

EDN[®]

Micropower circuits
Engineering calculators
Digital signal processing
Sequential testing
Technical-article
database index

ELECTRONIC TECHNOLOGY FOR ENGINEERS AND ENGINEERING MANAGERS

Personal-computer-based GPIB systems transcend time and cost constraints



REAL-TIME CONTROL JUST GOT FASTER

AND EASIER, AND CHEAPER, AND . . .

Higher in Performance

NEC's new CMOS μ PD78312 real-time controller uses an internal 16-bit bus to give you a fast 32 μ sec multiply, D/A or A/D conversion in 30 μ sec, and block transfers more than three times faster than the competition.

Unique functions like multiple register banks, context switching, macro service (eliminating interrupt software overhead), and an ANSI-standard real-time-control instruction set give you amazing flexibility and power to drive your system to higher performance.

Typical Execution Time (μ sec)

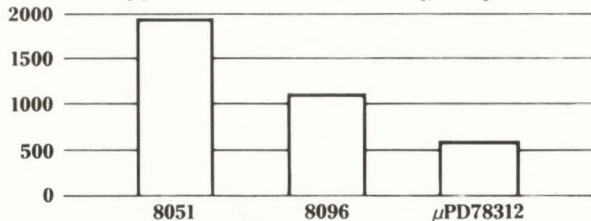

More Highly Integrated

A comprehensive selection of dedicated on-chip peripherals can master tough assignments, like controlling two independent servos and two highspeed stepper motors at the same time.

Fully Supported

To get you started, we offer full support for fast and easy software development with many options, like: a low-cost design and development kit (DDK-78310), state-of-the-art standalone ICE, third-party tools from Orion Instruments, plus relocatable assemblers and C-compilers from Lattice[®] for MS-DOS[™] and other operating systems.

To meet your packaging and production ramp-up needs, there's monolithic EPROM, OTP, and ROMless versions in your choice of PLCC, gull-wing flat, shrink DIP and QUIP packages.

Highly Available

Call your local NEC sales office to order the 78312 Evaluation Kit, documentation, and MS-DOS-based software. And, for our Micro-processor Data Book, call 1-800-632-3531. In California, call 1-800-632-3532. Or write, NEC Electronics Inc., 401 Ellis Street, P.O. Box 7241, Mountain View, CA 94039.

MS-DOS is a trademark of Microsoft Corp.
[®]Lattice is a registered trademark of Lattice, Inc.

©Copyright 1987 NEC Electronics Inc.

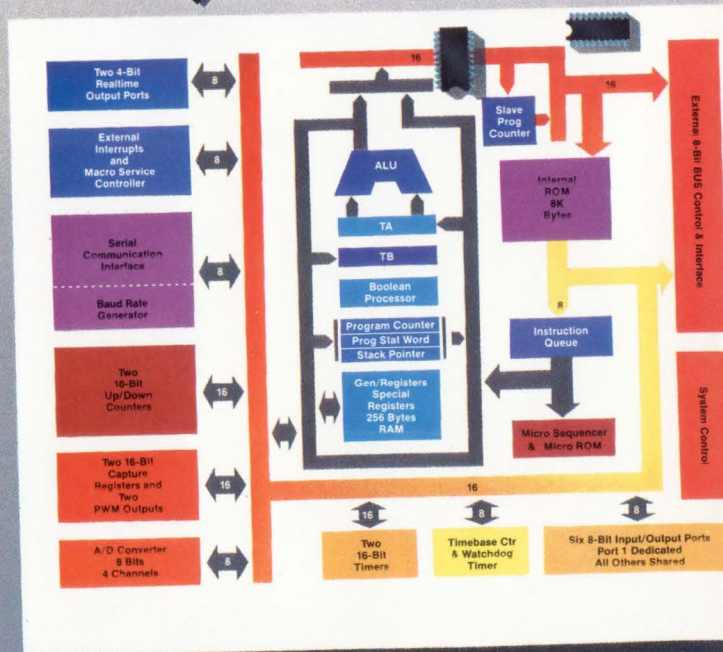
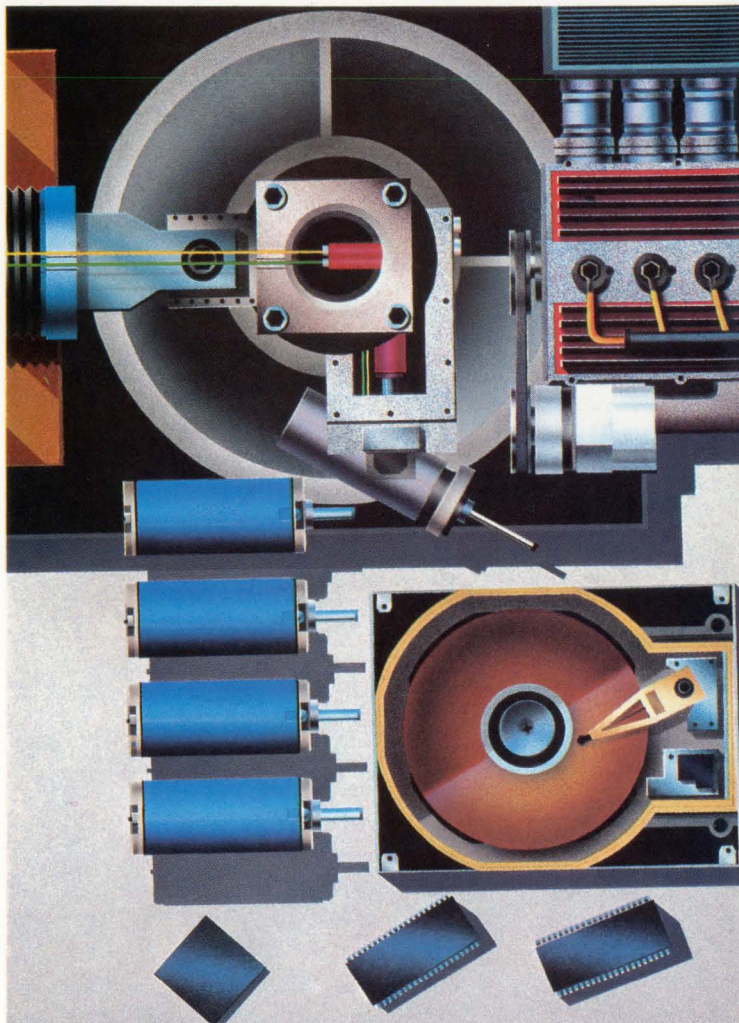

NEC
CIRCLE NO 122

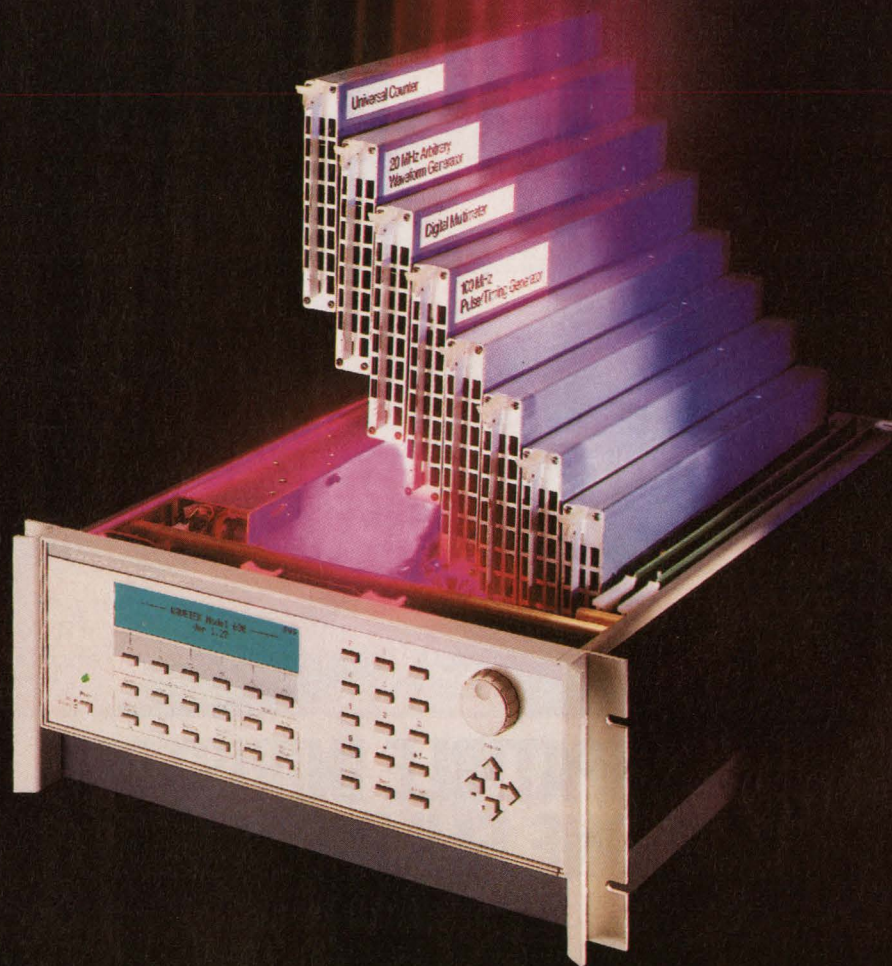

Now that Wavetek has built a new home for test instruments, look who's dropping in.

Imagine a full-size rack loaded with the highest performance instruments available.

Now picture all that performance in a much smaller space—inside the chassis of the new Wavetek Model 680, an open-architecture system of instruments on cards. Select from instruments made by Wavetek and other top manufacturers like Racal-Dana and Datron.

Model 680 is just 7" high, yet it holds up to eight instruments. Think how that can save room in your ATE bay. And think of the flexibility. Buy the modules you

need today. Then, as your needs change, plug in more.

Modules now available include a 20 MHz Arbitrary Waveform Generator, 100 MHz Pulse Generator, 6½ digit .002%-accuracy DVM and a Counter that measures intervals down to one nanosecond. You can even design your own modules.

Besides saving space, Model 680 can save money over stand-alone instruments.

Then there are the performance benefits. A 32-bit high-speed VME bus provides timing and synchronization signals, and an analog summing bus can be used to create

complex signals. There is also built-in testing, calibration and reference, and a powerful processor.

How will the Wavetek Model 680 fit into your present systems? Quickly and easily, because we have included interfaces for GPIB and MATE-CIL.

Best of all, the Model 680 is available now. For details, call or write us today. Wavetek San Diego, Inc., 9045 Balboa Ave., San Diego, CA 92123; Telephone 619/279-2200.

Circle 25 for literature

Circle 64 for demonstration

WAVETEK



THIS PC/XT-COMPATIBLE INDUSTRIAL COMPUTER MAY HAVE ONE FAILING...EVERY 7 YEARS.

That's the Pro-Log System 2 Mean Time Between Failures (MTBF) at 55°C. When you need reliability, that's it. An industrial computer that works and keeps on working for the life of your application. And it's covered by a 5-year limited warranty.

A HUGE SOFTWARE POOL

System 2 comes with Microsoft's MS-DOS 3.2 operating system and runs Lotus 1-2-3 and Flight Simulator. So it's PC/XT-compatible, right down to the chip level. Which is important for running industrial software, where real time response is needed.

Data acquisition, process monitoring and control, and multitasking software, plus a wide selection of editors, debuggers, and high-level languages are available. Many of them from Pro-Log.

HARD-WEARING HARDWARE

System 2 is based on the industry-standard STD BUS. So a wealth of industrial quality add-on products is available from over 100 STD BUS manufacturers.

PLUS ROOM TO EXPAND

You expand System 2 by simply plugging in additional STD BUS cards. Up to 23 expansion slots are available and many options, such as 640K bytes of memory, EGA/Keyboard interface, and printer interface, can be factory installed.

Grew up in the school of hard knocks. Secured on 4 sides, System 2 withstands 10gs of shock

No fan or heat sink needed, could be battery powered. Consumes as little as 1.25 watts

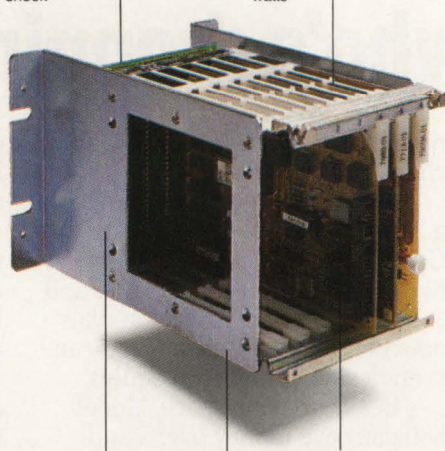

Works in places you wouldn't. 0° to 65°C operating temperature range

If it fails, down-time is minimized. All boards can be replaced in under 5 minutes

Can be isolated from dirt, moisture, and corrosion. Can be totally sealed in rack or NEMA Enclosures

A DISK DRIVE FOR EVERY APPLICATION

System 2 can be configured with IBM-compatible 3½-inch or 5¼-inch floppy disk drives and a 20M-byte hard disk.* For minimum power, maximum reliability and temperature range, select semiconductor (ROM and RAM) disk drives.

Take care of your next 7 years TODAY. Call toll-free (800) 538-9570 or write Pro-Log Corporation 2560 Garden Road, Monterey, CA 93940

*Thermal and mechanical specifications are reduced by the use of mechanical disk drives.

MS-DOS 3.2 and Flight Simulator are registered trademarks of Microsoft Corp. Lotus 1-2-3 is a registered trademark of Lotus Development Corp. IBM is a registered trademark of International Business Machines Corp.



USA TLX: 171879, Australia (02) 419-2088; Canada (416) 625-7752; England (0252) 851085; France (1) 3956-8143; Germany (07131) 50030; Italy (2) 498-8031; Switzerland (01) 624 444

PL055

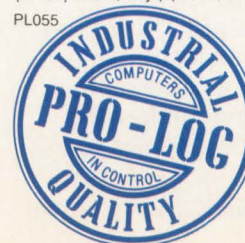

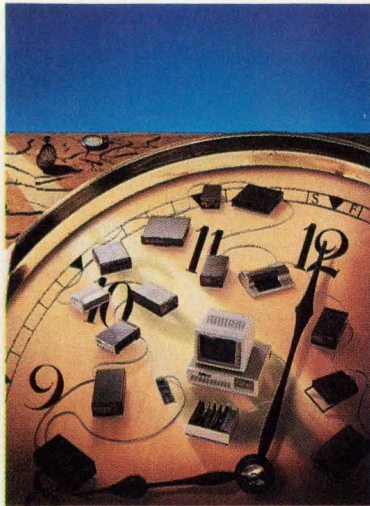

On the cover: Sophisticated hardware and software tools are blurring the distinction between instrument control and data acquisition. See pg 94. (Photo courtesy Keithley Instruments)

DESIGN FEATURES

Special Report: PC-based GPIB control and data-acquisition products 94

With a well-planned combination of hardware and software tools for your personal computer, you can turn your set of IEEE-488 (GPIB) instruments into a PC-controlled data-acquisition system.

—J D Mosley, *Regional Editor*

EDN's DSP Project—Part 1 111

This first in a 4-part series reviews some basics and brings you up to date on digital-signal-processing products.—Jim Wiegand, *Associate Editor*

Designer's Guide to Micropower Circuits—Part 1 123

Part 1 of this 2-part series focuses on micropower signal conditioning for the various sensors and transducers that have inherently low impedance or output voltage.—Jim Williams, *Linear Technology Corp*

Sequential-test techniques maximize throughput in tests 145

By performing a sequential test, which evaluates results after each trial, you can determine whether a system warrants further testing.

—R F Cobb, *Harris Corp*

Simplify FIR-filter design with a CMOS filter-control chip 157

You can now use three CMOS chips to construct an FIR filter that has fully programmable characteristics.—Jeff D Haight, *Intersil Inc*

Proper design tradeoffs translate to a precise position-control system 167

Microstepping technology offers a means of improving resolution in position-control applications. When it comes to a drive/control scheme, however, you must juggle a number of design tradeoffs if you hope to achieve an optimum design.—Yoram Hirsch, *IXYS Corp*

EDN Technical-Article Database Index 177

EDN's semiannual database index lists articles published from November 1986 to April 1987 in EDN, Electronic Design, Electronics, Electronic Products, Computer Design, and Digital Design.

Continued on page 7



▽BPA ABP



EDN®(ISSN 0012-7515) is published 38 times a year by Cahners Publishing Co, a Division of Reed Publishing USA, 275 Washington Street, Newton, MA 02158. William M Platt, President; Terrence M McDermott, Executive Vice President; Jerry D Neth, Vice President of Publishing Operations; J J Walsh, Financial Vice President/Magazine Division; Thomas J Dellamaria, Vice President Production & Manufacturing; Frank Sibley, Group Vice President. Copyright 1987 by Reed Publishing USA, a division of Reed Holdings Inc; Saul Goldweitz, Chairman; Ronald G Segel, President and Chief Executive Officer; Robert L Krakoff, Executive Vice President. Circulation records maintained at Cahners Publishing Co, 270 St Paul St, Denver, CO 80206. Second class postage paid at Denver, CO 80202 and additional mailing offices. Postmaster: Send address changes to EDN®, 270 St Paul St, Denver, CO 80206.

PC-based data acquisition. Just fill in the blanks.

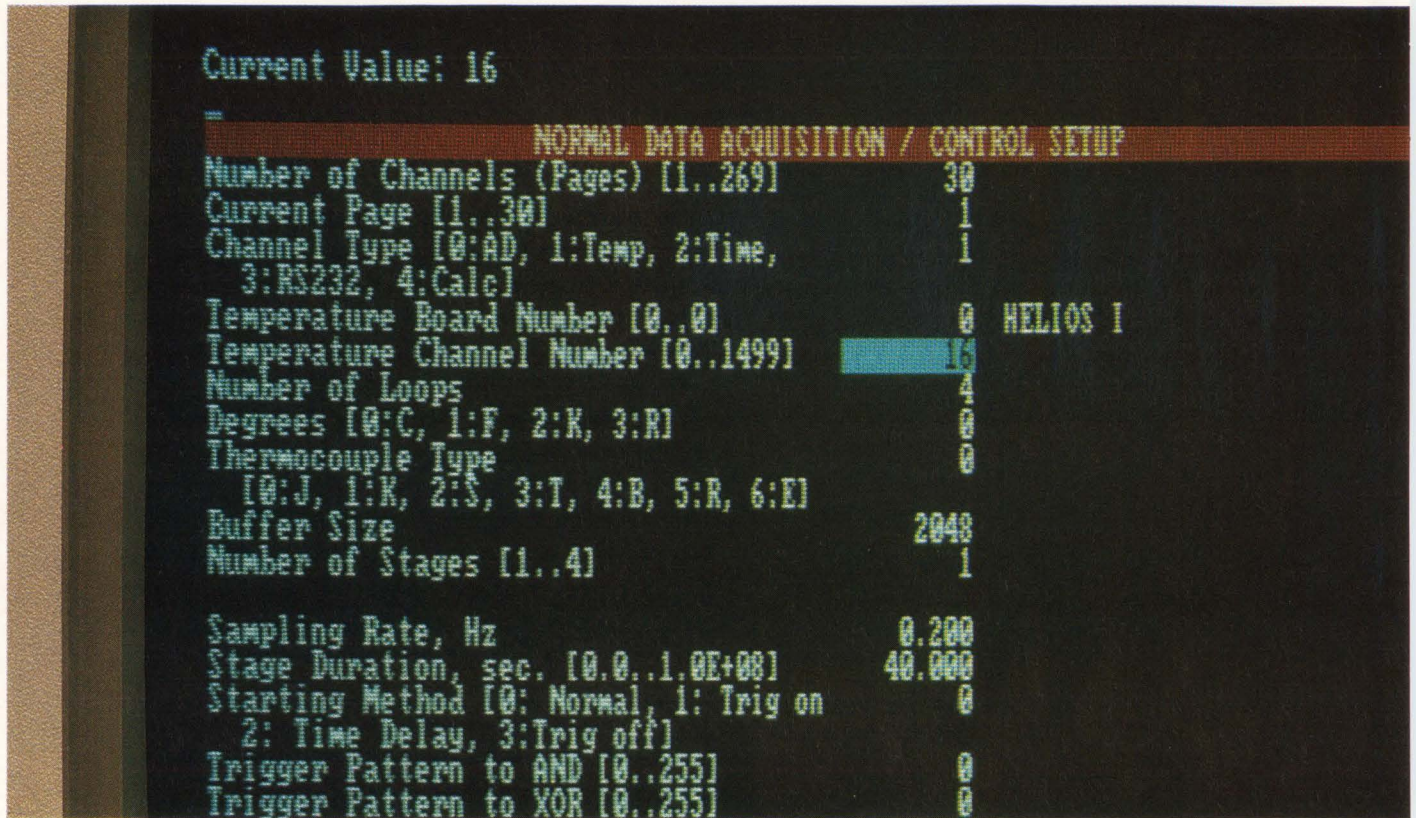

Get your application up and running fast with Helios-I™ and Labtech Notebook™.

When you're on a tight schedule and you wanted your data yesterday, talk to us. We've combined our Helios-I™ Computer Front End and Labtech Notebook™ software to give you everything you need between your sensors and your PC.

Just set up your application by filling in the blanks. No software programming is necessary—you are prompted through the choices for each configuration. You can have your system up and running in a matter of hours, not weeks.

After set-up, Helios-I collects real world



data you can depend on. Our I/O options have been proven in industrial settings worldwide. Helios-I converts raw data to engineering units, freeing your PC of this burden. Conditioning a wide range of inputs, Helios-I provides built-in transducer conditioning and linearization, even for strain gages.

Tailored especially for Helios-I, Labtech Notebook software offers a variety of sophisticated capabilities, including real-time graphic display of data and sampling at flexible rates. Integration with Lotus 1-2-3™ helps you present a clear picture of your test results.

Need more information? Let us fill in the blanks for you. Call **1-800-426-0361** or your nearest Fluke sales engineer.



Helios-I is a trademark of John Fluke Mfg. Co., Inc.
Lotus 1-2-3 is a trademark of Lotus Development Corporation

IN THE U.S. AND NON-EUROPEAN COUNTRIES: John Fluke Mfg. Co., Inc., P.O. Box C9090, MS 250C, Everett, WA 98206. Sales: (206) 356-5400. Other: (206) 347-6100.
EUROPEAN HEADQUARTERS: Fluke (Holland) B.V., P.O. Box 2269, 5600 CG Eindhoven, The Netherlands. (040) 458045. TLX: 51846.
© Copyright 1986 John Fluke Mfg. Co., Inc. All rights reserved. Ad No. 4604-HELIOS



Scientific calculators are offering a host of intriguing new functions, features, and capabilities (pg 63).

TECHNOLOGY UPDATE

Advanced engineering calculators perform sophisticated operations 63

Even though the market for new calculators would seem to be more than saturated, all the major scientific-calculator makers are betting that engineers will add another, top-of-the-line calculator to their flocks.—*Charles H Small, Associate Editor*

PRODUCT UPDATE

Transputer-based PC add-in board 73

Trio of digitizing oscilloscopes 77

Data-acquisition chip 82

DESIGN IDEAS

Add balanced signal to a variable voltage 215

Program aids analysis of FFT algorithms 216

Receiver guards against current-loop shorts 218

PLD implements permutation addressing 223

Talking meter gives dc-voltage readings 224

Continued on page 9

Advertising and editorial offices: 275 Washington St, Newton, MA 02158. Phone (617) 964-3030. Subscription offices: 270 St Paul St, Denver, CO 80206. Phone (303) 388-4511. EDN® is circulated without charge to those qualified. Subscription to others: US, \$95/year, \$6/copy; Canada and Mexico, \$110/year, \$8/copy; Europe Air Mail, \$135/year, \$10/copy; all other nations surface mail, \$135/year, \$10/copy; all other nations Air Mail, \$200/year. Special issue prices may vary. Send requests for qualification forms and/or change of address to subscription office.
© 1987 by Reed Publishing USA, Division of Reed Holdings Inc. All rights reserved.

Microprocessor Development Systems & In-Circuit Emulators



SA2000

Complete universal development system and in-circuit emulator for latest micro controllers.

- Cross assembler, Linker, Editor standard.
- Powerful software debugger plus Real-Time ICE.™

SA700-68000

Dedicated in-circuit emulator for 68000 Microprocessor.

- Most transparent 68000 emulation.
- Over 1/2MByte emulation Ram.
- Command files for software/prototype/production test.



| PROCESSOR (16bit) | | PKG | SA710M | SA700-68000 |
|-------------------|------------------------------|------------------|--------|-------------|
| INTEL | 8086/88 | DIP40P | ○ | ○ |
| | 80C86/88 | DIP40P | ○ | ○ |
| | 80186/188 | LCC/PGA | ○ | ○ |
| NEC | μPD70108/116 (V20/30) | DIP40P | ○ | ○ |
| | μPD70208/216 (V40/50) | PGA | ○ | ○ |
| MOTOROLA | MC68000 | DIP64P, PGA68P | | ○ |
| PROCESSOR (8bit) | | PKG | SA2000 | |
| ZILOG | Z80CMOS (Z80, Z80A, Z80C) | DIP40P | ○ | ○ |
| | Z80H (Z80, Z80A, Z80B, Z80H) | DIP40P | ○ | ○ |
| | Z8 (Z8601/03/11/13-12R) | DIP40P | ○ | ○ |
| | SUPER-8 (Z8310-33) | DIP40/48P | ○ | ○ |
| INTEL | 80C85, 8085AH-2 | DIP40P | ○ | ○ |
| | 8048 (8035/39/40/49/50AH) | DIP40P | ○ | ○ |
| | 8051 (8031/51AH, 80C51) | DIP40P | ○ | ○ |
| MOTOROLA | MC6801 (6801/03-1) | DIP40P | ○ | ○ |
| | MC6809 (68A09, 68809) | DIP40P | ○ | ○ |
| | MC6809E (68A09E, 68B09E) | DIP40P | ○ | ○ |
| HITACHI | MC68HC11 | DIP48P | ○ | ○ |
| | HD6301Y/6303R, HD63701V | DIP40P | ○ | ○ |
| | HD6301X/6303X, HD63701X | SDIP64P | ○ | ○ |
| | HD6301Y/6303Y, HD63701Y | SDIP64P | ○ | ○ |
| | HD6305U/V, HD63705V | DIP40P | ○ | ○ |
| | HD6305X/Y | SDIP64P | ○ | ○ |
| | HD6305Z, HD63705Z | FLAT80P | ○ | ○ |
| HD6309E | DIP40P | ○ | ○ | |
| NEC | HD61810B (HSP) | DIP40P | ○ | ○ |
| | μPD 7807/08/09 | SDIP64P, QUIP64P | ○ | ○ |
| | μPD7810H/11/14/16 | SDIP64P, QUIP64P | ○ | ○ |
| MITSUBISHI | μPD78C10/11 | SDIP64P, QUIP64P | ○ | ○ |
| | M50734SP | SDIP64P | ○ | ○ |
| | M50745 | SDIP64P | ○ | ○ |
| ROCKWELL | M50747 | SDIP64P | ○ | ○ |
| | R6502, 65C02 | DIP40P | ○ | ○ |



SA710M

16-bit universal system analyzer and in-circuit emulator.

- Symbolic features include local variables, arrays, structures.
- Start/Stop trace without breaking.
- Stand-alone or Host operation.

*In U.S. SA2000 & SA710M with Zilog chip support can be purchased through Zilog or Sophia sales channel.

*ICE™ is a trademark of Intel Corp.

*No.3 universal MDS manufacturer in the world.

Call toll-free 1-800-824-9294 (outside CA.)
1-800-824-6706 (in CA.)

Sophia
systems™

U.S. & European Headquarters: Sophia Computer Systems, Inc., 3337 Kifer Road, Santa Clara, CA. Tel.(408)733-1571 Fax.(408)749-8172 95051.
Corporate Headquarters: Japan, Sophia Systems Co., Ltd. NS Bldg. 2-4-1, Nishishinjuku, Shinjuku-ku, Tokyo 163. Tel.(03)348-7000.

VP/Publisher
F Warren Dickson

VP/Associate Publisher/Editorial Director
Roy Forsberg

Editor
Jonathan Titus

Managing Editor
Rick Nelson

Assistant Managing Editor
Joan Morrow

Special Projects
Gary Legg

Home Office Editorial Staff
275 Washington St, Newton, MA 02158
(617) 964-3030

Tom Ormond, *Senior Editor*
Deborah Asbrand, *Associate Editor*
Joanne Clay, *Associate Editor*
Tarlton Fleming, *Associate Editor*
John A Gallant, *Associate Editor*
Clare Mansfield, *Associate Editor*
Dave Pryce, *Associate Editor*
Cynthia B Rettig, *Associate Editor*
Charles Small, *Associate Editor*
Chris Terry, *Associate Editor*
Jim Wiegand, *Associate Editor*
Ron Gilbert, *Staff Editor*
Valerie Lauzon, *Staff Editor*
Helen McElwee, *Staff Editor*
Steven Paul, *Senior Production Editor*

Editorial Field Offices

Margery S Conner, *Regional Editor*
Doug Conner, *Regional Editor*
Newbury Park, CA: (805) 499-7901

Bob Cushman, *Special Features Editor*
Port Washington, NY: (516) 944-6524

Steven H Leibson, *Regional Editor*
Boulder, CO: (303) 494-2233

J D Mosley, *Regional Editor*
Arlington, TX: (817) 465-4961

David Shear, *Regional Editor*
San Jose, CA: (408) 296-0868

Maury Wright, *Regional Editor*
San Diego, CA: (619) 748-6785

Peter Harold, *European Editor*
0603-630782
(St Francis House, Queens Rd,
Norwich, Norfolk NR1 3PN, UK)

Contributing Editors
Eva Freeman, Robert Pease, Bob Peterson,
Don Powers, Bill Travis

Editorial Services
Kathy Leonard, *Office Manager*
Loretta Curcio, Nancy Weiland,
Sharon Gildea

Art Staff
Kathleen Ruhl, *Art Director*
Ken Racicot, *Assistant Art Director*
Chin-Soo Chung, *Graphic Designer*
Deborah Queally, *Graphic Designer*

Production/Manufacturing Staff
William Tomaselli, *Production Supervisor*
Donna Pono, *Production Manager*
Janice Dow, *Production Assistant*
Andrew A Jantz, *Production Assistant*
Diane Malone, *Composition*

Graphics Director
Norman Graf

VP/Production/Manufacturing
Wayne Hulitzky

Director of Production/Manufacturing
John R Sanders

Director of Research
Deborah Virtue

Marketing Communications
Janice Molinari, *Manager*
Jennifer Ware, *Communications Manager*
Corie Rand, *Promotion Coordinator*
Anne Foley, *Promotion Assistant*

EDITORIAL

55

You'll enjoy life more if you keep an eye open for the unexpected.

NEW PRODUCTS

| | |
|--|-----|
| Computers & Peripherals | 232 |
| Integrated Circuits | 239 |
| Components & Power Supplies | 250 |
| CAE & Software Development Tools | 254 |
| Test & Measurement Instruments | 257 |

PROFESSIONAL ISSUES

269

Users groups and their vendors: The ins and outs of a partnership.—*Deborah Asbrand, Associate Editor*

LOOKING AHEAD

279

Miniaturization move aids power-hybrid market... Delivery delays clog LVDT market.

DEPARTMENTS

| | |
|---------------------------------|-----|
| News Breaks | 21 |
| News Breaks International | 24 |
| Signals & Noise | 31 |
| Calendar | 44 |
| Readers' Choice | 86 |
| Leadtime Index | 90 |
| Literature | 266 |
| Business/Corporate Staff | 268 |
| Career Opportunities | 272 |
| Advertisers Index | 278 |

Cahners Publishing Company A Division of Reed Publishing USA
Specialized Business and Consumer Magazines for Building & Construction
Interior Design Electronics & Computers Foodservice & Lodging
Manufacturing Book Publishing & Libraries Medical & Health Care
Child Care/Development

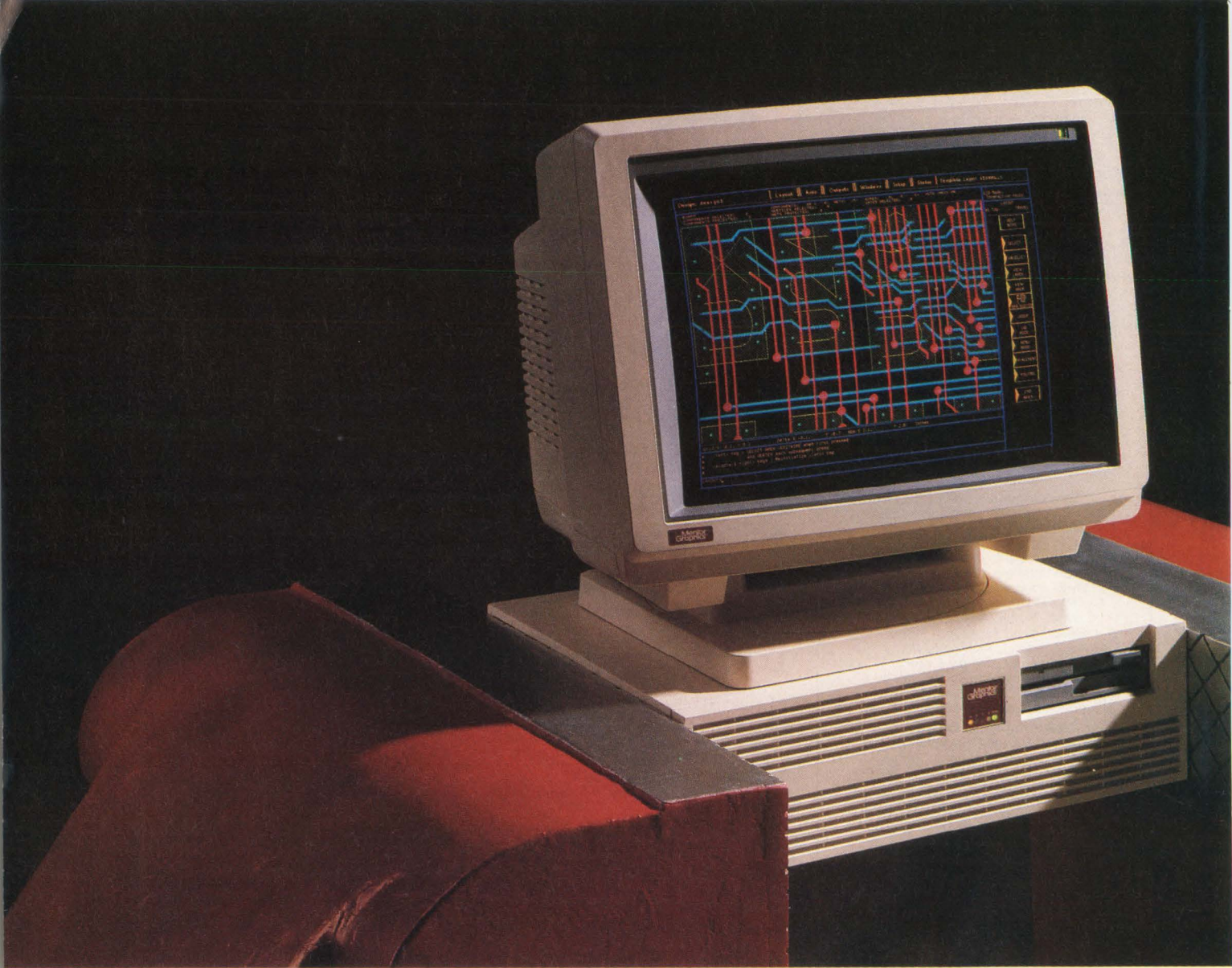

Only Mentor Graphics stands up to the pressures on PCB layout.

As a PCB designer, you're under constant pressure from all sides. Endless ECOs from engineering. Impossible schedules from management. Anxiety from manufacturing.

The only way to survive and thrive is to be fast and accurate.

So the flashy simplicity of some PCB layout workstations makes them very appealing at first glance. But all too soon, you'll find they've made you neither faster nor more accurate.

Now there's Board Station® from Mentor Graphics. It's easy to learn, yet also packs the power you'll need to cope with even the most complex board designs and technologies.

Within minutes after you sit down at Board Station, you'll be performing all its basic operations with confidence and ease. A fast, graphics-oriented interface moves you smoothly and comfortably from one design function to the next. All commands are grouped logically, with pop-up menus and pull-down forms.

And when you're ready for more sophisticated operations, Mentor Graphics stays right with you. Board Station's flexible and versatile editor lets you effectively tackle even the most

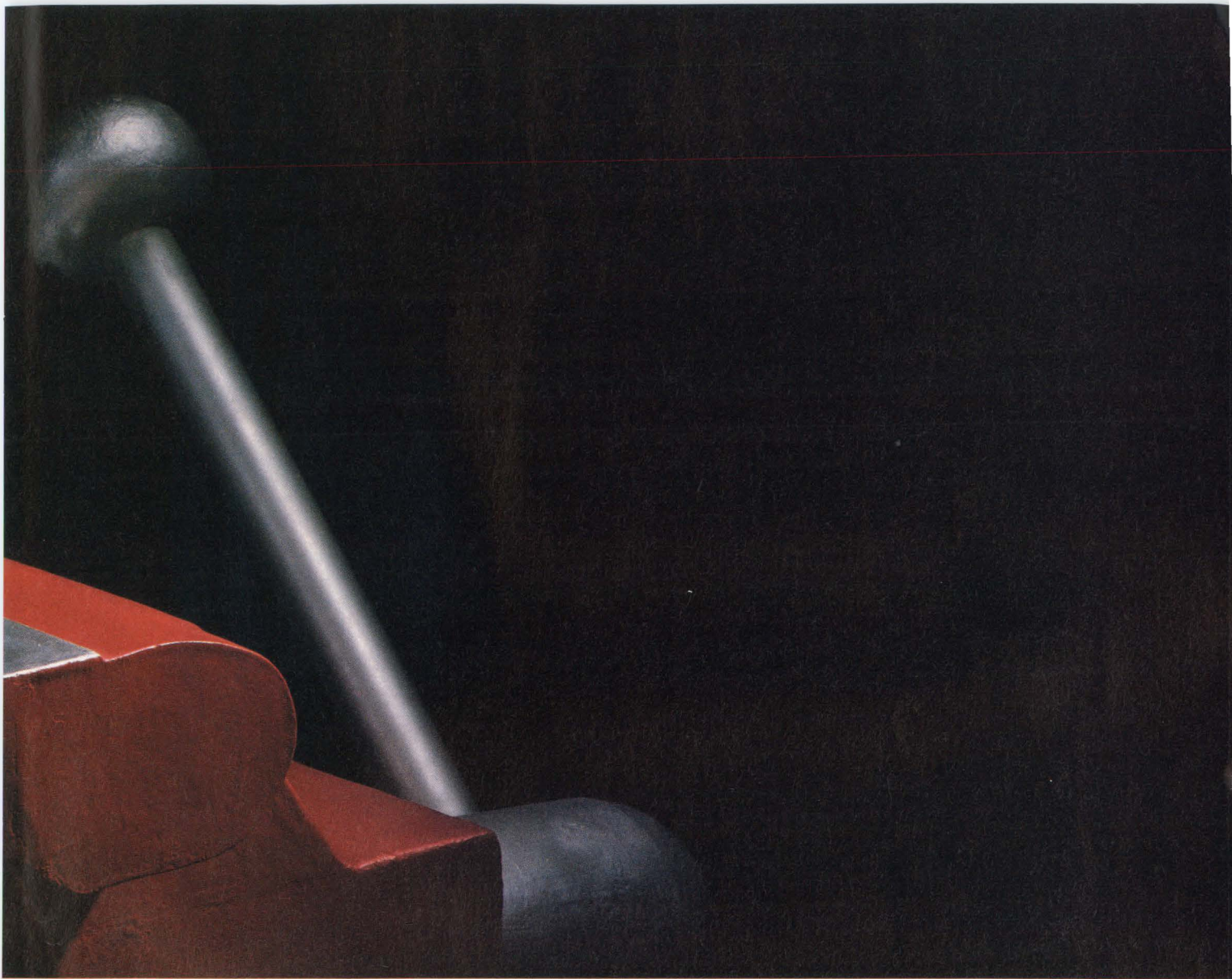

advanced layout problems, like SMDs and double-sided placement. And our component placement tool is the best anywhere, with software that thinks just like a PCB designer.

Also, you can shift effortlessly from interactive to automatic placement or routing, so your work effort is constantly optimized. And you have ready access to a large PCB geometry library, while intelligent logical-to-physical pin mapping streamlines your layout task. Board Station can even be gradually converted into a highly personalized tool with high-level macros and custom window layout.

What's more, you can share a database with the engineering department, so essential information is automatically forwarded to you, like specific component locations, critical nets and other design constraints.

Board Station. It's all part of a vision unique to Mentor Graphics, the leader in

electronic design automation. Let us show you where this vision can take you.

Call us toll free for an overview brochure and the number of your nearest sales office.

Phone 1-800-547-7390
(in Oregon call 284-7357).

**Mentor
Graphics®**



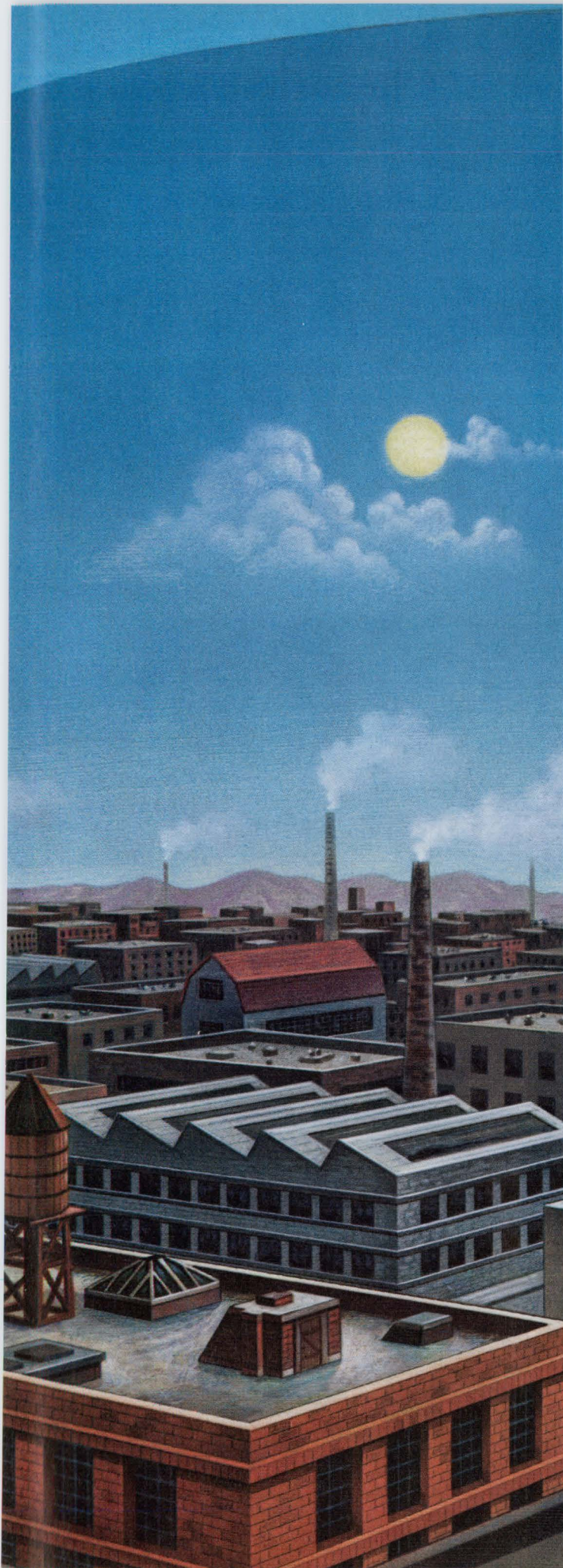

PAL devices: We didn't wait for the future.

There's no doubt that we're fast. But speed isn't all that makes us the logical choice in programmable logic.

AMD PAL* devices give you more because they have more functions per chip. With unique features like input/output logic macrocells, buried registers and variable product term distribution, you can design with more efficiency. And freedom.

PAL devices you can count on.

Speed and functionality don't mean much if you can't count on your PAL devices. We can deliver better than 98% programming yield. And we added extra circuitry for functional and AC testing. That means we can test parts prior to programming. Then after you've programmed all the parts, you'll be pleasantly surprised to discover our Post-Programming Functional Yield is an incredible 99.9%.

Our products range from industry standard 20- and 24-pin PAL devices to the innovative 22V10. We've got the kinds of technologies and features you need in packages and temperature ranges to fit your design. We've even got high-complexity E²CMOS products and ECL on the way.

And it's easy to use our PAL devices because we provide a broad selection of high level software that lets you get from system requirements to programmed product easily. Need more information? Just ask and we'll send you the AMD Program-

| Performance Speed-Up 20-Pin PAL Devices | | |
|--|-------------|----------|
| Propagation Delay | Speed Level | Date |
| 25.0ns | A Speed | Q4, 1981 |
| 15.0ns | B Speed | Q3, 1986 |
| 10.0ns | D Speed | Q3, 1987 |
| 7.5ns | E Speed | Q4, 1987 |

mable Logic
Handbook.

Now you
don't have to
wait for the
future either.

*PAL is a registered trademark of, and is used under license from, Monolithic Memories Inc.
Call toll-free (800) 538-8450 ext. 5000; inside California call (408) 749-5000.

Advanced Micro Devices

901 Thompson Place, P.O. Box 3453
Sunnyvale, CA 94088

CIRCLE NO 118

(408) 727-5433

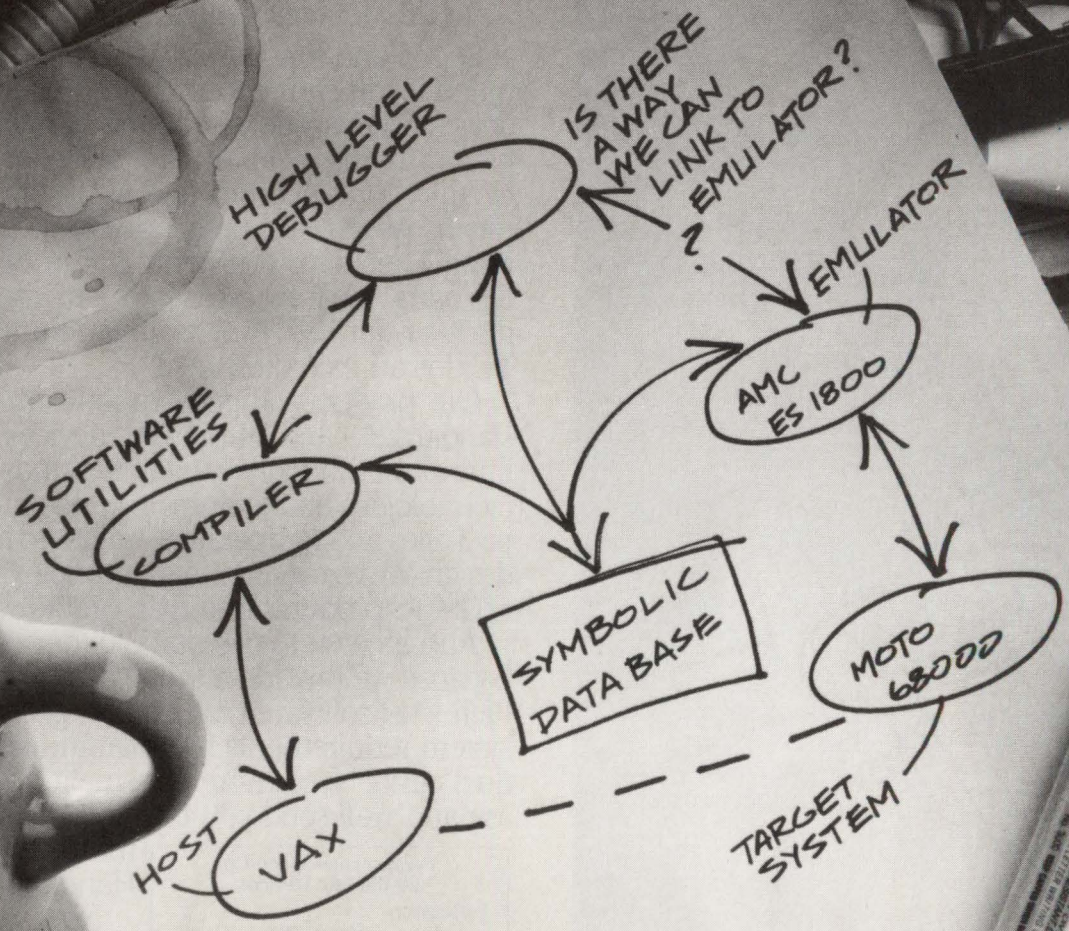

CALL DEREK
BEFORE 3:00!

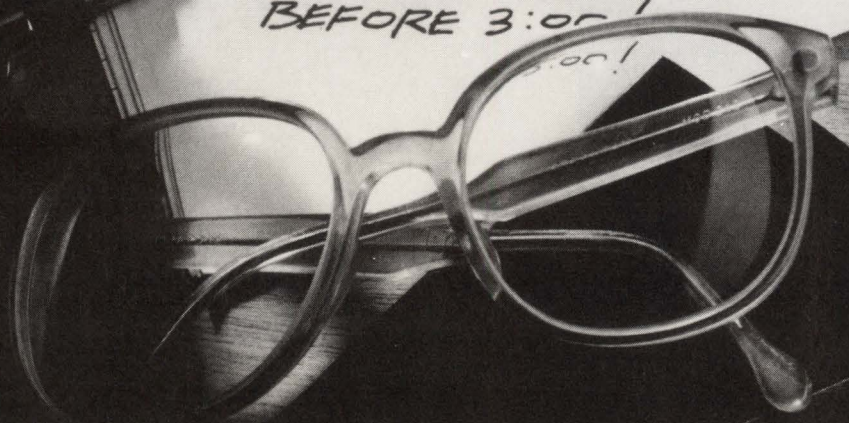

The development system you need won't exist until we create it for you.

Applied Microsystems lets you link the powerful tools you need with ease and precision.

Unless your system has off-the-shelf bugs, you can't solve your problems with off-the-shelf development tools. But if you try to pull all the pieces together yourself, you'll spend long frustrating hours and still wind up with a development system that falls short of your needs.

Now Applied Microsystems offers help: a new method of linking development tools that can be adapted to your specific needs. We offer you a seamless, painless interface along with the ability to match your host, language, operating system and software requirements to your engineering methods and target design, be it Intel, Motorola or Zilog.

Debug tools for your integrated development environment.

Whether you're working on an 8-bit, 16-bit or even 32-bit microprocessor design, Applied Microsystems lets you tailor the emulation and debug tools you need. Everything from symbolic and source-level debuggers to assemblers, cross-compilers and utilities. The chart shown above

| HOSTS | OPERATING SYSTEMS | TARGETS | LANGUAGES | TOOLS |
|---------------|-------------------|---------------|-----------|------------------------|
| VAX | VMS | 8051, | C | Assemblers |
| MicroVAX | ULTRIX | 8048 family, | Pascal | Linkers |
| UNIX® | UNIX | 8080, 8085, | FORTRAN | Locaters |
| workstations | XENIX | 8086/88, | PL/M | Compilers |
| · Apollo | MS-DOS | 80186/188 | Assembler | Symbolic debuggers |
| · Sun | | and 80286 | Jovial | Source level debuggers |
| · IBM AT | | 68HC11, | | Emulators |
| MS-DOS | | 6800/2/8, | | |
| workstations | | 6809/9E, | | |
| · PC | | 68000/8/10 | | |
| · PC XT | | and 68020 | | |
| · PC AT | | Z80, MK3880/4 | | |
| · Compatibles | | and Z8001/2/3 | | |
| | | NSC-800 | | |

A stand-alone or host-control system of fully integrated debug tools built on high performance emulation.

gives some idea of the power and convenience we can offer you, but it can only hint at the benefits you will enjoy.

Validate™ links emulation with symbolic and source-level debugging.

When your software engineers only speak C and your emulator only speaks assembler, your development tools are worse than worthless. If your function is in assembler and your debugger speaks only C, you've got the same problem. The power of the Validate environment is that it works equally in high level languages and in assembler. You don't sacrifice any power or any comfort.

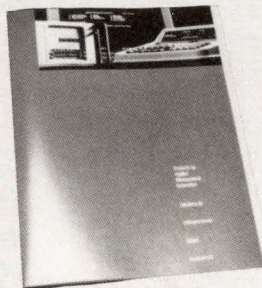

Call toll-free and ask for the proof.

Discover why our integrated development systems are the fastest and easiest ways to start and finish a design project. For technical and application details call 1-800-426-3925. In Washington, call (206) 882-2000. Or write Applied Microsystems Corporation, P.O. Box 97002, Redmond, WA 98073-9702.

In Europe, contact Applied Microsystems Corporation Ltd., Chiltern Court, High Street, Wendover, Aylesbury, Bucks, HP22 6EP, United Kingdom. Call 44-(0)-296-625462.

UNIX is a registered trademark of AT&T.



**Applied
Microsystems
Corporation**

**What has
the gate array density
you've been waiting for—
without the waiting?**

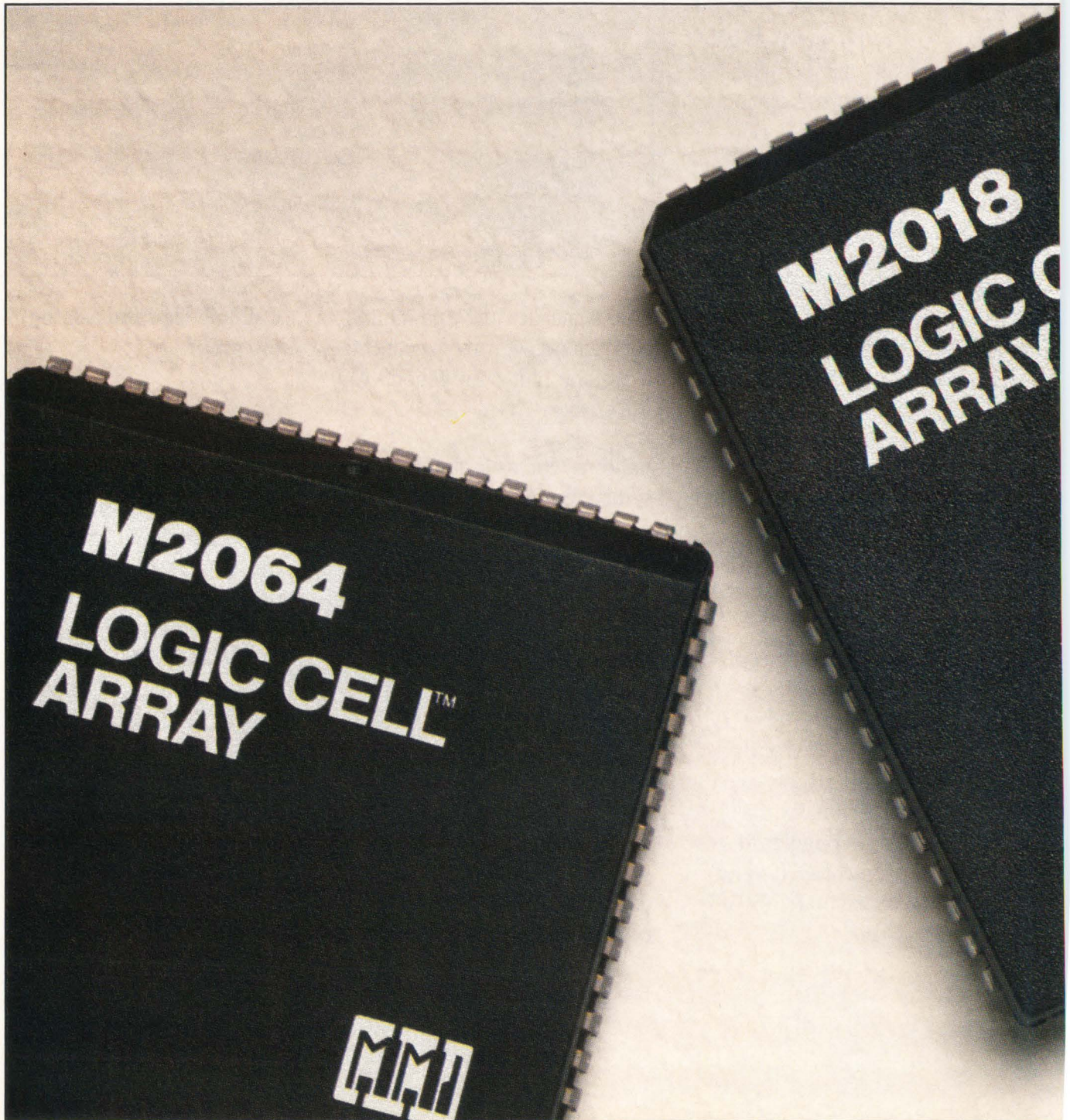

Easy answer: the Logic Cell™ Array (LCA). A new, field-programmable CMOS gate array that has a flexible, wide-open architecture. Along with true VLSI-level density.

LCAs are built around logic and I/O blocks which you define and interconnect to build larger-scale, multi-level logic functions. Since you never alter their structure, you can reprogram them as often as you like. And avoid any NRE.

With LCAs, you get an honest-to-goodness 1800 usable gates (and as many as 8000 gates in the near future). So just one part can replace

up to 50 SSI/MSI devices. Or up to 10 PLDs.

You also get a choice of surface mount, pin-grid or DIP packages. In speeds up to 70MHz.

New developments weekly.

With our easy-to-use XACT™ software, you simply draw the design and let your IBM® PC XT/AT computer convert it to code. You can use our library of over a hundred macros or define your own. Let the software perform the interconnections automatically (unless you specify something unique). And generate documentation at the touch of a button.

The whole process is so fast, you'll be testing prototypes in a matter of days. And shipping finished products while your competitors wait for their prototype chips to come in.

Look who's behind you.

When it comes to field programmable logic, there's no substitute for experience.

Which is what you get plenty of when you deal with the company that invented the PAL® device and made it the industry standard.

Because we've got a complete staff of systems-experienced FAEs, there's no waiting to talk to an expert who knows how Logic Cell Arrays can work for you. And, you can get comprehensive assistance at MMI distributors worldwide.

If you'd like to talk to one of those experts about your application, or for a free LCA Demo Disk, call our Applications Hotline at (800) 222-9323.

Or write to Monolithic Memories, 2175 Mission College Blvd., Santa Clara, CA 95054.

Because there's nothing else like having the right part from the right company.



MMI's XACT software allows for simple LCA design.



Logic Cell and XACT are trademarks of XILINX Inc. IBM is a registered trademark of International Business Machines Corp. PAL is a registered trademark of Monolithic Memories, Inc.
© 1987, Monolithic Memories, Inc.

Monolithic Memories 

Top Gun in High-Rel SRAMs.

Also available in commercial versions.



Set your sights on our new 256K SRAMs.

These High-Rel SRAMs offer you all these benefits:

- 100 ns access time at 25°C
- Low standby current: 1 mA typical
- Full Mil temperature range
- 32Kx8 organization
- 28 Terminal DIL Package
- Screened to Mil-Std-883 Class B.* So they're perfect for use in a wide range of military systems. And, as you'd expect from the leaders in High-Rel CMOS, we have a full line of SRAMs, including 64K (8Kx8) and 16K (2Kx8).

Tops in Rad-Hard RAMs, too.

If you need rad-hardness, remember that we offer 1K, 4K and 16K CMOS/SOS RAMs as well.

Our Rad Hard 16Kx1 CMOS/SOS RAM has an access time of 125 ns at 25°C and is available for immediate delivery to Class S type specifications.

CMOS/SOS is the ideal technology for rad-hard

applications because:

- It's latch-up free under transient radiation
- It's highly tolerant to single-event upset caused by radiation (typically 2×10^{-9} errors/bit/day)
- It has total dose tolerance from 100K RADs to "MEGARAD."

We know, because we invented CMOS/SOS.

So whatever your needs in SRAMs, aim high, and call the Top Guns today.

For additional information, call toll-free 800-443-7364, extension 20. Or contact your local GE/RCA sales office or distributor.

*Rev. C, Paragraph 1.2.2



RCA

Select your favorite ads in this issue of EDN!

Enter the EDN Reader Vote Advertising Contest by following the three steps listed below.

1. Select the 10 ads in the August 6 issue of EDN that you think your fellow readers will choose as being the most helpful, informative, and attractive.
2. List your selections on the entry card provided.
3. Mail by September 17, 1987

★ Top **3** prizes ★

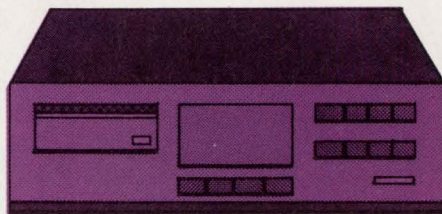

Compact Disc Players

★ **10** ★



\$25.00 Gift Certificates
from Radio Shack

Contest Rules

1. List your top selections on the entry card provided. Be sure to indicate the name of the advertiser (company or organization) and the Information Retrieval Service or Reader Vote number for each advertisement selected. Do NOT use page number. (Ads placed by Cahners Publishing Company, EDN or other Cahners' publications cannot be considered in this contest.)
2. No more than one entry may be submitted by any one individual. Entry blank must be filled in completely, or it will not be considered.
3. To qualify, you must be engaged in electronic design engineering, supervising or managing design engineering, or setting standards for design components and materials.
4. Contest void where prohibited or taxed by law. Liability for any taxes on prizes is the sole responsibility of the winners.
5. Entries that most closely match the rank will be declared winners.
6. Entry cards must be postmarked before September 17, 1987
7. In case of a tie, the earlier postmark will determine the winner. Decisions of the contest judges will be final.
8. In the event that a prize is not available, publisher may substitute an alternative prize of equal value without prior notice.

Reader
★ Vote ★

SOON
WIN
THE
BEST



8051 vs. 68HC11 Who wins? Microtek.

When choosing between the two leading microcontrollers, don't let emulator support slow you down. NWIS is the exclusive U.S. source of in-circuit emulators for both. And for all the popular microprocessors as well, including the 32-bit 68020 and 80386. As well as 68010, 68000, 80286, 80186, 8086, plus many others.*

In fact, Microtek emulators have a long track record of being first to market with quality support for every major microprocessor. Which gives you shorter time-to-market and an assured expansion path for product upgrades.

Every Microtek emulator can be used as a stand-alone device, or as part of an integrated system. All use simple command structures and include a symbolic debugger for rapid insight into your software's real-time behavior. And each communicates with the IBM® PC/XT/AT, VAX®, MicroVAX®, Apollo and Sun computers.

Microtek emulators are just one part of NWIS's complete line of embedded microprocessor software development tools.

Our Software Analysis Workstation (SAW) brings you hardware-based, real-time software analysis in a source code environment. Including performance analysis, time-aligned dual processor trace, code coverage analysis, and Context Trace™, which lets you trace high-level events and related assembly-level code at the same time.

And for source code development, our Microtec® Research products provide you with C and Pascal cross-compilers, cross-assemblers and debuggers for the same wide range of popular processors.

Best of all, NWIS backs all these products with solid applications support, both at the local and factory level.

So let us become your single source for emulators and other microprocessor Computer-Aided Software Engineering (CASE) tools.

1-800-547-4445.



Pioneering Microprocessor CASE

NWIS

NORTHWEST INSTRUMENT SYSTEMS, INC.

Circle 58 for demonstration

P.O. Box 1309 • Beaverton, OR 97075 • 1-800-547-4445

Circle 19 for literature

*Processors supported by Microtek: 80386, 80286, 80186, 80188, 8086, 8088, 68020, 68010, 68008, 68000, 6809, 6809E, 6502, Z80, NSC800, 8085, 8032, 8051, 8031, 8344, 8048, 8049, 8050, Z8, SUPER 8, 68HC11, 64180, 80515.

IBM is a registered trademark of International Business Machines. VAX and MICROVAX are registered trademarks of Digital Equipment Corporation. Microtec is a registered trademark of Microtek Research, Inc.

NEWS BREAKS

EDITED BY JOAN MORROW

80386-BASED ADD-IN BOARD TRIPLES SPEED OF MICROVAX

You can triple the processing speed of a MicroVAX system by running the system's CPU-bound programs on an 80386-based AP/20 Attached Processor add-in board. The AP/20, which costs \$10,000, is made by Avalon Computer Systems (Glendale, CA, (818) 247-2216). It is compatible with any Q Bus VAX, runs at 3.5 to 4 MIPS, and features a floating-point multiply time of 437 nsec. It has its own memory and operating kernel; all user-mode instructions and many of the operating-system functions execute on the AP/20 with no transfers over the bus to the host VAX. The VAX interface only handles program loading, I/O, and system call processing.

The board comes with 4M bytes of memory. Options include high-speed floating-point capability and a choice of C, Fortran, or Pascal compilers.—Margery S Conner

FIVE TRACKBALL MODELS SUIT WORKSTATIONS AND PCs

The Mouse-Trak trackball from Itac Systems Inc (Richardson, TX, (214) 234-5366) lets you replace your mouse with a plug-in device that requires less desk space and less effort for cursor movement. For PCs, Models M4 and M5 plug into your RS-232C port, provide a cursor-speed regulator, and furnish two and three buttons, respectively, for menu selection or mouse emulation. Models Q1, MQ2, and MQ3 have quadrature interfaces for use with workstations such as the Sun, VAX, and Apollo. The Q1 and MQ2 have two buttons, and the MQ3 has three. The Q1 offers no cursor-speed control. OEM prices range from \$80 (51) for the Q1 to \$109 (51) for the M5.—J D Mosley

ENGINE USES THREE UNLIKE PROCESSORS TO SPEED PC-BOARD ROUTING

The combined might of a 68020 μ P, a bit-slice processor, and a RISC μ P in Cadnetix's (Boulder, CO, (303) 444-8075) \$89,500 Route Engine III provide twice the pc-board routing performance of the company's previous offering. The standard version of the product includes 8M bytes of memory that you can expand to 48M bytes for very large jobs. Currently, the router employs a gridded, costed-maze routing algorithm, but the company plans to ship a free software upgrade, including a flexible-field routing algorithm, late this year. This flexible-field router shifts the routing grid over the span of the pc board as needed to avoid obstacles such as component pads, thus maximizing the board's routability. Owners of the company's older Route Engine Plus can upgrade their machines to Route Engine IIIs for \$37,500.—Steven H Leibson

RUGGED WINCHESTERS FEATURE 129M- TO 389M-BYTE CAPACITIES

Hewlett-Packard Co (Palo Alto, CA, (800) 367-4772) has increased its offerings in the OEM hard-disk market by introducing a family of three rugged, hard-disk drives with unformatted capacities of 129M, 194M, and 389M bytes; 17-msec seek times; and an MTBF of 40,000 hours. The company offers these drives in both SCSI and ESDI versions as the HP97530S and HP97530E, respectively. The SCSI version supports the SCSI common command set, asynchronous transfer rates of 1.5M bytes/sec, and synchronous rates exceeding 2M bytes/sec. The ESDI version features a 10M-bps burst-transfer rate. In quantities of more than 1500, the 389M-byte versions of the SCSI and ESDI drives cost \$2050 and \$1900, respectively.—Steven H Leibson

NEWS BREAKS

KEYBOARD LETS YOU CHANGE LAYOUTS AND LEGENDS ON SITE

If you need a keypad that you can alter repeatedly, consider the reconfigurable keyboard from Preh Electronic Industries (Niles, IL, (312) 647-8338), which lets you easily change legends. According to the manufacturer, this "coffee and cola proof" keypad resists spills and moisture, thus making it suitable for factories and point-of-sale systems. But it's the polyvalent frame that lets you perform fast layout changes on site by popping off and repositioning single-, double-, triple-, and quad-size keys. You can even mix and interchange the various sizes on a single keypad. Changing legends on the keys is just as simple. OEM pricing for a typical keypad incorporating at least one multiposition key ranges from \$20 to \$100.—J D Mosley

SOFTWARE RELEASE QUADRUPLES MAP COMMUNICATIONS THROUGHPUT

Release 2 of the MicroMAP 2.1 software from Motorola Inc (Tempe, AZ, (800) 521-6274), running on the company's \$2660 MVME372 MAP controller board, speeds task-to-task communications over the MAP network by a factor of four compared with the company's previous software. This latest software release increases the effective data rate between Unix tasks running on different network nodes from 35,000 to 140,000 bytes/sec. The company offers the new product for \$600/copy and will sell source licenses to interested parties.—Steven H Leibson

8-BIT FLASH A/D CONVERTER DIGITIZES DATA AT 125M SAMPLES/SEC

The HADC77200 flash A/D converter from Honeywell's Signal Processing Technologies (Colorado Springs, CO, (303) 577-1000) features a minimum sample rate of 125M samples/sec with a 5-nsec acquisition time. The IC includes an input preamplifier that minimizes the input noise often associated with flash converters. The converter, including the preamp, can follow signals with slew rates to 650V/ μ sec. Prices for the device are \$115 (100) for a ± 0.75 -LSB version of the converter and \$150 for a ± 0.5 -LSB version.—Steven H Leibson

IMAGE-PROCESSING ICs OPERATE ON VIDEO IMAGES IN REAL TIME

A family of five devices, which will be available in the 3rd qtr from LSI Logic Corp (Milpitas, CA, (408) 433-8000), will allow you to build real-time image-processing systems. Components in the 20-MHz family obtain their speed from highly parallel internal architectures. The \$35 (500) L64210 and \$60 (500) L64211 variable-length, video shift registers act as formatting devices for the other devices in the family by accepting four 1032-pixel or eight 516-pixel lines of 8-bit/pixel video data, respectively, and outputting the data in a parallel, multiline format. The \$395 (500) L64220 rank-value filter operates on 12-bit data points in 1x64-, 2x32-, 4x16-, or 8x8-pixel arrays; determines pixel maxima or minima; finds pixels with a user-specified value; or masks pixels for windowing operations.

The \$395 (500) L64230 binary filter and template matcher contains 1024 filter taps, each consisting of a 1-bit multiplier/comparator and associated adder, and will operate on 1- or 2-dimensional pixel arrays with window sizes to 32x32 pixels. Comprising the equivalent of 64 8x8-bit multiplier/accumulators, the \$695 (500) L64240 multibit filter operates on 8- or 16-bit data presented in 1- or 2-dimensional arrays. All of the components are available as building blocks for incorporation into the company's ASICs.—Steven H Leibson

Bringing the Worlds of Data Acquisition and DSP Together

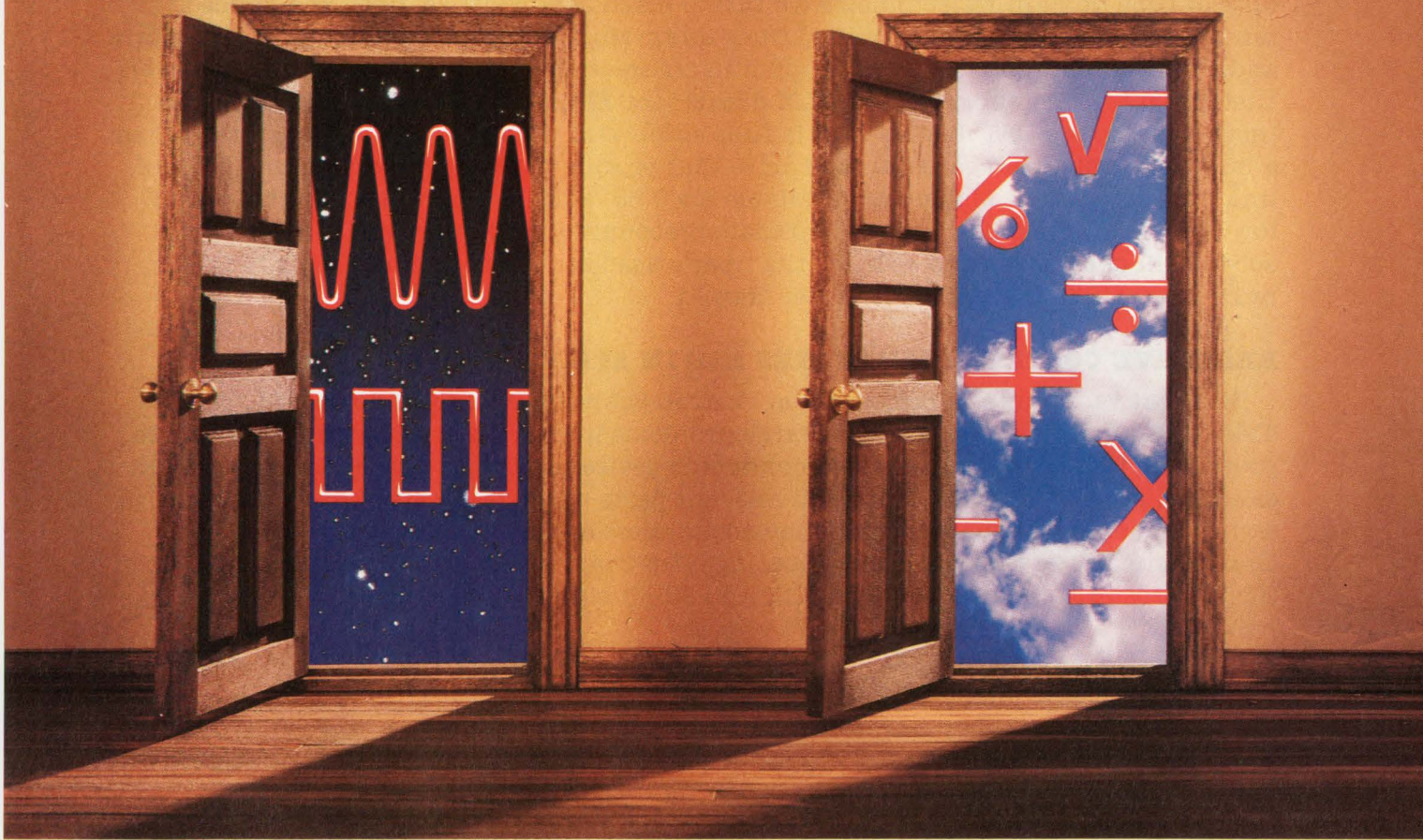

You can have the best of both worlds from just one source. Data acquisition and DSP are just down the hall from each other at TRW LSI. That's good, because these functions must perform in close harmony in your system. We can relate. No one understands your total system needs better than we do.

And, no one offers a broader range of cost-effective, high-performance analog and digital circuits. Converters up to 200 MHz. DSP building blocks up to 20 MHz. And that's just for openers.

Data acquisition and DSP are on a converging course at TRW LSI. Not far beyond these doors lies a whole new world of data conversion, floating point, image processing and graphics DSP chips. If that sounds like opportunity knocking, you're right.

Our doors are always open. Our technical staff is waiting to help you. Let us help bring your high-performance data acquisition and DSP requirements together. Contact us at 619.457.1000 and ask for one of our applications engineers. We'll help make a world of difference in your system performance.

LSI Products Division
P.O. Box 2472, La Jolla, CA 92038
619.457.1000

In Europe, call or write:
TRW LSI Products
Konrad-Celtis-Strasse 81
8000 Muenchen 70, W. Germany
089.7103.115

In the Orient, phone:
Hong Kong, 3.856199;
Tokyo, 03.461.5121; Taipei, 751.2062;
Seoul 2.553.0901

© TRW Inc. 1987 — 712A01087

LSI Products Division

NEWS BREAKS: INTERNATIONAL

OPTICAL TIME-DOMAIN REFLECTOMETER SIMPLIFIES FIBER TESTING

Simple menu-selected test setups allow unskilled personnel to use the 7720 Series optical time-domain reflectometer (OTDR) to make bandwidth or fiber and splice attenuation measurements on optical fiber links. More experienced personnel can obtain additional measurement data and zoom in on areas of special interest. From Solartron Instruments (Farnborough, UK, TLX 858245, or Elmsford, NY, (914) 592-9168), the instrument has a CRT display that is fully annotated with the fiber's losses, and it has a built-in printer and cassette tape drive that provide hard copy and storage/recall of link characteristics. Models are available for 0.85- and 1.3- μm multimode fibers and for 1.30- μm single-mode fibers. A special optocoupling device for the 0.85- μm fiber accepts all cable sizes and reduces the fiber's dead zone to zero. The OTDRs range in price from £12,000 to £16,500.—Peter Harold

RESISTIVE COATING ELIMINATES ESD IN ATE FIXTURES

Diss-Stat vacuum test fixtures from Factron Schlumberger (Ferndown, UK, TLX 41436) eliminate electrostatic-discharge problems in board-test ATE, which can cause premature failure of sensitive semiconductor devices on the pc boards under test—for example, submicron VLSI chips. All relevant parts of the test fixture, including any internal and external surfaces that may accumulate an airflow-induced electrostatic charge, are coated with a resistive coating. This coating provides a discharge path for the electrostatic charge of between 10^9 and 10^{10} Ω /square.—Peter Harold

MITI GIVES APPROVAL TO US LAB FOR INSPECTION OF EXPORTS TO JAPAN

The Japanese Ministry of International Trade and Industry (MITI) has designated the United States Testing Co Inc (Hoboken NJ) as a Specific Foreign Inspection Organization in the "JIS" Mark program. This authorization by the MITI allows US Testing to perform inspection for export to Japan on a wide variety of industrial and consumer goods, including electronic equipment and electrical machinery. For more information, you can call the company at (201) 792-2400.—Joan Morrow

US CONCEPT, JAPANESE ENGINEERING LEAD TO NEW OFFICE PRODUCT

From a concept by Jef Raskin, originator of the Macintosh computer, Canon Inc (Tokyo) and Canon USA (Lake Success, NY, (516) 488-6700) have engineered and produced the Canon Cat, a "work processor" that includes a keyboard, 9-in. black-and-white display, software with spelling checker, a 3½-in. floppy-disk drive, a modem, and serial and parallel interfaces. An improvement in cursor control, called Leap keys, allows you to quickly locate and edit, move, or restyle information in 180k bytes of stored text in just a few keystrokes. The systems sells for \$1495.—Joan Morrow

US vs. THEM

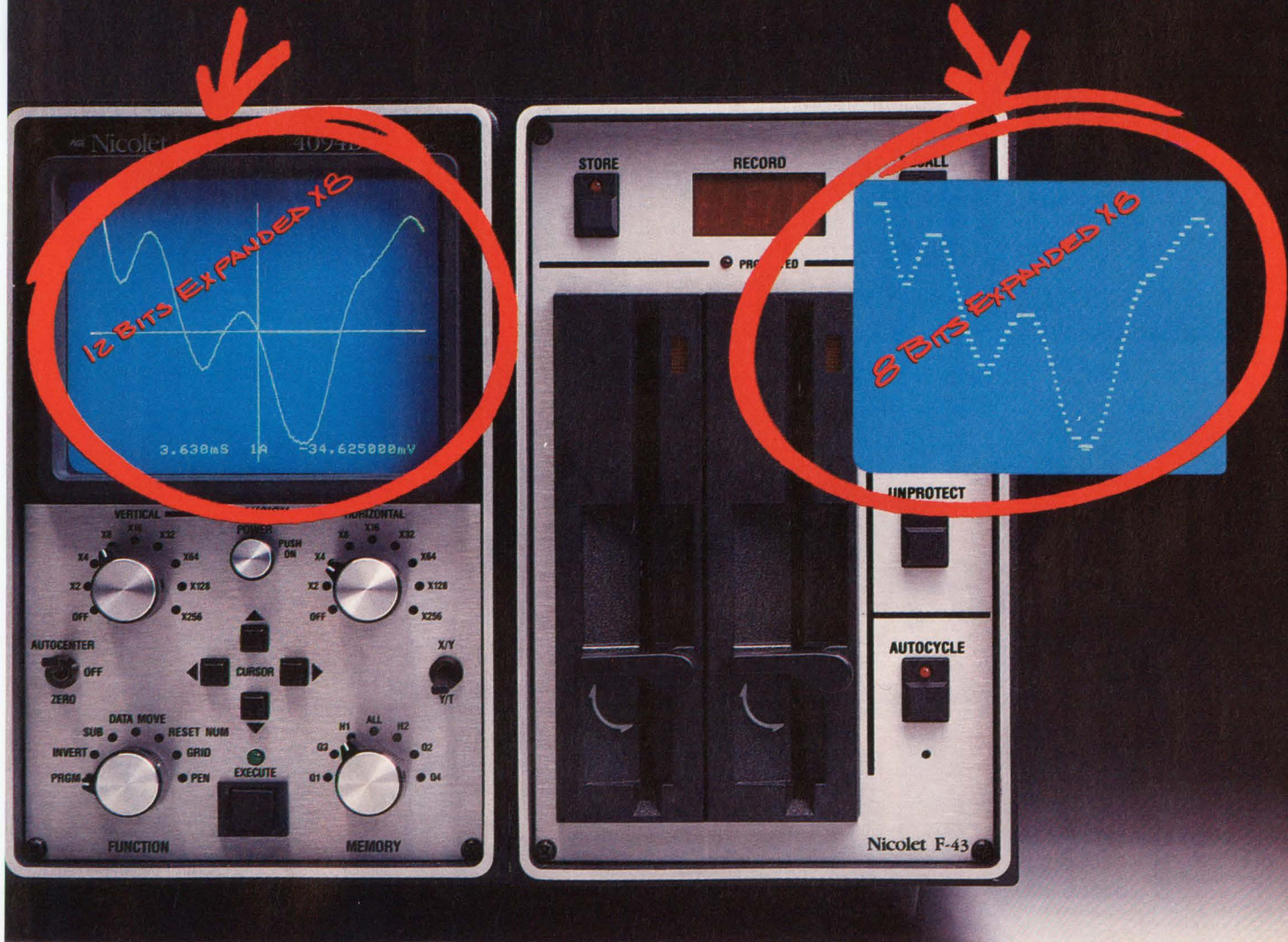

High resolution 12-bit digitizers vs. "typical" 8-bit digitizers.

Do you want to see the details in your signal or not?

800/356-3090
or 608/273-5008

Nicolet Test Instruments Division
P.O. Box 4288
5225-2 Verona Road
Madison, WI 53711-0288

EDN August 6, 1987

Nicolet Digital Oscilloscopes

Bring the true power of digital oscilloscopes to bear on your problem. High accuracy, high resolution 12-bit digitizers let you zoom in on the small variations in your waveform. Variations you've been trying to find, but can't. That's why Nicolet digital scopes offer waveform expansion on the time and voltage axes up to X256. That's why Nicolet scopes have precise cursor readout of each measured data value.

Make sure your digital storage oscilloscope is part of the answer, not part of the problem.

NTE Nicolet
"Instruments of Discovery"

CIRCLE NO 113



value-packed
filters **\$9.95**
 from

dc to 3GHz

- less than 1dB insertion loss over entire passband
- greater than 40dB stopband rejection
- 5 section, 30dB per octave roll-off
- VSWR less than 1.7 (typ)
- over 100 models, immediate delivery
- meets MIL-STD-202
- rugged hermetically sealed package (0.4 x 0.8 x 0.4 in.)
- BNC, Type N, SMA available

finding new ways ...
 setting higher standards

Mini-Circuits

A Division of Scientific Components Corporation
 P.O. Box 350166, Brooklyn, New York 11235-0003 (718) 934-4500
 Domestic and International Telexes: 6852844 or 620156

| LOW PASS | Model | *LP- | 10.7 | 30 | 50 | 70 | 100 | 150 | 200 | 300 | 450 | 550 | 600 | 750 | 850 | 1000 |
|--------------------------------|-------|------|------|----|----|----|-----|-----|-----|-----|-----|-----|-----|------|------|------|
| Min. Pass Band (MHz) DC to | | | 10.7 | 32 | 48 | 60 | 98 | 140 | 190 | 270 | 400 | 520 | 580 | 700 | 780 | 900 |
| Max. 20dB Stop Frequency (MHz) | | | 19 | 47 | 70 | 90 | 147 | 210 | 290 | 410 | 580 | 750 | 840 | 1000 | 1100 | 1340 |

Prices (ea.): P \$9.95 (6-49), B \$24.95 (1-49), N \$27.95 (1-49), S \$26.95 (1-49)

| HIGH PASS | Model | *HP- | 50 | 100 | 150 | 200 | 300 | 400 | 500 | 600 | 700 | 800 | 900 | 1000 | |
|--------------------------------|-------|------|-------------|-----|-----|-----|-----|------|------|------|------|------|------|------|------|
| Pass Band (MHz) | | | start, max. | 41 | 90 | 133 | 185 | 290 | 395 | 500 | 600 | 700 | 780 | 910 | 1000 |
| | | | end, min. | 200 | 400 | 600 | 800 | 1200 | 1600 | 1600 | 1600 | 1800 | 2000 | 2100 | 2200 |
| Min. 20dB Stop Frequency (MHz) | | | | 26 | 55 | 95 | 116 | 190 | 290 | 365 | 460 | 520 | 570 | 660 | 720 |

Prices (ea.): P \$12.95 (6-49), B \$27.95 (1-49), N \$30.95 (1-49), S \$29.95 (1-49)

*Prefix P for pins, B for BNC, N for Type N, S for SMA *example: PLP-10.7*

CIRCLE NO 114

C105 REV. C

RF transformers

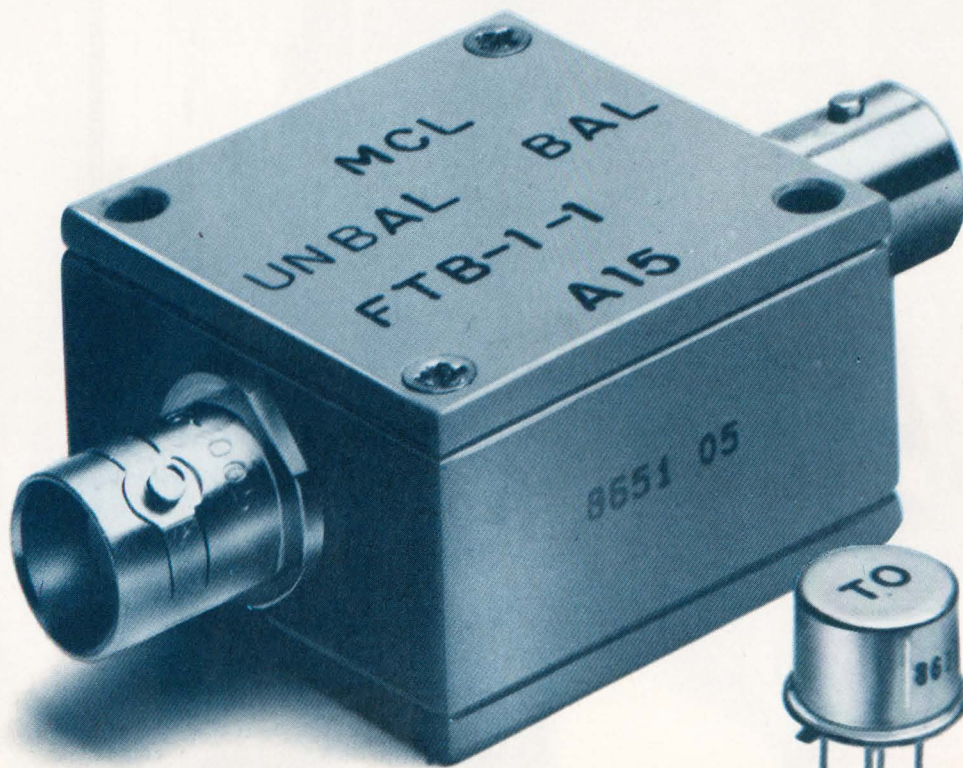

3 KHz-800 MHz
over 50 off-the-shelf models
from \$2⁹⁵

Choose impedance ratios from 1:1 up to 36:1, connector or pin versions (plastic or metal case built to meet MIL-T-21038 and MIL-T-55631 requirements*). Fast risetime and low droop for pulse applications; up to 1000M ohms (insulation resistance) and up to 1000V (dielectric withstanding voltage). Available for immediate delivery with one-year guarantee.

Call or write for 64-page catalog or see our catalog in EBG, EEM, Gold Book or Microwaves Directory.

*units are not QPL listed

finding new ways ...
setting higher standards

 **Mini-Circuits**

A Division of Scientific Components Corporation
P.O. Box 350166, Brooklyn, New York 11235-0003 (718) 934-4500
Domestic and International Telexes: 6852844 or 620156

C71 Rev. A

CIRCLE NO 153

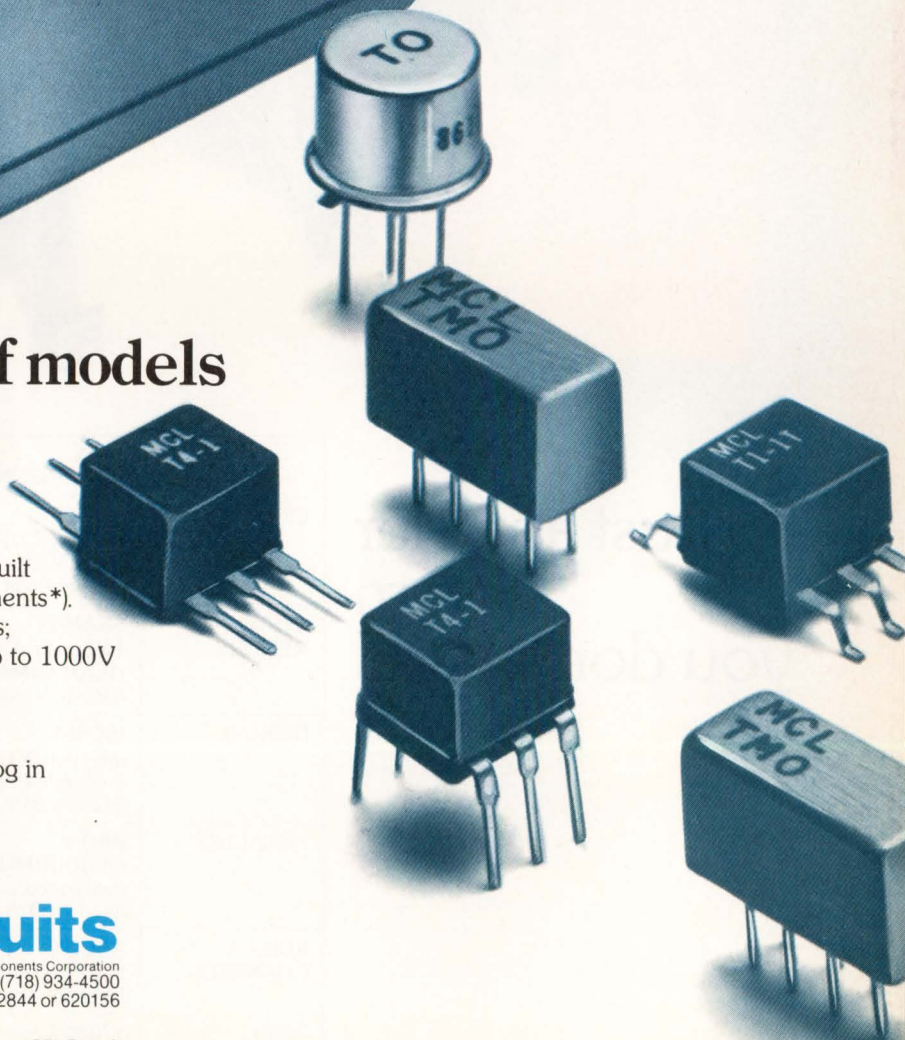

THE FOCUS



Not just another
system
you don't need

| | UNIX: FOCUS 32 UNIX System 25 | REALTIME: FOCUS 32 PDOS System 21 |
|-------------------|--|--|
| CPU | CPU-25 68020 (16.7/20 MHz) Paged MMU Floating Point Coprocessor | CPU-21 68020 (20/25 MHz) Zero wait state operation Floating Point Coprocessor |
| SYSTEM MEMORY | SRAM-22 1 Mbyte SRAM DRAM-E4M4 4 Mbyte of highspeed VMEbus DRAM | SRAM-22 1 Mbyte of SRAM, zero wait state access |
| DISK I/O | ISCSI-1 68010 (10 MHz) 128 Kbyte SRAM dual ported, zero wait state access SCSI interface, SA460 floppy interface | ISCSI-1 68010 (10 MHz) 128 Kbyte SRAM dual ported, zero wait state access SCSI interface, SA460 floppy interface |
| SERIAL I/O | ISIO-1 68010 (10 MHz) 128 Kbyte SRAM dual ported, zero wait state access 8 serial I/O channels (RS232) | ISIO-1 68010 (10 MHz) 128 Kbyte SRAM dual ported, zero wait state access 8 serial I/O channels (RS232) |
| ADD. I/O CHANNELS | ASCU-2 System controller, IEEE 488 interface, Centronics parallel printer port | ASCU-2 System controller, IEEE 488 interface, Centronics parallel printer port |
| DISK DRIVES | 170 Mbyte winchester, 1 Mbyte floppy 120 Mbyte streamer tape | 170 Mbyte winchester, 1 Mbyte floppy 120 Mbyte streamer tape (optional) |

IS ON VME

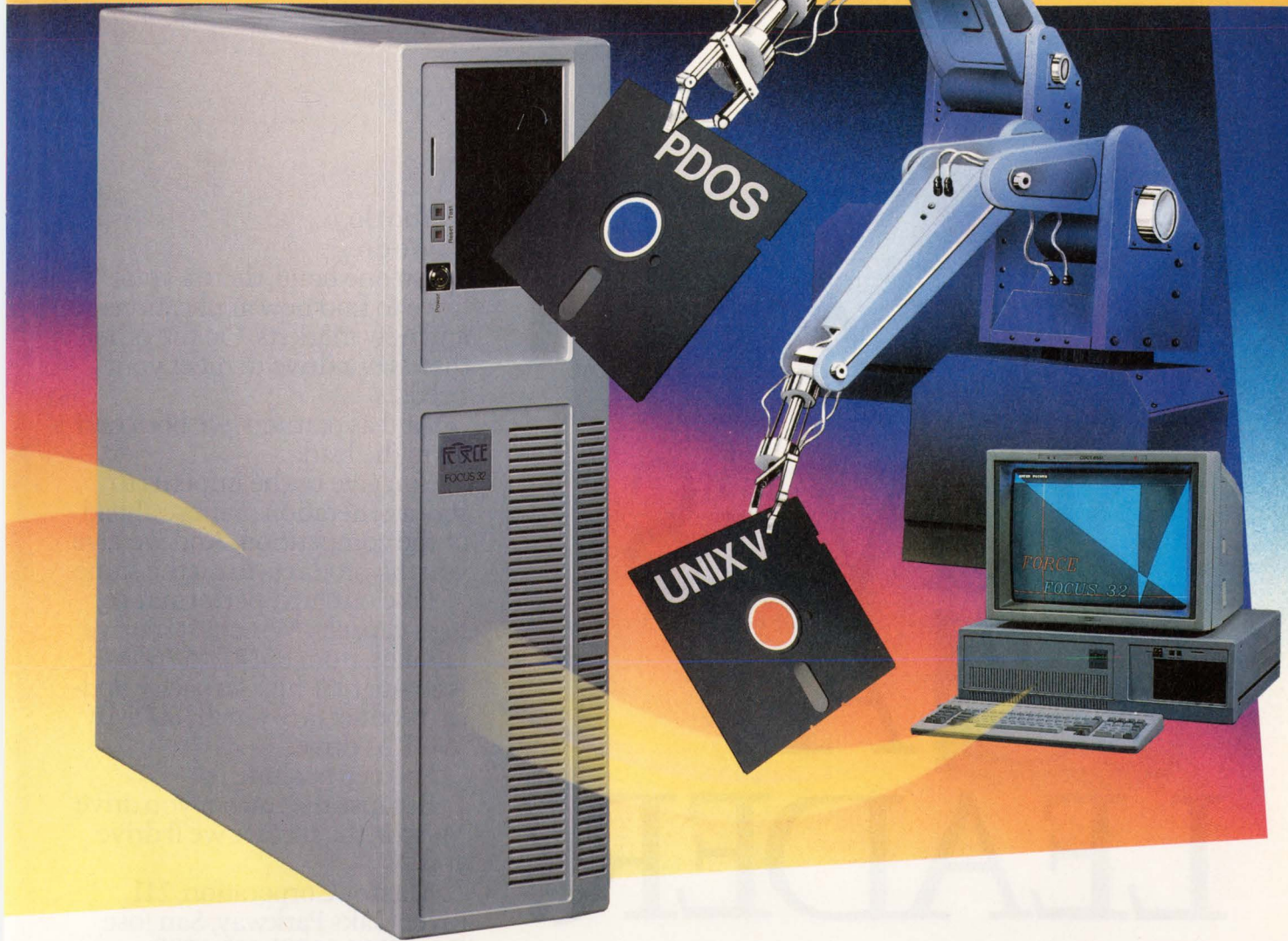

For the last five years our sole business has been to provide customers with high performance VMEbus solutions. The FOCUS 32 series is an extension of our ongoing commitment to the VMEbus product spectrum, software and support. FOCUS 32 reflects inputs from many customers to take full advantage of the open VMEbus architecture in the smallest possible space (6.7 x 21.3 x 23.7 inches) without sacrificing reliability, ruggedness, expansion capabilities and user friendliness.

The powerful FOCUS 32 supports both UNIX* System V and real time PDOS* including a wide range of compilers.

Intelligent serial and SCSI controllers reduce bus traffic and CPU overhead to maximize system throughput.

You also have a choice to upgrade the FOCUS 32 development/target system by adding any of our more than 50 boards.

We don't want you in the dark with just another black box. That's why we provide you with an open system architecture right down to the component level of our VMEbus boards.

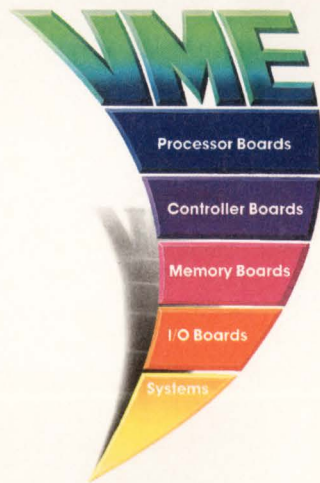

Free! Call 1-800-Best VME
(or 1-800-237-8862 in California) for our 380 page VME data book and for rapid applications support.



FORCE COMPUTERS, INC., Los Gatos, CA 95030, Phone (408) 354-3410
Midwest: Ann Arbor, MI 48108, Phone (313) 769-0840
Southeast: Roswell, GA 30076, Phone (404) 642-9647
FORCE COMPUTERS GMBH, 8012 Ottobrunn, Phone (089) 600910
FORCE COMPUTERS FRANCE, 92100 Boulogne, Phone (1) 46203737
FORCE COMPUTERS (UK) LTD, Wendover, Phone (0296) 625456

*UNIX is a registered trademark of AT&T Bell Laboratories.
PDOS is a registered trademark of Eyring Research Institute.

CIRCLE NO 125

WHAT DRIVES A LEADER?

You do.

We do.

On one hand, there's your drive to find new applications and new markets. On the other, there's our drive to meet your needs.

And as partners, we both end up in the lead.

You give us the impetus to stay a generation or more ahead of the competition. And we give you the products to do the same.

Like our high-performance, high-capacity Winchester drive families, from 85MB to 760MB. And our first high-capacity optical product, a 5¼-inch, 800MB WORM drive.

So keep pushing us.

Because the further you drive Maxtor, the further we'll drive you.

Maxtor Corporation, 211 River Oaks Parkway, San Jose, CA 95134, (408) 432-1700, TELEX 171074.

Sales offices: Austin (512) 345-2742, Boston (617) 872-8556, Orange County (714) 472-2344, New Jersey (201) 747-7337, San Jose (408) 435-7884, Woking, England (44)/4862-29814.

Maxtor

SIGNALS & NOISE

A clarification of telephone-noise specs

The excellent article by Brady Barnes in EDN's May 14 issue ("Check advanced features and noise specs when selecting codecs," pg 227) was interesting and informative in most respects, but Mr Barnes's attempts to clarify noise specifications (on pgs 229 to 234 of the article) may have added to any existing confusion about them. As an engineer with over 20 years' experience in testing international telephone circuits, perhaps I can offer some clarification.

Telephone-circuit weighing filters are based on the performance of telephone handsets, not on that of the human ear. While the Bell Telephone system held a monopoly position in the US, weighing filters were based on the telephone set currently in use. Bell system engineers thought that noise should be measured as a positive quantity; they introduced the concept of "reference noise." When the Western Electric Co (WECO) Model 144 handset was in use, the noise-measuring term was "dBRN" (144 line). The WECO Model F1A handset resulted in F1A weighing. C-Message-weighing filters are based on the WECO Model 500 handset, and the current US telephone noise-measuring term is dBrnC; -90 dBm is the current reference-noise level.

The CCITT, as an international standards group, produced a weighing filter based on the characteristics of most of the world's telephone handsets, and called it a "psophometric" filter after the Greek word "psophos," which means "noise." The CCITT's term for telephone-noise measurement is dBmp.

The CCITT did not adopt the Bell system's concept of reference noise, and no CCITT noise measurement implies reference noise. Unweighed noise is measured in dBm. Conversion to dBrn is simply a matter of adding 90. For example, a CCITT

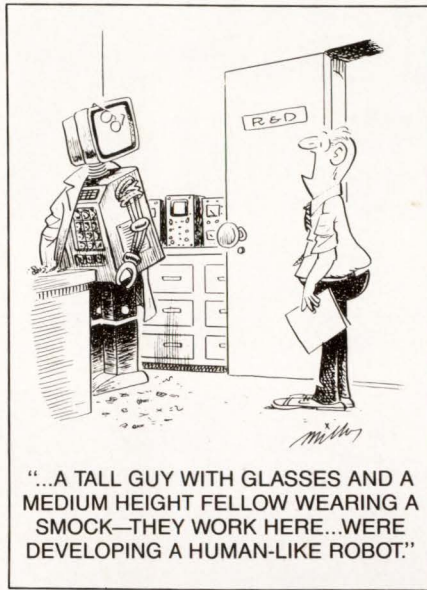

"...A TALL GUY WITH GLASSES AND A MEDIUM HEIGHT FELLOW WEARING A SMOCK—THEY WORK HERE...WERE DEVELOPING A HUMAN-LIKE ROBOT."

measurement of -70 dBm is equal to 20 dBrn (that is, -70 dBm is 20 dB greater than the -90-dBm reference level). Similarly, you can easily convert 30 dBrn to a CCITT level of -60 dBm by subtracting 90. This conversion is exact for an unweighed measurement such as 3-kHz flat.

The psophometric and C-message filters are so nearly equivalent in terms of noise-power measurements that, even though the C-message filter is based on a reference tone of 1000 Hz and the psophometric filter is based on an 800-Hz tone, in a practical sense they are used interchangeably. In a telephone channel that has only white noise, both filters improve the noise reading by approximately 2 dB as compared with a 3-kHz flat measurement.

Consequently, you can convert dBmp to dBrnC simply by adding 90, and you can convert dBrnC to dBmp by subtracting 90. In other words, -65 dBmp is equal to 25 dBrnC. The conversion is accurate to within ± 0.5 dB, which is better than the accuracy of most noise meters.

The term "dBp" means "dB referred to 1 pW," just as "dBm" means "dB referred to 1 mW." Since the Bell system has established 1 pW (-90 dBm) as reference noise, the terms dBrn and dBp are equivalent.

Text continued on pg 34

WHERE TO FIND A LEADER.

For more information on high-capacity Maxtor disk drives, contact our distributor in your area.

CALIFORNIA

Anthem Electronics, Inc.

(714) 768-4444

(408) 295-4200

FLORIDA

Pioneer Standard Electronics, Inc.

(305) 934-9090

GEORGIA

Pioneer Standard Electronics, Inc.

(404) 448-1711

Quality Components

(404) 449-9508

ILLINOIS

Pioneer Standard Electronics, Inc.

(312) 437-9680

KANSAS

Pioneer Standard Electronics, Inc.

(913) 492-0500

MARYLAND

Pioneer Standard Electronics, Inc.

(301) 921-0660

MASSACHUSETTS

Pioneer Standard Electronics, Inc.

(617) 861-9200

Lionex Corporation

(617) 657-5170

MINNESOTA

Pioneer Standard Electronics, Inc.

(612) 935-5444

NEW YORK

Pioneer Standard Electronics, Inc.

(516) 921-8700

OHIO

Pioneer Standard Electronics, Inc.

(216) 587-3600

(513) 236-9900

PENNSYLVANIA

Lionex Corporation

(215) 443-5150

TEXAS

Quality Components, Inc.

(214) 733-4300

Pioneer Standard Electronics, Inc.

(214) 386-7300

CANADA

Future Electronics

(514) 694-7710

Maxtor

CIRCLE NO 29

TEK'S NEW EASY-TO-EXPERT LOGIC ANALYZER

\$3995.*

Introducing the Tek 1220 and 1225: the two newest members of the Tek 1200 Series of logic analyzers.

Nothing else in their price range delivers so much and makes it all so easy to use. Consider:

1 Powerful state, timing and disassembly analysis.

The 1220 and 1225 provide 32 or 48 data channels, respectively, in groups of 16-channels, with channel groups clocked independently or linked together — so you can

sample

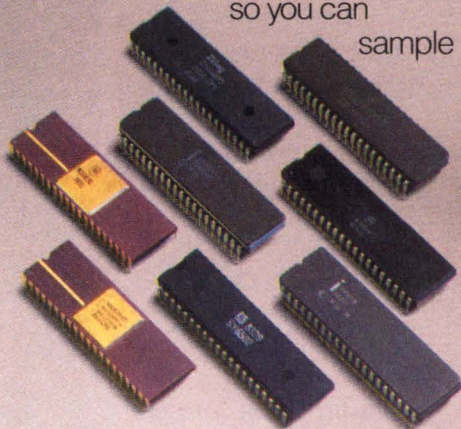

data from as many as three circuit sections at once.

Tek currently provides support for the most popular microprocessors, with additional 8- and 16-bit personality modules to be

introduced continually.

2 A total of four 2K nonvolatile memories support each channel.

Acquire data in one memory and compare it to data in any of the three other memories.

Clock/calendar plus storage for up to eight test set-ups are also in battery-backed memory. Date and time of storage are included with each data memory, so it's easy to find and interpret results.



| Loc | Addr | Data | Z80 Disassembly | Operation |
|------|------|--------|-----------------|-----------|
| 0504 | 0503 | 3A0444 | LD A, (4404) | 4404=00 |
| 0508 | 0506 | FE01 | CP 01 | |
| 0510 | 0508 | 20FF | JR NZ, 040B | |
| TRIG | 0000 | C30001 | JP 0100 | |
| 0515 | 0100 | 31FF7F | LD SP, 7FFF | |
| 0518 | 0103 | CDCB04 | CALL 04CB | 7FFD=0106 |
| 0523 | 04CB | ED4D | RETI | 7FFD=0106 |
| 0527 | 0106 | CDCB02 | CALL 02CB | 7FFD=0109 |
| 0532 | 02C8 | 3E4F | LD A, 4F | |
| 0534 | 02CA | D392 | OUT (92), A | 92=4F |
| 0537 | 02CC | 3E0A | LD A, 0A | |
| 0539 | 02CE | D392 | OUT (92), A | 92=0A |
| 0542 | 02D0 | 3E83 | LD A, 83 | |
| 0544 | 02D2 | D392 | OUT (92), A | 92=83 |
| 0547 | 02D4 | DB90 | IN A, (90) | 90=01 |
| 0550 | 02D6 | 3E0F | LD A, 0F | |
| 0552 | 02D8 | D393 | OUT (93), A | 93=0F |
| 0555 | 02DA | 3E0C | LD A, 0C | |
| 0557 | 02DC | D393 | OUT (93), A | 93=0C |
| 0560 | 02DE | 3E83 | LD A, 83 | |

```

MON, FEB 02, 1987  State: Memory 4  14:28  IOBOARD
-----
Addr  Data  Ah  Al  Displayed bytes)
0000  33 50 1011101  00000000
0010  74 50 1011101  00110100
0020  D4 5C 10011101  00111101
0030  D6 7C 11110111  00100000
0040  DE 7E 11110110  00100001
0050  FA 6E 11110110  00110010
0060  17 C8 01001000  11011101
0070  15 E8 00100010  11000000
0080  17 E8 00100010  11000000
0090  39 F9 00100011  10000001
00A0  39 F9 00001111  00001111
00B0  39 50 00011101  00010000
00C0  38 50 10111101  00010001
00D0  D4 50 10111101  00110000
00E0  FA 4E 11011010  11101101
00F0  FA C7 11101000  11110000
0100  5B C7 01101000  11110001
0110  17 C7 01101000  11010100
0120  78 5C 10011101  00111101
0130  DE 7C 11110111  00110000
Func:F Scroll:~w Cur:0,1 Locate, TRIG:2 Cond:3 Diff:1
  
```

Left Set reference cursors on the timing diagram to measure pulse width or the time between pulse edges. Above State tables are displayable in binary or hex formats.

Use the optional interfaces to control the instruments via computer and attach inexpensive dot matrix printers for immediate documentation.

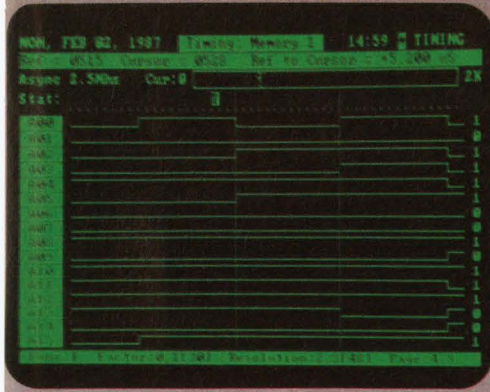

3 Triggering can be as simple or sophisticated as you choose.

Specify up to 24 trigger conditions. Conditionally branch with up to 12 levels of IF...THEN...ELSE statements. Cross-trigger between channel groups. Do state and timing analysis simultaneously.

| | | |
|----------------|---------------|----------------|
| 0 Mem Config | 4 Mem Select | A Storage |
| 1 Timebase | 5 State | B Clock/Name |
| 2 Trigger Spec | 6 Disassembly | C Video/Keypad |
| 3 Conditions | 7 Limits | D Option 1 |
| | 8 Compare | E Option 2 |
| | | F Option 3 |

Above Pop-up menus, such as this main menu, are easy to understand and logically arranged.

Capabilities like these make the 1220/1225 more than hardware analyzers. They are capable tools for both software debugging and system integration.

4 Pop-up menus are easy to use. Logically arranged. And respond instantly on command.

Push one button for on-screen notes appropriate to the current display.

5 This is affordable logic analysis in a league by itself. Users can evolve from one unit to another, through the entire 1200 Series, with a minimum of readjustment. You can be confident that Tek quality is built in, and that documentation and service will be there when required.

Call 1-800-245-2036 (in Oregon, 231-1220) for more information or for the name of your nearest Tek sales engineer. Learn why these are the first low-cost logic analyzers that don't act like it.

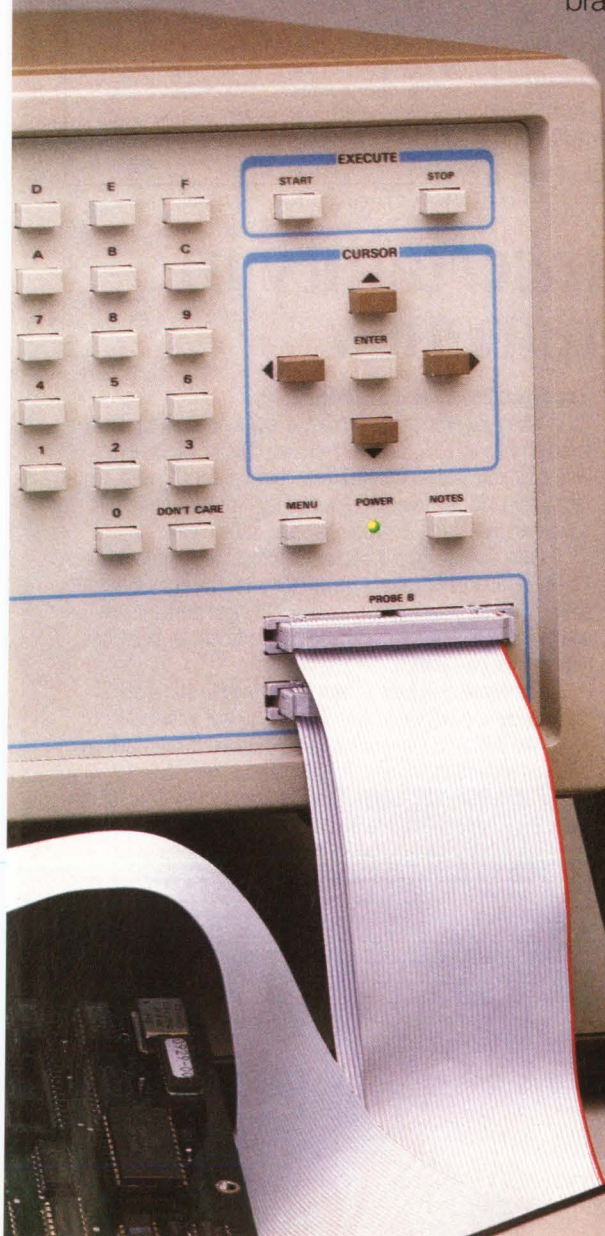

Tektronix
COMMITTED TO EXCELLENCE

Circle 115 for literature
Circle 154 for sales contact

SIGNALS & NOISE

lent, and no weighing is implied.

Thus, -65 dBm0p (the level that CCITT recommends idle-channel noise not exceed) is equal to 25 dBmC0 ($-65+90$) for telephone weighing. The equivalent 3-kHz flat values are -63 dBm0 and 27 dBm0 (you add 2 to remove the weighing effect).

Most telecommunications handbooks have these conversion factors in chart form for easy use. One such handbook is Roger L Freeman's *Telecommunication Transmission Handbook*, 2nd ed, which is published by John Wiley & Sons.

G W Foreman

Contel Federal Systems

Applied Systems Div

Fairfax, VA

Transistor should be diode-connected

In my article "JFET-input amps are unrivaled for speed and accuracy"

(EDN, May 14, pg 161), Fig 4 (on pg 165) contains an error. The temperature-sensing transistor, Q_2 , should be diode-connected; that is, its base and collector should be shorted together. Without this short, the circuit will have extreme difficulty working. I hope the error did not cause too many difficulties for those building the circuit.

Peter S Henry

Precision Monolithics Inc
Santa Clara, CA

What's in a name

"The promise of surface-mount technology," part 1 of EDN's Hands-On SMT Project (EDN, May 28, pg 164), used the word "onsserter" in the photo caption on pg 172 as a generic name for automatic-insertion equipment for surface-mount devices (SMDs). Instead, we should have used the term "onsertion equipment," as we did elsewhere in

the article. "Onserter" is a trademark of Universal Instruments Corp (Binghamton, NY) for its pick-and-place machine for SMDs. We apologize for inadvertently taking the name in vain.

Sorry, wrong number

The manufacturers' box accompanying EDN's μ C Support-Chip Directory (EDN, June 11, pg 131) contained an incorrect phone number for AT&T Technologies Inc. The correct number is (800) 372-2447.

WRITE IN

Send your letters to the Signals and Noise Editor, 275 Washington St, Newton MA 02158. We welcome all comments, pro or con. All letters must be signed, but we will withhold your name upon request. We reserve the right to edit letters for space and clarity.

How to clear up the uncertainty in your test measurements.



The Fluke 25, 27 and 37 DMMs.

When you need performance that leaves no room for doubt, focus on the Fluke 25, 27 and 37 Analog/Digital Multimeters. With their patented A/D converters, they deliver DC volts accuracy within 1%. An easy-to-view display also provides a full 4 digits of resolution for readings up to 3200 counts.

Fully sealed, drop proof cases protect the handheld Fluke 25 and 27 from abuse on the job site. The unique design of the Fluke 37 is well suited for benchtop and portable use, and includes a convenient storage compartment for test leads and small accessories.

The circuitry in each model is shielded to eliminate interference — even near motors, radar, and other transmitters.

And thirty-six components are dedicated to high-energy overload protection, for you and the meter.

Call **1-800-227-3800**, Ext. 229 today and ask about the Fluke 25, 27 and 37 meters. You'll get the picture.

Fluke 25, 27, & 37

| | |
|--------------------------------|---|
| 0.1% basic dc accuracy | Touch Hold™ function |
| Analog/Digital Display | Relative (difference) mode and MIN/MAX recording mode (27 & 37) |
| Volts, ohms, amps, diode test | Integral handle, storage compartment (37) |
| 0.1 μ A to 10A, all fused | Two-year warranty |
| 30 kHz ac bandwidth | |
| 100 μ V to 1000V ac and dc | |

FLUKE®

CIRCLE NO 30

You told us what
you wanted in
digitizing oscilloscopes,

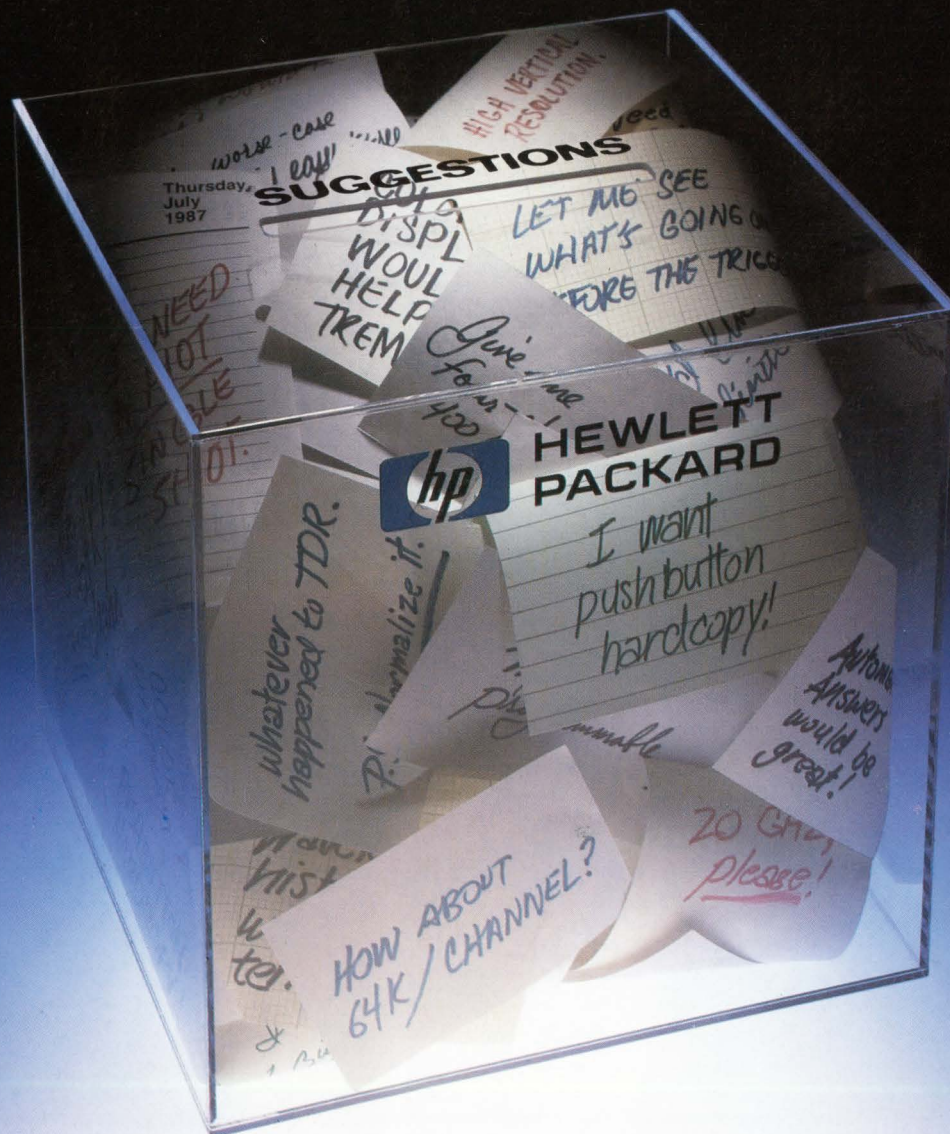

and we
took your advice...

...AGAIN.

Introducing HP's new high-perfo

You told us what would best meet your measurement needs.

So in '84 and '85 we brought you digitizing oscilloscopes with pioneering features like full programmability, 1 GHz repetitive bandwidth, color displays, automatic answers, single-shot pulse reconstruction, infinite persistence, and instant hardcopy output.

And now, we bring you the new HP 54111D/54112D/54120T series.

These high-performance digitizing oscilloscopes let you measure what you've never measured before, with superb accuracy and ease of use.

You'll find innovations

such as 20 GHz bandwidth, 4-channel simultaneous 400 MSa/sec with 64k memory per channel, time domain reflectometry (TDR) with normalization, 10 psec time interval accuracy, and more.

HP 54111D: the hot single shot.

The HP 54111D offers two simultaneous channels operating at up to 1 Giga-sample per second...allowing you to capture high-speed single-shot phenomena such as high-speed pulses, plasma discharge, high voltage arcing, high frequency bursts, laser pulses and high energy events.

You get the single-shot performance of analog storage oscilloscopes with all of the performance advantages of digitizing oscilloscopes.

The HP 54111D also offers a 500 MHz bandwidth, so it will perform admirably in a wide variety of repetitive as well as non-repetitive applications.

HP 54112D: 64,000 bytes times 4.

The HP 54112D offers you simultaneous 4-channel capture at 400 Megasamples per second with 64k of memory per channel. Just right for the long data streams found in serial data communication applications.

HP 54111D

- 1 Gigasample/sec digitizing rate
- 500 MHz repetitive bandwidth
- 250 MHz single-shot bandwidth
- 8k memory per channel
- 1 mV/div sensitivity

HP 54112D

- 400 Megasamples/sec digitizing rate
- 100 MHz repetitive or single-shot
- 4 simultaneous channels
- 64k memory per channel



Performance digitizing oscilloscopes.

Four simultaneous channels enhance critical timing measurements on multiple test points...single-shot. And the HP 54112D's four channels are always real-time correlated for every trigger occurrence.

In automated test, four channels with 64k memory per channel boost your throughput by capturing 256k of data simultaneously.

HP 54120T: excels in high-speed applications.

With its 20 GHz bandwidth and 10 psec accuracy, the HP 54120T lets you measure propagation delays of ICs or switching times of high-speed

diodes. Characterize microwave switches. Verify signal path impedances in computer backplanes and test fixtures. And more.

You get high sensitivity, resolution, and accuracy for repeatable time-interval and voltage measurements, with stability and ease-of-use comparable to lower-performance oscilloscopes.

The HP 54120T offers four channels for logic gate characterization. Time and voltage histograms to help you quantify noise and jitter. Normalization to correct for imperfect connectors in reflection (TDR) and transmission measurements.

Probing to 6 GHz. And the list goes on.

Contact HP today!

For more information on our new high-performance digitizing oscilloscopes, fill out and mail the postage-paid reply card today. Call us direct at 1-800-752-0900. Or contact your local HP sales office listed in the telephone directory white pages. Ask for the electronic instruments department.



HP 54120T

- dc-20 GHz bandwidth with averaging
- 10 psec time interval accuracy
- 0.25 psec time interval resolution
- Time and voltage histograms
- Stable TDR with normalization
- 0.4% voltage accuracy
- 4 channels

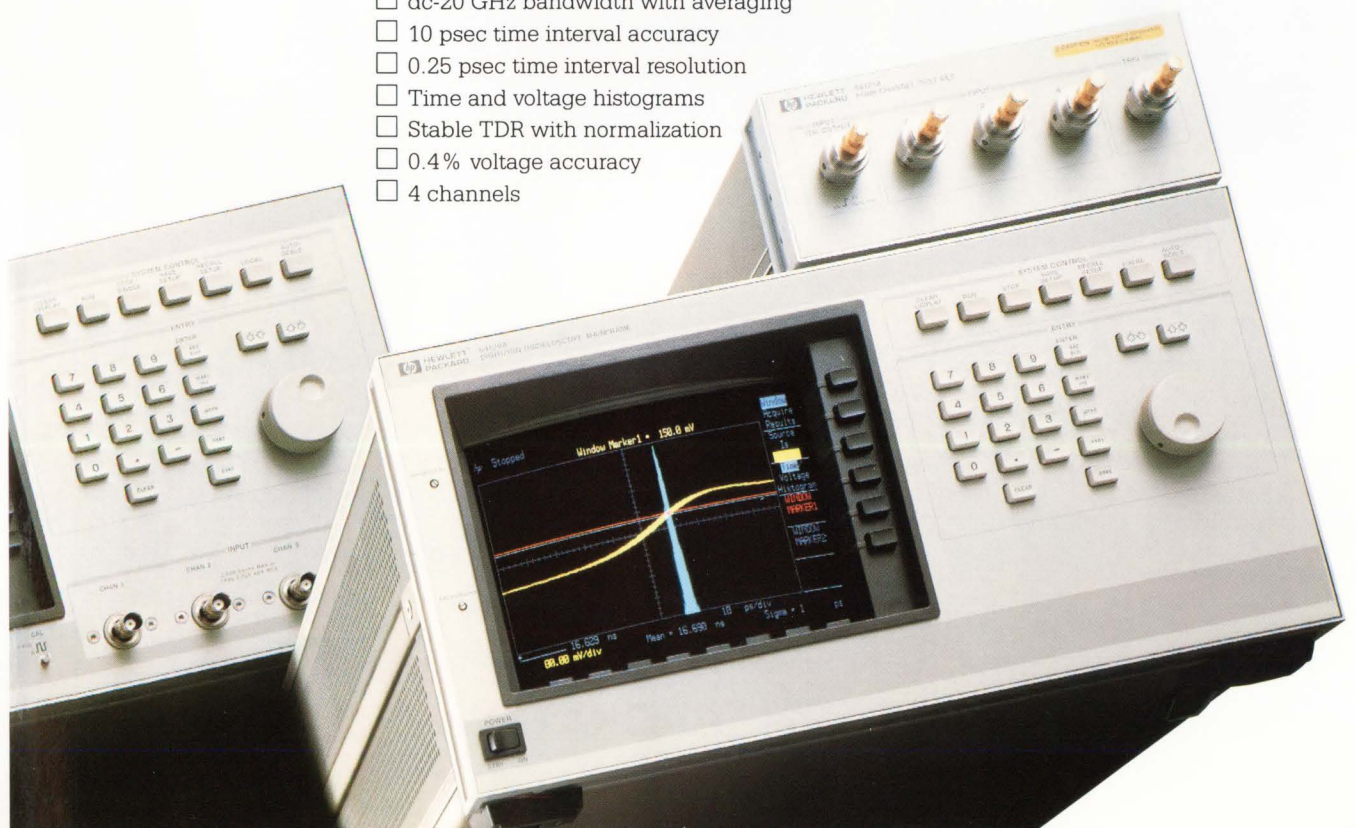

The specs you need, and the features you want.

In addition to their outstanding individual contributions, the new HP 54111D/54112D/54120T digitizing scopes offer you full programmability, automatic measurements, instant hardcopy output to printers and plotters, waveform storage, and multiple-color displays.

You also have HP's excellent reliability, documentation, and support to make you productive with your HP instrument quickly and ensure your satisfaction for years to come.

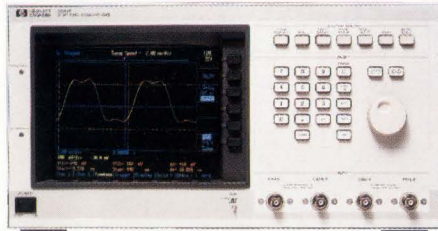

HP 54111D \$23,900.00*

VERTICAL

| | |
|----------------|---|
| Rep. bandwidth | 500 MHz |
| S.S. bandwidth | 250 MHz |
| Inputs | 2 chan & 2 trig |
| Resolution | 8 bit to 25 MHz, 7 bit to 100 MHz, 6 bit to 250 MHz |
| Sensitivity | 1 mV/div to 5 V/div |
| Coupling | ac, dc; 50 Ohm & 1 MOhm |

HORIZONTAL:

| | |
|-----------------------|-----------|
| Digitizing rate (max) | 1 GSa/sec |
| Resolution | 10 psec |
| Pre-trigger viewing | YES |

MEMORY:

| | |
|------------------|---------------------------------|
| Acquisition/chan | 8k |
| Waveform storage | 2 pixel, 4 rep wfm, 4 ss wfm |

| | |
|-------------------------------|----|
| Nonvolatile instrument setups | 10 |
|-------------------------------|----|



HP 54112D \$22,900.00*

VERTICAL:

| | |
|----------------|----------------------------|
| Rep. bandwidth | 100 MHz |
| S.S. bandwidth | 100 MHz |
| Inputs | 4 chan & 1 trig |
| Resolution | 6 bit to 100 MHz |
| Sensitivity | 5 mV/div to 5 V/div |
| Coupling | ac, dc; 50 Ohm & 1 MOhm |

HORIZONTAL:

| | |
|-----------------------|-------------|
| Digitizing rate (max) | 400 MSa/sec |
| Resolution | 40 psec |
| Pre-trigger viewing | YES |

MEMORY:

| | |
|------------------|---------------------------------|
| Acquisition/chan | 64k |
| Waveform storage | 2 pixel, 4 rep wfm, 4 ss wfm |

| | |
|--------------------------------|----|
| Nonvolatile instrument setups: | 10 |
|--------------------------------|----|

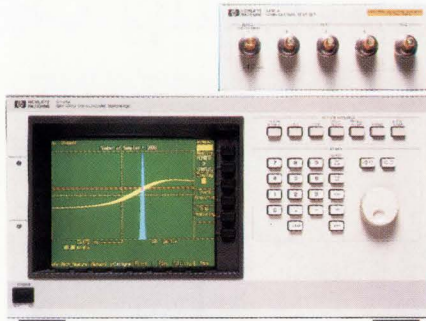

HP 54120T \$27,850.00**

VERTICAL:

| | |
|----------------|-----------------------|
| Rep. bandwidth | 20 GHz |
| S.S. bandwidth | NO |
| Risetime | 17.5 psec |
| Accuracy | 0.4% |
| Inputs | 4 chan & 1 trig |
| Resolution | 12 bits |
| Sensitivity | 1 mV/div to 80 mV/div |
| Coupling | 50 Ohm |

HORIZONTAL:

| | |
|---------------------|---------------------|
| Accuracy | 10 psec |
| Resolution | 0.25 psec |
| Pre-trigger viewing | NO |
| Range | 10 psec/div-1 s/div |

MEMORY:

| | |
|------------------|--|
| Acquisition/chan | 0.5k |
| Waveform storage | 2 pixel (volatile), 4 rep wfm (nonvolatile) |

| | |
|--------------------------------|----|
| Nonvolatile instrument setups: | 10 |
|--------------------------------|----|

TDR

| | |
|---------------------|----------|
| Pulse source | |
| Amplitude | 0-200 mV |
| Risetime | 35 psec |
| Flatness | 1% |
| Normalization | YES |
| Waveform histograms | YES |

*U.S. list price only.
Varies according to options selected.

**U.S. list price only.
Includes both the HP 54120A and HP 54121A.
Specifications subject to change without notice.



HP-IB. Not just IEEE-488, but the hardware, documentation and support that delivers the shortest path to a measurement system.



**HEWLETT
PACKARD**

*we never
stop
asking*
"What if..."

NEPCON™

National Electronic Packaging and
Production Conference

***If you do business in the complex
world of electronics manufacturing,
NEPCON means business for you!***

For further information contact: Cahners Exposition Group, Cahners Plaza,
1350 East Touhy Avenue, P.O. Box 5060, Des Plaines, IL 60017-5060,
Telephone: (312) 299-9311, U.S. Telex: 256148 CEGCGO DSP,
Int'l Telex: 82882 CEG CHGO



A Member of:
THE REED
EXHIBITION
COMPANIES

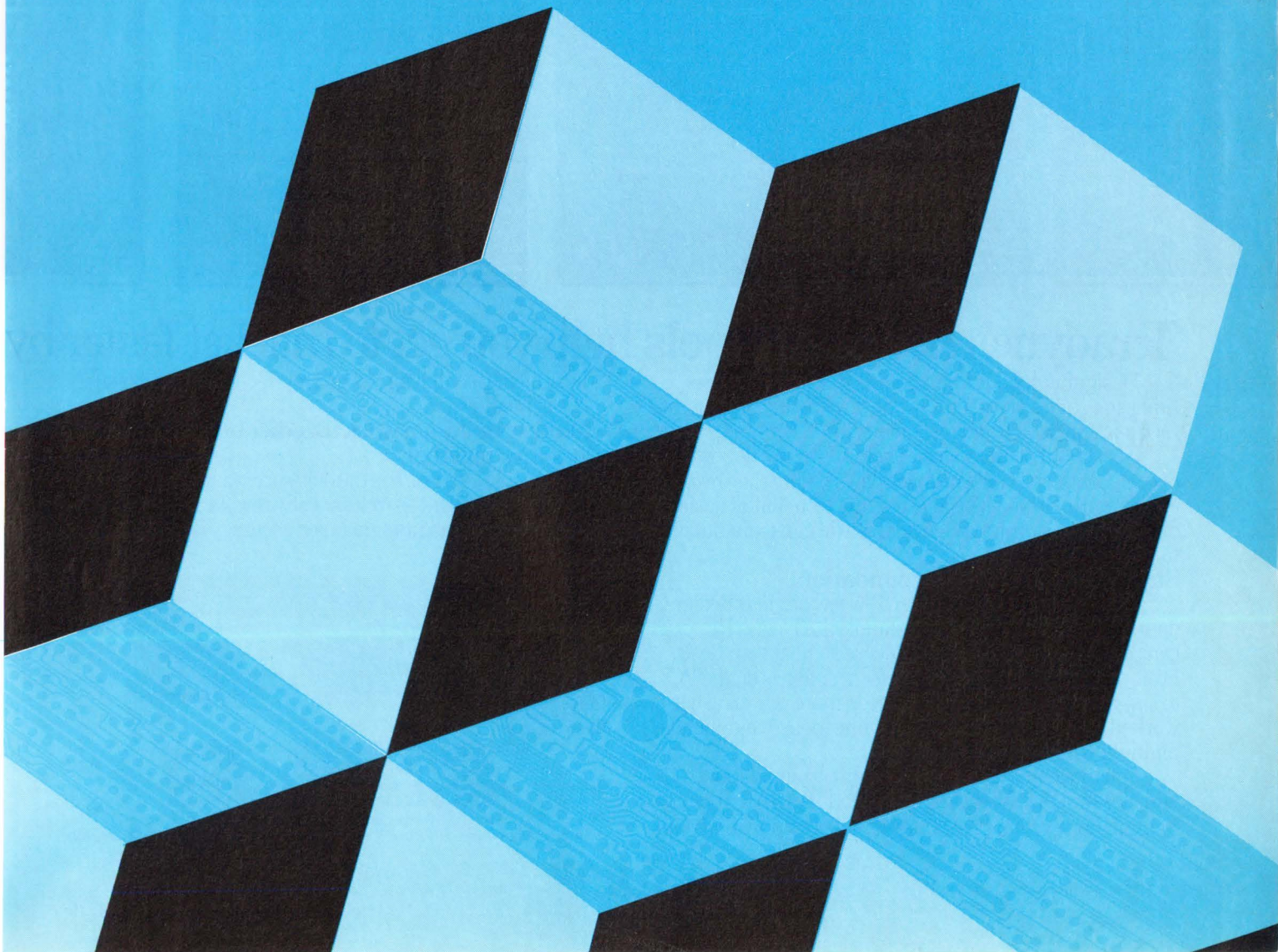

ONE PROTOTYPE THREE PROTO FIVE PROTOTYPE SEVEN PROTO

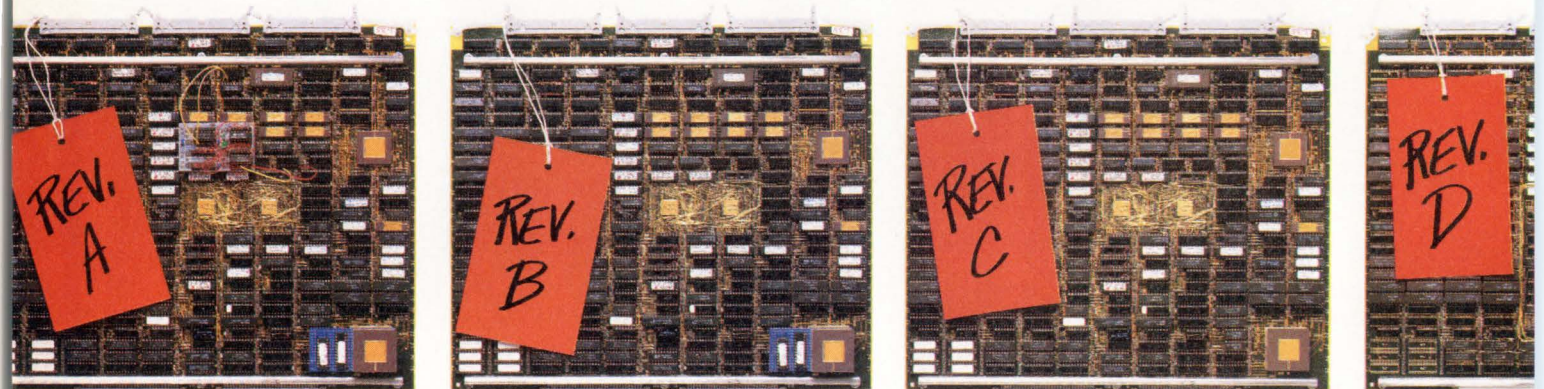

Teradyne's new CAE tools help you get to market faster by

Designing VLSI circuit boards that work the first time isn't child's play. You can't do it without fast, accurate feedback on design and test quality.

Now count on Teradyne to help. With our new family of CAE products, you'll uncover flaws before they're cast in hardware. So you'll be able to jump from initial design directly to final prototype. And from design to manufacturing test.

Start with a firm design foundation.

The process starts with DATAView our new design entry system. Running it on a standard AT-class PC, you can control the whole design process right at your desk. From schematic entry and waveform analysis on the PC to simulation and fault simulation on more powerful networked computers. All with the same mouse-and-menus, multiple-window interface.

You move from schematic capture to simulation effortlessly. DATAView's links with our LASAR Version 6 simulation system save hours of model compilation time.

Incremental compiling lets you revise a design and resimulate in minutes.

Make your design work together before it comes together.

LASAR Version 6 is the only sure way to avoid multiple trips to artwork as well as costly rework steps in manufacturing. Because its simulation accuracy is unmatched

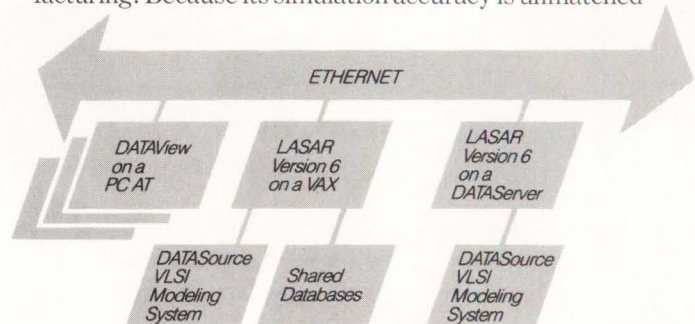

Teradyne networks advanced CAE tools for convenience and performance.

TWO PROTOTYPE, TOTYPE FOUR. SIX PROTOTYPE, TOTYPE, MORE.

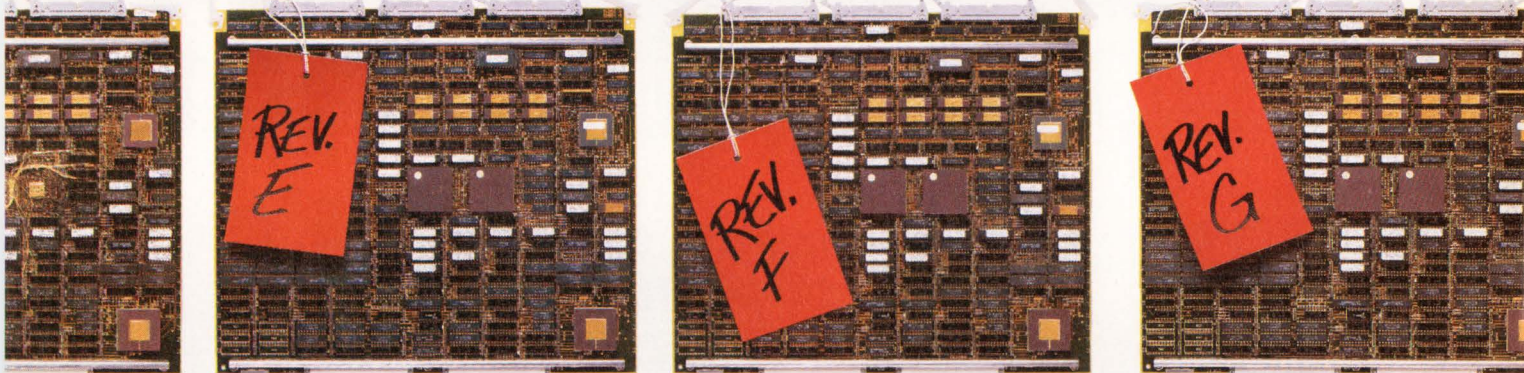

giving you a working prototype the first time.

for analyzing PC board designs prior to prototyping. For instance, LASAR takes full device timing specifications into account for true worst-case timing analysis. And it eliminates shared timing ambiguity in reconverging signals. Both of which mean LASAR finds real design errors reliably.

Finally, you can use LASAR fault simulation. It will uncover testability problems and untested circuit functions before it's too late.

Simulation without trial and tribulation.

LASAR also takes care of the board modeling problem. It includes models of over 4000 devices. And the most popular gate array libraries.

For new VLSI parts, our DATASource hardware modeling system uses actual devices instead of software models. A single system supports multiple users and concurrent fault simulation. With extraordinarily fast response.

LASAR and DATASource work with any VAX. For

simulations up to 25 times faster, you can use our new parallel/multiprocessing host, DATAServer. It will give you quick results, with full LASAR precision.

Teradyne makes it easy.

If you want to avoid multiple prototypes and get to market faster with better products, Teradyne's new CAE system is the way. Why not call Daryl Layzer at (617) 482-2700, ext. 2808 for more information. Or write Teradyne, 321 Harrison Avenue, Boston, MA 02118.

VAX is a trademark of Digital Equipment Corp.
AT is a trademark of International Business Machines Corp.

TERADYNE

We measure quality.

Hitachi's Wide Selection of CMOS Microprocessors Gives You Freedom of Choice

Visit the grasslands of Africa, and you'll be amazed by the sheer variety of life. Each animal has evolved with specific traits, especially suited to its needs... its environment.

Take a look at the CMOS Microprocessors and Microcontrollers from Hitachi. Here's an incredible variety of devices, each created to meet your specific design needs.

Hitachi makes more devices in CMOS than anybody else. Our product lines include CMOS microprocessors and microcontrollers, as well as peripherals, gate arrays, and a broad range of memories. They're available in various industry-

standard architectures, in a choice of speeds, temperature ranges, and packaging variations.

Now you can get CMOS benefits in many of your old favorites. Plus, we've come up with some new devices destined to become your new favorites.

Hitachi has the CMOS solution for all your designs. Our high-speed CMOS devices are perfect for portable instrumentation, telecommunications, high-reliability industrial control, automotive applications, and systems used in harsh environments.

These devices are available in production quantities today. Many are second-sourced. Now you can build high-performance systems that are more reliable, smaller, and less expensive.

Abundant Variety

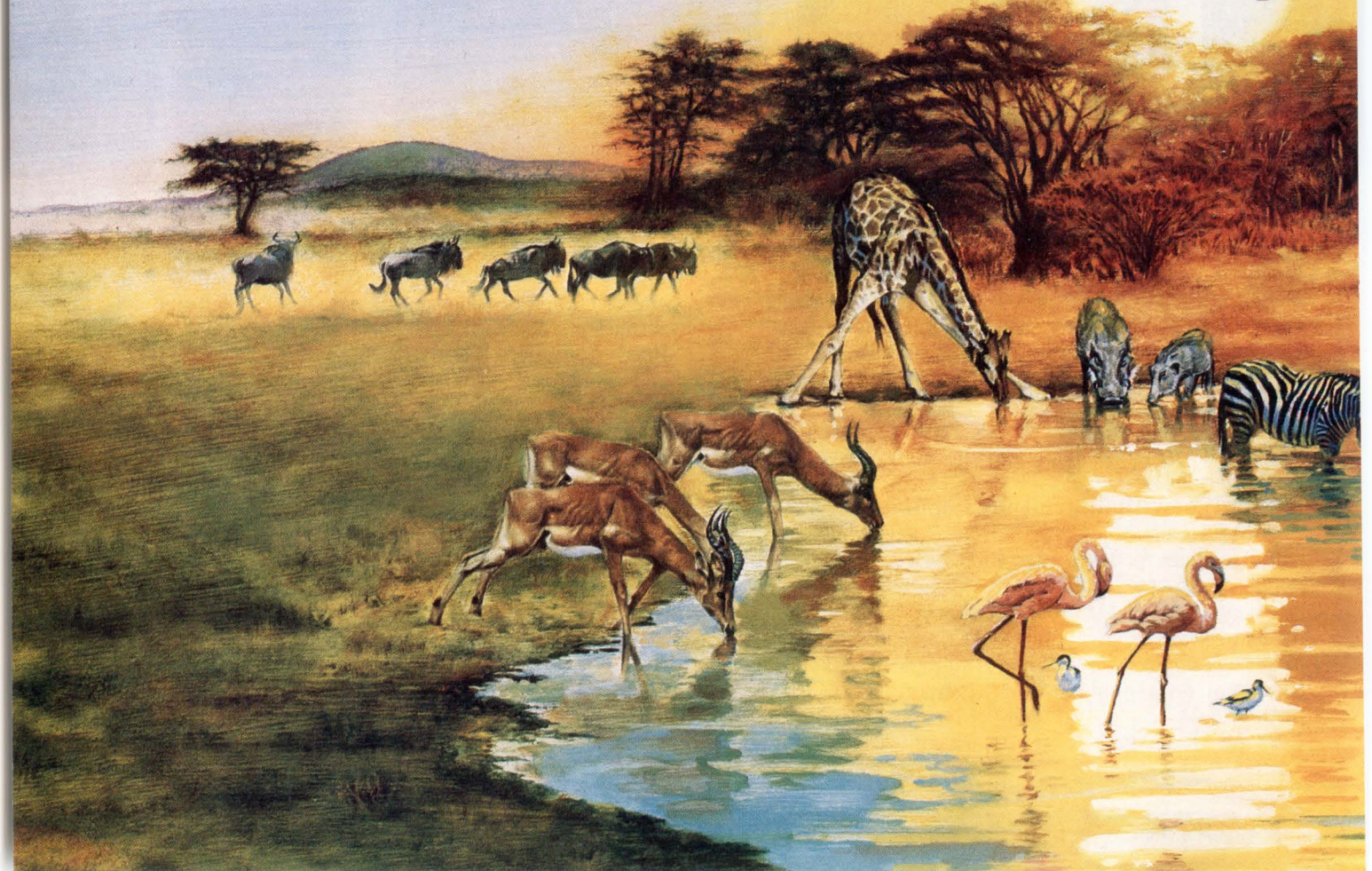

Our CMOS products include:

- HMCS400 Series 4-Bit Microcontrollers
- HD6301/6305 8-Bit Microcontrollers
- HD6303/6309 and HD64180 8-Bit Microprocessors
- HD68HC000 16-Bit Microprocessors
- 8/16-Bit Microprocessor Peripherals

Fantastic devices are only part of Hitachi's total CMOS solution. Hitachi's CMOS products also deliver unsurpassed quality and reliability. We have comprehensive hardware and software development support running on popular systems such as IBM-PC. The conclusion: You have a complete solution with Hitachi.*

Fast Action: To obtain product literature immediately, CALL TOLL FREE, 1-800-842-9000, Ext. 6809. Ask for literature number R16.

*IBM-PC is a registered trademark of International Business Machines Corporation.

Hitachi America, Ltd.
Semiconductor and IC Division
2210 O'Toole Avenue, San Jose, CA 95131
Telephone 1-408/435-8300

 **HITACHI**
We make things possible



LOW PROFILE/HIGH DENSITY SWITCHING POWER

Case 23

Up to 600 Watts
3"x5"x14.25"
Main Channel
Up to 80A
Auxiliary Mag
Amp Outputs



400 to 600 Watts from up to 7 fully regulated outputs in a package that's sized to fit your OEM requirements. With the standard features and options you are looking for: N+1 redundancy; EMI filtering to FCC 20780 Class A; Main channel pre-load; A ball bearing, brushless DC fan; DC input models. International safety approvals and field strappable ac input voltage to fit anywhere in the world. The Case 23 from Qualidyne—try it on for size.

THE SWITCHER FIT FOR YOUR NEEDS

Qualidyne

QUALIDYNE SYSTEMS, INC.

3055 Del Sol Boulevard, San Diego, CA 92154
(619) 575-1100 Telex: 709 029 FAX: 619 429-1011
(800) 445-0425 In Calif. (800) 237-6885

CIRCLE NO 31

8M BYTE MEMORY MODULE

TVME-220

The TVME-220 is a 8Mbyte memory board. Since the 32 bit address of VME bus is assigned to B pin lines and VSB (VME Subsystem Bus) is assigned to A, C pin lines, the board can be used for both VME and VSB System Buses.

MAIN FEATURES

- * TC511000P-12 is used for the memory.
- * Cas-Refor-Ras-Refresh method is employed as refresh.
- * Parity Checking.
- * The base address of VME bus can be set by 1 Mbyte unit.
- * The base address of VSB can be set by 1 Mbyte unit.
- * Inhibit function of VSB.
- * Memory inhibit (by 2 Mbyte) at accessing of VME bus.
- * Hi Speed Accessing Mode of VME bus.
- * Byte, Word and Long word Accessing.
- * It can be used in 4G memory area.
- * It can be used either in expanded address or standard address.

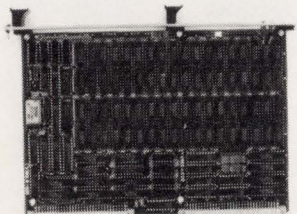

BLOCK DIAGRAM OF TVME-220

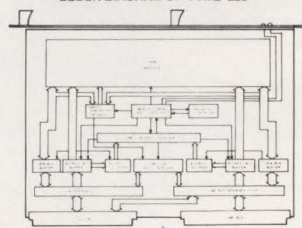

OUR COMPANY IS SEEKING A SALES REPRESENTATIVE

Phone toll free for
information & orders.
1-800-237-4590

TEL (408) 922-0133
FAX (408) 922-0137
TLX 902405802

CIRCLE NO 27

EPOTEK
CORPORATION

2151 O'Toole Ave., Suite L
O'Toole Business Center
San Jose, CA 95131

CALENDAR

International Computers in Engineering Conference and Exhibition, New York, NY. American Society of Mechanical Engineers, 345 E 47th St, New York, NY 10017. (212) 705-7795. August 9 to 13.

Modern Techniques in Digital Signal Processing and Analysis (short course), Santa Cruz, CA. University of California Extension, Santa Cruz, CA 95064. (408) 429-4535. August 10 to 12.

Intensive C Language Programming (short course), Santa Cruz, CA. University of California Extension, Santa Cruz, CA 95064. (408) 429-4535. August 10 to 13.

Advanced SMT Design Techniques (short course), San Jose, CA. Surface Mount Technology Plus, 2216 Lundy Ave, San Jose, CA 95134. (408) 943-0196. August 17 to 18.

Engineering and Manufacturing '87, Boston, MA. National Computer Graphics Association, 2722 Merrilee Dr, Suite 200, Fairfax, VA 22031. (703) 698-9600. August 17 to 20.

Designing Signal Processors with DSP and Bit-Slice Chips (short course), San Diego, CA. Integrated Computer Systems, Box 3614, Culver City, CA 90231. (800) 421-8166; in CA, (213) 417-8888. September 1 to 4.

Effective Skills for Technical Managers (short course), Washington, DC. Integrated Computer Systems, Box 3614, Culver City, CA 90231. (800) 421-8166; in CA, (213) 417-8888. September 1 to 4.

Modern Electronic Packaging, Seattle, WA. Technology Seminars, Box 487, Lutherville, MD 21093. (301) 269-4102. September 9 to 11.

Invitational Computer Conference Computer Graphics Series, Fort Lauderdale, FL. BJ Johnson & As-

POWER-ONE vs. POWER-ONE

... Our Only Competition.



We're Taking On The Champ!

So far, we've met every challenger, head on ... and nobody's gone the distance. So now we're taking on the undisputed D.C. Power Supply champ—POWER-ONE!

Sure... it would be easier to sit back and rest on our laurels, but that's not POWER-ONE's style. And never will be. For three straight years you've voted us *Buyers' Top Choice in OEM Power Supplies**, and we intend to make it four. That means continued unbeatable POWER-ONE quality, prices, service, and delivery. Most important, it means raising our already high standards to a whole new plateau in CUSTOMER SATISFACTION.

So while we welcome hard-hitting competition, we're not about to grow complacent waiting for it to come along. We're setting new goals for ourselves, developing new products, pushing our R&D efforts to the limit—all designed to save our customers money, time and worry.

In a word, we're getting tougher! And this isn't just a training session or

a few rounds of shadow boxing. This is an all-out battle between the reigning champ of today, POWER-ONE, and the new champ of tomorrow, POWER-ONE.

We guarantee the outcome will be a crowd pleaser.

For the Champ's new 1987 Catalog and capabilities brochure,

CALL OUR TOLL-FREE LITERATURE HOT-LINE:

(800) 235-5943, Ext. 113.
From California: **(800) 421-3439, Ext. 113.**

* Electronic Buyers' News, Annual Top 100 Component Suppliers Survey... 1984, 1985, 1986.



"Innovators in Power Supply Technology"
POWER-ONE
D.C. POWER SUPPLIES

POWER-ONE D.C. POWER SUPPLIES
740 Calle Plano • Camarillo, CA 93010-8583
Phone: (805) 987-8741 • (805) 987-3891
TWX: 910-336-1297 • FAX: (805) 388-0476



We never thought of ourselves as music makers. But we are now. Because we built the 286 CPU board and other components that allow Personics' amazing CD ROM jukebox to duplicate recordings for retail customers. And soon we'll be playing near you.

In fact, NCR's OEM PC-based technology is finding its way into a lot of places you might not think. Like medical imaging and diagnostic equipment. Environmental control systems. Robotics and manufacturing control systems of every description. And everywhere we go, NCR PC technology is proving itself an attractive alternative to other architectures.

That's because our PC technology is so versatile.

We put the RAM in the ram-a-lam-a ding-dong.

With an innovative approach to assembling the chips, boards and subsystems you need for your specific application. Without chewing up the calendar and your R&D budget in the process.

In short, we're easy to work with. From design to production to delivery. Because we have the engineering know-how and the manufacturing can-do to deliver the goods. Without hitches, without surprises, without fail.

So if you're looking into developing new products, or finding ways to improve your current ones, look into NCR. For more details about how NCR PC technology can fit into your plans, call us at (513) 445-0670.

And who knows, we could end up making beautiful music together.

CIRCLE NO 12

**A SMART FOUNDATION
TO BUILD ON.**



NCR Corporation
Personal Computer Division
OEM/Technology Sales
Dayton, Ohio
45479



CALENDAR

sociates, 3151 Airway Ave, #C-2, Costa Mesa, CA 92626. (714) 957-0171. September 10.

Integrated Manufacturing Solutions (IMS '87), Long Beach, CA. Intertec Communications, 2472 Eastman Ave, Bldg 33-34, Ventura, CA 93003. (805) 658-0933. September 14 to 18.

Hands-On Microprocessor Software, Hardware, and Interfacing (short course), Washington, DC. Integrated Computer Systems, Box 3614, Culver City, CA 90231. (800) 421-8166; in CA, (213) 417-8888. September 15 to 17.

PCB Expo, Minneapolis, MN. PMS Industries, 1790 Hembree Rd, Alpharetta, GA 30201. (404) 475-1818. September 15 to 17.

Effective Skills for Technical Managers (short course), Los Angeles, CA. Integrated Computer Systems, Box 3614, Culver City, CA 90231. (800) 421-8166; in CA, (213) 417-8888. September 15 to 18.

Designing Signal Processors with DSP and Bit-Slice Chips (short course), Boston, MA. Integrated Computer Systems, Box 3614, Culver City, CA 90231. (800) 421-8166; in CA, (213) 417-8888. September 22 to 25.

Hands-On Microprocessor Software, Hardware, and Interfacing (short course), San Diego, CA. Integrated Computer Systems, Box 3614, Culver City, CA 90231. (800) 421-8166; in CA, (213) 417-8888. September 22 to 25.

NEW
Programmable Pulse Discriminator



- Discriminates Against Programmed Pulse-Widths
- Digitally Programmable
- 3-BIT Address
- TTL Input & Output
- 24 Pin-DIP
- 1 NS to 50 NS Increment Steps
- Low Profile
- Stable & Precise
- Glitch & Noise Suppressor

data delay devices, inc.

385 Lakeview Avenue • Clifton, New Jersey 07011 • (201) 772-1106

CIRCLE NO 4

1 THERMAL SPEED CONTROL Thermally Automatic

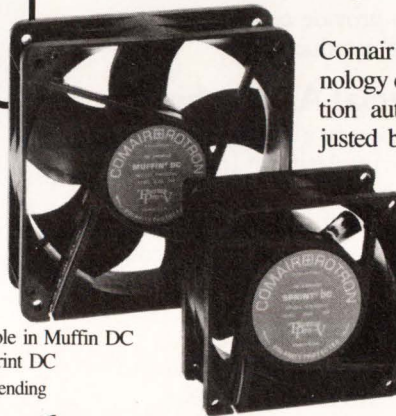

Available in Muffin DC and Sprint DC
Patent Pending

Comair Rotron's new ThernaPro-V technology controls internal temperature variation automatically. Motor Speed is adjusted by a temperature sensitive resistor allowing for continuous monitoring. With fan speed based upon temperature, motor can be downsized; passive heat dissipating units reduced and airflow programmed for extreme environments.

Comair Rotron. The automatic choice in brushless DC fans.

Therma Pro-V
FORCED CONVECTION COOLING TECHNOLOGY

For literature only call (800) 367-2662. In NYS and for product or technical assistance, call our Application Engineering Dept. at (914) 246-3615.

COMAIR ROTRON

a KLI company

Sawyer Industrial Park, Saugerties, NY 12477

Telephone: (914) 246-3615 TWX: 910-333-7572 Telex: 551496

CIRCLE NO 33

For workstations that thrive in a multivendor

HP's powerful family of technical workstations fits right in with your present computing resources, as well as those added in the future. With industry standard networking, operating systems, and languages. *Plus* hundreds of advanced application packages, and performance extras to give you the competitive edge in all of your engineering and technical activities.

Our solutions are implemented on one of the industry's largest technical computer and workstation families. It consists of the HP Technical Vectra PC, the HP 9000 series 200/300/500, and the new model 840 Precision Architecture Computer.

Full UNIX System V compatibility.

HP's technical workstations use AT&T's System V UNIX operating system with Berkeley 4.2 enhancements and HP improvements. The result is a standard tuned to the workstation environment with windowing, real-time I/O extensions, graphics, six languages and other extras.

The networking you need.

HP offers the networking to unify design, test, manufacturing, and technical office automation in your company. You'll have ARPA and Berkeley services and TCP/IP on Ethernet** and IEEE 802.3 to provide connectivity with IBM, DEC, and other vendors' products.

AI power without special AI machines.

You get everything you expect in a multipurpose workstation, plus the ability to run Artificial Intelligence on the same machine. Based on Common Lisp, it lets you harness AI power for accelerated software development. You can also get premier expert system tools from companies such as Intellicorp and Teknowledge.

Wide range of graphics solutions.

The choice is yours...from low-cost monochrome to high-resolution color monitors...from simple report



run UNIX* systems and environment, talk to HP.



graphics to 3D solids modeling. There are industry standards like GKS and ANSI Computer Graphics Virtual

Device Interface (CG-VDI), to protect your investment by making your existing software portable. HP's accelerated graphics solutions are highly modular, so you can upgrade whenever you choose.

Hundreds of application packages.

Specialized technical applications? No problem. HP's application packages include logic and analog CAE, PCB CAD, microprocessor software development, 2D design and drafting, 3D solids modeling and finite element analysis, documentation and report generation, and database management. New software packages are constantly being added for an even larger selection.

HP—protecting your investment.

Buying HP's solutions is not only a smart decision initially, but it provides the added benefit of lower cost of ownership that reflects our commitment to quality and service. For more information, call your local HP sales office listed in the telephone directory white pages.

Tap HP's DATA-LINE for complete facts...instantly!

For on-line information 24 hours a day, use your computer, modem, and HP's DATA-LINE. Dial 1-800-367-7646 (300 or 1200 baud, 7 bits even parity, 1 stop bit). In Colorado call 1-800-523-1724.

*UNIX is a trademark of AT&T.

**Ethernet is a trademark of Xerox Corporation.



**HEWLETT
PACKARD**

DS15603B

CIRCLE NO 65

A TOUGH ACT TO FOLLOW.

Q: A 60-foot rope is suspended between two poles, one 40 feet high, the other 30 feet high. An acrobat hangs from the rope. If the hanging point is 5 feet from the ground, how far apart are the poles? Note: picture is intentionally not to scale.



If you follow the test equipment business, you know the master at solving tricky problems is LTX. Our LTX77 has been the industry standard for some time. The Ninety is an even faster, more compact version of this versatile mixed-signal and consumer device tester. We recently introduced the highest throughput machine in linear testing: Hi.T. And, of course, there's Trillium.

If quick digital shipment and turn around schedules have you on the ropes, Trillium is the solution. In addition



THE LTX trillium

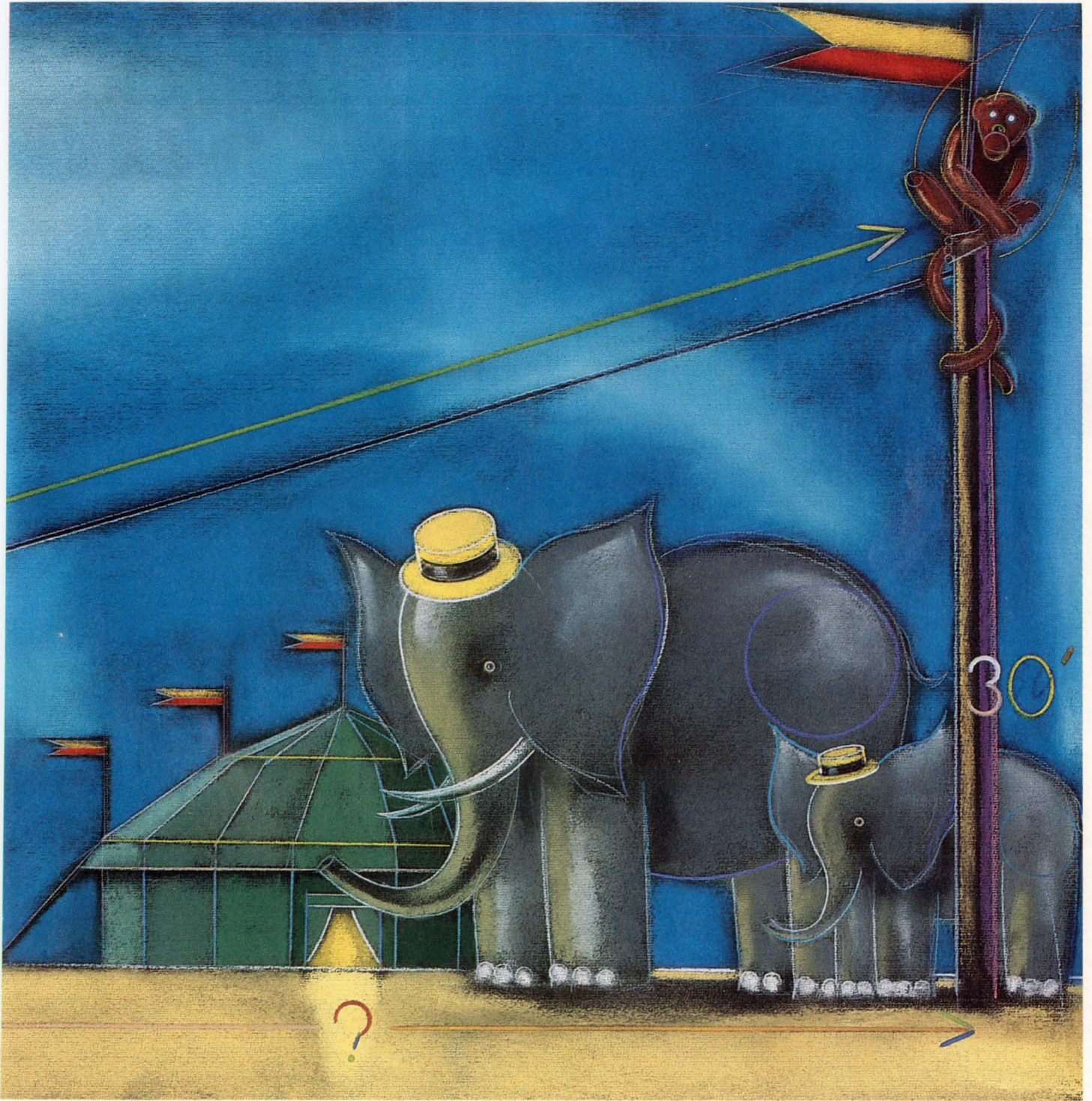

Michael A. Stueben, © Discover Magazine 1/87

to high throughput, Trillium's test-head design allows the fastest set up and change-over time in the industry. Trillium's powerful program generation and debug software (coupled with resource-per-pin architecture) is compatible with customer CAD test patterns and programs. It also facilitates fast, accurate and interactive device debug and verification.

If you want to get new CMOS and ECL products out the door faster than ever, Trillium is the answer. Call your nearest LTX sales office for more information and, if need be, for the answer to the brain tester above.



TEST YOUR LIMITS.

WE'LL BE AROUND FOR AND THE NEXT.

**Mepco/Centralab is investing
to keep you ahead of**

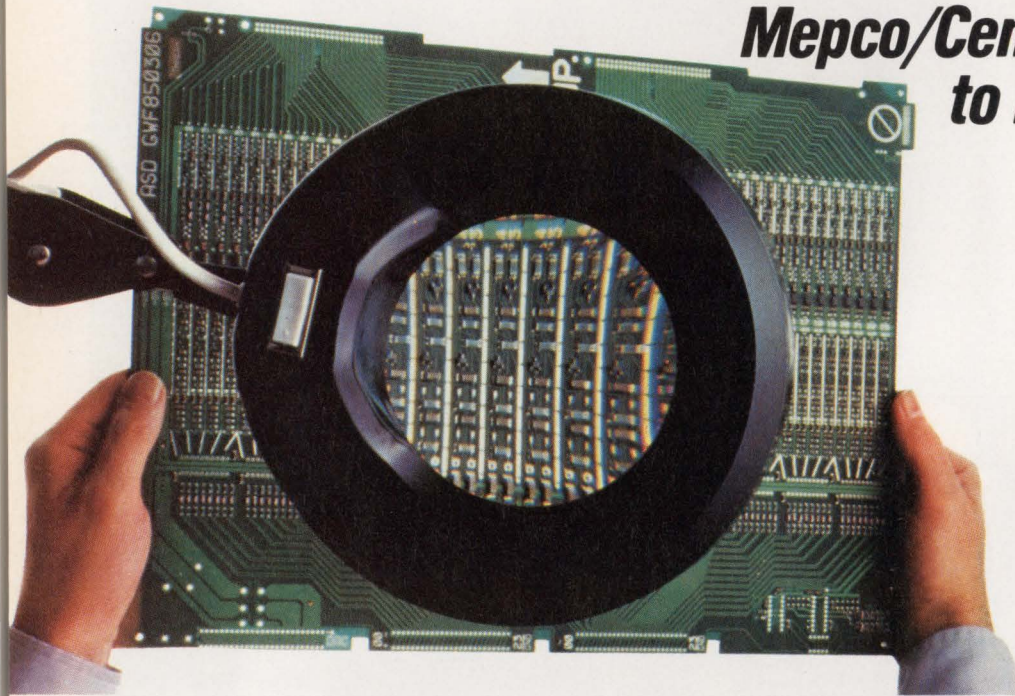

We know you face stiff competition with your next generation of products. We're actively working to help you stay in front.

Starting with substantial investments in research and development and in product, process and mechanization engineering, we have committed all of our resources to a single goal: to be the leading source for the advanced, reliable passive components you'll need in the months and years ahead.

Broadest line of passive components in the U.S.

Since we've combined the resources of Mepco/Electra and Centralab, we can meet your needs better than ever. We offer the broadest line of passives

in the industry. Both leaded and surface mount. And we're adding new components, new configurations and new packaging alternatives all the time.

For example, we challenge you to find a supplier that can match Mepco/Centralab's wide selection of capacitors. Ceramic Capacitors. Film Capacitors. Aluminum Electrolytic Capacitors. And Tantalum Capacitors.

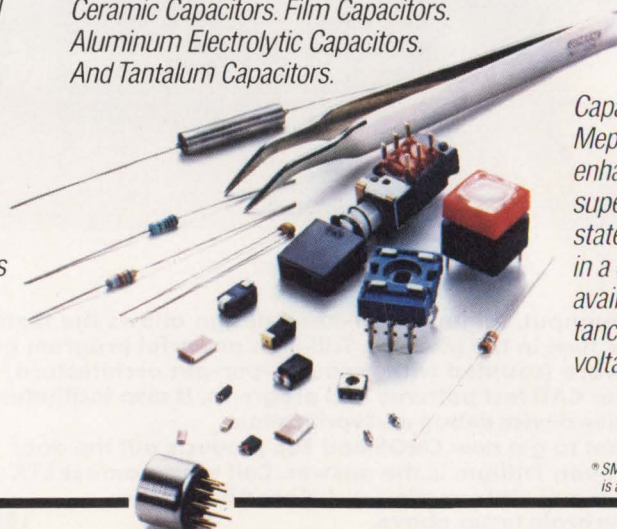

We also have a broad selection of resistors, including Thick Film Chip Resistors. Metal Film Resistors. Precision MELF Resistors. Nonlinear Resistors. And Trimming Potentiometers.

Our electromechanical line includes Rotary and Pushbutton Switches. Key-switches. Membrane Switches made to your precise specifications. And custom or standard Potentiometers.

Leading in SMDs®: selection, performance and reliability.

We can meet your growing needs for superior component performance in small sizes. We offer the largest selection of passive Surface Mount Devices (SMDs) in the industry, many with unique performance advantages. For example, our BLUE CHIP® Tantalum Capacitor has achieved worldwide recognition for reliability in many applications that demand outstanding electrical characteristics in a very small size.

Our SMD Ceramic Chip Capacitors are another example of how Mepco/Centralab can help you greatly enhance circuit board density with superior SMD components. They offer state-of-the-art volumetric efficiency in a capacitance device. And they're available in a wide selection of capacitance values, dielectric materials and voltage ratings.

® SMD is a service mark and BLUE CHIP is a registered trademark of North American Philips Corporation.

THE NEXT GENERATION. AND THE NEXT...

**\$20 million in passives
your competition.**

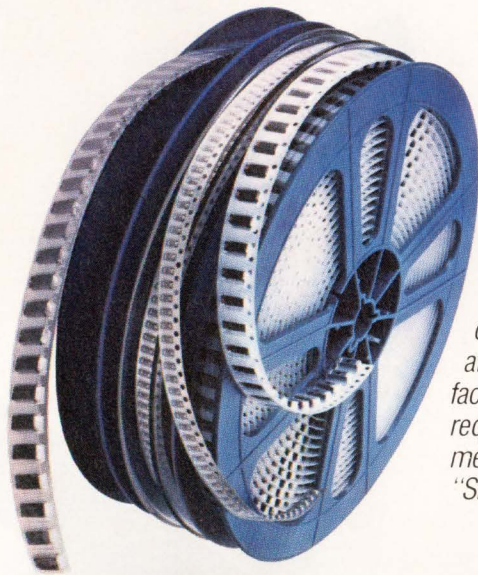

**We're backed by Philips—
a worldwide technology leader.**

We're a North American Philips company. As such, we share the resources and know-how of Philips—an established leader in surface mount technology and electronics research and development. We have the commitment, the financial strength and the stability to stay the active leader in passive components well into the future.

**At Mepco/Centralab, quality
is everyone's responsibility.**

Statistical Process Control is at work in all Mepco/Centralab manufacturing plants. Our online operators

are responsible for testing product quality at frequent intervals—at each critical step of every manufacturing operation.

Through the personal commitment to quality control that is shared by each of our employees, our most demanding customers can rely on Mepco/Centralab. Time after time. We're dedicated to manufacturing passives that meet your requirements, and we have implemented quality programs such as "Ship to Stock."

**Make us a part of your
next generation.**

We want to be your partner in passives. We're prepared to meet your toughest performance or selection criteria in order to prove our capabilities. We'll meet your volume requirements as well as your precise scheduling needs—including "Just in Time" delivery.

With Mepco/Centralab, you'll find the selection, reliability, availability and technical support you need. All from one dependable source. So beat the competition with your next generation of products. Team up with the active leader in passive components. We'll be around.

For more complete information on our product line, please send in the coupon. Or call us at (305) 881-3257.



Mepco/Centralab, Inc.
2001 W. Blue Heron Blvd.
Riviera Beach, FL 33404
Att: Corp. Advertising

EDN 080687

Yes, I want to stay ahead of my competition.

Please send me the following catalog(s):

- Surface Mount Device Catalog Electromechanical Product Catalog
 Leaded Resistor/Capacitor Data Book Please have a representative call.

Name _____ Title _____

Company _____ Dept. _____

Address _____ City _____

State _____ Zip _____ Phone () _____

MEPCO/CENTRALAB
A NORTH AMERICAN PHILIPS COMPANY

THE ACTIVE LEADER IN PASSIVE COMPONENTS

Faster!

CMOS at speed.

A few more fast, fast reasons to call for our new databook:

1. New 64K SRAM. 25ns. Seven configurations—including bit-wide, nibble-wide, byte-wide, separate I/O, and all with low, low, power. As low as 50 mA active at 45ns.

2. New 128K Reprogrammable PROM. 45 ns. 100 mA active, 30 mA standby.

3. New 64 x 9 and 64 x 8 FIFOs. 35 MHz. Virtually no bubble through. Cascadeable.

4. Fastest 22V10 Reprogrammable PLD. 25ns. 55 mA. And we have the board to turn your PC into a PLD/PROM programmer, too!

5. High speed CMOS SRAM.

6. High speed CMOS PROM.

7. High speed CMOS PLD.

8. High speed CMOS LOGIC.

9. Fabricated and assembled in our DESC-certified U.S.A. facilities.

This databook, packed with high speed, low power parts, is yours for a phone call.

DATABOOK HOTLINE:

1-800-952-6300, Ask for Dept. CD2

1-800-423-4440 (In CA), Ask for Dept. CD2

(32) 2-672-2220 (In Europe)

(416) 475-3922 (In Canada)

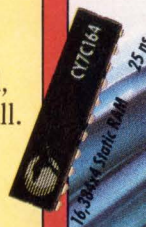
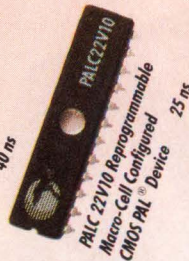
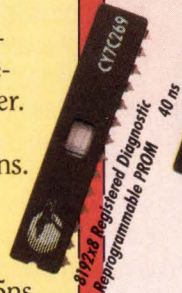

CYPRESS SEMICONDUCTOR

Cypress Semiconductor, 3901 North First Street, San Jose, CA 95134.
Phone (408) 943-2666 Telex 821032 CYPRESS SNJ UD, TWX 910-997-0753.
PAL is a registered trademark of Monolithic Memories, Inc.
©1987 Cypress Semiconductor

We illustrate the Lockheed SR-71 Reconnaissance aircraft, holder of the world's air speed record: 2,193 miles per hour. We're fond of speed records. Over 30 of our parts have broken or still hold speed records for integrated circuits.

EDITORIAL

Expect the unexpected



Some time ago I noticed a slogan that someone had carefully painted on the sidewalk: "Expect a miracle." Well, it seems that miracles are few and far between. Although I hoped for one, no amount of expectation reduced my load of day-to-day work, nor did it lead to any great inspirations. The slogan reminds me of a cartoon I saw some time ago. Two researchers are looking at complex equations on a blackboard. Right in the middle there's the legend "... and then a miracle occurs."

Perhaps the phrases should have been "Expect the unexpected," and "... and then the unexpected occurs." For example, during the spring, my son's class was scheduled to take a field trip to one of Boston Harbor's many islands. Because other kids in his class were grumbling about the trip, he knew ahead of time that he'd hate the experience. So, at many dinners prior to the trip, we heard about how it was going to be "stupid" and "dumb." It turns out that he thoroughly enjoyed the visit and wants the whole family to go back with him during the summer.

I've wasted a lot of my own time worrying about how boring and "stupid" a meeting or trip was going to be only to find that, for the most part, it was interesting and informative. Even if the event turned out to be less useful than I had hoped, I usually found something positive that I hadn't expected. I tend to be a pessimist at heart, but I'm trying to change my attitude. My recent experiences confirm that optimists have more fun.

I'm not a complete optimist yet, because the unexpected has its negative side, too. For example, in early June, a bolt of lightning accidentally set off three rockets at NASA's Wallops Island, VA, facility. The rockets had their igniters in place and were awaiting launch. By a twist of fate, one of the rockets had been intended to help scientists study the effects of lightning on the ionosphere. Unfortunately, that rocket was set at a low angle, and it blasted into a body of water several hundred feet away. The other two rockets flew perfectly, but no one was set up to track them.

Jon Titus
Editor



THIS IS WHAT OUR NEW SRA

| VLSI Part No. | Organization | Functions | Access Times |
|---------------|--------------|--------------------|--------------|
| VT7C122 | 256 x 4 | Separate I/O | 15 ns |
| VT20C18 | 2K x 8 | APD; 10 ns OE | 20 ns |
| VT20C19 | 2K x 8 | 12 ns CE; 10 ns OE | 20 ns |
| VT20C50 | 1K x 4 | Separate I/O; FC | 15 ns |
| VT20C68 | 4K x 4 | APD | 20 ns |
| VT20C69 | 4K x 4 | 12 ns CS | 20 ns |
| VT20C71 | 4K x 4 | Separate I/O; OT | 20 ns |
| VT20C72 | 4K x 4 | Separate I/O; HZ | 20 ns |
| VT20C78 | 4K x 4 | APD; 10 ns OE | 20 ns |
| VT20C79 | 4K x 4 | 12 ns CS; 10 ns OE | 20 ns |
| VT20C98* | 8K x 8 | APD | 25 ns |
| VT20C99* | 8K x 8 | Fast CE | 25 ns |
| VT62KS4* | 16K x 4 | 15 ns CS | 25 ns |
| VT63KS4* | 16K x 4 | 15 ns CS; OE | 25 ns |
| VT64KS4* | 16K x 4 | APD | 25 ns |
| VT65KS4* | 16K x 4 | APD; OE | 25 ns |

APD=Auto Power Down; CE=Chip Enable; OE=Output Enable; CS=Chip Select; FC=Flash Clear; OT=Outputs Track Inputs During Write; HZ=High-Impedance Outputs During Write *Samples Available 4th Quarter, 1987.

So long, Cypress. Sayonara, Toshiba. That goes for you, too, IDT. And Motorola. And all you other CMOS SRAM makers.

Now VLSI has some of the fastest CMOS SRAMs around.

We're not talking about just one part here. And one part there.

But a whole family of SRAMs that blow the doors off anything from the competition.

Our SRAMs make it easy to



MS DO TO THE COMPETITION.

boost performance in your existing designs because each and every one is pin-compatible with industry-standard chips.

And we're developing tools to make them available for ASIC designs.

So phone VLSI Technology at 800-8-SAMPLE for more information and samples. Or write to us at 1109 McKay Dr., San Jose, CA 95131.

And see how you can blow the doors off your competition.

For a free poster of this ad call 800-8-SAMPLE.



VLSI TECHNOLOGY, INC.

High-resolution conversion

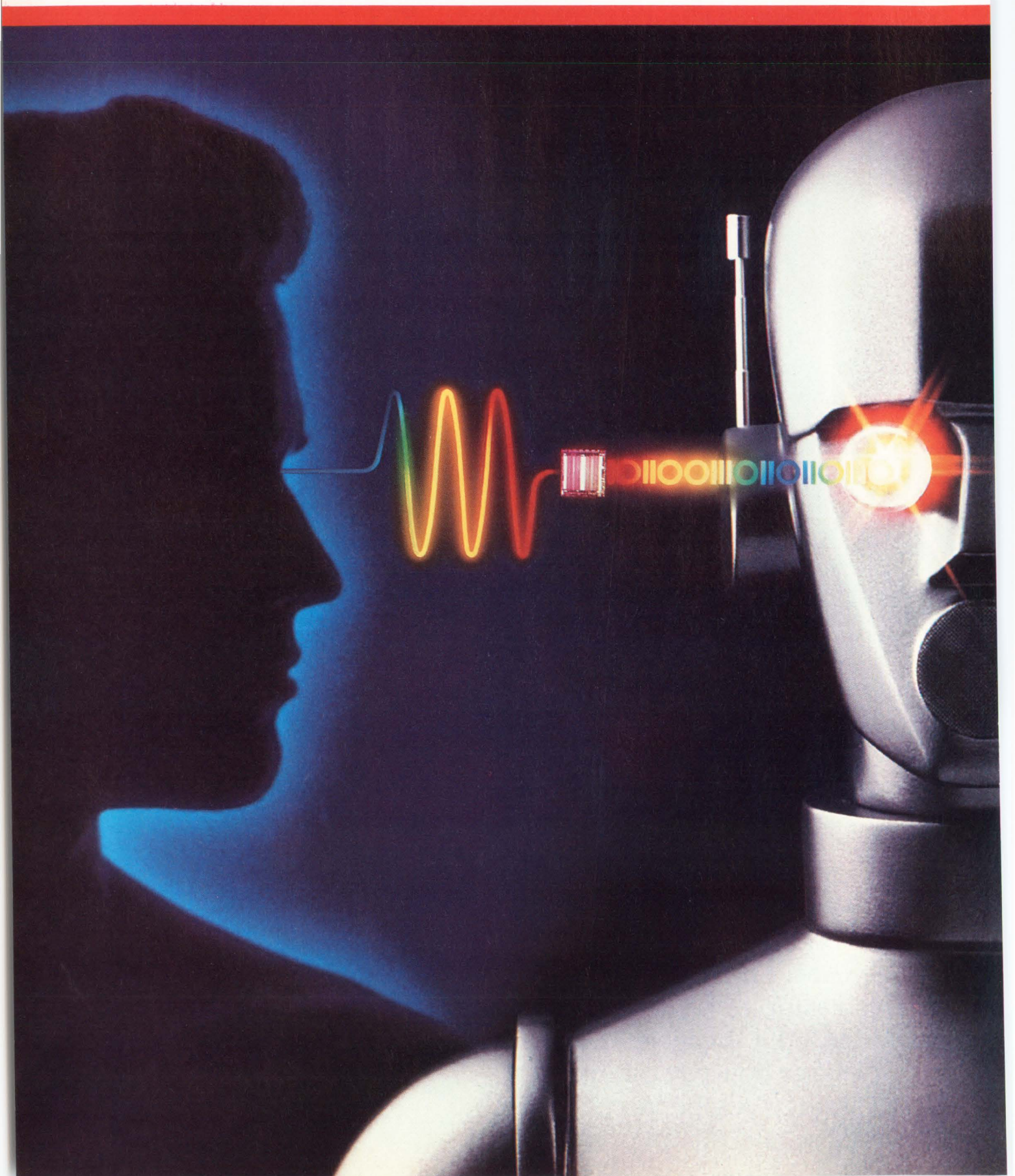

in the blink of an eye.

Get video speed, low power consumption, high resolution and superior price/performance with our new CMOS data converters.



4-bit

We've expanded our line to include more CMOS flash ADC's, a charge balancing ADC, an SPI ADC and a DAC. All featuring single 5V supply operation.

We also offer a new high-speed op amp especially well-suited to driving ADC's or video cables.

4, 6 and 8-bit CMOS flash ADC's.

Choose from 4, 6 and 8-bit ADC's. All operate at video speeds, with clocking speed and input bandwidth specified at 5V. What makes these flash ADC's special is silicon-on-sapphire construction, resulting in low cost, high speed, very low input capacitance, low power consumption and inherent latch-up resistance.

10-bit CMOS charge balancing ADC.

This 10-bit successive approximation ADC captures fast moving signals, providing excellent resolution.

It features a built-in fast track and hold, with conversion rates of 150 KHz and an input bandwidth of 1.5 MHz. Even at the maximum rate, power consumption is less than 20 mW.

10-bit CMOS serial ADC.

The CDPHC68A2 is selectable for either 8- or 10-bit resolution and has an 8-channel multiplexer allowing up to 8 channels of inputs. The device can be used directly with our CDP68HC05C4, C8 or D2 microprocessors or other similar SPI (Serial Peripheral Interface) buses.

8-bit CMOS R-2R video-speed DAC's.

These CMOS/SOS digital-to-analog converters operate

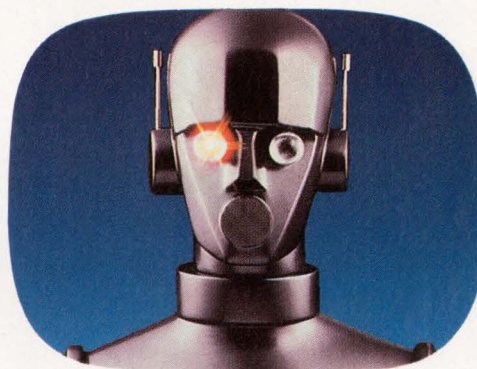

8-bit

from a single 5V supply at video speeds and can produce "rail-to-rail" output swings.

Typical update rate is 50 MHz. Settling is fast (20 ns typical) to 1/2 LSB. "Glitch" energy is minimized by segmenting and bar graph decoding of upper 3 bits.

High-speed op amp.

Specially designed for use with data converters, the CA3450 op amp has excellent speed and transmission line driving capabilities.

For 10-bit accuracy, it settles to within 1/2 LSB in 40 ns with a 2V input signal. And it can drive up to four 50 ohm transmission lines.

| ADC's | Res. Bits | Conv. Rate Hz | Power Diss. (mW) | Pkg. Leads | 1K Price |
|----------------|----------------|------------------------|---------------------------|------------------|-----------------|
| CA3304E | 4 | 20M | 30 | 16 | 2.95 |
| CA3304AE | 4 | 25M | 35 | 16 | 4.50 |
| CA3306CE | 6 | 10M | 65 | 18 | 5.50 |
| CA3306E/3306AE | 6 | 15M | 70 | 18 | 6.25/11.25 |
| CA3318E/3318CE | 8 | 15M | 150 | 24 | 38.50/24.00 |
| CA3310E/3310AE | 10 | 150K | 15 | 24 | 6.00/8.00 |
| CDP68HC68A2E | 10 | 10K | 15 | 16 | 3.75 |
| DAC's | | | | | |
| CA3338E/3338AE | 8 | 50M | 100 | 16 | 6.00/8.40 |
| OP AMP | | | | | |
| | UGBW Hz | Slew Rate (X10) | I_{out} MA | Pkg Leads | 1K Price |
| CA3450E | 200M | 300V/μSec | ±75 | 16 | 2.70 |

Data in a flash.

For data sheets of these new products, call toll-free 800-443-7364, extension 19. Or contact your local GE/RCA sales office or distributor.

In Europe, call: Brussels, (2) 246-21-11; Paris, (1) 39-46-57-99; London, 0276-685911; Milano, (2) 82-291; Munich, (89) 63813-0.

GE/RCA/INTERSIL Semiconductors





Our ASIC Program targets all your design needs.

**In gate arrays, standard cells
or Compiled Cell Custom, you'll
always score with S-MOS.**

Complete design tools.

S-MOS SYSTEMS supports a large and growing number of workstations, including Daisy, Mentor, Calma and PC-based systems using FutureNet, Orcad and Viewlogic. Our proprietary LADS simulator is one of the fastest in the world,

and our engineering support will keep you ahead of the competition.

Advanced manufacturing.

Our manufacturing affiliate, Seiko Epson, is one of the world's most advanced CMOS IC manufacturers, with 18 years of CMOS experience.

At our highly automated Class 10 facility in Japan, Seiko Epson can produce 40,000 4" wafers, 20,000 5" wafers and 20,000 6" wafers. Each month.

That's a total equivalent of about 23 million units a month.

High quality and total reliability.

With a product reject rate of less than .0001%, S-MOS and Seiko Epson deliver the ASICs you can depend on.

For a fully integrated ASIC program, call us. (408) 922-0200.

**S-MOS SYSTEMS
2460 North First Street
San Jose, CA 95131-1002**

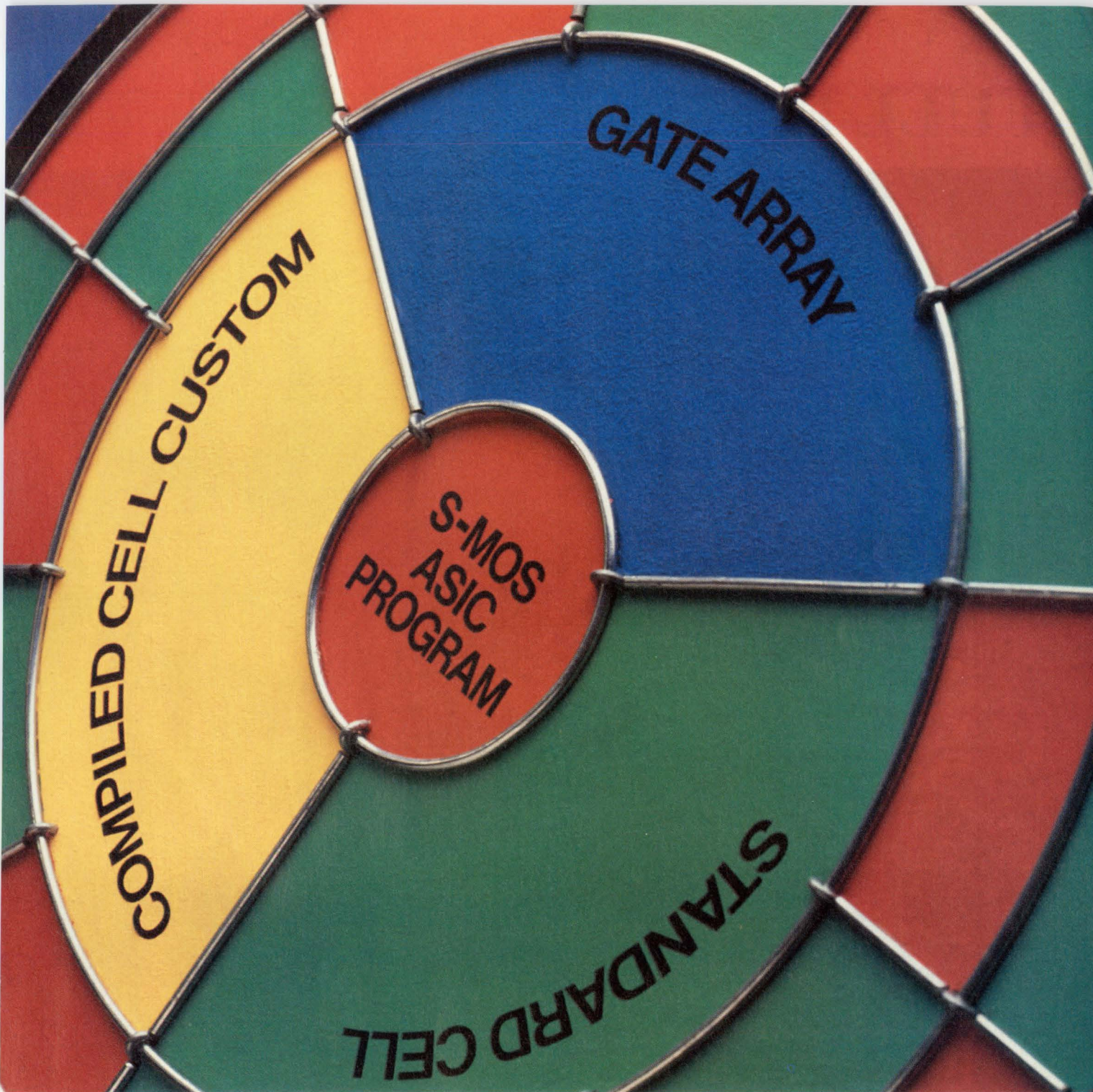

| CMOS Gate Arrays | CMOS Standard Cells | Compiled Cell Custom |
|--|---|---|
| Complexities to 16K gates • SLA8000 (500ps)* 1.2 μ drawn, 0.95 μ Leff • SLA7000 (640ps)* 1.5 μ drawn, 1.2 μ Leff • SLA6000 (1.3ns)* 2.0 μ drawn, 1.7 μ Leff • SLA5000 (2.2ns)* 3.0 μ drawn, 2.3 μ Leff | Complexities to 16K gates • SSC1000 (720ps)* 1.8 μ drawn, 1.5 μ Leff • Fully migratable from S-MOS gate arrays • RAM and ROM blocks available | <i>The Alternative to Full Custom</i> • 1.5 μ CMOS Process • Can utilize dissimilar cell geometries • 3-button approach to custom design • Currently over 300 fully characterized cells • Fast 14-week implementation time • Timing-driven TANCELL* Place-and-Route Software |

*Typical propagation delay of 2-input NAND gate driving 1 internal load including 100 μ interconnect.

*TANCELL is a registered trademark of Tangent Systems.

S MOS
SYSTEMS
A Seiko Epson Venture

FULL HOUSE.

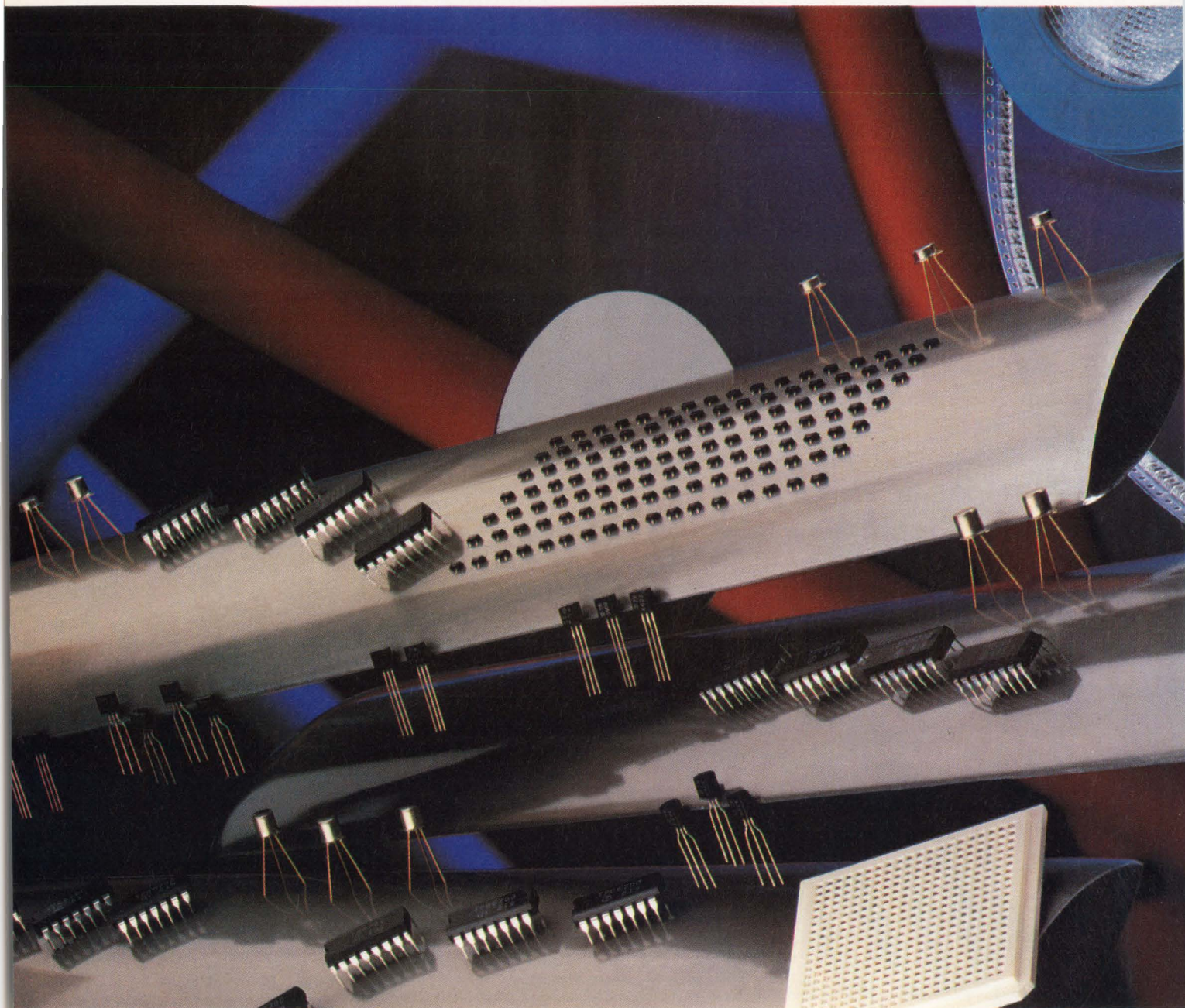

45S-6118R3

SPRAGUE IS THE ONE-STOP SEMI SHOP. Sprague is your source for discrete semiconductors: For bipolar or junction field-effect transistors, for Darlingtons, diodes, Zeners, MOS capacitors, transistor and diode arrays. In TO-92, SOT 23, 14- and 16-pin DIPs, metal cans, and as chips and wafers. Fully tested to meet your specs. Packaged to meet your needs, including standard tape and reel formats. For the best in service, come to us. *Sprague Electric Company, Lexington, MA.* For our Catalogs CN-164 and CN-185, write to Technical Literature Service, Sprague Electric Company, P.O. Box 9102, Mansfield, MA 02048-9102. For applications assistance, contact our Customer Service Center in Concord, NH at 603/224-1961.

 **SPRAGUE**
THE MARK OF RELIABILITY

CIRCLE NO 59

TECHNOLOGY UPDATE

Advanced engineering calculators perform sophisticated operations

Charles H Small,
Associate Editor

A recent survey by a calculator manufacturer revealed that design engineers have, on the average, five scientific calculators apiece. Even though the market for new calculators would seem to be more than saturated, all the major scientific-calculator makers are betting that engineers will add a sixth, top-of-the-line calculator to their flocks.

Casio, Hewlett-Packard, Sharp, and Texas Instruments have all recently introduced powerful scientific calculators with a host of intriguing new functions, features, and capabilities.

You can take for granted that these advanced, programmable calculators come with a full complement of scientific and engineering functions, including hyperbolic functions; single- and dual-variable statistical analysis; Boolean operations in binary, octal, and hexadecimal number bases; and conversion functions for both complex numbers and common English and metric units. These calculators have also benefited from general advancements in electronics—they now sport informative, eye-pleasing LCDs and low-power, CMOS circuitry.

You might well wonder, however, why you'd want to purchase one of these advanced models when you can get a perfectly serviceable, basic scientific calculator for less than \$30, and when virtually every engineer has access to a personal or mainframe computer.

The answer is threefold. First, and quite simply, even though we are well into the computer age, the handheld calculator is still the engineer's primary, interactive, prob-

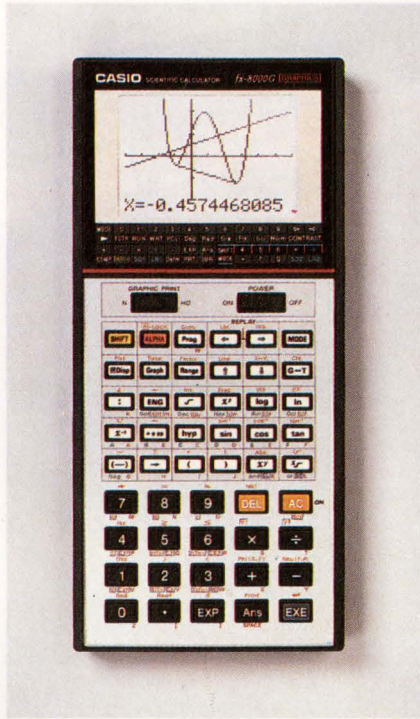

The \$109.95 fx-8000G from Casio has the largest LCD of any scientific calculator. The LCD can show long, complex command strings as well as graphs of functions.

lem-solving tool. Second, the new advanced calculators provide important functions that basic calculators do not. Third, advanced calculators are becoming more and more computerlike in the way they operate and hence are not likely to be made obsolete by computers.

Computerlike calculators

The new, advanced calculators can perform sophisticated operations such as random-number generation, complex arithmetic, matrix mathematics, integration, and differentiation. The Hewlett-Packard HP-28C (\$235) can even do symbolic math; it can rearrange, simplify, and solve equations for any variable and even do calculus.

Depending on the model, some

advanced scientific calculators have the following computerlike features: high-level-language programmability, multiline displays, menus, typewriter-style (qwerty) keyboards, built-in subroutine libraries, graphics capability, off-line storage of programs, and printer and plotter interfaces.

One thing these calculators don't have that their less-complicated brethren do is shirt-pocket portability. With the exception of the 5 $\frac{1}{16}$ -in.-tall Sharp Model EL-5200 (\$109.95), none of the advanced scientific calculators in this article will fit into a typical shirt pocket without peeking over the top. Some, such as the Hewlett-Packard and Texas Instruments calculators, will not fit into a shirt pocket at all; perhaps they're best termed "suit-pocket portable."

Neither are these calculators in the same class as so-called handheld computers. Not long after the introduction of the scientific calculator, calculator makers also introduced calculator-size, handheld computers. These small computers differed from calculators in two ways: They lacked the calculators' built-in scientific functions, and you programmed them in an interpreted language such as Forth or Basic.

At first, the handheld computers were just a curiosity for the computer hobbyist and were not capable of much useful computing work. But one handheld, the Panasonic HHC, came with a Forth cross-development system. Armed with this system, OEM users wrote custom programs and hammered out a niche market for handheld computers as point-of-sale aids. For example, insurance and real-estate salesmen could use a handheld computer run-



Introducing touch-sensitive computer power for the price sensitive.

The Casio PB-1000 hand-held computer. Don't let its size fool you. When it comes to power, the PB-1000 is a real handful—with 8K bytes, in fact, which can be easily expanded to 40K, with an optional RAM pack.

Besides impressive power for its small size, the PB-1000 has an LCD large enough for 32 columns of 4 lines of data. And the screen is touch-sensitive, so you can step through programs and data with the touch of a finger. To that you can add, as a low cost option, a 3.5" floppy disk drive that includes both an RS-232C and

printer port. All this has made the PB-1000 the computer of choice for many different professionals.

Business and salespeople, bankers, insurance and real estate brokers, construction engineers, auto dealerships and other small, inventory intensive businesses—they've all found the PB-



1000 to be useful for expanding productivity both in the office and in the field. And new applications are being discovered daily.

Let Casio or our VAR network show you how it can be custom-structured with the appropriate hardware and software to suit your requirements exactly. The PB-1000 starts at less than \$200. So you can make the most of its handful of power, without having to reach deep into your pockets.

CASIO
Where miracles never cease

TECHNOLOGY UPDATE

ning a custom program to figure rates and payments.

Handheld computers have evolved in parallel with scientific calculators. For example, Panasonic's latest model, the FH-2000, approaches the capabilities of a laptop computer and has a CMOS 8088 μ P, 128k bytes of RAM and 512k bytes of ROM, and an 8-line \times 80-character LCD. With some changes to the source code, the unit can run programs written for the IBM PC. Despite their advancements, handheld computers remain devices that an engineer would design *in* rather than design *with*.

Basic-language programming

But advanced scientific calculators are incorporating one key feature of the handheld computers: Some now employ Basic-language programming rather than keystroke programming. The first programmable scientific calculators were keystroke programmable; that is, they had a memory that you could load with exactly the same series of keystrokes you'd use to evaluate a mathematical formula manually.

For a function that requires only one pass through the program—or series of keystrokes—keystroke programming is very straightforward because of its one-to-one correspondence with manual execution. But when a program requires decision-making branches and repeating loops, keystroke programming becomes less user friendly because of the quirky, arcane nature of the decision-making and looping constructs of the keystroke-programmable calculators.

Further, verifying a program after you had entered it into the older calculators was a tiresome, error-prone task because the machines' 7-segment numeric LED displays could not spell out the keys' mnemonics. Instead of mnemonics, the calculators would regurgitate encoded check digits.

Now, one trend in advanced scientific calculators is to meld stand-



A powerful Zoom key for manipulating graphs is one feature of the \$109.95 Sharp EL-5200. Other graphical calculators require you to call up and alter the Range menu for scale changes.

ard Basic programming constructs with the keystroke scientific functions. With these hybrid calculators, you can evaluate mathematical functions manually in the normal calculator fashion. Programming the calculators, however, doesn't mean you'll have to learn a new style of programming; you'll be able to use the Basic-programming skills you already have. As a plus, the flow of your programs will be somewhat easier for others to follow (and, for that matter, easier for you to follow when you try to regain understanding of a program you wrote in the past). Keystroke programming is hanging on in the US but has fallen into disfavor elsewhere in the world.

Whether they are keystroke or Basic programmable, virtually all new, advanced scientific calculators sport some form of alphabetic-character entry for naming programs and variables. Some have the alphabetic characters laid out in the standard qwerty format. Others have them in a less handy but more compact rectangular array in alphabetical order. Still others allow you to enter alphabetic characters as shifted, or second, functions. This last scheme results in the most com-

pact keyboards but proves the least handy to use.

However, the issue of handiness is somewhat moot for punching text strings into a calculator. Although one model, the Casio fx-8000G (\$109.95), can store text files, no one will ever be foolish enough to use a calculator for word processing. And, following a trend started by the Sinclair personal computer (which had a miserable, hard-to-use membrane keyboard), all programmable calculators provide one-stroke keys for common programming constructs and scientific-function calls. Therefore, you don't have to do as much typing to enter a program into a calculator as you would if you were entering your program into a file for compilation or interpretation on a computer.

The longest string of alphabetic characters you would typically enter would be a program's title. The next longest strings would be variable names. In either case, the ease of use of the various keyboards would probably not have a significant effect on the total time you would spend writing, entering, and debugging a program.

In addition to having alphabetic

TECHNOLOGY UPDATE

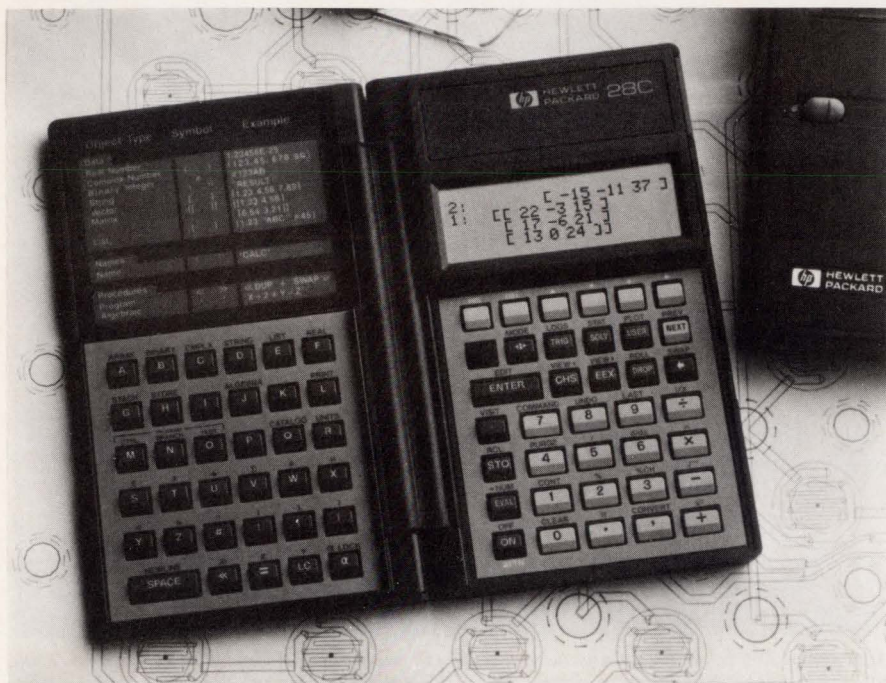

To help you access its more than 250 built-in functions, the \$235 Hewlett-Packard HP-28C provides an extensive series of menus.

keys, advanced scientific calculators are becoming more computerlike in other ways. Take, for example, the Casio Model fx-850P (\$149.95). This calculator is laid out in a horizontal format with a numeric keypad and scientific keys occupying the rightmost third of the calculator. On the left is a miniature qwerty keyboard; the shifted functions of the qwerty keyboard include common Basic keywords. Thus, the fx-850P is indeed a hybrid of the scientific calculator and the handheld Basic computer.

Calculator has 1M-byte ROM

Basic programming isn't this calculator's only computerlike feature. Remarkably, the fx-850P comes with a huge (1M-byte) internal ROM that stores 116 scientific programs. You can use these programs just as you'd use the scientific-subroutine libraries of mainframe computers.

Similarly, the Texas Instruments Model TI-74 Basicalc (\$135) has a qwerty keyboard and shifted functions for Basic keywords and scientific functions. However, when you press the Mode key, the alphabetical keys become scientific-calculator

keys. Thus you have your choice, in one unit, of a handheld Basic computer with scientific functions or a conventional scientific calculator.

In addition to picking up the keyboards and programming languages of computers, calculators are also getting more computerlike displays. The Sharp Model EL-5150 (\$79.95) is a new, low-cost entrant in the firm's line of programmable calculators. It sacrifices the qwerty layout and Basic keywords for a larger display than that of its cousins, Models EL-5500III and EL-5520. Just like a computer's graphics terminal, the calculator displays equations in algebraic form with true superscripts for powers and standard mathematical symbols (HP and TI calculators still use Fortran-like conventions for mathematical symbols). The Casio fx-8000G prints the characters A through F in one typeface when you use them in names and another typeface when they signify hex numbers.

Advancements in calculator displays don't stop with mere mathematical symbols and Greek letters. Three new calculators, the Casio Model fx-8000G (\$109.95), the

Hewlett-Packard HP-28C (\$235), and the Sharp Model EL-5200 (\$109.95) feature large, multiline LCDs having graphics capabilities. The fx-8000G (like the company's earlier \$79.95 fx-7000G) offers 16 characters×8 lines or 96×64 pixels. The HP-28C has 23 characters×4 lines or 137×32 pixels. The EL-5200 shows 16 digits×4 lines or 96×32 pixels.

These dot-addressable LCDs offer two capabilities that you formerly could get only from a computer. First, they let you draw a graph of any function you can key in. The calculators have functions for plotting points, for drawing straight lines, and for graphing several functions and determining their intersections. Further, the Sharp EL-5200 has dedicated keys for scrolling and zooming the display. You can invoke these keys manually or in a program. (To change the scale of Casio's and HP's displays, other than by a fixed multiplier or factors of two, you must call up and alter the Range menu and then rerun the graphing routine.)

Only time will tell whether or not the ability to quickly view a graph of a function is really a valuable tool for engineers or is just a gimmick. With the notable exception of software engineers, most engineers employ a wide variety of visual design aids such as pole-zero plots and Smith charts. These aids allow an engineer to go back and forth between the analytical realm and the real world. Perhaps engineers find such tools useful because, as brain research indicates, the creative half of the brain thinks in visual terms while the analytical half works syntactically.

Thus, perhaps the ability to jump from the inherently syntactical, analytical world of the calculator, with its precisely ordered strings of commands, into the visual domain of graphed functions will prove to be a surprisingly powerful aid to an engineer's creativity.

The other benefit conferred by

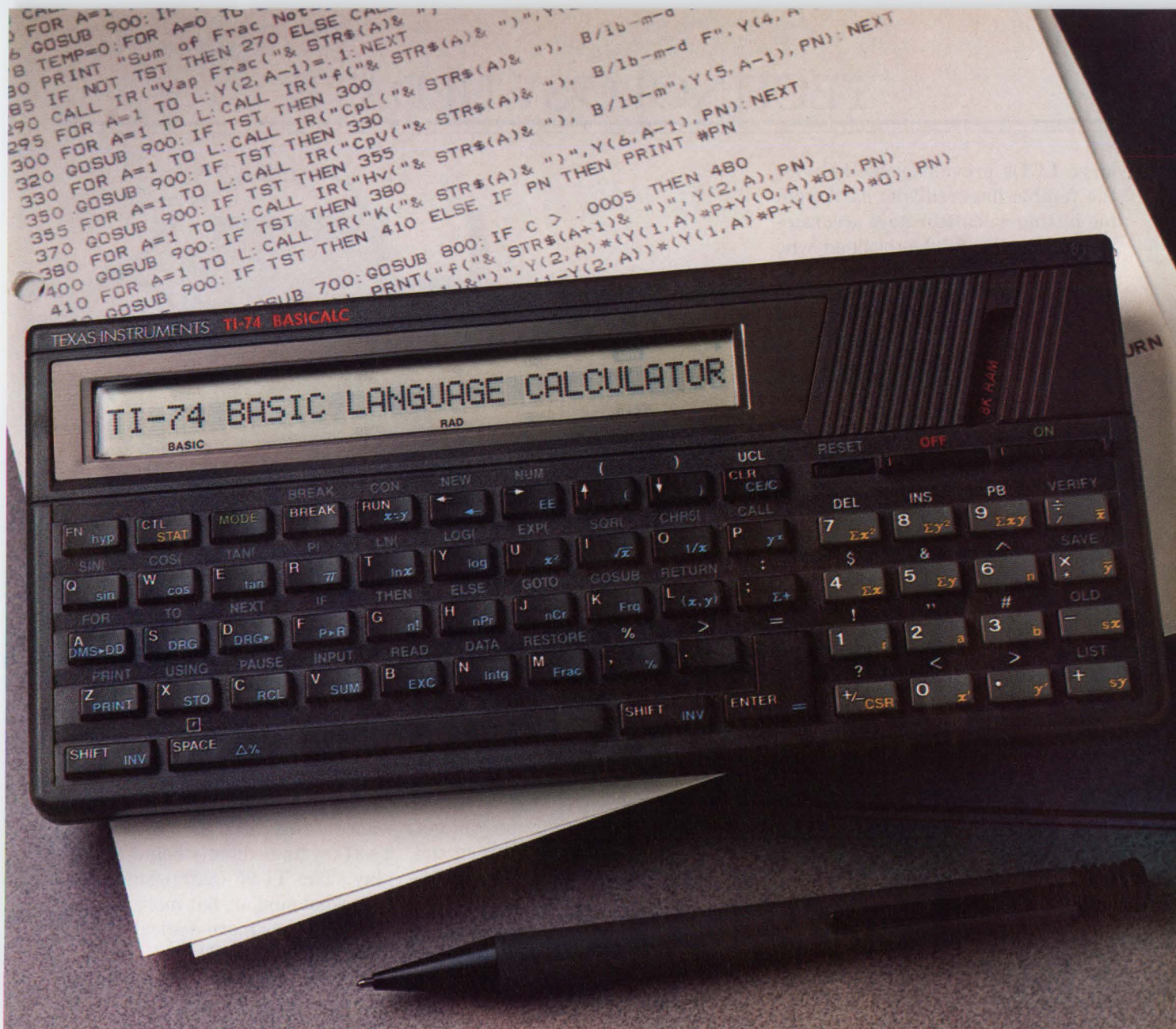

Basic spoken here.

The TI-74 BASICALC™
The advanced scientific calculator you can program in BASIC.

Every engineer should check it out. Because when you talk programs, you probably speak BASIC. And this powerful TI programmable understands your language.

The TI-74 BASICALC from Texas Instruments knows 113 BASIC keywords: From ABS to VERIFY.

You'll enjoy fast, straightforward

entry of the programs you use constantly on your job. And BASICALC keeps them always handy in its Constant Memory™ 8K internal RAM or optional 8K plug-in cartridges.

You'll zip through everyday calculations using BASICALC's 70 built-in scientific, engineering, and statistical functions—and its ten user-definable keys. And you'll see each operation on the large, easy-to-read LCD display.

If all that's not enough, you

can add software cartridges—like Pascal, statistics, mathematics... A portable printer. And a cassette interface for saving data in big batches.

Think what you could accomplish with a programmable that speaks your language. Ask to see it where you buy your professional tools. Try the TI-74 BASICALC now.

TEXAS INSTRUMENTS

TECHNOLOGY UPDATE

large LCDs provides some help for the fumble-fingered who have trouble hitting calculator keys accurately and for the fumble-brained who can't get formulas or programs right on the first pass. Whereas most calculators display only the present results of the operation last invoked, the fx-8000G, HP-28C, and EL-5200 can retain and display an entire string of commands on their large, multiline displays. The calculators have editing keys for moving the cursor around in the command line, and they have inserting and deleting functions. Thus, you can go back and alter the string before you execute it. And, if you don't like the result of the calculation, you can recover the command string and data, alter them further, and rerun them. (The HP-28C can also operate in the immediate mode, as a conventional calculator does.)

This command-string mode of operation and these editing capabilities make entering complex functions and programs in this calculator much easier than it was in earlier calculators that did not capture your command line or support simple editing functions. The HP-28C has one further computerlike trait: a single-stepping command in its program-control menu for troubleshooting programs.

Menus and softkeys

An additional way in which scientific calculators are becoming more like computers is that many of them are now menu controlled, and many also provide some softkeys instead of having a dedicated key for each function. Very early in their development, scientific calculators acquired more functions than could possibly be handled by the maximum number of dedicated keys that could fit on a control panel of reasonable size. Soon each key had to do double duty—it had a primary function that you got with a single keystroke and a "shifted" function that you got by preceding the keystroke with the press of a shift or a second



The \$200 TI-95 from Texas Instruments requires only a simple connecting cable to drive its companion printer (\$115). The calculator also accepts preprogrammed ROM cartridges containing applications programs or constant-memory cartridges for storing user programs and data.

function key.

The Casio fx-8000G provides an extreme example of this form of control. Some of its keys have five functions. Which function you get depends on the mode you are in and whether you precede a keystroke with a shift-key or alpha-key keystroke.

HP and TI have chosen to make their newest control interfaces more like menu-driven computer programs. The HP-28C's keypad doesn't have many of the math keys you'd expect to find on a scientific calculator. It has only eight math keys—four basic mathematical operations and four simple, shifted math functions. The keyboard has no keys for common scientific functions such as trigonometric or logarithmic operations. It does, however, have an equals sign (earlier scientific calculators from HP did not). The HP-28C gives you the option of entering functions algebraically as well as in the company's classical reverse Polish notation.

Before you can use most of the mathematical, graphical, or editing functions of the calculator, you must first summon the appropriate menu. For example, before taking the sine of an angle, you must first press the

Trig button. After you've pressed the Trig key, a series of five choices appears across the bottom of the display. You invoke the function you want (in this case, sine) by pressing a softkey immediately below the display. The TI-95 (\$200) employs a somewhat similar, but more limited, scheme; it has more dedicated function keys than the HP-28C does.

The HP-28C's designers had no choice but to employ this menu scheme. For its size, the HP-28C is probably the most complex object ever made by man. The calculator has far more functions than any other calculator—too many functions to employ dedicated keys for each one. Mechanically, the process of selecting a menu with one key and then using a softkey to get the function you want from the menu is identical—at least in the number of keystrokes—to pressing a shift key and a function key. Conceptually, though, the two schemes are significantly different.

To use the shifted-function approach, you need only learn your way around your calculator's keyboard. To use the HP-28C's menu approach, you must learn the hierarchy that the calculator's designers imposed on its collection of func-

Get more out of your workstation.

Give your workstation the powerful output it deserves. Versatec electrostatic and thermal plotters deliver your drawings, maps, and charts faster, more reliably than any pen plotter.

Draw big, beautiful plots with high speed monochrome or color plotters in plot widths from 11 to 44 inches. Print as you plot using hardware character generators. Present your work on high quality paper and film media.

The right connection. Link your Sun, Apollo, MicroVAX or IBM PC/AT workstation directly with any Versatec plotter via fast parallel interfaces and optimized plotting software, or simultaneously receive plots from six nodes on your Ethernet® TCP/IP network with a Versatec Plot Server.

Versatec delivers more support. More interfaces. More standalone and embedded rasterizers. More experienced electrostatic and thermal plotter service. And more spares at more locations.

Circle our readers' service number or call toll-free 800/538-6477* for your copy of "How to get more out of your workstation."

Move up to Versatec.



*In California, call toll-free 800/341-6060

Sun is a trademark of Sun Microsystems. Apollo is a trademark of Apollo Computer. MicroVAX is a trademark of Digital Equipment Corporation. IBM PC/AT is a trademark of International Business Machines Corporation.

Versatec and Versatec Plot Server are trademarks of Versatec, Inc. Xerox is a trademark of Xerox Corporation.

Plot data courtesy of Xerox, IMI and Zeh Graphic Systems.

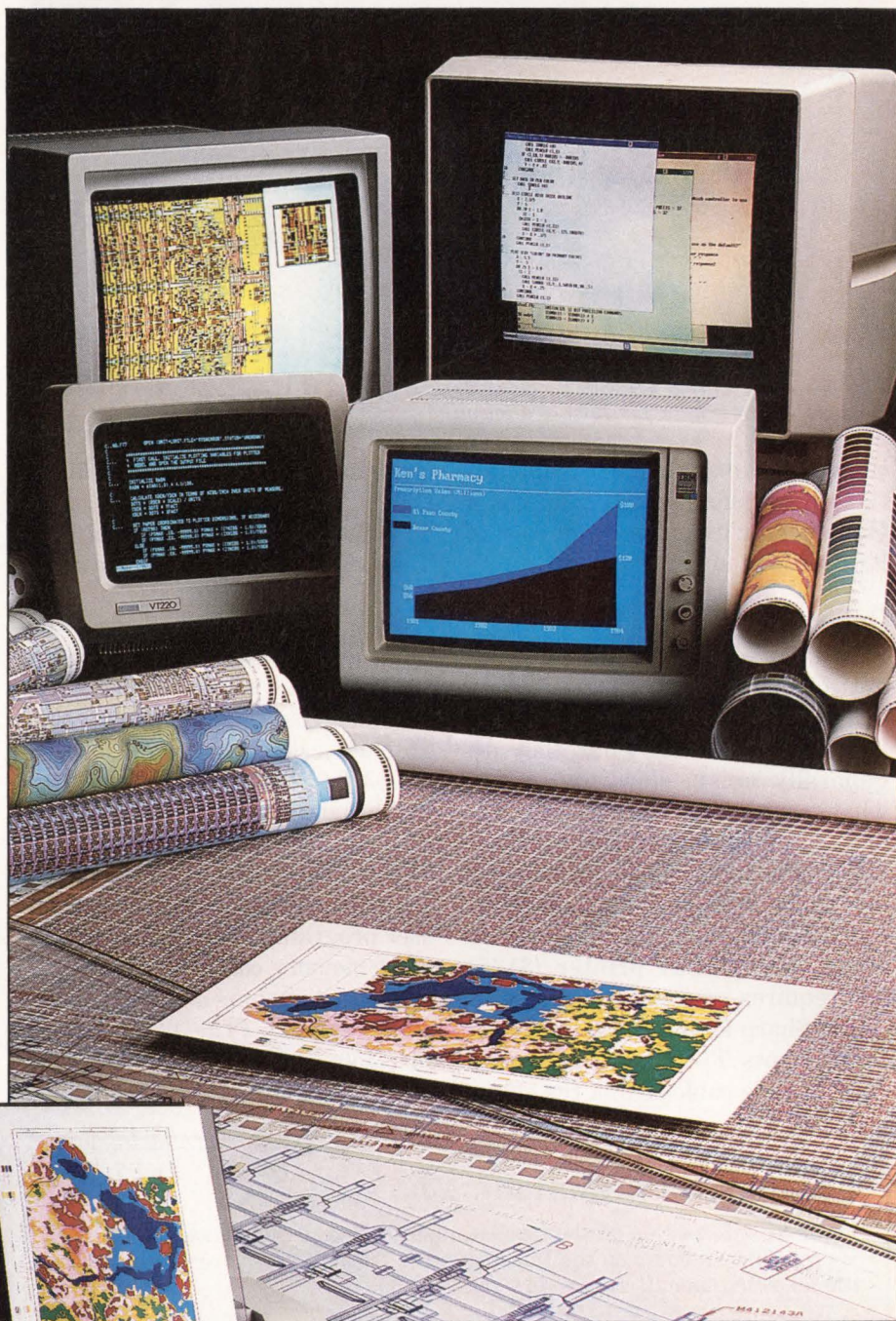

VERSATEC
A XEROX COMPANY

CIRCLE NO 22

TECHNOLOGY UPDATE



The press of a button switches the Texas Instruments \$135 TI-74 from a handheld Basic computer with scientific functions to a scientific calculator.

tions. Like many complex applications programs, the HP-28C has a Help menu with an entry for each of its functions and commands.

Optional printers

Just like real computers, most scientific calculators can give you a printout. But their optional printers have two drawbacks. First, they are generally noisy, slow, and somewhat troublesome to program. Second, some require extra interface boxes. The HP-28C has the simplest link to its printer. It uses an infrared LED to send a print file to its Model HP-82240A printer (\$135) and requires no connecting cable.

The Sharp EL-5200 and the Texas Instruments TI-74 and TI-95 need only a single cable to link the calcu-

lator and printer. The Sharp Model CE-50P printer costs \$124, and the TI Model PC 324 printer costs \$115. The Casio calculators require an interface unit between calculator and printer. For example, the fx-8000G requires the \$69.95 Model FA80 interface. The Casio Model FP40 printer costs \$139.95. Casio's graphics calculators can also drive the \$399.95 Model FP-100 plotter.

The latest scientific calculators offer nothing really new in the way of storage of programs and data. The cleanest solutions for storing user programs and data are the constant-memory cartridges that some Texas Instruments and Sharp calculators employ. (The TI cartridges cost \$50; Sharp's are \$45 to \$125.) These calculators have a rudimenta-

ry file-management system that allows you to store and retrieve your programs from the cartridges. Continuing the long-standing tradition of ROM packs, the TI calculators also accept preprogrammed, \$45 ROM cartridges that contain routines for various specific applications such as mathematics and chemical engineering.

With the aid of the appropriate interface units, you can also store programs for Casio, TI, and Sharp calculators on common cassette recorders. The Model FA80 cassette/prINTER interface for the Casio fx-8000G costs \$69.95. The TI cassette interface costs \$35. The Sharp CE-50P printer (\$124) also incorporates a cassette interface. The Hewlett-Packard HP-28C has no provision for external storage.

These calculators vary widely in the amount of internal storage they offer. The Casio fx-8000G can store 10 programs (having a total of 1446 steps) internally. The Hewlett-Packard HP-28C has 1650 bytes of user memory and is not intended to replace the company's HP-41, which does offer off-line storage of large program libraries and data files.

The Sharp EL-5200 can store 99 formulas having a total of 5120 steps; the Model EL-5150 stores 99 formulas having 1454 total steps. Finally, the Texas Instruments Models TI 95 and TI 74 each have an 8k-byte memory that you can partition at will among file space, program steps, and data registers. You can expand the memory with an 8k-byte constant-memory cartridge. **EDN**

For more information . . .

For more information on the calculators described in this article, circle the appropriate numbers on the Information Retrieval Service card or contact the following manufacturers directly.

Casio Inc
Box 1386
Fairfield, NJ 07007
(201) 575-7400
Circle No 697

Panasonic Industrial Co
One Panasonic Way
Secaucus, NJ 07094
(201) 348-7000
Circle No 699

Texas Instruments Inc
Box 79408
Lubbock, TX 79408
(806) 741-2000
Circle No 701

Hewlett-Packard Co
Inquiries Manager
1000 NE Circle Blvd
Corvallis, OR 97330
Phone local office
Circle No 698

Sharp Electronics Corp
Sharp Plaza
Mahwah, NJ 07430
(201) 529-9526
Circle No 700

Article Interest Quotient (Circle One)

High 518 Medium 519 Low 520

HARD-TO-FIND SIGNALS A SOURCE OF DELAY?

Look at the Tek 2465A with a 17-bit Word Recognizer. It's an easy, economical scope option that makes the critical difference when you need to trigger on data to monitor digital system performance. Parallel bus information triggers your display, so you can view up to four channels of real-time information. Add standard features such as 350 MHz bandwidth, on-screen cursors, 500 ps/div time base and trigger level readout, and you have a scope made for solving tough problems in digital design!



CUT IT OUT!

- Please send me your free videotape introduction, "The 2445A/2465A Family: From Performance to Productivity."
- Please send me your free 22-page brochure.
- Please have a Tek representative get in touch with me as soon as possible to arrange a demonstration.

Yes! I want a closer look at the Tek 2445A/2465A Family.

Name _____

Title _____

Company _____

Address _____

City _____

State _____

Zip _____

() _____

Phone _____

Ext _____

D888-6-38AX EDN

Tektronix
COMMITTED TO EXCELLENCE

SCOPES CUT OUT FOR YOUR KIND OF WORK.

You can tailor the 2465A for special needs. Or choose one of three multiple-option packages, the 2465A Special Editions. They are configured for specific application areas at a significant savings over the separately ordered options.

The 2465A CT with Counter/Timer/Trigger offers crystal-controlled timing accuracy plus the extra triggering power you need for digital systems.

Frequency and period can be measured with counter accuracy from any vertical channel directly. Or set up the scope to measure time intervals such as pulse width, rise time and propagation delay. Then store instrument setups in nonvolatile memory—for easy access and automatic execution.

Check Tek software development packages. They make it easy to generate automated and semi-automated test procedures, even without prior GPIB-programming experience. Use the simple, multi-

| Key Features | 2465A DV | 2465A DM | 2465A CT | 2465A | 2445A |
|---------------------------------------|---|---------------|---------------|-------------|-------------|
| Probe Tip Bandwidth | 350 MHz | 350 MHz | 350 MHz | 350 MHz | 150 MHz |
| No. of Channels | 4 | 4 | 4 | 4 | 4 |
| Horizontal Accuracy | 2% (.001%*) | 2% (.001%*) | 2% (.001%*) | 2% (.001%*) | 2% (.001%*) |
| Max. Sweep Speed | 500 psec | 500 psec | 500 psec | 500 psec | 1 nsec |
| Vertical Sensitivity | 2 mV/div | 2 mV/div | 2 mV/div | 2 mV/div | 2 mV/div |
| Trigger Frequency | 500 MHz | 500 MHz | 500 MHz | 500 MHz | 250 MHz |
| GPIB | Standard | Standard | Standard | Optional | Optional |
| Counter/Timer/Trigger/Word Recognizer | Standard | Standard | Standard | Optional | Optional |
| Digital Multimeter | Standard | Standard | Not Available | Optional | Optional |
| Video Trigger | Standard | Not Available | Not Available | Optional | Optional |
| Probes | 4 | 4 | 4 | 2 | 2 |
| Warranty | 3 years on parts and labor, including CRT | | | | |

*with Counter/Timer/Trigger

level menus to develop sophisticated test programs.

Software is available to operate with the Tektronix 4041 controller, IBM PC, XT,™ AT® and compatibles.

Get the full story! Return the reply card to Tek today. For a hands-on demonstration, call your Tek Sales Engineer.

BUSINESS REPLY MAIL

FIRST CLASS PERMIT NO. 1 BEAVERTON, OR

POSTAGE WILL BE PAID BY ADDRESSEE

Tektronix, Inc.

P.O. Box 1700
Beaverton, OR 97077



NO POSTAGE
NECESSARY
IF MAILED
IN THE
UNITED STATES

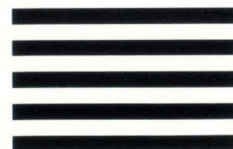

Transputer-based PC add-in board supports programming in C

With the T4 add-in board, you can develop parallel-processing applications on an IBM PC or compatible computer. The board comprises four processor sections, each containing an Inmos Transputer and 1M, 2M, or 4M bytes of dedicated dynamic RAM.

A program running on a parallel system typically comprises several processes, each operating on a separate processor, and is capable of

interprocess communications. The Transputer performs these interprocess communications through four on-chip hardware links. The links perform high-speed (10M or 20M bps) serial data transfers between Transputers when necessary. The software can direct any process to send data to or receive it from any other process. Each Transputer has four links that connect to externally accessible pinouts, so you can con-

nect the Transputers in a variety of parallel architectures, such as ring or hypercube configurations. In a system with multiple T4 boards, you can link Transputers between boards.

The initial version of the board uses a T414 Transputer that operates at 15 or 20 MHz and that's capable of an instruction throughput of 10 MIPS. The chip has a linear address space of 4G bytes, of

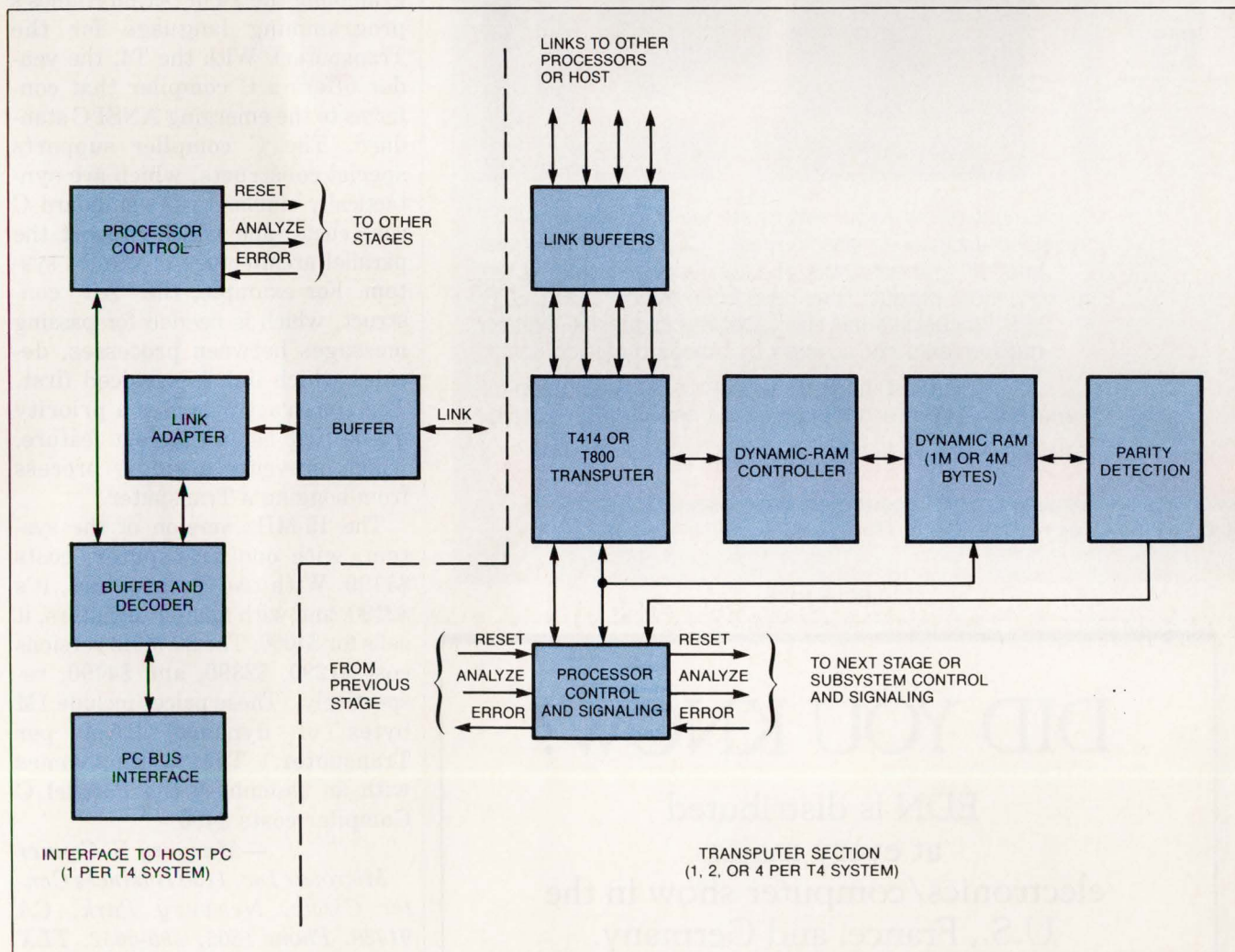

The host-interface section of the Transputer-based T4 PC add-in board receives data from the PC bus and passes it to the board's four Transputer sections over high-speed serial links. You can connect the links among the Transputers either on the same board or on multiple T4 boards, so you can configure parallel architectures, such as ring or hypercube configurations.

Emission Control

With Emcor EMI/RFI enclosures

Available for FCC and military shielding requirements

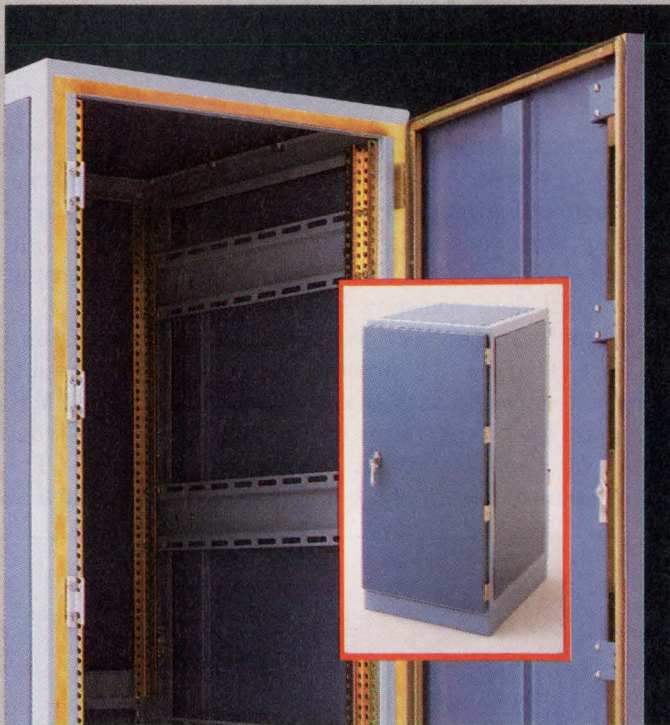

Crenio, Inc.
Emcor Products

Emcor offers two levels of standard catalog EMI/RFI shielded enclosures: one to meet FCC requirements and another to meet levels of attenuation required by the military. Both product lines have been tested to MIL STD 285. Emcor also has the capability to provide custom requirements not covered by standard catalog items.

Find out more about Emcor's emission control enclosures. Write or call today for our new EMI/RFI catalog.

EMCOR

1600 Fourth Avenue N.W., Rochester, Minnesota 55901 (507) 289-3371

CIRCLE NO 6

DID YOU KNOW?

EDN is distributed
at every major
electronics/computer show in the
U.S., France, and Germany.

EDN

UPDATE

which 2k bytes is 20-nsec internal memory. It's this fast workspace memory that lets the Transputer perform rapid context switching. Instead of having to store all of its register states when it switches tasks, the Transputer merely changes a pointer in the workspace; the pointer tracks the section of memory that holds a particular set of registers.

The vendor will offer to retrofit the T4 with the more powerful T800 version of the Transputer as soon as Inmos begins shipping it in production quantities. The T800 incorporates a floating-point unit and has 4k bytes of on-chip, 20-nsec dynamic RAM.

You have an alternative to programming the T4 in Occam (Inmos's programming language for the Transputer). With the T4, the vendor offers a C compiler that conforms to the emerging ANSI C standard. The C compiler supports special constructs, which are syntactically similar to the standard C constructs and which support the parallel architecture of the T4 system. For example, the "Alt" construct, which is needed for passing messages between processes, decides which link is serviced first. The construct provides a priority queue that has a time-out feature, which prevents a single process from hogging a Transputer.

The 15-MHz version of the system, with one Transputer, costs \$1190. With two Transputers, it's \$2190, and with four Transputers, it sells for \$4090. The 20-MHz versions cost \$1290, \$2390, and \$4490, respectively. (These prices include 1M bytes of dynamic RAM per Transputer.) The system comes with an assembler; the Parallel C Compiler costs \$495.

—Margery S Conner

Micropar Inc, 1100 Business Center Circle, Newbury Park, CA 91320. Phone (805) 499-0652. TLX 272849.

Circle No 648

Z I L O G



The highest performance and highest integration, ever. Together on a single 16-bit chip.

The Z280™ gives you a more powerful CPU and higher performance peripherals than you've ever seen on a 16-bit chip. Think of it as a complete microsystem on a chip.

Unmatched performance...

Start with the most powerful 16-bit engine available, add on-board Cache, MMU and Burst Mode memory support — and you'll begin to understand the Z280's power and potential.

...powerful on-board peripherals...

Imagine the savings in cost and board size when you have peripherals like 4 DMA channels that'll give you transfers at 6.6 Mbytes/sec, and a full-duplex UART.

... and the glue to tie it all together.

With a DRAM Controller to support up to 1 MBit DRAMs and Programmable Wait State Logic — on board — you're really looking at significant glue reduction.

| | Z280™ | 80186 | 68070 |
|------------------------|-----------------------------------|---------------------------|----------------------------------|
| Package | 68-pin PLCC/CMOS | 68-pin LCC/NMOS | 84-pin PLCC/CHMOS |
| Typical Power | 375 mW | 2 W | 800 mW (est) |
| Speed | 10-25 MHz | 8-12.5 MHz | 10 MHz |
| Memory Support | 16 Mb Physical Paged | 1 Mb Physical Segmented | 16 Mb Physical 8 or 128 Segments |
| 16-bit Registers | 12 General | 8 General | 15 Dedicated |
| Instruction Pre-fetch | 256-Byte Assoc. Cache; Burst Mode | 6-Byte Queue | None |
| Multiprocessor Support | Local or Global | Local only | Local only |
| Wait Logic | Programmable | Programmable | Hardwire |
| DMA | 4 Channels, 6.6 Mb/s @ 10 MHz | 2 Channels 2 Mb/s @ 8 MHz | 2 Channels, 3.2 Mb/s @ 10 MHz |
| Counter/Timers | 3 16-bit | 3 16-bit | 2 16-bit |
| Serial I/O | 1 Full-Duplex UART | None | 1 Full-Duplex UART |
| DRAM Controller | 10-bit Refresh | None | None |
| Price (100) | \$33 | \$43 | \$50 |

Z280: Truly a microsystem.

The Z280 gives you a lot more performance. In a lot less board space. All off the shelf and backed by Zilog's proven quality and reliability. Plus, it's binary code-compatible with the Z80® and priced to rival 8-bit chips. And all the development support tools you need are available from industry leaders. Contact your local Zilog sales office or your authorized distributor today. Seeing is believing. Zilog, Inc., 210 Hacienda Ave., Campbell, CA 95008 (408) 370-8000.

The choice is clear.

Right product. Right price. Right away.

ZILOG SALES OFFICES: CA (408) 370-8120, (714) 432-9971, (818) 707-2160, CO (303) 494-2905, FL (813) 585-2533, GA (404) 923-8500, IL (312) 885-8080, MA (617) 273-4222, MN (612) 831-7611, NJ (201) 288-3737, (609) 778-8070, OH (216) 447-1480, TX (214) 231-9090, CANADA Toronto (416) 673-0634, ENGLAND Maidenhead (44) (628) 781227, W. GERMANY Munich (49) (89) 612-6046, JAPAN Tokyo (81) (3) 587-0528, HONG KONG Kowloon (852) (3) 723-8979, R.O.C.: Taiwan (886) (2) 731-2420, U.S. AND CANADA DISTRIBUTORS: Anthem Electric, Bell Indus., Graham Elec., Hall-Mark Elec., JAN Devices Inc., Lionex Corp., Schweber Elec., Western Microtech., CANADA Future Elec., SEMAD.

Zilog
an affiliate of
EXON Corporation

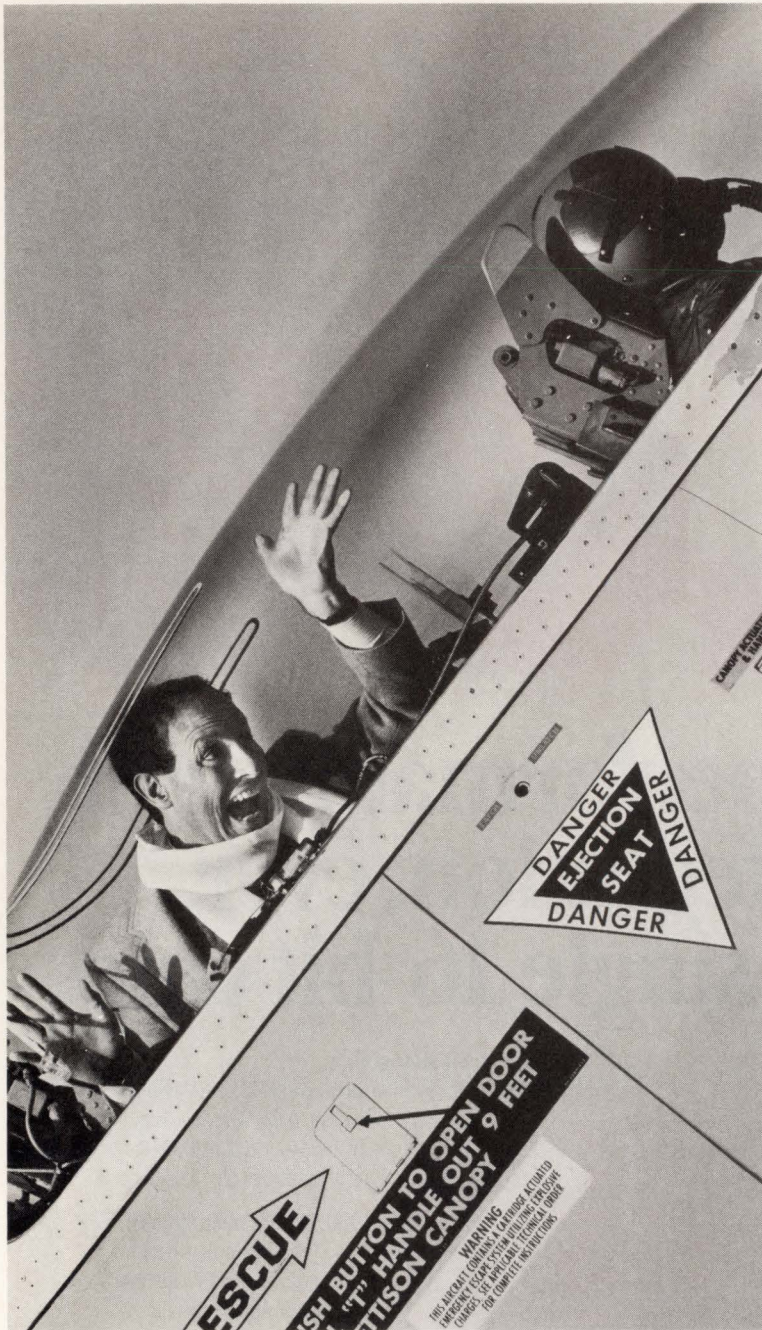

Take Image Processing and Data Acquisition to MACH speed on the IBM PC with our new Array Processor.

Fasten your seat belts! Our IBM PC array processing board and software fly! And they're completely backwards compatible with our Image Processing (frame grabber) and Data Acquisition (A/D, D/A) boards and software.

Our MACH Series DT7010 Floating-Point Array Processor is general-purpose, and performs IEEE 32-bit floating-point arithmetic at 6.5 Mflops. The DT7010 is particularly good at crunching data acquired by a Data Translation frame grabber or A/D board.

And with our MACH Series software, you don't have to program the board. The MACH Vector Subroutine Library contains 118 general-purpose subroutines for digital image processing/signal processing, and vector/matrix operations. Our MACH Assembler and MACH Simulator ease writing custom algorithms.

So hold on to your hat, and call us, at (617) 481-3700. The age of supersonic, desktop Image Processing and Data Acquisition is flying.

To learn more, see us in Gold Book 1987, or call to receive our first-ever 1987 3-Book Set, including 1987 Catalog, Product Summary Price List, and Applications Handbook.



Call (617) 481-3700

Fred Molinari, President

Hardware

MACH SERIES SUMMARY

Software

| | FFT* 1024 Point Real | FFT* 1024 Point Complex | FFT* 256 x 256 Image | Price |
|---|----------------------------|-------------------------------|----------------------------|--------|
| DT7010 Floating-Point Array Processor | 23ms | 41ms | 3.9s | \$4995 |

| | |
|--|---------------------------------------|
| MACH Vector Subroutine Library |for end-users (\$1495) |
| MACH Microcode Assembler And Simulator |for algorithm developers (\$1495) |
| MACH Library, Assembler And Simulator |(\$2495) |

*All execution speeds are real-world, not theoretical, and include overhead times.

DATA TRANSLATION®

World Headquarters: Data Translation, Inc., 100 Locke Dr., Marlboro, MA 01752 (617) 481-3700 Tlx 951 646

European Headquarters: Data Translation Ltd., 13 The Business Centre, Molly Millars Lane, Wokingham, Berks, RG11 2QZ, England Tlx 849862 (#D)

International Sales Office: Australia (61) 2-662-4295; Belgium (32) 2-7352135; Canada (416) 625-1907; Chile (2) 2-253689; China (408) 727-8222; (86) 8-721-4017; Denmark (45) (02) 187188; England (44) 734-79383; Finland (358) 90-372144; France (33) (1) 69-28-01-73; Greece (30) (3) 152-7039; (30) (1) 361-4300; Hong Kong (852) 3-318585; India (91) 2-231040; Israel (972) 3-324298; Italy (39) 2-81821; Japan (81) (3) 502-5550; (81) (3) 375-1551; (81) (3) 355-1111; Korea (82) 778-0721; Malaysia (60) 3-36299; Morocco (21) 9-30-6949; Netherlands (31) 70996360; New Zealand (61) 2-662-4295; Norway (47) (02) 559050; Peru (51) (14) 31-8060; Philippines (63) 818-0103; Portugal (351) 1545313; Singapore (65) 271-3163; South Africa (27) 12469221; Spain (34) 14558112; Sweden (46) 8-7617820; Switzerland (41) 17231410; (41) 22360830; Taiwan (86) 2-709-1394; West Germany (49) 89809020.

Data Translation is a registered trademark of Data Translation, Inc. IBM PC is a registered trademark of International Business Machines Corp.

Trio of digitizing oscilloscopes features high bandwidth, deep memory

Three digitizing oscilloscopes—the HP5185T, HP54112D, and HP54120T—can cater to almost all your high-bandwidth and deep-capture measurement needs. Each of the three instruments focuses on different measurement requirements (see **Table 1**). The HP5185T precision digitizing oscilloscope/waveform recorder provides the high resolution and variable digitizing rate you expect from a waveform recorder and also performs frequency-domain signal analysis. Although it has nearly the same input bandwidth, the HP54112D offers twice as many channels as the HP5185T does, but at a little more than half the price. For extremely high-frequency (to 20 GHz), repetitive measurements, the HP54120T offers high-resolution signal digitizing on four input channels.

With its high-resolution A/D converter, deep memory, and complex triggering capability, the HP5185T precision digitizing oscilloscope captures extensive information about a signal. The deep memory improves the instrument's ability to perform an FFT on the sampled waveform. In addition, the digital scope can compute and display a signal's power and phase spectra. Each input channel has two adjustable

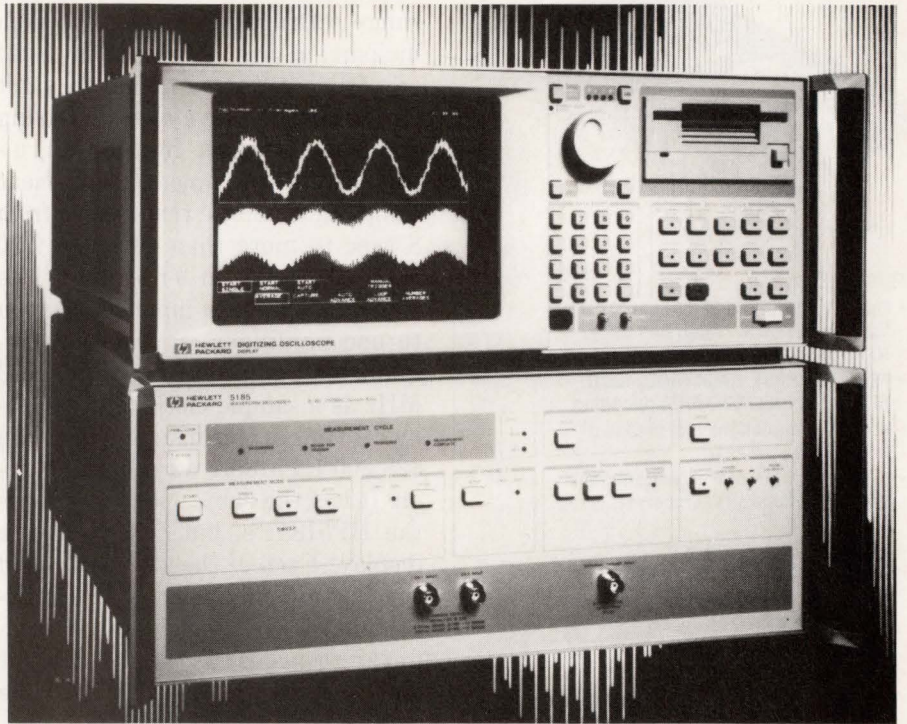

One member of a family of three digitizing oscilloscopes, the HP5185T features high-resolution digitizing on two input channels at rates to 250M samples/sec, and it captures 64k samples/channel.

trigger levels for internal triggering.

You can use these two levels to create a hysteresis window that prevents noise from accidentally triggering data capture, to create a "bi-trigger" window that triggers data capture when a signal deviates either above or below a set voltage,

to create "posneg" trigger levels that start data capture only when a signal has crossed both trigger levels (regardless of the order of the crossings), or to create a dropout trigger that starts data capture when a signal is either above or below the trigger level for a specified length of time. A program-

TABLE 1—KEY SPECS FOR THREE DIGITIZING SCOPES

| MODEL | REPETITIVE BANDWIDTH (MHz) | SINGLE-SHOT BANDWIDTH (MHz) | SAMPLE RATE (MHz) | RESOLUTION (BITS) | CHANNELS | SAMPLES/CHANNEL | PRICE |
|----------|----------------------------|-----------------------------|-------------------|-------------------|----------|-----------------|----------|
| HP5185T | 110 | 110 | 250 | 8 | 2 | 64k | \$40,000 |
| HP54112D | 100 | 100 | 400 | 6 | 4 | 64k | \$22,900 |
| HP54120T | 2000 | N/A | * | 12 | 4 | 1k TO 10k | \$27,850 |

NOTE: N/A=NOT APPLICABLE
*SEE TEXT

NEW 2400 BPS CCITT V.22 BIS SINGLE-CHIP MODEM

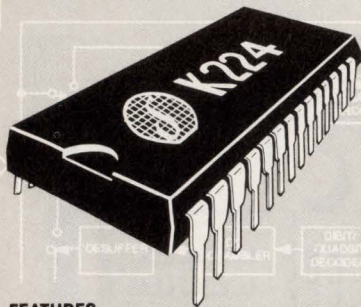

FEATURES:

- One-chip multi-mode modem IC for V.22 bis/V.22/V.21 and Bell 212A/103 applications
- FSK (300 BPS), DPSK (600, 1200 BPS), or QAM (2400 BPS) encoding
- All modem functions included in a single chip
- Integrated DSP for high performance adaptive equalization receive capability
- Fully compatible with SSI K212, K221, and K222 1-chip modems
- Interfaces directly with standard microprocessors (8048, 80C51 typical)
- Single +12V or +5V supply
- CMOS technology for low power consumption (120mW @ 5V)

Silicon Systems now offers the industry's most highly integrated modem IC—the SSI K224. It is a single-chip modem IC that provides all the functions needed to construct a V.22 bis compatible modem, capable of 2400 BPS full-duplex operation over dial-up lines. The SSI K224 offers excellent performance and a high level of functional integration in a single 28 pin DIP. This device meets world-wide standards and supports all modes of operation, allowing both synchronous and asynchronous communication.

The SSI K224 is ideal for use in either free-standing or integral system modem products such as lap-tops, PC's and portable terminals, or wherever full-duplex 2400 BPS data communications over the 2-wire switched telephone network is desired.

The SSI K224 is pin and software compatible with the SSI K212, K221, and SSI K222 single-chip modem IC's, allowing system upgrades with a single component change.

For more information on the SSI K224 and the complete SSI K-Series modem IC family, contact: **Silicon Systems**, 14351 Myford Road, Tustin, CA 92680. Phone: (714) 731-7110, Ext. 575.

silicon systems
INNOVATORS IN INTEGRATION

PRODUCT UPDATE

mable delay allows you to postpone the start of data capture by as many as 1M samples. The scope also has an external-trigger input.

Each channel of the HP5185T provides nine full-scale input ranges from ± 50 mV to ± 20 V, and you can define as many as three custom range settings for frequently taken measurements. A gated timebase allows an external signal to start and stop the waveform digitizing after the trigger. In addition, although the instrument has a linear sampling timebase that ranges from 8 nsec to more than 490 μ sec (250 MHz to 2 kHz) in 8-nsec steps, its external timebase input allows you to use nonlinear or precision frequencies ranging from dc to 250 MHz as a sample clock. The company also offers this instrument as the \$28,200 HP5185A waveform digitizer: It has the same specifications as the HP5185T's, but doesn't have a display. Each of the two versions of the instrument includes an IEEE-488 interface that allows a host computer to program the instrument and to read the samples after the signals have been captured.

Although some of its specifications resemble those of the HP5185T, the HP54112D digitizing oscilloscope is quite a different instrument. It has two bits less vertical resolution, twice as many channels, and costs a little more than half the price. The HP54112D does not have the HP5185T's frequency-domain-calculation capability or its dual internal triggers for each channel, but it does share the HP5185T's ability to compute and display other signal attributes, including frequency, period, pulse duration, rise and fall times, and signal rms voltages.

The HP54112D digitizes signals at rates from a blazing 400 MHz to a snail-like 50 sec/sample. Its input-channel ranges span ± 5 mV/div to ± 5 V/div. Each input has one trigger level, and the instrument accepts an external trigger applied to a rear-panel input connector. In addition, it has a pattern trigger that

allows you to use the four analog input channels plus the external trigger input as a 5-bit logic trigger. A trigger delay allows you to hold off the start of data capture by as many as 16M trigger events. The scope's color display makes the multiple signal traces easy to identify: The scope ties numeric information on the display to the associated trace by displaying the numbers in a matching color.

For very-high-frequency analysis, the HP54120T digitizing oscilloscope features a 20-GHz repetitive-signal bandwidth on its four input channels. The company rates the scope's timebase as having 0.25-psec resolution and 10-psec accuracy. Because the instrument uses a sequential sampling technique that acquires only one sample per trigger, it does not perform single-shot measurements. In fact, the scope digitizes at a typical sample rate of 4500 Hz and has a maximum sample rate of 10 kHz. Its input channels have no trigger levels; you must use the instrument's 500-MHz external trigger input.

In addition, the 50 Ω input channels have no input attenuators. The full-scale input range for all channels is ± 320 mV. To reduce larger signals, you use fixed, external attenuators that you screw onto the channel's 3.5-mm input connectors. The company offers HP33340C Series fixed attenuators for \$248 each; they offer attenuation of 0 to 40 dB. An external enclosure houses the input channels and trigger input, allowing you to place the input connectors close to the circuit you're testing so you can minimize the lengths of the test cables. At the very high frequencies the HP-54120T can capture, you need the shortest possible cable runs. The input head contains fast S/H circuits with filtering, so only low-frequency analog signals pass back to the instrument's mainframe, where the digitizing is performed.

Above 1 GHz, you'd normally pipe signals around a system by using

"THEY SAID NO ONE COULD PUT IT ALL ON ONE CHIP."

Introducing the SSI K224 With Everything You Want in a 2400 BPS Modem— With DSP on Chip.

"When we set out to design the universal modem IC that would meet 300 to 2400 BPS worldwide standards, even some of our best customers were skeptical. We knew existing solutions took a handful of IC's and separate DSP's for V.22 bis operation, requiring a lot of space and power. Our customers said they needed a single IC that would do it all, so it was only natural that we would come up with a chip that would meet their needs.

"Here's what they asked for, and here's what the K224 gives them: V.22 bis, V.22, V.21, Bell 212A and 103 modes of operation for both synchronous and asynchronous communication; complete tone generation for DTMF, answer and guard tones; call progress tone and handshake pattern detectors; and all the other functions needed to support intelligent modem designs. We integrated all these functions plus the DSP on a single chip—something no one else had attempted.

"So our skeptics were almost right when they said no one could put it all on one chip—because so far no one else has. Maybe some day someone else will. Meanwhile, give us a call and take advantage of the jump we've got on our competition by getting the jump on yours."

Call Now!
(714) 731-7110, Ext. 575

For more information on the SSI K224, or the complete K-Series family of compatible modem IC's, contact: **Silicon Systems**, 14351 Myford Road, Tustin, California 92680.

silicon systems™
INNOVATORS IN INTEGRATION

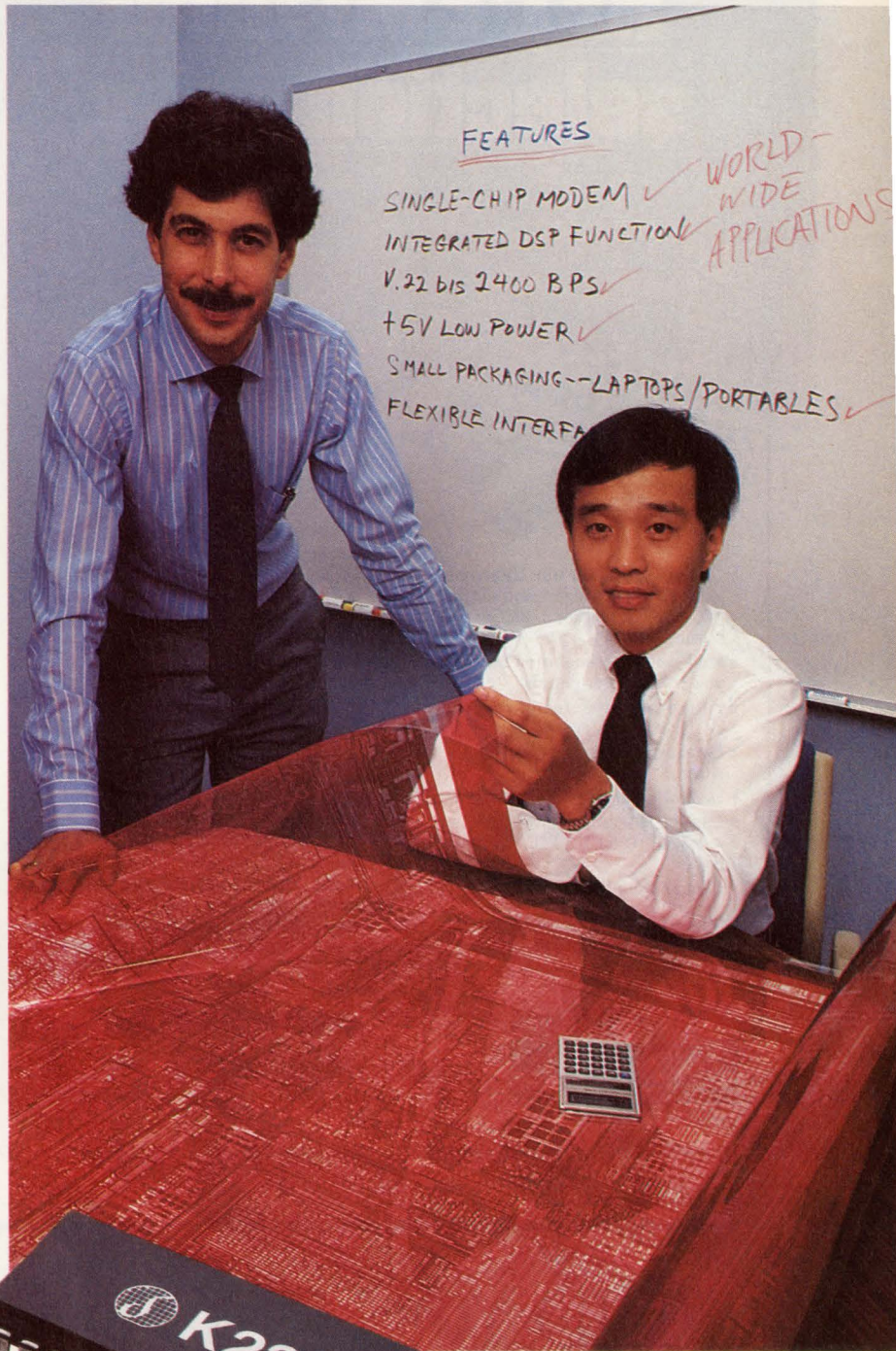

Steve Levy / Peicheng Ju
Design Engineers

"Where we design to your applications."

LMI makes RFI/EMI filter selection easy.

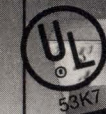

**NEW
FACILITY
FILTERS NOW
UL LISTED!**

Write for new
Catalog 300-A

- Lectroline® power line filters meet MIL-F-15733 and interface with all UL and NEC approved equipment. UL-1283 approval pending.
- Wall- and Floor-mounted Lectroline power line filter panels.
- Filters and power factor coils available for standard 60 Hz and 400 Hz power systems.
- Communication and control line filters.
- Lectroline signal line filter panels.
- Custom filters to your specs to comply with MIL-STD-461/2/3, FCC, VDE and other regs.
- Common mode filters.

Reliability — an LMI advantage.

All Lectroline power line filters are supplied with internal bleeder discharge resistors per UL 478-1967 and NEC 460-4.

Oil leakage is virtually eliminated by hermetically sealing both the oil-impregnated capacitors and the external case.

Other LMI advantages include ventilation screens in high-current Lectroline filters (to UL-1283), use of wiring wells to isolate input and output wiring, and internal filter wiring at 1000 circular mils per ampere, minimum. Assembly of all electrical wiring, terminal strips and cabling is performed with UL-approved devices.

For most RFI/EMI suppression applications.

LMI filters and filter panels are now widely used in shielded rooms and cabinets, ground support equipment, computer rooms, hospital diagnostic facilities, electrical and electronic equipment, and communication centers. Write or call the LMI Application Engineering Department for additional information.

Nationwide Representatives



LectroMagnetics, Inc.

Specialists in electromagnetic shielding and compatibility

6056 West Jefferson Blvd., Los Angeles, CA 90016 • (213) 870-9383, Toll Free (800) 325-9814-U.S.A. • (800) 325-9815-CA

CIRCLE NO 10

DID YOU KNOW?

EDN serves
electronic engineers and
engineering managers in more than
100 countries worldwide.

EDN

UPDATE

coaxial cable and connectors. That procedure is often inconvenient for troubleshooting purposes, because the nodes you'd want to probe are generally not those that are conveniently attached to a connector. The company offers the Model HP-54006A, a passive, 6-GHz divider probe, for \$895. The probe allows you to explore very-high-frequency circuits when a coaxial hookup isn't available. The probe operates the way a regular scope probe does, but at much higher frequencies. It has interchangeable resistors, which give it attenuation of either 10:1 or 20:1.

A time-domain reflectometer (TDR) built into channel 1's input allows you to perform reflectance and impedance tests on circuit traces and cables. The HP54120T's onboard μ P allows you to null the effects of your test jig by pressing a button, so that only information pertaining to the circuit under test is displayed. With the TDR, you can explore the effects of stubs and impedance mismatches on ECL and GaAs pc-board traces.

The HP54120T features the color display and computation capabilities of the HP54112D and adds time and voltage statistics and histograms. You can use these histograms to determine jitter and noise on repetitive signals, a measurement traditionally made on analog scopes by subjectively judging the intensity of the shades in a smear of traces. At a single keystroke, the HP54120T calculates and displays the mean and standard deviation of time or voltage for several cycles of the digitized signal.—*Steven H Leibson*

Hewlett-Packard Co, Box 10301, Palo Alto, CA 94303. Phone local sales office.

Circle No 649

Introducing the new Wire-Wrap® XA3. It's operator friendly!

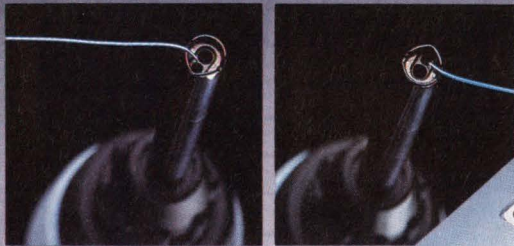

A turn of the outer knurled ring allows positioning of bit and sleeve to be adjusted to suit individual working styles.



Our designers call it "Operator Adjustable Indexing". It allows the operator to suit their own style of working by adjusting the index position of the bit and sleeve. It means faster, easier and more comfortable loading of the tool, more output and less fatigue for the operator. Inside the XA3 is an ultra tough drive train that features a planetary gear system to ensure quieter running, smoother operation, longer life, and easier servicing.

It also enabled our engineers to design a slimmer, lighter tool that's more compact and comfortable to use for longer periods of time. Get to know the Wire-Wrap XA3 from CooperTools. It's the good looking, high quality tool that's going to make a lot of friends in wire wrapping circles.

CooperTools

BREWER-TITCHENER® CAMPBELL® COVERT® CRESCENT® LUFKIN® MERRILL®
NICHOLSON® PLUMB® TURNER® WELLER® WIRE-WRAP® WISS® XCELITE®

The Cooper Group PO Box 728 Apex NC, 27502 USA
Tel (919) 362-7510 Telex 579497



BACK AMERICA

Data-acquisition chip contains 10-bit ADC, S/H circuit, and multiplexer

The LTC1090 data-acquisition system contains a 10-bit A/D converter, an S/H circuit with a 1- μ sec acquisition time, and an analog input multiplexer, all on a single piece of silicon packaged in a 20-pin DIP. The secret of the low pin count is the device's full-duplex, serial μ P interface. Selected versions of the part feature a total unadjusted error of ± 0.5 LSB over the full operating temperature range.

You can configure the analog input multiplexer as eight single-ended inputs, four differential inputs, or a combination of single-ended and differential inputs by means of the chip's 8-bit input data word. This data word selects a multiplexer input channel, picks single-ended or differential operation for the selected analog input, sets the polarity of the input pins for a selected differential-input pair, selects unipolar or bipolar A/D operation, defines the output word width, and determines whether the LSB or the MSB of the conversion will emerge first from the serial output. The internal S/H circuit operates only for single-ended conversions.

An on-chip, 10-bit, switched-capacitor D/A converter; a comparator; and a successive-approximation register form the A/D converter. You can select either 10-bit unipolar or 9-bit-plus-sign bipolar conversions by means of the chip's serial input data word. A conversion requires 20 μ sec. The total unadjusted error for either the unipolar or the bipolar conversion mode over the device's full temperature range is ± 0.5 LSB for the LTC1090A and ± 2 LSB for the LTC1090. The LTC1090CN, in a plastic package and rated for -40 to $+85^\circ\text{C}$ operation, costs \$11.95 (100). A similarly

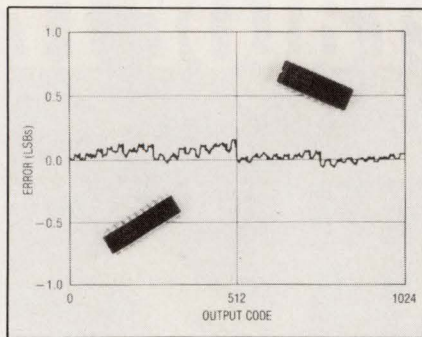

Each of these 20-pin DIPs houses a complete data-acquisition system comprising an analog input multiplexer, an S/H circuit, a 10-bit A/D converter, and a serial I/O port. The manufacturer rates the part's total unadjusted error at ± 0.5 LSB for selected devices.

packaged LTC1090ACN costs \$18.95 (100).

The A/D converter has ratiometric, differential reference inputs, so you can use any reference voltage and polarity that suits your application. When the reference voltages are low (around 0.5V), a charge-injection offset voltage becomes significant and can result in an error of about 0.5 LSB. However, this offset is proportional to the power-supply voltage and is not sensitive to temperature, so a software routine that runs an automatic calibration on a grounded input can null this error. For reference voltages around 5V, the offset voltage causes only about 0.1 LSB of error and therefore won't affect readings.

Because the device allows you to program unipolar or bipolar operation, you can achieve 11-bit resolution with this device by using a technique the company calls "Sneak-a-Bit." By performing two unipolar, 10-bit conversions and switching the polarity of the differential inputs between the two conversions, a software routine can assemble an 11-bit representation (composed of a 10-bit

magnitude and a sign bit) of the analog signal.

To accommodate 4-, 8-, and 16-bit μ Ps, the manufacturer designed a variable word width into this device. You can select 8-, 10-, 12-, or 16-bit output data words, and you can decide whether the LSB or MSB of the data word will be shifted out of the serial port first. This latter feature allows the part to interface directly with Motorola's SPI and National Semiconductor's Micro-wire serial μ C ports, which require data output to take place MSB first, or Hitachi's SCI and Texas Instruments' TMS7000 μ C ports, which want the LSB first.

For applications for which the 8-channel multiplexer and 20-pin package are too large, the company offers the LTC1091CN8 and LTC1091ACN8, which are 2-channel versions of the data-acquisition system in an 8-pin DIP. You can use the analog channels as two single-ended or one differential input. The LTC1091ACN8 has a maximum unadjusted error of ± 0.5 LSB, and it costs \$15.80 (100). The LTC1091CN8, which has a relaxed specification for total unadjusted error, costs \$10.95 (100).

—*Steven H Leibson*

Linear Technology Corp, 1630 McCarthy Blvd, Milpitas, CA 95035. Phone (408) 942-0810. TLX 172110.

Circle No 647

**JUST BECAUSE
YOU'VE MADE IT...**

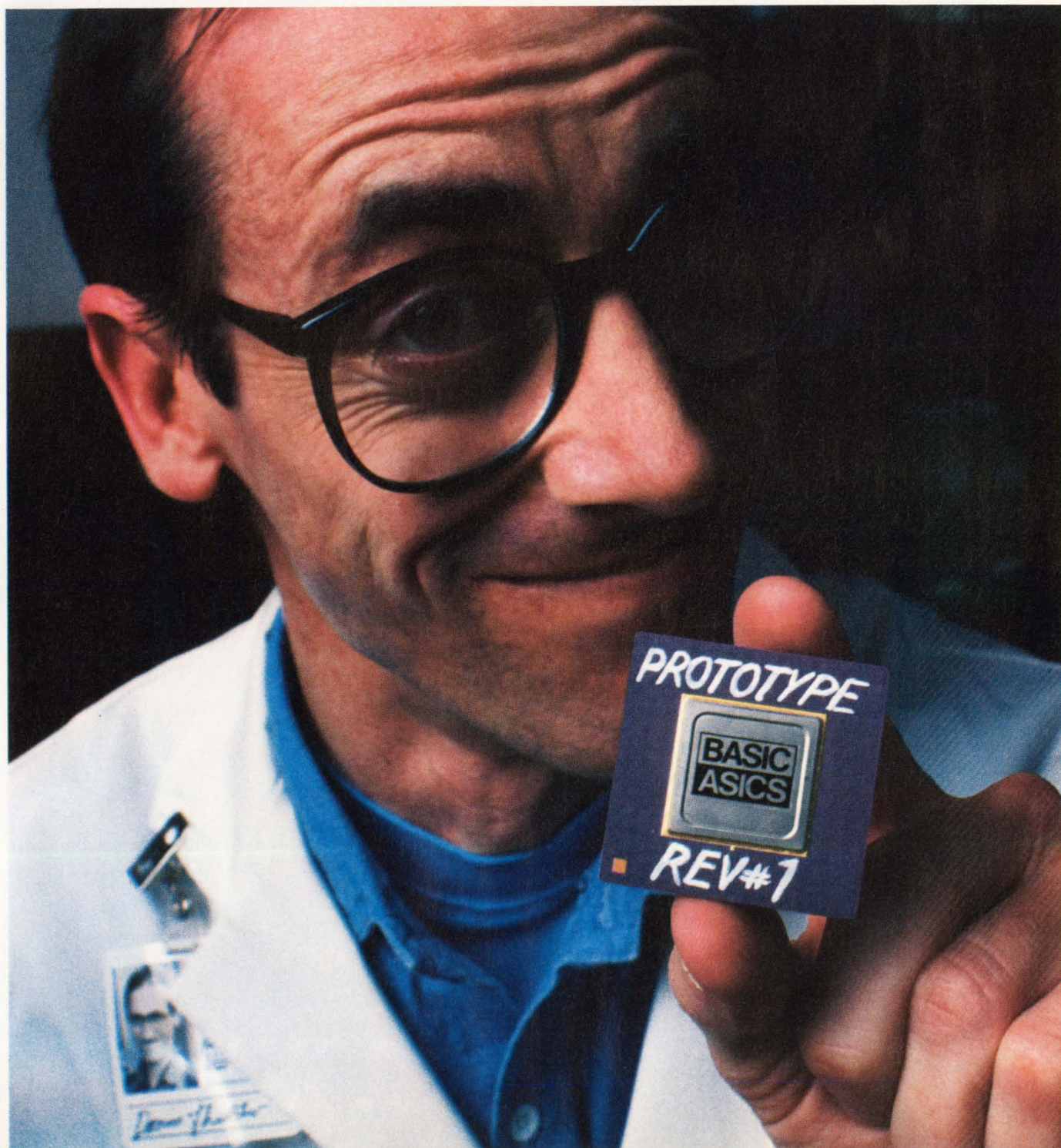

...DOESN'T MEAN YOU'VE GOT IT MADE.

With a lot of ASIC vendors, your first prototype is just the beginning of a long journey into design revisions. And after the arduous task of making the thing work, you're still not sure the device can be mass produced.

Unless you're working with Fujitsu.

Because when we produce your prototypes, you can bet they'll meet your performance specs. And you can be absolutely certain you'll be able to produce the device in quantity. And on schedule.

Here's why. We've taken over 8,000 designs from concept through mass-production. And over 99% of them have worked the first time. That's right. Prototype number one worked as specified.

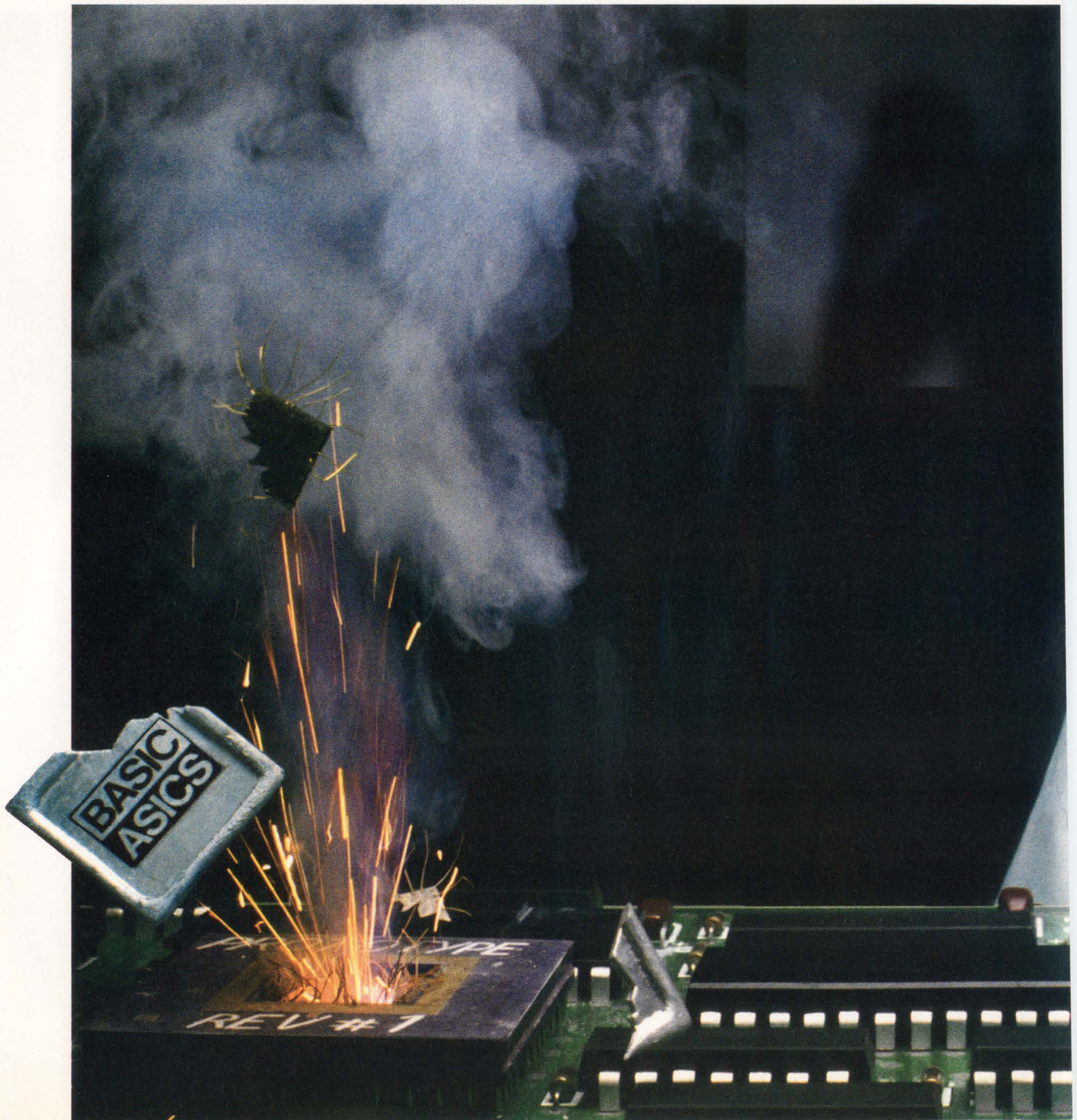

You see, we've been refining our design tools for the past fifteen years. And because they verify your input to worst case specs, as well as scrutinize every detail from spike analysis to bus contention, all the guesswork is eliminated. Our simulations are closely correlated to silicon (with a 99% hit rate). Plus, all prototypes and wafers are tested exactly like production units. So you know what you'll get. Before you get it.

Mass production. Guaranteed.

Once you've accepted a prototype from Fujitsu, you can put all your production worries aside. Our design system drives devices to match the production process. That's guaranteed by 100% AC testing at

frequency, in addition to the standard DC and functional testing. What's more, all wafer fabrication, assembly and testing are done in-house. All this means that you can count on production units that work uniformly.

Combine these failsafe methodologies with our unprecedented quality assurance record, and you've got mass production with the highest quality available. Anywhere.

The right technology.

Finally, consider our experience. We can deliver the precise technology you need to fit your application. Leading edge technology from CMOS to ECL. With more packaging options than you can imagine.

So don't listen to promises. The proof is in our performance. Simulations that match silicon 99.9% of the time. Prototypes that perform to spec the first time. And devices that work uniformly when they're mass produced.

Call our Custom Products Group today at (800) 556-1234, ext. 82; in California (800) 441-2345. Because when your devices are made by Fujitsu, you've really got it made.

CIRCLE NO 97

FUJITSU **FUJITSU**[®]
MICROELECTRONICS INC.

Technology That Works.

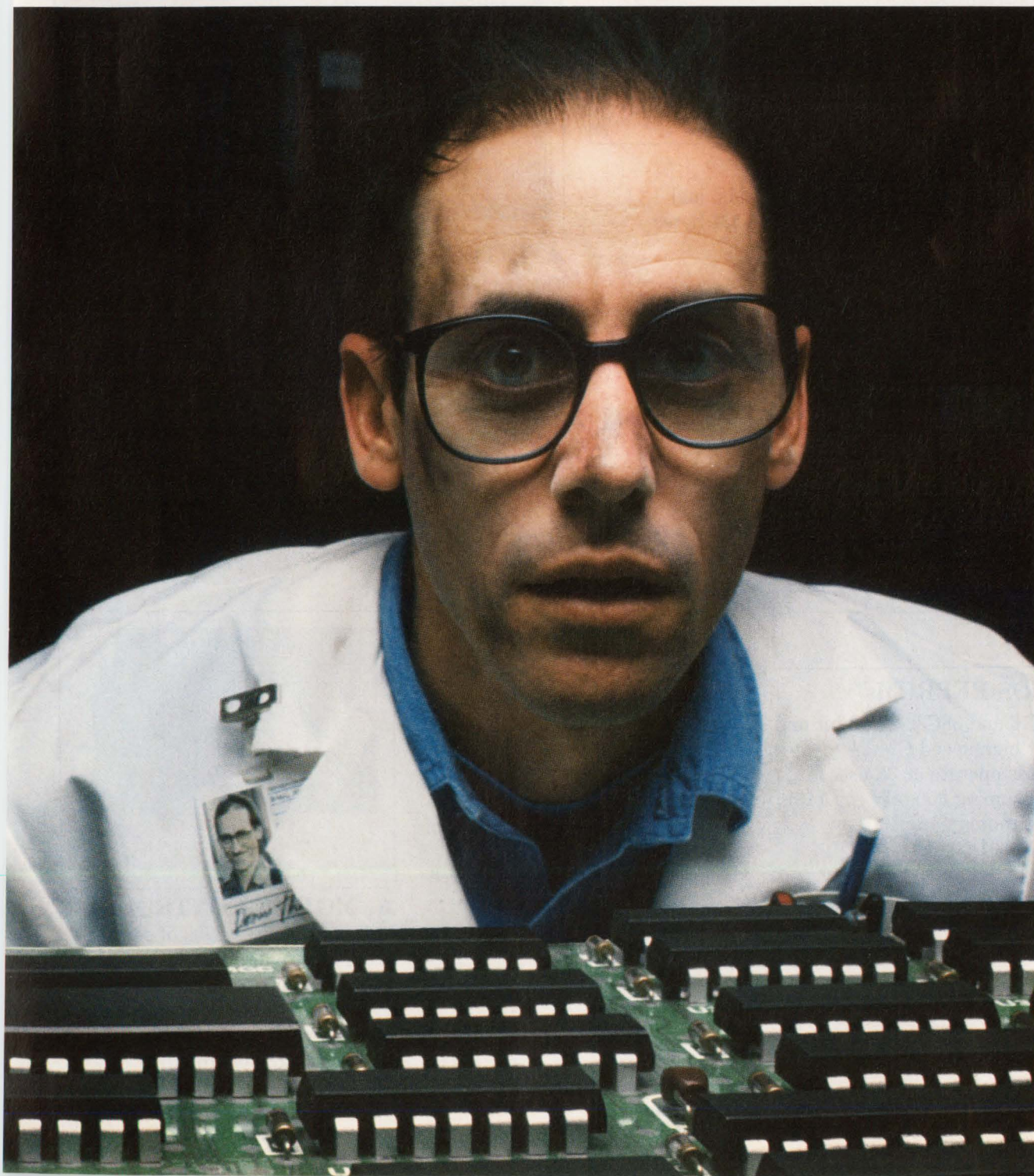

© 1987 Fujitsu Microelectronics, Inc.

READERS' CHOICE

Of all the new products covered in EDN's May 28, 1987, issue, the ones reprinted here generated the most reader requests for additional information. If you missed them the first time, find out what makes them special: Just circle the appropriate numbers on the Information Retrieval Service card, or refer to the indicated pages in our May 28, 1987, issue.



▲ PROM PROGRAMMER

The SE4944 programs PROMs, EPROMs, and EEPROMs having capacities of 16k to 1M bytes (pg 280).

Epotek Corp.
Circle No 605

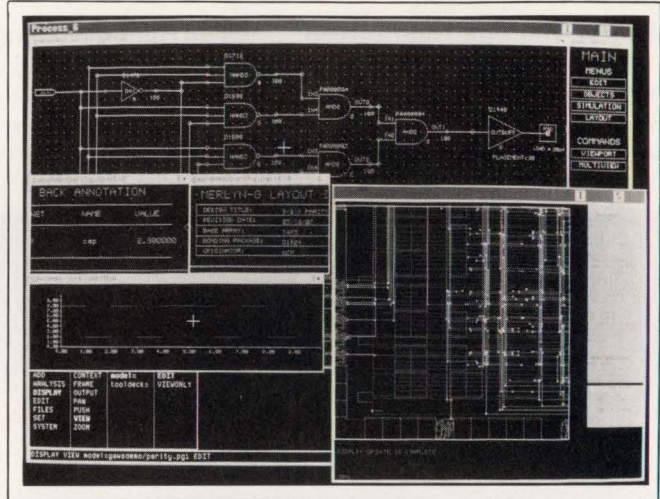

▲ INTEGRATED SOFTWARE

The Gate Array WorkSystem software integrates logic design, circuit simulation, and physical layout for creating and implementing circuit designs on gate arrays from specific foundries (pg 111).

Tektronix CAE Systems Div.
Circle No 603

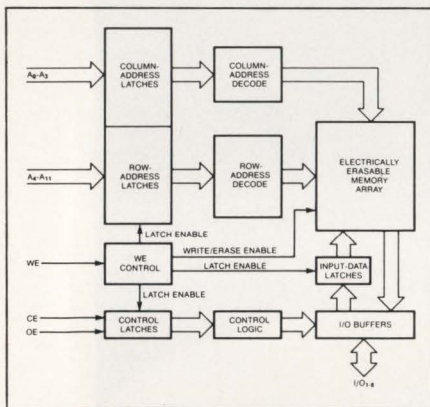

▲ CMOS EEPROMs

The 38C16 and 38C32 2k×8-bit and 4k×8-bit high-speed CMOS EEPROMs operate at 35 nsec while consuming 350 mW (pg 116).

Seeq Technology Inc.
Circle No 601

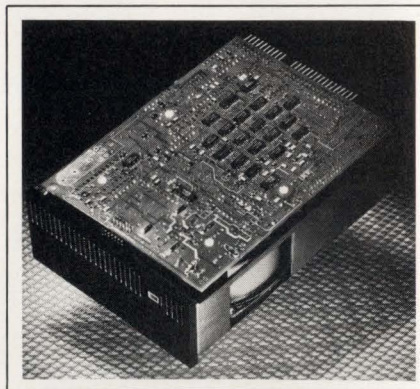

▲ WINCHESTER DRIVE

The LXT-170 stores 170M bytes of unformatted data in a standard 3½-in. package and offers a choice of SCSI- or ESDI-interface versions (pg 119).

Maxtor Corp.
Circle No 602

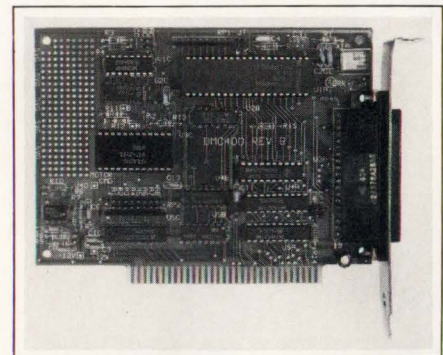

▲ MOTION CONTROLLER

Units in the -10 Series of servo motor controllers feature a digital integrator, programmable torque and error limits, a position latch, and diagnostics (pg 260).

Galil Motion Control Inc.
Circle No 604

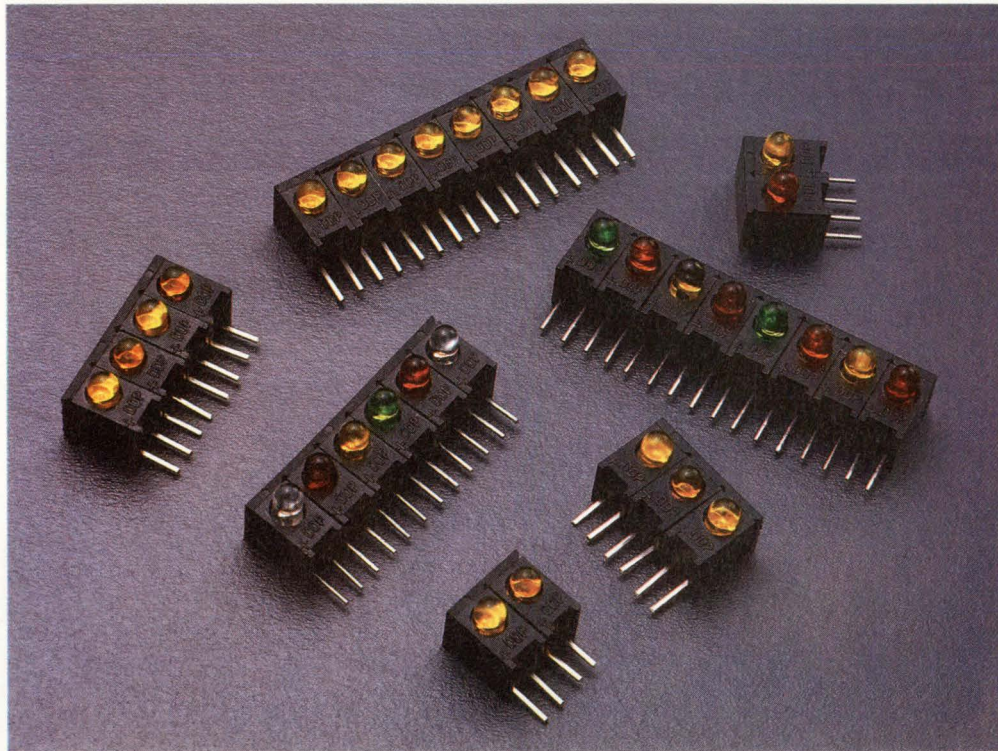

BRILLIANT PREMIERE

High density variable arrays with performance and quality you've never seen before.

For dazzling results with your design applications, make the brilliant choice of the latest advance in variable arrays from Data Display Products. As direct replacements for the Dialight 551 PCB series, they introduce a new performance standard that you can expect from the world leader in high-efficiency LEDs.

Choose from a shining selection of standard to high intensity LEDs in sizes of 1 to 8 modules with 2.4, 5 and 12 volt operation... all with availability guaranteed.

You'll clearly see the difference in precision alignment, easy handling

features, high quality and long lasting reliability.

Make the brilliant choice. Call Data Display, TOLL FREE (800) 421-6815. Within California, call (213) 640-0442. Also ask about our new line of bi-color LEDs.

Send for our free catalog.



301 Coral Circle, El Segundo, California 90245
 (213) 640-0442 TELEEX 664-690
 FAX (213) 640-7639

INTERNATIONAL REPS: Argentina YEL SRL, PH: 541 46 2211, TLX: 390 18605—Australia Ampec, PH: 02 7122466, TLX: 790 27136 AMPEC—Belgium/Holland Klaasing Etc, PH: 01620 81600, TLX: 844 54598 KLBDNL—Denmark Radio Parts, PH: 01 333311, TLX: 855 19613 RPARTDK—France A Jahmichen, PH: 387 59 09, TLX: 842290714—Israel R.C.M. Computers, PH: 03 485192, TLX: 922 361580 IL—Italy Microdata, PH: 0187 988182, TLX: 8432 72070—South Africa Liberty Etec, PH: 52 7637/8/9, TLX: 960 429435 SA—Spain Belatron, PH: 6932421, TLX: 831 23911 PCOE—United Kingdom Marl Int'l, PH: 0229 52430, TLX: 851 65100 MARLG—West Germany/Austria Kuhn GmbH, PH: 06235 5662, TLX: 841 464766 KUHND

CIRCLE NO 96

**FE FIFFO
FUM.**

The next huge step from the FIFO giant.

Announcing the new 2K x 9 MK4503 from Thomson-Mostek – our highest density BiPORT™ FIFO since the MK4501.

Like the 4501, the MK4503 is a first-in/first-out CMOS buffer memory. With its DIP packaging, the 4503 provides pin-for-pin replacement of our industry-standard 4501. And like its predecessor, the 4503 offers a CMOS RAM-based BiPORT architecture, allowing the two ports to operate at completely independent data rates and providing a simultaneous read/write capability.

What makes the MK4503 a true giant is its incredible 2K x 9 architecture – four times the density of the 4501. Making the MK4503 the new industry-standard CMOS FIFO.

And because the 4503 is memory-based, opposed to shift-register-based, you can implement very large FIFO arrays without experiencing ripple-through delay. Plus asynchronous read and write operations with no timing penalties.

What's more, the MK4503 now offers a Half-Full flag, plus the standard Full and Empty warning flags to prevent data overflow and underflow. Allowing you to monitor your status at all times, without external hardware or software counters.

So if you thought the MK4501 was a small miracle, get ready for our latest giant step forward. The MK4503 BiPORT FIFO from Thomson-Mostek. The people who also bring you the world's fastest FIFO – the MK4505.

The MK4503 is available now. For sampling information, contact your distributor or write Thomson Components-Mostek Corporation, 1310 Electronics Drive, Carrollton, Texas 75006, MS2205. Or call (214) 466-6836.

BiPORT Family Features

| | MK4501 (512 x 9) | MK4503 (2K x 9) |
|--|----------------------------------|----------------------------------|
| First-in/First-out buffer | X | X |
| Independent data rates | X | X |
| Cycle rate | up to 12.5 MHz | up to 15.4 MHz |
| Access time range | 65ns-200ns | 50ns-200ns |
| Simultaneous read & write capability | X | X |
| Fully asynchronous | X | X |
| Fully expandable by word width & depth | X | X |
| Empty and full warning flags | X | X |
| Half-full status flag | | X |
| Packaging available | 28-pin DIP & 32-pin K PLCC | 28-pin DIP & 32-pin** PLCC |
| TTL compatible | X | X |



**To be introduced.

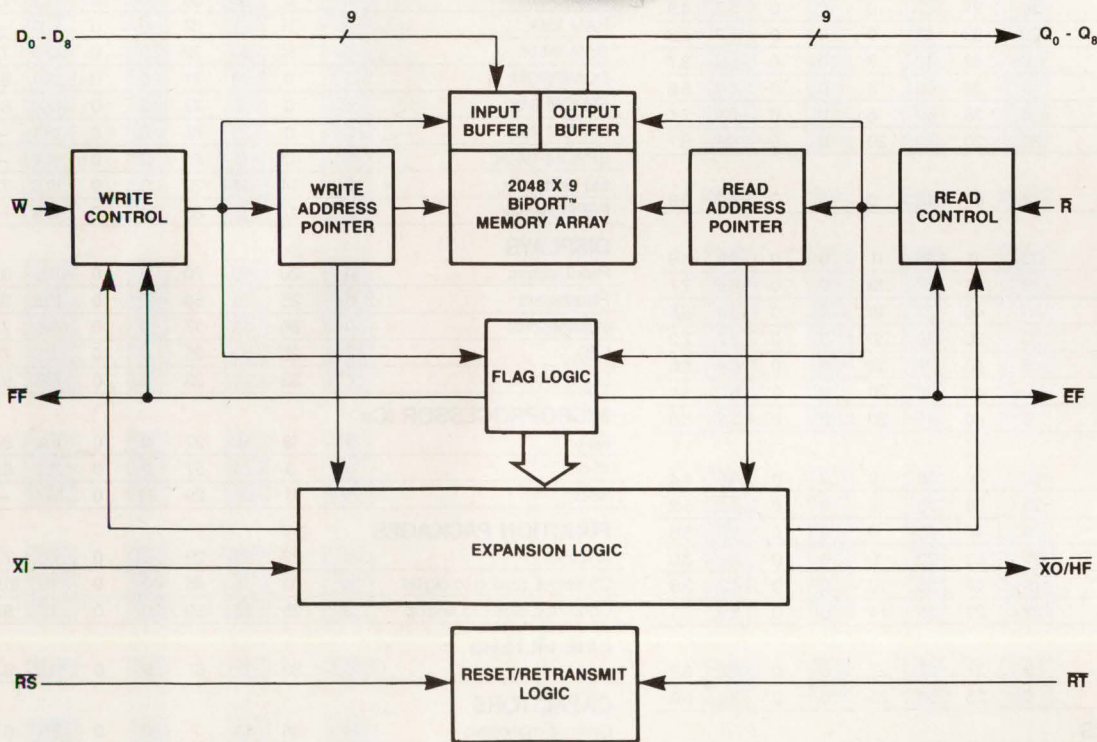

MK4503 Block Diagram

U.S. and Canadian Sales Offices

Western Area:

Santa Clara, CA
408/970-8585
Irvine, CA
714/250-0455
Woodland Hills, CA
818/887-1010
Seattle, WA
206/632-0245
Longmont, CO
303/449-9000
Scottsdale, AZ
602/998-1580
Tigard, OR
503/620-5517

Eastern Area:

Burlington, MA
617/273-3310
Marlton, NJ
609/596-9200
Huntsville, AL
205/830-9036
Poughkeepsie, NY
914/454-8813
Dublin, OH
614/761-0676
Norcross, GA
404/447-8386

Central Area:

Carrollton, TX
214/466-8844
Bloomington, MN
612/831-2322
Schaumburg, IL
312/397-6550
Austin, TX
512/451-4061

Canada:

Montreal, Quebec
514/288-4148
Brampton, Ontario
416/454-5252

Semiconductor Distributors

Add Electronics
Advent Electronics
All American Semiconductor
Almac Electronics Corp.
Almo Electronics, Inc.
Future Electronics
Greene-Shaw
Hammond Electronics
Integrated Electronics Corp.
ITAL Sales
Kierulff Electronics
Lionex Corp.
Marshall Industries
Nu-Horizons Electronics
Pioneer Technologies Group
Pioneer-Standard Quality Components (Q.C.-SW)
Quality Components (Q.C.-SE)
ITT Microcomponents
Schweber Electronics
Solid State, Inc.
Zentronics
Zeus Components, Inc.



In addition to FIFOs, Thomson-Mostek manufactures a broad selection of MOS and bipolar devices for both commercial and military applications: microcomponents, ASIC, memories, telecom/datacom and linear circuits as well as Discrete, RF and microwave transistors and passive components. BiPORT is a trademark of Thomson Components-Mostek Corp.

LEADTIME INDEX

Percentage of respondents

| ITEM | Percentage of respondents | | | | | | Average (weeks) | |
|-------------------------------|---------------------------|-----------|------------|-------------|-------------|---------------|------------------------------|-----------------|
| | Off the shelf | 1-5 weeks | 6-10 weeks | 11-20 weeks | 21-30 weeks | Over 30 weeks | Last month's average (weeks) | Average (weeks) |
| TRANSFORMERS | | | | | | | | |
| Toroidal | 0 | 29 | 57 | 14 | 0 | 0 | 7.6 | 9.5 |
| Pot-Core | 0 | 50 | 33 | 17 | 0 | 0 | 6.8 | 8.8 |
| Laminate (power) | 0 | 25 | 33 | 34 | 8 | 0 | 10.7 | 7.1 |
| CONNECTORS | | | | | | | | |
| Military panel | 0 | 20 | 40 | 0 | 0 | 40 | 16.2 | 10.7 |
| Flat/Cable | 25 | 38 | 37 | 0 | 0 | 0 | 4.1 | 5.7 |
| Multipin circular | 11 | 34 | 22 | 22 | 0 | 11 | 9.7 | 10.3 |
| PC | 11 | 34 | 22 | 22 | 0 | 11 | 9.7 | 5.8 |
| RF/Coaxial | 11 | 34 | 33 | 22 | 0 | 0 | 7.1 | 9.0 |
| Socket | 8 | 42 | 33 | 17 | 0 | 0 | 6.5 | 5.7 |
| Terminal blocks | 8 | 54 | 31 | 7 | 0 | 0 | 5.3 | 4.6 |
| Edge card | 11 | 33 | 45 | 11 | 0 | 0 | 6.3 | 6.6 |
| Subminiature | 0 | 42 | 33 | 17 | 8 | 0 | 8.6 | 8.2 |
| Rack & panel | 0 | 50 | 33 | 17 | 0 | 0 | 6.8 | 7.7 |
| Power | 0 | 33 | 34 | 33 | 0 | 0 | 8.8 | 8.4 |
| PRINTED CIRCUIT BOARDS | | | | | | | | |
| Single-sided | 7 | 22 | 57 | 7 | 0 | 7 | 8.5 | 5.1 |
| Double-sided | 0 | 47 | 47 | 6 | 0 | 0 | 6.2 | 6.7 |
| Multilayer | 0 | 15 | 54 | 31 | 0 | 0 | 9.5 | 8.7 |
| Prototype | 0 | 83 | 17 | 0 | 0 | 0 | 3.8 | 3.8 |
| RESISTORS | | | | | | | | |
| Carbon film | 31 | 25 | 38 | 6 | 0 | 0 | 4.7 | 3.6 |
| Carbon composition | 36 | 27 | 37 | 0 | 0 | 0 | 3.7 | 4.9 |
| Metal film | 20 | 33 | 47 | 0 | 0 | 0 | 4.7 | 4.3 |
| Metal oxide | 8 | 42 | 42 | 8 | 0 | 0 | 5.9 | 3.7 |
| Wirewound | 8 | 38 | 46 | 8 | 0 | 0 | 6.0 | 5.6 |
| Potentiometers | 6 | 38 | 50 | 6 | 0 | 0 | 6.1 | 7.4 |
| Networks | 20 | 20 | 40 | 20 | 0 | 0 | 6.9 | 5.7 |
| FUSES | | | | | | | | |
| | 18 | 36 | 46 | 0 | 0 | 0 | 4.7 | 3.6 |
| SWITCHES | | | | | | | | |
| Pushbutton | 33 | 11 | 45 | 11 | 0 | 0 | 5.6 | 4.9 |
| Rotary | 18 | 27 | 37 | 18 | 0 | 0 | 6.5 | 7.7 |
| Rocker | 9 | 46 | 27 | 18 | 0 | 0 | 6.4 | 6.5 |
| Thumbwheel | 20 | 20 | 30 | 30 | 0 | 0 | 7.7 | 7.2 |
| Snap action | 9 | 46 | 27 | 18 | 0 | 0 | 6.4 | 5.6 |
| Momentary | 10 | 40 | 30 | 20 | 0 | 0 | 6.7 | 5.1 |
| Dual in-line | 0 | 40 | 40 | 20 | 0 | 0 | 7.5 | 6.6 |
| WIRE AND CABLE | | | | | | | | |
| Coaxial | 30 | 40 | 30 | 0 | 0 | 0 | 3.6 | 4.4 |
| Flat ribbon | 23 | 39 | 38 | 0 | 0 | 0 | 4.2 | 5.2 |
| Multiconductor | 9 | 46 | 45 | 0 | 0 | 0 | 5.0 | 5.8 |
| Hookup | 27 | 53 | 20 | 0 | 0 | 0 | 3.2 | 3.0 |
| Wire wrap | 18 | 46 | 36 | 0 | 0 | 0 | 4.3 | 3.8 |
| Power cords | 21 | 29 | 36 | 14 | 0 | 0 | 5.9 | 5.1 |
| POWER SUPPLIES | | | | | | | | |
| Switching | 9 | 27 | 37 | 27 | 0 | 0 | 8.0 | 8.6 |
| Linear | 0 | 25 | 50 | 25 | 0 | 0 | 8.6 | 6.9 |
| CIRCUIT BREAKERS | | | | | | | | |
| | 10 | 40 | 40 | 10 | 0 | 0 | 6.0 | 6.1 |
| HEAT SINKS | | | | | | | | |
| | 17 | 58 | 17 | 8 | 0 | 0 | 4.4 | 5.8 |
| RELAYS | | | | | | | | |
| General purpose | 0 | 54 | 23 | 23 | 0 | 0 | 7.0 | 6.8 |
| PC board | 0 | 33 | 9 | 58 | 0 | 0 | 10.7 | 8.6 |

| ITEM | Percentage of respondents | | | | | | Average (weeks) | |
|-------------------------------------|---------------------------|-----------|------------|-------------|-------------|---------------|------------------------------|-----------------|
| | Off the shelf | 1-5 weeks | 6-10 weeks | 11-20 weeks | 21-30 weeks | Over 30 weeks | Last month's average (weeks) | Average (weeks) |
| RELAYS | | | | | | | | |
| Dry reed | 0 | 38 | 25 | 37 | 0 | 0 | 8.9 | 8.5 |
| Mercury | 0 | 33 | 34 | 33 | 0 | 0 | 8.8 | 9.8 |
| Solid state | 11 | 33 | 22 | 34 | 0 | 0 | 7.9 | 10.1 |
| DISCRETE SEMICONDUCTORS | | | | | | | | |
| Diode | 22 | 22 | 28 | 28 | 0 | 0 | 7.2 | 5.3 |
| Zener | 20 | 20 | 33 | 27 | 0 | 0 | 7.4 | 5.5 |
| Thyristor | 0 | 27 | 46 | 27 | 0 | 0 | 8.7 | 8.0 |
| Small signal transistor | 7 | 27 | 40 | 26 | 0 | 0 | 8.1 | 6.3 |
| MOSFET | 0 | 36 | 27 | 37 | 0 | 0 | 8.9 | 7.8 |
| Power, bipolar | 0 | 30 | 20 | 50 | 0 | 0 | 10.3 | 7.8 |
| INTEGRATED CIRCUITS, DIGITAL | | | | | | | | |
| Advanced CMOS | 0 | 31 | 31 | 38 | 0 | 0 | 9.3 | 6.5 |
| CMOS | 6 | 24 | 23 | 47 | 0 | 0 | 9.9 | 6.5 |
| TTL | 0 | 25 | 44 | 31 | 0 | 0 | 9.1 | 6.3 |
| LS | 0 | 29 | 41 | 30 | 0 | 0 | 8.7 | 6.1 |
| INTEGRATED CIRCUITS, LINEAR | | | | | | | | |
| Communication/Circuit | 0 | 38 | 37 | 25 | 0 | 0 | 8.0 | 7.0 |
| OP amplifier | 0 | 36 | 29 | 35 | 0 | 0 | 8.9 | 7.7 |
| Voltage regulator | 0 | 38 | 31 | 31 | 0 | 0 | 8.4 | 5.9 |
| MEMORY CIRCUITS | | | | | | | | |
| RAM 16k | 11 | 0 | 33 | 56 | 0 | 0 | 11.3 | 7.5 |
| RAM 64k | 11 | 0 | 33 | 56 | 0 | 0 | 11.3 | 7.9 |
| RAM 256k | 11 | 11 | 11 | 67 | 0 | 0 | 11.6 | — |
| RAM 1M-bit | 0 | 14 | 14 | 72 | 0 | 0 | 12.6 | 7.0 |
| ROM/PROM | 0 | 0 | 29 | 71 | 0 | 0 | 13.4 | 8.3 |
| EPROM 64k | 18 | 0 | 9 | 73 | 0 | 0 | 12.0 | 8.6 |
| EPROM 256k | 11 | 0 | 22 | 67 | 0 | 0 | 12.1 | — |
| EPROM 1M-bit | 0 | 17 | 0 | 66 | 17 | 0 | 15.1 | — |
| EEPROM 16k | 0 | 14 | 14 | 72 | 0 | 0 | 12.6 | 7.3 |
| EEPROM 64k | 0 | 17 | 0 | 83 | 0 | 0 | 13.4 | — |
| DISPLAYS | | | | | | | | |
| Panel meters | 0 | 20 | 60 | 20 | 0 | 0 | 8.5 | 8.2 |
| Fluorescent | 0 | 25 | 25 | 50 | 0 | 0 | 10.5 | 9.1 |
| Incandescent | 0 | 50 | 33 | 17 | 0 | 0 | 6.8 | 7.9 |
| LED | 17 | 25 | 33 | 25 | 0 | 0 | 7.3 | 7.4 |
| Liquid crystal | 0 | 33 | 34 | 33 | 0 | 0 | 8.8 | 9.1 |
| MICROPROCESSOR ICs | | | | | | | | |
| 8-bit | 9 | 18 | 46 | 27 | 0 | 0 | 8.4 | 9.0 |
| 16-bit | 14 | 0 | 29 | 57 | 0 | 0 | 11.1 | 6.8 |
| 32-bit | 29 | 0 | 28 | 29 | 14 | 0 | 10.4 | — |
| FUNCTION PACKAGES | | | | | | | | |
| Amplifier | 14 | 29 | 28 | 29 | 0 | 0 | 7.6 | 7.7 |
| Converter, analog to digital | 11 | 33 | 11 | 45 | 0 | 0 | 8.8 | 10.9 |
| Converter, digital to analog | 13 | 25 | 12 | 50 | 0 | 0 | 9.5 | 9.5 |
| LINE FILTERS | | | | | | | | |
| | 0 | 33 | 0 | 67 | 0 | 0 | 11.3 | 8.3 |
| CAPACITORS | | | | | | | | |
| Ceramic monolithic | 14 | 36 | 43 | 7 | 0 | 0 | 5.6 | 6.1 |
| Ceramic disc | 17 | 42 | 33 | 8 | 0 | 0 | 5.2 | 8.9 |
| Film | 15 | 31 | 39 | 15 | 0 | 0 | 6.4 | 6.8 |
| Aluminum Electrolytic | 7 | 36 | 29 | 28 | 0 | 0 | 7.8 | 7.8 |
| Tantalum | 0 | 50 | 25 | 25 | 0 | 0 | 7.4 | 7.1 |
| INDUCTORS | | | | | | | | |
| | 0 | 38 | 37 | 25 | 0 | 0 | 8.0 | 6.4 |

Source: *Electronics Purchasing* magazine's survey of buyers

The HP 8175A is a great stimulus companion to logic analyzers used in response testing.

You spend a lot of time evaluating response instruments. What if you had a stimulus that measured up to your response?

Now you do.

The HP 8175A Signal Generator produces thousands of digital and analog signals, letting you emulate missing portions of your system . . . and test your design under many different operating conditions.

It's an advanced parallel and serial data generator that doubles as an analog dual arbitrary waveform generator.

You get 24 parallel channels at 50 Mbits/s. 2 serial channels at 100 Mbits/s. 2 analog channels at 50 Mbits/s. Plus an 8-bit input

trigger and 8-bit output flags for easy interaction with your DUT. Prompts to guide you. Data editing capabilities to save you time. And more.

Just pair up the new HP 8175A Signal Generator with the HP 1630/31 Logic Analyzer or other response instrument. You'll have a powerful stimulus-response solution to make you more productive today and meet your test needs tomorrow as well.

Call HP today!

Add a great stimulus to your test setup. For more information on the HP 8175A, contact your local HP sales office listed in the telephone directory white pages. Ask for the electronic instruments department.



CIRCLE NO 8

Now, a stimulus as good as your response!

we never stop asking "What if..."



HP-IB: Not just IEEE-488, but the hardware, documentation and support that delivers the shortest path to a measurement system.

EI15704

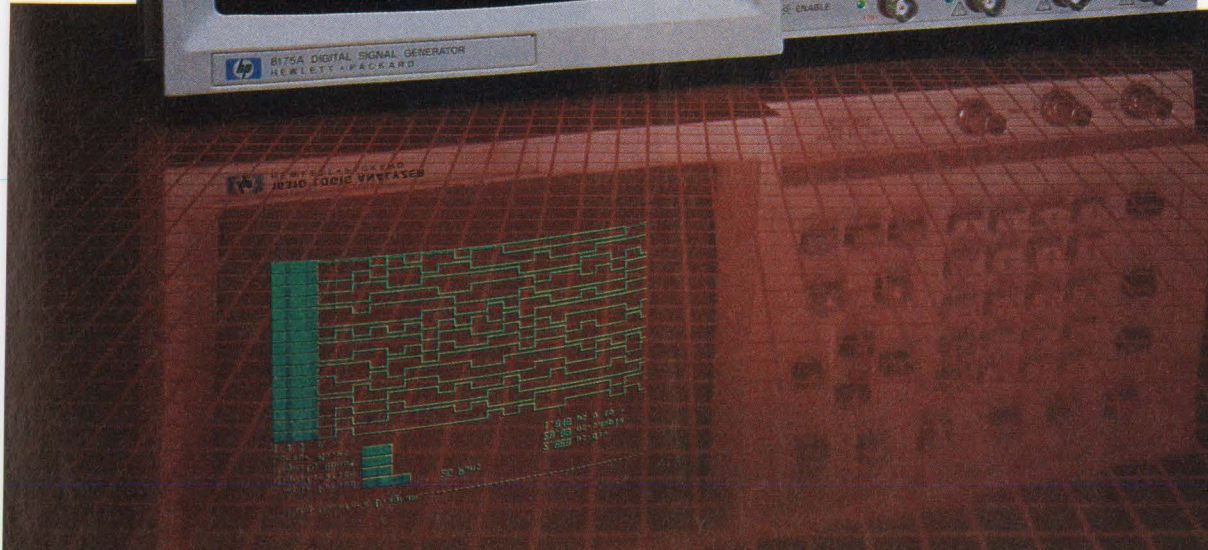

WHO CAN INTEGRATE FOUR 100V DMOS SWITCHES IN A SINGLE SMART POWER CHIP?

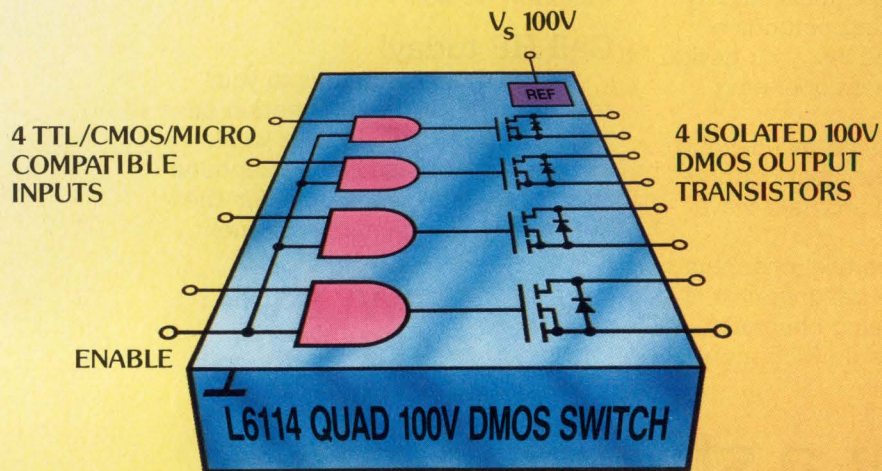

Four fully isolated DMOS transistor switches with all the associated control and interface circuits. For less than \$3 in quantities of 10K or more. That's what you get with the SGS L6114. Plus 70 watts total output power from a standard outline DIP package.

Can anyone else deliver anything like it?

The secret is SGS' Bipolar, CMOS, and DMOS smart power technology, which allows complete isolation of the output power DMOS transistors. And thanks to the high efficiency of the outputs, by using 6 of the package pins as a dedicated heat path, a small area of PCB copper dissipates the heat.

The L6114, with its 200kHz switching

capability, is aimed at switch mode applications where multiple high current inductive loads are interfaced with low level logic. Unipolar stepper motor driving and needle solenoid driving in matrix printers are typical examples.

The L6114 is just one of a whole range of ICs based on SGS' Multipower-BCD™ technology. This unique smart power technology is bringing you a whole new generation of devices with improved performance levels and application potential.

| Absolute Maximum Ratings | |
|--------------------------|------------------------|
| Vdss max | 100V |
| Iout max | 1.5A dc 5A peak |
| Ron | 0.7ohms |
| Fswitch | 200kHz |
| Package | Powerdip 14 + 3 + 3 |

THE BRIGHTER POWER™

SGS' exclusive Multipower-BCD technology—that's integrated Bipolar, CMOS, DMOS—has a lot more to offer. What other smart power IC technology isolates the DMOS output power transistors to let you connect as many as you need on a chip in any way you like? None.

That's just one example of how smart SGS power really is. And the L6114 is just one of many SGS smart power products.

Why not get the full story on SGS Multipower-BCD technology plus full data on the L6114? Call 602/867-6259 now or write SGS Semiconductor Corporation, 1000 E. Bell Road, Phoenix, Arizona 85022. After all, the brighter your smart power source, the brighter your design's future.



Of course.

PC-based GPIB control and data-acquisition



Powerful hardware and software tools make it easy for you to control a set of IEEE-488 instruments with a personal computer. (Photo courtesy National Instruments)

Sophisticated PC-based hardware and software tools are now blurring the distinctions between instrument control and data acquisition. You can use these tools to turn your IEEE-488 instruments into a data-acquisition system that you control from your PC. IEEE-488 instruments and PC-

based data-acquisition systems have traditionally provided very different services. The IEEE-488 or GPIB (general-purpose interface bus), which has long been recognized as the premier instrumentation bus, provides for the transfer of digital data among as many as 14 programmable instruments by using standardized sig-

products

J D Mosley, Regional Editor

With a well-planned combination of hardware and software tools for your personal computer, you can turn your set of IEEE-488 (GPIB) instruments into a PC-controlled data-acquisition system. To select the right PC-to-GPIB interface for your project, you'll need to consider such factors as controller intelligence, software sophistication, and system performance.

nals, techniques, and a single interface to the party-line GPIB. PC-based data-acquisition systems provide signal conditioning, A/D and D/A conversion, real-time data monitoring, and multiple inputs for as many as 32 channels on a standard IBM PC-compatible computer.

However, by adding a carefully selected suite of hardware and software tools to your PC, you can integrate GPIB instrumentation control with a PC-based data-acquisition system. Your system thus becomes a multiprogramming environment that lets you perform sophisticated test and measurement tasks. For instance, your laboratory-grade instruments will be able to provide precise measurements in the pico-ampere and microvolt range, as well as 24-bit A/D resolution and high-speed transient measurements that are accurate to eight bits at 1 MHz. Also, by using an IEEE-488 interface to control the instruments via a desktop PC, you'll obtain additional data-storage and -analysis capabilities that naturally complement any test and measurement task.

Further, the manufacturers of these hardware and software products have recently developed tools that allow you to use the IEEE-488 link for more than just controlling instruments. Some of these newly introduced products

can provide you with more than rudimentary signal conditioning. Of course, for applications requiring 16-bit-wide DMA (direct-memory-access) transfers or 32 I/O lines, you'll still need to use dedicated data-acquisition boards. But some of the available software products are sophisticated enough that they can treat the input from multiple IEEE-488 boards as separate channels and can even provide different scale factors, sampling rates, and triggering conditions for each.

Windows simplify control

One such software product is LabWindows, which National Instruments expects to release in September. LabWindows lets you interactively control instruments, develop applications, and edit instrument-library modules. The product actually gives you several libraries: a graphics library, a digital-signal-processing (DSP) library, an instrument library, and a data-formatting library. LabWindows uses a proprietary internal format for command interpretation, but it displays the commands on your PC's CRT in the syntax of either C or Basic. LabWindows can also generate source code in C or Basic from your interactive session for incorporation in an application program.

You develop a program by entering the LabWindows program win-

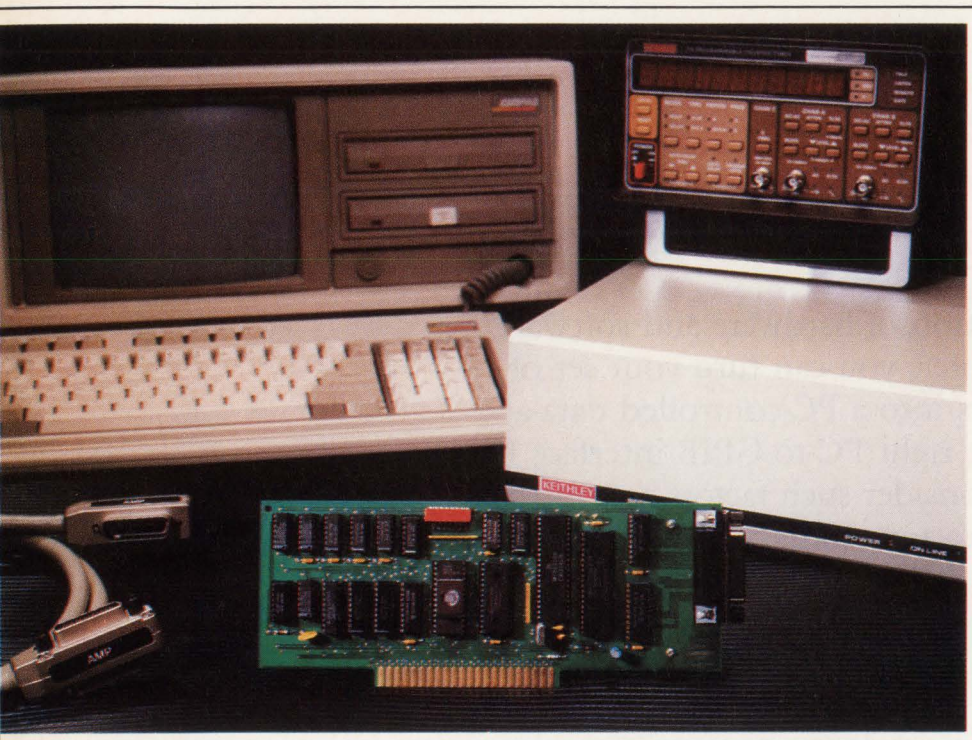

Unlike IEEE-488 cards that plug directly into your PC, Keithley Instruments' 500-IEEE card plugs into the System 570 data-acquisition unit. This configuration facilitates the integration of instrument control with data acquisition without monopolizing multiple expansion slots in your computer.

dow, typing in program lines, and selectively executing them. You can also invoke pull-down menus and select library functions and parameters to generate a sequence of code that you can add to the program window. The instrument library lets you perform high-level programming of GPIB instruments. You can create and test an instrument-control program without knowing specific details of the instrument or of GPIB programming. A window can mimic a GPIB instrument's front panel with slide controls, binary controls, numeric-input boxes, and string-input boxes. By moving switches with the cursor keys or mouse, or by entering values in the numeric or string boxes, you can set up an instrument and manipulate its controls.

The LabWindows graphics library lets you produce a variety of graphs, plots, and charts. It allows you to zoom and pan and to superimpose graphs on one another. You can scale and rotate text generated with multiple fonts and create printouts without leaving your application program.

The DSP library includes such functions as array arithmetic, curve fitting, scaling, FFTs, and

inverse FFTs. By using LabWindows' data-formatting library, you can transform data from one format to another, thus reducing the programming time for instruments that transfer data in peculiar formats. The software package also lets you call libraries from QuickBasic and Microsoft C. LabWindows starts at \$395.

Another product that provides IEEE-488 control via software windows is Summation's TestWindows. Although the TestWindows software is a DOS-based ATE program, in order to use it you must also purchase the company's SigmaSeries TestStation and connect it to your PC. The TestStation is a \$9950 chassis with an embedded 68000 μ P for internal control, 512k bytes of RAM, 12 slots for instrumentation-function modules, an IEEE-488 interface with DMA, seven synchronization buses, 10 high-frequency buses, a power supply, DOS, and TestWindows. TestWindows alone costs \$1950 and includes the Test-Basic programming language, Microsoft Windows software, Test-Basic Editor, an IEEE-488 window generator, debugging tools, documentation tools, and manuals.

A unique approach to GPIB control is to use a DOS-installable device driver that automatically loads your IEEE-488 control software each time you boot your PC. By using this technique, IOtech's Driver488 software functions as a utility. The technique also provides software compatibility with Basic, C, and Fortran, so when you use Driver488 you don't need separate device drivers for those languages. For applications written in Basic, Driver488 allows your program to vector to a subroutine upon a service request.

Driver488 uses a proprietary language that resembles the language used for HP Series 80 IEEE-488 controllers. Driver488 includes built-in error checking and time-out indications. The software works with the manufacturer's GPIB interface boards for IBM PC-compatible computers and for similar boards manufactured by National Instruments and Capital Equipment Corp. You can also order a version for use with the company's Personal488/2, a new board for the IBM Personal System/2. Driver488 starts at \$195.

Ziatech Corp also offers DOS-installable driver software for its GPIB controller cards. The driver

Advancements in hardware and software products for the IEEE-488 bus are pushing GPIB control beyond the realm of mere instrumentation.

is called DOS.GPIB, and it gives your existing development tools and applications programs access to your IEEE-488 controllers without the need for additional programming. You can configure DOS.GPIB as a controller or as a talker/listener. DOS.GPIB costs \$250; the company requires no licensing fees for multiple-system users.

Database organizes input

The latest software package from HP for IEEE-488 data management is especially suited to HP's hardware products, such as the HP Vectra PC, which comes with an IEEE-488 interface for instrument control. The \$1450 DACQ/PC program provides a vectorized database for data col-

lected from IEEE-488 instruments, your computer's keyboard, and program results. DACQ/PC accommodates data-acquisition applications by including routines for thermocouple, RTD, and thermistor temperature linearizations. DACQ/PC also includes subroutines for calculating microstrain from strain-gauge cards.

Furthermore, the software facilitates process control by tuning and executing as many as 10 proportional-integral-derivative (PID) loops with one subroutine call. You can also use DACQ/PC to schedule as many as 99 prioritized tasks, to transfer data to other software programs (such as Lotus 1-2-3, WordStar, or dBaseIII), and to analyze your data via statistics, scaling, linearizations, and tabular

conversions. You can plot your results on multiple-trace graphs or print them out as strip charts or formatted data.

Lotus Development Corp has introduced a program called Measure that links the GPIB and data-acquisition functions with spreadsheet analysis for technical applications. Although the spreadsheet was originally developed for financial-analysis applications, its format is also suitable for use in technical data analysis. Measure runs under Lotus 1-2-3, and it provides device drivers that let you import data directly from your instruments to a spreadsheet. You can then analyze and graphically display your data by using Lotus 1-2-3's math and graphics functions.

Featuring a screen full of application windows, the SigmaSeries TestStation from Summation provides an integrated multi-tasking environment that supplies IEEE-488 device windows, a TestBasic editor window, a debugging window, and output windows.



The GPIB-PCII interface for the new IBM Personal System/2 Model 30 (which is compatible with the IBM PC) specs data-transfer speeds exceeding 300k bytes/sec. The vendor, National Instruments, expects to offer versions for the PS/2 Models 50, 60, and 80 in September.

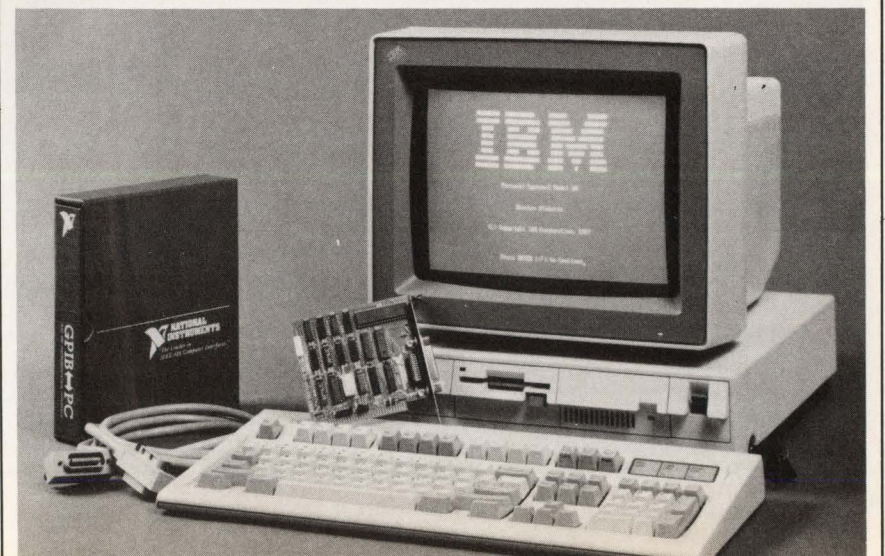

Window-oriented software packages are simplifying test and measurement applications by letting engineers monitor several tasks at once.

The \$495 menu-driven program uses the Lotus 1-2-3 macro language to capture keystrokes, automate repetitive tasks, and parse incoming data. If you are an experienced macro-language programmer, you can provide commands to make the system prompt the user for variables, perform file opera-

tions, facilitate decision making and branching, and provide screen and window control.

DSP Systems bills its DaDisp Worksheet program as "the first technical spreadsheet for digital signal analysis." Like Measure, DaDisp is a menu-driven program that lets you solve math problems,

analyze data, perform "what-if" manipulations, generate graphs, and organize data. However, DaDisp has the sophistication to handle signal editing, waveform generation, FFT analysis, and peak finding. Furthermore, this package performs real and complex arithmetic and carries engineering

IEEE-488 CONTROLLER BOARDS FOR IBM PCs AND COMPATIBLE COMPUTERS

| MANUFACTURER | MODEL | PRICE | SYSTEM BUS | DATA RATE (BYTES/SEC) | RAM CAPACITY |
|------------------------|---------------|-------|---------------|-----------------------|---------------------------|
| CAPITAL EQUIPMENT CORP | 4x488 | \$795 | PC | 800k | 4M BYTES (OPTIONAL) |
| | PC-488 | \$395 | PC | 800k | 8kx8-BIT CACHE (OPTIONAL) |
| IOTECH INC | GP488A | \$295 | PC | 300k | |
| | LPT488 | \$295 | PC | N/A | |
| | PERSONAL488 | \$395 | PC | 300k | |
| | PERSONAL488/2 | \$500 | MICRO-CHANNEL | 250k | |
| KEITHLEY INSTRUMENTS | 500-IEEE | \$650 | PC | N/A | |
| NATIONAL INSTRUMENTS | GPIB-PCII | \$395 | PC | 300k | |
| | GPIB-PCIII | \$795 | PC | 1M | |
| | MC-GPIB | \$495 | MICRO-CHANNEL | 1M | |
| SCIENTIFIC SOLUTIONS | IEEE488 | \$395 | PC | 225k | |
| | IEEE488-LM | \$355 | PC | 300k | |
| ZIATECH | ZT 2 | \$395 | MICRO-CHANNEL | | |
| | ZT 1444 | \$350 | PC | 450k | |
| | ZT 1488A | \$449 | PC | 450k | |

A=MICROSOFT'S BASIC A
 B=MICROSOFT'S GW BASIC
 C=MICROSOFT'S COMPILED BASIC
 D=MICROSOFT'S QUICK BASIC
 E=MICROSOFT'S FORTRAN
 F=MICROSOFT'S PASCAL
 G=MICROSOFT C
 H=BORLAND INTERNATIONAL'S TURBO PASCAL
 I=MANX SOFTWARE SYSTEMS' AZTEC C

J=LOTUS'S MEASURE
 K=MACMILLAN SOFTWARE'S ASYST
 L=LABORATORY TECHNOLOGIES' LABTECH NOTEBOOK
 M=TRANSERA'S TBASIC
 N=TRUE BASIC'S TRUE BASIC
 O=ASSEMBLY LANGUAGE
 P=LATTICE C
 Q=DESMET C

units through compound calculations.

DaDisp lets you create mutually dependent windows depicting graphic representations of signal-processing functions: When you load a new signal, each dependent window is automatically updated. The software's pipeline facility lets

you run external programs, such as IEEE-488 drivers and data-acquisition software, from within DaDisp. The IBM PC-compatible version costs \$795. You can order an interactive DaDisp demo disk for \$20.

The IEEE-488 version of Labtech Notebook from Laboratory

Technologies Corp also offers a spreadsheet format. This \$1195 menu-driven program was originally developed to work exclusively with data-acquisition boards, but it's now compatible with National Instruments' IEEE-488 interface board as well. Its functions include process control, real-time graphics display, time stamping, mathematical calculations, and real-time data analysis.

Macmillan Software's Asyst is a 4-module software package that combines data-acquisition analysis and graphing with IEEE-488 support. To obtain GPIB control, you must purchase Modules 1, 2, and 4 for \$1995. Module 1 provides the screen and array editor, graphics and windows, and statistical functions. Module 2 provides data analysis, including simultaneous equation solutions, FFTs, and least-squares approximations. Module 4 incorporates GPIB control and offers such complex bus functions as DMA transfers. You can add data-acquisition I/O (Module 3) for an additional \$200, bringing the total cost of the four modules to \$2195.

Boards vary in intelligence

The recent advancements in GPIB/data-acquisition products aren't limited to the realm of software. A number of hardware developments are also playing a major role in bridging the gap between data acquisition and GPIB instrumentation. Keithley Instruments' 500-IEEE card, for example, has an onboard 68000 μ P. The manufacturer claims that this built-in intelligence makes the board easy to program: The μ P converts high-level IEEE-488 commands from Keithley's simplified Soft500 programming language to GPIB protocol and handshaking.

Instead of requiring the cryptic programming codes used by most

| | ADDITIONAL I/O | SOFTWARE INCLUDED | SOFTWARE COMPATIBILITY | SPECIAL FEATURES |
|--|----------------------------|-----------------------------------|---|---|
| | RS-232C; CENTRONICS | ROM-BASED; PROPRIETARY | A, B, C, D, E, F, G, H, O, P, Q | SHORT-SLOT CARD |
| | | ROM-BASED; PROPRIETARY | A, B, C, D, E, F, G, H, O, P, Q | SHORT-SLOT CARD |
| | | DRIVER488 | J, K, L, M, N A, B, C, D, E, F, G, H, I, J, K, L, M, N | SHORT-SLOT CARD INTERFACES IBM PCs TO IEEE-488 PRINTERS AND PLOTTERS SHORT-SLOT CARD 1M-BYTE/SEC VER- SION AVAILABLE |
| | | | SOFT500 | REQUIRES SERIES 500 OR SYSTEM 570 CHASSIS |
| | | DOS HANDLER & BASICA | A, B, C, D, E, F, G, H, J, K, L, O | |
| | | DOS HANDLER & BASICA | A, B, C, D, E, F, G, H, J, K, L, O | INCLUDES ONBOARD BUS ANALYZER |
| | | DOS HANDLER | A, B, C, D, E, F, G, H, J, K, L, O | PROGRAMMABLE OP- TION SELECT (POS) |
| | | DRIVERS; BASIC | A | OPTIONAL SOFT- WARE SUPPORT PACKAGE |
| | | DRIVERS; BASIC | A, J, K, M | SHORT-SLOT BOARD |
| | | | DOS.GPIB | WATCHDOG TIMER; SECURITY OPTION |
| | | DRIVERS; BASIC; COMPILED BASIC | C, F, G, H, P | SHORT-SLOT CARD |
| | I/O EXPANSION SOCKET | DRIVERS; BASIC; COMPILED BASIC | C, F, G, H, P | SHORT-SLOT CARD |

Many of the GPIB interface cards that fit into the short slot of an IBM PC's chassis offer as many or more features than do their full-size counterparts.

GPIB interfaces, the 500-IEEE card lets you use short, English-like commands similar to those used for HP Series 80 IEEE-488 controllers. For example, a 31-line program that polls a digital multimeter and displays the readings can be written in 13 brief lines of Soft500 text for the 500-IEEE. The card costs \$650, but for PC-based control you must plug it into Keithley's System 570 data-acquisition unit—a chassis that attaches to your IBM PC or compatible computer. A complete system—including a System 570 chassis, a 500-IEEE card, analog I/O, digital I/O, 16 control relays, and Soft500—costs \$2295.

Capital Equipment Corp provides its 4×488 multifunction board with the capacity for as much as 4M bytes of onboard RAM. Memory-management software comes with the board. The 4×488 card also has resident firmware that provides IEEE-488 extensions to Basic, Pascal, C, and Fortran, so you can program instruments without having to add software drivers for those languages. Besides providing an IEEE-488 interface, the board includes an RS-232C (serial) port

and a parallel port, so it lets you test, store, and print results without monopolizing numerous expansion slots in your PC. With 1M bytes of RAM, the 4×488 costs \$895.

The 4×488 board works with third-party software packages and the company's \$95 Co-Operator software. Co-Operator is a menu-driven program that writes IEEE-488 control programs. You can order free demo disks for Co-Operator and Lotus's Measure from Capital Equipment Corp.

National Instruments offers the \$395 GPIB-PCII and the \$795 GPIB-PCIII interface cards for PC-compatible computers. The PCII interface specs data-transfer speeds exceeding 300k bytes/sec. It also offers a choice of six interrupt lines and a choice of three DMA channels. It implements talker, listener, polling, service-request, and remote-programming functions. The GPIB-PCIII interface specs 1M-byte/sec data-transfer rates and includes an onboard IEEE-488 bus analyzer that monitors the status of your IEEE-488 bus com-

mand and data lines for debugging and loop-back testing.

For continuous bus analysis, you can purchase the company's \$995 GPIB-410 bus-analyzer/monitor card, which displays the bus status on the screen with simulated LEDs. The GPIB-410 includes a 256×16-bit buffer to capture bus data in real time, and it lets you store the data in your PC's memory for later review and analysis. You can also use the GPIB-410 to search for glitches or to find bus-timing problems.

Control on a short card

If you're running out of PC expansion slots, consider using the \$355 IEEE-488LM card from Scientific Solutions. This half-slot board offers a full implementation of the IEEE-488 standard and includes a 2-meter IEEE-488 cable. It comes with menu-driven interface software (including the source code), a BIOS printer/plotter driver, a Basic subroutine library, and sample programs. The board's 3-state buffers facilitate data-transfer rates reaching 500k bytes/sec

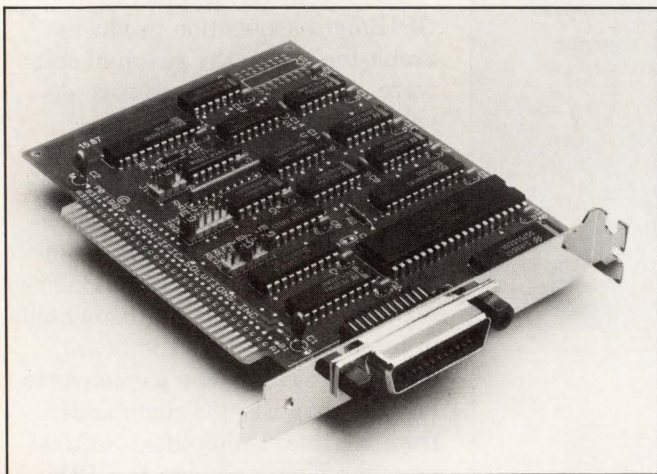

Providing a full implementation of the IEEE-488 standard on a half-slot card, the IEEE-488LM from Scientific Solutions includes menu-driven interface software and is compatible with such software packages as Measure and Asyst.

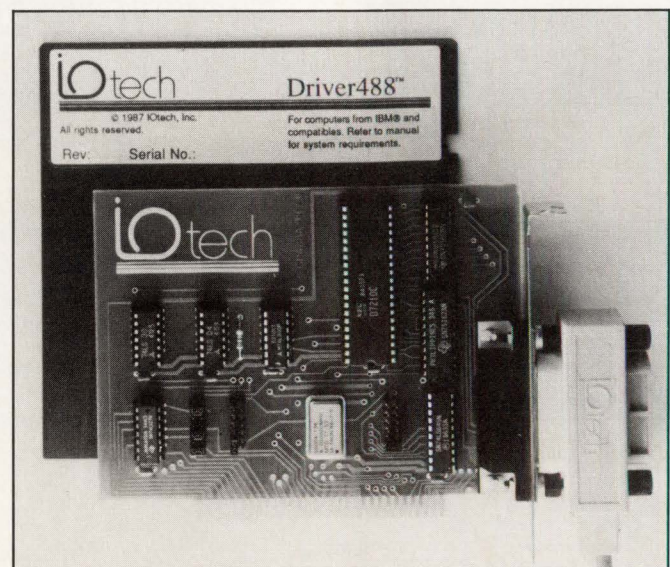

Once you've installed the Driver488 software package in your PC, you never have to load it from disk or reference it in ROM again. A DOS-installable device driver automatically loads Iotech's Driver488 each time you boot your PC.

DMA-transfer rates reaching 1M byte/sec are not uncommon in some of today's sophisticated IEEE-488 controllers.

for devices with open-collector buffers and 2M bytes/sec for devices with 3-state buffers. An onboard oscillator provides the GPIB interface-timing parameters. You can run such third-party programs as Measure or Asyst on this board without making additional software or hardware modifications.

Another short-slot card, the PC-488 from Capital Equipment Corp, comes with resident firmware that adds IEEE-488 control statements to interpreted and compiled Basic, Pascal, C, and Fortran. This ROM-resident software makes your PC ready to run IEEE-488 applications as soon as you plug in the board. Your PC will also be ready to run word-processing and spreadsheet programs with IEEE-488 printers and plotters. The PC-488 runs AutoCAD in conjunction with HP plotters. It can transmit and receive byte arrays as large as 64k bytes each at speeds greater than 800k bytes/sec. You can select from single, demand, or burst DMA in either background or foreground modes. PC-488 costs \$395, including software drivers and a programming and reference manual. The optional 8k×8-bit cache RAM costs \$29.

Intelligent chassis automates lab

Containing an internal Z80A μ P and a unique EPROM-resident operating system, the Taurus Lab from Taurus Computer Products Inc provides IEEE-488 control in conjunction with 64 analog and 64 digital channels for integrated data collection and control. This fixed-configuration system comes with 8k bytes of RAM and buffer storage, so you can adapt the unit for your particular process-control and data-acquisition tasks. Alternatively, you can use the Taurus Lab's preprogrammed features and commands for plug-and-go operation.



Providing a μ P-controlled IEEE-488 interface to your PC and instruments, this A/D-conversion system from Preston Scientific helps you integrate GPIB control with data-acquisition tasks.

As many as 31 Taurus systems can communicate with a host computer over a single multidrop line. Taurus command messages include an embedded system address that lets you direct any command message to any of the linked systems. Taurus Lab sells for \$5732.

Another chassis product comes from Preston Scientific. With the company's MPC, an IEEE-488 interface, you can transmit data to and from your PC-compatible computer, a rack-mountable A/D-converter chassis, and a variety of GPIB-compatible devices. Having a maximum DMA-transfer rate of 300k bytes/sec, a data-acquisition system using the MPC can provide continuous data throughput at speeds reaching 130 kHz and burst throughput at speeds reaching 1 MHz. The MPC software handler includes a language interface to interpretive Basic. You can purchase optional language interfaces for Fortran, Pascal, Compiled Basic, assembly language, and C. Depending on the configuration you

choose, the MPC system costs from \$7500 to \$20,000.

GPIB boards for the IBM PS/2

Besides providing boards that are compatible with the IBM PC family and its clones, a number of hardware vendors offer GPIB boards that you can use with IBM's new Personal System/2 computers. IOtech, for example, recently introduced the Personal488/2 GPIB interface, which works with IBM PS/2 Models 50, 60, and 80. You can choose from two versions of the board: the 250k-byte/sec version, which starts at \$500, and the 1M-byte/sec version (called the Personal488/2A), which costs \$595. Both boards plug into the PS/2 Micro Channel and provide interrupt levels, DMA channels, and controller/peripheral mode selection. These boards use no DIP switches or jumpers—you can choose from seven interrupt levels, 15 DMA arbitration levels, and 256 I/O addresses by means of software control. Alternatively, you

Text continued on pg 104

Manufacturers of IEEE-488 data-acquisition products

For more information on IEEE-488 products such as those discussed in this article, contact the following manufacturers directly or circle the appropriate numbers on the Information Retrieval Service card.

Analog Devices Inc
2 Technology Way
Norwood, MA 02062
(617) 329-4700
Circle No 650

Anasco
Audubon Rd
Wakefield, MA 01880
(617) 562-9673
Circle No 651

Bit 3 Computer Co
8120 Penn Ave S
Minneapolis, MN 55431
(612) 881-6955
Circle No 652

Burr-Brown
Box 11400
Tucson, AZ 85734
(602) 746-1111
Circle No 653

Capital Equipment Corp
99 S Bedford St, Suite 107
Burlington, MA 01803
(617) 273-1818
Circle No 654

Computer Dynamics Inc
105 S Main St
Greer, SC 29651
(803) 877-7471
Circle No 655

Connecticut Microcomputer Inc
Box 186
Brookfield, CT 06804
(203) 354-9396
TWX 710-456-0052
Circle No 656

Contec USA Inc
3000 Scott Blvd
Suite 211
Santa Clara, CA 95054
(408) 727-1497
Circle No 657

Cyborg Corp
55 Chapel St
Newton, MA 02158
(617) 964-9020
Circle No 658

Data Motion
Box 889
Orland Park, IL 60642
(312) 495-4007
Circle No 659

Dataq Instruments Inc
100 Lincoln St
Akron, OH 44308
(216) 434-4284
Circle No 660

Devtek Systems
Box 5224
Lancaster, PA 17601
(717) 560-0652
Circle No 661

DSP Systems
1 Kendall Square
Cambridge, MA 02139
(617) 577-1133
Circle No 662

Erbtech Engineering Inc
2760 29th St
Boulder, CO 80301
(303) 447-8750
Circle No 663

General Research Corp
7655 Old Springhouse Rd
McLean, VA 22102
(703) 893-5900
Circle No 664

Hewlett-Packard Co
Box 10301
Palo Alto, CA 94303
Phone local office
Circle No 665

Hart Scientific
177 W 300 South
Provo, UT 84601
(801) 375-7221
Circle No 666

ICS Computer Products
8601 Aero Dr
San Diego, CA 92123
(619) 279-0084
Circle No 667

Integrated Systems Products Inc
6028 Fremont Circle
Camarillo, CA 93010
(805) 987-5125
Circle No 668

Interactive Microware Inc
Box 139
State College, PA 16804
(814) 238-8294
Circle No 669

IOtech Inc
23400 Aurora Rd
Cleveland, OH 44146
(216) 439-4091
TWX 650-282-0864
Circle No 670

Keithley Instruments Inc
28775 Aurora Rd
Cleveland, OH 44139
(216) 248-0400
TLX 985469
Circle No 671

Laboratory Technologies Corp
255 Ballardvale St
Wilmington, MA 01887
(617) 657-5400
Circle No 672

Lawson Labs Inc
5700 Raibe Rd
Columbia Falls, MT 59912
(406) 387-5355
Circle No 673

Lotus Development Corp
55 Cambridge Parkway
Cambridge, MA 02142
(617) 577-8500
Circle No 674

Macmillan Software Co
866 Third Ave
New York, NY 10022
(212) 702-3241
Circle No 675

MetraByte Corp
440 Myles Standish Rd
Taunton, MA 02780
(617) 880-3000
Circle No 676

Microcomputer Systems Inc
1814 Ryder Dr
Baton Rouge, LA 70808
(504) 769-2154
Circle No 677

Microstar Laboratories Inc
2863 152 Ave NE
Redmond, WA 98052
(206) 881-4286
Circle No 678

Micro/Sys
1011 Grand Central Ave
Glendale, CA 91201
(818) 244-4600
Circle No 679

Microway Inc
Box 79
Kingston, MA 02364
(617) 746-7341
Circle No 680

National Instruments
12109 Technology Blvd
Austin, TX 78727
(800) 531-4742
TLX 756737
Circle No 681

Northwest Analytical Inc
520 NW Davis
Portland, OR 97209
(503) 224-7727
Circle No 682

Octagon Systems Corp
6510 W 91st Ave
Westminster, CO 80030
(303) 426-8540
Circle No 683

Opto 22
15461 Springdale St
Huntington Beach, CA 92649
(714) 891-5861
TLX 692386
Circle No 684

Preston Scientific
805 E Cerritos Ave
Anaheim, CA 92805
(714) 776-6400
Circle No 685

Pro-Log Corp
2560 Garden Rd
Monterey, CA 93940
(800) 538-9570
Circle No 686

Qua Tech Inc
478 E Exchange St
Akron, OH 44304
(216) 434-3154
Circle No 687

Scientific Solutions Inc
6225 Cochran Rd
Solon, OH 44139
(216) 349-4030
Circle No 688

Signal Technology Inc
5951 Encina Rd
Goleta, CA 93117
(408) 736-3083
Circle No 689

Summation Inc
11335 NE 122nd Way
Kirkland, WA 98034
(206) 823-8688
Circle No 690

Taurus Computer Products Inc
1755 Woodward Rd
Ottawa, Ontario
Canada K2C 0P9
(613) 226-5361
Circle No 691

Tektronix Inc
Box 1700
Beaverton, OR 97075
(800) 423-2200
Circle No 692

Transera Corp
3707 N Canyon Rd, Suite 4
Provo, UT 84604
(801) 224-6550
Circle No 693

Ultralink International
Box 1809
Minden, NV 89423
(702) 782-9758
Circle No 694

Witt Engineering
1802 Jefferson Ave
Glenview, IL 60025
(312) 724-0920
Circle No 695

Ziatech Corp
3433 Roberto Ct
San Luis Obispo, CA 93401
(805) 541-0488
Circle No 696

FIREBREATHING MULTIBUS



SUPERCHARGE WITH SBE'S 32-BIT, 20 MHz MPU-20.

Drop SBE's MPU-20 CPU into your Multibus* I chassis and buckle your shoulder harness. Because you're in for one fast ride.

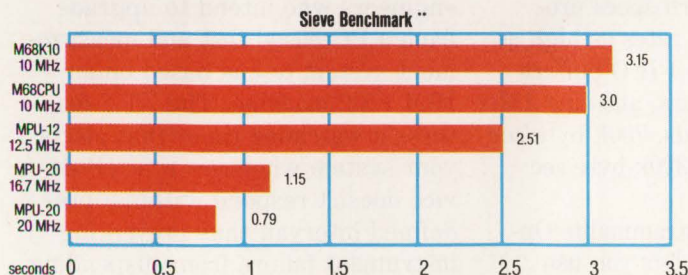

The MPU-20 is the only no wait state, 68020-based board running at either 16.7 or 20 MHz. And, it's a field upgrade for the 68000-based CPU you're using now. Which means you can supercharge your existing system. Fast. At a reasonable cost.

We'll even give you a running start with a free 30 day trial. Call us Toll Free. Give us your P. O. number and a credit reference. We'll ship you the MPU-20 Starter Kit:***The MPU-20 CPU board

with 1 Megabyte of RAM, plus PROBUG* software, cabling and documentation... everything you need to upgrade your 68000-based system. At our 100-piece price of \$1,950. Complete.

Install the board in your system and let'er rip. If the MPU-20 doesn't supercharge your system as promised, send it back within 30 days and tear up the bill.

SBE. From CPU's, COM and LAN boards to I/O expansion and systems. We've got what it takes to make Multibus breathe fire: No-compromise boards and systems.

**To Order, or for more information:
Toll Free: (800) 221-6458**

In California: (800) 328-9900
In Canada: (514) 445-0898

SBE, INC.
MICROCOMPUTER BOARDS AND SYSTEMS

2400 Bisso Lane, Concord, CA 94520
TWX: 910-366-2116 (SBE CNCD)

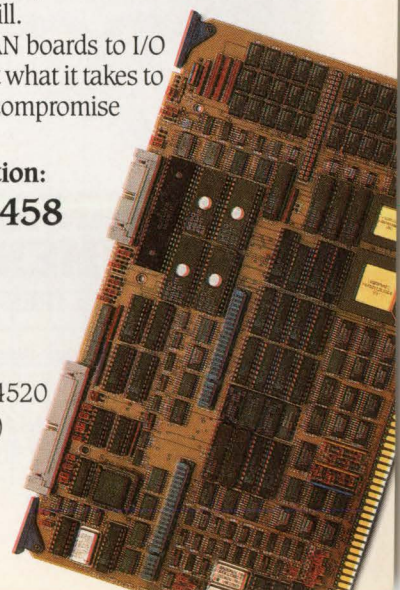

SBE, INC. IS A PUBLIC COMPANY TRADED ON THE NASDAQ NATIONAL MARKET SYSTEM *MULTIBUS IS A REGISTERED TRADEMARK OF INTEL CORPORATION
**RUNNING REGULUS (TRADEMARK OF ALCYON CORP) OPERATING SYSTEM. UNIX (REGISTERED TRADEMARK OF AT&T) SYSTEM V BENCHMARKS ALSO AVAILABLE.
***SUBJECT TO CREDIT APPROVAL

GPIB ↔ PC



IEEE-488

Interfaces For

IBM PC/XT/AT
 and Compatibles

IBM Personal
 System/2

Industry standard GPIB software
 for MS DOS and XENIX.

Co-developer of GPIB support for
 Lotus Measure, ASYST, LABTECH
 NOTEBOOK, and TBASIC.

Software compatible with our
 family of IEEE-488 interfaces for
 Macintosh, MicroVAX, PDP-11,
 LSI-11, VMEbus, STD Bus,
 MULTIBUS, S-100 Bus, and
 SBX Bus.



NATIONAL
 INSTRUMENTS

The Leader in IEEE-488

12109 Technology Blvd.
 Austin, Texas • 78727-6204

CALL FOR CATALOG

800/531-4742 • 512/250-9119

CIRCLE NO 34

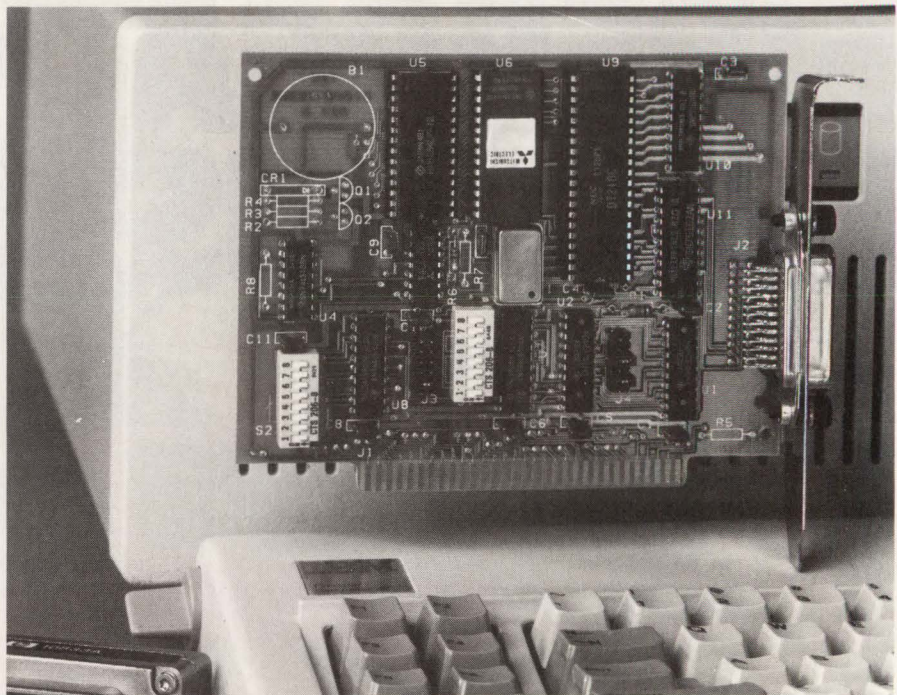

The ROM-based software and optional 8k×8-bit cache RAM of the PC-488 short-slot board from Capital Equipment Corp boosts DMA-transfer speed and facilitates advanced programming applications.

can use the company's \$295 GP488A board to link your PC-compatible computer to IEEE-488 devices. The GP488A, bundled with the vendor's Driver488 software, costs \$395.

National Instruments also offers a GPIB interface card for IBM's Micro Channel computers. The MC-GPIB board includes an NEC μ PD7210 μ P, which provides IEEE-488 talker, listener, and controller functions. The board also features a Turbo488 custom IC, which provides increased data-transfer rates and lower software overhead. The board specs programmed I/O data rates as high as 100k bytes/sec. Its FIFO buffers boost DMA transfers, allowing 1M-byte/sec GPIB reads, 700k-byte/sec GPIB writes, and 320k-byte/sec GPIB commands.

The board's Programmable Option Select feature lets you use IBM system-configuration utilities to select I/O addresses, interrupt levels, and DMA channels automatically, so you don't need any switches or jumpers from the board. The MC-GPIB also provides extra monitor and control ports for board- and bus-level diagnostics. For \$495, you receive the MC-

GPIB board and the MS/PC-DOS software handler. MS/PC-DOS is a device driver that can be installed as part of the operating system; it provides compatibility with most of the popular languages for the PC, including Fortran, Basic, C, Pascal, and assembly language.

A third company that offers an IEEE-488 controller for IBM's Micro Channel computers is Ziatech Corp. The firm's \$395 ZT 2 board uses the same device driver (DOS.GPIB) that supports the company's PC-compatible IEEE-488 board, so it may be useful to engineers who intend to upgrade from a PC-based test and measurement system to one based on an IBM PS/2 machine. The ZT 2 features a watchdog timer that alerts your system whenever a GPIB device doesn't respond within a pre-defined interval, thus preventing instrument failure from suspending the system's operation. The ZT 2 also offers a security option: a hardware-based security lock for your software applications. **EDN**

Article Interest Quotient
 (Circle One)

High 500 Medium 501 Low 502

MULTI-BUS POWER... STD BUS PRICE!

(From \$550.00)

80186 16 BIT MICROPROCESSOR

SBX CONNECTOR

SERIAL AND PARALLEL I/O

SOFTWARE LINKS TO PC

128 K BYTES EPROM

512 K BYTES RAM

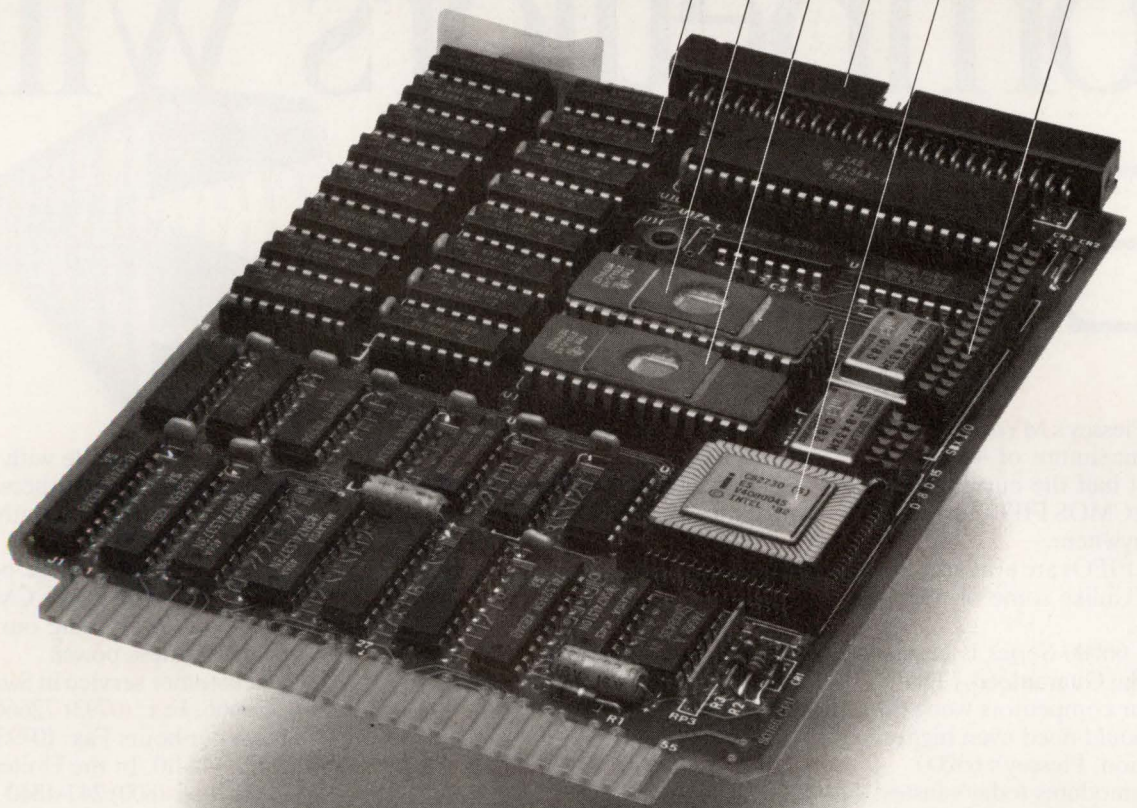

CuBIT DIVISION
OF
PROTEUS
INDUSTRIES

190 South Whisman Road
Mountain View, CA 94041-1577
Telephone: (415) 962-8237

There's only one thing our FIFOs won't do that our competitors' will. Eat power.



In fact, Plessey's MV66000 FIFOs consume a maximum of 40mA. That's almost half the current of the lowest power CMOS FIFO currently available. Anywhere.

And our FIFOs are available now. In quantity. (Unlike some of our competitors).

Plessey's 66000 Series is cascable to 25MHz. Guaranteed. (That's something our competitors won't do).

If you should need even higher speed operation, Plessey's 65000 Series accommodates today's fastest clock rates. (Think in terms of 40MHz). All without the large

power requirements of slower NMOS and Bipolar FIFOs.

And Plessey has the only FIFOs with extremely low standby currents. Our fully static CMOS design means that standby currents less than 10mA are experienced. Even at 5.5 volts.

The family

| | |
|----------|------------------------------|
| MV 66000 | 64 x 4,5,9 bit FIFOs, 25 MHz |
| MV 65000 | 64 x 4,5,9 bit FIFOs, 40 MHz |
| MV 61900 | 1K x 9 bit FIFOs, 10 MHz |

Package options include ceramic and plastic DIL and LCC.

Plessey FIFOs are pin compatible with MMI, Cypress, TRW and others. In 4, 5 and 9 bit widths. With or without 3-state outputs.

So you can replace those power-hungry FIFOs with Plessey's CMOS FIFOs. They do everything our competitors' do. For less power.

Call customer service in Swindon (0793) 726666. Fax: (0793) 726666 Ext. 250. After-hours Fax: (0793) 729412. Tx: 444410. In the United States, call (800) 247-4840 or (714) 472-0303. Telex 701464. Fax: (714) 770-0627.



PLESSEY

Where great systems come from small packages.

We also have sales and marketing centers in: **BENELUX** Brussels Tel: 02 733 9730 Tx: 22100 **ITALY** Milan Tel: (2) 390044/5 Tx: 331347 **FRANCE** Les Ulis Cedex Tel: (1) 64-46-23-45 Tx: 692858F **GERMANY (FDR)** Munich Tel: 089 23 62-0 Tx: 0522197

These are supported by agents and distributors in major countries worldwide.

Plessey and the Plessey symbol are registered trademarks of the Plessey Company plc.

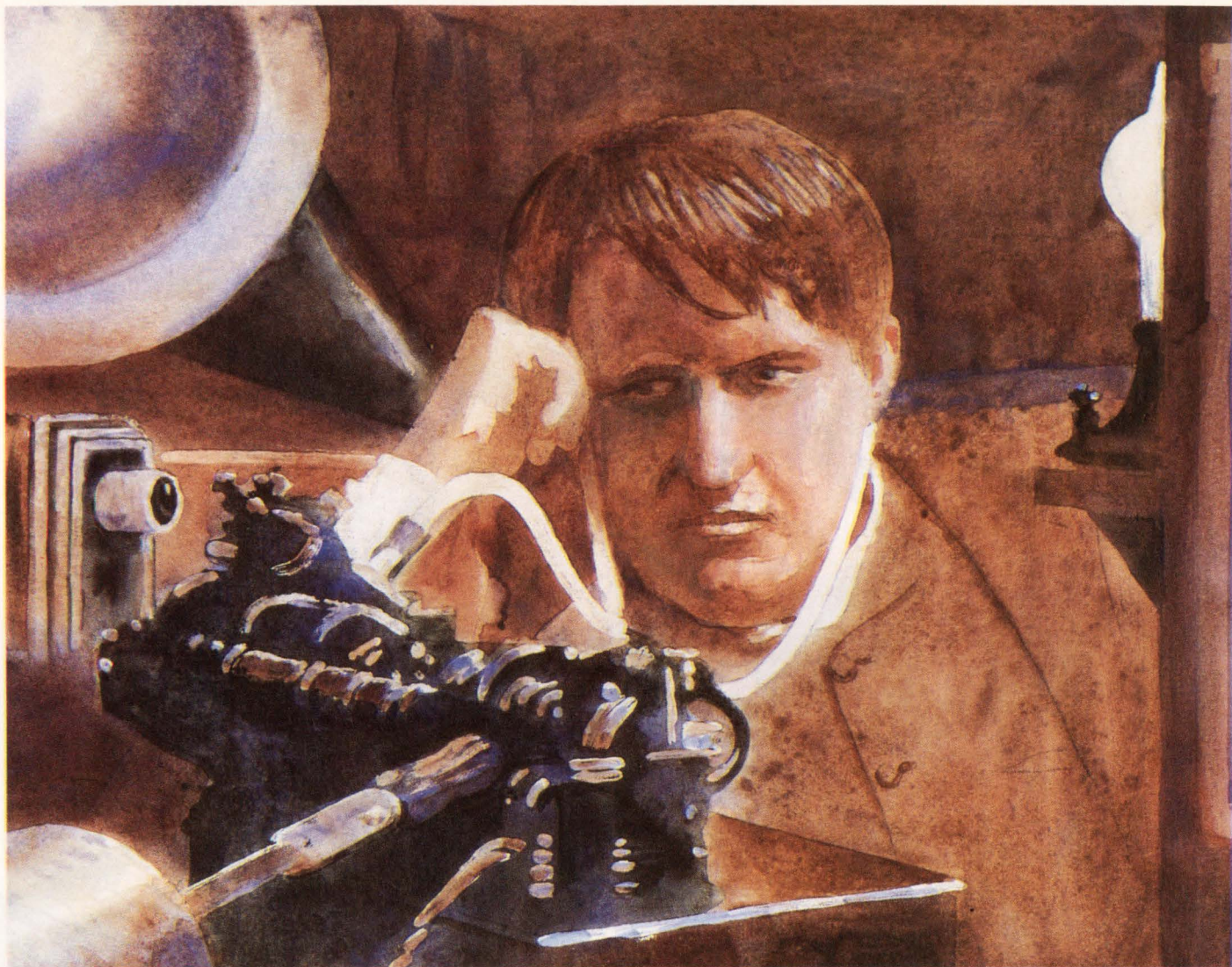

Sometimes, one good idea leads to another.

The company that pioneered in-house press fit manufacturing for the backplane and connector industry now offers another unique choice in high density connectors.

A new Six Row High Density Double-Din™ developed by Elfab for backpanel applications is now an Augat connector. With 60 contacts per linear inch, this new connector offers design opportunities unheard of until now.

With traditional design ingenuity, our new surface mount box connector straddles the board, occupying half the real estate of conventional connectors. And providing shorter signal paths for better performance under high speed circuit conditions.

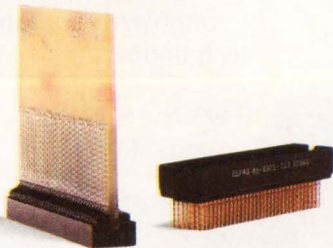

Best of all, conductor path distance is consistent between all six rows, insuring a uniform impedance control between the connector and the printed circuit board.

The same innovation and quality also is available immediately in two and four row connectors, and soon, five and seven row configurations.

But if your application requires something even more unusual, Elfab can custom build to your specifications. After all, that's what you'd expect from the Augat family, where innovation has always been a tradition.

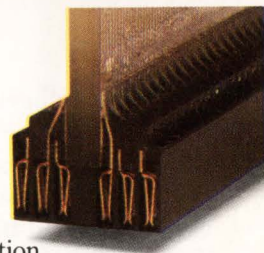

AUGAT® *Imagination begins at*
 **ELFAB**®

Quality and Innovation

Elfab Corporation
 1097 Yates • Lewisville, Texas 75067 • 214/221-8776
 Call toll-free 1-800-527-0753 • In Europe: Elfab Europe, B.V.
 • Raheen Industrial Estate • Limerick, Ireland • 061/27600
 • Telex: 70150

WE PUT A GREAT INTERFACE



As an intelligent interface for small computers, SCSI has become a great standard, supporting multiple peripherals on a single cable.

Seagate supports that standard with the widest variety of SCSI hard disc drives available: 3½" and 5¼". Half-heights and full-heights. With capacities from 20 to 160 MB.

Seagate's SCSI drives have built-in features that give your products these advantages:

- Superior performance through higher transfer rates.
- Greater system throughput with overlapped operations, low command overhead and defect management that is automatic and transparent.
- Improved data integrity with enhanced recovery techniques.

ST 4077N



ST 4096N ST 225N

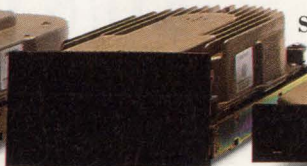

ST 138N

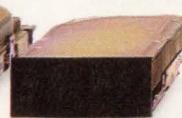

ST 157N



WHERE IT DOES THE MOST GOOD.



- Superior reliability due to fewer cables, connectors and components.
- Increased flexibility with a choice of command sets: common (CCS) or customer-defined.
- Direct hardware connections to computers with built-in SCSI ports.
- Simple PC installation with our ST01 host adaptor.

Customers have come to expect this attention to performance, quality and reliability from Seagate. That's why they've bought more than 6 million of our hard disc drives.

If you want to put great drives with a great interface in your system, call us. 800-468-DISC. Or write: Seagate Technology, 920 Disc Drive, Scotts Valley, CA 95066.

ST251N

ST277N

ST4144N

ST4192N

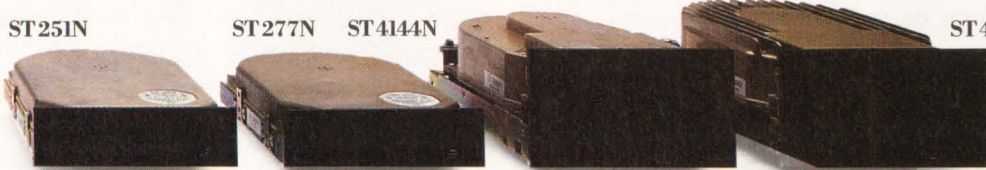

 **Seagate**

The first name in disc drives.



The future: interconnection components designed, manufactured, fabricated and tested under one roof. Here now, at Hughes.

One-roof capability means you can expect higher reliability, lower cost and faster response for your aerospace/mil applications.

We provide system support in the integration of connectors and boards, cables or other subassemblies, including black boxes. And we're doing it now, not waiting for the future.

Our engineers simplify tough problems. But just because we're problem-solvers doesn't mean we ignore ordinary connectors or flex circuitry.

We manufacture everything from PCs to fiber optics to umbilicals. Rectangular, circular, off-the-shelf or specials.

Flexible or rigid flex circuitry? We practically invented it. We'll manufacture to your specs or design it to your requirements. We'll even assemble Brand X connectors and our flex.

So whether your interconnection requirements are simple or sophisticated, give us a call. We can make the future work for you today.

For more information, call Mike Howett, 714-660-5702. In England call Hugh McInally, 0932 47262.

HUGHES
AIRCRAFT COMPANY

CONNECTING DEVICES DIVISION
Industrial Electronics Group

Digital signal processing enters the mainstream

Digital signal processing is finding use in products that don't involve such traditional applications as radar. And the chips in general are faster, cheaper, and even easier to use. DSP ICs are popping up in systems that address everything from the more conventional filtering applications to some less traditional ones like financial-modeling and servo-control applications. This first in a 4-part series reviews some basics and brings you up to date on digital-signal-processing products.

Jim Wiegand, Associate Editor

The strengths of the DSP approach to signal manipulation and analysis—extremely stable specs over temperature and time, and extreme flexibility—together with advances in operating speed, have made DSP a central player in areas where analog signal processing has long dominated. Although no one is willing to predict that DSP might replace analog signal processing the way digital computers have displaced analog computers, the quality and pervasiveness of digital products, such as compact disks, digital audio tape, and digital radio broadcast equipment, indicate that DSP is here to stay.

This, the first of a 4-part series EDN is devoting to DSP, briefly reviews the basics of DSP and gives you an update of the products available. David Shear's 2-part

contribution will start with an article on the tools that can ease your implementation of a DSP design. David will follow that with a hands-on article, in which he will take you from conceptualization to finished product. Bob Cushman's directory of DSP products will conclude the series. Similar to EDN's μ P directory, the DSP directory will provide you with a concise aid in the selection of DSP products.

DSP noise-reduction techniques provide audio/visual products with unmatched signal purity and dynamic range. And so it's unlikely that consumers will be trading in their CD players for a purely analog playback system. But other less traditional areas are beginning to use DSP techniques as well. DSP's promise now extends to the financial world, for example. Wall Street's traditional reliance on experience and intuition is giving way to increasing dependence on algorithms and computers, and this newfound trust seems to be creating a niche for DSP. The day when you can convert stock and commodity data into a financial model and then apply pattern-recognition techniques to predict market trends isn't too far away. This application is quite different from the seismology, medical imaging, and radar applications that have been the mainstay of image processing.

Filling the gap between general-purpose μ Ps and bit-slice DSP products, the monolithic DSP chip provides you with the same flexibility afforded by a general-purpose μ P along with an instruction set and archi-

DSP noise reduction techniques provide audio/visual products with unmatched signal purity and dynamic range.

texture that are optimized for the multiply and accumulate operations that are characteristic of DSP applications. Basically, DSP products fall into three categories: special-purpose DSP ICs, general-purpose DSP chips, and building-block ICs. Typical of the special-purpose ICs is the DSP56200 finite-duration impulse-response filter (FIR) IC from Motorola. And the Texas Instruments TMS320C30 is a representative general-purpose DSP chip. The WS59510 multiplier accumulator (MAC) IC from Waferscale Integration (Fremont, CA) is a member of the building-block family (Ref 1). Table 1 indicates some of the applications and corresponding hardware requirements for DSP designs.

The \$32 (OEM qty) WEDSP16 from AT&T is a general-purpose DSP, but this programmable device offers above average rates, performing a 16×16-bit multiplication and 36-bit accumulation in 75 nsec. You can also test a standard set of ALU conditions for conditional ALU operations, including branches and subroutine calls. The condition tests, branching capability, and subroutine calls allow you to operate the processor as a 16- or 32-bit μ P for logical and control operations in addition to the computationally intensive operations.

The WEDSP16 device contains a data arithmetic unit, which performs the signal-processing arithmetic; a ROM-address arithmetic unit; a RAM-address arithmetic unit; and a 2048×16-bit ROM that contains instructions and fixed data. For variable RAM data, it includes a 512×16-bit RAM. The device also has a serial I/O unit and a 16-bit parallel I/O unit. In addition, an on-chip cache is organized as 15×16 bits.

The chip includes a 2048×16-bit ROM. If you want to perform full-speed prototyping, you can replace the

on-chip ROM with as much as 64k 16-bit words of off-chip ROM. The off-chip ROM must provide at least a 50-nsec access time, however. The clock input to the chip has a specified range of 37.5 to 1000 nsec for its cycle time. The access time for off-chip memory is given as twice the cycle time of the input clock minus 25 nsec.

Use off-chip ROM to modify programs

You can also use the off-chip ROM to accommodate frequently modified programs. The additional circuitry required for an off-chip ROM implementation increases the per-piece price of your product, but the code, as with any μ P-based design, often changes frequently enough to justify the added cost. So unless you are quite certain of your system specifications and the code you use to implement the system's functions, plan on using the off-chip ROM.

The \$40 (OEM qty) TMS320C30 is a third-generation DSP chip from Texas Instruments. The part can achieve 33M flops when operated with a 60-nsec cycle time (the manufacturer claims that faster versions will be available). The processor incorporates two 1k×32-bit single-cycle, dual-access RAM blocks; one 4k×32-bit single-cycle dual-access ROM block; a 64×32-bit instruction cache; and an on-chip DMA controller.

The TMS320C30's multiplier operates in either floating-point or integer mode. In floating-point mode the inputs are 32-bit numbers, and the result is a 40-bit number that provides room for any growth that might occur after several calculations. The integer operands are 24-bit numbers, and the result is 32 bits long. You can use the part to build a 256-tap FIR filter that operates at a sampling rate of greater than 60 kHz or a 256-tap least-mean-square (lms) adaptive FIR filter with a sample rate of more than 20 kHz. The corresponding floating-point operation requires more time for these functions.

DSP's a natural for servo control

As with other DSPs, you needn't restrict your application of the TMS320C30 exclusively to DSP areas. Digital control systems are a natural extension of the application of these parts, and DSPs are already used as the servo controller in some disk drives. The stability over time and temperature is once again the crucial asset.

The high-speed processing that chips such as the \$157 TS68930 from Thomson-Mostek offer also make them perfectly suitable for graphics engines. Graphics processors must create and manipulate images that typical-

TABLE 1—COMPONENTS REQUIRED FOR VARIOUS DSP APPLICATIONS

| APPLICATION | REQUIRED COMPONENTS |
|--------------------------|---|
| LOW-FREQUENCY CONTROLLER | A GENERAL-PURPOSE μ P |
| HIGH-SPEED MODEM | A GENERAL-PURPOSE DSP |
| ELECTRONIC ECHO CANCELER | A μ P PLUS A SPECIAL-PURPOSE DSP |
| DIGITAL RADIO | A GENERAL-PURPOSE PLUS A SPECIAL-PURPOSE DSP |
| ACOUSTIC ECHO CANCELER | A GENERAL-PURPOSE DSP PLUS MULTIPLE SPECIAL-PURPOSE DSP |
| WORKSTATION | MULTIPLE GENERAL-PURPOSE DSPs |
| RADAR SYSTEM | MULTIPLE GENERAL-PURPOSE DSPs AND/OR BUILDING-BLOCK ICs |

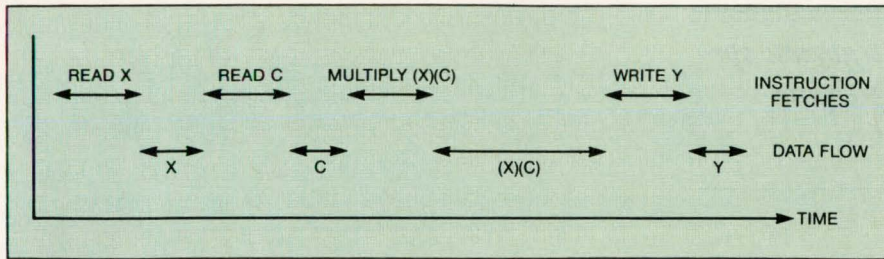

Fig 1—The traditional, Von Neumann architecture of most μ P's prevents parallel acquisition of data and instructions since both data and memory are contained in the same memory space. The sequential operation of acquiring, multiplying, and storing the results of the multiplication of two numbers is illustrated here.

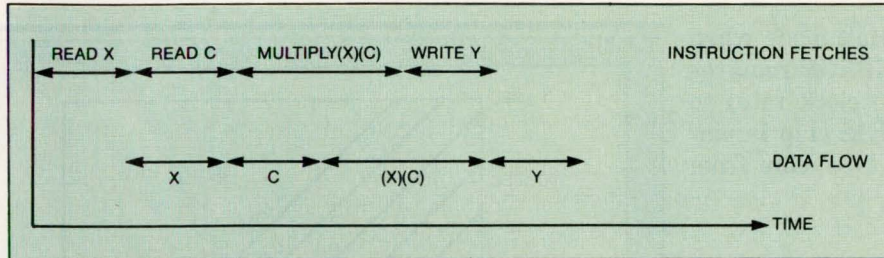

Fig 2—A Harvard-type architecture allows a μ P to fetch data and instructions in parallel. Beginning with the point where microinstruction READ C and data X are fetched in parallel, the multiplication operation of Fig 1 is executed in parallel, using the Harvard architecture.

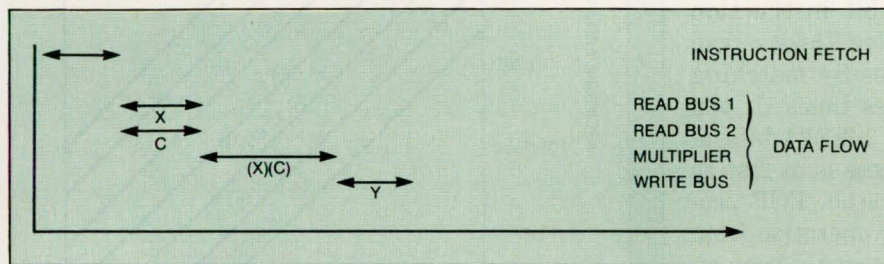

Fig 3—An enhancement to the Harvard architecture, three parallel buses, allows a μ P to fetch two operands simultaneously, but the μ P's operation depends upon the execution speed of the multiplier.

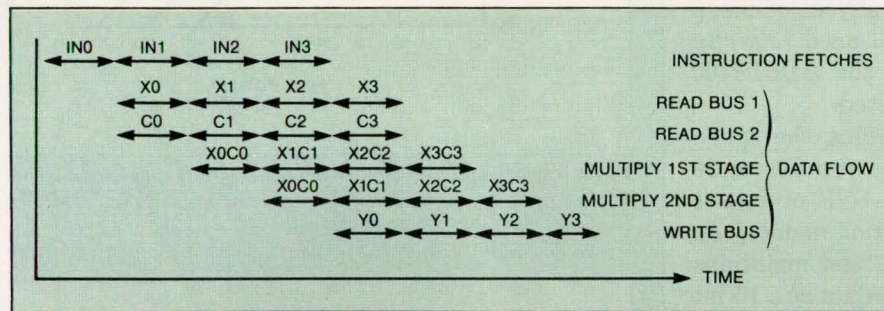

Fig 4—A parallel architecture can take advantage of pipeline techniques. In this example, operands for the third multiplication in a series are fetched at the same time as the results of the first multiplication are stored.

ly consist of $1k \times 1k \times 8$ bits. And an image-rotation operation requires repeated multiplication and addition computations that must be performed on all one million bytes contained in such an image. Multiplications and additions are, of course, a forte of DSP chips.

The TS68930 incorporates the Harvard architecture, which is common to most DSP processors. By separating instruction and data memory, the Harvard architecture allows processors to fetch instructions and data simultaneously. All general-purpose μ P's employ a Von Neumann architecture, in which instructions and data are located in the same memory space. During the first clock cycle of an instruction's execution, the μ P fetches the instruction, and then it fetches the data. Fig 1 illustrates the sequential nature of the instruction execution associated with the Von Neumann architecture. The Harvard processor, as illustrated in Fig 2, can fetch data and instructions simultaneously. By fetching instructions and data at the same time, the μ P operates much faster than a Von Neumann μ P.

One limitation of many Harvard processors, however, involves the bus structure. With two buses, simultane-

ous fetching is possible, but an extra bus cycle must be devoted to storing results. A processor that has three buses, one for each operand and one for results, benefits most from the Harvard architecture. Fig 3 illustrates the advantages of a 3-bus Harvard architecture. By including pipelined operation, a μ P can realize further improvements in throughput (Fig 4). To support the Harvard architecture, the TS68930 has three pipelined buses and 32-bit instructions. All these features combine to produce a performance level of 6.25 MIPS, which means the chip completes a 1024-point complex FFT in 9.65 msec.

The \$100 DSP320EE12 from General Instrument Microelectronics adds a new twist to the DSP product line-up by incorporating 2.5k words of on-chip EEPROM. The EEPROM lets you design systems that monitor signals, interpret previously digitized inputs, and then adjust on-chip parameters to fine-tune your system's performance. The internal EEPROMs high-voltage programming supply is also included on the chip, so you don't need to include an external one. If you elect to reprogram the part during program execution,

DSP products fall into three categories: special-purpose DSP ICs, general-purpose DSP ICs, and building-block ICs.

keep in mind that the μP remains in Halt mode when reprogramming is taking place. The EEPROM requires 1029 cycles (50 μ sec at the maximum clock rate) to reprogram each word. The DSP320EE12 chip is pin-for-pin compatible with the TM32010 DSP chip from TI.

Tight code makes a comeback

Because it has an on-chip 16×24 -bit instruction cache, the \$337 ADSP2100 from Analog Devices can maintain maximum performance rates by matching instruction-fetch times with data-access times. If you can confine your code to the on-chip $16k \times 24$ bits of program memory, then instruction access is as fast as data access, and you won't need the cache. DSP processors, because they are optimized for operation from on-chip memory, bring back what has recently been an outdated requirement: tight code. The advent of cheap memory obviated tight code, but you'll need to write tight code again if you use chips like the ADSP2100 because on-chip memory is strictly limited.

Of course, another approach to avoiding the speed penalty of using off-chip memory is to provide more memory on the chip. The \$250 M6992 DSP processor from Oki includes 64k words of instruction memory on the chip. The part performs 20M flops and maintains 480 dB of dynamic range. It formats the data as a 16-bit mantissa and a 6-bit exponent. Although its 22-bit floating-point operations don't conform to 32-bit floating-point standards, the manufacturer claims that the extra resolution provided by 32-bit floating-point processors is wasted in 90% of all applications.

Adapt, adopt, improve

Adaptive filters form a distinct class of filters. Often used to provide echo cancellation in telecommunications applications, these filters have two inputs that are correlated to produce an error signal. The error signal is then used through feedback techniques to adapt the filter to signal conditions. The signal of one input passes through a filter that varies its parameters in order to estimate the ideal of the second input. An external processor or the filter itself varies the filter parameters until the parameters converge. At that point, the output, which is the error signal, is minimized.

The \$100 DSP56200 from Motorola is a FIR-filter chip and, as is common in adaptive filters, it is based on the lms algorithm. The algorithm is implemented in silicon, so you don't have to write the software. You can

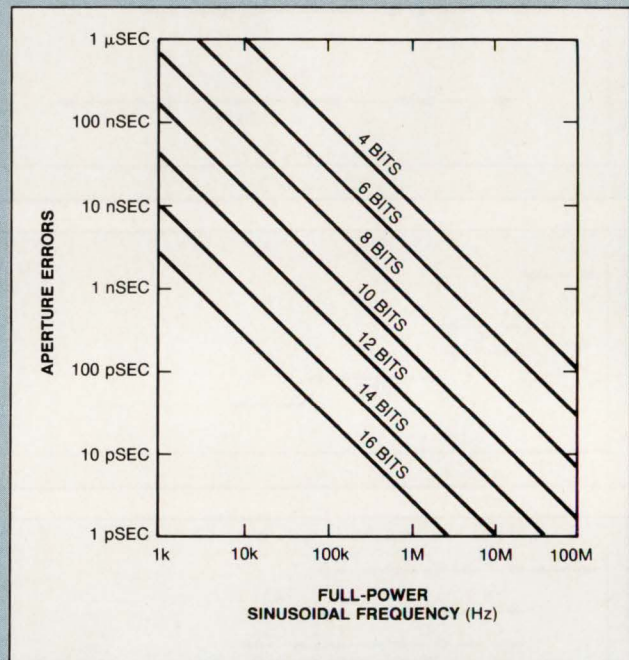

Fig A—Allowable aperture errors for a 1-LSB amplitude error are based on the frequency of a sinusoidal input signal and the required resolution for your system.

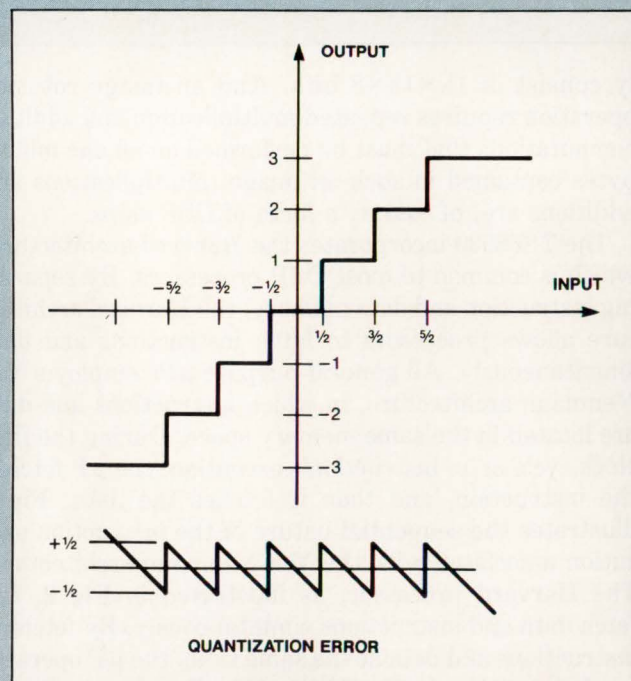

Fig B—The quantization error varies between $\pm \frac{1}{2}$ LSB of the quantizer—in this case an A/D converter.

A DSP primer

The function of any DSP system is pretty elementary: A DSP system generally acquires an analog signal and converts it to digital form. The system then processes the digitized data and, optionally, converts the results back into analog form.

The foundation of DSP is Shannon's sampling theorem, and it states that a signal must be sampled at a rate that is at least twice as high as the highest frequency in the signal's spectrum. In order to implement a DSP system, all you really need is an A/D converter for signal acquisition, a DSP to perform the digital processing, and a D/A converter to transform your processed signal to analog form.

But it's not quite that simple. The Shannon theorem applies to all frequency components and not just the ones you're trying to process. Thus, to avoid aliasing, you must prefilter those signals you intend to process. Any aliasing of the signal precludes the recovery of the origi-

nal distortion-free signal. Further, the filter can't act like a brick wall. Therefore, in addition to prefiltering, you must sample the signal at a rate higher than the prefilter's cutoff frequency. If you adjust the sampling rate in this way, you avoid aliasing.

After filtering and oversampling the input signal, you also must take into account uncertainties associated with the sampling process. An error voltage associated with the variation in aperture time and uncertainties in the starting time of a sampling aperture can be expressed as

$$e = \Delta V / V \text{ full scale.}$$

In the case of a sinusoidal signal, the error-voltage equation can be written

$$e = 2\pi f t_a,$$

where f is the frequency of the sinusoid and t_a is the aperture time of the digitizer. From the error-voltage equation, you can determine the maximum allowa-

ble aperture time for a given signal frequency and digitization resolution. **Fig A** illustrates this relationship for 1-LSB error.

Quantization error is also inherent in the digitization process because it's merely a measure of the limits of resolution of your digitizer. If you have a 2-bit ADC, then you can divide the full-scale signal you're sampling into four segments or steps, and the maximum error due to quantization is one-half step. **Fig B** illustrates quantization error as a function of input voltage for a 2-bit ADC.

When you select components for signal acquisition, it's important to consider not just the quantization error but also the aperture error associated with the A/D conversion process. A 12-bit ADC (244-ppm resolution) is wasted in a system where the signal frequency is 100 kHz and the aperture time is over 10 nsec. **Fig C** provides you with a good overview of the resolution and the conversion-rate requirements for a variety of applications.

Once you've digitized your signal, you'll need to determine what format you want the data to appear in. Fixed-point arithmetic provides greater resolution and speed. Floating-point operation, on the other hand, affords you greater dynamic range, but it does generally cost more.

Fig C—The conversion rate and the resolution determine the application ranges of ADCs. You must consider quantization error, too.

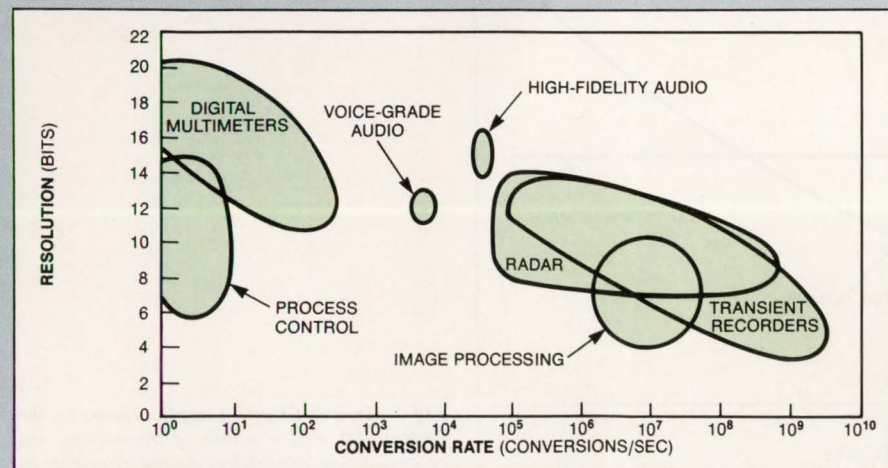

The inherent stability and extreme flexibility of DSP, together with advances in IC technology, have made it an active player in the signal processing arena.

cascade these devices to increase the basic 256 taps or to increase the throughput of the filter. The chip provides a serial cascade interface that lets you cascade DSPs without using extra circuitry. For example, you can cascade 16 of these chips to fabricate a 4096-tap FIR filter that operates with a maximum sampling frequency of 37 kHz. The input frequency and the number of operations needed to implement the filter determine the maximum sampling frequency.

You can cascade four \$110 (1000) ZR33881s from Zoran Corp and achieve a 40-MHz throughput. (These ICs are video-speed filter processors, which means they run at 10 MHz minimum.) The resultant cascading filter has only 16 taps, but it's sufficient for video applications. The ZR33481, ZR33881, and ZR33891 digital filter processors (DFP) from Zoran are all video-speed devices that you can use to implement 1-D and 2-D FIR filters, multibit correlators, and adaptive filters. Each of these devices comprises four (33481) or eight (33881 and 33891) filter cells and features 20-MHz sampling rate, 8- or 9-bit coefficients and data, and shift and add output stages for combining filter outputs. In quantities of 1000, the ZR33481 costs \$100; the ZR33891, \$150.

Zoran's \$230 (1000) ZR34161 vector signal processor (VSP) is aimed at digital image-processing applications. The VSP is optimized for frequency-domain processing, which provides some advantages over spatial-domain processing. Image compression and coding algorithms, feature extraction, spectral analysis of images, and image restoration are some of the applications that benefit from frequency-domain treatment. You can re-

store an image, for example, by converting it to the frequency domain and de-convolving its spectrum with that of the noise or the blurring that degrades the image. **Fig 5** compares the efficiency achieved by frequency- and spacial-domain treatments and shows how those performances relate to the kernel size of filters and to the number of operations required to implement them.

Choose integer or floating-point operations

The VSP completes a 1024-point block-floating-point complex FFT in 3.3 msec; its 23 high-level instructions operate on complex vectors or arrays of data. The VSP features both integer and block-floating-point execution and 16-bit address and data buses. Block floating-point arithmetic is a method of dealing with overflow in the results of an arithmetic operation. This approach maintains the dynamic range of the processor by shifting results only when an overflow occurs rather than shifting results as a matter of course. The device performs all calculations with an internal accuracy of 17 bits. Its 25-bit accumulators operate with no overflow of the accumulation of 256 17-bit words, a requirement for 128 complex-point dot-product operations.

Video-speed filtering is also the object of the NC45CF8, an NCR FIR filter. The basic filter chip provides 14.5-MHz data-throughput rates on 9-bit data processed with 8-bit coefficients. You can cascade the \$170 chip to lengths of either an even or odd number of taps. You can operate the chip in a linear phase mode, in which case it provides you with eight taps per chip, or

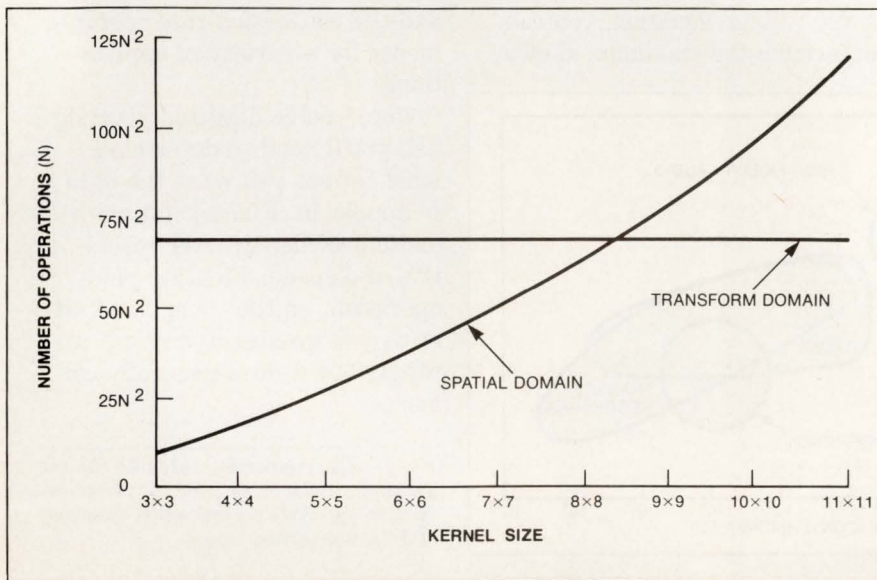
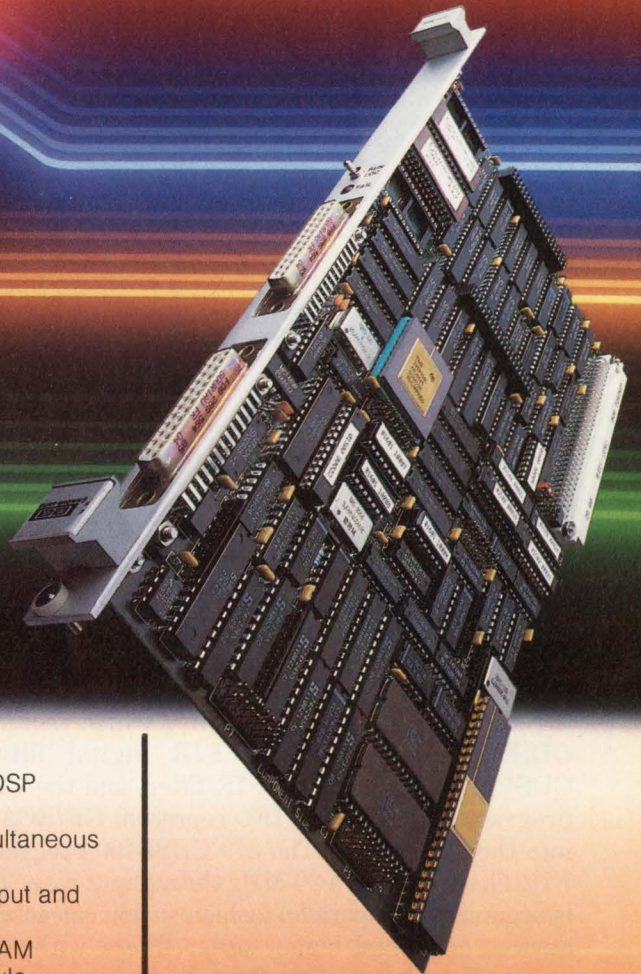

Fig 5—In 2-D filtering applications, as the kernel size and number of operations increase, it becomes advantageous to operate in the frequency domain.

Signal Processing Solutions



Fully Integrated DSP Hardware/Software

SPV100

- TMS32010-based DSP board
- RAM and PROM program memories
- Data/program memory overlap
- Swinging buffer RAM bus interface
- Firmware available for FFTs, digital filtering and correlation

SPV120

- TMS32020-based DSP board
- Fast I/O ports under DMA control reduce VMEbus data transfer burden
- Memory extension module utilizes full memory capability of TMS32020
- Two serial ports plus on-board monitor aid software development

MPV960

- Combination analog input/DSP board (TMS32010)
- Four analog inputs with simultaneous sampling
- Optical isolation between input and bus
- Dual-port swinging-buffer RAM
- Software development module (ACX960) available

DSPac™ Software Support

VERSAdos™-based software available for both the SPV100 and SPV120

- VERSAdos drivers
- TMS320 cross-assemblers
- Monitor/debuggers
- DSP application libraries

For complete hardware and software product information, call or write Burr-Brown Corporation, P.O. Box 11400, Tucson, AZ 85734. 602-746-1111.



By fetching instructions and data at the same time, the Harvard processor operates much faster than the Von Neumann μP .

For more information . . .

For more information on the DSP products described in this article, contact the following manufacturers directly or circle the appropriate numbers on the Information Retrieval Service card.

Analog Devices Inc
Box 280
Norwood, MA 02066
(617) 329-4700
Circle No 702

AT&T Technology Systems
555 Union Blvd
Allentown, PA 18103
(800) 372-2447
Circle No 703

GE/RCA
Solid State Div
Rte 202
Somerville, NJ 08876
(201) 685-6104
Circle No 711

General Instrument Microelectronics
2355 W Chandler Blvd
Chandler AZ 85224
(602) 963-7373
Circle No 704

Motorola Inc
Literature Distribution Center
Box 20924
Phoenix, AZ 85036
(512) 440-2039
Circle No 705

NCR Corp
Microelectronics Div
2001 Danfield Ct
Fort Collins, CO 80525
(303) 226-9500
Circle No 706

Oki Semiconductor
650 N Mary Ave
Sunnyvale, CA 94086
(408) 991-2000
Circle No 707

Texas Instruments Inc
Semiconductor Group (SC-612)
Box 809066
Dallas, TX 75380
(800) 232-3200
Circle No 708

Thomson-Mostek Corp
1310 Electronics Dr
Carrollton, TX 75006
(214) 466-6000
Circle No 709

Zoran Corp
3450 Central Expressway
Santa Clara, CA 95051
(408) 720-0444
Circle No 710

you can operate in a nonlinear phase mode and obtain four taps per chip.

Another family of FIR filters also offers video-rate throughput. The CDSP family, which includes the CDSP100 programmable FIR digital filter, the CDSP110 LMS adaptive FIR filter, and the CDSP200 programmable-length FIFO represent GE/RCA's foray into the DSP arena. The \$79 CDSP100 programmable FIR filter features a 20-MHz throughput rate. The chip is organized in a parallel fashion so you can cascade the devices and build higher-order filters without losing speed. The filter accepts 8-bit data and provides 11-bit 2's-complement output. The 11-bit data, however, is truncated to eight bits for output. The part limits truncation noise to less than -60 dB.

The \$110 CDSP110 is a least-mean-square adaptive FIR filter that accepts 8-bit input data and produces 12-bit outputs. You can operate the part at 10 MHz and, because it adapts on every cycle, the convergence time (time required for the error signal to be reduced to an

acceptable level) is minimized.

The \$26 CDSP200 programmable-length FIFO device can write or recirculate from dc to 55 MHz and is programmable in single-delay steps from two to 1281 sample delays. The device comes in 9- or 10-bit data-word versions. You can use the FIFO in applications such as comb filter designs, horizontal delay-lines for high-resolution monitors, and image processing. **EDN**

References

1. Titus, Jon, "Special Report: MAC chips," *EDN*, June 11, 1987, pg 114.
2. Bucklin, Willard, John Eldon, Louis Schirm, and Fred Williams, "Designer's Guide to Digital Signal Processing," originally in *EDN*, March 18, 1981, pg 133; April 1, 1981, pg 153; and April 15, 1981, pg 133. This 3-part tutorial on DSP is now only available from University Microfilms International, 300 N Zeeb Rd, Box 91, Ann Arbor, MI 48106, (313) 761-4700.
3. Gold, B, and C M Radar, *Digital Processing of Signals*, New York, NY, McGraw-Hill Book Co, 1969.
4. Jury, E I, *Application of the Z-Transform Method*, New York, NY, John Wiley & Sons Inc, 1964.
5. Karwoski, R J, "Introduction to the Z-transform and it's Derivation," *TRW/LSI Products*, El Segundo, CA, Sept 1979.
6. Oppenheim, A V, and R W Shaffer, *Digital Signal Processing*, Englewood Cliffs, NY, Prentice-Hall Inc, 1975.
7. Rabiner, L R, and B Gold, *Theory and Applications of Digital Signal Processing*, Englewood Cliffs, NJ, Prentice-Hall Inc, 1975.
8. Ragazzini, J R, and G F Franklin, *Sampled Data Control Systems*, New York, NY, McGraw-Hill Book Co, 1958.
9. Stanley, W D, G R Dougherty, and R Dougherty, *Digital Signal Processing*, Reston, VA, Reston Publishing Co, 1984.
10. Titus, Jon, "Special Report: DSP ICs," *EDN*, Oct 16, 1986, pg 162.
11. Tou, J T, *Digital and Sampled-Data Control Systems*, New York, NY McGraw-Hill Book Co, 1958.

Article Interest Quotient (Circle One)
High 476 Medium 477 Low 478

PMI PREMIERES: A QUARTET OF QUADS

Precision Quad

OP-400

$V_{OS} = 150\mu\text{V Max}$
 $I_B = 3\text{nA Max}$
 $A_{VO} = 5000\text{V/mV Min}$
 $I_{SY} = 2.9\text{mA Max}$
Starting from \$5.35

Low Noise Quad

OP-470

$e_n = 5\text{nV}/\sqrt{\text{Hz}} @ 1\text{kHz Max}$
 $A_{VO} = 1000\text{V/mV Min}$
 $SR = 2\text{V}/\mu\text{s Typ}$
 $I_{SY} = 11\text{mA Max}$
Starting from \$5.50

High Speed Quad

OP-471

$BW = 6.5\text{MHz Typ}$
 $SR = 8\text{V}/\mu\text{s Typ}$
 $A_{VO} = 500\text{V/mV Min}$
 $I_{SY} = 11\text{mA Max}$
Starting from \$5.50

Micropower Quad

OP-490

$I_{SY} = 80\mu\text{A Max}$
 $V_S = +1.6\text{V to } +36\text{V};$
 $\pm 0.8\text{V to } \pm 18\text{V}$
Single Supply Operation;
 V_{IN}, V_O include ground
Starting from \$3.30

Available now. For more information on PMI's next generation quad op amps, circle the inquiry number or call us at 1-800-843-1515. Prefer duals? Contact us!

Precision Monolithics Inc.
A Bourns Company
Santa Clara, California, USA
408-727-9222

ANAHEIM: (714) 666-0140, LOS ANGELES: (818) 886-6881, SANTA CLARA: (408) 727-6616,
DALLAS: (214) 341-1742, CHICAGO: (312) 250-0808, ATLANTA: (404) 263-7995,
PHILADELPHIA: (215) 675-7600, BOSTON: (617) 794-0026



The precision solution.

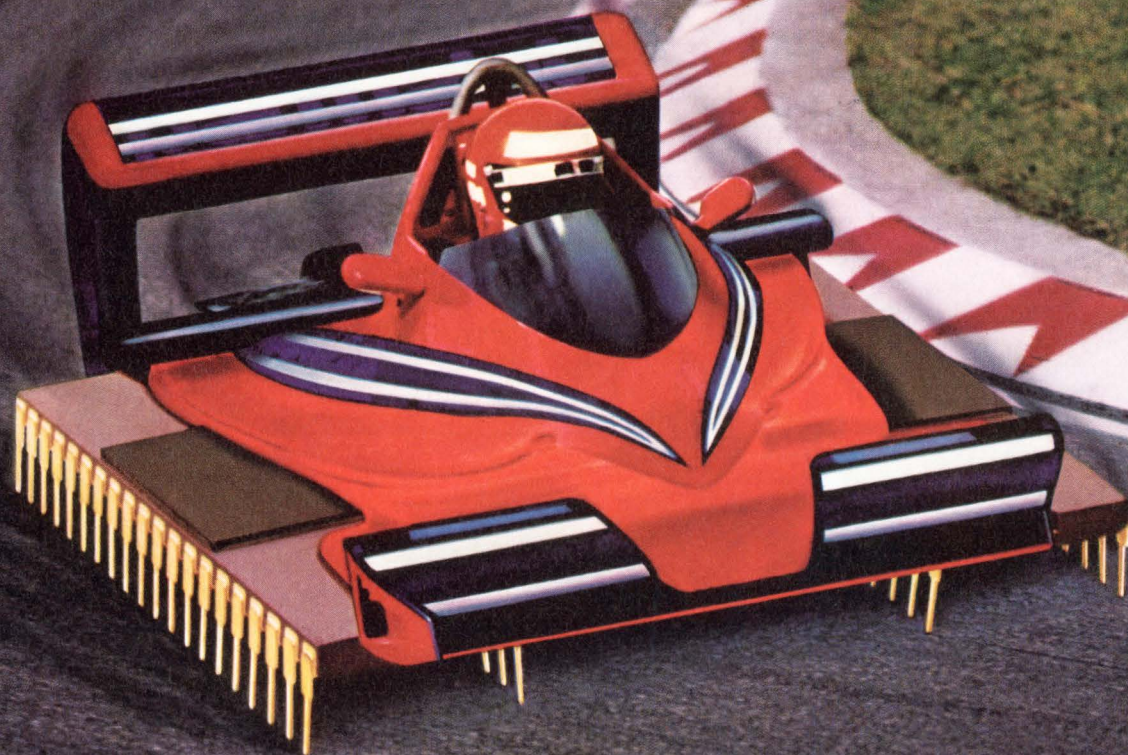

AT&T Single Chip DSPs:
the first and the fastest.



Now AT&T offers the world's first floating point and fastest fixed point DSPs.

Only AT&T can give you a complete single-chip Digital Signal Processor solution for all your analog and digital applications.

Because, only AT&T has a single-chip floating point DSP in full production, as well as the fastest fixed point DSP available.

Speed and flexibility.

The AT&T DSP32 has a 32-bit floating format with 24 bits of precision. It has an on-chip CAU that allows it to perform like a 16-bit microprocessor with 32-bit floating point capabilities. This makes precision possible over a wider range, so essential for high tech applications such as computer aided design, image processing and speech compression.

If your requirement is for faster speeds, our fixed point DSP16 operates at 55 ns. It is the first single-chip DSP to approach "building block" speeds.

Easier programming, development and debugging.

AT&T's DSPs make it easier to develop algorithm implementations. Unlike competitive DSPs, AT&T DSPs are

programmed using high level C-like Syntax, which is equation-like and much easier to program. AT&T also offers a complete single-board system for the development and real-time evaluation of your DSP programs. Plus, we offer a complete UNIX* and MS*-DOS software library for creating, testing and debugging applications programs.

Single chip means savings.

So, whatever your applications: voice signal filtering, speech and video signal compression, spectral analysis, graphics and computer-aided design, AT&T's single-chip DSPs can cut your development time as well as cutting power consumption and board area.

And, of course, AT&T Bell Laboratories' ongoing R&D will assure you that AT&T will stay at the forefront of DSP technology.

For more information, call 1 800 372-2447, or send the reply coupon. In Europe, call AT&T Microelectronics in Munich, Germany at 089/95970, Telex 5216884. In Singapore, call 2508422/2533722, Telex RS21473/RS55038. Let us show you why AT&T is the only DSP supplier with a complete single-chip solution for all your analog and digital applications.

AT&T, Dept. 203130-Leads, 555 Union Blvd., Allentown, PA 18103
Please send me more information about AT&T's DSPs.

Name _____
Title _____
Company _____
Address _____
City _____
State _____ Zip _____
Telephone (____) _____

© 1987 AT&T *Trademark of the Microsoft Corporation

CIRCLE NO 74



AT&T

The right choice.

GET THE WORD ON DSP.

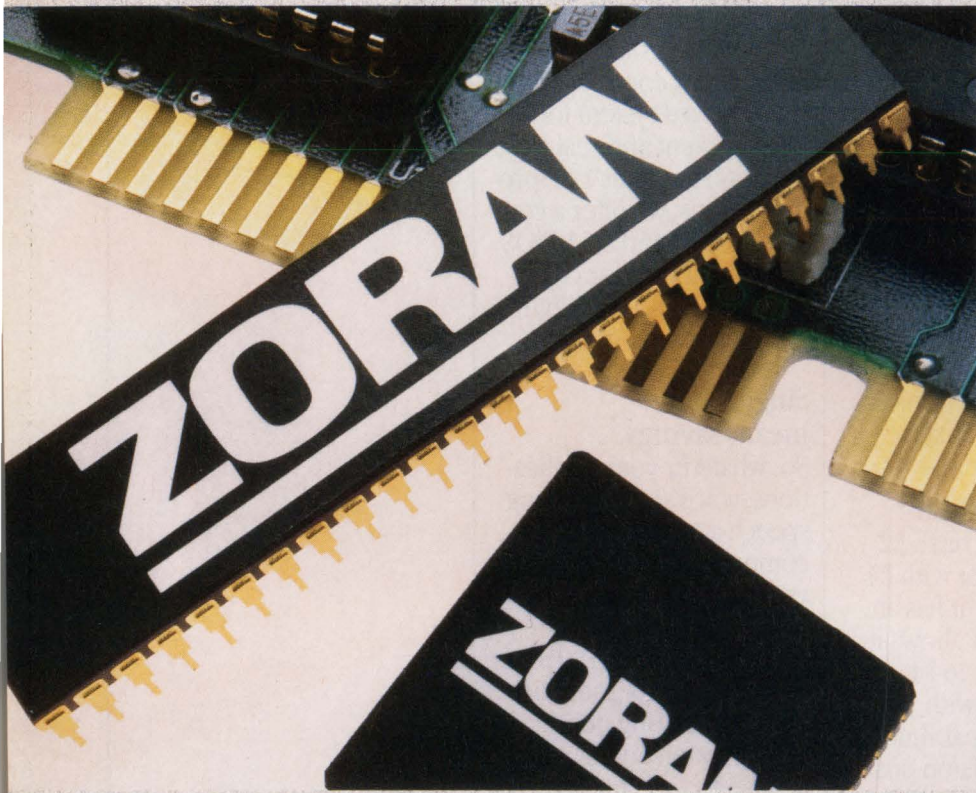

With all the talk about digital signal processing these days, it's hard to know what to believe. At Zoran, we'd like to make it easy for you.

For us, DSP isn't just a sideline, as it is at other companies. It's the bottom line. Because it's all we do.

Which means we strive to achieve only one objective. Developing the high-performance DSP products you need to shorten your time to market.

As evidenced by the Zoran Vector Signal Processor (VSP)[™] and Digital Filter Processor (DFP).

Two new signal processors that enable you to concentrate on your application, instead of getting bogged down in the details of software implementation.

Using single, highly integrated CMOS devices that use parallel processing to deliver all the speed of multiple components. Without all the hassle of extensive programming.

What's more, you'll do it in a lot less time. At a lower cost. And with greater ease, flexibility and reliability than you ever thought possible.

Best of all, we're shipping products now. Instead of simply announcing them. Which means you don't

have to wait to get the jump on your competition.

High performance never looked so easy. We didn't think it was enough for the VSP and the DFP to be the fastest DSP devices. So we also made them the easiest to use.

We developed proprietary architectures and optimized them for faster, more efficient execution of embedded DSP algorithms, such as FFT's and FIRs.

And we slashed programming time with a high-level instruction set that shrinks hundreds of lines of code to a mere handful, speeding system design.

On top of that, we developed a modular design that lets you configure multiple VSPs and DFPs in parallel to achieve even higher performance.

All the tools you need for faster product development. Most DSP support doesn't give you much to lean on. So we decided to provide you with all the help you need to shorten your development cycle and get to market faster, ahead of the competition.

All of which explains why the VSP and DFP are currently in use in computation-intensive applications like image processing, instrumentation and high-performance communications.

Get the word on Zoran. For a free Zoran databook, call 1-800-441-2345, ext. 99 (in CA) or 1-800-556-1234, ext. 99 (outside CA).

Or write Zoran Corporation, Dept. MC, 3450 Central Expressway, Santa Clara, CA 95051. We'll get the word out to you.



Comprehensive hardware and software development tools shorten your time to market.

Micropower circuits assist low-current signal conditioning

Part 1 of this 2-part series focuses on micropower signal conditioning for the various sensors and transducers that have inherently low impedance or output voltage. Those characteristics can complicate the design of a circuit that must operate at low current and low power. Part 2, scheduled for the August 20 issue, will look at micropower design techniques for the signal conditioning of A/D and V/F converters, of an A/S/H circuit, and of several low-power regulator circuits.

Jim Williams, Linear Technology Corp

Applications such as medical instrumentation, remote data acquisition, and power monitoring are all excellent candidates for battery operation, making low power consumption increasingly desirable in electronic apparatus. Micropower analog circuits for transducer-based signal conditioning present their own special problems. Although ICs that operate at low current are available, the interconnection of these devices to form a micropower circuit requires care (see box, "Designing micropower circuits: some guidelines"). In particular, trade-offs between signal levels and power dissipation become painful when you want good performance in the 10- to 12-bit range. Also, many transducers intrinsically produce small outputs, complicating an already difficult situation when dealing with micropower requirements. Despite these problems, the design of micropower circuits is possible by using high-performance, low-current-drain ICs with the appropriate circuit techniques.

Fig 1 illustrates a simple circuit for signal condition-

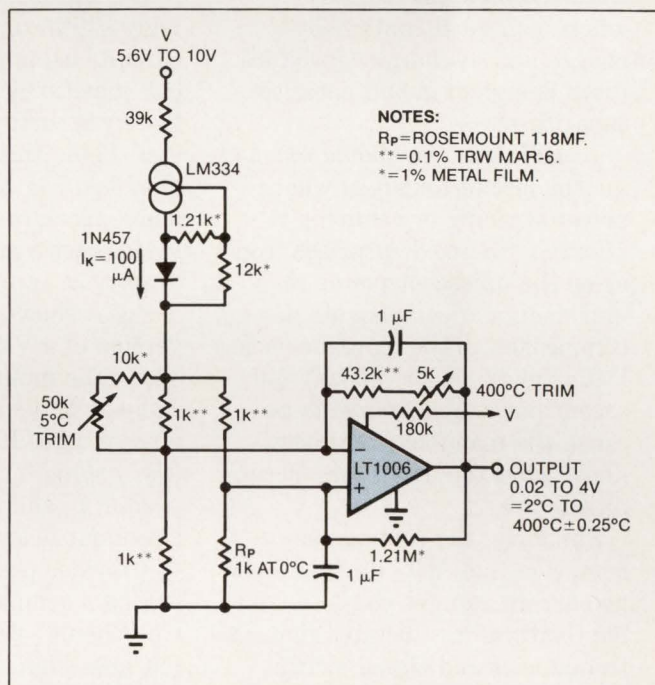

Fig 1—This signal-conditioning circuit for a platinum temperature sensor includes correction for the sensor's nonlinear response. Current drain is 250 μ A at a 2°C sensed temperature, increasing to 335 μ A at 400°C.

ing a platinum RTD (resistance temperature detector); the circuit includes correction for the sensor's nonlinear response. The circuit accuracy is $\pm 0.25^\circ\text{C}$ over a sensed range of 2 to 400°C. To improve noise immunity, you should connect one side of the sensor to ground. Current consumption is 250 μ A for a sensed temperature of 2°C and increases to 335 μ A at 400°C. You connect the platinum sensor in a current-driven bridge with the 1-k Ω resistors.

Text continued on pg 126

Designing micropower circuits: some guidelines

The most obvious way to save power is to choose components that use little energy. Although they require more effort, some subtler procedures can give you additional savings. First, you should examine the circuit current flow in terms of all ac and dc paths. Check, for example, to see that dc base currents are going where they can do some useful work. Try to minimize ac signal swings, particularly where you must continually charge and discharge capacitors (both designed-in and parasitic capacitors).

In addition, you should examine the circuit for areas where power strobing or sampling is possible. To avoid surprises, consider the quiescent power requirements of components in comparison to the dynamic ones. Data sheets usually specify quiescent power requirements because the manufacturer doesn't know what the user's circuit conditions are.

Similarly, the common assumption that MOS devices draw no current can get you into trouble. Natural law dictates that, as frequencies and signal swings increase, the capacitances associated with MOS devices begin to require more power. So it's often a mistake to associate low-power operation with any particular process technology. Although it's likely that CMOS will provide lower power operation than a 12AX7 vacuum tube, a bipolar approach may be even better. In the end, you might opt for a combination of technologies—CMOS and bipolar ICs, for ex-

ample, along with discrete transistors and diodes—for best results.

Obtaining low-power operation usually requires performance tradeoffs. Minimizing signal swings and current drain saves power, but it also moves circuit operation closer to the noise floor. As you constrict signal amplitudes to save power, you'll find that offsets, drift, bias currents, and noise become increasingly significant error factors. Circuits using power strobing can sometimes avoid this problem by resorting to low duty cycles. Using this technique, the circuit in Fig 3 (pg 127), for example, achieves dramatic power savings with an on-state current drain that approaches 20 mA.

Fig A shows a rudimentary version of a V/F converter. When the input current-derived ramp at IC_{1A}'s negative input crosses zero, IC_{1A}'s output drops low, pulling a charge through capacitor C₁ and forcing the negative input below zero. Capacitor C₂ provides positive feedback, allowing a complete discharge for C₁. When C₂ decays, IC_{1A}'s output goes high and clamps at the level set by D₁, D₂, and V_{REF}. C₁ receives a charge, and recycling occurs when IC_{1A}'s negative input again reaches zero. The frequency of this action relates to the input voltage. Diodes D₃ and D₄ steer, while diodes D₁ and D₂ provide temperature compensation. The sink saturation voltage of IC_{1A} is small and uncompensated. IC_{1B} acts as a start-up loop.

Although the LT1017 and

LT1034 have low operating currents, the circuit in Fig A draws almost 400 μ A. The ac-current paths include C₁'s charge-discharge cycle and C₂'s branch circuit. The dc path through D₂ and V_{REF} is particularly costly. C₁'s charging must occur quickly enough for 10-kHz operation—that is, the clamp seen by IC_{1A}'s output must have a low impedance at that frequency.

Capacitor C₃ helps, but you still need significant current to keep the impedance low. IC_{1A}'s current-limited output cannot do the job alone; it uses the supply's resistor to help in keeping the impedance low. Even if IC_{1A} could supply the necessary current, V_{REF}'s settling time would be an issue.

Dropping C₁'s value reduces the impedance requirements proportionally and seems to solve the problem. Unfortunately, such a reduction magnifies the effects of stray capacitance

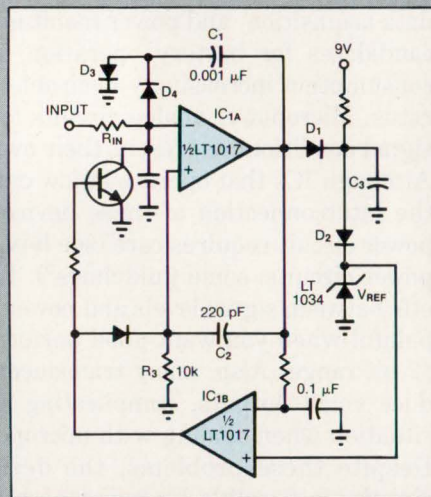

Fig A—This rudimentary version of a V/F converter draws almost 400 μ A. The dc path through D₂ and V_{REF} is particularly costly.

at the D_3 - D_4 junction. It also mandates an increase in the value of R_{IN} to keep the scale factor constant. This increase lowers the operating currents at IC_{1A} 's negative input and thus makes bias current and offset more significant sources of error.

Attacking the problems

Fig B shows an initial attempt at dealing with these issues. This scheme is similar to Fig A's, except for the addition of Q_1 and Q_2 . Instead of being on all the time, V_{REF} now receives switched bias via Q_1 , and Q_2 provides the sink path for C_1 . These transistors invert IC_{1A} 's output, requiring an exchange in its input-pin assignments. Resistor R_1 provides a small current from the supply, improving the reference settling time. This arrangement decreases supply current to about $300 \mu A$.

Several problems remain, how-

ever. The switched operation of Q_1 is really only effective at higher frequencies. In the lower ranges, IC_{1A} 's output is low most of the time, biasing Q_1 on and wasting power. Also, when IC_{1A} 's output switches, Q_1 and Q_2 simultaneously conduct during the transition, effectively shunting R_2 across the supply. Finally, the base currents of both transistors flow to ground and are lost. The basic temperature compensation is thus the same as before, except that Q_2 's saturation term replaces that of the comparator.

Fig C presents a better solution. Q_1 is gone, but Q_2 remains with the addition of Q_3 , Q_4 , and Q_5 . V_{REF} and its associated diodes receive bias from R_1 . Q_3 is an emitter follower and sources current to C_1 . Q_4 provides temperature compensation for Q_3 's V_{BE} , and Q_5 switches Q_3 .

This method has some distinct advantages. The V_{REF} string can

operate at greatly reduced current because of Q_3 's current gain. Also, the simultaneous conduction problem in Fig B is largely alleviated because Q_2 and Q_5 are switched at the same voltage threshold from the output of IC_{1A} . Q_3 delivers its base and emitter currents to capacitor C_1 . Q_5 's currents are wasted, although they are much smaller than Q_3 's. Q_2 's small base current is also lost. The circuit design changes the values for C_2 and R_3 . The time constant is the same, but some current reduction occurs because of the increase in the value of R_3 .

If, for performance reasons, you cannot reduce the value of C_1 , then you must accept its ac currents. The only significant wasted values are the Q_2 and Q_5 currents, along with the now smaller R_1 loss. Current drain for this circuit is about $200 \mu A$ max.

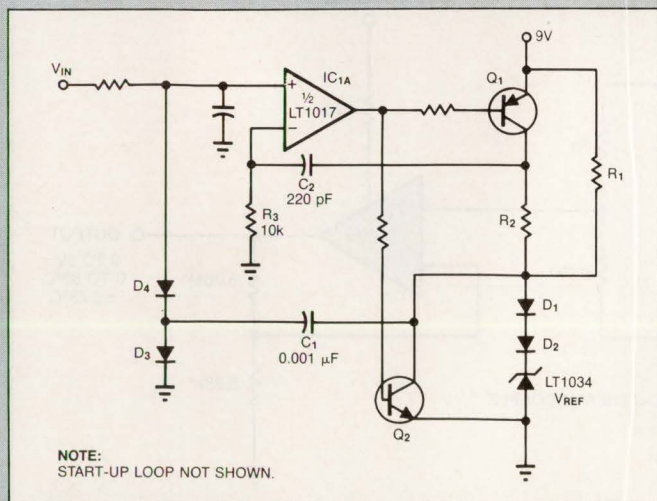

Fig B—This improved version of the Fig A circuit needs only $300 \mu A$ of current. Instead of being on continuously, V_{REF} now receives switched bias.

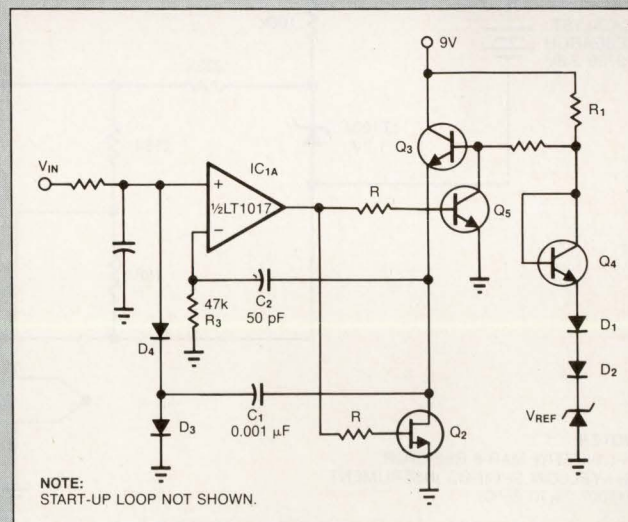

Fig C—Needing only $200 \mu A$, this circuit operates the V_{REF} string at greatly reduced current.

ICs that operate at very low currents do not, by themselves, guarantee the successful design of micropower circuits. Techniques are of equal importance.

The LM334 current source drives the bridge at an operating current of 100 μA , determined by the bridge's equivalent resistance. The 1N457 diode in series with the bridge provides temperature compensation. By reducing the voltage across the LM334, the 39-k Ω resistor minimizes its temperature rise and ensures its closer temperature tracking with the diode. The low current of 100 μA , which is split by the bridge, restricts the platinum sensor's output to about 200 $\mu\text{V}/^\circ\text{C}$.

To achieve a circuit accuracy of $\pm 0.25^\circ\text{C}$ and stable gain, you should use a low-power precision op amp like the LT1006. The LT1006 takes the signal differentially from the bridge to provide the circuit's output. The platinum sensor's slightly nonlinear response normally causes several degrees of error over the sensed temperature range, but the 1.21-M Ω resistor provides a slight positive feedback to correct for this error. The amplifier's negative feedback path dominates, and the circuit configuration is stable. The 1- μF capacitor rolls off the circuit's high-frequency response, and the 180-k Ω resistor programs the LT1006 for 80 μA of quiescent current.

Use decade box for calibrating

To calibrate this circuit, you can substitute a precision decade box (such as the General Radio #1432) for R_P . Set the box to the 5 $^\circ\text{C}$ value (1019.9 Ω) and adjust

the 5 $^\circ\text{C}$ trim for 0.05V at the output of the LT1006. Next, set the box for the 400 $^\circ\text{C}$ value (2499.8 Ω) and adjust the 400 $^\circ\text{C}$ trim for 4.00V output. Repeat this sequence until both points remain fixed.

The resistance values set by the decade box are for a nominal 1000.0 Ω (0 $^\circ\text{C}$) sensor. You can use sensors deviating from this nominal value by factoring in the deviation from 1000.0 Ω . Because it is an offset value that arises from winding tolerances during the fabrication of the RTD, the manufacturer specifies this deviation for each individual sensor. The platinum's gain slope, which is primarily fixed by the purity of the material, is a very small error factor.

The temperature-sensing circuit in Fig 2 uses a thermocouple as the transducer. It is accurate within 1.5 $^\circ\text{C}$ over the sensed temperature range of 0 to 60 $^\circ\text{C}$. Current consumption is about 125 μA .

Not only are thermocouples inexpensive, they have low impedance and generate their own outputs. They do, on the other hand, produce low-level outputs and require cold-junction compensation, both of which complicate signal conditioning. The bridge network, composed of a thermistor and its associated resistors, provides cold-junction compensation with the LT1004 acting as a voltage reference. The lithium battery lets the bridge float and also lets the thermocouple have a ground reference, thereby eliminating the need for a multi-amplifier differential stage with its attendant

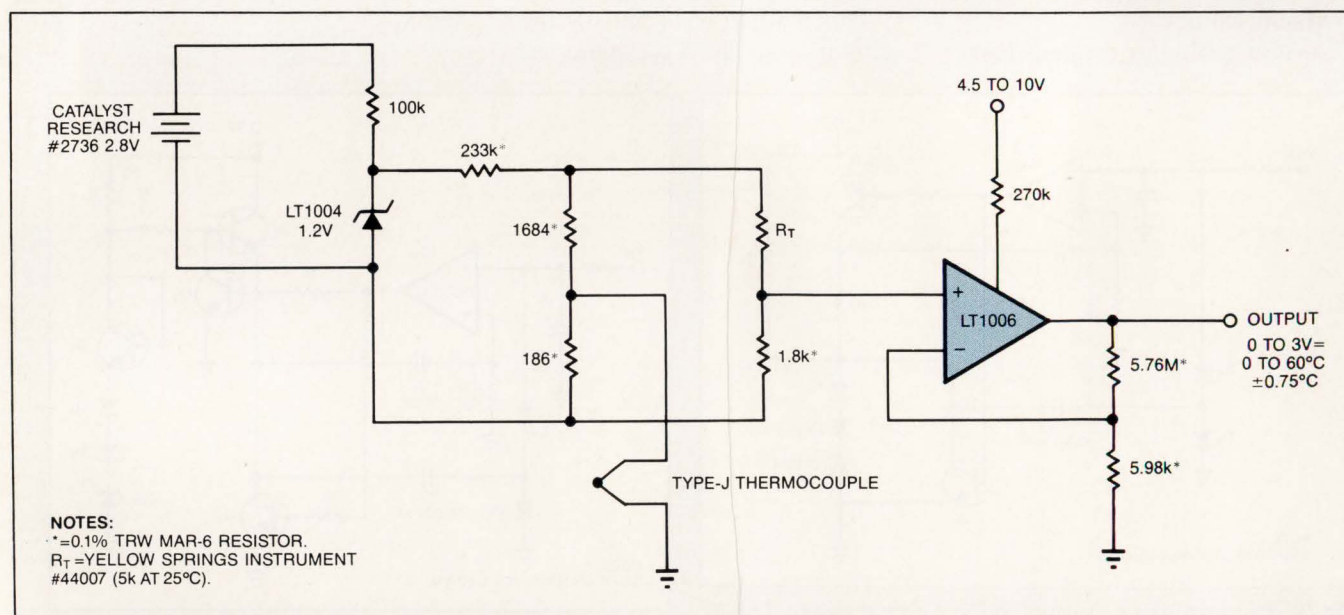

Fig 2—This thermocouple-type temperature-sensing circuit features cold-junction compensation and is accurate within 1.5 $^\circ\text{C}$ over a 60 $^\circ\text{C}$ temperature range. Current-drain is about 125 μA .

power drain. (The battery specified in the figure is supposed to last nearly 10 years.) The gain adjustment of the LT1006 provides the output shown, and the 270-k Ω resistor programs the IC for low current drain. Note that this circuit requires no trimming.

Bridge-based, strain-gauge transducers present a challenge for low-power designs. Some common values for the transducers are a 350 Ω impedance and a low output signal (typically 1 to 3 mV per volt of drive), and these common values create problems for low-power designs. Even with only 1V of drive, the bridge current consumption approaches 3 mA. Reducing the drive to 100 mV drops the current to acceptable levels, but

precludes any great accuracy because of the minuscule output available.

In many situations, continuous transducer information is unnecessary, and consequently a sampling operation is viable. Sampling at a low duty cycle permits a high-current bridge drive while keeping the average power consumption low (see **box**, "Sampling techniques reduce circuit current"). **Fig 3** uses such a scheme to achieve dramatic power savings in a strain-gauge bridge application.

In the circuit of **Fig 3**, Q_2 is off when the sample command is low. Under these conditions, only the LT1006 and the CD4016 receive power, and the current

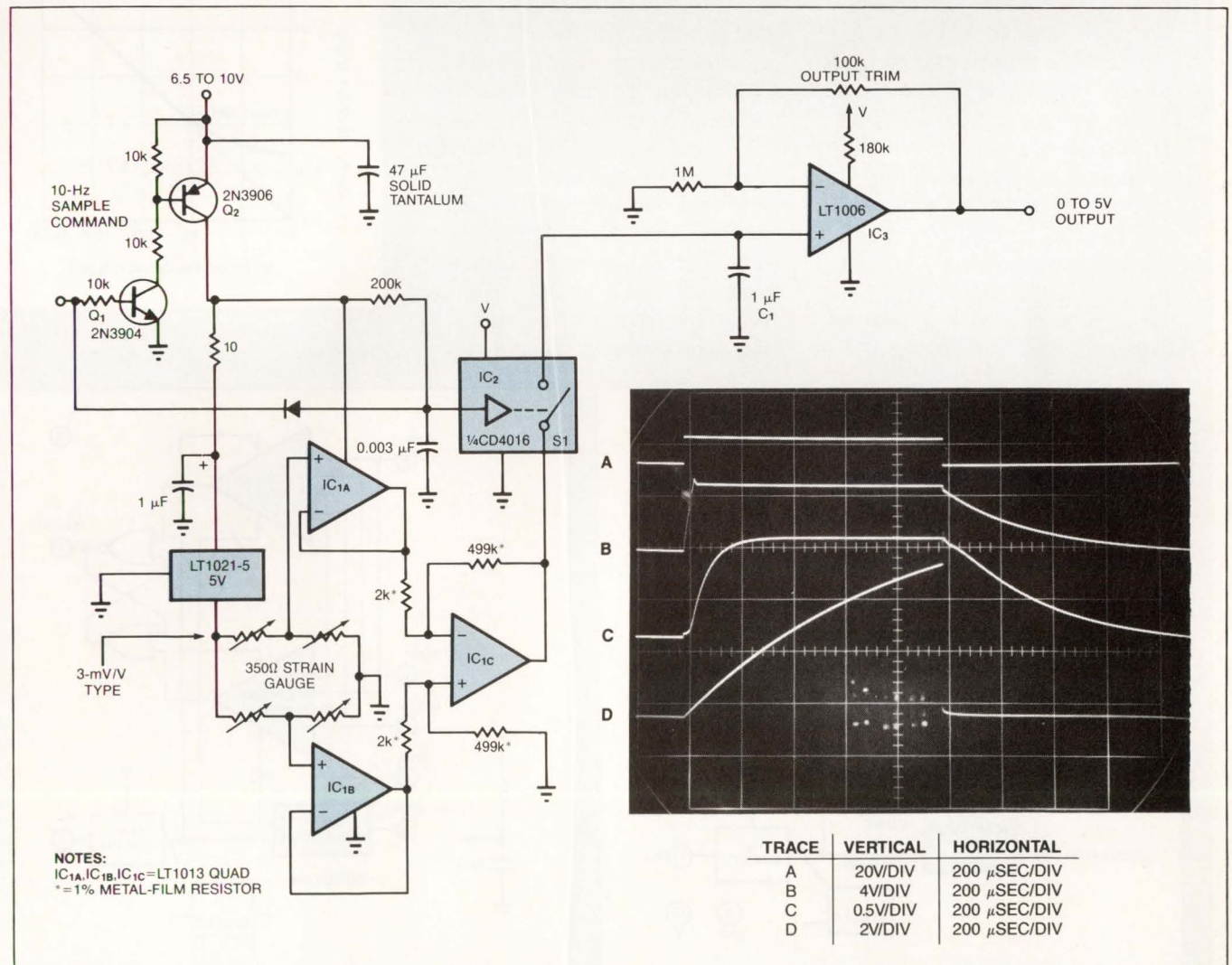

Fig 3—Strain-gauge bridge-type transducers present problems in achieving low-current operation because of their low impedance and low output signals. The circuit shown in a uses a sampling approach to lower the average current. The operating waveforms shown in b are described in the text.

Sampling or strobing techniques can drastically reduce the average current drain in many circuits while still providing full drive power when needed.

drain is less than 125 μA . When the sample-command pulse goes high, the collector of Q_2 (trace A, Fig 3b) goes high, providing power to all other circuit elements. The 10 Ω resistor and the 1- μF capacitor at the input of the LT1021 prevent the strain bridge from having to handle a fast-rising pulse, which could cause long-term transducer degradation.

The LT1021-5 reference output (trace B) drives the

strain bridge, and the output of the differential amplifier IC_{1A} , IC_{1B} appears at IC_{1C} (trace C). At the same time, S_1 's switch-control input (trace D) ramps toward Q_2 's collector. At about half of Q_2 's collector voltage (in this case, just before midscreen), S_1 turns on, and the output of IC_{1C} charges capacitor C_1 . When the sample command drops low, Q_2 's collector falls, the bridge and its associated circuitry shuts down, and S_1 turns off.

Sampling techniques reduce circuit current

The best way to achieve low-power circuit characteristics is to turn off the power. Obviously, there are some problems with this approach, but in many applications, continuous circuit power is not necessary. If bandwidth requirements are low, sampling techniques offer a simple way to save power. With low duty cycles, instantaneous current can be relatively high, and average current drain remains low.

One of the issues you need to examine when considering a

sampling approach is that the desired circuit bandwidth dictates the minimum sampling frequency in accordance with Nyquist criteria. The circuit's settling time (to the desired accuracy) determines the required duration of the sampling interval.

You should consider this settling time for all circuit elements (transducers, ICs, and discrete components) separately and together. You should also examine the effects of a sampled operation on component life and oper-

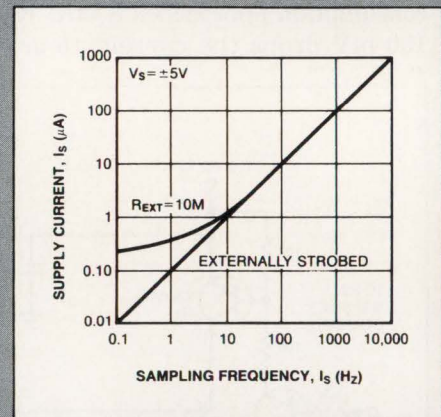

Fig B—This graph plots supply current vs frequency for the circuit in Fig A.

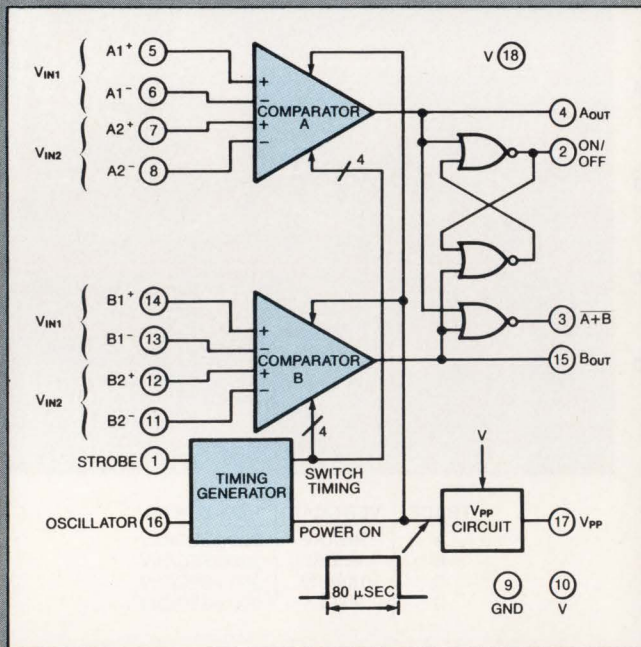

Fig A—The output of the LTC1040 dual comparator supplies power only during the programmed sampling interval.

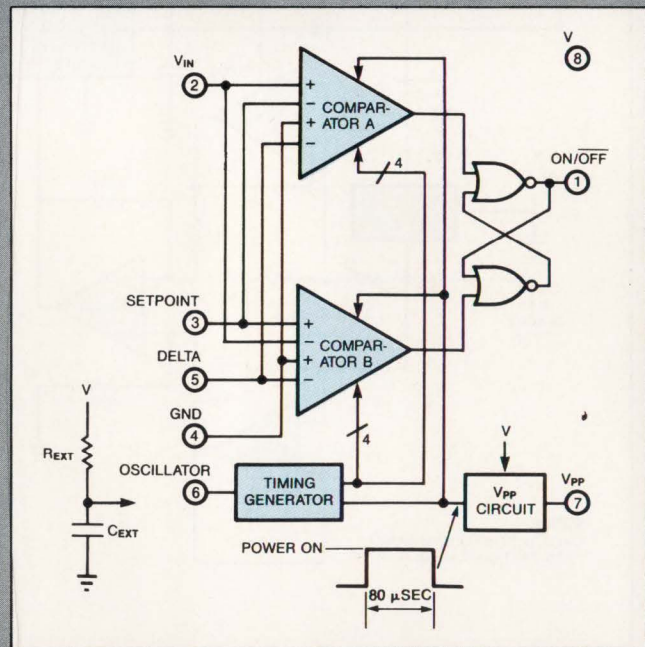

Fig C—The LTC1041 shown here is dedicated to on-off servo operation.

Capacitor C_1 's stored value appears at the gain-scaled output of the LT1006 (IC₃).

By preventing the updating of C_1 until IC_{1C} settles, the RC delay at S₁'s control input ensures glitch-free operation. During the 1-msec sampling phase, supply current approaches 20 mA, but the 10-Hz sampling rate cuts the effective current drain below 200 μ A. Slower sampling rates will further reduce current drain, but

C_1 's droop rate (about 1 mV/100 msec) limits the accuracy. The 10-Hz rate provides adequate bandwidth for most transducers. The gain trimming shown allows calibration for 3-mV/V slope-factor transducers. You should rescale the trimming for other types. The current drain of this circuit is about 300 μ A, and the output is accurate enough for 12-bit systems.

By switching most of the power into the circuit, the

ating characteristics. This latter issue is particularly important in the case of transducers, which are often designed and tested under dc operating conditions.

The LTC1040, 1041, and 1042 are specifically designed for sampled operation. Fig A details the LTC1040 dual micropower comparator. Its programmable internal oscillator sets a sampling rate with an interval lasting 80 μ sec. The V_{PP} output supplies power during the sampling interval, thereby providing drive for the external circuitry or transducers. Note that the input common-mode range includes both rails. Fig B plots supply current vs sampling frequency.

The LTC1041 is shown in Fig C. Although similar to the 1040, it is specially dedicated to on-off servo loops. You can control the servo setpoint and delta at the inputs. The Fig D diagram graphically defines its operation. The operating current is similar to the 1040's.

The final example, the LTC1042, is also similar to the 1040, but it's laid out as a window comparator. Its internal construction is shown in Fig E, and its graphic operation, in Fig F. The operating current, input range, and sampling characteristics are similar to the LTC1040's and 1041's.

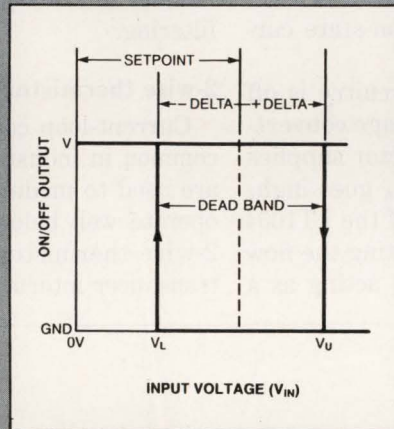

Fig D—This plot of the LTC1041's setpoint and delta graphically defines its operation.

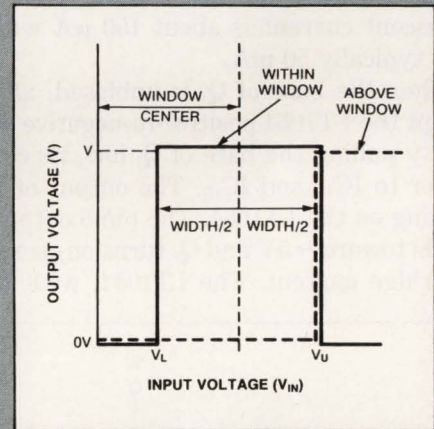

Fig F—This graph illustrates the window characteristics of the LTC1042 comparator.

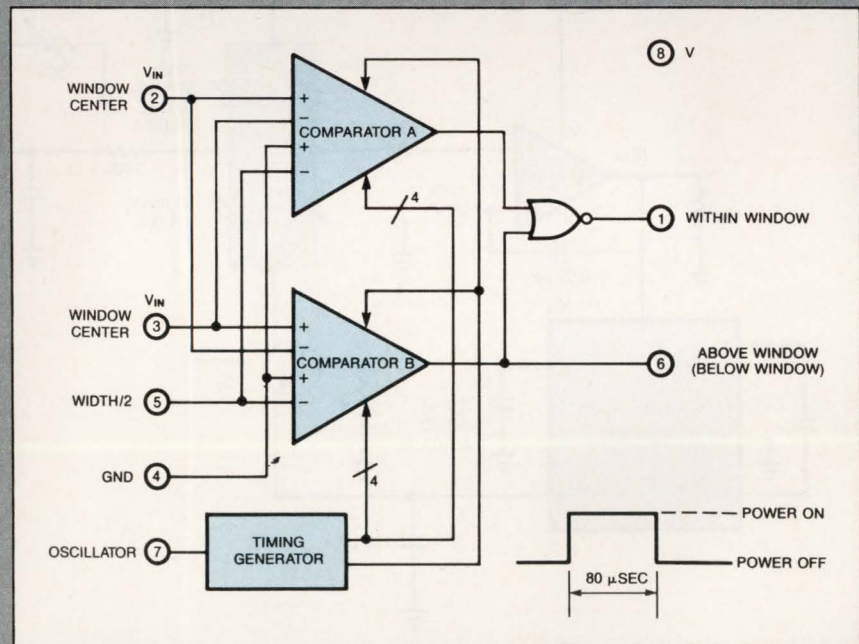

Fig E—The LTC1042 window comparator is similar to the 1040 and 1041 in terms of operating current and sampling characteristics.

The low impedance and low output-voltage of many transducers present special problems in the design of micropower circuits.

circuit in Fig 4 helps to reduce losses caused by the strain-gauge bridge. Rather than operate in a continuously sampled mode, this circuit sits in a quiescent state for long periods, with relatively brief on times.

A typical application for this circuit is the remote measurement of the contents of a storage tank when weekly readings are sufficient. Despite the floating output of the strain-gauge bridge, the circuit has the advantage of not needing a differential amplifier. In addition, it improves measurement accuracy because it provides nearly full-rated drive to the strain bridge. Quiescent current is about 150 μA with on-state current typically 50 mA.

When the base of Q_1 is unbiased, all circuitry is off except the LT1054 positive-to-negative voltage converter. By pulling the base of Q_1 low, its collector supplies power to IC_{1A} and IC_{1B} . The output of IC_{1A} goes high, turning on the LT1054. The pin 5 output of the LT1054 heads toward -5V and Q_2 turns on, permitting the flow of bridge current. The LT1054, with IC_{1A} acting as a

servo, balances the inputs to the bridge and drives the midpoint of the bridge to 0V . The bridge ends up with about 8V across it, and so requires the LT1054, which can handle 100 mA, to sink about 24 mA. The $0.02\text{-}\mu\text{F}$ capacitor then stabilizes the loop.

The negative output of the IC_{1A} and LT1054 loop sets the common-mode voltage of the bridge to zero, allowing IC_{1B} to make a simple single-ended measurement. The output trim adjustment scales the circuit for a 3-mV/V strain-gauge bridge transducer. The $100\text{-k}\Omega$ resistor and $0.1\text{-}\mu\text{F}$ capacitor together provide noise filtering.

2-wire thermistor needs no external supply

Current-loop control in the range of 4 to 20 mA is common in industrial environments, and circuits that are used to modulate data into this type of loop must operate well below the 4-mA minimum current. The 2-wire thermistor used in a complete temperature-transducer interface (Fig 5) has an output in the 4- to

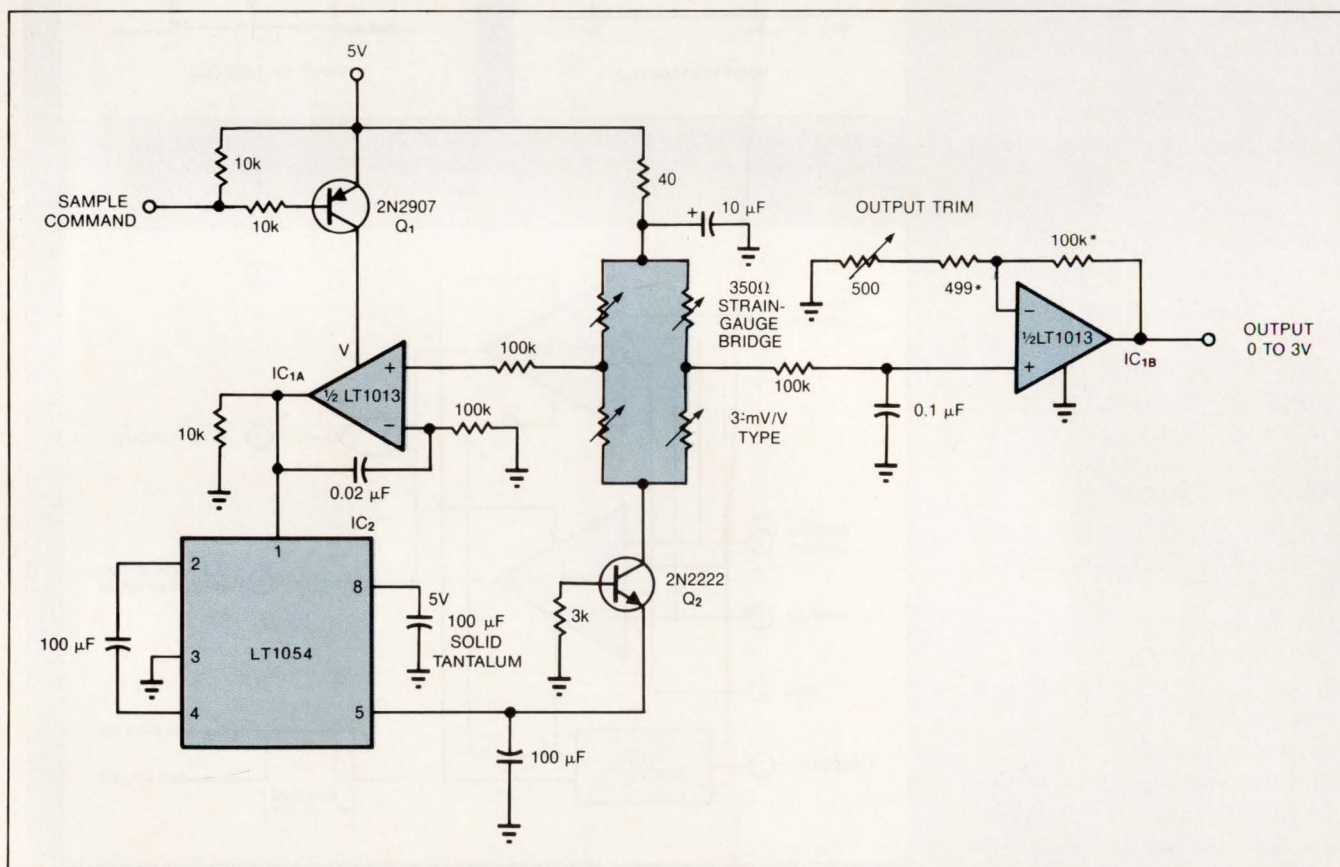

Fig 4—The strobed operation of this circuit uses only 150 μA of quiescent current. Full-rated drive up to 50 mA occurs only on command.

20-mA range. Accuracy for this current-loop circuit is $\pm 0.3^\circ\text{C}$ over a 0 to 100°C range. The circuit does not require an external supply.

By fixing the current well below the 4-mA minimum, the LM134 current source saves the LTC1040 from having to handle too high a supply voltage (see box, "Sampling techniques reduce circuit current"). The LTC1040 senses the thermistor-network output and forces this voltage across the output resistor to set the total circuit current. You can adjust the current by varying the gate voltage of the 2N6657 FET. The comparator output operates in a PWM mode, with the FET-gate voltage filtered by the 1-M Ω resistor and the 1- μF capacitor.

An important feature of the LTC1040 is that very little current—something on the order of nanoamperes—flows from the V- supply. The V- supply therefore connects to ground with negligible current error in the output-sensing resistor. The differential input of the LTC1040 can sense the current through the output resistor because its common-mode range includes the V- supply. You make the trimming adjustments for 0 and 100°C (full scale) by exposing the thermistor to those temperatures or by electrically simulating those conditions.

Fig 6 shows a circuit for a battery-powered thermostat using the LTC1041 and a bridge-connected thermistor to sense the temperature. A potentiometer at the output of the bridge provides a means of setting the temperature. The power for driving the bridge comes

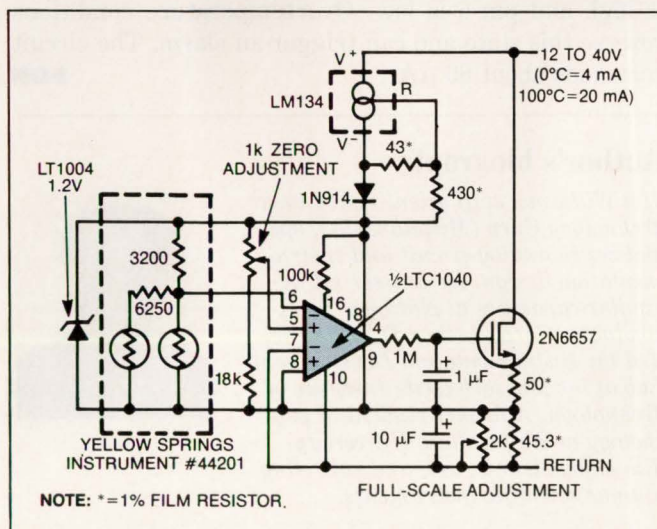

Fig 5—This 2-wire thermistor signal-conditioning circuit requires no external supply. Powered by a current-loop, the circuit accuracy is $\pm 0.3^\circ\text{C}$ over a 100°C range.

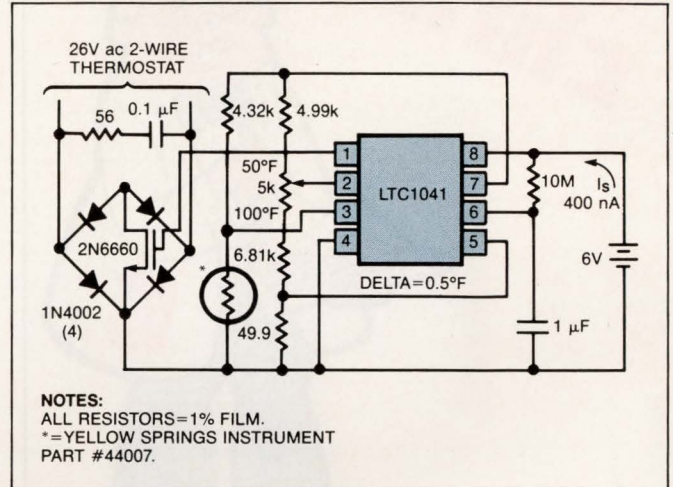

Fig 6—This thermistor-based temperature-sensing circuit uses pulse techniques to limit the current to 1 μA . With a lithium battery, this circuit can operate for over 10 years.

from pin 7 of the LTC1041, not from the battery. Pin 7 is the pulse-power (V_{PP}) output and only turns on when the LTC1041 samples the inputs. A system's average power consumption when this technique is used turns out to be quite small: In this application, total system current is less than 1 μA . This is far less than the self-discharge rate of the battery. A lithium battery can operate this circuit for over 10 years.

An external R-C network sets the sampling frequency. The initiation of an internal sampling cycle turns on power to the comparators and the V_{PP} output. The CMOS latches in the LTC1041 store the resulting outputs of the sampled analog inputs. After the sampling, the circuit switches off the power but keeps the outputs on. The unlocked CMOS logic consumes negligible current.

The sampling process takes approximately 80 μsec . During this interval, the LTC1041 draws about 1.7 mA of current from the 6V supply. Because the sampling rate is low, average power consumption is extremely small. The low sampling rate is adequate for a thermostat, however, because of the low rate of change associated with temperature.

A power MOSFET in the diode bridge switches 26V ac to the heater control circuitry. The MOSFET is a voltage-controlled device that requires no current from the battery. The voltage from pin 5 (DELTA) to pin 4 (GND) sets the dead band. The dead band, which is desirable to prevent excessive cycling in the heating unit under control, equals two times DELTA and is independent of both V_{IN} (pin 3) and setpoint (pin 2).

Keep your
untouchables
untouched with
CLINCHER II™

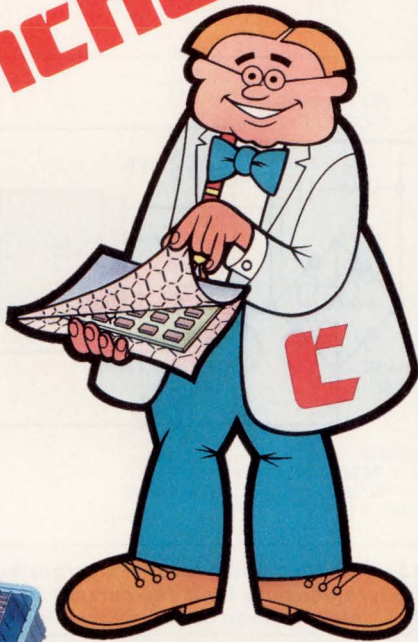

CLINCHER II static-shielding Peel-Back™ Jackets are Customer's response to your need to protect and inspect your components... without subjecting them to unnecessary handling.

Reusable CLINCHER II Jackets enclose your components in layers of cushioned, shielded material that is superior to thin film conductive bags. The unique Peel-Back design offers easy product insertion and inspection. The "clam shell" closing effect permits a natural secure closure. The combination of these benefits make CLINCHER II Jackets ideal for use in tote boxes, one-way shipping cartons and bulk shippers.

CLINCHER II is only part of a total system.

After listening to you and analyzing your packaging situation, your local ADE rep will respond to your needs from the broad base of products and design capabilities at his disposal. CLINCHER™, CANCEL® and CADDY-PACK® are joined together to become an optimum packaging solution engineered to take the anxiety out of transporting your components.

To get in touch with how CLINCHER II Jackets can help protect your products, call us toll free at 1-800/222-0221 or FAX 312/646-3919. Customer will send you—AT NO CHARGE—ADE's Guide to ESD Damage Control.



ADE, Inc.
1430 East 130th Street
Chicago, IL 60633
312/646-3400

CANCEL, CLINCHER and CADDY-PACK are registered trademarks of ADE, Inc. © 1987, ADE, Inc.

CIRCLE NO 35

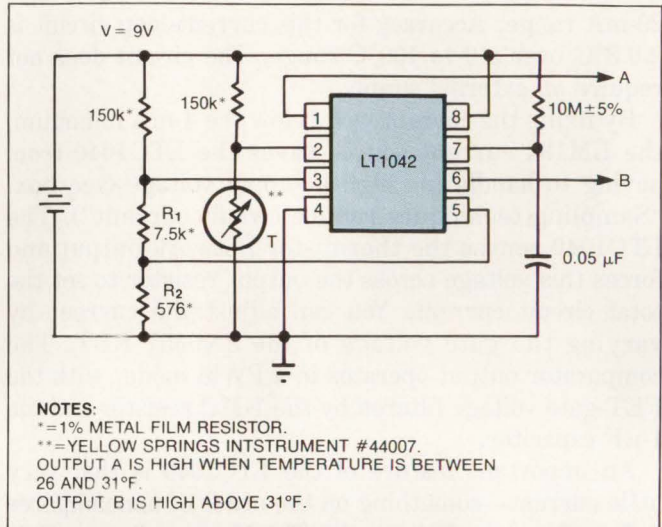

Fig 7—This simple freezer-alarm circuit draws only 80 μ A of current and uses the LTC1042 as a sampling window-comparator.

Thus as you vary the setpoint, the dead band remains fixed at two times DELTA. Conversely, as you vary the dead band, the setpoint stays the same.

Fig 7 is a very simple configuration for a freezer alarm. Circuits such as this one are useful in industrial and home freezers as well as in refrigerated trucks and rail cars. The LTC1042 acts as a sampling window comparator. The 10-M Ω resistor and 0.05- μ F capacitor set a sampling rate of 1 Hz and the bridge-network values program the internal window comparator for the outputs shown. During normal freezer operation, pin 1 is high and pin 6 is low. Overtemperature conditions reverse this state and can trigger an alarm. The circuit consumes about 80 μ A.

EDN

Author's biography

Jim Williams, staff scientist at Linear Technology Corp (Milpitas, CA), specializes in analog-circuit and instrumentation design. He has served in similar capacities at National Semiconductor Corp, Arthur D Little Inc, and the Instrumentation Development Lab at the Massachusetts Institute of Technology. A former student of psychology at Wayne State University, Jim enjoys tennis, art, and collecting antique scientific instruments.

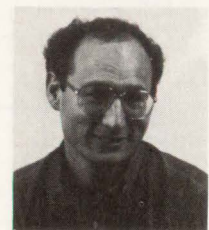

Article Interest Quotient (Circle One)
High 470 Medium 471 Low 472

MICRO-LOGIC II.™

The CAE tool with a 10,000-gate digital simulator for your PC.

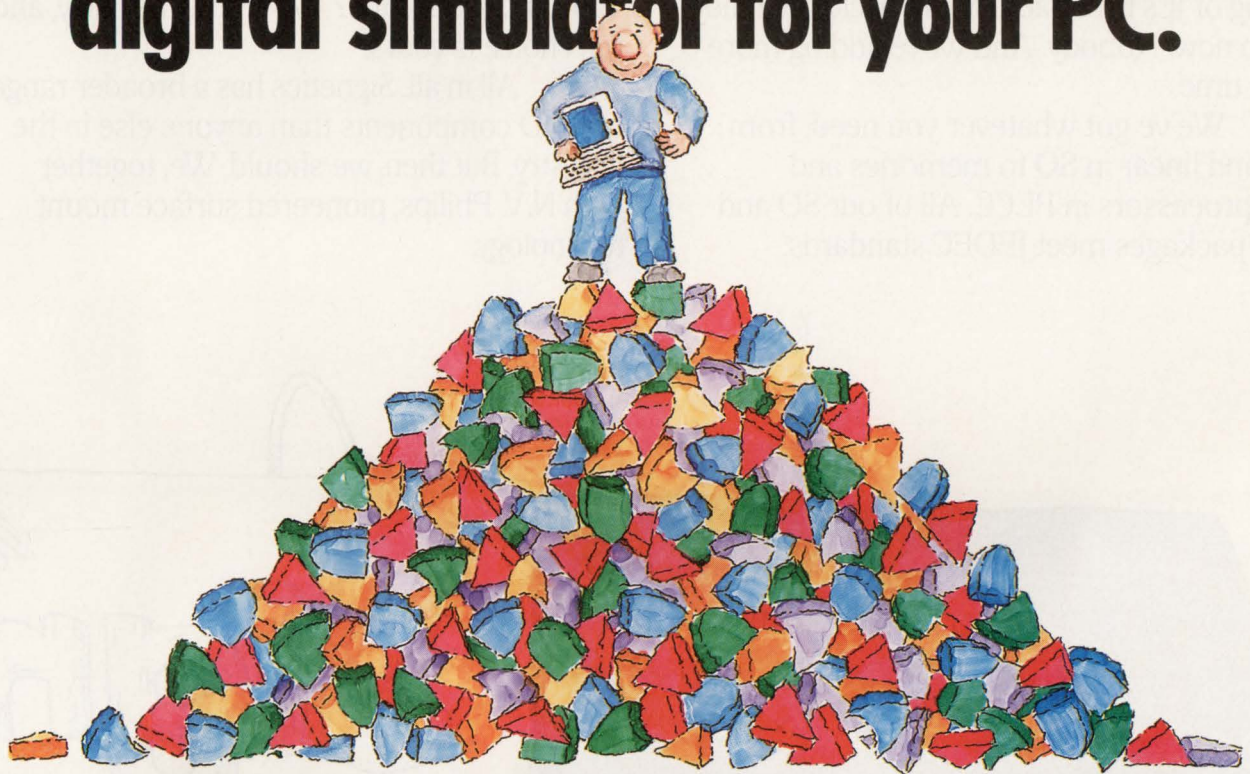

Spectrum Software's MICRO-LOGIC II® puts you on top of the most complex logic design problems. With a powerful total capacity of 10,000 gates, MICRO-LOGIC II helps engineers tackle tough design and simulation problems right at their PCs.

MICRO-LOGIC II, which is based on our original MICRO-LOGIC software, is a field-proven, second-generation program. It has a high-speed event-driven simulator which is significantly faster than the earlier version.

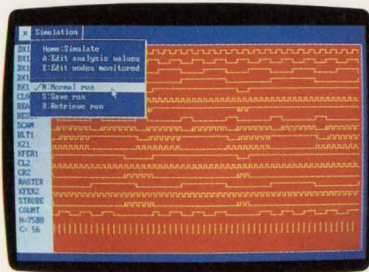

Timing Simulator

The program provides you with a top-notch interactive drawing and analysis environment. You can create logic diagrams of up to 64 pages with ease. The software features a sophisticated schematic editor with pan and zoom capabilities.

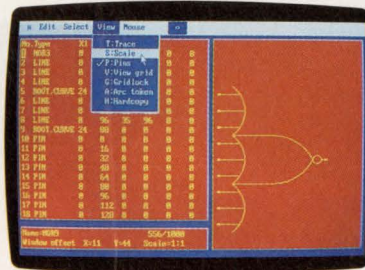

Shape Editor

A 200-type library of standard parts is at your fingertips. And for a new high in flexibility, a built-in shape editor lets you create unique or custom shapes.

MICRO-LOGIC II is available for the IBM® PC. It is CGA, EGA, and Hercules® compatible and costs only \$895 complete. An evaluation version is available for \$100. Call or write today for our free brochure and demo disk. We'd like to put you in touch with a top digital solution.

- Total capacity of 10,000 gates
- Integrated schematic editor
- Fast assembly language routines
- Standard parts library of 200 types
- Event-driven timing simulator

- Built-in shape editor
- Multiple delay models
- Printer and plotter hard copy

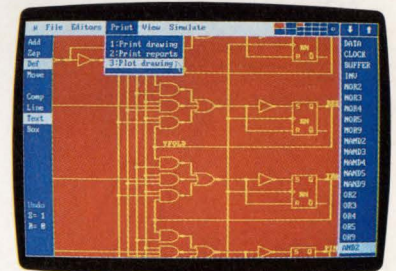

Schematic Editor

spectrum

1021 S. Wolfe Road, Dept. E
Sunnyvale, CA 94087
(408) 738-4387

MICRO-LOGIC II is a registered trademark of Spectrum Software.
Hercules is a registered trademark of Hercules Computer Technology
IBM is a registered trademark of International Business Machines, Inc.

SMDs TO GO.

When you want most any SMD IC, and you want it now, just keep on doing what you've probably been doing all along: Call Signetics first.

Because nobody has as broad an offering of ICs in surface mount packages ready to ship now. Nobody. And we're adding more all the time.

We've got whatever you need, from logic and linear in SO to memories and microprocessors in PLCC. All of our SO and PLCC packages meet JEDEC standards.

Our free SMD pocket guide lists everything available. SO and PLCC package drawings, too.

How do you want to get your SMDs? Tape and reel? Tube? We ship either way, and the choice is yours.

All in all, Signetics has a broader range of SMD components than anyone else in the industry. But then, we should. We, together with N.V. Philips, pioneered surface mount technology.



So when you put that level of experience together with the industry's toughest quality standard—Zero Defects—there's no contest between Signetics and anyone else.

When you're looking for surface mount ICs, look to Signetics. Odds are, we have it made.

One standard. *0* defects.
Signetics

a subsidiary of U.S. Philips Corporation

800-227-1817 x 966D

CIRCLE NO 76

Please send me more info on Signetics SMDs.

EDN 080687

- Free SMD Pocket Guide.
- Library of SMD technology papers.
- Put me on your mailing list.

Name _____

Position _____

Company _____

Division _____

Address _____

City _____ State _____ Zip _____

Phone _____

Product Interest _____

Send coupon to: Signetics Corporation, 811 E. Arques Ave., P.O. Box 3409, Sunnyvale, CA 94088-3409, Attn: Publications Services, M/S 27

966

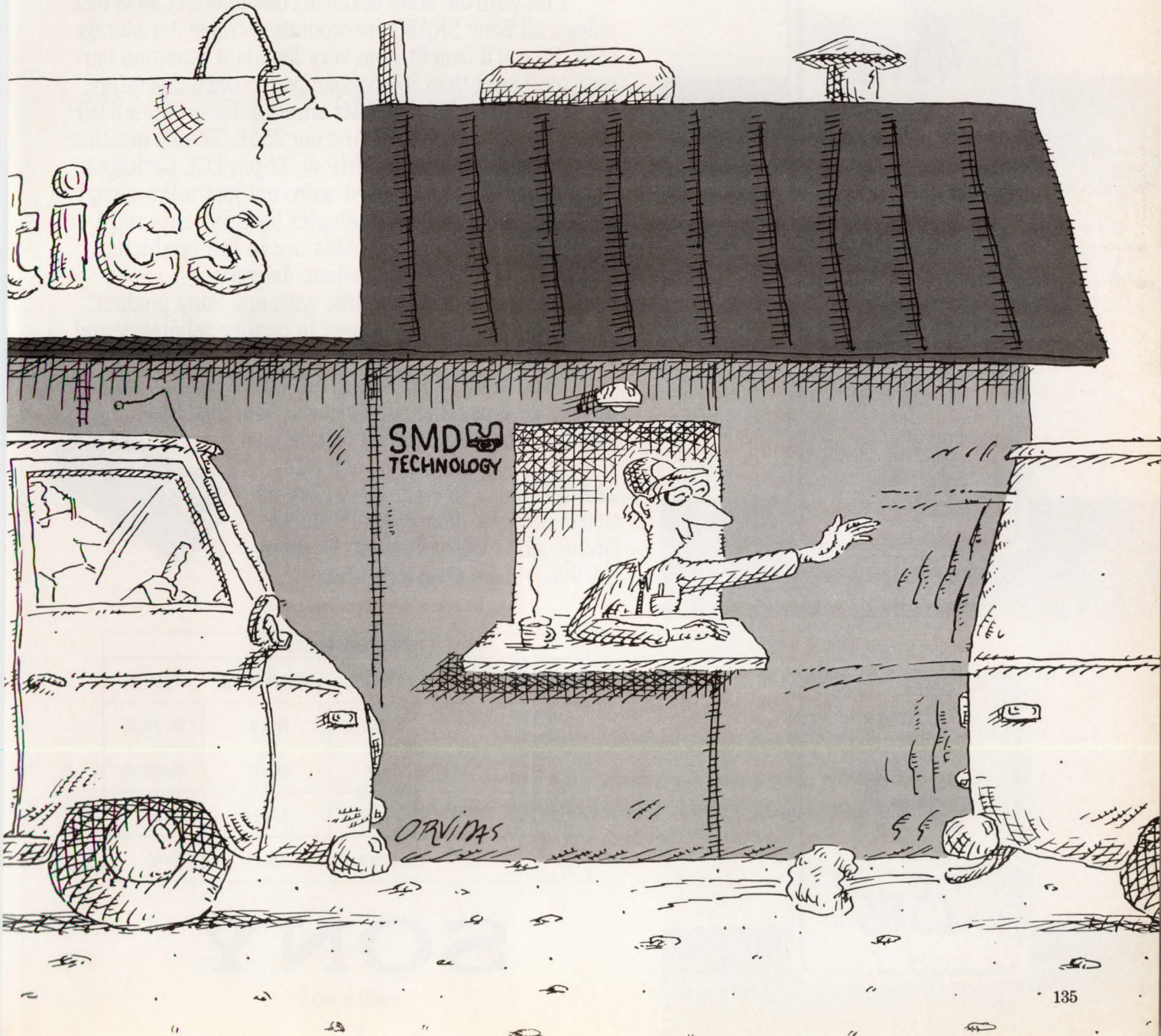

SONY SETS NEW RECORDS IN SRAM PERFORMANCE.

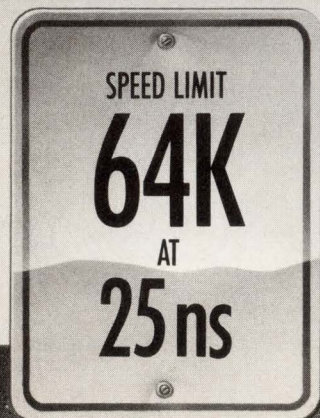
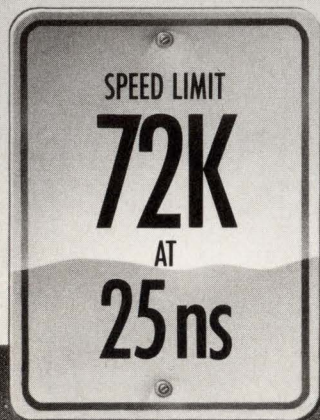

To help your designs push the limits of high-speed performance, design in Sony's high-speed SRAMs.

Because our SRAMs, featuring full-CMOS technology, offer perhaps the fastest access times of any SRAMs available.

Speeds of up to 25 ns in 64K configurations. 25 ns in 72K configurations. And 45 ns in 256K configurations.

Plus with our state-of-the-art one-micron CMOS technology, all Sony SRAMs incorporate 6-transistor storage cells. So you'll benefit from very low data retention current, too. Lower than 500 nanoamps at room temperature.

Our 64K and 72K SRAMs are available in 300-mil DIP packages. And our 256K SRAMs in either 600-mil DIP or 32-pin LCC packages.

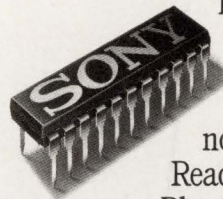

And we're not just talking engineering samples here. Because right now, our SRAMs are in full production.

Ready for immediate delivery.

Plus of course, like with any Sony product, you're also assured the utmost in quality, reliability and performance.

So put Sony's high-speed, full-CMOS SRAMs to work in your designs. Then who knows? Your systems may set some performance records, too.

To get all the details, call (714) 229-4192 today. Or write Sony Corporation of America, Component Products Group, 10833 Valley View St., Cypress, CA 90630. FAX (714) 229-4271.

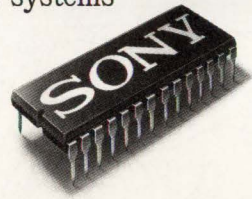

| SONY SRAM DEVICES | | | |
|----------------------------------|---------|--------------|------------|
| PART NUMBER— PACKAGE | DENSITY | ORGANIZATION | SPEED (ns) |
| CXK5863P—25/30/35 300 mil DIP | 64K | 8K x 8 | 25/30/35 |
| CXK5971P—25/30/35 300 mil DIP | 72K | 8K x 9 | 25/30/35 |
| CXK58255P—45/55 600 mil DIP | 256K | 32K x 8 | 45/55 |
| CXK58255K—45/55 32 pin LCC | 256K | 32K x 8 | 45/55 |

SONY®

CIRCLE NO 77

Sequential-test techniques maximize throughput in tests

You're wasting time if you test an obviously defective system as thoroughly as a system that comes close to meeting its specification. By performing a sequential test, which evaluates results after each trial, you can determine whether a system warrants further testing.

R F Cobb, *Harris Corp*

When you test a system that has statistical specifications, you can't measure the system's characteristics exactly. You have to measure the system repeatedly and determine the mean of the results. Clearly, this type of test takes a long time, but you can shorten the length of your test by measuring each system only long enough to determine whether the system meets its specifications.

Your test should be able to determine when the outcome is predictable enough to discontinue testing. You shouldn't need to test a unit that is far better or worse than its specification for as long as you test a system that is marginal. Once you know whether a unit passes or fails, further testing is unproductive.

You can determine the certainty of the result of your test by using the sequential test. To conduct such a test, you pose a null hypothesis (H_0) and calculate the minimum number of trials needed to dismiss or accept the hypothesis. **Ref 1** describes the hypothesis test.) The sequential test requires only a few trials if the equipment is far better or far worse than required. For equipment that comes close to its specifications, the test lasts longer.

The sequential test is an extension of the likelihood-ratio test, and thus both tests use the same basic equations. (For a review of these equations, see **box**, "Equations are key to sequential-test comprehension.") However, the likelihood-ratio test isn't intelligent, and the sequential test is. The number of trials (n) in a sequential test isn't a predetermined number: The sequential test assesses the need for more trials as a test progresses.

Suppose, for example, that you're testing a receiver for a bit-error rate of 10^{-5} and you've determined that, to obtain your desired probabilities of error α and β , you need $n=10^7$ trials and a mean (m) that is $\leq 2 \times 10^{-5}$. Thus, $n \times m$ must be less than or equal to 200—the unit fails if you record 201 errors.

Now assume that you measure 90 errors during the first 10^3 bits. The receiver will fail if you record 111 errors in the next 9.999×10^6 bits. Considering that you've recorded a bit-error probability of 9×10^{-2} already, you'll almost surely record a bit-error probability greater than 1.11×10^{-5} during the remainder of the test. The receiver is almost certain to fail, so further tests are a waste of time. In this example, the outcome is obvious. But when the outcome is less obvious, you can still use the sequential test to justify terminating a test.

Because the number of samples in a sequential test isn't fixed, you need more samples when θ_0 and θ_1 are nearly equal than when they differ by a great amount. You also need a large number of samples if you want to minimize the probability of error.

To calculate a likelihood ratio for a sequential test, start by choosing a pair of constants, A and B (**Ref 2**):

$$0 < B < 1 \quad 1 < A < \infty.$$

The likelihood ratio for the sequential test λ is the

The number of trials in a sequential test isn't a predetermined number—the sequential test assesses the need for more trials as the test progresses.

reciprocal of the general likelihood ratio λ_L ,

$$\lambda = \frac{P(x_1|\theta_1)P(x_2|\theta_1) \dots P(x_n|\theta_1)}{P(x_1|\theta_0)P(x_2|\theta_0) \dots P(x_n|\theta_0)} \quad (1)$$

There's no mathematical reason for inverting the ratio—it's simply a matter of convention.

After i trials, compute the likelihood ratio $\lambda(i)$ and

if $\lambda(i) \leq B$, accept H_0 ;
 if $\lambda(i) \geq A$, reject H_0 ;
 if $B < \lambda(i) < A$, take another sample.

The sequential test is like the general likelihood-ratio test in that, after a number of trials, you compare λ to a constant and decide whether to accept or reject H_0 . But, in contrast to the likelihood-ratio test, the constants A and B replace the single constant k . Moreover, you compute λ after each trial. The two constants determine whether a test has reached the stage where you can make a decision.

Sequential test has potential drawbacks

Although you must continue testing until λ falls outside a certain range, all sequential tests end after a finite number of samples (Ref 2). Nonetheless, the number of trials can be large, and therefore you should set a cap on the number of samples. This cap can distort test statistics, of course, but if you specify a cap large enough so that you conclude most tests before the cap is reached, the effect is negligible.

The sequential test has two disadvantages. First, because you must check your results after every trial, the test can't be left to run unattended. Second, it's hard to characterize the test's key performance parameters: its accuracy and efficiency.

Calculate the comparison thresholds

To analyze the probability that a sequential test will give an erroneous result, you must begin by calculating the values of the comparison thresholds A and B . Set A and B to produce your desired values of α and β . If you choose

$$A = \frac{1-\beta}{\alpha}$$

$$B = \frac{\beta}{1-\alpha}$$

the sensitivity of your test will be very close to what you want. The bounds on the actual performance parameters, α' and β' , are

$$\alpha' \leq \frac{\alpha}{1-\beta}$$

$$\beta' \leq \frac{\beta}{1-\alpha}$$

Because α and β are both small, the actual values of the error probabilities, α' and β' , can't be much larger than the desired values of the error probability, α and β . In fact, because the definitions of α' and β' specify upper boundaries, the actual values of α' and β' are often lower than your planned values.

Try a Gaussian distribution of samples

Eq 1 indicates that solving for λ in a test with n trials requires $2n$ multiplications. However, it's often possible to implement a sequential test without multiplying. You can calculate the likelihood ratio for a continuous Gaussian random variable by taking the natural logarithm of Eq 1. For a Gaussian distribution having a known variance σ^2 and an unknown mean μ , the logarithm of the likelihood ratio reduces to a simple sum of the values taken at each sample. The likelihood ratio at the n th sample is

$$\lambda' = \sum_{i=1}^n x_i \quad (2)$$

Then, for $\mu_1 > \mu_0$,

if $\lambda' \leq B'$, accept H_0 ;
 if $\lambda' \geq A'$, reject H_0 ;
 otherwise, take another sample.

The inequalities reverse if $\mu_0 > \mu_1$. The equations for A' and B' are

$$A' = \frac{\sigma^2 \ln(A)}{\mu_1 - \mu_0} + n \frac{\mu_0 + \mu_1}{2} \quad (3)$$

$$B' = \frac{\sigma^2 \ln(B)}{\mu_1 - \mu_0} + n \frac{\mu_0 + \mu_1}{2} \quad (4)$$

Eq 2 shows that a sequential test of a Gaussian distribution doesn't require any multiplication or division; you simply add each new sample, x_i , to the running

Equations are key to sequential-test comprehension

In a hypothesis test (**Ref 1**), you guess the value of a parameter, θ , and then perform tests until you collect sufficient evidence to see if the guess is right. The initial guess is the null hypothesis, H_0 . The null hypothesis makes the statement that the value of θ is θ_0 .

Part of the test process involves deciding how close to θ_0 your results must be to decide that H_0 is true. To make this decision, you must define an alternate hypothesis, H_1 , against which to compare H_0 . H_1 makes the statement that the value of θ is θ_1 . After performing a test, you compare the test results with the two hypotheses and decide which hypothesis to accept.

Because you can't perform a perfect test, you can err in choosing one of the two hypotheses. If H_0 is true, but you decide that it's false, you commit a Type I error. The probability of producing a Type I error in a statistical test is α . If H_0 is false, but you decide it's true, you commit a Type II error. The probability of making a Type II error is β .

Deliberately bias results

Often you want to favor one type of error over the other type. For example, if you're testing an edible product for bacteria count, you want to make sure that you don't release tainted food—even though you may destroy some batches of good product. You can prevent the release of contaminated food by biasing your test to favor rejection.

To determine the value of a bias (the values of α and β), you may use risk analysis, game theory, or educated guessing. Once you set α and β , you must design your hypothesis test to obtain these values.

The likelihood-ratio test finds the acceptance criteria that will produce your desired values of α and β . To introduce a bias to a hypothesis test, you find a likelihood ratio λ_L that satisfies

$$\lambda_L = \frac{P(s|\theta_0)}{P(s|\theta_1)} \quad (1)$$

where $P(s|\theta_0)$ is the conditional probability of measuring the data s if θ_0 is the true value of θ and $P(s|\theta_1)$ is the conditional probability of measuring s if θ_1 is true.

For each test,

if $\lambda > k$, accept H_0 ;
if $\lambda < k$, reject H_0 ;
and if $\lambda = k$, do either.

The value of k ($k > 0$) determines the likelihood of choosing H_0 . When you decrease k , you increase

the likelihood of accepting H_0 (α decreases, β increases).

Once you set the bias of your test, you can tie the results of all trials into **Eq 1**. If the measured data consists of a set of independent results, x_1, x_2, \dots, x_n , then $P(s|\theta_0)$ is $P(x_1 \text{ and } x_2 \text{ and } \dots \text{ and } x_n|\theta_0)$ is the conditional probability of observing those n results if θ_0 is the true value of θ . If the results are independent,

$$P(s|\theta_0) = P(x_1 \text{ and } x_2 \text{ and } \dots \text{ and } x_n|\theta_0) \\ = P(x_1|\theta_0)P(x_2|\theta_0)\dots P(x_n|\theta_0). \quad (2)$$

Substituting **Eq 2** into **Eq 1** gives

$$\lambda_L = \frac{P(x_1|\theta_0)P(x_2|\theta_0)\dots P(x_n|\theta_0)}{P(x_1|\theta_1)P(x_2|\theta_1)\dots P(x_n|\theta_1)}. \quad (3)$$

Eq 3 is valid for discrete or continuous probability densities.

If a likelihood-ratio test includes hundreds of trials, it also has to include $2 \times$ hundreds of multiplication operations (to implement **Eq 3**). Although performing the multiplication is a time-consuming process, you can often simplify the likelihood ratio and avoid the multiplication by using the logarithm of the likelihood ratio as described in the main text.

Eq 3 is exact for a simple hypothesis such as $\theta = 0.5$. For a composite hypothesis, such as $\theta_0 < 0.5$, you can't define the likelihood exactly.

Suppose you design a radar receiver for a bit-error probability $P(e)$ that has a null hypothesis of $P(e) < 10^{-5}$ and an alternate hypothesis of $P(e) > 10^{-3}$. At every value of θ , α and β have different values. To find the likelihood ratio for this system, you simply choose values of θ_0 and θ_1 . For example, you could choose $\theta_0 = 10^{-5}$ and $\theta_1 = 10^{-3}$.

At the chosen values of θ_0 and θ_1 , you set α and β as if the hypotheses were simple. If the actual value of θ differs from either of the hypothesis values, it will have values of α and β that you can't control. You can compute the values and plot α and β over a wide range of θ , however. Even though you can control the test performance exactly only for simple hypotheses, you have the capability of knowing what the actual performance is at any point.

Reference

1. Cobb, R F, "Use statistics to test communications systems efficiently," *EDN*, January 8, 1987, pg 143.

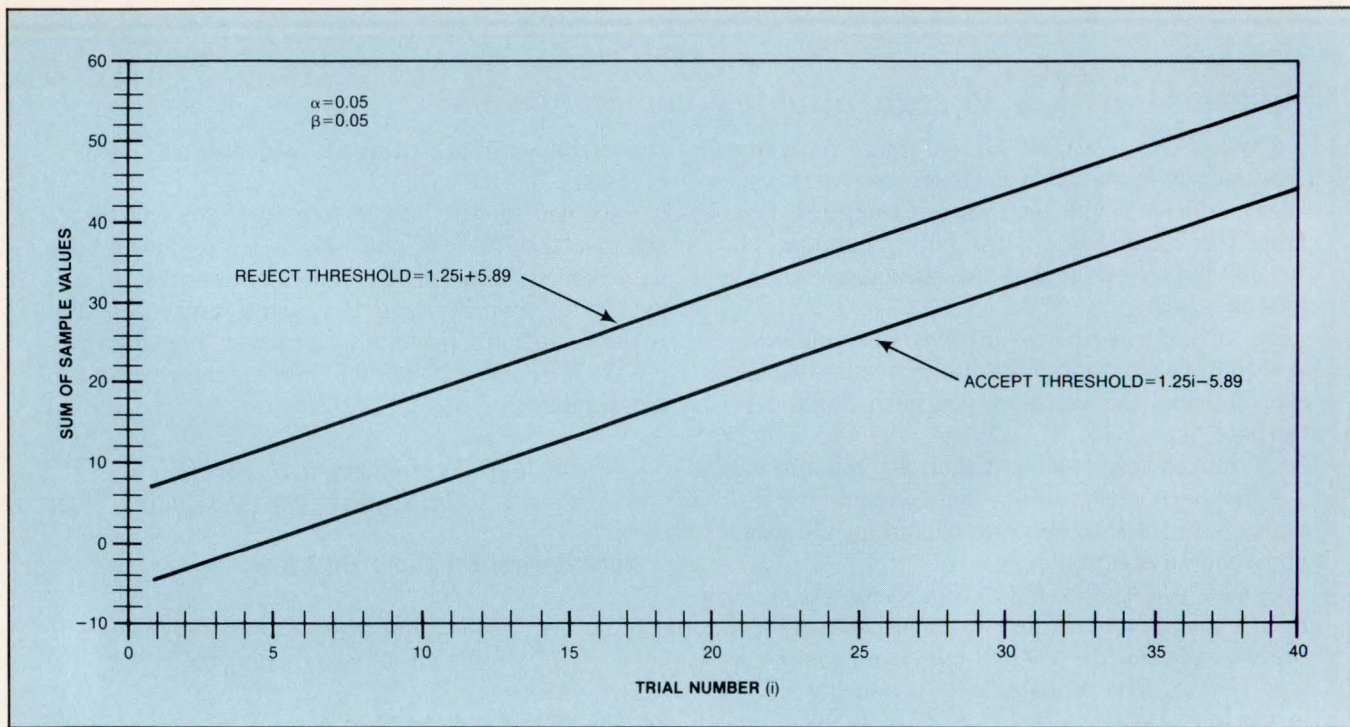

Fig 1—The straight lines indicate the thresholds for testing the null hypothesis, mean=1.0, vs the alternate hypothesis, mean=1.5, for a Gaussian random variable having a variance of 1.0. The unit under test passes by crossing the acceptance threshold at the 22nd trial.

total. Eqs 3 and 4 show that the thresholds (A' and B') aren't constants; they change linearly with the number of trials (n). Except for n , all the quantities in Eqs 3 and 4 are fixed, so you can plot or tabulate A' and B' vs n before you begin your test. You can then compare λ' with the tabulated threshold values.

Eqs 3 and 4 show that the threshold values are parallel straight lines. Their slopes depend on the average value of the two hypothesized means. The distance between the parallel lines depends on the ratio of A to B (the difference between their logarithms) and the size of the difference in the hypothesized means.

Fig 1 plots the acceptance and rejection criteria as a function of the number of measurements for one set of parameters. As long as the running total remains between the lines, the test must continue. If the total rises above the upper line, you reject H_0 ; if it falls below the lower line, you accept H_0 (assuming $\mu_1 > \mu_0$). You can confirm the plausibility of Fig 1 by observing that if the difference between μ_1 and μ_0 is small, A' and B' are large. In this case, the threshold lines are far apart and you'll have to perform many measurements to reach a decision.

Try a binomial distribution of samples

The procedure for developing a sequential test for a binomial distribution is similar to the one for a Gaussian distribution. You can express the likelihood ratio as

$$\lambda' = \frac{{}_n C_x P_1^x q_1^{n-x}}{{}_n C_x P_0^x q_0^{n-x}}$$

where p_i is the probability of an event occurring during

any one trial; $q_i = 1 - p_i$; x is the number of successes that have occurred; and ${}_n C_x = n!/[x!(n-x)!]$. Ref 1 gives p_i for a binomial distribution.

After you cancel common factors and take the natural logarithm (to remove exponents), the equation becomes

$$\ln(A) \leq x \ln(p_1) + (n-x) \ln(q_1) - x \ln(p_0) - (n-x) \ln(q_0) \leq \ln(B), \quad (5)$$

where $\ln(A)$ is the rejection threshold and $\ln(B)$ is the acceptance threshold. If you solve for the number of successes, x , as a function of the number of failures, $w = n - x$, you can express Eq 5 as

$$\frac{\ln(A) - w \ln(q_1/q_0)}{\ln(p_1/p_0)} \leq x \leq \frac{\ln(B) - w \ln(q_1/q_0)}{\ln(p_1/p_0)},$$

when $p_1 > p_0$. For a binomial distribution, the definition of the likelihood ratio becomes $\lambda' = x$. The rules of the sequential test are

$$\begin{aligned} &\text{if } \lambda' \leq B', \text{ accept } H_0; \\ &\text{if } \lambda' \geq A', \text{ reject } H_0; \end{aligned}$$

otherwise, take another sample.

This is true for

$$A' = \frac{\ln(A) - w \ln(q_1/q_0)}{\ln(p_1/p_0)} \quad (6)$$

$$B' = \frac{\ln(B) - w \ln(q_1/q_0)}{\ln(p_1/p_0)}. \quad (7)$$

If $p_1 < p_0$, the inequalities reverse.

Although you must continue testing until the likelihood ratio falls outside of a certain range, all sequential tests end after a finite number of samples.

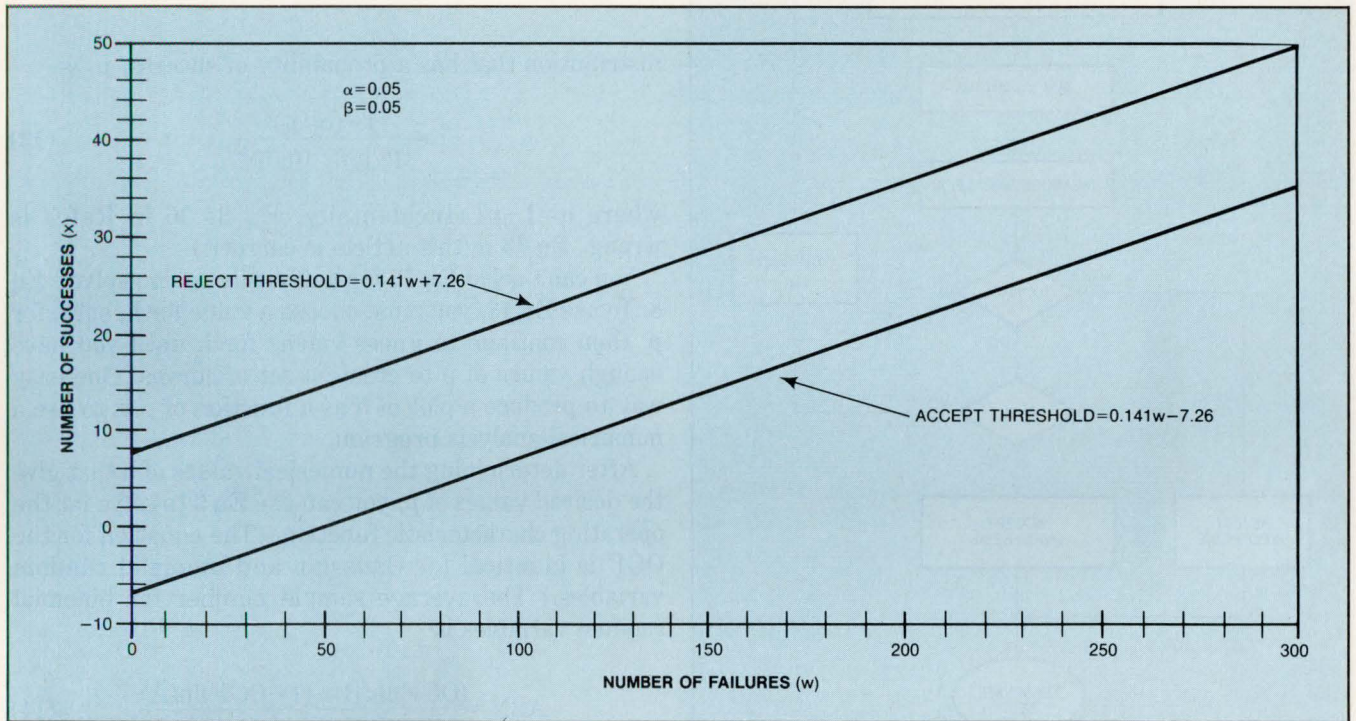

Fig 2—These parallel lines represent the thresholds for testing a null hypothesis, $p_0=0.1$, vs an alternate hypothesis, $p_1=0.15$, for a binomial distribution. Because p is the probability of success, and $p_0 < p_1$, units pass when the number of failures is large.

Eqs 6 and 7 are of the form $c_i - (w \times k)$, where c_i and k are constants for any given set of test parameters. Therefore, just as for the Gaussian random variables, the sequential test for binomial random variables boils down to a simple set of operations.

To perform a sequential test on a binomial distribution, you plot (or tabulate) the number of successes, x , against the number of failures, w . Then you compare x against calculated values of A' and B' at each trial. Fig 2 shows an example of this type of test.

Characterization may prove difficult

Although you may intuitively expect the sequential test to require fewer trials than a fixed-length test, you don't have to rely on your intuition. You can quantify the advantage of a sequential test over a fixed-length test by calculating the reliability of the sequential test.

The primary benchmarks that characterize a hypothesis test are its operating characteristic function (OCF) and its average sample number (ASN). The OCF is the probability of accepting H_0 , plotted against values of the test quantity, θ . The ASN is the average number of samples that you must measure to reach a decision. Thus, the OCF gives the accuracy of the test; the ASN measures its efficiency. You can't calculate the ASN or the OCF exactly for a sequential test, but you can

approximate these quantities (Ref 3).

To calculate the efficiency (ASN) of a sequential test for a Gaussian random variable, you start by defining a parameter h as

$$h = \frac{\mu_1 + \mu_0 - 2\mu}{\mu_1 - \mu_0} \quad (8)$$

Then, express the OCF and the ASN as

$$\text{OCF} = \frac{A^h - 1}{A^h - B^h} \quad (9)$$

$$\text{ASN} = \frac{(\text{OCF})\ln(B) + (1 - \text{OCF})\ln(A)}{(\mu_1 - \mu_0)\mu - (\mu_1^2 - \mu_0^2)/2} \quad (10)$$

When $\mu = \mu_0$, $h=1$; when $\mu = \mu_1$, $h=-1$. The ASN is close to its maximum value when $h=0$. Because usually you need to know how many trials you'll need in the worst case (of an average number of trials), you must determine the value of ASN when $h=0$. To solve Eqs 9 and 10 for $h=0$, you use L'Hospital's rule:

$$\lim_{h \rightarrow 0} \frac{F(h)}{G(h)} = \frac{dF}{dG} \cdot \frac{dG}{dh}$$

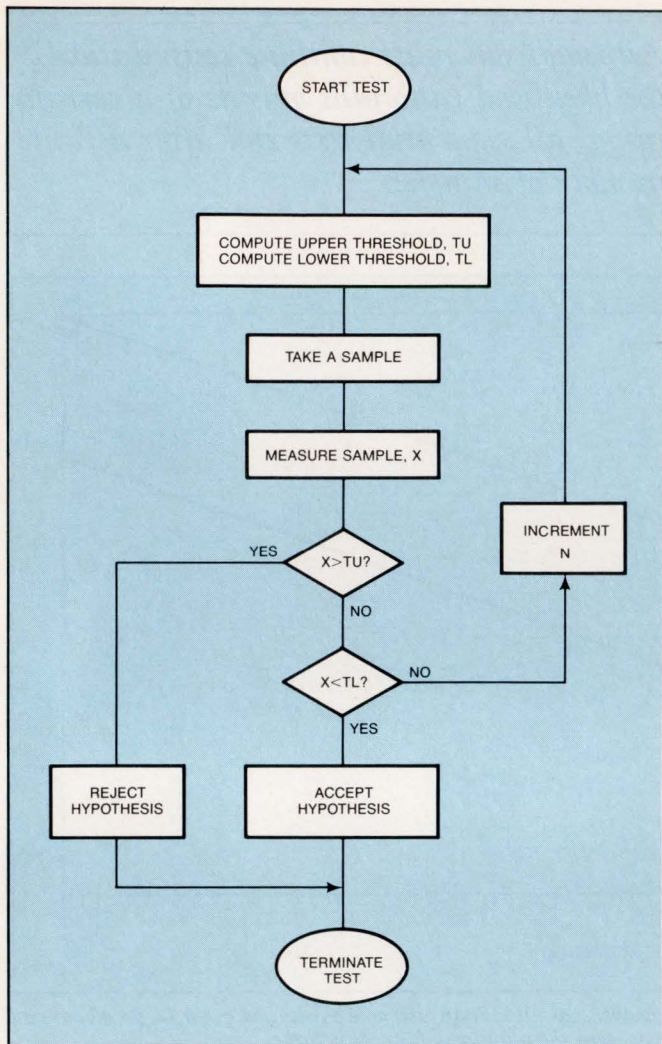

Fig 3—In this flow chart of a sequential hypothesis test, a Monte-Carlo random-number generator produces the data. Depending on how you specify the acceptance criteria, you may need to interchange the acceptance and rejection blocks.

To find the OCF when $h=0$, you use L'Hospital's rule once on Eq 9; to find the ASN, you must use the rule twice:

$$OCF(h=0) = \frac{\ln(A)}{\ln(A) - \ln(B)} \quad (11)$$

$$ASN(h=0) = \frac{\ln(A)\ln(B)}{(\mu_0 - \mu_1)^2} \quad (12)$$

Solving Eq 8 for μ when $h=0$ tells you the approximate value of μ that produces the largest value of ASN. It is the average value of the two hypothesis means, μ and μ_0 . But note that the values given by these equations are approximate. Particularly when the ASN is small, a simulation can characterize a test better than an approximation.

To simulate a sequential test, you generate a set of random numbers and measure their OCF and ASN. You can implement a Monte-Carlo simulation of random numbers by using Fig 3's flow chart.

The definition of the parameter, h , for a binomial

To analyze a sequential test's sensitivity to the probability of error, you must begin by calculating the values of the comparison thresholds.

distribution that has a probability of success, p , is

$$p = \frac{1 - (q_1/q_0)^h}{(p_1/p_0)^h - (q_1/q_0)^h} \quad (13)$$

where $q=1-p$. (Incidentally, Eq 34.36 in Ref 3 is wrong. Eq 13 in this article is correct.)

You can't solve Eq 13 for h as easily as you solved Eq 8. To use Eq 13, you must choose a value for h , solve for p , then continue to guess values for h until you have enough values of p to create a set of curves. One easy way to produce a plot of h as a function of p is to use a numerical-analysis program.

After determining the numerical values of h that give the desired values of p , you can use Eq 9 to solve for the operating characteristic function. (The equation for the OCF is identical for Gaussian and binomial random variables.) The average sample number for binomial random variables is

$$ASN = \frac{(OCF)\ln(B) + (1 - OCF)\ln(A)}{p\ln(p_1/p_0) + q\ln(q_1/q_0)} \quad (14)$$

To find the ASN when $h=0$, you must apply L'Hospital's rule three times:

$$ASN(h=0) = \frac{\ln(A)\ln(B)}{\ln(q_1/q_0)\ln(p_1/p_0)} \quad (15)$$

An application for Gaussian variables

Now that you know how to design and characterize a sequential test, you can compare the sequential test to the fixed-length test (Ref 1). To perform a representative comparison, evaluate a sequential test of a Gaussian random variable that produces $\alpha=\beta=0.01$. Using Eqs 3 and 4,

$$\begin{aligned} \text{if } \lambda(i) < -2.298 + 1.5i, & \text{ accept } H_0; \\ \text{if } \lambda(i) > 2.298 + 1.5i, & \text{ reject } H_0. \end{aligned}$$

H_0 is the hypothesis that the mean is 1.4; H_1 is the hypothesis that the mean is 1.6; i is the sample number; and σ^2 is 1.0. Because $\alpha=\beta$, the thresholds at $i=0$ are symmetrical about zero.

Fig 4 shows this test's OCF. For this example, the approximation from Eqs 9 and 11 is quite good; the approximation agrees with the simulation. Fig 5 plots the ASN curve. The difference between the approximation and the simulation is greater than in Fig 4, but the percentage error is small.

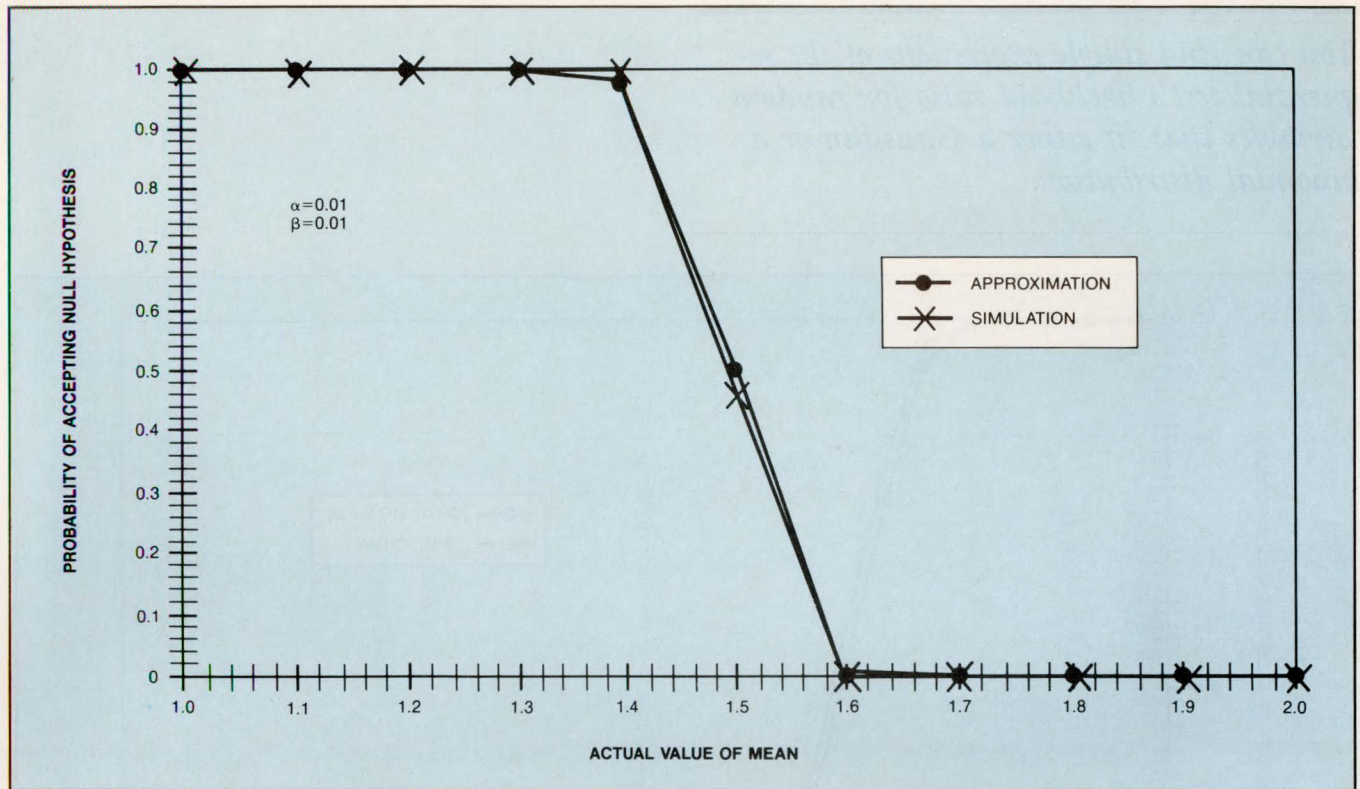

Fig 4—In this OCF plot of a sequential test for a Gaussian random variable with a variance of 1.0, the test compares the null hypothesis, mean=1.4, and the alternate hypothesis, mean=1.6.

As a general rule, the approximations become more accurate as the number of samples becomes larger. If you measure large numbers of samples when α and β are small, it appears that the approximations are more accurate for small values of α and β . The largest ASN in

Fig 5 occurs midway between the two hypothesis values. The maximum point is at the exact midpoint because the two error values are equal, but the maximum ASN is always between H_0 and H_1 .

For a fixed-length test that produces $\alpha=\beta=0.01$, the

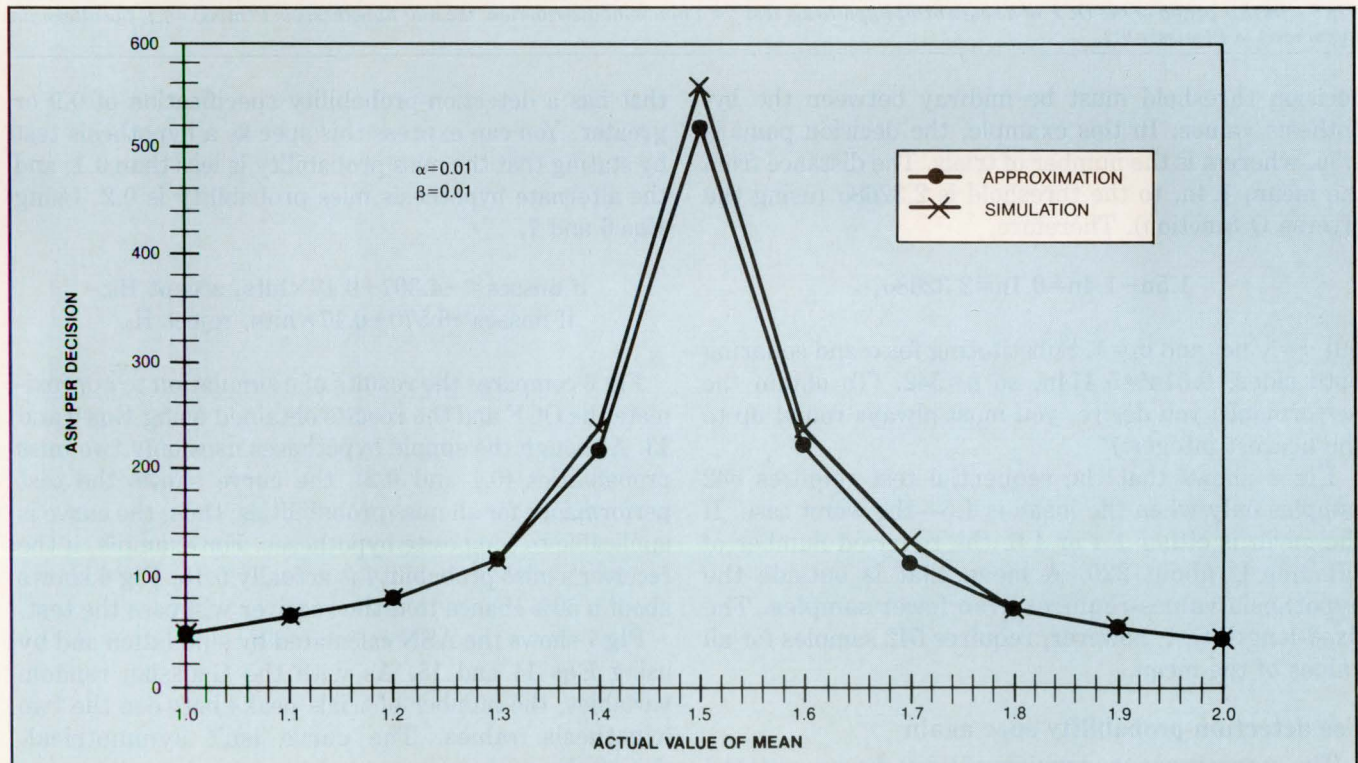

Fig 5—This figure plots the ASN curve for the test performed in Fig 4. Because $\alpha=\beta$, the curve is symmetric. The simulations always result in higher numbers of samples than the approximations.

You can find simple expressions of the sequential test's likelihood ratio for random variables that fit either a Gaussian or a binomial distribution.

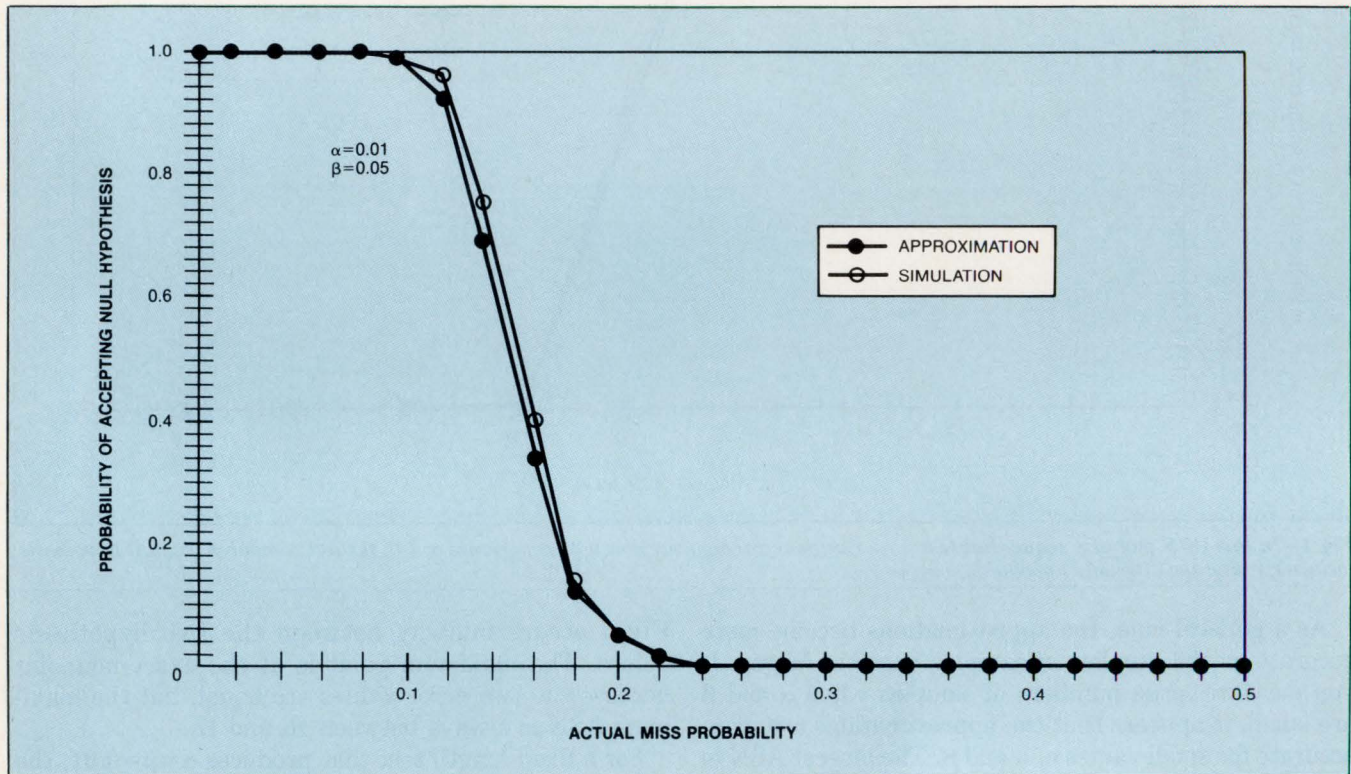

Fig 6—In this graph of the OCF of a sequential hypothesis test for a binomial distribution, the null hypothesis is $P(\text{miss})=0.1$; the alternate hypothesis is $P(\text{miss})=0.2$.

decision threshold must be midway between the hypothesis values. In this example, the decision point is $1.5n$, where n is the number of trials. The distance from the mean, $1.4n$, to the threshold is 2.3268σ (using the inverse Q function). Therefore,

$$1.5n - 1.4n = 0.1n = 2.3268\sigma,$$

but $\sigma = \sqrt{n}\sigma_0$ and $\sigma_0 = 1$. Substituting for σ and squaring both sides, $0.01n^2 = 5.414n$, so $n = 542$. (To obtain the performance you desire, you must always round up to the nearest integer.)

Fig 5 shows that the sequential test requires 542 samples only when the mean is 1.5—the worst case. If the mean is either 1.4 or 1.6, the required number of samples is about 220. A mean that is outside the hypothesis values requires even fewer samples. The fixed-length test, however, requires 542 samples for all values of the mean.

Use detection-probability spec again

The reduction in the number of trials for a sequential test of a binomial random variable is similar to that of a Gaussian variable. Consider the case of a radar receiver

that has a detection-probability specification of 0.9 or greater. You can express this spec as a hypothesis test by stating that the miss probability is less than 0.1, and the alternate hypothesis miss probability is 0.2. Using Eqs 6 and 7,

$$\begin{aligned} \text{if misses} < -4.307 + 0.17 \times \text{hits, accept } H_0; \\ \text{if misses} > 6.570 + 0.17 \times \text{hits, reject } H_0. \end{aligned}$$

Fig 6 compares the results of a simulation to approximate the OCF and the results obtained using Eqs 9 and 13. Although the simple hypotheses uses only two miss probabilities (0.1 and 0.2), the curve shows the test performance for all miss probabilities; thus, the curve is applicable to composite hypotheses. For example, if the receiver's miss probability is actually 0.15, Fig 6 shows about a 50% chance that the receiver will pass the test.

Fig 7 shows the ASN calculated by simulation and by using Eqs 14 and 15. As with the Gaussian random variables, the number of trials peaks between the two hypothesis values. The curve isn't symmetrical, though, because $\alpha \neq \beta$.

To compare the sequential test to the fixed-length test with a large number of trials, you need the

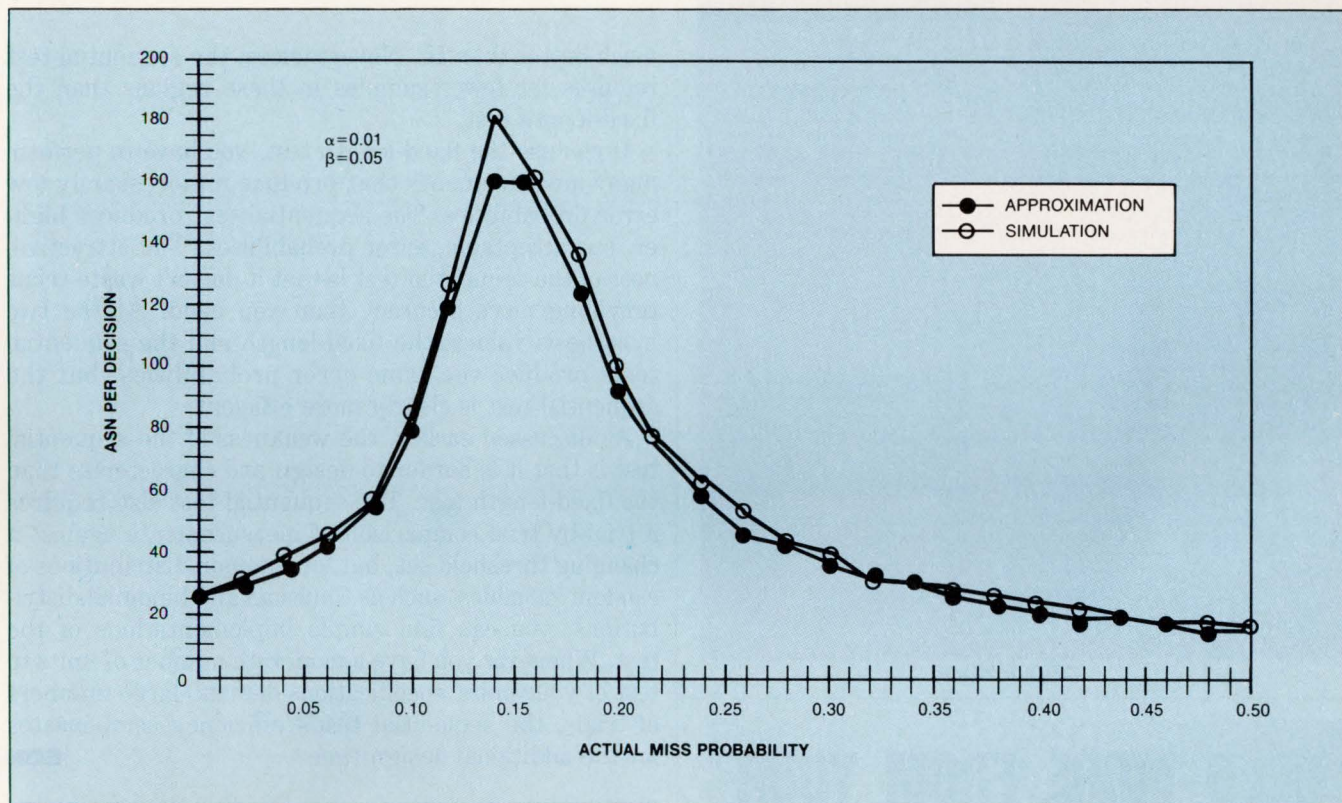

Fig 7—This figure plots the ASN curve for the test performed in Fig 6. The maximum ASN is about equal to the number of samples required for a fixed-length test. For $P(\text{miss})=0.1$ or $P(\text{miss})=0.2$, the sequential test requires about half as many samples as a fixed-length test.

Gaussian approximation to the binomial distribution (Ref 1). The parameters are

$$\begin{aligned} \mu_0 &= np_0 = 0.1n \\ \mu_1 &= np_1 = 0.2n \\ \sigma_0 &= (np_0q_0)^{1/2} = 0.3\sqrt{n} \\ \sigma_1 &= (np_1q_1)^{1/2} = 0.4\sqrt{n}. \end{aligned}$$

If the number of misses exceeds the threshold, t , the receiver fails the test. Using the Gaussian approximation, set

$$\begin{aligned} P(\text{exceeding the threshold} | p=0.1) &= 0.01 \\ P(t \leq x < \infty) &= Q\left(\frac{t-0.1n-0.5}{0.3\sqrt{n}}\right) = 0.01 \\ t-0.1n-0.5 &= 0.698\sqrt{n}, \end{aligned} \quad (16)$$

and

$$\begin{aligned} P(\text{falling below threshold} | p=0.2) &= 0.05 \\ P(-\infty \leq x \leq t) &= 1 - Q\left(\frac{t-0.2n+0.5}{0.4\sqrt{n}}\right) = 0.05 \\ t-0.2n+0.5 &= -0.6224\sqrt{n}. \end{aligned} \quad (17)$$

By solving Eqs 16 and 17 simultaneously for n (the number of trials), you find that $n=194$. Fig 7 shows that the fixed-length test requires a sample number roughly equal to the largest ASN of the sequential test.

Compare the two tests

When your measurements aren't right at the peak in the ASN, the sequential test requires far fewer samples than the fixed-length test. For example, when the miss probability is 0.1, the sequential test requires less than half the number of trials of the fixed test. The maximum ASN equals the sample number for the fixed-length test simply because the sequential test knows when to quit. If testing involves a difficult decision, even the sequential test can require a large number of samples.

If you calculate the fixed-length test's OCF for true values other than the two hypothesis values, you'll see that the fixed-length test is more accurate than the sequential test over a large portion of the curve. The fixed-length test is more likely than the sequential test to fail a unit whose performance is much worse than H_0 , and it is more likely to pass a unit whose performance is



The Dawn Of A New Era In Computing

THE AGE OF INDIFFERENCE

Let's face it! The whole point of high-technology is to make life a little easier, not harder. However, in our highly technical society, companies have developed products that are so complex they leave the user frustrated and confused.

A WORLD OF DIFFERENCE

GTEK[®], Inc. has made a world of difference with their Model 2010B Single Board Computer. In fact, the 2010B has put an end to all the rigamarole involved in using a computer. This powerful board is multi-faceted to perform any industrial control application you desire.

BIG THINGS-SMALL PACKAGES

Big things do come in small packages. The Model 2010B is all the proof you need. Its features include:

- A solid state EEPROM DOS for programs
- 40 I/O lines, each individually programmable
- 64K bytes RAM for data and/or programs
- Enhanced version Intel control BASIC v1.1
- RS232 with handshake, onboard EIA voltages
- EEPROM storage for floating point constants
- Single power supply 9-15v, onboard regulator
- Expansion bus, for even **BIGGER** things!

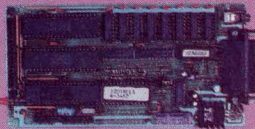

GTEK[®], Inc. has turned the dawn of a new era in computing into the age of difference...the age to make a difference. So call or write us today. Distributor and OEM inquiries welcomed. Also available, 2010M Machine language version.

ORDER TOLL FREE 1-800-255-GTEK (4835)
TELEX 315814 GTEK UD
MS & Technical Support: 1-601-467-8048



DEVELOPMENT HARDWARE & SOFTWARE
Drawer 1346
Bay St Louis, MS 39520 U.S.A.

CIRCLE NO 36

NEED MORE FROM YOUR DATA STORAGE SYSTEM?

Cost, speed, capacity and reliability . . . the big trade-off in selecting data storage equipment. Where ruggedness and reliability are important, Targa has more solid-state, heavy-duty alternatives.

More Interfaces. More Capacity. More Options.

Convenient cartridges or low cost boards and drives. High speed CMOS RAM or ultra-reliable bubble memory.

More Experience. For years Targa products have been proving their ruggedness and reliability all over the world in mines, factories, vehicles, aircraft, ships and other tough spots.

Call now for information on our introductory discount program.

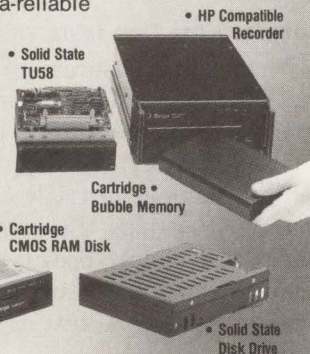

Targa Electronics Systems Inc.



• PC Bus Bubble Memory

3101 Hawthorne Rd.,
Ottawa, Canada
K1G 3V8

HAS MORE.

Call toll free
from the U.S.
1-800-267-9793
Or (613) 731-9941

much better than H_0 . Nevertheless, the sequential test requires far fewer samples in these regions than the fixed-length test.

If you use the fixed-length test, you have to perform many measurements that produce unnecessarily low error probabilities. The sequential test produces higher, but acceptable, error probabilities. The attractiveness of the sequential test is that it doesn't waste trials providing more accuracy than you need. At the two hypothesis values, the fixed-length and the sequential tests produce the same error probabilities, but the sequential test is clearly more efficient.

As discussed earlier, the weakness of the sequential test is that it is harder to design and characterize than the fixed-length test. The sequential test also requires a trial-by-trial comparison of measurements against a changing threshold set, but for common distributions of random variables, such as Gaussian and binomial distributions, you can find simple implementations of the test. Whenever you have a moderate number of units to test or your units' specifications demand large numbers of trials, the sequential test's efficiency compensates for the additional design time.

EDN

References

1. Cobb, R F, "Use statistics to test communications systems efficiently," *EDN*, January 8, 1987, pg 143.
2. Rao, C Radhakrishna, *Linear Statistical Inference and its Applications*, 2nd edition, Wiley, NY, 1973, pg 474-489.
3. Kendall, M G, and A Stuart, *The Advanced Theory of Statistics*, volume 2, Hafner, NY, 1961, Chapter 34.

Author's biography

R F Cobb, a senior scientist at Harris Corp's Government Communications Systems Div (Melbourne, FL), specializes in the design of spread-spectrum modems for satellite communications. He received a BSEE from the University of Detroit and an MSEE from the Georgia Institute of Technology. Ray devotes his free time to teaching a neighborhood Bible study and to running.

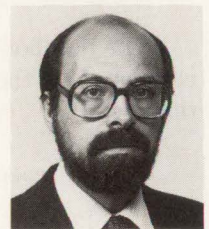

Article Interest Quotient (Circle One)
High 497 Medium 498 Low 499

For winning 8051 family designs that meet your time-to-market deadline and engineering budget—you'll need development tools, particularly In-Circuit Emulation.

The price of your success? From \$1,500 to \$5,000 with MetaLink's PC-hosted 8051-family of development tools and add-ons!

With our MetaICE-52 tool for example, you can add real time, transparent 8052-family In-Circuit Emulation to your lab PC for \$3,295—a fraction of the cost of large, dedicated development stations.

All MetaICE units plug in to your IBM or compatible PC via a standard RS-232 serial port. In one compact box, you get full symbolic debug, 16,000 hardware breakpoints, 16K of both program and external data memories, 12 break conditions, all microcontroller modes supported—and much more.

With our menu-driven software, telephone support and patent-pending 8051 family design—you can go to work instantly on a wide range of 8051 microcontroller-driven products.

All MetaICE units are affordable—like our \$2,895 MetaICE-51 for 8051 emulation, the MetaICE-31 for 8031 support (\$1,495) and our 80515 unit, the MetaICE-80515, just \$4,995.

MetaICE units are available for the full range of 8051 family devices:

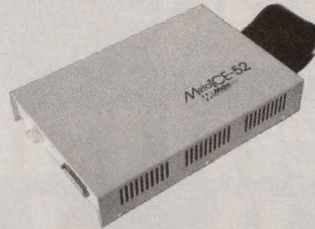

| | | |
|-------|-------|------|
| 8051 | 8052 | 8044 |
| 8031 | 8032 | 8344 |
| 80515 | 80535 | 8053 |

And, if you add our optional MetaICE-CHEST feature (included in MetaICE-80515), you can reach a full 64K of program and external data memories, 128,000 hardware breakpoints, 4K trace buffer and 15 break/trace conditions—for an additional \$1,495.

"Who are these guys?" you ask. MetaLink is the leader in PC-hosted 8051 In-Circuit Emulation products. **Nobody** knows 8051 architecture, applications and software inside and out like we do. Need 8051 emulation solutions? Call MetaLink...the ICE-House™: 1-800-METAICE.

MetaLink
Corporation

33 West Boxelder Place, Suite 110
Chandler, AZ 85224

Call (800)638-2423 or (602)926-0797

Telex: 4998050 MTLNK

IBM is a registered trademark of IBM Corporation
(All prices are USA list)

PC-hosted 8052 ICE for under \$3500!

CIRCLE NO 88



And just how many Multibus[®] II boards has Central Data chalked up?

Our R & D people have earned their "gold stars".

For the past several months, they've done their Multibus II homework and produced four high-performance Multibus II boards.

We're emphasizing all of the Multibus II concepts in these formative years. And, we're chalking up our rapid development of Multibus II boards to what we've learned from our Multibus I products.

Ask our R & D people if they're planning more Multibus II boards for the future and they'll say, "You can count on it!" These four Multibus II boards are at the head of their class:

CD22/3800 Multibus II Eight Channel Communication Controller – adds extensive communications abilities with 512K of RAM for data buffers and support for asynchronous, X.25, and user specific protocols.

CD22/4500 Multibus II SCSI/Floppy Controller – offloads the host CPU of data

storage and manipulation tasks and communicates with up to seven SCSI peripheral adapters.

CD22/6400 Multibus II SBX Motherboard – improves on the SBX concept by supporting up to four SBX modules on this powerful 80186 Single Board Computer.

CD22/6410 Multibus II Intelligent Prototyping Board – provides all the intelligence, control circuitry, RAM, and bus interface you'll need to create a powerful custom I/O board for any Multibus II system.

Talk with our Product Managers about our Multibus II boards and how they can help with your design. Jeff Tieri will tell you all about the 3800 (that's one of his favorite numbers), and Andre Felix can tick off features and application ideas on all the others. Call them toll free at 1-800-482-0315 (In Illinois, call 217-359-8010). They love to show and tell, so they'll send you a brochure with snapshots, specs, and prices.

Or write us, Central Data, 1602 Newton Drive, Champaign, IL 61821-1098.

Central Data

** Multibus is a trademark of Intel Corporation.*

Simplify FIR-filter design with a CMOS filter-control chip

Digital techniques let you define the phase and frequency characteristics of a high-speed filter more rigorously than you can with analog methods, but they require complex control circuitry. You can now implement this circuitry easily by using three CMOS chips to construct an FIR filter that has fully programmable characteristics.

Jeff D Haight, *Intersil Inc*

The design of digital filters used to be tedious, because it required either complex software or a great deal of hardware: multiple up/down counters, clock generators, data memory, and a μ P or microprogrammed controller. By using VLSI components, however, you can now design a digital filter that uses only three CMOS chips and has fully programmable characteristics. Without enmeshing you in complexity, these chips let you design a medium- or high-speed filter that is stable, yields high performance, maintains linear phase response, and has zero drift over a wide temperature range.

Although designers have traditionally preferred analog techniques for designing filters that operate at audio or subaudio frequencies, all analog filters that use linear op amps suffer to some extent from drift caused by component aging, power-supply voltage changes, temperature changes, humidity changes, and component tolerances. These effects become more serious as

you increase the filter's operating frequency or sharpen its roll-off characteristics. You can replace the linear amplifiers with charge-coupled or switched-capacitor devices, but the performance of filters using these devices can be limited by leakage of the charge on a capacitor (which can change the frequency response), by clock noise, and by the limited dynamic range of the devices.

Digital filters provide long-term stability

For demanding applications, therefore, the stability and programmability of digital filters makes them a better choice. The factors that determine the response of a digital filter are the coefficients, the clock or sample rate, and the number of taps, which determines the order of the filter. Digital filters provide long-term stability, because once you've programmed those parameters, only a hard failure (such as a change in one of the bits in a coefficient-storage PROM) can cause an undesired change in the filter's response.

You can choose from three basic types of digital filter for your design. Finite-impulse-response (FIR) filters are tolerant of reduced coefficient size and are always stable because they use only feedforward signal paths. They may require a large number of taps, however. Infinite-impulse-response (IIR) filters can yield the same response with fewer taps, because they include feedback paths as well as feedforward paths. However, because of the feedback, they may introduce more phase distortion and may be more difficult to stabilize than FIR filters. The third type, the lattice filter, can yield better results in some applications than either the FIR or the IIR types can, but it's much more difficult to design.

To choose a filter type, you can use a PC-based

The factors that determine a digital filter's response are the coefficients, the clock or sample rate, and the number of taps.

simulator that lets you tweak any filter parameters as a function of the various tradeoffs—S/N ratio, amplitude of passband ripple, stopband rejection, cost, and other factors. In digital-filter design, as in analog design, experience and rules of thumb will give you a good idea of what hardware you'll need in order to meet system requirements, but a simulator will let you see exactly how changes in filter type, filter length, coefficients, and other factors will affect filter performance.

You can design an FIR filter easily with two VLSI CMOS chips (from Intersil): the IM29C128 FIR filter controller (FFC), which contains all the required timing, addressing, data-history memory, and control circuitry, and the IM29C510 multiplier-accumulator (MAC), which performs the filtering. In addition, you'll

need a RAM or PROM for coefficient storage. **Fig 1** shows the internal structure of the FFC; **Fig 2** shows how to interconnect the FFC, MAC, and PROM or RAM to construct a single-stage FIR filter with as many as 128 taps. **Fig 3** shows the timing requirements.

When you're performing your initial calculations, remember that typical filter operations require approximately 80 nsec per tap. Thus, when you take into account the setup and hold times of typical external circuitry, your coefficient storage will need to have an access time of 65 nsec or less. On the other hand, if the processing on each data point takes less than 80 nsec, you can slow the filter clock and use slower storage devices.

From the above figures you can easily calculate the

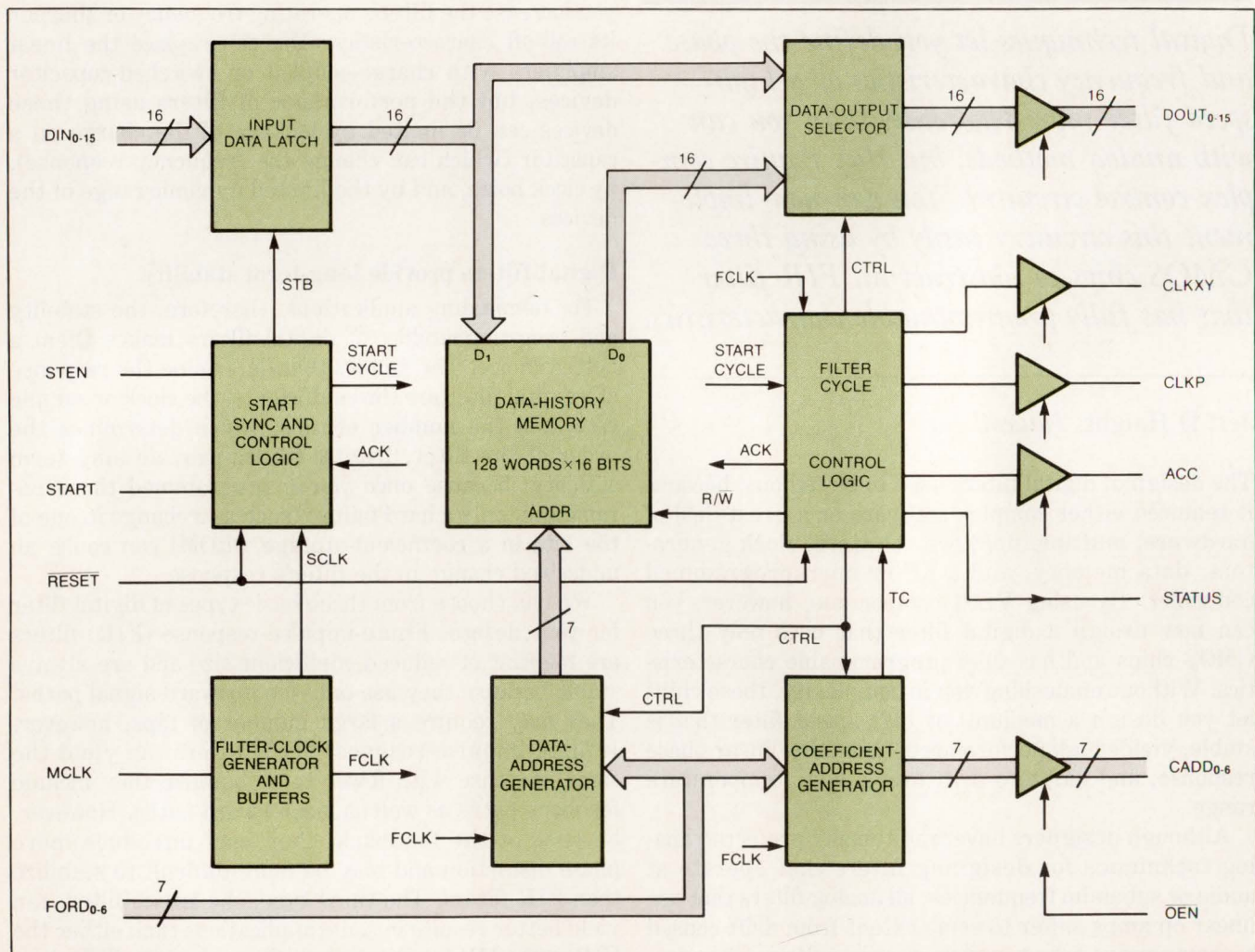

Fig 1—This VLSI chip, the FFC, contains all the memory, timing, and control circuits needed to control a multiplier-accumulator (MAC) and a coefficient-storage PROM. Using only these three chips, you can build a 128-tap FIR filter that has programmable characteristics.

bandwidth that a single filter stage can handle. For example, if your simulations show that you'll need 100 taps to achieve the response you want, then each data point requires 100×80 nsec, or 8 μ sec; that is, the filter can accept data at $1,000,000/8$ data points per second, or 125 kHz. However, the Nyquist criterion states that, to avoid aliasing, sampling must take place at more than twice the maximum data frequency. Therefore, your filter will handle a bandwidth of 62.5 kHz.

You'll find that the number of taps you need in the filter depends entirely on the application. Some types of video processing (such as edge detection) may need as few as 10 taps. On the other hand, some types of notch filters may require several hundred taps, or, in extreme cases, several thousand.

If you need more than 128 taps, you'll have to cascade two or more stages. The total throughput depends on the number of multiplications and additions that the circuit must perform per second. If you double the number of stages, each of which contains its own MAC, you almost double the number of sum-of-products oper-

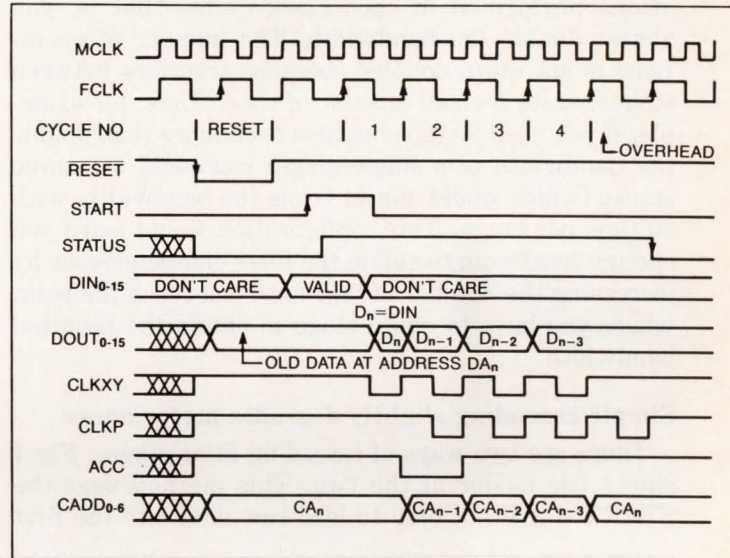

Fig 3—A filtering cycle starts on the rising edge of the START signal. The FFC derives all timing and control signals from the externally supplied MCLK clock pulse, which must have twice the frequency of the internal CLKP filter clock.

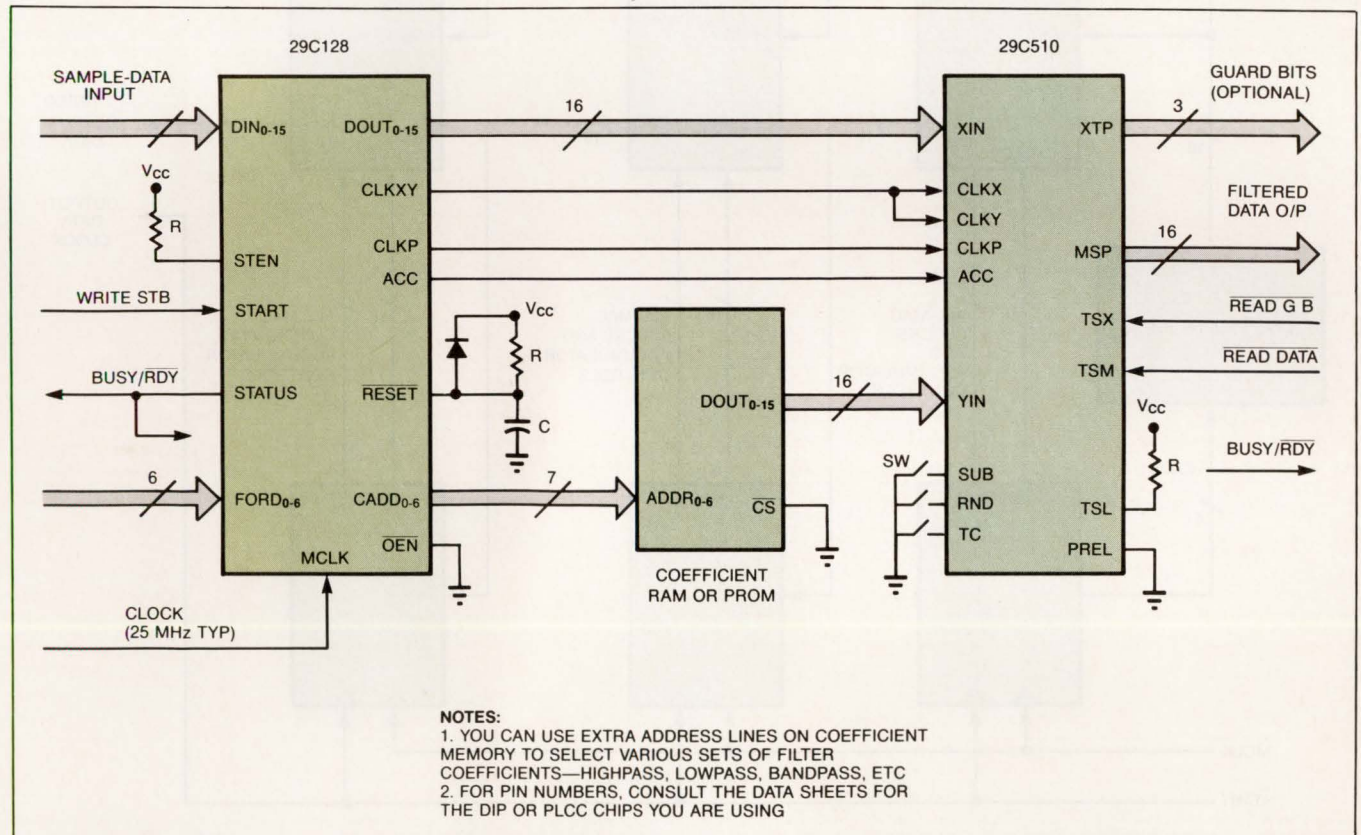

Fig 2—It's simple to connect the FFC to a 16-bit MAC. The FFC also provides six address lines for accessing coefficients stored in PROM or RAM.

Simple cascading may produce more ripple in the passband than an optimally designed filter would, but you can compensate for it by specifying less ripple initially.

ations performed in each clock cycle—that is, you almost double the bandwidth. The number of operations is not quite doubled, because transfers between stages waste a small amount of time. Thus, for example, if you need 90 taps but also need more than double the bandwidth of a single stage, you could use three stages (which would almost triple the bandwidth) with 30 taps per stage. This configuration would leave you enough headroom to refine the filter characteristics by increasing the number of taps until you reach the point where you have to add a stage to obtain the required bandwidth.

Simple cascading slightly degrades performance

There are two ways of cascading filter stages; Fig 4 shows the easier of the two. This method uses the START signal not only to load raw data into the first

FFC, but also to load partially filtered data present on the MSP and XTP output lines of that FFC into the following FFC. The method imposes a slight performance penalty, for the following reasons. Consider a filter that requires 205 taps configured as five stages with 41 taps each. At the output of any given stage, each data point has a history of 41 different points times 41 different coefficients, and these partially filtered and summed data points enter the next stage for further multiplication and summation. The result is not mathematically the same as that of an optimally designed 205-tap filter, in which each output would be the result of 205 different input data points multiplied by 205 different coefficients.

In practice, however, the difference may not be significant, because convolution is a linear operation: If you put a 20-dB notch in the signal in one stage, and

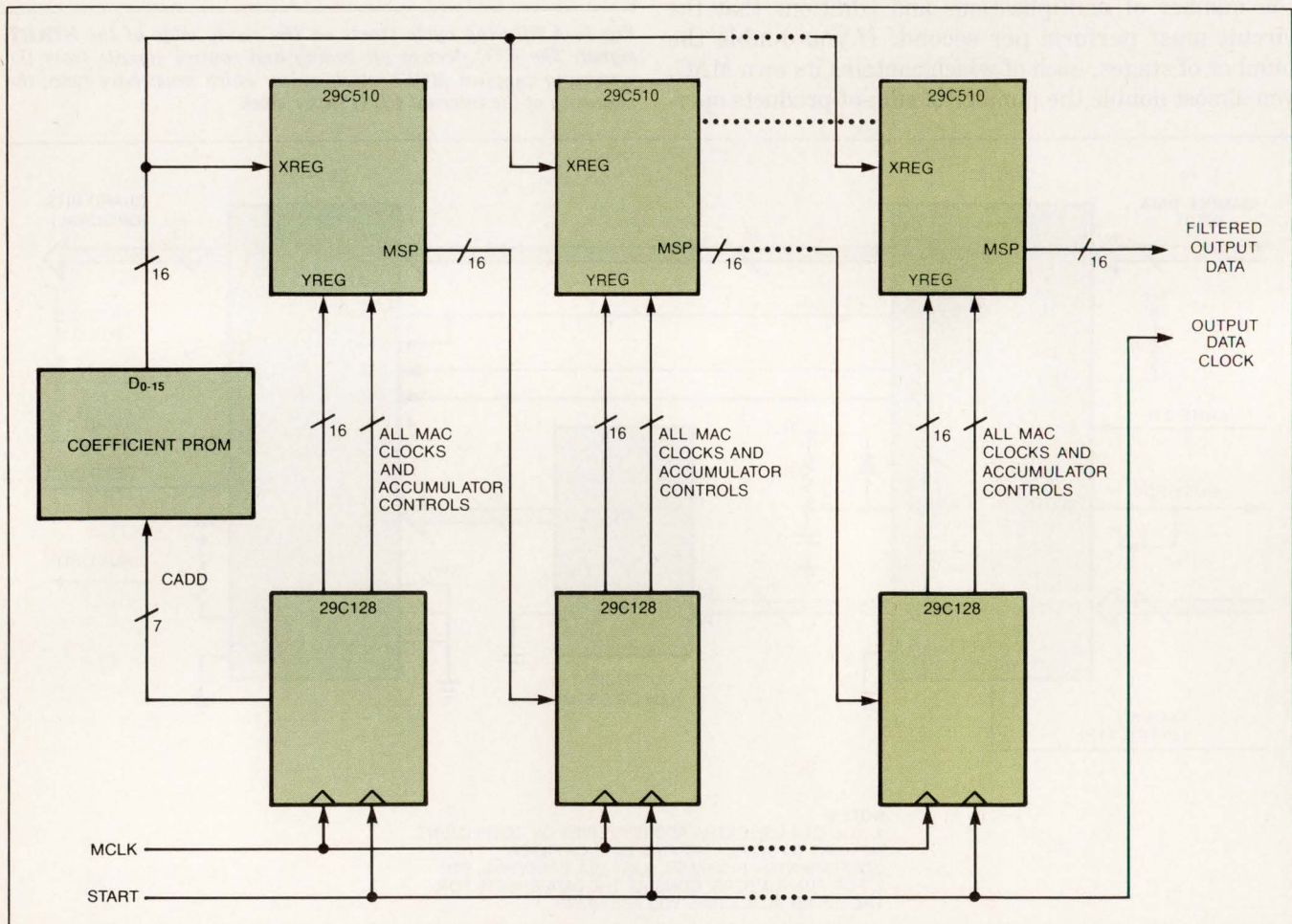

Fig 4—If you need more than 128 taps in your filter, you can cascade several filter stages, each consisting of an FFC and a MAC. The coefficient-storage chips can be common to all stages.

then feed the output of that stage into an identical second stage, the result will be a 40-dB notch. Additional stages will each deepen the notch by 20 dB. This characteristic makes it easy for you to design a filter by performing simple cascading. You simply divide the desired frequency characteristic (in dB) by the number of stages, calculate the coefficients and the number of taps needed for one stage, and cascade the required number of identical stages. Because you'll be using the same coefficients for each stage, you can simplify the hardware by using a single set of PROM or RAM coefficient-storage chips to serve all the MACs in the filter, regardless of the number of stages.

Other performance-degrading factors

You may have to consider some other factors that make the filter performance obtained from simple cascading less than optimal. For example, the Remez exchange algorithm (or any algorithm that uses Chebyshev or other polynomials in an iterative optimization technique) calculates the optimal set of coefficients for a

given number of taps. Reducing the number of taps, or, more accurately, reducing the number of distinct coefficients, somewhat degrades filter performance. You can compensate for this degradation by specifying a tighter response and adding a few taps to obtain it.

Further, simple cascading may produce more ripple in the passband than an optimally designed filter would. However, you can compensate for the excess ripple by specifying less ripple in your initial calculations. Simple cascading may also cause a slight deterioration in the noise floor. In a single stage, arithmetic operations take place with full 16×16-bit-precision summing and 35-bit accumulation. When you employ simple cascading, however, the summed least-significant products in bits 15 through 0 of a 16-bit MAC are not passed to the next stage, so you'll observe truncation or round-off errors. These errors are relatively insignificant, except in very long filters that must satisfy very demanding requirements.

The second method of cascading filter stages (Fig 5) maintains full precision and full data history but re-

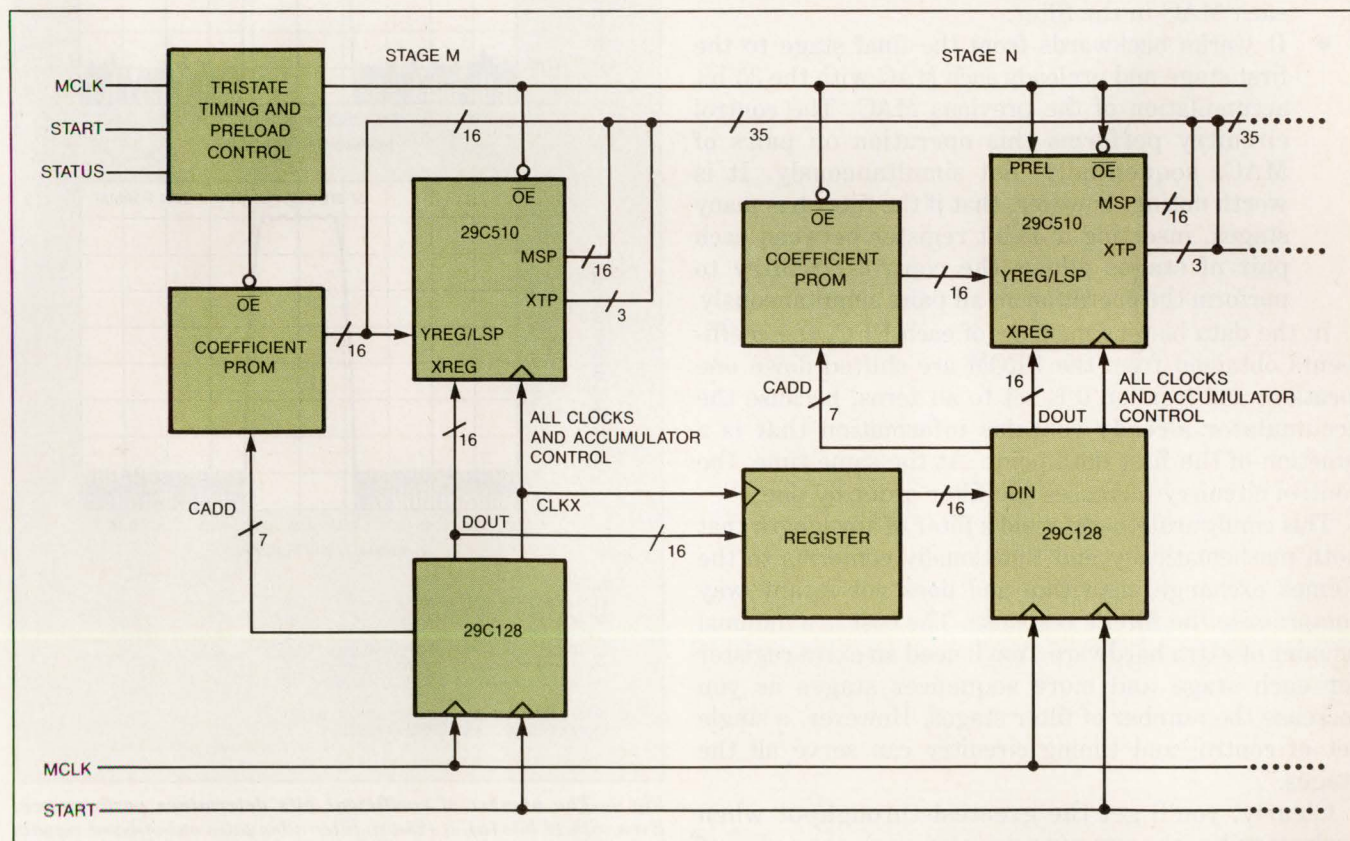

Fig 5—For less distortion and noise, you use one extra register in each stage. You'll need extra timing and control circuitry to obtain the full precision that the MAC can deliver, but this circuitry can serve all stages.

Cascading with extra registers maintains full precision and full data history, but requires some extra hardware for data storage and control-signal generation.

quires some extra hardware for data storage and control-signal generation. This method requires the addition of a register connected in parallel with the X register of each MAC. The rising edge of each CLKXY pulse loads the same data point into both the X register of the stage *M* MAC and the additional register; the output of the extra register is connected to the data-input port of the following stage-*N* FFC. At the beginning of each cycle (that is, for each new data point), the control circuitry clears the registers of the first-stage MAC.

The sequence of the filter's operations is as follows. When the START signal loads new data into the stage-*M* FFC, it also loads the previous data point into the initial position of the stage-*N* FFC's data memory. The falling edge of the FFC's status flag starts a control sequence that performs the following steps:

- It latches the output of the final filter stage into the next section of circuitry for display or other processing.
- It disables the MSP, LSP, and XTP outputs of each MAC in the filter.
- It works backwards from the final stage to the first stage and preloads each MAC with the 35-bit accumulation of the previous MAC. The control circuitry performs this operation on pairs of MACs sequentially, not simultaneously. It is worth noting, however, that if the filter has many stages, inserting a 35-bit register between each pair of stages allows the control circuitry to perform the operation on all pairs simultaneously.

In the data-history memory of each FFC, the coefficients obtained from the PROM are shifted down one location, and location 0 is set to all zeros, because the accumulator already contains information that is a function of the first data point. At the same time, the control circuitry increases the filter order by one.

This configuration can yield a filter of any length that both mathematically and functionally conforms to the Remez exchange algorithm and does not in any way compromise the filter's response. The cost is a minimal amount of extra hardware. You'll need an extra register for each stage and more sequencer stages as you increase the number of filter stages. However, a single set of control and timing circuitry can serve all the stages.

Clearly, you'll get the greatest throughput when each stage has the same (or almost the same) number of taps. However, when maximum throughput is not critical, you can include stages that are grossly different in

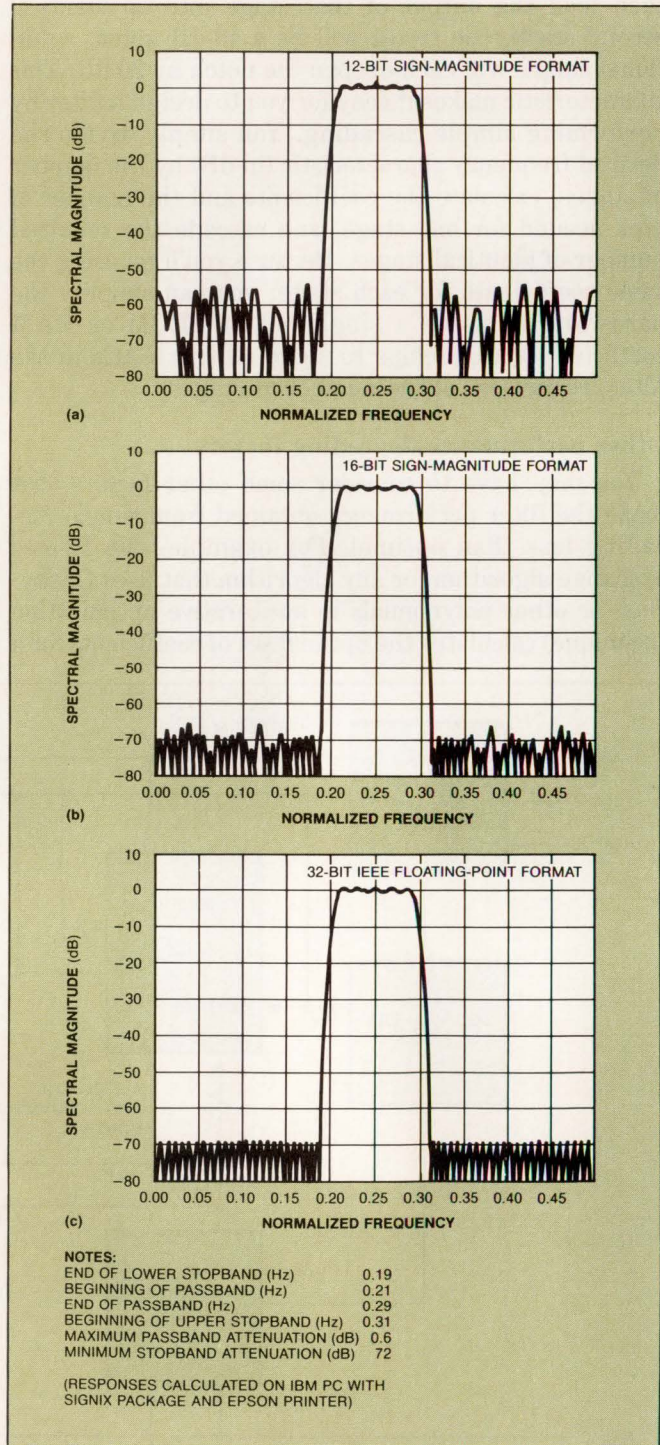

Fig 6—The number of coefficient bits determines performance. Even with 12 bits (a), a 128-tap filter attenuates out-of-band signals by at least 50 dB; 16-bit coefficients (b) increase attenuation to 65 dB; and 32-bit floating-point coefficients (c) bring the attenuation to 70 dB.

length. You could, for instance, implement a lowpass filter in the first section and a bandpass filter in the second. This might simplify the implementation of adaptive algorithms, for example, in which only the bandpass portion varies.

MAC resolution affects performance

One advantage of the 29C128 FFC is that it can work with MACs of widely differing resolution. Although the price of MACs has dropped so much that 16-bit devices are economical for most applications, you may have to use MACs of a different size for filters with demanding requirements.

Further, you'll have noted from the discussion on cascading stages that simple cascading produces more ripple and noise than does the more complex cascading with registers. It's important to remember that the round-off and truncation noise are uniformly distributed, regardless of whether the source is data truncation, coefficient truncation, or truncation of the products that are summed. Further, a change in the coefficient size affects the filter response in exactly the same way, whether the data width is four bits or 400 bits. Thus, in very demanding applications, it may be desirable to use 16-bit, 24-bit, or floating-point MACs, even when the data width is only eight bits.

Fig 6 shows the different filter responses that you can achieve from a 127-tap bandpass filter according to whether you use the 12-bit fixed-point format (Fig 6a); the 16-bit fixed-point format (Fig 6b); or the 32-bit floating-point format (Fig 6c) for the coefficients. You can see from Fig 6 that a filter of this length doesn't show much increase in performance when the coefficient word size goes from 16 to 32 bits. Even when you use 12-bit coefficients, out-of-band signals are reduced by more than 50 dB, which is adequate for most telecommunications applications.

For filters with very few taps, or for noncritical filters, you could use 8-bit MACs. Many image-processing operations consist of 1- or 2-dimensional FIR filtering that requires only a few taps and for which 8-bit resolution is sufficient. For many speech-processing operations, you'll need 12-bit resolution, however. The FFC lets you easily tailor the filter parameters to take advantage of the tradeoffs between resolution and number of taps.

You can change filter response dynamically

Other applications that benefit from the ability to vary filter parameters dynamically include adaptive

Filter board plugs into PC

To simplify FIR-filter design and allow sophisticated data conversion without investing a lot of design time, you can use a plug-in filter board that occupies one slot in an IBM PC or compatible computer. The board, Intersil's EVK-128, provides an ICL7115 14-bit A/D converter, an ICL7121 16-bit D/A converter, an IM29C128 FFC, an IM29C510 16-bit CMOS MAC, and control and interface circuitry. It comes with a floppy disk containing programs for filter design. The programs include routines that let you calculate filter coefficients and plot filter response. Once you've calculated the coefficients, you can download them to RAM storage on the board so the filter system can use them.

The board also includes a digital uniform-noise generator that lets you perform further verification of your design. The documentation includes complete schematics, a parts list, and pc-board artwork, from which you can copy the items you need for your own filtering system. If you wish to use purely digital I/O, you can bypass either the A/D or the D/A converter or both: You can access the filter system directly, either via the PC bus or by means of edge-mounted connectors that are externally accessible. This arrangement allows you to process data off line, using floppy-disk storage for the intermediate results of repeated passes through the filter.

filtering for modems, radar-signal processing, and multichannel applications such as ultrasound medical imaging and sonar systems. High-speed modems need to vary filter response dynamically to maximize, or at least improve, the S/N ratio as channels fade or multipath distortion varies. Most of the work requires the modem to vary the response of a fixed-length filter; however, the structure of the FFC makes it easy to vary filter length as well. In radar-signal processing, the same filter can encode biphase transmitted pulses and also compress the pulses of long, weak received sequences. For the processing of A/D radar outputs, 12-bit coefficients are usually adequate. For further processing, however, you'd need coefficients having 16 or more bits. In telecommunications applications, where very poor S/N ratio is the norm, you might

FAIL-SAFE PROTECTION

FOR: CMOS MEMORY BACK-UP
STAND BY POWER
PRIMARY POWER SOURCE

DESIGN

NO.

1

COIN CELL SERIES



- Fit all 12mm to 24mm dia. 3V coin-type lithium cells
- Design guarantees proper polarity
- Nickel plated stainless steel contacts

Low profile coin type battery holders solder right to your PC board. Unique design assures easy battery insertion and removal without special tools. Ability to withstand temperatures from -55°C to +140°C and resistance to a wide range of solvents provide ultra-reliability.

Custom battery holders on request. Call or write today for more details. 1



BOGEN
COMMUNICATIONS, INC.

MPD is a product of
Bogen Communications, Inc.

50 Spring Street, Ramsey, NJ 07446 • 201-934-8500
FAX: 201-934-9832 • TLX: 7109905047

CIRCLE NO 38

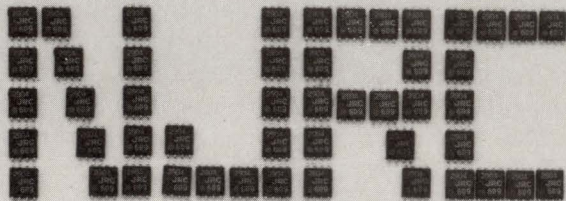

LINEAR ICs

NJRC, one of the world's largest producers of Linear ICs now offers a broad line of low noise operational amplifiers, comparators, voltage regulators and special function devices. The ICs are outstanding in design, reliability and low price. And they are available in popular package styles with special emphasis on surface mount technology.

Features:

- High Quality
- Stringent Q/A testing
- Low Noise OP amps (dual quad)

Call now for more information on Linear ICs you can depend on!

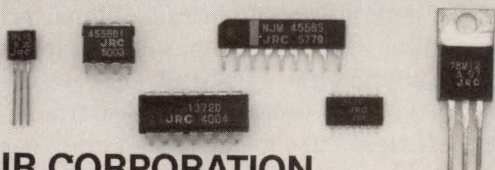

NJR CORPORATION

340-B East Middlefield Road, Mountain View, CA 94043
Tel: (415) 961-3901, Telex: 172172, FAX: (415) 969-1409

CIRCLE NO 40

employ very long character codes that have very low cross-correlation values. In such applications, the coefficients wouldn't need to have more than eight bits.

If intermediate storage is available, you could achieve more than 128 taps in a single stage by storing the partially filtered data on disk and cycling it through the same filter stage several times. For example, you might have several hundred kilobytes of physiological data that you know has been contaminated by 60- or 120-Hz components radiated from fluorescent lighting. You could eliminate the noise by passing the data through a digital filter with 1000 taps, yielding extremely sharp notches at 60 and 120 Hz. Where software filtering is too slow, you could speed up the processing by three orders of magnitude by cycling the data through one 128-tap filter stage. To perform this and other types of filtering, you can use a special plug-in board for the IBM PC (see box, "Filter board plugs into PC"). **EDN**

Author's biography

Jeff Haight was product marketing manager for DSP products at GE Intersil (Cupertino, CA) when he wrote this article. He's now vice president of sales and marketing at Micro Integration Corp (San Jose, CA). Jeff holds a BA from the University of Washington; he also attended Caltech. He's a member of the Old Crows (an electronic warfare society) and SPIE, and his leisure pursuits include music, tennis, bicycling, reading, and skiing.



Article Interest Quotient (Circle One)

High 473 Medium 474 Low 475

Now, Your PC Can Talk DSP!

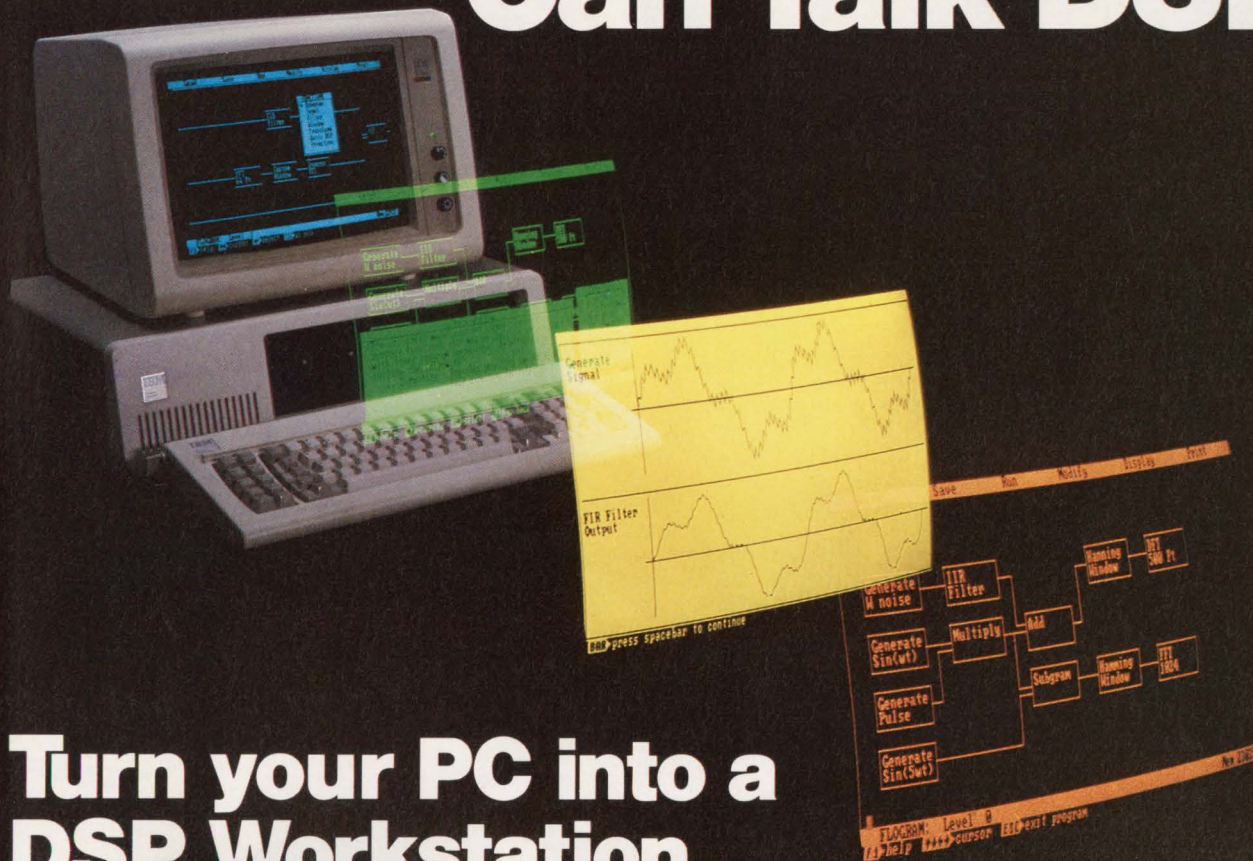

Turn your PC into a DSP Workstation

We've just made Digital Signal Processing simulation extremely easy and affordable. Our new **DSPlay™ Software Package** lets you turn your IBM® PC/XT/AT or compatible into a versatile DSP workstation. This state-of-the-art software is designed to acquire, process, and analyze real-world signals. It's ideal for the scientist or engineer involved in *vibration analysis, process/medical/analytical instrumentation, product test, physiology, or audio/voice/sonar signal processing.*

Easy To Use

Menus, pull-up lists, and specific Help windows simplify the formulation of the signal process. There's no more DSP algorithm development drudgery. Your process development and delivery times are dramatically reduced, and you can concentrate on solutions instead of implementations.

DSPlay uses functional block diagrams or FlowGrams™ as its language for easy program development and documentation. Each block represents a process function such as correlation,

signal source, filter, FFT operation, and more. The DSP programs are easily developed using the built-in editor function. You can create a flow diagram and select for each block: the process function, its parameters, and inputs and outputs by drawing connections to the next or previous function. You can change parameters or the block diagram itself any time you wish.

Easy To Display

Finally, you have a variety of ways to view signal data. The Windows Display monitors signals in an overview fashion,

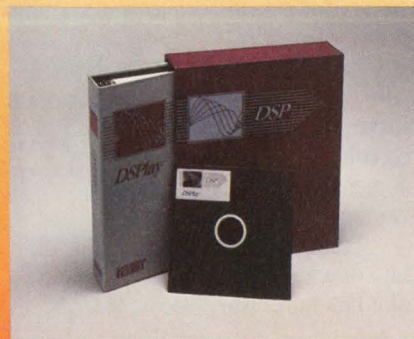

the Active Display allows more in-depth examination of signals, and the Landscape Display shows a series of signal frames in a 3-D perspective.

What more do you need? Just an IBM PC/AT/XT or compatible with 512kB memory, one double-sided floppy disk drive, an IBM color graphics board, and a desire to make your DSP tasks easy and affordable.

Easy To Afford

How affordable? Just \$495! For complete information, contact your nearest Burr-Brown sales office, or Applications Engineering at 602-746-1111. Burr-Brown Corp., PO Box 11400, Tucson, Arizona 85734.

BURR-BROWN®
BB

Improving DSP Productivity

Now available from

United States
Instrument Rentals, Inc.

US

1-800-824-2873



Only one logic timing analyzer slices nanoseconds into 10 perfect parts.

Take a deep breath and brace yourself. Because the logic analyzer you loved last year isn't going to cut it from this moment on.

Outlook Technology introduces the T-100. With clock speeds up to 2 GHz, new measurement techniques and its 100 psec resolution capability, this device is so sophisticated it will change forever the way you think about logic timing analysis.

Only the T-100 couples the triggering capability and width of a logic analyzer

with the resolution of four 16-channel sampling scopes. Only the T-100 can spot those setup and hold violations which may produce failure at some future time, usually after shipment to your customer. And only the T-100 can reveal when the wrong contents are sent to or read from a memory location.

Techniques such as synchronous harmonic clocking, time-shifted harmonic clocking and equivalent time recording of 10 GHz give you progressively more resolution, accuracy and precision.

Each technique is thoroughly discussed, with screen displays, in our full color brochure. The patterns you can

generate, all the possible configurations, and the breakthroughs which are the cutting edge of logic timing analysis.

For your free copy—or to arrange a complete demonstration—call us now at 408-374-2990.

Or write to us today at Outlook Technology, 200 East Hacienda Avenue Campbell, California 95008.



Discover the newest
measurement techniques in
our 12-page brochure.

OUTLOOK

Proper design tradeoffs translate to a precise position-control system

Microstepping technology offers a means of improving resolution in position-control applications. When it comes to a drive/control scheme, however, you must juggle a number of design tradeoffs if you hope to achieve an optimum design.

Yoram Hirsch, IXYS Corp

Designers of drive and control systems for microstepping motors in positioning applications have to take into account several considerations: matching and accuracy requirements for microstepping control; H-bridge power-stage operating modes; the impact of the PWM switching frequency on system operation; single-supply operation; sign/magnitude-vs-bipolar inputs; under-

voltage, overcurrent, and overtemperature protection; and advanced adaptive-compensation schemes.

Although stepping motors have advantages when compared with servo motors, they aren't problem-free. A stepping motor's large pulse-drive waveforms create mechanical forces that excite and aggravate the mechanical resonances in the positioning system. These resonances are load dependent and difficult to control because stepping motors have very little inherent damping capability. At resonance, a stepping-motor system is likely to lose synchronization and skip or gain a step. In an open-loop system (typical in stepper-motor applications), this loss of synchronization implies loss of position information—obviously an unacceptable situation. Commonly, system designers circumvent this problem by avoiding the band of resonance frequencies, but this solution severely limits system performance.

Stepping motors also suffer from the disadvantage of limited resolution. Most steppers have resolutions of 200 steps/revolution (1.8° per step). The highest resolu-

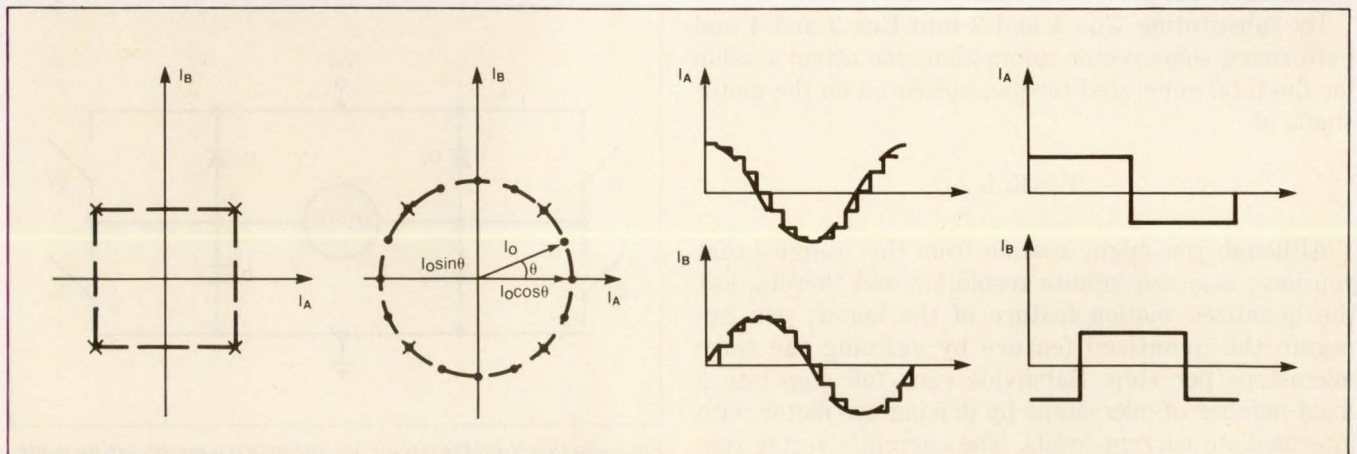

Fig 1—You can subdivide each full step into a number of microsteps by driving a motor with the intermediate current levels at which the vector sum tracks the circle.

tion motors spec 400 steps/revolution (0.9° per step).

Microstepping technology allows you to overcome these disadvantages while still retaining an open-loop system's advantages. Microstepping divides each normal step into smaller steps by applying currents to both phases of the motor, creating a torque phasor that's proportional to the vector sum of both currents. When this phasor completes one turn (360 electrical degrees), the motor moves exactly four full steps (one torque cycle). Similarly, when the phasor moves 22.5 electrical degrees, the motor will move $(22.5/90) \times 100 = 25\%$ of a full step. Thus, it is possible to position the motor to any arbitrary angle.

You can easily control the torque phasor's angle by applying two periodic waveforms to the motor, which are shifted by 90 electrical degrees. Let the phase current equations be

$$I_A = I_0 \cos \theta_E \quad (1)$$

and

$$I_B = I_0 \sin \theta_E \quad (2)$$

where θ_E equals electrical position. The resulting torque generated by the corresponding phases is then

$$T_A = K_0 I_A = K_0 I_0 \cos(\theta_E) \quad (3)$$

and

$$T_B = K_0 I_B = K_0 I_0 \sin(\theta_E) \quad (4)$$

where K_0 is the torque constant of the motor.

By substituting **Eqs 1** and **2** into **Eqs 3** and **4** and performing some vector summation, you attain a value for the total generated torque, measured on the motor shaft, of

$$T_G = K_0 I_0.$$

Although you might assume from this exercise that you have attained infinite resolution and thereby lost the quantized motion feature of the motor, you can regain the quantized feature by defining the term microsteps per step. Subdivide each full step into a fixed number of microsteps by driving the motor with intermediate current levels. The current's vector sum will then track the circle in **Fig 1** and divide the full step (90 electrical degrees) into the required number of

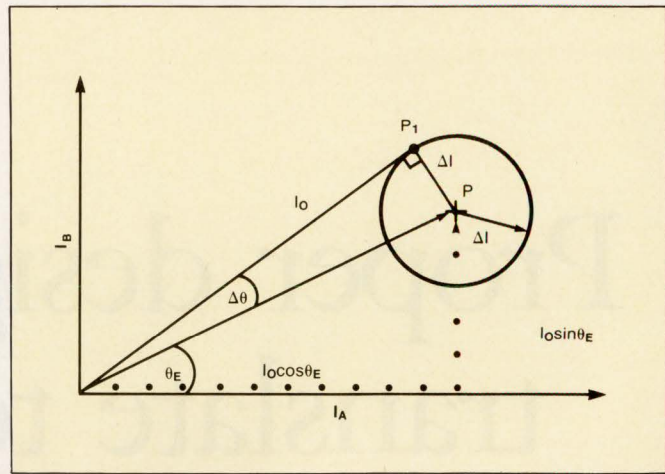

Fig 2—Worst-case position errors occur when the vector sum is tangent to the circle.

microsteps. **Fig 1** illustrates the phase currents required for full-step and four microstep/step operation. (Actually, you can implement this operation using look-up tables and two D/A converters.)

Match phase currents for microstepping

To best utilize microstepping techniques to improve resolution, you must first select an appropriate motor based on torque requirements, the specified step accuracy, and the required resolution or number of microsteps/step. Secondly, you have to determine how closely you need to match the phase currents to avoid degrading the step accuracy.

Eqs 1, 2, 3, and 4 clearly indicate that errors in the magnitude or phase of the phase currents will have an impact on positioning accuracy. These equations also illustrate that if you keep the ratio of phase currents (I_A/I_B) constant, errors in their values will only result in torque-value errors, not positioning errors.

Referring to **Fig 2**, assume that the vector sum of currents I_A and I_B is located at point P . You must ascertain the upper boundary of the current errors that will keep the position error within some given angle $\Delta\theta$. Let the phase currents vary by a small amount such that their vector sum lies within the circle that has a

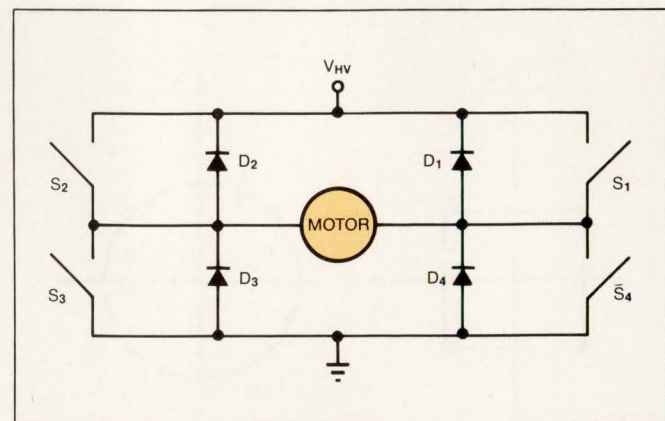

Fig 3—In this H-bridge circuit operating in a noncirculating mode, the closure of S_2 and S_4 generates the charging current. S_1 and S_3 then close to generate the discharging current.

At resonance, a stepping-motor system is likely to lose synchronization and skip or gain a step.

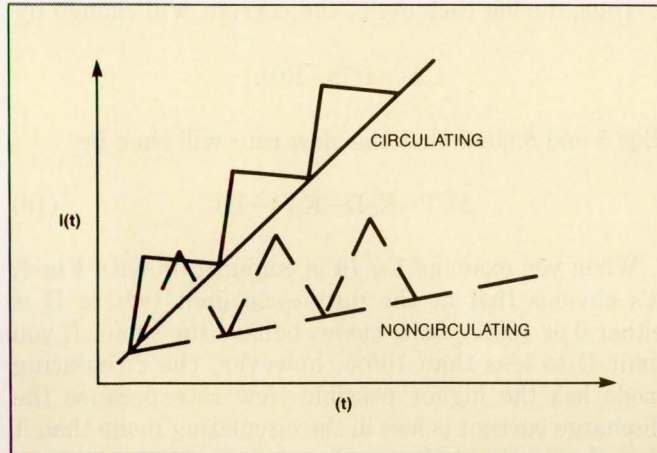

Fig 4—The circulating and noncirculating modes behave the same at the duty-cycle limit (0 or 100%).

radius Δi and that is centered at point P. It follows that the worst-case position error occurs in the cases where the vector sum is tangent to the circle (such as point P₁). At this point,

$$\tan(\Delta\theta) = \Delta I / I_0$$

or

$$\Delta I / I_0 = \tan(\Delta\theta).$$

To achieve a position error of less than 1% of a full step, for example, you must keep the total error current under 1.6% of full scale or peak current. This upper error boundary includes all sources such as zero-offset errors and full-scale matching errors. Looking at **Fig 2** again, you can see that in the vicinity of a full step, the phase with the smaller current has the biggest impact on position error.

Implement the H-bridge power stage

Your next design concern involves the implementation of H-bridge power stages for current-regulated PWM control. The stages can have two possible operating modes: circulating and noncirculating. In the noncirculating mode, the closure of S₂ and S₄ generates the phase charging current (**Fig 3**). Current flows left to right through the motor's phase winding. At the appropriate moment, S₁ and S₃ close, generating a discharge current that flows through D₃ and D₁ back into the power-supply leads and typically charges the supply's output capacitor. In practice, you'll find that the charge and discharge slopes are about equal in the steady-state

condition. For a low back-EMF, the forcing voltage for charge and discharge is about equal but opposite in sign.

In the circulating mode, the charging action mirrors that of the noncirculating mode. After the current reaches the appropriate level, however, only S₂ opens. The resulting discharge current then flows through D₃ and S₄ until the beginning of the next cycle. In general, the discharge slope is much smaller than the charge slope because there's no forcing voltage during the discharge phase—only initial current.

Next, define the duty cycle (D) and charge/discharge current slopes (I_C(t)/I_D(t)):

$$D = t_1 / T$$

$$K_C = (B - A) / DT$$

$$K_D = (B - A) / (1 - D)T;$$

therefore

$$I_C(t) = A + K_C t \text{ for } 0 \leq t < DT \quad (5)$$

$$I_D(t) = A + (K_C + K_D) - K_D t \text{ for } DT \leq t < T. \quad (6)$$

After some mathematical manipulation, the result is

$$I_{AV}(t) = A + \frac{1}{2}(K_C + K_D)T [K_C / (K_C + K_D) - (D - 1)^2].$$

In the steady-state (or static) case, I_{AV}(t) is constant. Therefore,

$$I_C(0) = I_D T. \quad (7)$$

Combining **Eqs 5, 6, and 7** for the steady-state duty cycle results in

$$D_{SS} = K_D / K_C + K_D. \quad (8)$$

According to **Eq 8**, and because both slopes are approximately equal in the noncirculating mode, D=50%. You can thus define the phase ripple current as

$$\Delta I_{PP} = I_D(DT) - I_D(T). \quad (9)$$

Combining **Eqs 6 and 9** results in

$$\Delta I_{PP} = T[(K_C K_D) / (K_C + K_D)].$$

Near a full step, the phase carrying the smallest current has the biggest impact on position error.

Maximum ripple current occurs when $K_C=K_D=K$. It has the value

$$\Delta I_{PP}=KT/2.$$

This mathematical exercise indicates that as far as ripple current is concerned, the noncirculating mode is never better than the circulating mode. In the noncirculating mode, $D=50\%$ (ripple is at its maximum), whereas in the circulating mode, $D=0$ (ripple is at its minimum).

Parameter affects slew-rate limiting

Ripple current notwithstanding, you also have to evaluate the maximum rate of change of $I_{AV}(t)$ in the two modes. This parameter sets an upper limit on the rate of change of the phase currents and on the maximum motor velocity in a microstepping application. When the positioning system reaches this velocity limit, it is in a slew-rate-limiting condition. This condition means that the product of the peak undistorted phase current and the frequency of the input command is a constant value.

To simplify things, assume that the ripple current stays approximately constant, which is a fair assumption because the motor's back-EMF voltage is the major contributor to changes in ripple current. This motor voltage changes relatively slowly compared to the modulator's chopping frequency.

Thus, during each cycle, the current will change by

$$\Delta I=I(T)-I(0).$$

Eqs 5 and 6 show that the slew rate will then be

$$\Delta I/T=K_C D-K_D(1-D). \quad (10)$$

When you examine Eq 10 in conjunction with Fig 4, it's obvious that at the duty-cycle limit (where D is either 0 or 100%), both modes behave the same. If you limit D to less than 100%, however, the circulating mode has the higher possible slew rate because the discharge current is less in the circulating mode than it is in the noncirculating mode.

Technically, it is much more difficult to build a circulating-mode PWM controller. This mode requires extremely fast circuit-design techniques, which aren't easy to implement. The circulating mode has another drawback: It doesn't return any energy to the power supply and thus is less efficient. A noncirculating-mode PWM controller, on the other hand, operates efficiently at duty cycles of approximately 50%.

Fig 5 shows the power-driver stage for a sample controller system and an IC that operates at a PWM switching frequency of 10 to 400 kHz (Fig 6). To drive a 2-phase stepping motor, you need two of these stages. Fig 5's circuit uses two n-channel and two p-channel

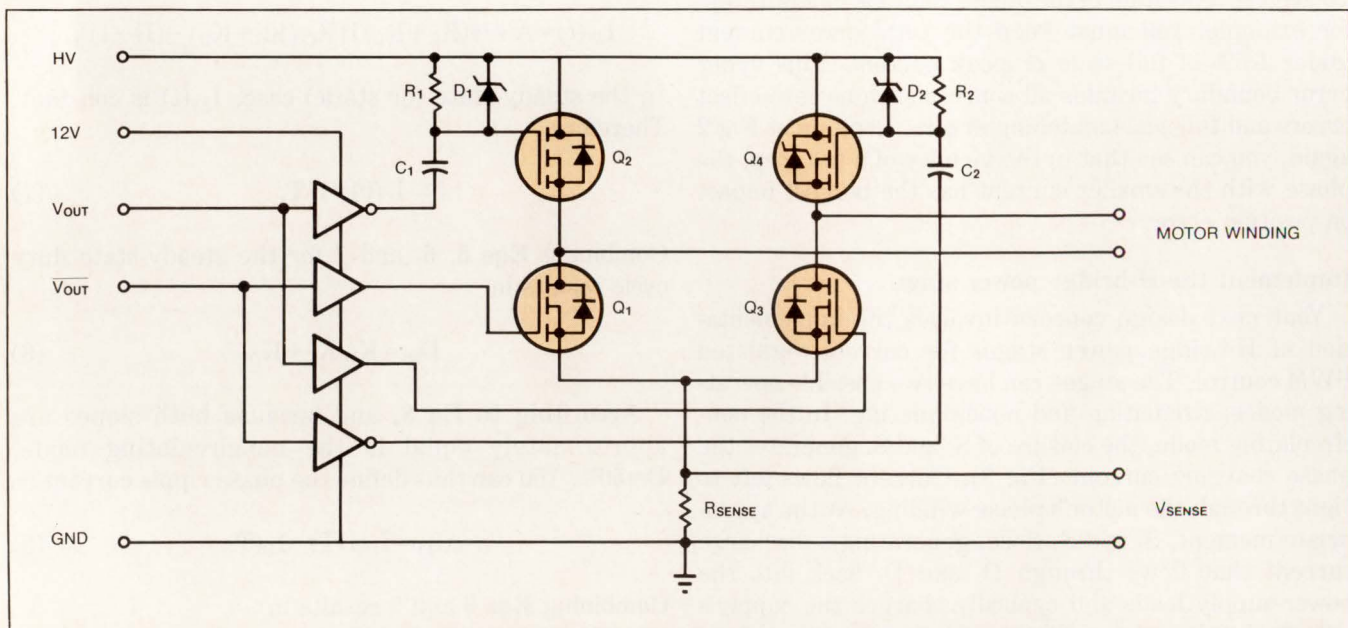

Fig 5—To simplify drive and level-shift circuitry, this H-bridge power stage employs two n-channel and two p-channel power MOSFETs.

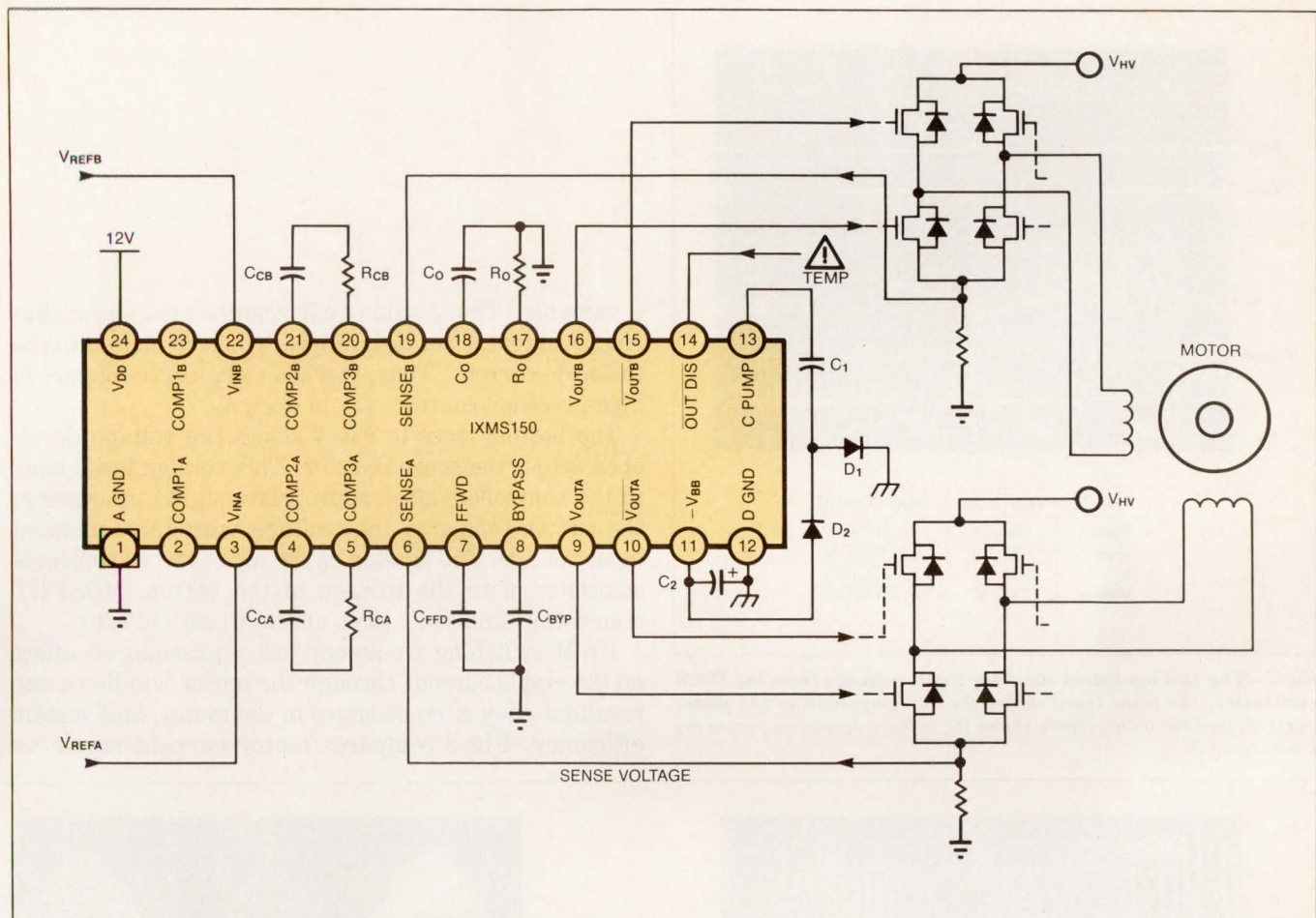

Fig 6—This system's built-in undervoltage lockout feature holds the outputs low until the negative-bias voltage is high enough to accept the negative sense voltages.

power MOSFETs rather than an all n-channel architecture. P-channel transistors are larger and more expensive than similarly rated n-channel devices, but the use of p-channel units simplifies the drive and level-shift circuitry, which lowers component count and increases reliability. It also makes it easier to hybridize the circuit.

AC coupling enhances efficiency

This topology also offers other advantages. Using ac coupling in the level-shifting circuitry increases efficiency because there's no power dissipation with capacitors. Also, you can use the same circuit for motor applications where the supply voltage ranges from tens to hundreds of volts. Obviously, you have to change the transistors and capacitors to accommodate such voltage levels, but there's no need to change circuit topology.

The circuit does have one limitation. It cannot accommodate operation at duty-cycle extremes (one input constantly low with the other constantly high). If an extreme duty-cycle condition persists, coupling capacitors C_1 and C_2 will charge to a voltage level that's high enough to turn off (and perhaps destroy) the two top transistors (Q_1 and Q_2). You can always remedy this problem by restricting the duty-cycle excursions.

In the control system of Fig 6, however, the IXMS150 solves this problem in another way. It places

a minimum limit of $0.5 \mu\text{sec}$ on the output pulse width. Operating at 100 kHz, this translates to a 5 to 95% duty-cycle range. At 20 kHz, the duty-cycle range measures 1 to 99%. Limiting the duty cycle to D_{MAX} in the unrestricted case limits the maximum slew rate to $1 - D_{\text{MAX}}^2$, which translates to 90% at 100-kHz operation.

Fig 7 shows the circuit waveforms for Fig 5. The two top traces illustrate the PWM controller's input voltages. Note that the input voltages aren't exactly complementary, but include a deadtime programmable by using the controller. This deadtime prevents Q_1 and Q_2 from conducting simultaneously. The third trace is the ac component of the phase current, and it indicates a ripple current of about 200 mA p-p. The supply voltage for these measurements is 40V, and the switching frequency is 100 kHz.

Select a phase-current sensing scheme

Most PWM controllers monitor and control the peak of the phase current by comparing the voltage across the sense resistor (or a somewhat filtered version of it) with a ramp voltage. The rationale is that the ripple current has a constant amplitude. Unfortunately, test results demonstrate that ripple current varies with frequency. Even in fixed-frequency systems, the ripple current is directly proportional to the motor supply voltage and to the motor's back-EMF voltage, which is

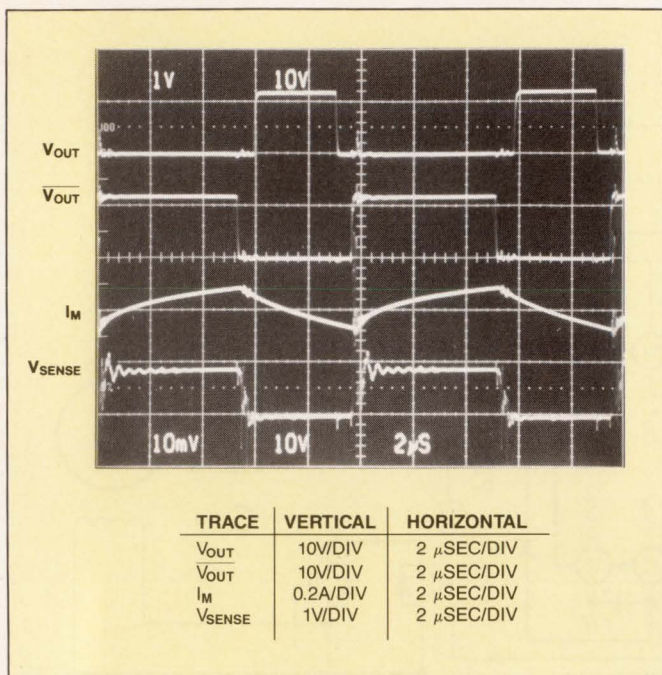

Fig 7—The two top traces show the input voltages from the PWM controller, the third trace shows the ac component of the phase current, and the bottom trace shows the voltage developed across the sense resistor.

a variable. These same test results also show that ripple current is not insignificant when compared to the full-scale current. Thus, you can't neglect its impact in high-precision-control system designs.

The bottom trace in **Fig 7** shows the voltage developed across the sense resistor. This voltage feeds back to the controller; after appropriate signal processing, the circuit compares this voltage with the command input voltage. The ringing at the top of the waveform is associated with the turn-on of the bottom MOSFET transistors and isn't part of the drain current.

PWM switching frequency has a pronounced effect on the ripple current through the motor windings, the resultant eddy-current losses in the motor, and system efficiency. **Fig 8** compares motor current ripple vs

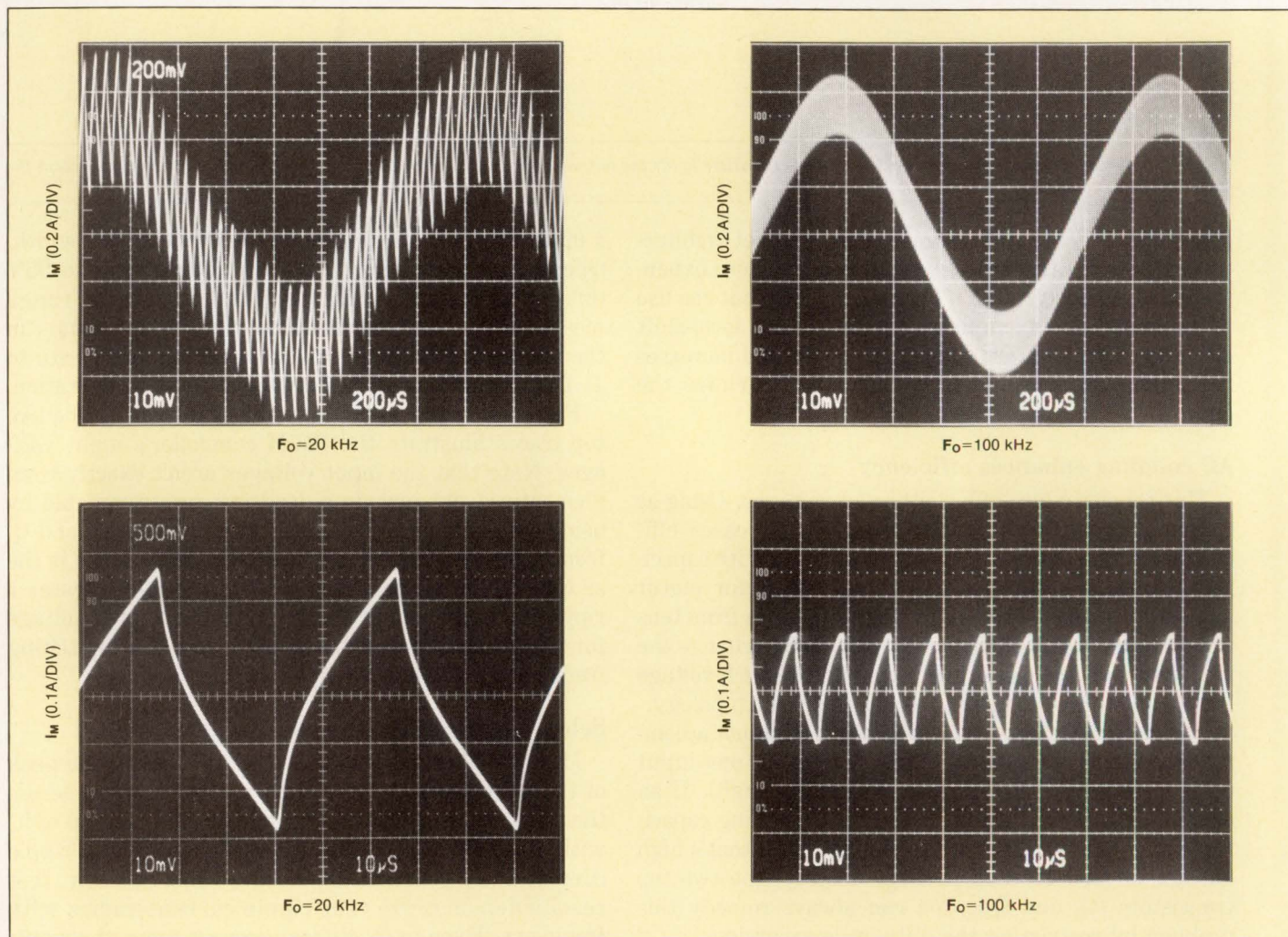

Fig 8—As these scope photos illustrate, current-ripple amplitude isn't exactly inversely proportional to the frequency. In addition, the charge/discharge waveforms appear to have a double time constant.

There are two possible operating modes for H-bridge power stages that use current-regulated PWM control: circulating and noncirculating.

frequency in three ranges: 20, 100, and 250 kHz. As expected, ripple current goes down as frequency increases. Therefore, losses resulting from ripple current also decrease with increasing frequency.

Switching frequency also has an impact on losses in the power stage. These losses, a function of the energy required to turn the power MOSFETs on and off, are proportional to the switching frequency: the higher the frequency, the more on/off transitions per second.

Looking at Fig 8 again, you can see that current-ripple amplitude is not exactly inversely proportional to the frequency. Secondly, charge/discharge waveforms seem to have a double time constant. The motor in the control-system test setup turns out to be the culprit here—its winding inductance actually decreases with

increasing frequency. As unlikely as this might seem, measurement results indicate that, even though the winding inductance is about 3 mH at 1 kHz, it is only 0.8 mH at 100 kHz (Fig 9).

Economic considerations take over

Today, many designers cut system costs by minimizing the number of power supplies; they strive to operate the control section from a single supply. Unfortunately, the current-feedback and reference-input signals are bipolar. In the past, designers used level shifting to solve the problem of the reference-input signal. Level shifting wasn't a good solution for the feedback signal, however, because it was very difficult to implement without degrading accuracy or efficiency.

Another solution to the reference-input level problem uses two inputs (sign and magnitude) instead of the usual bipolar input. Some chip vendors have tried this technique because in theory it requires only one supply. In practice, it's necessary to also use a negative power supply to generate a true zero voltage with a low-impedance drive; otherwise, you have to make a trade-off and sacrifice accuracy.

Sign and magnitude inputs also pose another problem. The input-voltage shape resembles a rectified sine wave, which means the system must have an extremely high-speed response at what would be the zero-crossing points for bipolar inputs.

To circumvent this problem and still accommodate single-supply operation, the controller IC in Fig 6 incorporates an integral negative-bias generator. This circuitry consumes a significant amount of silicon and places stringent demands on noise decoupling. However, it does give the chip flexibility and has no impact on accuracy.

Protect against abnormal conditions

Reliability is a crucial requirement in any system and is especially critical for the high-voltage, high-current, and high-temperature environment of a motor-control system. It is very important to monitor and guard against abnormal conditions such as undervoltage (which would only partially turn on the power transistors and lead to excessive power dissipation in the power stage), overcurrent, and overtemperature (which would destroy the power devices).

The system in Fig 6 incorporates a built-in undervoltage lockout feature. This lockout holds the outputs low (keeping the gates of the power MOSFETs at ground) until the supply exceeds approximately 9V, and the

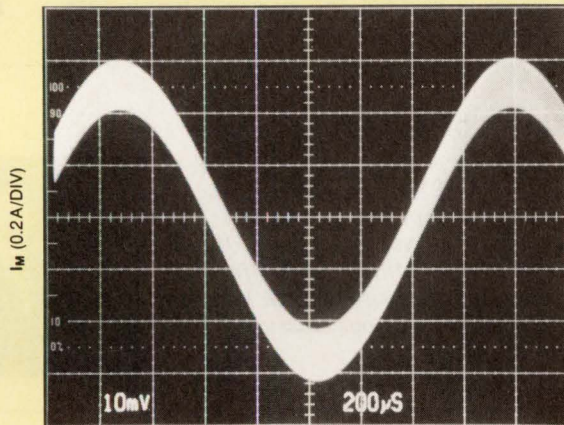

F₀=250 kHz

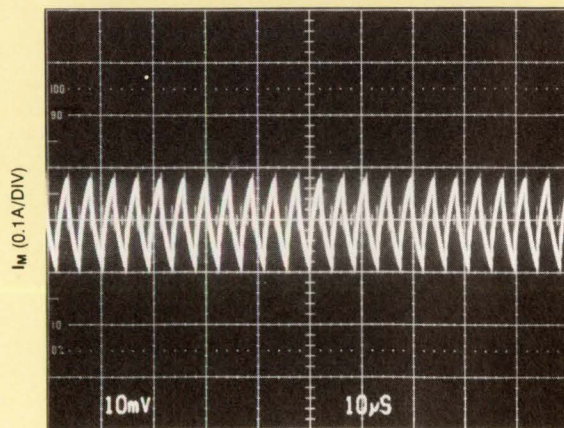

F₀=250 kHz

The PWM switching frequency has a pronounced effect on ripple current through the motor windings.

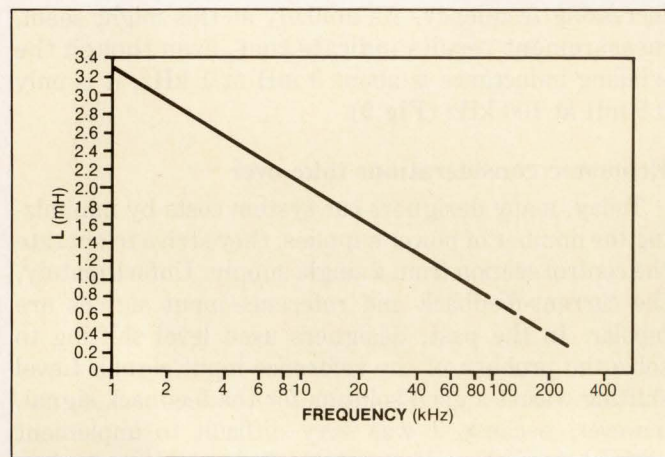

Fig 9—The motor's winding inductance clearly decreases as the PWM switching frequency increases.

internal negative-bias voltage is high enough to accept the negative sense voltages associated with normal operation.

The system also includes a 2-level current-limiting scheme. The first level, which is about 40% above full scale, is time dependent to prevent MOSFET turn-on spikes from tripping the system. The second trip point is at about 250% of full scale and is time independent. With this scheme, a true short will trip the system immediately. Finally, the system provides for overcurrent protection on a cycle-by-cycle basis, with automatic reset at the end of the overcurrent condition.

Because the IXMS150 IC doesn't include an integral power section, the power driver must provide the temperature-sensing function. The controller has a pin available that lets you develop overtemperature protection. Pulling this pin low disables the outputs.

You can also use the output-disable pin as a status-output pin. When the internal circuitry pulls this pin low, it indicates an abnormal condition such as under-voltage, insufficient negative-supply voltage, or over-current conditions. You can use this low-output condition to gate or disable the input voltage until negative-supply levels are well enough established to prevent the possibility of latchup. You can also use this signal to poll the status of a smart system or to disable all channels in a multi-axis system.

Feedforward is best for loop compensation

Loop compensation is the final design tradeoff you have to consider. In all fixed-frequency PWM-control system applications, open-loop gain, motor-current slew rate, and motor-current ripple are proportional to

the motor supply voltage. Feedforward, historically associated with switch-mode power supplies, is an open-loop technique that compensates for variations in the high-voltage level. In applications requiring high-current slew rates (such as high velocities), high supply voltage (with its associated high current ripple) is inevitable.

Using feedforward in a microstepping motor-control system offers some advantages. First, it allows you to use supplies that are not highly regulated. Second, feedforward lets you design sophisticated, high-performance systems that can take advantage of the adaptive motor-supply feature. These systems have to be stable under widely varying motor supply conditions. Without feedforward compensation, gain variations due to supply-voltage changes would complicate system design and severely restrict the system's bandwidth. **EDN**

Author's biography

Yoram Hirsch is director of product development at IXYS Corp in San Jose, CA, and has been employed by the company for the past three years. He holds BSEE and MSEE degrees from Wayne State University, and in his spare time Yoram enjoys classical music and soccer.



Article Interest Quotient (Circle One)

High 494 Medium 495 Low 496

A VME Designer's Guide to Choosing the Perfect Strategic VME Partner.

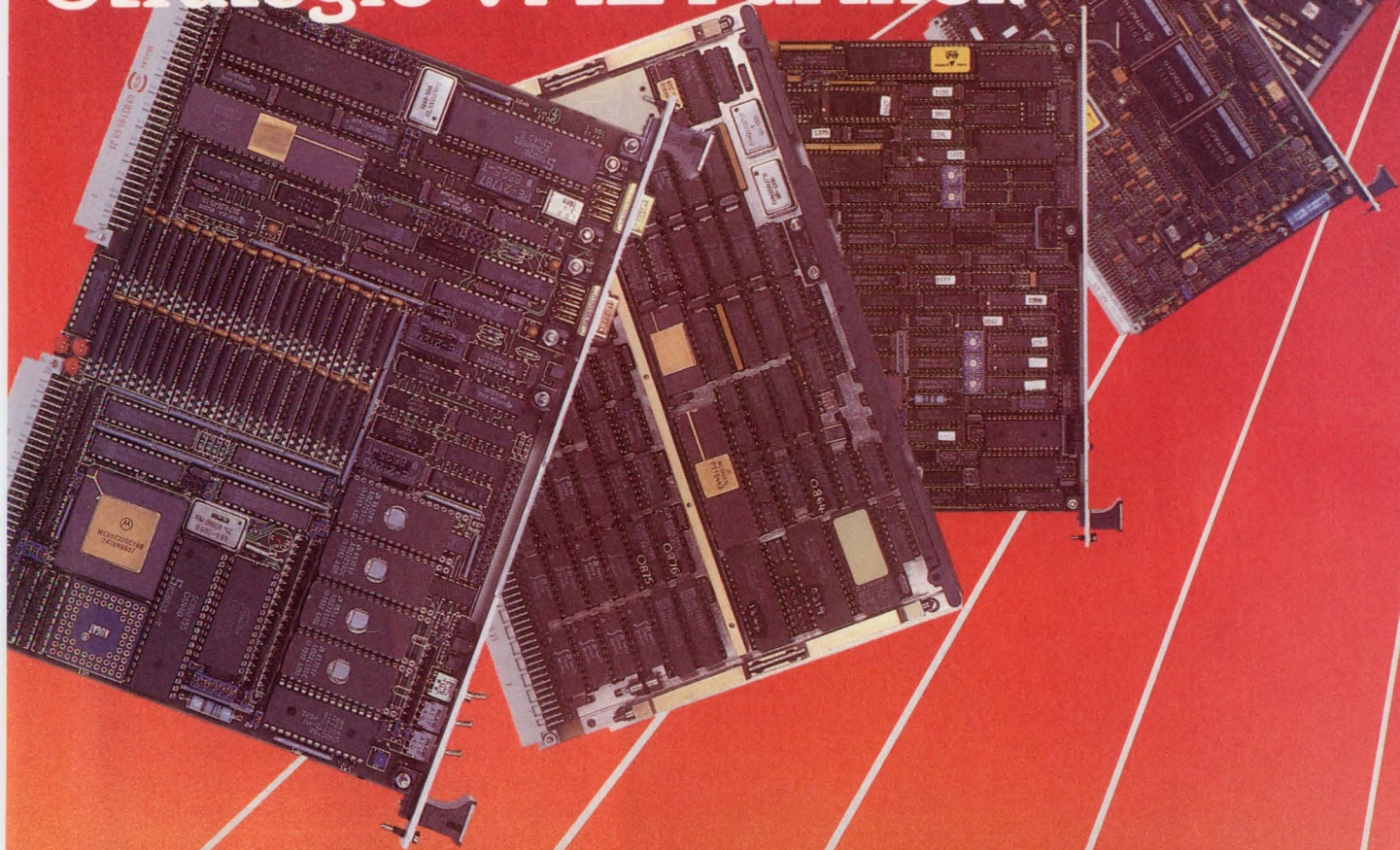

Experience. Start with the basics. Make sure your supplier has extensive board and system level problem solving experience. Nobody in VME has more than 30 years. Except Plessey Microsystems.

Resources. Make sure your supplier is here to stay, with multi-billion dollar corporate resources. That's Plessey . . . proven staying power.

Product. Be sure you can choose from a complete and continually evolving range of hardware, including 16 and 32 bit processors, advanced memory technology, sophisticated I/O and controllers and development systems. With a real choice in integrated software. Plus a full range of true mil spec VME product. Only Plessey Microsystems has all that.

System Support. Choose a supplier who has a superior track record in solving tough problems. With a highly skilled technical support network available worldwide.

Assured Quality. Look for a VME supplier with production facilities that meet U.S., U.K., NATO and international mil standards for quality. Plessey Microsystems is the only one.

Silicon Independence. If your supplier is locked in to specific devices, you may get locked out. Plessey Microsystems is silicon independent.

Confidence. This is the factor that embraces all the others. Make sure you're totally confident that your supplier can serve your needs responsively and reliably . . . today and a decade from today. Make it a company that your top management will trust as much as your engineers do. A company like Plessey.

Call. Now. Or write for details on the only company in VME that really qualifies to be your long-term strategic VME partner. Plessey Microsystems. Ultimate VME strength.

One Blue Hill Plaza, Pearl River, NY 10965-8541
(800) 368-2738, (914) 735-4661
Fax (914) 735 9527
9 Parker, Irvine, CA 92718 (714) 472-2586
Fax (714) 458 7084
2000 E. Lamar Blvd., Arlington, TX 76006
(817) 261-9988 Fax (817) 861 8730



**PLESSEY
MICROSYSTEMS**

PLESSEY and the Plessey symbol are registered trademarks of The Plessey Company plc.

4-bit micros have never displayed more power.

**NEC introduces single-chip,
CMOS devices optimized for
LCD displays.**

Four bits of NEC technology can buy you a whole lot of performance. The new member of our μ PD75000 Series features advanced architecture, VLSI technology and CMOS design. Optimized for LCD displays, this single-chip device rivals 8-bit micros in speed and sophistication.

The μ PD75308GF offers an on-chip programmable LCD controller/driver and four speeds. The top speed is 0.95μ s at 4.19MHz; the slowest, designed for super low-power operation, is 122μ s at 32kHz. You can select optimum combinations of speed, supply voltage and power consumption to meet diverse system display needs. On-chip memories are extra large: 8k-byte program ROM and 512-nibble data RAM.

Other features include enhanced timer and interrupt functions, a systematized instruction set that offers efficient 1/4-8-bit manipulation, and a full kit of hardware/software development tools. We offer both EPROM (μ PD75P308K) and OTP (μ PD75P308GF) versions.

LCD displays are a crucial user interface in telephones, copiers, facsimile systems, typewriters, CD players and VTRs.

To achieve maximum results with minimum circuitry, base your design on NEC's new-generation of 4-bit microcomputers: the μ PD75308GF and 75P308K/GF. 4-bit technology has never looked this good.

For further information, please contact:

| | |
|-----------|--|
| ■ USA | Tel:1-800-632-3531. In California: 1-800-632-3532. TWX: 910-379-6985. |
| ■ Europe | W. Germany Tel:0211-650302. Telex:8589960 NE D. The Netherlands Tel:040-445-845. Telex:51923 NEC B NL. Sweden Tel:08-732-8200. Telex:13839 NECSCAN S. France Tel:1-3946-9617. Telex:699499 NEC EF. Italy Tel:02-6709108. Telex:315355 NECEIT I. UK Tel:0908-691133. Telex:826791 NECUK G. |
| ■ Asia | Hong Kong Tel:3-755-9008. Telex:54561 HKNEC HX. Taiwan Tel:02-522-4192. Telex:22372 HKNEC TP. Singapore Tel:4819881. Telex:39726 NECES RS. |
| ■ Oceania | Australia Tel:03-267-6355. Telex:AA38343 NECBCD. |

1987



Technical-Article Database Index

(November 1986 through April 1987)

Including EDN, Electronic Design, Electronics, Electronic Products, Computer Design, and Digital Design (ESD)

With compliments from EDN

To use this database . . .



Photo courtesy Motorola Inc,
Austin, TX

. . . Look for the topic of interest in the keyword index. If your topic isn't one of the keywords, try a related, but less specific topic. Then go to the appropriate page in the database and scan the article titles, which are listed alphabetically within each keyword category. Information provided in each listing includes article title, author, company, magazine name, issue date, starting page number, and article length.

For more information on the articles listed, please contact each magazine directly.

EDN

Cahners Bldg
275 Washington St
Newton, MA 02158
(617) 964-3030

Electronic Design

10 Mulholland Dr
Hasbrouck Heights, NJ 07604
(201) 393-6000

Electronics

McGraw-Hill Bldg
1221 Avenue of the Americas
New York, NY 10020
(212) 512-2000

Electronic Products

645 Stewart Ave
Garden City, NY 11530
(516) 227-1300

Computer Design

119 Russell St
Littleton, MA 01460
(617) 486-9501

Digital Design (now ESD*)

1050 Commonwealth Ave
Boston, MA 02215
(617) 277-1120

*Digital Design changed its name to ESD in January. For consistency in this database, we've listed this magazine as Digital Design throughout.

1987

Technical-Article Database Index

(November 1986 through April 1987)

Keyword Index

| | | | | | |
|---|-----|--|-----|--|-----|
| Amplifiers | 181 | Digitizers | 189 | Motors/motor controllers | 202 |
| Analog signal processing | 181 | Discrete components, other | 189 | Multipliers | 207 |
| Arithmetic chips/circuits | 181 | Disk controllers | 189 | Multiprocessing | 207 |
| Artificial intelligence | 181 | Disk encoders | 189 | Multiuser computer systems | 207 |
| Artwork generation/plotting equipment (ICs) | 181 | Displays | 189 | Network analyzers/analysis | 207 |
| Automatic test equipment/techniques | 181 | Employment/labor relations/personnel/ recruitment | 189 | standards (nonlocal) | 207 |
| Backplanes | 181 | Engineering workstations | 189 | Networking ICs | 207 |
| Board-level computers | 181 | Ergonomics/product design | 189 | Op amps | 207 |
| Bonders, die/wire/tab | 181 | Fiber optics | 190 | Optical storage | 207 |
| CMOS logic | 181 | Flexible circuits | 190 | Optoelectronics | 207 |
| CMOS technology | 181 | Floppy-disk drives | 190 | Oscilloscopes | 207 |
| CRTs/monitors | 181 | Frequency synthesizers/synthesis/ measurement | 190 | PROM programmers/programming | 207 |
| Capacitors | 181 | Fuses | 190 | Packaging/encapsulation/sealing | 207 |
| Circuit packages | 181 | GaAs technology | 190 | Parallel processing | 207 |
| Communications ICs | 182 | Gate arrays | 190 | Personal computers | 207 |
| Comparators | 182 | Government | 190 | Power converters | 208 |
| Computer languages/compilers/ interpreters | 182 | Graphics boards | 190 | Power semiconductors | 208 |
| Computer operating systems/system software | 182 | Graphics circuits | 190 | Power supplies | 208 |
| Computer software, communications/ networking | 182 | Graphics systems | 190 | Printed circuits | 208 |
| Computer software, data/file management | 182 | Hardware/interconnection, other | 190 | Printed-circuit processing | 208 |
| Computer software, design applications | 182 | Heat sinks/cooling devices | 190 | Printers | 208 |
| Computer software, emulation | 182 | Hybrid circuits | 190 | Probing systems/accessories | 208 |
| Computer software, graphics | 182 | Imports/exports | 190 | Processors, special-purpose (array, front-end, etc) | 208 |
| Computer software, other | 182 | In-circuit emulators/emulation | 197 | Production testing techniques | 208 |
| Computer software, performance measurement | 182 | Inductors | 197 | Professional associations/issues | 208 |
| Computer software, production test | 187 | Industrial electronics | 197 | Programming | 208 |
| Computer software, program development | 187 | Inspection | 197 | Prototyping boards/systems | 209 |
| Computer software, scientific/statistical | 187 | Instrument interface systems | 197 | Relays | 209 |
| Computer software, training | 187 | Instrumentation amps | 197 | Resistors | 209 |
| Computer subsystems/peripherals, other | 187 | Instrumentation/design aids & services/ measurement, other | 197 | Rigid-disk drives | 209 |
| Computer systems/system design, other | 187 | Integrated circuits/semiconductor devices/circuit design, other | 197 | Robotics | 209 |
| Computer-aided design/engineering (CAD/CAE) | 187 | Interconnection systems | 198 | Scientific computer systems | 209 |
| Computer-aided manufacturing/testing (CAM/CAT) | 188 | Keyboards | 198 | Screen printers | 209 |
| Conferences/conventions/shows | 188 | Land & plant sites | 198 | Semicustom/custom ICs | 209 |
| Connectors | 188 | Legal issues | 198 | Sensors/transducers | 209 |
| Consumer electronics | 188 | Linear circuits | 198 | Signature analyzers/analysis | 209 |
| Corporate appointments/development/ strategies | 188 | Local-area network architecture/design/ design standards | 198 | Simulators/simulation | 209 |
| Counters | 188 | Logic analyzers/analysis | 198 | Sockets | 210 |
| Crystals/crystal oscillators | 188 | Logic arrays/systems | 198 | Speech synthesis/recognition | 210 |
| Data acquisition/communications, other | 188 | Mainframe computers | 198 | Standards | 210 |
| Data-acquisition systems/techniques | 188 | Management | 198 | Surface-mounting devices/techniques | 210 |
| Data-communications systems/ techniques | 188 | Marketing/markets/pricing | 198 | Switches | 210 |
| Data converters | 189 | Materials research/development | 198 | Switching circuits | 210 |
| Data encryption/decryption/verification | 189 | Memory boards/systems | 201 | TTL logic | 210 |
| Data loggers/recorders | 189 | Memory controllers | 201 | Technology/research, other | 210 |
| Data processing | 189 | Memory devices | 201 | Telecommunications | 210 |
| Design services | 189 | Microcomputer buses/interfaces | 201 | Terminal controllers | 210 |
| Development systems | 189 | Microcomputers | 201 | Terminals | 210 |
| Digital multimeters (DMMs) | 189 | Microprocessor buses | 201 | Timer ICs/circuits | 210 |
| Digital signal processing | 189 | Microprocessor support chips | 201 | Touch-screen devices | 210 |
| | | Microprocessors | 202 | Track/hold amps | 210 |
| | | Military electronics | 202 | Transformers | 210 |
| | | Minicomputers | 202 | Transmitter/receiver circuits | 210 |
| | | Modems | 202 | Trigger circuits | 210 |
| | | Monitor circuits | 202 | Video | 210 |
| | | Motor control circuits | 202 | Vision systems | 212 |
| | | | | Wire/cable | 212 |

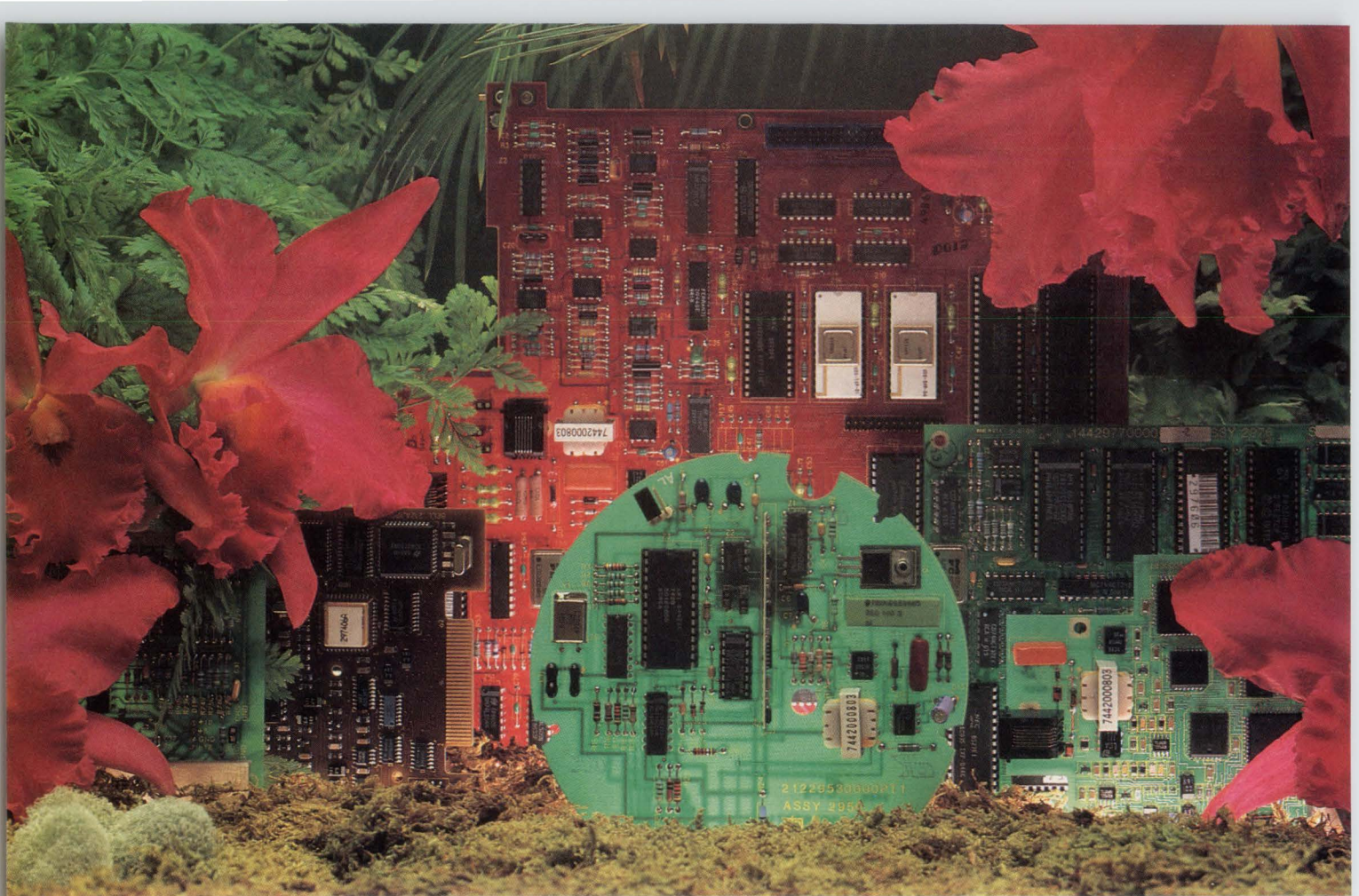

Exotic Customs at UDS

The special requirements of data communications OEMs have resulted in some pretty exotic custom modem cards from Universal Data Systems.

Funny form factors are routine fare for our custom designers. Nooks, crannies and odd card configurations are no problem, given sufficient square inches of real estate. UDS engineers have even designed a circular 212A modem that fits in the back of a residential electric meter.

Non-standard modem functions are another specialty of the house. For example, UDS engineers have already designed and



For a generous sampling of UDS' custom design capabilities, ask for the new, free OEM modem brochure.

delivered a hand-held RF modem operating at 4800 bps!

UDS has successfully handled more than 3,000 custom OEM modem design assignments — and we can handle yours. To begin an exotic custom, contact Universal Data Systems, 5000 Bradford Drive, Huntsville, AL 35805. Telephone 205/721-8000; Telex 752602 UDS HTV.



Universal Data Systems



UDS modems are offered nationally by leading distributors. Call the nearest UDS office for distributor listings in your area.
 DISTRICT OFFICES: Apple Valley, MN, 612/432-2344 • Atlanta, GA, 404/998-2715 • Aurora, CO, 303/368-9000 • Blue Bell, PA, 215/643-2336 • Boston, MA, 617/875-8868 • Columbus, OH, 614/895-3025 • East Brunswick, NJ, 201/238-1515 • Glenview, IL, 312/998-8180 • Houston, TX, 713/988-5506 • Huntsville, AL, 205/721-8000 • Issaquah, WA, 206/392-9600 • Livonia, MI, 313/522-4750 • Mesa, AZ, 602/820-6611 • Milwaukee, WI, 414/273-8743 • Mission Viejo, CA, 714/770-4555 • Mountain View, CA, 415/969-3323 • Richardson, TX, 214/680-0002 • St. Louis, MO, 314/434-4919 • St. Peters, MO, 314/434-4919 • Silver Spring, MD, 301/942-8558 • Tampa, FL, 813/684-0615 • Uniondale, NY, 516/222-0918 • Van Nuys, CA, 818/891-3282 • Willowdale, Ont, Can, 416/495-0008 • Winston-Salem, NC, 919/760-4184

Created by Dayner/Hall, Inc., Winter Park, Florida

EDN TECHNICAL-ARTICLE DATABASE

A

Amplifiers

- Composite amplifiers yield high speed and low offset. *Williams, Jim, Linear Technology Corp; EDN, 01/22/87, pg 139, 11 pgs.*
- Flexible PGA designs require few components. *Kaniel, Akavia, Intech Inc; EDN, 01/22/87, pg 181, 5 pgs.*
- GaAs ICs add gain block to rf designer's arsenal. *Schappacher, Jerry, Harris Microwave Semiconductor; Electronic Design, 03/05/87, pg 109, 2.5 pgs.*
- Hybrid isolation amps zap price and voltage barriers. *Smith, Greg, Burr-Brown; Electronic Design, 12/11/86, pg 91, 4.5 pgs.*
- Instrumentation amp suits wide range of circuit designs. *Burt, Rod, Burr-Brown; EDN, 01/08/87, pg 157, 7 pgs.*
- Monolithic operational amplifiers. *Travis, Bill, Senior Editor; EDN, 11/13/86, pg 134, 12.5 pgs.*
- Power op amps solve deflection-yoke drive problems. *Scofield, Granger, Apex Microtechnology; EDN, 02/19/87, pg 171, 6 pgs.*

Analog signal processing

- Low-power op amp delivers precision at low signal levels. *Bowers, Derek F, Kapoor, Art, Precision Monolithic; EDN, 01/08/87, pg 185, 5.5 pgs.*

Arithmetic chips/circuits

- A crucial step toward ultra-fast data paths. *Staff; Electronics, 11/27/86, pg 78, 1 pg.*
- New coprocessors head toward supermini speeds. *Wilson, Ron, Staff Editor; Computer Design, 04/15/87, pg 23, 6 pgs.*
- Processor chip set shrinks latency, boosts throughput. *Peterson, Jim; Leibowitz, Robert N, Bipolar Integrated Technology; Electronic Design, 02/05/87, pg 75, 4.5 pgs.*
- This CPU does floating point faster than any two-chip set. *Staff; Electronics, 11/27/86, pg 51, 5 pgs.*

Artificial intelligence

- AI general-purpose versus tagged machines. *Aseo, Joseph, Staff Editor; Digital Design, 02/87, pg 33, 3 pgs.*
- AI meets parallel processing. *Billstrom, David, Intel Scientific Computers; Teeter, John, Gold Hill Computers; Digital Design, 12/86, pg 38, 3 pgs.*
- CIM: The right medicine for electronic manufacturing? *Shapiro, Sydney F, Staff Editor; Computer Design, 11/01/86, pg 73, 12 pgs.*
- Expert systems poised to reshape industry. *Schindler, Max, Staff Editor; Electronic Design, 03/19/87, pg 29, 2 pgs.*
- General-purpose machines and PCs emerge as AI platforms. *Hindin, Harvey J, Staff Editor; Computer Design, 11/01/86, pg 43, 6 pgs.*
- Imaging joins forces with AI. *Wilson, Andrew C, Staff Editor; Digital Design, 01/87, pg 53, 2.5 pgs.*
- Microcontrollers teach robots to learn. *Cormier, Denny, Staff Editor; Digital Design, 03/87, pg 38, 3 pgs.*
- Special report: AI boosts IQ of silicon compilers. *McLeod, Jonah, Staff Editor; Electronics, 04/30/87, pg 54, 4 pgs.*
- TI puts its Lisp chip into a system for military AI. *Wolfe, Alexander, Staff Editor; Electronics, 03/19/87, pg 95, 2 pgs.*

Artwork generation/plotting equipment (ICs)

- Expert designers evaluate PC-based schematic editors. *Freeman, Eva, Associate Editor; EDN, 12/25/86, pg 82, 4.5 pgs.*

Automatic test equipment/techniques

- Can testers catch up with complex chips? *McLeod, Jonah, Staff Editor; Electronics, 01/22/87, pg 49, 4 pgs.*
- The sky is not falling in the ATE world. *McLeod, Jonah, Staff Editor; Electronics, 11/13/86, pg 68, 4 pgs.*

B

Backplanes

- Power planes increase wire-wrapped circuit speeds. *Visco, P Anthony, Mupac Corp; EDN, 11/27/86, pg 225, 3 pgs.*

Board-level computers

- 32-bit VME CPUs pack power of a VAX onto just one board. *Panasuk, Curtis, Staff Editor; Electronic Design, 12/11/86, pg 59, 6 pgs.*
- A spate of better models spark an exploding market. *Wolfe,*

- Alexander, Staff Editor; Electronics, 03/19/87, pg 87, 4 pgs.*
- Board-level systems set the trend in data acquisition. *Shapiro, Sydney F, Staff Editor; Computer Design, 04/01/87, pg 59, 12.5 pgs.*
- Buyers guide to single-board computers. *Staff; Computer Design, 02/15/87, pg 81, 34.5 pgs.*
- Controllers spark fast data transfers in VMEbus systems. *Ohr, Stephan, Staff Editor; Electronic Design, 12/11/86, pg 73, 5.5 pgs.*
- Make your own low-cost 8051 emulator. *Horton, Eric P, Nova Scotia Power Corp; EDN, 11/13/86, pg 193, 12 pgs.*
- Single-board computers offer designers system-level performance. *Mokhoff, Nicolas, Staff Editor; Computer Design, 02/15/87, pg 63, 9 pgs.*

Bonders, die/wire/tab

- The door is opening for chip-on-board assembly. *Lyman, Jerry, Staff Editor; Electronics, 12/18/86, pg 101, 2 pgs.*

C

CMOS logic

- Advances in CMOS and ECL process technology yield power-house ICs. *Marrin, Ken, Staff Editor; Computer Design, 12/86, pg 81, 9.5 pgs.*
- CMOS ADC achieves reliable 12-bit resolution. *Reidy, John, et al, Analog Devices; EDN, 03/04/87, pg 131, 13.5 pgs.*
- Check lists help you avoid trouble with MOS and memory ICs. *Sokal, Nathan O, Design Automation Inc; EDN, 11/27/86, pg 229, 5.5 pgs.*
- Integrated current sensing simplifies MOSFET designs. *Young, Sean, International Rectifier Corp; EDN, 11/13/86, pg 215, 5 pgs.*
- Interface various IC technologies to CMOS arrays. *Stansberry, Mark, National Semiconductor; EDN, 03/04/87, pg 153, 4 pgs.*
- Manufacturers of fast CMOS logic families take sides in packaging controversy. *Mosley, JD, Regional Editor; EDN, 04/15/87, pg 69, 7.33 pgs.*
- Memory-based CMOS FIFO buffers sport large capacities, rival the speed of bipolars. *Harold, Peter, European Editor; EDN, 03/18/87, pg 65, 6.33 pgs.*
- TI's pinout scheme for ACL devices still under attack. *Bond, John, Contributing Editor; Computer Design, 11/15/86, pg 28, 3 pgs.*

CMOS technology

- Analog CMOS will breed unpredictable discoveries. *Fullagar, David J, Maxim Integrated Products; Electronic Products, 01/15/87, pg 39, 2 pgs.*
- At IEDM, new ways to boost chip speed and density. *Staff; Electronics, 11/27/86, pg 66, 3 pgs.*
- CMOS devices close in on bipolar logic. *Thompson, Bill, Texas Instruments; Beijer, Albert, Signetics; Computer Design, 01/15/87, pg 73, 3 pgs.*
- ECL gains ground in battle against CMOS. *Leibowitz, Bob; Taylor, Greg, Bipolar Integrated Technology; Computer Design, 04/01/87, pg 91, 5 pgs.*
- Manufacturers of fast CMOS logic families take sides in packaging controversy. *Mosley, J D, Regional Editor; EDN, 04/15/87, pg 69, 7.33 pgs.*
- Mixed analog/digital technologies pack complete systems on-chip. *Martin, Steven L, Contributing Editor; Computer Design, 04/01/87, pg 39, 6 pgs.*
- National's CMOS process tailored for analog ICs. *Staff; Electronics, 02/05/87, pg 75, 1.5 pgs.*

CRTs/monitors

- External hardware augments low-cost display controller. *Stelbrink, Juergen, Advanced Micro Devices Inc; EDN, 11/27/86, pg 209, 6 pgs.*

Capacitors

- Capacitors. *Travis, Bill, Senior Editor; EDN, 01/22/87, pg 116, 13 pgs.*
- Inrush of switching power supplies propels advances in materials, technology. *Biancomano, Vincent, Staff Editor; Electronic Design, 11/13/86, pg 83, 4 pgs.*

Circuit packages

- Cost, device speed, size, and reliability determine the best package for an ASIC. *Freeman, Eva, Associate Editor; EDN, 04/30/87, pg 77, 5 pgs.*

EDN TECHNICAL-ARTICLE DATABASE

Communications ICs

- A modem chip that needs only one 5-V power supply. *Staff; Electronics, 01/08/87, pg 81, 3 pgs.*
- Analog arrays speed design and lower cost of uhf chips. *Heyes, Gary L; Shier, John S, VTC; Electronic Design, 12/11/86, pg 119, 4 pgs.*
- Availability of cryptographic ICs augurs the increasing use of data encryption. *Terry, Chris, Associate Editor; EDN, 01/22/87, pg 63, 4 pgs.*
- Digital video data can now travel by Taxi. *Vesuna, Sarosh; Price, Simon, Advanced Micro Devices; Computer Design, 02/01/87, pg 79, 4.5 pgs.*
- Ethernet/CheaperNet chips: The power and the process. *Cormier, Denny, Staff Editor; Digital Design, 04/87, pg 87, 3 pgs.*
- Faster, cheaper modem ICs are well on their way. *Allan, Roger, Staff Editor; Electronic Design, 04/30/87, pg 81, 8 pgs.*
- GaAs cells simplify high-speed communications. *Schappacher, Jerry B, Davis, Richard T, Harris Microwave Semiconductor; Digital Design, 02/87, pg 57, 3 pgs.*
- ISDN terminals simplify data transmissions. *O'Toole, Tony, EDN, 01/22/87, pg 167, 8 pgs.*
- LAN ICs let you build networks for PCs. *Cormier, Denny, Regional Editor; EDN, 12/11/86, pg 136, 8.5 pgs.*
- Low-cost chip set offers Bell 103 functions. *Wolbert, Bob, Exar; Computer Design, 03/01/87, pg 73, 4 pgs.*
- Modem prices drop as chips absorb more functions. *Chester, Michael, Staff Editor; Electronic Products, 03/01/87, pg 28, 6 pgs.*
- Some silicon solutions for MAP. *Loyer, Bruce A, Motorola Semiconductor Products; Electronic Products, 03/15/87, pg 60, 8 pgs.*
- The furious race to develop 2,400-b/s modem chip sets. *Lineback, J Robert, Staff Editor; Electronics, 01/08/87, pg 84, 3 pgs.*
- Two-chip modem suits high-speed LAN systems. *Shah, Prasanna M, Signetics Corp; EDN, 03/31/87, pg 171, 8.5 pgs.*
- Variety reigns supreme in ISDN chip sets. *Spadaro, Joseph J, Staff Editor; Electronic Products, 03/15/87, pg 55, 3.5 pgs.*
- Video codecs send full-motion CGA images over the phone. *Cormier, Denny, Staff Editor; Digital Design, 04/87, pg 93, 2 pgs.*

Comparators

- Synchronous-network circuit boosts network flexibility. *Vesuna, Sarosh N, Advanced Micro Devices; EDN, 11/13/86, pg 231, 6 pgs.*

Computer languages/compiler/interpreters

- A compiler for semicustom solutions. *Staff; Electronics, 02/05/87, pg 62, 3 pgs.*
- Code optimization speeds C throughput. *Wolverton, Frank B; Hedrick, Ellen L, AT&T Information Systems; Computer Design, 11/01/86, pg 117, 4 pgs.*
- Here come the tools to design 50,000-gate ASICs. *McLeod, Jonah, Staff Editor; Electronics, 02/05/87, pg 55, 4 pgs.*
- Lisp tackles real data and abstract concepts. *Gabriel, Richard P, Lucid; Computer Design, 03/15/87, pg 78, 6 pgs.*
- Mainframe architectures and compiler techniques power 32-bit micros. *Marrin, Ken, Staff Editor; Computer Design, 02/01/87, pg 57, 12 pgs.*
- New compilers feature flexibility and fewer restrictions. *Martin, Steven L, Contributing Editor; Computer Design, 02/15/87, pg 34, 2 pgs.*
- Parallel processing makes compiler advances. *Meng, Brita, Staff Editor; Digital Design, 03/87, pg 61, 3.5 pgs.*
- Second-generation compilers optimize semicustom circuits. *Rowson, Jim; Trimberger, Steve, VLSI Technology; Electronic Design, 02/19/87, pg 92, 5 pgs.*
- Software-development environments grow interactive. *Suydam, William, Contributing Editor; Computer Design, 04/15/87, pg 45, 5 pgs.*
- Special report: AI boosts IQ of silicon compilers. *McLeod, Jonah, Staff Editor; Electronics, 04/30/87, pg 54, 4 pgs.*
- The first GaAs compiler is already producing chips. *McLeod, Jonah, Staff Editor; Electronics, 04/30/87, pg 58, 3 pgs.*

Computer operating systems/system software

- A work station that runs Unix and MS-DOS side by side. *Staff; Electronics, 11/13/86, pg 63, 3 pgs.*
- CASE makes strides toward automated software development. *Suydam, William, Contributing Editor; Computer Design, 01/01/87, pg 49, 11 pgs.*
- DOS compatibility spurs design-ins for 80386. *Williams, Tom, Staff Editor; Computer Design, 01/15/87, pg 22, 2.5 pgs.*

EDIF format brings uniformity to CAE/CAD data. *Marx, Esther, Switzer, Hart, Motorola Inc; EDN, 01/22/87, pg 153, 5.5 pgs.*

Microprocessor experts tackle benchmarking, support and architectural issues in open debate. *Marrin, Ken, Staff Editor; Computer Design, 01/01/87, pg 21, 5.5 pgs.*

Software opens new windows for 80386-based workstations. *Gold, Martin, Staff Editor; Electronic Design, 12/11/86, pg 27, 1 pg.*

Suddenly, work-station makers unite on a windowing standard. *Manuel, Tom, Staff Editor; Electronics, 01/22/87, pg 58, 2 pgs.*

Toolkit helps build VME-based UNIX systems. *Condry, Michael; Dietrich, William, AT&T; Digital Design, 03/87, pg 85, 3 pgs.*

Unix environment offers flexible I/O design. *Petersen, J F; Picus, S J, AT&T; Computer Design, 11/15/86, pg 84, 5.5 pgs.*

Wanted: Communications software for multiprocessing. *Boberg, Richard W, Microbar Systems; Digital Design, 03/87, pg 72, 4 pgs.*

Computer software, communications/networking

Wanted: Communications software for multiprocessing. *Boberg, Richard W, Microbar Systems; Digital Design, 03/87, pg 72, 4 pgs.*

Computer software, data/file management

Object-oriented database keeps the house in order. *McCaskey, John, Data General; Electronic Design, 03/19/87, pg 129, 5 pgs.*

Computer software, design applications

Combine C and assembly language for the 8086/88. *Warner, William C, Consultant; EDN, 03/18/87, pg 195, 4 pgs.*

Expert systems as engineering tools will broaden productivity/creativity options. *Mosley, J D, Regional Editor; EDN, 11/13/86, pg 91, 5.33 pgs.*

Low-cost pc-board layout software. *Freeman, Eva, Associate Editor; EDN, 03/18/87, pg 139, 9.5 pgs.*

Silicon compilation to win more users and vendors. *Uvelli, David A; Whitner, Stephen M, Seattle Silicon; Electronic Products, 01/15/87, pg 44, 2 pgs.*

Computer software, emulation

Analog simulator models multitechnology systems. *Johnson, Doug, Analogy; Computer Design, 11/15/86, pg 92, 4 pgs.*

Debug system targets multiprocessor design. *Noelcke, Gus, Northwest Instrument Systems; Computer Design, 11/01/86, pg 105, 6.5 pgs.*

In-circuit emulators crowd eagerly onto the PC platform. *Leonard, Milt, Staff Editor; Electronic Products, 02/01/87, pg 19, 4 pgs.*

Make your own low-cost 8051 emulator. *Horton, Eric P, Nova Scotia Power Corp; EDN, 11/13/86, pg 193, 12 pgs.*

Microprogram monitor helps develop bit-slice designs. *Richardson, Brian, Hewlett-Packard Co; EDN, 03/31/87, pg 191, 5 pgs.*

Computer software, graphics

A million pixels and up launched on IBM PCs. *Chester, Michael, Staff Editor; Electronic Products, 01/01/87, pg 14, 2.5 pgs.*

Array processor spurs faster imaging. *Kayat, Mike, Sky Computers; Digital Design, 02/87, pg 70, 3 pgs.*

Bringing solids modeling to the PC. *Leszkowicz, Irene, Matrox Electronic Systems; Digital Design, 04/87, pg 57, 3 pgs.*

Color graphics homes in on bus computers. *Lieberman, David, Staff Editor; Electronic Products, 01/01/87, pg 47, 6 pgs.*

Imaging hardware gets software support. *Wilson, A, Staff Editor; Digital Design, 12/86, pg 21, 1 pg.*

Industry consortium starting X-Windows bandwagon. *Williams, Tom, Staff Editor; Computer Design, 02/01/87, pg 45, 1.5 pgs.*

X-Windows potential aid to network connectivity. *Williams, Tom, Staff Editor; Computer Design, 03/15/87, pg 44, 2.5 pgs.*

Computer software, other

Cross-development tools for PCs and minis let you develop software for 8-bit μ Ps. *Terry, Chris, Associate Editor; EDN, 04/15/87, pg 89, 3.66 pgs.*

Computer software, performance measurement

ASIC-verification systems speed prototype testing, but system capabilities vary. *Everett, Chris, Regional Editor; EDN, 11/27/86, pg 51, 8 pgs.*

Approaches to software testing embroiled in debate. *Suydam,*

Text continued on pg 187

EDN August 6, 1987

Who manages the power in Honeywell's AEWTS and ETS?

KEPCO POWER MANAGERS™



Honeywell's Dual-Port Advanced Electronic Warfare Test Set (AN/USM-487), shown here, is designed for testing the Joint Services AN/ALQ-165 Airborne Self-Protection Jammer, and six other EW systems, to meet stringent Navy shipboard throughput requirements. Their Electronic Test Set (AN/USM-603) has been selected for intermediate level testing and fault isolation of line replaceable units from the USAF AN/ALQ-172 electronic warfare system.

Kepeco's Series ATE Power Managers interfaced to an IEEE bus through Kepeco SNR 488-8 digital programmers, manage all the controlled power requirements, for both systems, furnishing the critical programmed test voltages and logic levels to the unit under test.

The Kepeco Power Managers are linear programmable power supplies that have been especially designed for programming applications, using either analog or digital control signals. They can scale a uniform 0-1V or 0-10V control signal into any desired

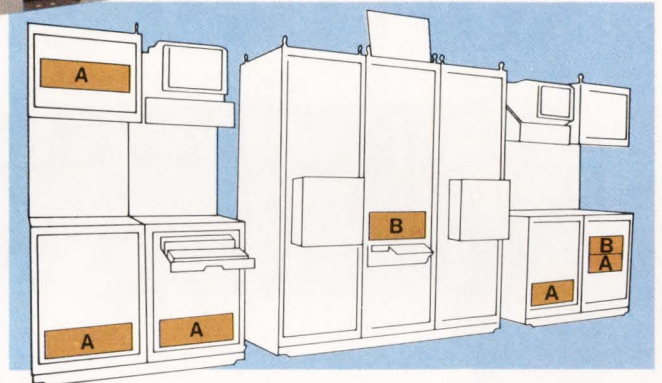

This Honeywell AEWTS incorporates ten Kepeco ATE Power Managers (A), programmed by two Kepeco SNR 488-8 Digital Programmers (B).

output within their range, and respond to programming step inputs in microseconds. They control voltage to 0.001% and current to 0.005%, from zero through their entire range, and give you maximum rated voltage and maximum rated current *at the same time*.

They offer, in short, the most precise, the most flexible control of power available.

To learn more, write to Dept. KDF-12.



KEPCO, INC. • 131-38 SANFORD AVENUE, FLUSHING, NY 11352 USA • (718) 461-7000 • TWX #710 582 2631 • FAX (718) 767-1102.

ISLAND
AUTOMATION, INC.

SEND
HARRIS
ICs

**Hardware...
software...
beachware!
Nothing wears better
in your islands of
automation than
our 80C86 circuits.**

*"What's he doing with
those Harris ICs?"*

*"Going head-first
into factory automation."*

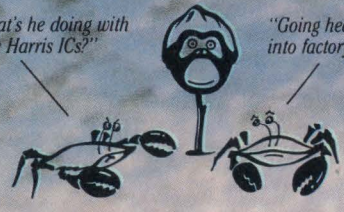

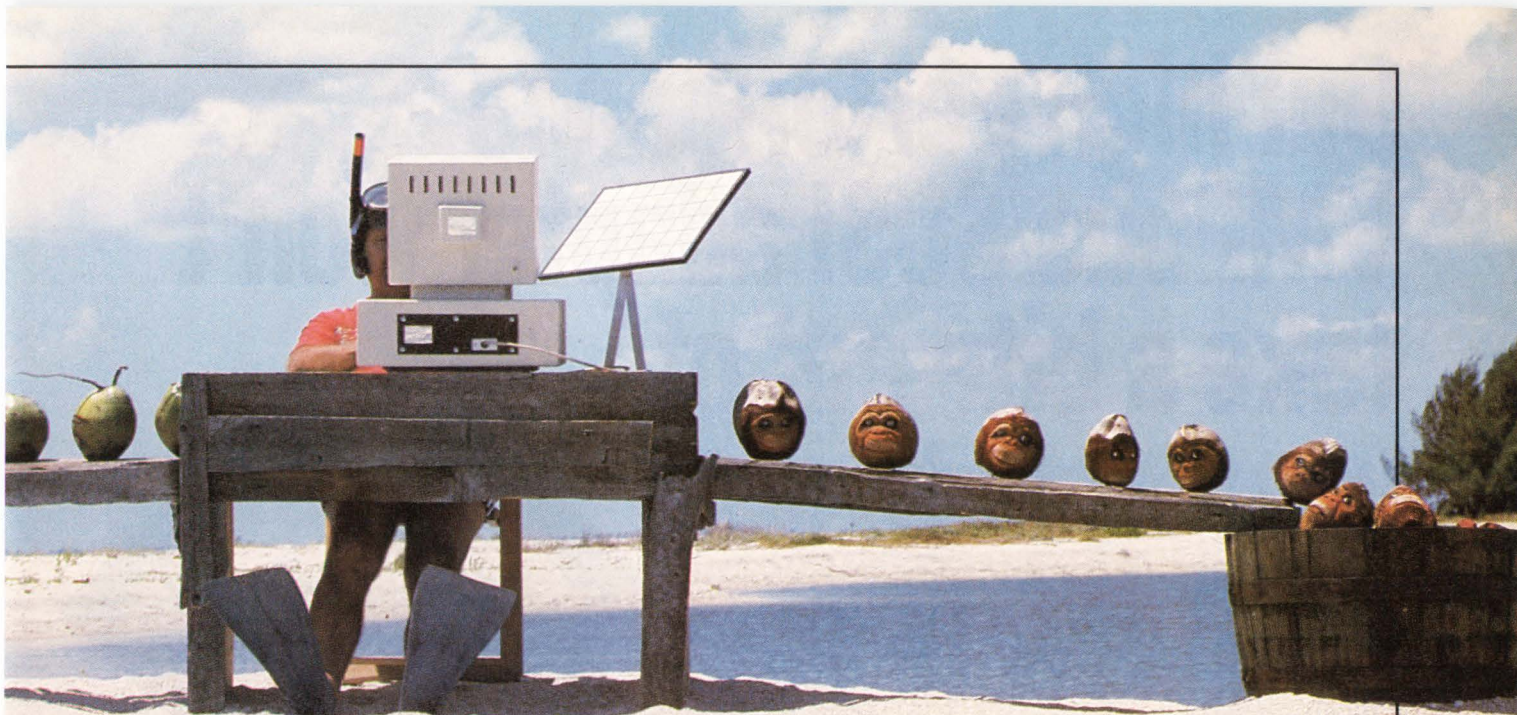

Their reliable operation turns every island into paradise.

It's a simple fact: to do more in factory automation, give your local islands of automation the ability to do more...with Harris industrial-grade 80C86 microprocessors and peripherals.

The Harris 80C86 family is designed and built for industrial, full temperature range operation (-40°C to $+85^{\circ}\text{C}$)—not cherry-picked from commercial product. They thrive in the toughest conditions—shock, heat, vibration, contaminants and more. Their high performance under these adverse conditions increases system reliability, factory throughput and your competitiveness.

Our proven static circuits give you the flexibility to design the lowest-power systems possible by running the system at the speed you need and only when you need it...from the maximum operating frequency to a complete stop.

And low power means low system operating temperatures, no fans, smaller power supplies and sealed enclosures, preparing your system to meet the rigors of the factory floor. For space-critical applications, choose plastic leaded chip carriers (PLCCs) to reduce board and system size even more. For package count reduction, use our semicustom cell library to combine 80C86-family peripheral circuits with glue logic on a single chip.

Harris low-power static 16-bit and 8-bit CMOS CPUs and peripheral circuits will transport your system to new levels of function and flexibility, whether you're building robots, data acquisition systems, process and numerical controllers or advanced instrumentation.

Harris 80C86 and 80C88 CMOS μPs and support circuits: the smart choice for improving performance and reliability in intelligent factory automation.

Contact your Harris Semiconductor travel agent and get started on your trip to paradise. In U.S. phone 1-800-4-HARRIS, Ext. 1275. In Canada: 1-800-344-2444, Ext. 1275.

IN INDUSTRIAL CMOS,
THE NAME IS
HARRIS

Harris Semiconductor: Analog - CMOS Digital
Gallium Arsenide - Semicustom - Custom



Our high performance VMEbus/SCSI adapter won't take a bite out of your wallet.



The Rimfire® 3500 SCSI Host Bus Adapter is for VMEbus users who want it all. Performance. Versatility. And low price.

It's for designers who want to pass through any command—including vendor-unique and CCS commands—directly to SCSI devices.

It's for those who want a simple command queuing software interface, free of timing restrictions. For those who want to conserve bus bandwidth with a 30 Mbyte/sec VMEbus burst rate.

And for those who want to overlap commands on peripheral devices, the adapter supports disconnect/reconnect.

The Rimfire 3500 adapter is for integrators who want floppy

support for up to 4 dual or quad density drives.

For those looking ahead to faster data rates, the Rimfire 3500 adapter provides 4.0 Mbyte/sec synchronous as well as 1.5 Mbyte/sec asynchronous transfer rate capability. For interconnection flexibility, differential transceivers are an option.

Behind all this high performance is Ciprico support. A full staff to develop and support UNIX® drivers. Factory and field support engineers. 48-hour turn-around on board repair. And the expertise gained from over 40,000 disk and tape controller boards installed worldwide.

As for price...

The Rimfire 3500 adapter is the best price/performance VMEbus/SCSI adapter you can get. OEM pricing is under \$995.

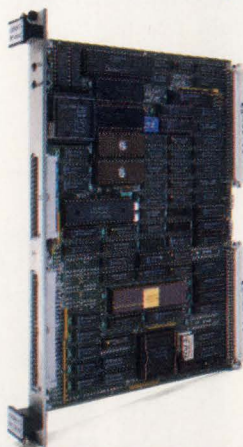

The Ciprico Rimfire 3500 Host Bus Adapter enables VMEbus system developers to take full advantage of any high performance SCSI device. Software support for the board includes drivers for the System V and BSD 4.2 versions of the UNIX operating system.

UNIX is a registered trademark of AT&T. Ciprico and Rimfire are registered trademarks of Ciprico Inc.



Ciprico Inc.
2955 Xenium Lane
Plymouth, MN 55441
612-559-2034

For more information call from your modem **1-800-332-0012** (300-1200 baud, 8 bit, no parity 1 stop bit) and enter the access code **CIPBUS2** when prompted. (In VA call 703-476-5255)

You can take us for granted.

EDN TECHNICAL-ARTICLE DATABASE

- William E, Contributing Editor; Computer Design, 11/15/86, pg 49, 5 pgs.*
- Code optimization speeds C throughput. *Wolverton, Frank B; Hedrick, Ellen L, AT&T Information Systems; Computer Design, 11/01/86, pg 117, 4 pgs.*
- Debug system targets multiprocessor design. *Noelcke, Gus, Northwest Instrument Systems; Computer Design, 11/01/86, pg 105, 6.5 pgs.*
- How to benchmark a supercomputer. *Dodson, David S; Gray, Ronald W, Convex Computer; Digital Design, 04/87, pg 63, 4 pgs.*
- Software analyzers team up to track down complex bugs. *Ableidinger, Bruce, Northwest Instrument Systems; Electronic Design, 11/27/86, pg 125, 4 pgs.*
- Computer software, production test**
- Approaches to software testing embroiled in debate. *Suydam, William E, Contributing Editor; Computer Design, 11/15/86, pg 49, 5 pgs.*
- Expert systems as engineering tools will broaden productivity/creativity options. *Mosley, J D, Regional Editor; EDN, 11/13/86, pg 91, 5.33 pgs.*
- Computer software, program development**
- Code optimization speeds C throughput. *Wolverton, Frank B; Hedrick, Ellen L, AT&T Information Systems; Computer Design, 11/01/86, pg 117, 4 pgs.*
- Cross-development tools for PCs and minis let you develop software for 8-bit μ Ps. *Terry, Chris, Associate Editor; EDN, 04/15/87, pg 89, 3.66 pgs.*
- Microprogram monitor helps develop bit-slice designs. *Richardson, Brian, Hewlett-Packard Co; EDN, 03/31/87, pg 191, 5 pgs.*
- Optimizing the software development environment. *Richmond, Michael, Intel; Digital Design, 03/87, pg 45, 3 pgs.*
- Parallel processing makes compiler advances. *Meng, Brita, Staff Editor; Digital Design, 03/87, pg 61, 3.5 pgs.*
- Project-management software for PCs helps you map out a plan for your project. *Leibson, Steven H, Regional Editor; EDN, 02/05/87, pg 57, 5 pgs.*
- Computer software, scientific/statistical**
- Transform-based processing: How much precision is needed? *Woods, R E, Perceptics; Digital Design, 02/87, pg 76, 4.5 pgs.*
- Computer software, training**
- Expert systems as engineering tools will broaden productivity/creativity options. *Mosley, J D, Regional Editor; EDN, 11/13/86, pg 91, 5.33 pgs.*
- Computer subsystems/peripherals, other**
- Add-in facsimile boards enable users of PCs to transfer CAE graphics in real time. *Terry, Chris, Associate Editor; EDN, 03/04/87, pg 53, 2.66 pgs.*
- Bridged SCSI controllers remain viable regardless of emerging embedded controllers. *Wright, Maury, Regional Editor; EDN, 02/19/87, pg 69, 5 pgs.*
- Knowing error sources lets you evaluate hard-disk drives. *Robinson, George, FlexStar Corp; EDN, 02/05/87, pg 165, 6 pgs.*
- Computer systems/system design, other**
- A designer's decision: System or device level for peripheral interfaces? *Fifield, Brian, Emulex; Electronic Products, 11/17/86, pg 39, 3.5 pgs.*
- A swarm of RISC chips is chasing a fast-growing systems market. *Barney, Clifford, Staff Editor; Electronics, 03/19/87, pg 66, 1 pg.*
- Open systems free users from hardware constraints. *White, Lisa D, Cadnetix; Computer Design, 03/15/87, pg 73, 5 pgs.*
- Optics and neural nets: trying to model the human brain. *Williams, Tom, Staff Editor; Computer Design, 03/01/87, pg 47, 13 pgs.*
- Parallelism breeds a new class of supercomputers. *Mokhoff, Nicolas, Staff Editor; Computer Design, 03/15/87, pg 53, 10 pgs.*
- RISCs and parallel processors drive multiprocessing innovations. *Mokhoff, Nicolas, Staff Editor; Computer Design, 12/86, pg 55, 7 pgs.*
- The fast way to build a RISC processor. *Ajmera, Dhaval; Kong, Cheng-Gang, Advanced Micro Devices; Electronic Products, 11/17/86, pg 45, 5 pgs.*
- Computer-aided design/engineering (CAD/CAE)**
- Analog simulator models multitechnology systems. *Johnson, Doug, Analogy; Computer Design, 11/15/86, pg 92, 4 pgs.*
- Apple gives new Macintoshes the right stuff for CAE applications. *Gabay, Jon, Contributing Editor; Computer Design, 04/01/87, pg 22, 2 pgs.*
- Artificial-intelligence techniques boost utility of CAE/CAD tools. *Mosley, J D, Regional Editor; EDN, 02/19/87, pg 83, 4.33 pgs.*
- Behavioral models take the pain out of system simulation. *Bloom, Michael, Contributing Editor; Computer Design, 02/15/87, pg 38, 5.5 pgs.*
- Benchmarking PCB design systems. *Barrett, Richard; DeMaria, David, Racal-Redac; Computer Design, 01/01/87, pg 77, 5.5 pgs.*
- CAE support groups boost designer productivity. *Poniatowski, Martin F, Canaan Computers; Computer Design, 04/01/87, pg 37, 2 pgs.*
- CAE takes to mainstream to reach all designers. *Weiss, Ray, Staff Editor; Electronic Design, 02/05/87, pg 62, 7 pgs.*
- Computer-aided engineering. *Milne, Bob, Staff Editor; Electronic Design, 01/08/87, pg 72, 7 pgs.*
- Customizing a gate array, Part 4. *Gabay, Jon, Staff Editor; Electronic Products, 12/15/86, pg 23, 5 pgs.*
- Design tools make advances toward supporting testability. *Goering, Richard, Staff Editor; Computer Design, 03/15/87, pg 23, 5 pgs.*
- Digital simulators encroach on breadboard domain. *Collett, Ronald, Staff Editor; Digital Design, 01/87, pg 64, 5 pgs.*
- EDIF Version 200 takes on production environment. *Waters, Mike, Motorola; Computer Design, 11/15/86, pg 79, 4.5 pgs.*
- EDIF format brings uniformity to CAE/CAD data. *Marx, Esther, et al, Motorola Inc; EDN, 01/22/87, pg 153, 5.5 pgs.*
- EDIF readers/writers handle data transfer between CAE systems. *Marx, Esther, et al, Motorola Inc; EDN, 03/04/87, pg 171, 4.5 pgs.*
- Expert designers evaluate PC-based schematic editors. *Freeman, Eva, Associate Editor; EDN, 12/25/86, pg 82, 4.5 pgs.*
- Hardware modeling: The real stuff's role in system simulation. *Leonard, Milt, Staff Editor; Electronic Products, 04/15/87, pg 37, 4 pgs.*
- Here come the tools to design 50,000-gate ASICs. *McLeod, Jonah, Staff Editor; Electronics, 02/05/87, pg 55, 4 pgs.*
- Hierarchical-level CAE system features snap and simplicity. *Miadejovsky, Michael, Hewlett-Packard Salt Lake Cericor Operation; Electronic Design, 02/19/87, pg 113, 4 pgs.*
- Implementations may blossom for design interface standards. *Goering, Richard, Staff Editor; Computer Design, 02/01/87, pg 24, 4 pgs.*
- Integrated CAE tools ease software design. *Lehto, Steve; Besemer, Jim, Tektronix; Electronic Design, 11/13/86, pg 151, 4 pgs.*
- Keys to the future: CAD and fab. *McLeod, Jonah, Staff Editor; Electronics, 04/02/87, pg 86, 5 pgs.*
- Layout tool streamlines full-custom IC design. *Staff; Electronics, 12/18/86, pg 80, 3 pgs.*
- Layout verification tools add graphical interface. *Cho, Gene; Lanfri, Ann, Mentor Graphics; Computer Design, 01/01/87, pg 87, 5 pgs.*
- Mixed-mode simulators bridge the gap between analog and digital design. *Bloom, Michael, Contributing Editor; Computer Design, 01/15/87, pg 51, 11.5 pgs.*
- Modified simulation files meet tester needs. *Den Beste, William E, Test Systems Strategies; Computer Design, 02/01/87, pg 85, 4 pgs.*
- PC-based CAE/CAD users turn to 32-bit solutions. *Goering, Richard, Staff Editor; Computer Design, 04/15/87, pg 57, 12 pgs.*
- Parameterizable cells strike middle ground between fixed and compiled cells. *Bloom, Michael, Contributing Editor; Computer Design, 11/01/86, pg 24, 5.5 pgs.*
- Pc-board workstation links production to design. *White, Lisa D; LeBrun, Jim, Cadnetix; Electronic Design, 03/19/87, pg 117, 5 pgs.*
- Price and performance improvements drive design tool market. *Goering, Richard, Staff Editor; Computer Design, 12/86, pg 105, 9 pgs.*
- Sony packs power into low-cost work stations. *Staff; Electronics, 03/19/87, pg 79, 3 pgs.*
- Tools bring PC-board design back to the future. *McLeod, Jonah, Staff Editor; Electronics, 02/19/87, pg 67, 4 pgs.*
- Understanding test vectors in CAE. *Laengrich, Norbert, Hi-level Technology; Electronic Products, 03/15/87, pg 47, 5 pgs.*
- Use EDIF to create test vectors and verify your logic. *Marx, Esther, et al, Motorola; EDN, 02/19/87, pg 185, 7 pgs.*
- Use an interchange format to port component libraries. *Waters, Mike, et al, Motorola; EDN, 02/05/87, pg 175, 7 pgs.*

EDN TECHNICAL-ARTICLE DATABASE

Versatile schematic capture set caters to custom-IC designers. *Benedict, J Stanley; Ruotsi, Wendell, CAECO; Electronic Design, 03/05/87, pg 96, 4.5 pgs.*

Workstations leap ahead toward interactive CAE goal. *Lin, Patrick; Laut, Andy, Daisy Systems; Electronic Design, 04/30/87, pg 113, 4 pgs.*

Computer-aided manufacturing/testing (CAM/CAT)
ASIC verification: New tester breed builds design security. *Milne, Bob, Staff Editor; Electronic Design, 04/16/87, pg 71, 7 pgs.*

CIM: The right medicine for electronic manufacturing? *Shapiro, Sydney F, Staff Editor; Computer Design, 11/01/86, pg 73, 12 pgs.*

Can testers catch up with complex chips? *McLeod, Jonah, Staff Editor; Electronics, 01/22/87, pg 49, 4 pgs.*

Impedance matching tweaks advanced CMOS IC testing. *Cox, Gerald C, GenRad; Electronic Design, 04/87, pg 71, 3.5 pgs.*

Conferences/conventions/shows

ADEE West '87 will keep you up to date on chip and system design with CAD/CAE. *Morrow, Joan, Assistant Managing Editor; EDN, 03/04/87, pg 89, 1.66 pgs.*

At IEDM, new ways to boost chip speed and density. *Staff; Electronics, 11/27/86, pg 66, 3 pgs.*

At Nepcon West: Assembly automation the theme. *Chin, Spencer, Staff Editor; Electronic Products, 02/15/87, pg 15, 2 pgs.*

Conference features new application-ready ICs. *Mokhoff, Nicolas, Staff Editor; Computer Design, 04/15/87, pg 37, 2 pgs.*

Custom IC Conference looks like a real winner. *Cole, Bernard C, Staff Editor; Electronics, 04/30/87, pg 45, 1.5 pgs.*

Electro/87. *Ormond, Tom, Senior Editor; EDN, 03/31/87, pg 139, 14.66 pgs.*

Electro/87 and Mini/Micro Northeast programs will examine divergent topics. *Ormond, Tom, Senior Editor; EDN, 03/18/87, pg 95, 3.33 pgs.*

ISSCC '87 will explore IC design in a restructured semiconductor industry. *Shear, David, Regional Editor; EDN, 02/05/87, pg 85, 2.33 pgs.*

ISSCC: Analog. *Goodenough, Frank, Staff Editor; Electronic Design, 03/05/87, pg 71, 4 pgs.*

ISSCC: Digital. *Bursky, Dave, Staff Editor; Electronic Design, 03/05/87, pg 61, 4.5 pgs.*

ISSCC: Special purpose. *Allan, Roger, Staff Editor; Electronic Design, 03/05/87, pg 79, 3 pgs.*

ISSCC—4-Mbit DRAMs and 25-nsec SRAMs mark silicon offerings. *Wilson, David, Editor; Digital Design, 04/87, pg 73, 3 pgs.*

Record-setting CPUs, DRAMs, and SRAMs star at ISSCC. *Cole, Bernard C, Staff Editor; Electronics, 03/05/87, pg 58, 9 pgs.*

Speed gains in RAMs, DSP lead the way at ISSCC '87. *Gold, Martin, Staff Editor; Electronic Design, 11/27/86, pg 26, 1.5 pgs.*

The ISSCC's menu ranges from 4-Mb DRAMs to GaAs memories. *Cole, Bernard Conrad, Staff Editor; Electronics, 11/27/86, pg 83, 2 pgs.*

The RISC-CISC debate plus a new crop of memories and PLDs top the agenda. *Gold, Martin, Staff Editor; Electronic Design, 03/19/87, pg 77, 4 pgs.*

Connectors
Focus on conductive elastomers. *Bernhard, Robert, Electronic Design, 11/20/86, pg 149, 5 pgs.*

Higher pin densities, custom assemblies reshape insulation-displacement. *Bloom, Michael, Electronic Design, 11/13/86, pg 91, 4.5 pgs.*

Simple solution cures glitches on high-speed buses. *DeBock, Richard M, Matrix Corp; EDN, 04/30/87, pg 173, 6.5 pgs.*

Consumer electronics
1987 U.S. market report: Consumer. *Staff; Electronics, 01/08/87, pg 64, 2 pgs.*

Corporate appointments/development/strategies
A new wave rises on the Pacific Rim. *Berger, Michael, Staff Editor; Shapiro, Don, Staff Editor; Electronics, 04/02/87, pg 78, 2 pgs.*

A one-world industry is arriving fast. *Erikson, Arthur, Staff Editor; Electronics, 04/02/87, pg 69, 4 pgs.*

A streamlined AMD fights back, looks for strategic partners. *Barney, Clifford, Staff Editor; Electronics, 03/19/87, pg 64, 2 pgs.*

Convergent hustles to turn around. *Barney, Clifford, Staff Editor; Electronics, 11/13/86, pg 66, 2 pgs.*

Does Catalyst have the key to smart cards? *Staff; Electronics,*

12/18/86, pg 59, 4 pgs.

Europe pushes hard for global role. *Gosch, John, Staff Editor; Electronics, 04/02/87, pg 75, 1.5 pgs.*

Japan drives for strategic alliances. *Cohen, Charles L, Staff Editor; Electronics, 04/02/87, pg 76, 2 pgs.*

LSI Logic's big bag of ASIC design tools. *Staff; Electronics, 02/05/87, pg 59, 3 pgs.*

Recruiting engineers to the South Bronx is a task less difficult than it seems. *Asbrand, Deborah, Staff Editor; EDN, 12/11/86, pg 305, 3 pgs.*

Siemens joins the 1-Mb DRAM club. *Gosch, John, Staff Editor; Electronics, 11/13/86, pg 30, 0.5 pgs.*

The look of the industry in 2000. *Weber, Samuel, Staff Editor; Electronics, 04/02/87, pg 60, 2 pgs.*

Under Thomson's wing, Mostek is beginning to fly. *Lineback, J Robert, Staff Editor; Electronics, 04/16/87, pg 48, 1 pg.*

Winds of change sweep the industry. *Barney, Clifford, Staff Editor; Electronics, 04/02/87, pg 62, 6 pgs.*

Counters

Counter-timers beat the 60-GHz clock and break through 2-ns resolution. *Bloom, Michael, Electronic Design, 11/20/86, pg 78, 6.5 pgs.*

Electronic counters move ahead—slowly. *Yates, Warren, Staff Editor; Electronic Products, 12/01/86, pg 44, 4 pgs.*

Scopes wield counter-timer for automatic measurements. *Baker, Cliff, Tektronix; Electronic Design, 11/13/86, pg 113, 4 pgs.*

Crystals/crystal oscillators
The quickening (beat) of the quartz crystal. *Chin, Spencer, Staff Editor; Electronic Products, 11/03/86, pg 65, 4 pgs.*

Counters
Counter-timers beat the 60-GHz clock and break through 2-ns resolution. *Bloom, Michael, Electronic Design, 11/20/86, pg 78, 6.5 pgs.*

Electronic counters move ahead—slowly. *Yates, Warren, Staff Editor; Electronic Products, 12/01/86, pg 44, 4 pgs.*

Scopes wield counter-timer for automatic measurements. *Baker, Cliff, Tektronix; Electronic Design, 11/13/86, pg 113, 4 pgs.*

Crystals/crystal oscillators
The quickening (beat) of the quartz crystal. *Chin, Spencer, Staff Editor; Electronic Products, 11/03/86, pg 65, 4 pgs.*

Data acquisition/communications, other
1987 U.S. market report: Communications. *Staff; Electronics, 01/08/87, pg 58, 3 pgs.*

Consider standard features when selecting codecs. *Barnes, Brady, Inter-Tel; EDN, 04/30/87, pg 211, 6 pgs.*

Use structured arrays for high-performance data processing. *Chang, Yen, LSI Logic Corp; EDN, 04/15/87, pg 177, 6 pgs.*

Data-acquisition systems/techniques
Board-level systems set the trend in data acquisition. *Shapiro, Sydney F, Staff Editor; Computer Design, 04/01/87, pg 59, 12.5 pgs.*

Data-acquisition system fits on a smart peripheral chip. *Yager, Charles, Micro Linear; Electronic Design, 03/05/87, pg 85, 5 pgs.*

Design steps improve effective resolution of digitizing scopes, waveform digitizers. *Everett, Chris, Regional Editor; EDN, 01/08/87, pg 61, 5.5 pgs.*

Optical encoders are shrinking to satisfy position-sensing application requirements. *Ormond, Tom, Senior Editor; EDN, 11/27/86, pg 81, 4.33 pgs.*

Synchronous VFC enhances accuracy in analog-input systems. *DeVito, Larry, Analog Devices Semiconductor; EDN, 11/13/86, pg 269, 9.5 pgs.*

Tapping the analog world for serial 10-bit data. *Redfern, Thomas P; Rempfer, William, Linear Technology; Electronic Products, 04/01/87, pg 32, 7.5 pgs.*

Data-communications systems/techniques
Analyzers keep pace with communications protocol development. *Mayer, John H, Staff Editor; Computer Design, 03/01/87, pg 81, 3 pgs.*

Availability of cryptographic ICs augurs the increasing use of data encryption. *Terry, Chris, Associate Editor; EDN, 01/22/87, pg 63, 4 pgs.*

ISDN gains ground as needed ICs emerge. *Mokhoff, Nicolas, Staff Editor; Computer Design, 11/15/86, pg 43, 4.5 pgs.*

ISDN terminals simplify data transmissions. *O'Toole, Tony, Advanced Micro Devices; EDN, 01/22/87, pg 167, 8 pgs.*

Serial data races at parallel rates for the best of both worlds. *Connor, Gary, et al, Advanced Micro Devices; Electronic Design, 01/22/87, pg 79, 5 pgs.*

Synchronous-network circuit boosts network flexibility. *Vesuna, Sarosh N, Advanced Micro Devices; EDN, 11/13/86, pg 231, 6 pgs.*

Use statistics to test communications systems efficiently. *Cobb, R F, Harris Corp; EDN, 01/08/87, pg 143, 9 pgs.*

Use structured arrays for high-performance data processing.

EDN TECHNICAL-ARTICLE DATABASE

Chang, Yen, LSI Logic Corp; EDN, 04/15/87, pg 177, 6 pgs.

Data converters

CMOS ADC achieves reliable 12-bit resolution. Reidy, John, Wynne, John, Analog Devices; EDN, 03/04/87, pg 131, 13.5 pgs.

Comparing ADC architectures is a designer's best bet. Koen, Mike, Burr-Brown; Electronic Design, 01/22/87, pg 119, 4 pgs.

Data-acquisition system fits on a smart peripheral chip. Yager, Charles, Micro Linear; Electronic Design, 03/05/87, pg 85, 5 pgs.

Fast A/D converters accelerate the development of sample/hold amplifiers. Fleming, Tarlton, Associate Editor; EDN, 03/31/87, pg 59, 4 pgs.

Fast-settling op amps aid in data conversion. Kitchin, Charles, et al, Analog Devices Semiconductor; EDN, 03/18/87, pg 185, 5.5 pgs.

Hardware methods improve 1-chip A/D converters. Sidman, Steven, Harris; EDN, 02/05/87, pg 139, 13.5 pgs.

Interface options enhance fast video converter. Price, John; Morgan, Dennis, Motorola Semiconductors; Electronic Products, 12/15/86, pg 31, 4 pgs.

New D-A converters boast higher performance and lower cost. Mayer, John H, Staff Editor; Computer Design, 03/15/87, pg 90, 5 pgs.

Resolver-to-digital IC makes move to monolithic. Sylvan, John, Analog Devices; Electronic Design, 02/05/87, pg 84, 6 pgs.

Synchronous VFC enhances accuracy in analog-input systems. DeVito, Larry, Analog Devices Semiconductor; EDN, 11/13/86, pg 269, 9.5 pgs.

Tapping the analog world for serial 10-bit data. Redfern, Thomas P; Rempfer, William, Linear Technology; Electronic Products, 04/01/87, pg 32, 7.5 pgs.

The standouts among fast converter ICs. Spadaro, Joseph J, Staff Editor; Electronic Products, 02/15/87, pg 29, 4 pgs.

Thermal-tracking IC converts rms to dc. Williams, Jim, Linear Technology Corp; EDN, 02/19/87, pg 137, 15 pgs.

Video hybrid digitizes images at RS-170 rates. Hansford, Alan, Analog Devices; Digital Design, 03/87, pg 50, 3 pgs.

Data encryption/decryption/verification

Availability of cryptographic ICs augurs the increasing use of data encryption. Terry, Chris, Associate Editor; EDN, 01/22/87, pg 63, 4 pgs.

Data loggers/recorders

Design steps improve effective resolution of digitizing scopes, waveform digitizers. Everett, Chris, Regional Editor; EDN, 01/08/87, pg 61, 5.5 pgs.

Data processing

1987 U.S. market report: Data processing. Staff; Electronics, 01/08/87, pg 54, 4 pgs.

Add-in facsimile boards enable users of PCs to transfer CAE graphics in real time. Terry, Chris, Associate Editor; EDN, 03/04/87, pg 53, 2.66 pgs.

Fast-settling op amps aid in data conversion. Kitchin, Charles, et al, Analog Devices Semiconductor; EDN, 03/18/87, pg 185, 5.5 pgs.

Design services

Parameterizable cells strike middle ground between fixed and compiled cells. Bloom, Michael, Contributing Editor; Computer Design, 11/01/86, pg 24, 5.5 pgs.

Development systems

In-circuit emulators crowd eagerly onto the PC platform. Leonard, Milt, Staff Editor; Electronic Products, 02/01/87, pg 19, 4 pgs.

μ P simulators let you debug software on an IBM PC. Wright, Maury, Regional Editor; EDN, 12/11/86, pg 196, 6.5 pgs.

Digital multimeters (DMMs)

Hand-held DMMs exploit custom CMOS ICs to boost accuracy and add features. Costlow, Terry, Staff Editor; Electronic Design, 11/27/86, pg 75, 5 pgs.

Digital signal processing

AT&T packs performance into its one-chip DSP. Staff; Electronics, 02/19/87, pg 74, 2 pgs.

CMOS DSP chip packs punch of a supercomputer. Simar, Jr, Ray; Hames, Mike, Texas Instruments; Electronic Design, 03/19/87, pg 103, 5.5 pgs.

DSP: A technology in search of applications. Marrin, Ken, Staff Editor; Computer Design, 11/15/86, pg 59, 14 pgs.

The multiple choices in DSP chips. Myrvagnes, Rodney, Staff Editor; Electronic Products, 04/15/87, pg 60, 8.5 pgs.

The star of single-chip digital signal processing is rising. Bader, Maryann L, Bader Associates; Electronic Products, 01/15/87, pg 41, 2 pgs.

Digitizers

ASIC-verification systems speed prototype testing, but system capabilities vary. Everett, Chris, Regional Editor; EDN, 11/27/86, pg 51, 8 pgs.

Digitizing instruments: Making a fair comparison. Manieri, Lawrence J, Sequence; Electronic Design, 11/20/86, pg 121, 3.5 pgs.

Digitizing scopes sweep away complex measuring problems. White, David, Tektronix; Electronic Design, 11/27/86, pg 111, 5 pgs.

Discrete components, other

1987 U.S. market report: Components. Staff; Electronics, 01/08/87, pg 72, 3 pgs.

Disk controllers

Bridged SCSI controllers remain viable regardless of emerging embedded controllers. Wright, Maury, Regional Editor; EDN, 02/19/87, pg 69, 5 pgs.

Compiler allows Ada development on an IBM PC/AT. Tetewsky, Avram, et al, Charles Stark Draper Laboratory Inc; EDN, 02/19/87, pg 157, 7.5 pgs.

Modular architectures break I/O bottleneck. Venkatesh, G (Ven), Adaptec; Digital Design, 12/86, pg 56, 3 pgs.

Disk encoders

Constant-density recording comes alive with new chips. Young, Mark S, Advanced Micro Devices; Electronic Design, 11/13/86, pg 141, 4 pgs.

Displays

Display modules span existing technologies, suit diverse uses. Fleming, Tarlton, Associate Editor; EDN, 12/25/86, pg 124, 6 pgs.

LCDs lead the assault on CRT's dominance. Williams, Tom, Staff Editor; Computer Design, 11/01/86, pg 53, 5 pgs.

Next-generation LCDs abound with options. Confrey, Jack, Epson America; Electronic Products, 11/03/86, pg 85, 3 pgs.

E

Employment/labor relations/personnel/recruitment

Former engineers parlay technical expertise into new careers. Asbrand, Deborah, Staff Editor; EDN, 12/25/86, pg 169, 3.5 pgs.

"Information revolution" may not make jobs. Patton, Carole, Staff Editor; Electronic Design, 02/05/87, pg 16, 0.5 pgs.

Laid-off engineers find the experience painful but survivable. Asbrand, Deborah, Associate Editor; EDN, 01/22/87, pg 303, 4 pgs.

Recruiting engineers to the South Bronx is a task less difficult than it seems. Asbrand, Deborah, Staff Editor; EDN, 12/11/86, pg 305, 3 pgs.

Engineering workstations

A work station that runs Unix and MS-DOS side by side. Staff; Electronics, 11/13/86, pg 63, 3 pgs.

CAE takes to mainstream to reach all designers. Weiss, Ray, Staff Editor; Electronic Design, 02/05/87, pg 62, 7 pgs.

General-purpose machines and PCs emerge as AI platforms. Hindin, Harvey J, Staff Editor; Computer Design, 11/01/86, pg 43, 6 pgs.

Hierarchical-level CAE system features snap and simplicity. Miadejovsky, Michael, Hewlett-Packard Salt Lake Cericon Operation; Electronic Design, 02/19/87, pg 113, 4 pgs.

Pc-board workstation links production to design. White, Lisa D; LeBrun, Jim, Cadnetix; Electronic Design, 03/19/87, pg 117, 5 pgs.

Processor board recasts PC into 5-MIPS Unix workstation. Lundell, Jon, et al, Opus Systems; Electronic Design, 03/05/87, pg 119, 4.5 pgs.

Sony packs power into low-cost work stations. Staff; Electronics, 03/19/87, pg 79, 3 pgs.

Workstations leap ahead toward interactive CAE goal. Lin, Patrick; Laut, Andy, Daisy Systems; Electronic Design, 04/30/87, pg 113, 4 pgs.

Ergonomics/product design

Behavioral models and hardware modelers simulate pc boards containing VLSI devices. Freeman, Eva, Associate Editor; EDN, 11/13/86, pg 65, 5.33 pgs.

EDN TECHNICAL-ARTICLE DATABASE

F

Fiber optics

- Fiber-optic testers determine faults in short-haul networks. *Conner, Margery S, Regional Editor; EDN, 12/25/86, pg 98, 6 pgs.*
- Influence of fiberoptic Ethernet LANs expands. *Mokhoff, Nicolas, Staff Editor; Computer Design, 01/15/87, pg 41, 3 pgs.*
- Next step for fiber optics: The local loop. *Rosenberg, Robert, Staff Editor; Electronics, 11/27/86, pg 61, 4 pgs.*

Flexible circuits

- Focus on conductive elastomers. *Bernhard, Robert, Electronic Design, 11/20/86, pg 149, 5 pgs.*

Floppy-disk drives

- Intelligent peripheral interface standard permits data-transfer rates of 10M bytes/sec. *Wright, Maury, Regional Editor; EDN, 01/08/87, pg 105, 6 pgs.*
- Knowing error sources lets you evaluate hard-disk drives. *Robinson, George, FlexStar Corp; EDN, 02/05/87, pg 165, 6 pgs.*
- Run-length-limited coding increases disk-drive capacity. *Cloke, Bob, Priam Corp; EDN, 03/31/87, pg 199, 4 pgs.*

Frequency synthesizers/synthesis/measurement

- ASIC-verification systems speed prototype testing, but system capabilities vary. *Everett, Chris, Regional Editor; EDN, 11/27/86, pg 51, 8 pgs.*

Fuses

- Fuses and circuit breakers stay in season. *Chin, Spencer, Staff Editor; Electronic Products, 12/15/86, pg 41, 4 pgs.*

G

GaAs technology

- Digital GaAs ICs make their move. *Tunick, Diane, Staff Editor; Electronic Design, 04/16/87, pg 35, 2 pgs.*
- GaAs ICs add gain block to rf designer's arsenal. *Schappacher, Jerry, Harris Microwave Semiconductor; Electronic Design, 03/05/87, pg 109, 2.5 pgs.*
- GaAs VLSI progresses toward commercial viability. *Bond, John, Contributing Editor; Computer Design, 01/15/87, pg 31, 4 pgs.*
- GaAs bit-slice processors blaze past silicon equivalents. *Aseo, Joseph, Staff Editor; Digital Design, 12/86, pg 22, 1 pg.*
- GaAs chips strive to mirror silicon functions. *Spadaro, Joseph J, Staff Editor; Electronic Products, 01/01/87, pg 41, 4 pgs.*
- GaAs wedges deeper into digital LSI market. *Leonard, Milt, Staff Editor; Electronic Products, 04/15/87, pg 15, 2 pgs.*
- Hughes breaks speed record for digital gallium arsenide. *Waller, Larry, Staff Editor; Electronics, 12/18/86, pg 31, 1 pg.*
- Military electronics. *Allan, Roger, Staff Editor; Electronic Design, 01/22/87, pg 62, 8 pgs.*
- The first GaAs compiler is already producing chips. *McLeod, Jonah, Staff Editor; Electronics, 04/30/87, pg 53, 3 pgs.*
- Wideband GaAs op amps push onto silicon's turf. *Staff; Electronics, 11/27/86, pg 77, 1 pg.*

Gate arrays

- Customizing a gate array, Part 4. *Gabay, Jon, Staff Editor; Electronic Products, 12/15/86, pg 23, 5 pgs.*

Government

- U.S. Inc.: IC makers still debate role of production consortium. *Barney, Clifford, Staff Editor; Electronics, 03/05/87, pg 31, 1 pg.*
- West Germany grabs the lead in X-ray lithography. *Gosch, John, Staff Editor; Electronics, 02/05/87, pg 78, 3 pgs.*
- Will Sematech fly? The next three months will tell. *Barney, Clifford, Staff Editor, et al; Electronics, 03/19/87, pg 31, 1.5 pgs.*

Graphics boards

- A versatile architecture for imaging. *Casey, Patrick, Imaging Technology; Digital Design, 02/87, pg 81, 3.5 pgs.*
- Convolution hardware accelerates imaging tasks. *MacRae, David, Matrox Electronic Systems; Digital Design, 01/87, pg 58, 3.5 pgs.*
- Graphics chips, boards bring CAD to personal computers. *Gold, Martin, Staff Editor; Electronic Design, 02/19/87, pg 67, 5 pgs.*

- Imaging boards put algorithms in hardware to up throughput. *Weir, Tony, Vision Systems; Digital Design, 03/87, pg 55, 3 pgs.*

- PC AT graphics must link performance and compatibility. *Williams, Tom, Staff Editor; Computer Design, 02/01/87, pg 30, 2.5 pgs.*

- Squeeze your image on the PC. *Silver, David, KoFax Image Products; Digital Design, 02/87, pg 66, 3 pgs.*

Graphics circuits

- A moment in the sun for TI's 34010 graphics processor. *Cole, Vera Jean, Staff Editor; Electronic Products, 03/15/87, pg 19, 2 pgs.*
- Chip set brings bit mapping to low-end CRT displays. *MacKenna, Craig, et al, Signetics; Electronic Design, 01/22/87, pg 88, 4 pgs.*
- Graphic chips help display fonts without a bit map. *Strupat, Achim, Advanced Micro Devices; Electronic Design, 11/20/86, pg 141, 5 pgs.*
- Graphics and DSP ICs speed PC imaging. *Chauvin, J W, et al, University of Washington; Digital Design, 01/87, pg 49, 2.5 pgs.*
- Graphics engines. *Conner, Margery, Regional Editor; EDN, 03/04/87, pg 112, 9 pgs.*

Graphics systems

- A million pixels and up launched on IBM PCs. *Chester, Michael, Staff Editor; Electronic Products, 01/01/87, pg 14, 2.5 pgs.*
- Bringing solids modeling to the PC. *Leszkowicz, Irene, Matrox Electronic Systems; Digital Design, 04/87, pg 57, 3 pgs.*
- Color graphics homes in on bus computers. *Lieberman, David, Staff Editor; Electronic Products, 01/01/87, pg 47, 6 pgs.*
- DEC graphics—Board vendors provide low-cost alternatives. *Wilson, Andrew C, Staff Editor; Digital Design, 01/87, pg 35, 2 pgs.*
- General-purpose machines and PCs emerge as AI platforms. *Hindin, Harvey J, Staff Editor; Computer Design, 11/01/86, pg 43, 6 pgs.*
- Graphics chips, boards bring CAD to personal computers. *Gold, Martin, Staff Editor; Electronic Design, 02/19/87, pg 67, 5 pgs.*
- Graphics developments geared toward speed and capacity. *Williams, Tom, Staff Editor; Computer Design, 12/86, pg 127, 8 pgs.*
- LCDs lead the assault on CRT's dominance. *Williams, Tom, Staff Editor; Computer Design, 11/01/86, pg 53, 5 pgs.*
- Optimize your graphics system for 2-D and 3-D. *Khurana, Anoop S, et al, Advanced Micro Devices Inc; EDN, 03/18/87, pg 161, 12.5 pgs.*
- PC graphics hardware dictates standards at high end. *Wilson, Andrew C, Staff Editor; Digital Design, 02/87, pg 37, 4 pgs.*
- Subsystem breaks through high-end image-processing barriers. *Shapiro, Sydney F, Staff Editor; Computer Design, 02/15/87, pg 56, 2.5 pgs.*

H

Hardware/interconnection, other

- Power planes increase wire-wrapped circuit speeds. *Visco, P Anthony, Mupac Corp; EDN, 11/27/86, pg 225, 3 pgs.*

Heat sinks/cooling devices

- Heat-removal devices hold semiconductors within operating ranges. *Travis, Bill, Senior Editor; EDN, 12/11/86, pg 77, 6 pgs.*

Hybrid circuits

- Hybrid isolation amps zap price and voltage barriers. *Smith, Greg, Burr-Brown; Electronic Design, 12/11/86, pg 91, 4.5 pgs.*

I

Imports/exports

- Overseas market report: Another tough year. *Staff; Electronics, 01/22/87, pg 65, 23 pgs.*
- U.S. chip makers press for dumping sanctions. *Berger, Michael, Staff Editor; Gomez, Iris, Electronics, 11/27/86, pg 30, 0.5 pgs.*

Text continued on pg 197
EDN August 6, 1987

INTRODUCING FUJITSU'S
NEW 8" DISK DRIVE.

Our best performance numbers yet.

Our new 8" Winchester offers an improved access time of 16ms. 690MB of storage. And 35,000 hours MTBF.

Three of the best numbers in the business. That's quality. That's reliability. That's the performance you should demand. And we're delivering production quantities.

It's SCSI compatible, too. Because our Intelligent Disk Controller provides single-ended or differential drivers and Common Command Set support for easy integration.

What's more, our new 8" disk drive has a dual-supported spindle that improves thermal off-track performance. And greatly increases shock tolerance.

So call for more information. On this or any of our famous family of data storage products,

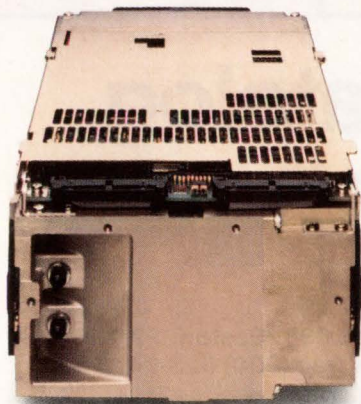

| Model | M2322K | M2333P | M2333K | M2344K |
|---------------|------------|-----------|-----------|-----------|
| Capacity | 168 MB | 377 MB | 337 MB | 690 MB |
| Access Time | 20 ms | 20 ms | 20 ms | 16 ms |
| Transfer Rate | 1.229 MB/s | 2.46 MB/s | 2.46 MB/s | 2.46 MB/s |
| Interface | SMD | IPI-2 | HSMD/SCSI | HSMD/SCSI |

including Winchester, tape, optical and flexible drives. 408-432-1300.

Or write Fujitsu America, Computer Products Group, 3055 Orchard Drive, San Jose, CA 95134-2017.

You'll find we have all the right numbers.

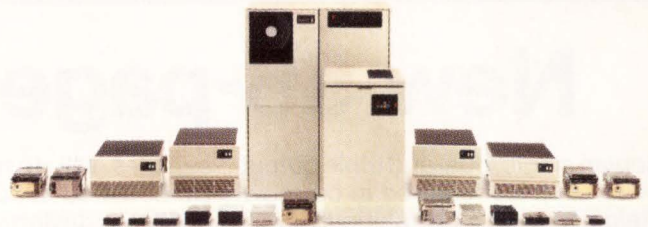

A COMPANY WITH CHARACTER AND DRIVE



FUJITSU AMERICA
Computer Products Group



Series A and B Regulated



Rack Mounting



DC-DC Converters



Plug-In

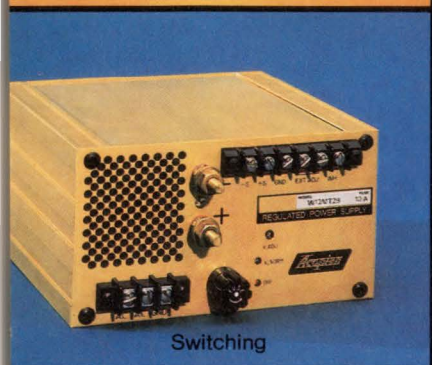

Switching



Miniaturized



Redundant Output Systems

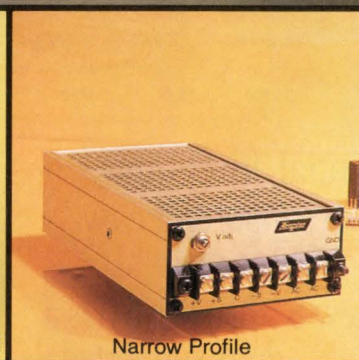

Narrow Profile

New 56-page 1987 catalog

Acopian single, dual and triple output power supplies featured in our new catalog for 1987 are shipped in three days. Included are PC-board-mounting and chassis-mounting mini modules. DC-DC converters. General-purpose modular supplies with outputs to 200 Vdc and current ratings to 32A. Narrow-profile supplies a mere 1.68" thin. Plug-in

supplies. MIL-tested supplies. Unregulated supplies for economically driving relays and displays. Voltage programmable supplies. Our rack-mounting power supplies and systems, and redundant output systems are shipped in nine days. The catalog contains complete specs and pricing information. Call or write for your copy.



P.O. Box 638, Easton, PA 18044
Call toll free (800) 523-9478

P.O. Box 2109, Melbourne, FL 32902
Call toll free (800) 327-6817

DC POWER SUPPLIES SHIPPED IN 3 DAYS

SAMSUNG Speaks

A NEWSLETTER FROM SAMSUNG SEMICONDUCTOR

VOLUME ONE, NUMBER TWO

Included in this issue:
 ► POWER MOSFETs ► DRAMs
 ► EEPROMs ► SRAMs ► SOT-23s
 ► AHCT/HCTLs CMOS LOGIC ► LINEAR ICs

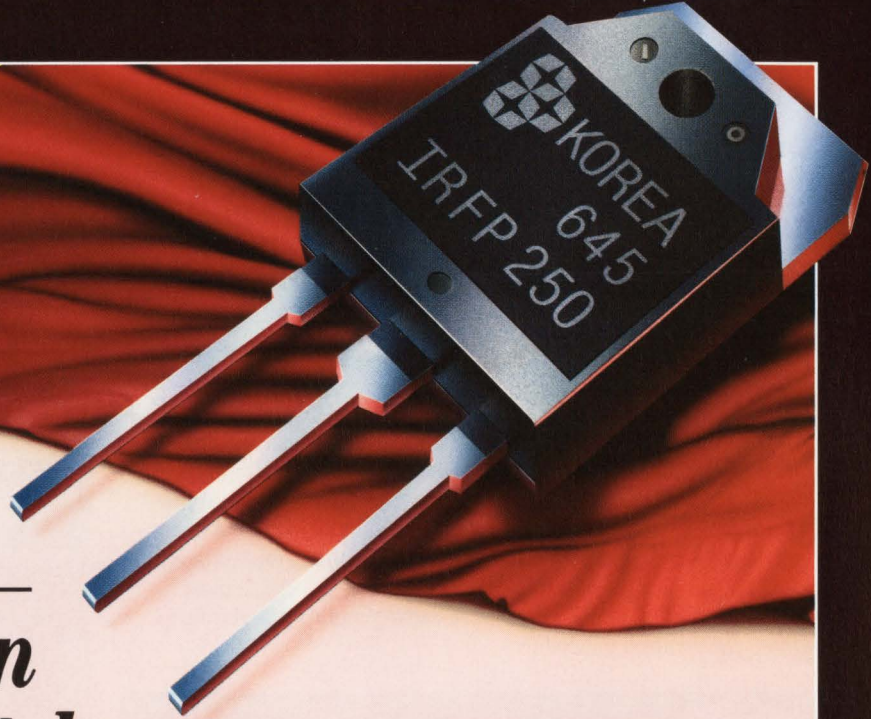

DIRECT REPLACEMENT POWER MOSFETS

The competition has met its match.

Introducing direct replacement for IR and Motorola® MOSFETs. Samsung MOSFETs. The fastest, most rugged, most reliable MOSFETs in the industry. (2230 mJ at 500 v.)

We have the broadest product line of any supplier—over 300 part types in both P- and N-channels are available for immediate delivery, ranging from 60v. to 700v. In TO-3P, TO-220, TO-3 and TO-92L packages.

We are the first and only supplier to use bulk CMOS processing that delivers smaller

die, higher yield, and lower cost. The entire family is supported by our technological partner, IXYS.

*Samsung delivers
higher performance,
at lower price.*

So call your local Samsung sales office today. Ask for samples, a reliability

report, or our new data book. Now you can replace IR and Motorola MOSFETs with something better. Samsung MOSFETs. ■

P & N Channel Part Types Available NOW

| | | | | | | | | | | | | | | | | | |
|------------------|----------|----------|---------|---------|------------------|---------------|---------|--------|--------|------------------|---------|------------------|----------|--------|--------|------------------|------------------|
| N-Channel | SSH20N50 | IRFP152 | IRFP322 | IRFP423 | IRFP9140 | SSP4N60 | IRF541 | IRF710 | IRF823 | IRF9530 | IRF9633 | SSM6N55 | IRF150 | IRF253 | IRF422 | IRF9132 | |
| | SSH4N50 | IRFP153 | IRFP323 | IRFP430 | IRFP9141 | SSP2N60 | IRF542 | IRF711 | IRF830 | IRF9531 | IRF9640 | SSM4N55 | IRF151 | IRF320 | IRF423 | IRF9133 | |
| TO-3P | SSH10N70 | SSH20N45 | IRFP230 | IRFP330 | IRFP431 | IRFP9142 | SSP6N55 | IRF543 | IRF712 | IRF831 | IRF9532 | IRF9641 | SSM20N50 | IRF152 | IRF321 | IRF430 | IRF9140 |
| | SSH6N70 | SSH25N40 | IRFP231 | IRFP331 | IRFP432 | IRFP9143 | SSP4N55 | IRF610 | IRF713 | IRF832 | IRF9533 | IRF9642 | SSM4N50 | IRF153 | IRF322 | IRF431 | IRF9141 |
| | SSH4N70 | SSH25N35 | IRFP232 | IRFP332 | IRFP441 | IRFP9230 | SSP2N55 | IRF611 | IRF720 | IRF833 | IRF9540 | IRF9643 | SSM20N45 | IRF220 | IRF323 | IRF432 | IRF9142 |
| | SSH3N70 | SSH15N10 | IRFP233 | IRFP333 | IRFP441 | IRFP9231 | SSP4N50 | IRF612 | IRF721 | IRF840 | IRF9541 | N-Channel | SSM25N40 | IRF221 | IRF330 | IRF433 | IRF9143 |
| | SSH15N60 | IRFP130 | IRFP240 | IRFP340 | IRFP442 | IRFP9232 | IRF510 | IRF613 | IRF722 | IRF841 | IRF9542 | TO-3 | SSM25N35 | IRF222 | IRF331 | IRF440 | IRF9230 |
| | SSH10N60 | IRFP131 | IRFP241 | IRFP341 | IRFP443 | IRFP9233 | IRF511 | IRF620 | IRF723 | IRF842 | IRF9543 | SSM10N70 | IRF120 | IRF223 | IRF332 | IRF441 | IRF9231 |
| | SSH8N60 | IRFP132 | IRFP242 | IRFP342 | IRFP444 | IRFP9240 | IRF512 | IRF621 | IRF730 | IRF843 | IRF9544 | SSM6N70 | IRF121 | IRF230 | IRF333 | IRF442 | IRF9232 |
| | SSH6N60 | IRFP133 | IRFP243 | IRFP343 | IRFP450 | IRFP9241 | IRF513 | IRF622 | IRF731 | P-Channel | IRF9545 | SSM4N70 | IRF122 | IRF231 | IRF340 | IRF443 | IRF9233 |
| | SSH4N60 | IRFP140 | IRFP250 | IRFP350 | IRFP451 | IRFP9242 | IRF520 | IRF623 | IRF732 | TO-220 | IRF9612 | SSM3N70 | IRF123 | IRF232 | IRF341 | IRF450 | IRF9240 |
| | SSH15N55 | IRFP141 | IRFP251 | IRFP351 | IRFP452 | IRFP9243 | IRF521 | IRF630 | IRF733 | IRF9510 | IRF9613 | SSM15N60 | IRF130 | IRF233 | IRF342 | IRF451 | IRF9241 |
| | SSH10N55 | IRFP142 | IRFP252 | IRFP352 | IRFP453 | IRFP9244 | IRF522 | IRF631 | IRF740 | IRF9511 | IRF9620 | SSM10N60 | IRF131 | IRF240 | IRF343 | IRF452 | IRF9242 |
| | SSH8N55 | IRFP143 | IRFP253 | IRFP353 | N-Channel | TO-220 | IRF523 | IRF632 | IRF741 | IRF9512 | IRF9621 | SSM8N60 | IRF132 | IRF241 | IRF350 | IRF453 | IRF9243 |
| | SSH6N55 | IRFP150 | IRFP320 | IRFP420 | TO-3P | SSP6N70 | IRF530 | IRF633 | IRF742 | IRF9513 | IRF9622 | SSM6N60 | IRF133 | IRF242 | IRF351 | P-Channel | N-Channel |
| | SSH4N55 | IRFP151 | IRFP321 | IRFP421 | | SSP4N70 | IRF531 | IRF640 | IRF743 | IRF9520 | IRF9623 | SSM4N60 | IRF140 | IRF243 | IRF352 | TO-3 | TO-92L |
| | | | | IRFP422 | | SSP2N70 | IRF533 | IRF642 | IRF821 | IRF9521 | IRF9630 | SSM15N55 | IRF141 | IRF250 | IRF353 | IRF9130 | IRFL120 |
| | | | | IRFP423 | | SSP6N60 | IRF540 | IRF643 | IRF822 | IRF9522 | IRF9631 | SSM10N55 | IRF142 | IRF251 | IRF420 | IRF9131 | IRFL123 |
| | | | | IRFP424 | | IRFP9133 | | | | IRF9523 | IRF9632 | SSM8N55 | IRF143 | IRF252 | IRF421 | | |

Motorola is a registered trademark of Motorola, Inc.

© 1987 Samsung Semiconductor

Nobody is moving faster in memory technology development than Samsung.

Samsung now offers an extensive line of memories: DRAMs, EEPROMs and SRAMs. We are among the industry leaders, producing high quality, highly reliable memory products. Our industry-standard pin-for-pin compatible memories are all proprietary products of our own design, developed in our state-of-the-art R&D facility, utilizing our own technology and processing.

We are determined to be your long term memory supplier. Our production facilities are internationally recognized as being among the most advanced in the world. Samsung is one of the few semiconductor companies fabricating 6-inch wafers in produc-

tion quantities. This advanced processing technology allows us to keep costs down and volume up.

Samsung's commitment to winning the memory game is underscored by the \$600 million we're investing in memory product development and by our new 80,000 square foot headquarters in San Jose, staffed by our 160 person R&D team. This R&D facility has the ultimate in Class-1 clean room technology. A unique vertical laminar flow process helps us control every aspect of the fab environment to achieve the industry's most exacting quality standards. ■

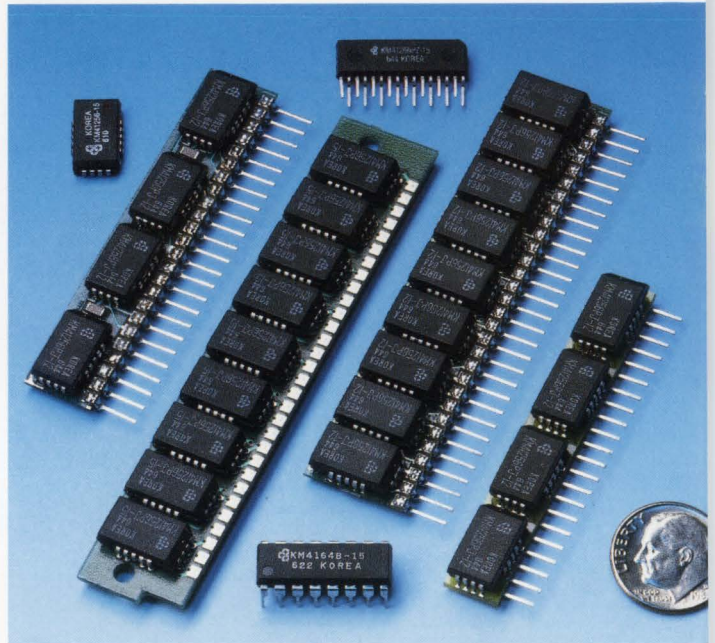

DRAMs

You can see how fast our DRAM technology is progressing in the graphs on the right.

Our 64K and 256K DRAMs are all available in production quantities now. You will be able to get engineering samples of our 1MB DRAM this quarter, qualification samples will be available in mid 1987 with production ramp starting in the third quarter.

Samsung now offers every major DRAM part type.

We're not stopping at 1-million bits. Our 4MB DRAM development program is right on track. Engineering samples will be available early next year.

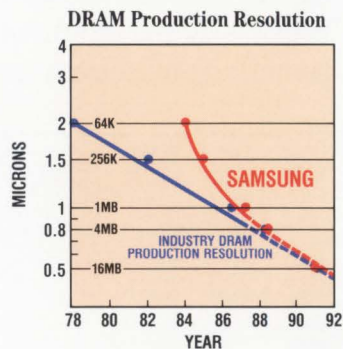
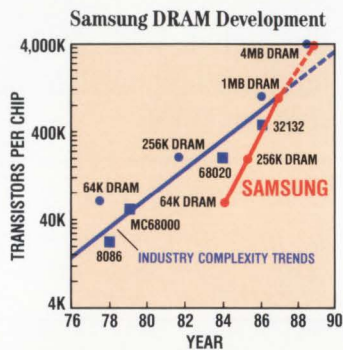

Samsung DRAMs are available in the most effective size, speed and organization combinations. Scan the chart below to find the right DRAMs for your applications.

You can see from the picture that we package our DRAMs the way you want them: DIP, PLCC, SIP/SIMM and ZIP.* If you're looking for state-of-the-art, check out our 256 x 8 (or x 9) SIP and

SIMM memory modules.

We have the technology, we have an aggressive memory development program in place and we have the memory products to meet your requirements, available now. Samsung is committed to being your memory supplier. Call your nearest Samsung sales office for samples and data sheets, today. ■

*Q3 CIRCLE NO. 166

DRAMs

| | 64K | 256K | 256K | 1 Mb | 1 Mb |
|--------------|----------------|---------------------------|---------------------------|----------------------------|-----------------------|
| Density | 64K | 256K | 256K | 1 Mb | 1 Mb |
| Organization | 64Kx1 | 256Kx1 | 64Kx4 | 1Mx1 | 256Kx4 |
| Availability | Now | Now | Now | Q3'87 | Q3'87 |
| Technology | NMOS | NMOS | NMOS | CMOS | CMOS |
| Package | DIP | DIP, PLCC, SIP/SIMM, ZIP* | DIP, PLCC, SIP/SIMM, ZIP* | SOJ, SIP/SIMM, ZIP | SOJ, SIP/SIMM, ZIP |
| Speed | 150 ns, 200 ns | 120 ns, 150 ns | 120 ns, 150 ns | 80 ns, 100 ns, 120 ns | 80 ns, 100 ns, 120 ns |
| Mode | Page | Page, Nibble | Page | Static Column Page, Nibble | Page |

*Q3 '87

EEPROMs

Samsung 16K and 64K EEPROMs meet or exceed industry standards. Endurance is rated at 10,000 erase/write cycles. Data retention ratings are 10 years for our entire line. Moreover, our

When it comes to EEPROMs, we deliver.

pin-out permits you to upgrade EEPROMs without re-designing your entire PCB. Most importantly, our EEPROMs are

immediately available.

We offer industrial temperature operating range (-40° to $+85^{\circ}\text{C}$) and high performance 64K KM2864AH and KM2865AH EEPROMs. They feature write cycle times that are five times faster than standard parts.

Samsung is known for reliability, quality and performance. And nobody beats our EEPROM prices. See for yourself. Call your Samsung sales office to get our EEPROM reliability report, data sheets or samples. ■

CIRCLE NO. 167

EEPROMs

| Density | 16K | 16K | 64K | 64K | 64K | 64K |
|---------------------|---------------------------|---------------------------|---------------------------|---------------------------|---------------------------|---------------------------|
| Part Number | KM2816A | KM2817A | KM2864A | KM2864AH | KM2865A | KM2865AH |
| Availability | Now | Now | Now | Now | Now | Now |
| Package | 24 Pin Plastic DIP | 28 Pin Plastic DIP | 28 Pin Plastic DIP | 28 Pin Plastic DIP | 28 Pin Plastic DIP | 28 Pin Plastic DIP |
| Speed | 250 ns, 300 ns, 350 ns | 250 ns, 300 ns, 350 ns | 200 ns, 250 ns, 300 ns | 200 ns, 250 ns, 300 ns | 200 ns, 250 ns, 300 ns | 200 ns, 250 ns, 300 ns |
| Endurance | 10,000 Erase/Write Cycles | 10,000 Erase/Write Cycles | 10,000 Erase/Write Cycles | 10,000 Erase/Write Cycles | 10,000 Erase/Write Cycles | 10,000 Erase/Write Cycles |
| End of Write Scheme | | RDY/BSY | Data Polling | Data Polling | RDY/BSY, Data Polling | RDY/BSY, Data Polling |
| Byte Write Time | 10 ms write/byte | 10 ms write/byte | 10 ms write/byte | 2 ms write/byte | 10 ms write/byte | 2 ms write/byte |

SRAMs

Samsung is making the same commitment to SRAMs that we make to all our memory products. Samsung is increasing Static RAM production rather than cutting back the way some other manufacturers are. And we are expanding our SRAM line as

we develop the next generation 256K and fast 64K CMOS Static RAMs. Check our offerings in the chart below. Then call your Samsung sales office for samples and data sheets. Make Samsung your quality SRAM supplier. ■

CIRCLE NO. 168

SRAMs

| Density | 64K | 64K | 64K | 64K |
|-----------------|------------|------------|------------------------|------------------------|
| Part Number | KM6264-12 | KM6264-15 | KM6264L-12 | KM6264L-15 |
| Organization | 8Kx8 | 8Kx8 | 8Kx8 | 8Kx8 |
| Availability | Q4 | Now | Q4 | Now |
| Technology | MIX-MOS | MIX-MOS | MIX-MOS | MIX-MOS |
| Package | 28 Pin DIP | 28 Pin DIP | 28 Pin DIP | 28 Pin DIP |
| Speed | 120 ns | 150 ns | 120 ns | 150 ns |
| Standby Current | 1mA Max. | 1mA Max. | 100 μA Max. | 100 μA Max. |

Samsung's 54/74 AHCT and 54/74 HCTLS CMOS Logic gives you the most comprehensive selection of LS, ALS and FAST™ replacements. 61 parts now—86 more in Q3.

Replace LS, ALS and FAST with AHCT and HCTLS CMOS logic parts from Samsung—right now. Look at the advantages we can offer you. And at prices comparable to bipolar!

Comparison of Key Parameters for a 244 Octal Buffer

| | 74AHCT | 74HCTLS | 74ALS | 74LS | 74ACT* |
|---|--------|---------|-------|-------|--------|
| Max Propagation Delay ($C_i = 50\text{pF}$) | 10ns | 18ns | 10ns | 18ns | 13.5ns |
| Drive Current, I_{OL} | 24mA | 24mA | 24mA | 24mA | 24mA |
| Power Dissipation (at 100KHz) | 0.6mW | 0.6mW | 70mW | 120mW | 1mW |

*Fairchild FACT™

You get low power, wide operating supply and temperature ranges, superior noise immunity, rail-to-rail output voltage swings and the low input currents of CMOS, combined with the high speed and drive capability of bipolar.

Unlike older performance-limited HC and HCT logic families, Samsung's high performance CMOS logic matches bipolar speed and drive. 24 mA is guaranteed. Moreover, our CMOS logic allows you to interface directly with all types of TTL, NMOS and CMOS circuitry.

Compare the power dissipation of Samsung's AHCT/HCTLS logic to bipolar LS/ALS/FAST. Our logic consumes 100,000 times less power at low frequencies and 10 times less power at 10 MHz. CMOS voltage swings

also give you up to three times the noise immunity.

Ask us and we'll send you two free samples each of up to five part types.

Just call your local

Samsung sales office and specify AHCT or HCTLS with your part number. Use this list to order your samples and to see what's

Order your free samples today.

coming later this year. Take advantage of Samsung's cool running, highly reliable, high performance CMOS logic.

(continued on next page)

CIRCLE NO. 169

FAST is a trademark of Fairchild Semiconductor Corp.

For product information call your local Samsung sales office.

SAMSUNG SAYS SO.

Flash Converter features independent 8-bit A to D and 10-bit D to A functions on a single chip.

The new KSV3100A flash converter is the latest and most impressive addition to Samsung's extensive line of linear products. The monolithic KSV3100A provides independent 8-bit flash A/D converter and 10-bit R-2R D/A converter functions over an operating range of DC to 38.5 MHz.

The single-chip architecture of the KSV3100A allows you to design-in with a single board rather than many. This saves real estate and gives you room to add more features to your system. Using fewer parts also raises the reliability of your system.

Samsung has designed a number of useful features into our new flash converter. You can choose between selectable peak level or keyed clamping. And the device's absolute non-linearity is rated at 1 per cent.

We also provide you with the support chips you need. Our KA2606 Sync Separate IC,

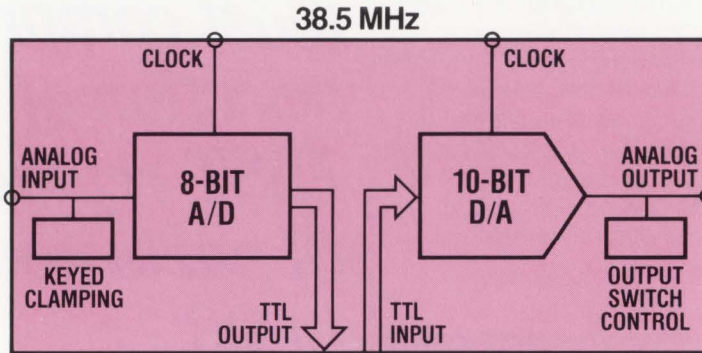

KA2153 Chrominance Signal Processor for NTSC systems, and KA2154 Video Chroma Deflection System for NTSC and PAL systems make it easy to integrate the KSV3100A into your video applications.

Samsung's flash converter prices are unbeatable. The chart shows our 100 piece KSV3100A Flash Converter prices:

| | | | |
|-----------------|---------|----------------|---------|
| KSV3100 AN - 10 | \$48.90 | KSV3100 AN - 8 | \$24.45 |
| KSV3100 AN - 9 | \$32.60 | KSV3100 AN - 7 | \$14.67 |

CIRCLE NO. 170

CMOS LOGIC (Continued)

KS/74AHCT & KS/74HCTLS Part Types

| Gates & Inverters | Flip-Flops | Transceivers/Registered Transceivers | Multiplexers |
|-------------------|-----------------|--------------------------------------|---------------------|
| 00 14* | 73* | 399* | 151* |
| 01 20* | 74 534 | 242* | 643 652* |
| 02 21* | 76* 564 | 243* | 645 658* |
| 03 22* | 78* 574 | 245 646 | 659* |
| 04 27* | 107 670* | 640 648 | 664* |
| 05 32 | 109 794* | 651* | 665* |
| 08 51* | 112 821* | | |
| 09 58* | 173* 822* | | |
| 10 86 | 174 823* | | |
| 11 132* | 175 824* | | |
| 12 133* | 273 825* | | |
| | 266 374 826* | | |
| | 377* | | |
| Counters | Shift Registers | Decoders/Encoders | Arithmetic Circuits |
| 160 169* | 164 299* | 42* 148* | 280* |
| 161 191* | 165* | 138 154* | 680* |
| 162 193* | 166 596* | 139 155* | 682* |
| 163 390* | 194* | | 684* |
| 168* | 195* | | 520* |
| 393 | | | 521* |
| | | | 688* |
| | | | 522* |
| | | | 689* |
| | | | 679* |

*Part Types Available in Q3—All Other Part Types Available Now.

CIRCLE NO. 169

SOT-23s

Samsung has the SOT-23s you're looking for: industry standard NPN and PNP epitaxial transistors implemented in the internationally standardized micro-package.

Samsung SOT-23s are ideal for both hybrid and surface mounting. Our SOT-23 micro-packaging saves real estate, slashes costs and boosts system reliability.

We also offer a broad range of TR products: industry standard TIP-series power transistors, high-speed high-voltage switching power transistors, power Darlington transistors and our TO-3P silicon mesa transistors—they're rated at 1500 Volts!

Call your Samsung sales office for our SOT-23s or New Transistor data book. ■

CIRCLE NO. 171

SALES OFFICES

| | | | | | |
|----|------------------------|----------------|--------|-----------------------|----------------|
| AL | EMA | (205) 536-3044 | MI | C.B. Jensen | (313) 643-0506 |
| AZ | Haas & Associate, Inc. | (602) 994-3813 | MN | IEI | (612) 571-0000 |
| CA | Quest-Rep | (619) 546-1933 | NC | EMA | (919) 847-8800 |
| CA | Samsung Semiconductor | (408) 727-7433 | NJ | NECCO | (201) 461-2789 |
| CA | Samsung Semiconductor | (714) 662-3406 | NM | Nelco Electronix | (505) 292-3657 |
| CA | SYNPAC | (408) 988-6988 | NY | Reagan-Compar | (518) 489-4777 |
| CA | Westar | (714) 835-4711 | | | (716) 271-2230 |
| CO | Electrodyne | (303) 695-6903 | | | (607) 723-8743 |
| CT | Phoenix Sales | (203) 438-9644 | | | (315) 732-3775 |
| FL | Lawrence Associates | (305) 368-7373 | | | (513) 687-1325 |
| | | (813) 584-8110 | | | (216) 273-3798 |
| | | (305) 339-3855 | | | (614) 262-7274 |
| | | (404) 448-1215 | OH | J.N. Bailey | (503) 245-2283 |
| GA | EMA | (312) 967-8430 | OR | Earl & Brown | (812) 233-4637 |
| IL | IRI | (312) 310-9780 | PA | RJI | (214) 239-0754 |
| IL | Samsung Semiconductor | (312) 844-9227 | SC | EMA | (803) 233-4637 |
| IN | STB | (617) 273-4888 | TX | Samsung Semiconductor | (214) 239-0754 |
| MA | Samsung Semiconductor | (617) 449-7928 | TX | Virelock | (817) 881-1940 |
| MA | Tech Comp | (301) 789-9360 | UT | Electrodyne | (206) 885-5064 |
| MD | ATS | | WA | Earl & Brown | (414) 259-0964 |
| | | | WI | IRI | (604) 430-6677 |
| | | | CANADA | GNT | (416) 622-7558 |
| | | | CANADA | Terrier | |

LINEAR ICs

Samsung offers a full line of linear products, in addition to converters, including: amplifiers, timers, regulators, comparators, telephone ICs, power amplifiers and a number of other ICs.

Samsung's entire line of standard parts is now available in production quantities. A number of our key linear offerings are listed below:

| Data Conversion | |
|--------------------|---|
| KS7126 | 3 1/2 Digit CMOS A/D Converter |
| KS25C02 | 8 bit CMOS Successive Approx. Register |
| KS25C03 | 8 bit CMOS Successive Approx. Register |
| KS25C04 | 12 bit CMOS Successive Approx. Register |
| Voltage Regulators | Op Amps |
| MC78xx | LM741 |
| MC78Mxx | MC1458 |
| MC78Lxx | MC4558 |
| MC79xx | LM358/A |
| MC79Mxx | LM348 |
| LM317T | LM324/A |
| μA78S40 | MC3403 |
| Timers | Comparators |
| KS555 (CMOS) | LM311 |
| NE555 | LM393/A |
| NE556 | LM339/A |
| NE558 | |
| Interface | Tone Decoder |
| MC1488 | LM567 |
| MC1489/A | LM567L (Micropower) |
| Telephone | Others |
| KA2410 | IR Transmitter |
| KA2411 | IR Preamp |
| KA2412A | IR Preamp |
| KA2420 | IR Preamp |
| KA2413 | FM IF Amplifier |
| KS5808 | Ground Fault Detector |
| KS5805A/B | Zero Voltage Switch |
| | LM386 |
| | Audio Power Amplifier |
| | KA2181 |
| | KA2182 |
| | KA2183 |
| | MC3361 |
| | KA2803 |
| | KA2084 |
| | LM386 |
| | IR Transmitter |
| | IR Preamp |
| | IR Preamp |
| | IR Preamp |
| | FM IF Amplifier |
| | Ground Fault Detector |
| | Zero Voltage Switch |
| | Audio Power Amplifier |

Call your local Samsung sales representative for a Data Book that includes our Cross Reference Guide and samples. ■

CIRCLE NO. 172

 **SAMSUNG**
Semiconductor
3725 N. First Street
San Jose, CA 95134-1708
(800) 423-8624

EDN TECHNICAL-ARTICLE DATABASE

In-circuit emulators/emulation

ICE makers grapple with 32-bit microprocessors. *Goering, Richard, Staff Editor; Computer Design, 12/86, pg 46, 2 pgs.*

Inductors

Magnetic materials provide the final piece to the high-frequency switching-supply puzzle. *Small, Charles H, Associate Editor; EDN, 03/04/87, pg 79, 2.33 pgs.*

Industrial electronics

1987 U.S. market report: Industrial. *Staff; Electronics, 01/08/87, pg 66, 2 pgs.*

Personal computers march into the factory. *Dixon, Tom, Staff Editor; Electronic Products, 02/15/87, pg 36, 5.5 pgs.*

Inspection

Moving wafer inspection into the fast lane. *Lyman, Jerry, Staff Editor; Electronics, 03/05/87, pg 74, 3 pgs.*

Quality and reliability screens impact the cost of owning ICs. *Denton, Donald L, Texas Instruments; Electronic Design, 11/20/86, pg 105, 4.5 pgs.*

Instrument interface systems

Card-based ATE system could set a standard. *Sideris, George, Staff Editor; Electronics, 04/16/87, pg 60, 3 pgs.*

How DOD is creating a major new business. *Sideris, George, Staff Editor; Electronics, 04/16/87, pg 57, 3 pgs.*

Instrumentation amps

Instrumentation amp suits wide range of circuit designs. *Burt, Rod, Burr-Brown Corp; EDN, 01/08/87, pg 157, 7 pgs.*

Instrumentation/design aids & services/measurement, other

1987 U.S. market report: Test & measurement. *Staff; Electronics, 01/08/87, pg 61, 3 pgs.*

A bargain in board tester virtuosity. *Hall, John, Summation; Electronic Products, 03/15/87, pg 34, 6.5 pgs.*

A new tool dramatically cuts VLSI debugging time. *McLeod, Jonah, Staff Editor; Electronics, 04/30/87, pg 51, 3 pgs.*

ASIC-verification systems speed prototype testing, but system capabilities vary. *Everett, Chris, Regional Editor; EDN, 11/27/86, pg 51, 8 pgs.*

Affordable image scanners and software simplify the design of imaging systems. *Wright, Maury, Regional Editor; EDN, 03/31/87, pg 75, 6 pgs.*

Analog scopes automate bench test measurements. *Engholm Sunderman, Kathy, Tektronix; Electronic Design, 11/27/86, pg 119, 3 pgs.*

Built-in testability helps to clear some stubborn IC bottlenecks. *Seaton, John; Chu, Louis, Tangent Systems; Electronic Design, 11/27/86, pg 101, 4 pgs.*

Calibrators move to automation to cope with new demands. *Tunick, Diane, Staff Editor; Electronic Design, 03/87, pg 49, 6 pgs.*

Expert designers evaluate PC-based schematic editors. *Freeman, Eva, Associate Editor; EDN, 12/25/86, pg 82, 4.5 pgs.*

Fiber-optic testers determine faults in short-haul networks. *Conner, Margery S, Regional Editor; EDN, 12/25/86, pg 98, 6 pgs.*

IEEE 802.3 LAN testers and analyzers pinpoint network and equipment flaws. *Leibson, Steven H, Regional Editor; EDN, 04/30/87, pg 59, 6 pgs.*

Low-cost IC testers add features. *Yates, Warren, Staff Editor; Electronic Products, 02/01/87, pg 24, 5 pgs.*

Traditional products get squeezed by newer gear. *Sideris, George, Staff Editor; Electronics, 02/05/87, pg 89, 5 pgs.*

Use an interchange format to port component libraries. *Waters, Mike, et al, Motorola; EDN, 02/05/87, pg 175, 7 pgs.*

Integrated circuits/semiconductor devices/circuit design, other

1987 U.S. market report: Semiconductors. *Staff; Electronics, 01/08/87, pg 68, 4 pgs.*

A new wave rises on the Pacific Rim. *Berger, Michael, Staff Editor; Shapiro, Don, Staff Editor; Electronics, 04/02/87, pg 78, 2 pgs.*

A one-world industry is arriving fast. *Erikson, Arthur, Staff Editor; Electronics, 04/02/87, pg 69, 4 pgs.*

A swarm of RISC chips is chasing a fast-growing systems market. *Barney, Clifford, Staff Editor; Electronics, 03/19/87, pg 66, 1 pg.*

Accurate, high-speed analog multipliers promise greater use of analog techniques. *Fleming, Tarlton, Associate Editor; EDN, 02/19/87, pg 57, 5.33 pgs.*

Advances in CMOS and ECL process technology yield power-house ICs. *Marrin, Ken, Staff Editor; Computer Design, 12/86, pg 81, 9.5 pgs.*

Analog-IC arrays can field board-level circuitry. *Moore, Bruce D, Raytheon, Semiconductor Division; Electronic Products, 02/01/87, pg 43, 3 pgs.*

Bipolar and MOS beware: BMFET has speed, power edge. *Beedie, Mitch, Staff Editor; Electronic Design, 11/13/86, pg 35, 0.5 pgs.*

Chip-on-board technology chugs along. *Chin, Spencer, Staff Editor; Electronic Products, 03/01/87, pg 37, 3.5 pgs.*

Consider how TTL outputs work during power-downs. *Taylor, Mark A, Hewlett-Packard Co; EDN, 11/27/86, pg 221, 3 pgs.*

Cost, device speed, size, and reliability determine the best package for an ASIC. *Freeman, Eva, Associate Editor; EDN, 04/30/87, pg 77, 5 pgs.*

Design-for-test techniques suit diverse applications. *Hess, Robert D, et al, Caedent Corp; EDN, 04/15/87, pg 189, 4.5 pgs.*

Designing a state machine with a programmable sequencer. *Lee, Frank, Monolithic Memories; Electronic Products, 02/01/87, pg 29, 7 pgs.*

Don't write off wafer-scale work: It's still going strong. *Cole, Bernard C, Staff Editor; Electronics, 01/08/87, pg 94, 2 pgs.*

Europe pushes hard for global role. *Gosch, John, Staff Editor; Electronics, 04/02/87, pg 75, 1.5 pgs.*

Fuzzy logic allows creation of precise process controllers. *Guilamo, Pedro J, Bailey Controls Co; EDN, 04/15/87, pg 201, 3.5 pgs.*

Hardware methods improve 1-chip A/D converters. *Sidman, Steven, Harris; EDN, 02/05/87, pg 139, 13.5 pgs.*

Here comes the billion-transistor IC. *Cole, Bernard C, Staff Editor; Electronics, 04/02/87, pg 81, 5 pgs.*

How linear IC designers are building denser chips. *Cole, Bernard Conrad, Staff Editor; Electronics, 12/18/86, pg 67, 4 pgs.*

ISSCC: Analog. *Goodenough, Frank, Staff Editor; Electronic Design, 03/05/87, pg 71, 4 pgs.*

ISSCC: Digital. *Bursky, Dave, Staff Editor; Electronic Design, 03/05/87, pg 61, 4.5 pgs.*

ISSCC: Special purpose. *Allan, Roger, Staff Editor; Electronic Design, 03/05/87, pg 79, 3 pgs.*

Inova brings wafer-scale integration to market. *Cole, Bernard C, Staff Editor; Electronics, 01/08/87, pg 91, 3 pgs.*

Interface various IC technologies to CMOS arrays. *Stansberry, Mark, National Semiconductor Corp; EDN, 03/04/87, pg 153, 4 pgs.*

Japan drives for strategic alliances. *Cohen, Charles L, Staff Editor; Electronics, 04/02/87, pg 76, 2 pgs.*

LAN ICs for IEEE-802 networks. *Wiegand, Jim, Associate Editor; EDN, 04/30/87, pg 131, 8.5 pgs.*

Magnetic compensation gives new life to transformer-based SLICs. *Stacey, Chris, National Semiconductor Corp; EDN, 04/30/87, pg 149, 5 pgs.*

Micromachining shapes solid-state sensors and actuators for the digital era. *Allan, Roger, Staff Editor; Electronic Design, 11/13/86, pg 71, 9 pgs.*

Microprogrammable processing. *Leibson, Steven H, Regional Editor; EDN, 04/15/87, pg 143, 13 pgs.*

Mixed analog/digital technologies pack complete systems on-chip. *Martin, Steven L, Contributing Editor; Computer Design, 04/01/87, pg 39, 6 pgs.*

Power on amps solve deflection-yoke drive problems. *Scofield, Grainger, Apex Microtechnology Corp; EDN, 02/19/87, pg 171, 6 pgs.*

Programmable-logic devices. *Small, Charles H, Associate Editor; EDN, 02/05/87, pg 112, 17 pgs.*

Record-setting CPUs, DRAMs, and SRAMs star at ISSCC. *Cole, Bernard C, Staff Editor; Electronics, 03/05/87, pg 58, 9 pgs.*

Reports from the PLD front. *Collett, Ron, Staff Editor; Digital Design, 02/87, pg 46, 5.5 pgs.*

Scan-path tools speed the conversion of your design into a testable chip. *Everett, Chris, Regional Editor; EDN, 03/04/87, pg 67, 5.33 pgs.*

Silicon-on-insulator gets easier. *Cole, Bernard C, Staff Editor; Electronics, 12/18/86, pg 32, 0.5 pgs.*

Synchronous VFC enhances accuracy in analog-input systems. *DeVito, Larry, Analog Devices Semiconductor; EDN, 11/13/86, pg 269, 9.5 pgs.*

Synchronous-network circuit boosts network flexibility. *Vesuna, Sarosh N, Advanced Micro Devices; EDN, 11/13/86, pg 231, 6 pgs.*

TI process boosts linear CMOS ICs to LSI densities. *Staff; Electronics, 12/18/86, pg 71, 3 pgs.*

The look of the industry in 2000. *Weber, Samuel, Staff Editor; Electronics, 04/02/87, pg 60, 2 pgs.*

EDN TECHNICAL-ARTICLE DATABASE

Thermal-tracking IC converts rms to dc. *Williams, Jim, Linear Technology Corp; EDN, 02/19/87, pg 137, 15 pgs.*
This bipolar process gives density and dynamic range. *Cole, Bernard C, Staff Editor; Electronics, 04/16/87, pg 69, 3 pgs.*
Use of check list prevents problems in TTL systems. *Sokal, Nathan O, Design Automation Inc; EDN, 11/13/86, pg 253, 8 pgs.*
Use structured arrays for high-performance data processing. *Chang, Yen, LSI Logic Corp; EDN, 04/15/87, pg 177, 6 pgs.*
VHSIC finally builds a head of steam. *Waller, Larry, Staff Editor; Electronics, 04/16/87, pg 84, 3 pgs.*
VHSIC moves headlong into the submicron stage. *Lyman, Jerry, Staff Editor; Electronics, 04/16/87, pg 91, 3 pgs.*
Winds of change sweep the industry. *Barney, Clifford, Staff Editor; Electronics, 04/02/87, pg 62, 6 pgs.*

Interconnection systems

Socket twists add versatility to a designer's repertoire. *Costlow, Terry, Staff Editor; Electronic Design, 03/87, pg 31, 6.5 pgs.*
Tools help you retain the advantages of using breadboards in gate-array design. *Shear, David, Regional Editor; EDN, 03/18/87, pg 81, 4.33 pgs.*

K

Keyboards

Knowing the ABCs of keyboards puts designers in touch with the right one for the job. *Moss, Craig A, Advanced Input Devices; Electronic Design, 03/87, pg 67, 5.5 pgs.*
Ubiquitous conductive-rubber switches adapt to fit your application and budget. *Conner, Margery, Regional Editor; EDN, 04/30/87, pg 91, 4 pgs.*

L

Land & plant sites

Where the action is in Southern California. *Waller, Larry, Staff Editor; Electronics, 11/13/86, pg 89, 3 pgs.*

Legal issues

Intellectual property turns into high-priced real estate. *Barney, Clifford, Staff Editor; Electronics, 04/30/87, pg 43, 2 pgs.*

Linear circuits

How linear IC designers are building denser chips. *Cole, Bernard Conrad, Staff Editor; Electronics, 12/18/86, pg 67, 4 pgs.*
Linear array captures spirit of discrete design. *Ritmanich, Will; Gill, Harry, Raytheon, Semiconductor Division; Electronic Design, 01/22/87, pg 99, 4.5 pgs.*
TI process boosts linear CMOS ICs to LSI densities. *Staff; Electronics, 12/18/86, pg 71, 3 pgs.*

Local-area network architecture/design/design standards

Dense chips ease networking. *Cormier, Denny, Staff Editor; Digital Design, 01/87, pg 44, 4 pgs.*
Ethernet/CheaperNet chips: The power and the process. *Cormier, Denny, Staff Editor; Digital Design, 04/87, pg 87, 3 pgs.*
IBM bridging scheme roils the local net community. *Lineback, J Robert, Staff Editor; Electronics, 11/27/86, pg 29, 1 pg.*
Influence of fiberoptic Ethernet LANs expands. *Mokhoff, Nicolas, Staff Editor; Computer Design, 01/15/87, pg 41, 3 pgs.*
LAN ICs for IEEE-802 networks. *Wiegand, Jim, Associate Editor; EDN, 04/30/87, pg 131, 8.5 pgs.*
LAN ICs let you build networks for PCs. *Cormier, Denny, Regional Editor; EDN, 12/11/86, pg 136, 8.5 pgs.*
LAN standards make headway in CAE/CAD. *Collett, Ron, Staff Editor; Digital Design, 04/87, pg 82, 3.5 pgs.*
Ring software brightens LAN-scape. *Lineback, J Robert, Staff Editor; Electronics, 11/27/86, pg 30, 1 pg.*
Some silicon solutions for MAP. *Loyer, Bruce A, Motorola Semiconductor Products; Electronic Products, 03/15/87, pg 60, 8 pgs.*
Two-chip modem suits high-speed LAN systems. *Shah, Prasanna M, Signetics Corp; EDN, 03/31/87, pg 171, 8.5 pgs.*

Logic analyzers/analysis

ASIC-verification systems speed prototype testing, but system

capabilities vary. *Everett, Chris, Regional Editor; EDN, 11/27/86, pg 51, 8 pgs.*

Debug system targets multiprocessor design. *Noelcke, Gus, Northwest Instrument Systems; Computer Design, 11/01/86, pg 105, 6.5 pgs.*

General-purpose logic analyzers increase functionality, ease of use. *Mayer, John H, Staff Editor; Computer Design, 04/01/87, pg 104, 5 pgs.*

IEEE 802.3 LAN testers and analyzers pinpoint network and equipment flaws. *Leibson, Steven H, Regional Editor; EDN, 04/30/87, pg 59, 6 pgs.*

Logic-timing analyzer samples synchronously. *Sheldon, James H, Outlook Technology; Electronic Design, 11/13/86, pg 131, 5 pgs.*

Signature analyzer on a chip tests complex logic. *Duncan, Robert, Altera; Electronic Products, 02/01/87, pg 36, 4 pgs.*

Logic arrays/systems

Altera makes it easier to build fast state machines. *Cole, Bernard C, Staff Editor; Electronics, 03/19/87, pg 76, 3 pgs.*

Designing a state machine with a programmable sequencer. *Lee, Frank, Monolithic Memories; Electronic Products, 02/01/87, pg 29, 7 pgs.*

ECL arrays sprint to the forefront. *Collett, Ron, Staff Editor; Digital Design, 04/87, pg 35, 6 pgs.*

Faster, more complex PLDs arrive with better programming tools. *Bursky, Dave, Staff Editor; Electronic Design, 04/87, pg 13, 7.5 pgs.*

Fusible links help customize high-density ECL arrays. *Agrawal, Om; Mubarak, Fares, Advanced Micro Devices; Electronic Design, 12/11/86, pg 105, 5 pgs.*

Microprogrammed devices. *Myrvaagnes, Rodney, Staff Editor; Electronic Products, 11/03/86, pg 46, 10 pgs.*

New tools ease state-machine design. *Martin, Steven L, Contributing Editor; Computer Design, 03/15/87, pg 36, 3 pgs.*

PLDs provide fast lane to semicustom designs. *Martin, Steven L, Contributing Editor; Computer Design, 03/01/87, pg 28, 6.5 pgs.*

Presenting the PLD today. *Gabay, Jon, Contributing Editor; Electronic Products, 04/15/87, pg 43, 5 pgs.*

Programmable devices tailored to state machine needs. *Martin, Steven L, Contributing Editor; Computer Design, 11/15/86, pg 37, 5 pgs.*

Programmable logic shrinks bus-interface designs. *Sharma, Nageen, Intel; Electronic Design, 02/05/87, pg 101, 3.5 pgs.*

Programmable-logic devices. *Small, Charles H, Associate Editor; EDN, 02/05/87, pg 112, 17 pgs.*

Prose devices simplify state machine design. *Schmitz, Nick, Monolithic Memories; Computer Design, 04/01/87, pg 97, 6 pgs.*

Regain lost I/O ports with erasable PLDs. *Smith, Daniel E; Bowns, Thomas B, Intel; Electronic Design, 03/19/87, pg 151, 4.5 pgs.*

Reports from the PLD front. *Collett, Ron, Staff Editor; Digital Design, 02/87, pg 46, 5.5 pgs.*

M

Mainframe computers

New minis bring supercomputing to earth. *Ohr, Stephan, Staff Editor; Electronic Design, 04/30/87, pg 33, 3 pgs.*

Management

Laid-off engineers find the experience painful but survivable. *Asbrand, Deborah, Associate Editor; EDN, 01/22/87, pg 303, 4 pgs.*

Marketing/markets/pricing

1987 U.S. market report: Consumer. *Staff; Electronics, 01/08/87, pg 64, 2 pgs.*

CMOS pushing into lead, advances in ECL slow GaAs. *Rosenblatt, Alfred, Staff Editor; Electronic Products, 03/01/87, pg 15, 1 pg.*

Overseas market report: Another tough year. *Staff; Electronics, 01/22/87, pg 65, 23 pgs.*

Materials research/development

Ballistic diode bursts through frequency ceiling. *Iversen, Wesley R, Staff Editor; Electronics, 02/19/87, pg 29, 1 pg.*

Found! A practical way to turn out Josephson junction chips. *Weber, Samuel, Staff Editor; Electronics, 02/19/87, pg 49, 5 pgs.*

Wyse takes the high cost out of high resolution.

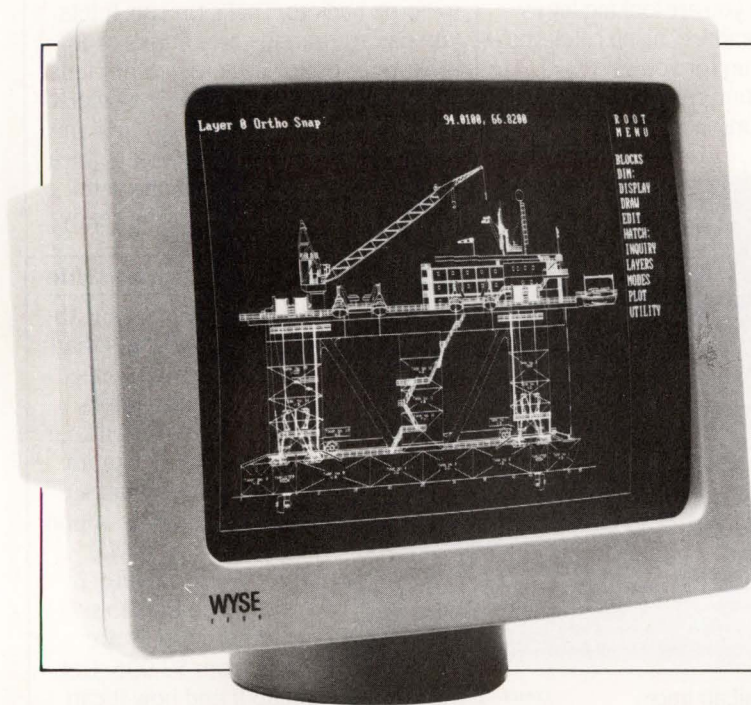

At \$999, the WY-700 Graphics Subsystem is easily affordable. And its 1280 x 800 resolution makes the best of software packages like these:

DESKTOP PUBLISHING

Ventura Publisher
PageMaker/PC
Frontpage
DeskSet
Pagemaster
Rim System
Compound Document Processor
Display Ad Make-up System
AdvanTex

GENERAL PC SOFTWARE

Lotus 1-2-3
Symphony
PC-Paintbrush

COMPUTER-AIDED DESIGN

AutoCAD
Cadvance
In-A-Vision
Generic CADD
VersaCAD ADVANCED
Workview
Procad PC
P-CAD Systems

GRAPHIC SYSTEM TOOLS

MS-Windows
GEM
MetaWindows
HALO
KEE PC

Wyse raises the standards for high resolution graphics, while lowering the cost.

Now you can have high resolution and full IBM software compatibility.

So Desktop publishing applications can get the screen treatment they deserve. You can run spreadsheets like Lotus 1-2-3 with four times more data displayed on the screen. Computer-Aided Design packages can deliver their full potential. And Graphics-based pc environments finally have the high resolution they were made for.

You can do it all on the WY-700. A complete system, monitor and board, for just \$999. With a large 15-inch display, full tilt and swivel, and a crisp 1280 x 800 pixel resolution.

The WY-700. It's your best solution for high resolution.

Write Wyse Technology, Attention: Marcom Dept. 700,

3571 N. First Street, San Jose, CA 95134. Or call toll-free, today, for more information.

Call 1-800-GET-WYSE

WYSE

YOU NEVER REGRET A WYSE DECISION.



MICROPROCESSOR MASTERY!

The Development System that Supports 150 Different Microprocessors.

A complete solution

Here, at last, is the working environment of the future for developing error-free and efficient microprocessor code. Save time and money with UniLab II's seamlessly integrated toolset:

An 8/16-Bit Universal Emulator

With UniLab's full selection of symbolic debug commands you can quickly display and change all registers, memory, and ports, plus set software and hardware breakpoints.

An Advanced 48-Channel Analyzer

Most other development systems are dead in the water if there is a hardware fault, such as a simple bus short. Now, you can use the power of UniLab to home in on both software and hardware problems quickly.

An Input Stimulus Generator

You conveniently specify system inputs and observe the results.

A Built-In EPROM Programmer

helps finish the job!

Development Dreams Come True

Use UniLab's advanced windows to set up your screen the way you want to... view multiple items of interest. Imagine being able to automatically compare a current trace with previous trace data to instantly determine differences. You can set breakpoints, single-step, then go back to the analyzer without missing a beat. If you make a change in your code, use UniLab's built-in line-by-line assembler to instantly patch the fix and test the results. Think of the time savings.

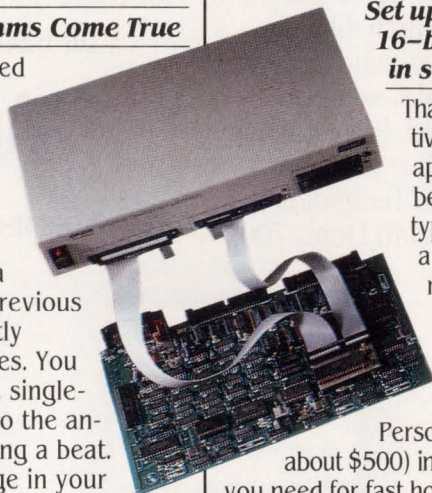

Find Bugs Fast

Searching for bugs by single-stepping through suspect code can take forever. Now, with UniLab, just specify the bug symptom you are looking for as a trigger spec and let UniLab catch the

bug for you as your program runs in real time.

On-Line Help menus, Command Glossary, and Word List.

Pop-up Mode Selection panel called by soft key.

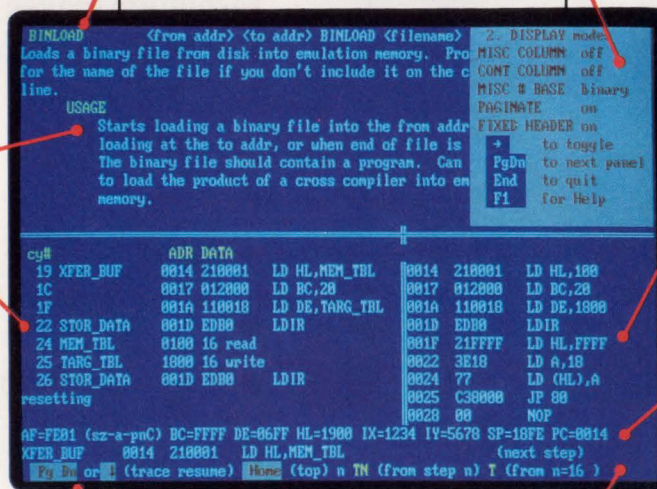

Windows can be used to view source files, previous traces, and more.

Symbol translation or source code line display.

Screen displays scroll off into history buffer - can be viewed later.

UniLab trace filtering eliminates extraneous information and shows you only the program steps of interest.

Context sensitive prompt line.

Get Running Fast

You probably won't use your development system every day. You do need a system that's easy to learn, and easy to come back to. That's UniLab. It lets you use commands or menus - or a mixture of both. The same commands work for all MPUs. Useful help screens, an on-line manual & glossary, instant pop-up mode panels, a quick command and parameter reference, are at the ready.

Affordable, Expandable

At less than \$5,000 UniLab costs less than our less-able competitors. You can add our new Program Performance Analysis option to help you

Disassembly of code in memory can be compared with trace in adjacent window.

Symbolic breakpoint register display.

optimize your software. If you don't need UniLab's power, other models are available from \$2,995. Get the story on UniLab II and how it can revolutionize your software design efficiency, as it has for thousands. Universities, ask about our Education Outreach Discount Program.

Call Toll-Free 1-800-245-8500. In California call (415) 361-8883.

Set up for any 8- or 16-bit processor in seconds!

Thanks to our innovative emulation approach, moving between processor types requires only a new emulation module and software change. You save both money and time: Our inexpensive

Personality Paks™ (only about \$500) include all the items you need for fast hook-up. Orion MicroTargets™, functioning target circuits for popular MPUs, let you test your software before your own hardware is ready.

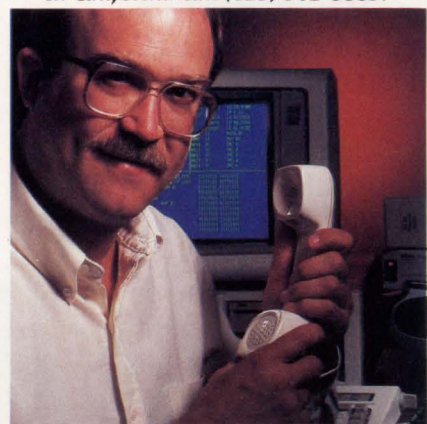

When you own or rent a UniLab II, you get access to Orion's team of Applications Engineers.

ORION
INSTRUMENTS, INC.

702 Marshall St.
Redwood City, CA
94063
TELEX 530942

EDN TECHNICAL-ARTICLE DATABASE

- Superconductor R&D moves ahead on several world fronts. *Iversen, Wesley R, Staff Editor; Electronics, 02/19/87, pg 54, 3 pgs.*
- TI's answer to the need for faster VLSI: its ExCL process. *Staff; Electronics, 03/19/87, pg 73, 3 pgs.*
- Memory boards/systems**
- Static RAMs. *Mosley, J D, Regional Editor; EDN, 01/08/87, pg 128, 9 pgs.*
- Two startups are the only U.S. players in bubble memories. *McLeod, Jonah, Staff Editor; Electronics, 01/08/87, pg 102, 2 pgs.*
- Memory controllers**
- Fast controller converts large static RAMs to FIFO buffers. *Siddique, Naseer; Krupecki, Frank, Signetics; Electronic Design, 02/19/87, pg 103, 3.5 pgs.*
- Fast error-correcting ICs aid large memory systems. *Rajpal, Suneel; Mick, John R, Integrated Device Technology; Electronic Design, 02/19/87, pg 123, 3.5 pgs.*
- Software approach broadens options for virtual memory. *Case, Brian, Advanced Micro Devices; Electronic Design, 04/16/87, pg 107, 5 pgs.*
- Static RAMs. *Mosley, J D, Regional Editor; EDN, 01/08/87, pg 128, 9 pgs.*
- Memory devices**
- 1-Mbit products bring new life to DRAM market. *Mayer, John H, Staff Editor; Computer Design, 02/15/87, pg 142, 4.5 pgs.*
- 200-MHz video FIFO buffer juggles multiple windows. *Pieper, Steve; Garbe, Olivier, Advanced Micro Devices; Electronic Design, 02/05/87, pg 95, 3 pgs.*
- 3-logic-state IC speeds data base. *Rose, Craig D, Staff Editor; Electronics, 11/13/86, pg 40, 1 pg.*
- A crucial step toward ultra-fast data paths. *Staff; Electronics, 11/27/86, pg 78, 1 pg.*
- Check lists help you avoid trouble with MOS and memory ICs. *Sokal, Nathan O, Design Automation Inc; EDN, 11/27/86, pg 229, 5.5 pgs.*
- Contactless arrays for EPROMs arrive just in time. *Staff; Electronics, 11/27/86, pg 70, 3 pgs.*
- Designing a state machine with a programmable sequencer. *Lee, Frank, Monolithic Memories; Electronic Products, 02/01/87, pg 29, 7 pgs.*
- EEPROM programs in a flash. *Murthy, Samba, Seeq Technology; Digital Design, 04/87, pg 78, 2.5 pgs.*
- Fast controller converts large static RAMs to FIFO buffers. *Siddique, Naseer; Krupecki, Frank, Signetics; Electronic Design, 02/19/87, pg 103, 3.5 pgs.*
- Fast error-correcting ICs aid large memory systems. *Rajpal, Suneel; Mick, John R, Integrated Device Technology; Electronic Design, 02/19/87, pg 123, 3.5 pgs.*
- Integrated MMU and data cache supports 30-MHz zero-wait-state accesses. *Marrin, Ken, Staff Editor; Computer Design, 12/86, pg 31, 2 pgs.*
- Memory-based CMOS FIFO buffers sport large capacities, rival the speed of bipolars. *Harold, Peter, European Editor; EDN, 03/18/87, pg 65, 6.33 pgs.*
- Message passing with dual-ported RAMs. *Myrvaaagnes, Rodney, Staff Editor; Electronic Products, 01/15/87, pg 24, 5 pgs.*
- Programmable devices tailored to state machine needs. *Martin, Steven L, Contributing Editor; Computer Design, 11/15/86, pg 37, 5 pgs.*
- Smart memories are eating into the jelly-bean market. *Cole, Bernard C, Staff Editor; Electronics, 02/05/87, pg 65, 5 pgs.*
- Software approach broadens options for virtual memory. *Case, Brian, Advanced Micro Devices; Electronic Design, 04/16/87, pg 107, 5 pgs.*
- Static RAMs. *Mosley, J D, Regional Editor; EDN, 01/08/87, pg 128, 9 pgs.*
- Testable PROM operates at bipolar speed. *Anderson, Gary, Cypress Semiconductor; Electronic Products, 03/01/87, pg 43, 4.5 pgs.*
- The 10- and 5-ns solution to SRAM contention. *Chritz, Jeff; Reddy, Al, Fairchild Semiconductor; Electronic Products, 04/01/87, pg 43, 3 pgs.*
- Two startups are the only U.S. players in bubble memories. *McLeod, Jonah, Staff Editor; Electronics, 01/08/87, pg 102, 2 pgs.*
- Microcomputer buses/interfaces**
- 32-bit VME CPUs pack power of a VAX onto just one board. *Panasuk, Curtis, Staff Editor; Electronic Design, 12/11/86, pg 59, 6 pgs.*
- 32-bit bus products to take off, aided by custom ICs and SMT. *Ramunni, Joseph S, Heurikon; Electronic Products, 01/15/87, pg 43, 1 pg.*
- A designer's decision: System or device level for peripheral interfaces? *Fifield, Brian, Emulex; Electronic Products, 11/17/86, pg 39, 3.5 pgs.*
- Controllers spark fast data transfers in VMEbus systems. *Ohr, Stephan, Staff Editor; Electronic Design, 12/11/86, pg 73, 5.5 pgs.*
- Extending the PC/AT bus. *Jones, Larry, Faraday Electronics; Digital Design, 03/87, pg 90, 3 pgs.*
- High-end buses face PC challenge. *Wilson, David, Editor; Digital Design, 12/86, pg 30, 4 pgs.*
- How Aptec plans to break the I/O bottleneck. *Staff; Electronics, 11/13/86, pg 54, 3 pgs.*
- Industrial buses. *Titus, Jonathan, Editor; EDN, 02/19/87, pg 115, 10.5 pgs.*
- Intelligent peripheral interface standard permits data-transfer rates of 10M bytes/sec. *Wright, Maury, Regional Editor; EDN, 01/08/87, pg 105, 6 pgs.*
- Interface your PC to the Multibus. *Robertson, William H, KLA Instruments Corp; EDN, 01/08/87, pg 167, 10.5 pgs.*
- PC platform simplifies STD bus development. *Finster, Ken, Micro/sys; Digital Design, 03/87, pg 79, 2.5 pgs.*
- Programmable logic shrinks bus-interface designs. *Sharma, Nageen, Intel; Electronic Design, 02/05/87, pg 101, 3.5 pgs.*
- The big drag on computer throughput. *Manuel, Tom, Staff Editor; Barney, Clifford, Staff Editor; Electronics, 11/13/86, pg 51, 3 pgs.*
- Turning to NuBus, the Mac opens up for engineering. *Meng, Brita, Staff Editor; Digital Design, 04/87, pg 21, 3 pgs.*
- Microcomputers**
- 32-bit VME CPUs pack power of a VAX onto just one board. *Panasuk, Curtis, Staff Editor; Electronic Design, 12/11/86, pg 59, 6 pgs.*
- Buyers guide to single-board computers. *Staff; Computer Design, 02/15/87, pg 81, 34.5 pgs.*
- Controllers spark fast data transfers in VMEbus systems. *Ohr, Stephan, Staff Editor; Electronic Design, 12/11/86, pg 73, 5.5 pgs.*
- EDN's 13th Annual μ P/ μ C Chip Directory. *Cushman, Robert H, Special Features Editor; EDN, 11/27/86, pg 102, 56.5 pgs.*
- High-end buses face PC challenge. *Wilson, David, Editor; Digital Design, 12/86, pg 30, 4 pgs.*
- High-powered desktop image processing gets closer. *Staff; Electronics, 02/19/87, pg 62, 3 pgs.*
- Mainframe architectures and compiler techniques power 32-bit micros. *Marrin, Ken, Staff Editor; Computer Design, 02/01/87, pg 57, 12 pgs.*
- Single-board computers offer designers system-level performance. *Mokhoff, Nicolas, Staff Editor; Computer Design, 02/15/87, pg 63, 9 pgs.*
- System timing sets microprocessor performance. *Schopmeyer, Robert, Convergent Technologies; Computer Design, 03/15/87, pg 67, 3.5 pgs.*
- The fast way to build a RISC processor. *Ajmera, Dhaval; Kong, Cheng-Gang, Advanced Micro Devices; Electronic Products, 11/17/86, pg 45, 5 pgs.*
- Microprocessor buses**
- Industrial buses. *Titus, Jonathan, Editor; EDN, 02/19/87, pg 115, 10.5 pgs.*
- Inter-IC bus eases control of linear circuits. *Nemec, John, Signetics; Computer Design, 01/01/87, pg 73, 3.5 pgs.*
- The big drag on computer throughput. *Manuel, Tom, Staff Editor; Barney, Clifford, Staff Editor; Electronics, 11/13/86, pg 51, 3 pgs.*
- Microprocessor support chips**
- Analogue supervisor chip keeps microprocessor out of trouble. *Allen, Charlie, Maxim Integrated Products; Electronic Design, 04/30/87, pg 104, 5 pgs.*
- Chip set brings bit mapping to low-end CRT displays. *MacKenna, Craig, et al, Signetics; Electronic Design, 01/22/87, pg 88, 4 pgs.*
- Constant-density recording comes alive with new chips. *Young, Mark S, Advanced Micro Devices; Electronic Design, 11/13/86, pg 141, 4 pgs.*
- Continued improvements ensure survival of 16-bit micros. *Bond, John, Contributing Editor; Computer Design, 02/15/87, pg 22, 7 pgs.*
- DSP: A technology in search of applications. *Marrin, Ken, Staff Editor; Computer Design, 11/15/86, pg 59, 14 pgs.*
- Designer's dream machine: Dallas Semiconductor's microcontroller updates itself on the fly. *Cole, Bernard C, Staff Editor; Electronics, 03/05/87, pg 53, 5 pgs.*

EDN TECHNICAL-ARTICLE DATABASE

- External hardware augments low-cost display controller. *Stelbrink, Juergen, Advanced Micro Devices Inc; EDN, 11/27/86, pg 209, 6 pgs.*
- Integrated MMU and data cache supports 30-MHz zero-wait-state accesses. *Marrin, Ken, Staff Editor; Computer Design, 12/86, pg 31, 2 pgs.*
- Microprogram sequencers depart from classic architectures. *Martin, Steven L, Contributing Editor; Computer Design, 12/86, pg 37, 4 pgs.*
- Microprogrammable processing. *Leibson, Steven H, Regional Editor; EDN, 04/15/87, pg 143, 13 pgs.*
- New coprocessors head toward supermini speeds. *Wilson, Ron, Staff Editor; Computer Design, 04/15/87, pg 23, 6 pgs.*
- Peripherals enhance 80386 design options. *Kumar, V Siva, Intel; Computer Design, 03/01/87, pg 63, 5 pgs.*
- Processor chip set shrinks latency, boosts throughput. *Peterson, Jim; Leibowitz, Robert N, Bipolar Integrated Technology; Electronic Design, 02/05/87, pg 75, 4.5 pgs.*
- Programmable devices tailored to state machine needs. *Martin, Steven L, Contributing Editor; Computer Design, 11/15/86, pg 37, 5 pgs.*
- Serial data races at parallel rates for the best of both worlds. *Connor, Gary, et al, Advanced Micro Devices; Electronic Design, 01/22/87, pg 79, 5 pgs.*
- Supermicro chip set spans micro-mainframe performance gap. *Ackerman, Mike, Fairchild Semiconductor; Electronic Products, 11/17/86, pg 28, 8 pgs.*
- This disk-drive controller chip plays in any league. *Cole, Bernard C, Staff Editor; Electronics, 03/05/87, pg 81, 3 pgs.*
- Microprocessors**
- 32-bit CMOS CPU chip acts like a mainframe. *Baron, Max; Iacobovici, Sorin, National Semiconductor; Electronic Design, 04/16/87, pg 95, 5 pgs.*
- 32-bit microprocessors. *Bursky, Dave, Staff Editor; Electronic Design, 01/08/87, pg 128, 7 pgs.*
- Continued improvements ensure survival of 16-bit micros. *Bond, John, Contributing Editor; Computer Design, 02/15/87, pg 22, 7 pgs.*
- DOS compatibility spurs design-ins for 80386. *Williams, Tom, Staff Editor; Computer Design, 01/15/87, pg 22, 2.5 pgs.*
- DSP: A technology in search of applications. *Marrin, Ken, Staff Editor; Computer Design, 11/15/86, pg 59, 14 pgs.*
- Designer's dream machine: Dallas Semiconductor's microcontroller updates itself on the fly. *Cole, Bernard C, Staff Editor; Electronics, 03/05/87, pg 53, 5 pgs.*
- Developers debate merits of military microprocessors. *Suydam, William, Contributing Editor; Computer Design, 02/01/87, pg 38, 5 pgs.*
- Does Catalyst have the key to smart cards? *Staff; Electronics, 12/18/86, pg 59, 4 pgs.*
- EDN's 13th Annual μ P/ μ C Chip Directory. *Cushman, Robert H, Special Features Editor; EDN, 11/27/86, pg 102, 56.5 pgs.*
- External hardware augments low-cost display controller. *Stelbrink, Juergen, Advanced Micro Devices Inc; EDN, 11/27/86, pg 209, 6 pgs.*
- High-speed processor revamps bit-slice design. *Rauch, Ken, et al, Weitek; Computer Design, 11/01/86, pg 97, 4 pgs.*
- How Meiko is getting an instant supercomputer. *Staff; Electronics, 11/27/86, pg 56, 2 pgs.*
- How computer makers are making the most of the 80386. *McLeod, Jonah, Staff Editor; Electronics, 11/27/86, pg 85, 2 pgs.*
- ICE makers grapple with 32-bit microprocessors. *Goering, Richard, Staff Editor; Computer Design, 12/86, pg 46, 2 pgs.*
- Mainframe architectures and compiler techniques power 32-bit micros. *Marrin, Ken, Staff Editor; Computer Design, 02/01/87, pg 57, 12 pgs.*
- Make your own low-cost 8051 emulator. *Horton, Eric P, Nova Scotia Power Corp; EDN, 11/13/86, pg 193, 12 pgs.*
- Microcontrollers ease real-time tasks. *Winard, Harold, Electronic Design, 11/20/86, pg 167, 6 pgs.*
- Microprocessor experts tackle benchmarking, support and architectural issues in open debate. *Marrin, Ken, Staff Editor; Computer Design, 01/01/87, pg 21, 5.5 pgs.*
- Microprogram sequencers depart from classic architectures. *Martin, Steven L, Contributing Editor; Computer Design, 12/86, pg 37, 4 pgs.*
- New tools ease development of bit-slice microcode. *Falk, Howard, Contributing Editor; Computer Design, 02/15/87, pg 48, 2.5 pgs.*
- Pipelined processor pushes performance. *Case, Brian, Advanced Micro Devices; Digital Design, 03/87, pg 30, 4 pgs.*
- Smart card: Will it create a billion dollar IC business? *Barney, Clifford, Staff Editor; Electronics, 12/18/86, pg 55, 4 pgs.*
- Software models simulate 68010 and its peripherals. *Billowitch, William D, Quadtree; Electronic Design, 02/05/87, pg 113, 4.5 pgs.*
- Supermicro chip set spans micro-mainframe performance gap. *Ackerman, Mike, Fairchild Semiconductor; Electronic Products, 11/17/86, pg 28, 8 pgs.*
- System timing sets microprocessor performance. *Schopmeyer, Robert, Convergent Technologies; Computer Design, 03/15/87, pg 67, 3.5 pgs.*
- The fast way to build a RISC processor. *Ajmera, Dhaval; Kong, Cheng-Gang, Advanced Micro Devices; Electronic Products, 11/17/86, pg 45, 5 pgs.*
- This CPU does floating point faster than any two-chip set. *Staff; Electronics, 11/27/86, pg 51, 5 pgs.*
- Three 32-bit chips boost multiuser performance. *Martin, Arlon G; Miller, Norman R, AT&T Technology Systems; Electronic Design, 11/27/86, pg 89, 6.5 pgs.*
- World's fastest microprocessor! *Wolfe, Alexander, Staff Editor; Cole, Bernard C, Staff Editor; Electronics, 03/19/87, pg 61, 3 pgs.*
- Military electronics**
- A major facelift starts for strategic radar nets. *Eleccion, Marce, Staff Editor; Electronics, 04/16/87, pg 78, 4 pgs.*
- Boosting MIL-spec chip performance with RISC. *Manuel, Tom, Staff Editor; Electronics, 03/19/87, pg 97, 2 pgs.*
- Computer pro says launch-on-warning is technically unsound. *Patton, Carole, Staff Editor; Electronic Design, 12/11/86, pg 181, 1 pg.*
- Developers debate merits of military microprocessors. *Suydam, William, Contributing Editor; Computer Design, 02/01/87, pg 38, 5 pgs.*
- How DOD is creating a major new business. *Sideris, George, Staff Editor; Electronics, 04/16/87, pg 57, 3 pgs.*
- Military electronics. *Allan, Roger, Staff Editor; Electronic Design, 01/22/87, pg 62, 8 pgs.*
- Military power supplies look to escape customization trap. *Neuhart, Milton, Electronic Design, 11/20/86, pg 29, 5 pgs.*
- Specially processed operational amplifiers meet rad-hard and high-temperature needs. *Wiegand, Jim, Associate Editor; EDN, 01/22/87, pg 75, 4.5 pgs.*
- Surface-mounting poises for a military takeover. *Reynolds, Robert A, Texas Instruments; Electronic Design, 03/87, pg 43, 3 pgs.*
- TI puts its Lisp chip into a system for military AI. *Wolfe, Alexander, Staff Editor; Electronics, 03/19/87, pg 95, 2 pgs.*
- VHSIC finally builds a head of steam. *Waller, Larry, Staff Editor; Electronics, 04/16/87, pg 84, 3 pgs.*
- VHSIC moves headlong into the submicron stage. *Lyman, Jerry, Staff Editor; Electronics, 04/16/87, pg 91, 3 pgs.*
- Minicomputers**
- Making the MicroVAX a real-time machine. *Wilson, Dave, Editor; Killmon, Peg, Contributing Editor; Digital Design, 01/87, pg 32, 1 pg.*
- Opening doors to DEC compatibility. *Aseo, Joseph, Staff Editor; Digital Design, 01/87, pg 39, 2 pgs.*
- Modems**
- A modem chip that needs only one 5-V power supply. *Staff; Electronics, 01/08/87, pg 81, 3 pgs.*
- Faster, cheaper modem ICs are well on their way. *Allan, Roger, Staff Editor; Electronic Design, 04/30/87, pg 81, 8 pgs.*
- Low-cost chip set offers Bell 103 functions. *Wolbert, Bob, Exar; Computer Design, 03/01/87, pg 73, 4 pgs.*
- Modem prices drop as chips absorb more functions. *Chester, Michael, Staff Editor; Electronic Products, 03/01/87, pg 28, 6 pgs.*
- The furious race to develop 2,400-b/s modem chip sets. *Lineback, J Robert, Staff Editor; Electronics, 01/08/87, pg 84, 3 pgs.*
- Monitor circuits**
- Synchronous-network circuit boosts network flexibility. *Vesuna, Sarosh N, Advanced Micro Devices; EDN, 11/13/86, pg 231, 6 pgs.*
- Motor control circuits**
- One-chip computer shrinks size and part count of stepping-motor controller. *Goldberg, Edward H, NEC Electronics; Electronic Design, 04/87, pg 81, 4 pgs.*
- Motors/motor controllers**
- Modern stepper-motor systems provide precise position control and resolution. *Ormond, Tom, Senior Editor; EDN, 01/08/87, pg 85, 5 pgs.*

Text continued on pg 207

EDN August 6, 1987

CUT COATING COSTS, WITH PARYLENE!



Vacuum-deposited parylene is widely recognized as the most effective and technically sophisticated conformal coating available for circuit boards and electronic components.

Count all of your coating expenses, and you may find that off-site custom parylene coating is also the most economical coating. Consider the advantages:

- eliminates contamination, pollution and disposal problems, and related expense
- reduces labor, need for space and equipment, and the high cost of waste material
- provides unmatched coating performance, in micron thicknesses
- preserves board repairability and saves scrap costs
- greatly improves long-term system reliability

Nova Tran is the leading custom parylene coater, with specialized expertise, and regional coating centers for fast response. Our efficient off-site custom coating services are used by commercial and military equipment OEM's.

Figure the real cost of your circuit board coating operation, and then take a closer look at parylene. Contact Nova Tran for economical engineering test run details.

Coating Centers:

New Hampshire
Indiana

Wisconsin
California

Qualified to Mil I-46058C

Nova Tran also offers parylene coating equipment and application engineering assistance for on-site coating.

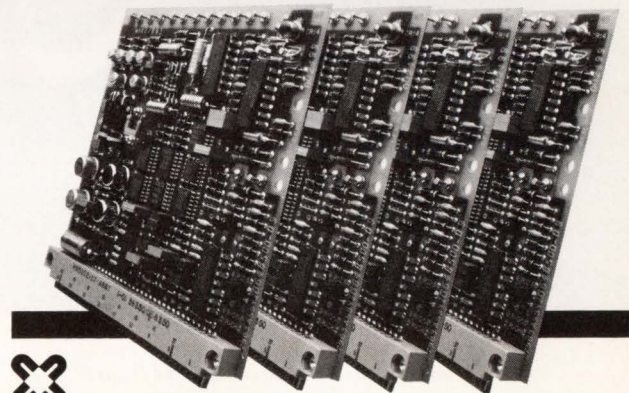

**NOVA TRAN
CORPORATION.**

100 DEPOSITION DRIVE
CLEAR LAKE, WISCONSIN 54005
715/263-2333 / TELEX 29-0220

1-800-554-1697



Subsidiary of Union Carbide Corporation
Copyright ©1986 Nova Tran Corp.

For OEMs who know the sky is not the limit.



Before the telescope, scientists charted the universe largely by testing theory against human observation. With the advent of the telescope, the cosmos could be more accurately mapped. Today, sophisticated systems from MASSCOMP are used to gather and process satellite data, helping scientists to expand the known universe.



Aerospace.

In aircraft design, weather forecasting, satellite telemetry or astronomy, our OEMs focus on solutions that push the frontiers of science and engineering.

MASSCOMP's OEM, VAR, and systems integrator customers use our systems wherever people need computer power to reach new heights.

From board sets to complete multiprocessor-based systems, from 2 to 15 MIPS, our family of compatible computers share an open architecture and the first real-time implementation of the UNIX® operating system.

A wide range of graphics options and hardware accelerators allow our resellers to configure systems for a variety of applications.

Expand your company's horizons. Call the MASSCOMP OEM Products Group and ask about our Growth Partnership Program—products and services designed for OEMs.

1-800-451-1824

MASSCOMP is a trademark of Massachusetts Computer Company.
UNIX is a registered trademark of AT&T Bell Laboratories.

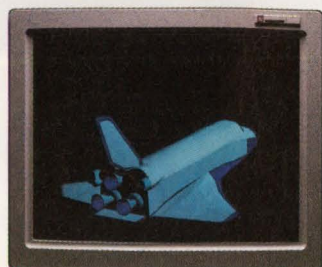

MASSCOMP

One Technology Park, Westford, Massachusetts 01886

LIF YOUR CAMS AWAY

LOW INSERTION FORCE (LIF) CONNECTORS BEAT ZERO INSERTION FORCE (ZIF) CONNECTORS 3 TIMES:

1. **WIPE:** contact wipe eliminates corrosion and disconnects caused by cable weight.
2. **COST:** jack screw coupling costs less than cam actuated coupling.
3. **RELIABILITY:** jack screw coupling eliminates intermittent contact.

The Hypertronics N-series of connectors eliminate the common problems of comparable ZIF connectors. They provide lower cost in high pin count models and applications flexibility:

- 70 to 700 contact positions
- Rack and panel, cable to chassis, cable to cable models
- 5 Amp and 9 Amp contacts
- Crimp, solder cup, wire wrap,[®] and dip solder termination.

The N-series utilize the Hypertac[®] contact which provides:

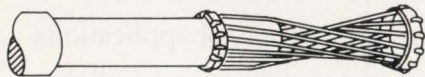

- Extremely low contact insertion/extraction force (as low as 1/2 ounce)
- Electrical continuity under extremes of shock and vibration (tested below 10 nanoseconds)
- Contact life exceeding 100,000 with excellent electrical repeatability
- Contact resistance under 5 milliohms.

To learn more about these versatile connectors and which configurations are right for you, call us toll-free 1-800-225-9228 or write for a copy of our complete 1987 catalog.

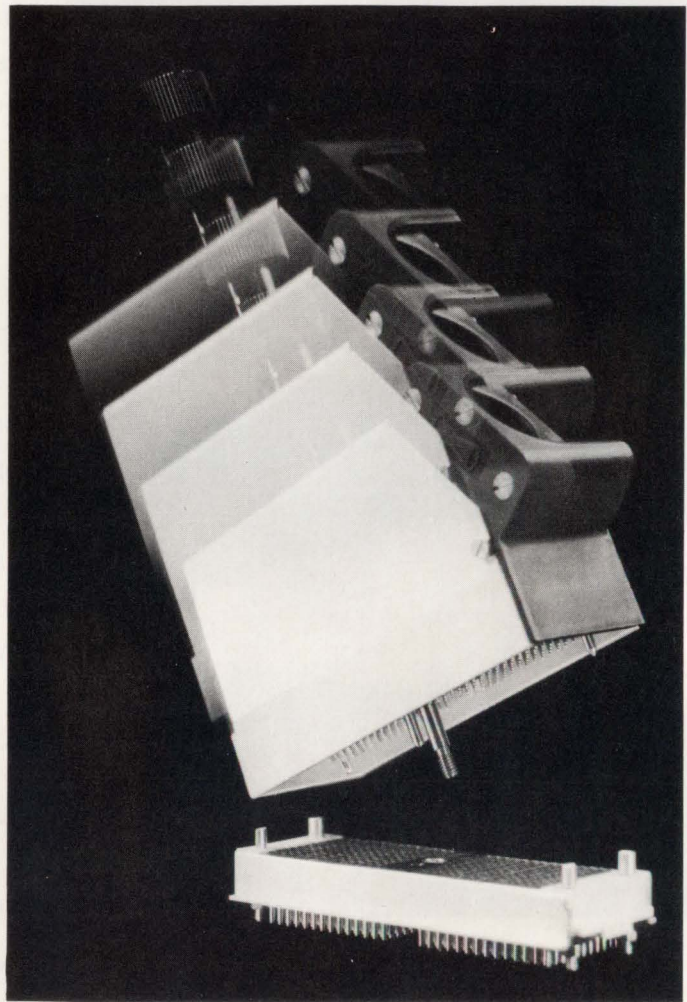

 **HYPERTRONICS CORPORATION**
"New Horizons in Connectors"

16 Brent Drive, Hudson, MA 01749-2904
MA & Canada Tel: (617) 568-0451

Telex: 95 1152
Fax: (617) 568-0680

[®] Wire wrap is a registered trademark of Gardner Denver.

EDN TECHNICAL-ARTICLE DATABASE

One-chip computer shrinks size and part count of stepping-motor controller. *Goldberg, Edward H, NEC Electronics; Electronic Design, 04/87, pg 81, 4 pgs.*

Multipliers

Accurate, high-speed analog multipliers promise greater use of analog techniques. *Fleming, Tarlton, Associate Editor; EDN, 02/19/87, pg 57, 5.33 pgs.*

Multiprocessing

Debug system targets multiprocessor design. *Noelcke, Gus, Northwest Instrument Systems; Computer Design, 11/01/86, pg 105, 6.5 pgs.*

Multiuser computer systems

Three 32-bit chips boost multiuser performance. *Martin, Arlon G; Miller, Norman R, AT&T Technology Systems; Electronic Design, 11/27/86, pg 89, 6.5 pgs.*

N

Network analyzers/analysis

Bit-error-rate testers troubleshoot data links in real time. *Harold, Peter, European Editor; EDN, 02/05/87, pg 69, 5.66 pgs.*

Fuzzy logic allows creation of precise process controllers. *Guilamo, Pedro J, Bailey Controls Co; EDN, 04/15/87, pg 201, 3.5 pgs.*

IEEE 802.3 LAN testers and analyzers pinpoint network and equipment flaws. *Leibson, Steven H, Regional Editor; EDN, 04/30/87, pg 59, 6 pgs.*

Network architecture/design/design standards (nonlocal)

ISDN gains ground as needed ICs emerge. *Mokhoff, Nicolas, Staff Editor; Computer Design, 11/15/86, pg 43, 4.5 pgs.*

Networking ICs

Dense chips ease networking. *Cormier, Denny, Staff Editor; Digital Design, 01/87, pg 44, 4 pgs.*

Ethernet/CheaperNet chips: The power and the process. *Cormier, Denny, Staff Editor; Digital Design, 04/87, pg 87, 3 pgs.*

LAN ICs let you build networks for PCs. *Cormier, Denny, Regional Editor; EDN, 12/11/86, pg 136, 8.5 pgs.*

O

Op amps

Composite amplifiers yield high speed and low offset. *Williams, Jim, Linear Technology Corp; EDN, 01/22/87, pg 139, 11 pgs.*

Fast-settling op amps aid in data conversion. *Kitchin, Charles, et al, Analog Devices Semiconductor; EDN, 03/18/87, pg 185, 5.5 pgs.*

Flexible PGA designs require few components. *Kaniel, Akavia, Intech Inc; EDN, 01/22/87, pg 181, 5 pgs.*

Hybrid isolation amps zap price and voltage barriers. *Smith, Greg, Burr-Brown; Electronic Design, 12/11/86, pg 91, 4.5 pgs.*

Low-power op amp delivers precision at low signal levels. *Bowers, Derek F, Kapoor, Art, Precision Monolithics Inc; EDN, 01/08/87, pg 185, 5.5 pgs.*

Monolithic operational amplifiers. *Travis, Bill, Senior Editor; EDN, 11/13/86, pg 134, 12.5 pgs.*

Multiplexer-op amp IC opens up novel circuit possibilities. *Bitner, John, National Semiconductor; Electronic Design, 03/19/87, pg 139, 4.5 pgs.*

Power op amps solve deflection-yoke drive problems. *Scofield, Granger, Apex Microtechnology Corp; EDN, 02/19/87, pg 171, 6 pgs.*

Specially processed operational amplifiers meet rad-hard and high-temperature needs. *Wiegand, Jim, Associate Editor; EDN, 01/22/87, pg 75, 4.5 pgs.*

Wideband GaAs op amps push onto silicon's turf. *Staff; Electronics, 11/27/86, pg 77, 1 pg.*

Optical storage

Half-height 5¼-in. CD ROM to personalize data bases. *Moes, Robert J, Laser Magnetic Storage International; Electronic Products, 01/15/87, pg 46, 1 pgs.*

Magneto-optic memories begin to look like a good bet. *Cohen,*

Charles L, Staff Editor; Electronics, 04/16/87, pg 33, 1 pg.
Optical-disk drives target standard 5¼-in. sites. *Leibson, Steven H, Regional Editor; EDN, 12/25/86, pg 42, 9 pgs.*

The optical-disk industry gropes for standards. *McLeod, Jonah, Staff Editor; Electronics, 03/19/87, pg 82, 4 pgs.*

Optoelectronics

LCDs lead the assault on CRT's dominance. *Williams, Tom, Staff Editor; Computer Design, 11/01/86, pg 53, 5 pgs.*

Mercury bromide makes efficient visible light. *Costlow, Terry, Staff Editor; Electronic Design, 12/11/86, pg 28, 1 pg.*

Next step for fiber optics: The local loop. *Rosenberg, Robert, Staff Editor; Electronics, 11/27/86, pg 61, 4 pgs.*

Optical encoders are shrinking to satisfy position-sensing application requirements. *Ormond, Tom, Senior Editor; EDN, 11/27/86, pg 81, 4.33 pgs.*

Oscilloscopes

Analog scopes forge ahead by taking advantage of digital technology. *Milne, Bob, Staff Editor; Electronic Design, 11/27/86, pg 63, 5.5 pgs.*

Design steps improve effective resolution of digitizing scopes, waveform digitizers. *Everett, Chris, Regional Editor; EDN, 01/08/87, pg 61, 5.5 pgs.*

Digitizing scopes sweep away complex measuring problems. *White, David, Tektronix; Electronic Design, 11/27/86, pg 111, 5 pgs.*

Found! A practical way to turn out Josephson junction chips. *Weber, Samuel, Staff Editor; Electronics, 02/19/87, pg 49, 5 pgs.*

Scopes wield counter-timer for automatic measurements. *Baker, Cliff, Tektronix; Electronic Design, 11/13/86, pg 113, 4 pgs.*

P

PROM programmers/programming

PLD programmers. *Small, Charles H, Associate Editor; EDN, 03/31/87, pg 119, 11.5 pgs.*

Packaging/encapsulation/sealing

Chip-on-board technology chugs along. *Chin, Spencer, Staff Editor; Electronic Products, 03/01/87, pg 37, 3.5 pgs.*

Climbing pin counts, speed spur activity in IC packaging. *Chin, Spencer, Staff Editor; Electronic Products, 01/15/87, pg 16, 3.5 pgs.*

Curious package grabs lead in lead density. *Chin, Spencer, Staff Editor; Electronic Products, 02/01/87, pg 16, 1 pg.*

New lead scheme saves board space. *Lyman, Jerry, Staff Editor; Electronics, 01/08/87, pg 34, 0.5 pgs.*

Parallel processing

AI meets parallel processing. *Billstrom, David, Intel Scientific Computers; Teeter, John, Gold Hill Computers; Digital Design, 12/86, pg 38, 3 pgs.*

High-speed processor revamps bit-slice design. *Rauch, Ken, et al, Weitek; Computer Design, 11/01/86, pg 97, 4 pgs.*

How ApTec plans to break the I/O bottleneck. *Staff; Electronics, 11/13/86, pg 54, 3 pgs.*

Parallel processing. *Schindler, Max, Staff Editor; Electronic Design, 01/08/87, pg 90, 7 pgs.*

RISCs and parallel processors drive multiprocessing innovations. *Mokhoff, Nicolas, Staff Editor; Computer Design, 12/86, pg 55, 7 pgs.*

Structured programming makes parallel processing easier. *Squires, Michael, Sequent Computer Systems; Electronic Design, 11/20/86, pg 99, 3 pgs.*

Personal computers

AI general-purpose versus tagged machines. *Aseo, Joseph, Staff Editor; Digital Design, 02/87, pg 33, 3 pgs.*

Add-in facsimile boards enable users of PCs to transfer CAE graphics in real time. *Terry, Chris, Associate Editor; EDN, 03/04/87, pg 53, 2.66 pgs.*

Apple gives new Macintoshes the right stuff for CAE applications. *Gabay, Jon, Contributing Editor; Computer Design, 04/01/87, pg 22, 2 pgs.*

Apple goes after a bigger bite of the microcomputer market. *Wolfe, Alexander, Staff Editor; Electronics, 01/08/87, pg 98, 2 pgs.*

Digitizing instruments: Making a fair comparison. *Manieri, Lawrence J, Sequence; Electronic Design, 11/20/86, pg 121, 3.5 pgs.*

Extending the PC/AT bus. *Jones, Larry, Faraday Electronics;*

EDN TECHNICAL-ARTICLE DATABASE

- Digital Design*, 03/87, pg 90, 3 pgs.
How computer makers are making the most of the 80386. *McLeod, Jonah, Staff Editor; Electronics*, 11/27/86, pg 85, 2 pgs.
- Industry consortium starting X-Windows bandwagon. *Williams, Tom, Staff Editor; Computer Design*, 02/01/87, pg 45, 1.5 pgs.
- PC AT graphics must link performance and compatibility. *Williams, Tom, Staff Editor; Computer Design*, 02/01/87, pg 30, 2.5 pgs.
- PC platform simplifies STD bus development. *Finster, Ken, Micro/sys; Digital Design*, 03/87, pg 79, 2.5 pgs.
- PC-based CAE/CAD users turn to 32-bit solutions. *Goering, Richard, Staff Editor; Computer Design*, 04/15/87, pg 57, 12 pgs.
- Peripherals enhance 80386 design options. *Kumar, V Siva, Intel; Computer Design*, 03/01/87, pg 63, 5 pgs.
- Personal computers play host to board array processors. *Molinari, John; Preston, Craig, Data Translation; Electronic Design*, 04/16/87, pg 118, 4.5 pgs.
- Turning to NuBus, the Mac opens up for engineering. *Meng, Brita, Staff Editor; Digital Design*, 04/87, pg 21, 3 pgs.
- Why IBM's new PS line is good news to the industry. *Naegle, Tobias, Staff Editor; Young, Jeremy, Staff Editor; Electronics*, 04/16/87, pg 46, 2 pgs.
- Power converters**
Dc-to-dc converter family packs power into tight spots. *Cogger, Steven D, Vicor; Electronic Design*, 02/19/87, pg 81, 5 pgs.
- Power semiconductors**
Heat-removal devices hold semiconductors within operating ranges. *Travis, Bill, Senior Editor; EDN*, 12/11/86, pg 77, 6 pgs.
- Integrated current sensing simplifies MOSFET designs. *Young, Sean, International Rectifier Corp; EDN*, 11/13/86, pg 215, 5 pgs.
- Power op amps fan out, covering a wide spectrum of jobs and specifications. *Hefman, Gene, Electronic Design*, 11/20/86, pg 62, 8 pgs.
- Power semiconductors. *Goodenough, Frank, Staff Editor; Electronic Design*, 01/08/87, pg 146, 7 pgs.
- The competition explodes in power MOS FETs. *Waller, Larry, Staff Editor; Electronics*, 12/18/86, pg 97, 2 pgs.
- Power supplies**
External power supplies eliminate more than just heat from your design. *Everett, Chris, Regional Editor; EDN*, 04/15/87, pg 107, 4.66 pgs.
- Low-power ac-dc switchers follow high-density trends. *Waterman, Pamela J, Staff Editor; Electronic Design*, 04/87, pg 59, 5 pgs.
- Magnetic materials provide the final piece to the high-frequency switching-supply puzzle. *Small, Charles H, Associate Editor; EDN*, 03/04/87, pg 79, 2.33 pgs.
- Military power supplies look to escape customization trap. *Newhart, Milton, Electronic Design*, 11/20/86, pg 29, 5 pgs.
- Power level gives clue to switching supply design. *Bassett, John A, Computer Products; Electronic Design*, 03/87, pg 59, 5 pgs.
- User-configurable power supplies speed development. *Small, Charles H, Associate Editor; EDN*, 12/11/86, pg 240, 5 pgs.
- Printed circuits**
A speedy board laminate suits surface mounting. *Staff; Electronics*, 11/27/86, pg 79, 1 pg.
- Behavioral models and hardware modelers simulate pc boards containing VLSI devices. *Freeman, Eva, Associate Editor; EDN*, 11/13/86, pg 65, 5.33 pgs.
- Printed-circuit processing**
A speedy board laminate suits surface mounting. *Staff; Electronics*, 11/27/86, pg 79, 1 pg.
- Benchmarking PCB design systems. *Barrett, Richard; DeMaria, David, Racal-Redac; Computer Design*, 01/01/87, pg 77, 5.5 pgs.
- Printers**
Price drop triggers boom in laser printers. *Mayer, John H, Staff Editor; Computer Design*, 01/01/87, pg 96, 5 pgs.
- Probing systems/accessories**
A new tool dramatically cuts VLSI debugging time. *McLeod, Jonah, Staff Editor; Electronics*, 04/30/87, pg 51, 3 pgs.
- Processors, special-purpose (array, front-end, etc)**
Engineering computers. *Ohr, Stephan, Staff Editor; Electronic Design*, 01/08/87, pg 104, 7 pgs.
- Make your own low-cost 8051 emulator. *Horton, Eric P, Nova Scotia Power Corp; EDN*, 11/13/86, pg 193, 12 pgs.
- More needed in accelerators for multilevel simulation. *Bloom, Michael, Contributing Editor; Computer Design*, 04/01/87, pg 26, 7 pgs.
- One-board array processor eases data-intensive tasks. *Daukas, Stephen C; Preston, Craig, Data Translation; Electronic Design*, 04/30/87, pg 119, 4 pgs.
- Personal computers play host to board array processors. *Molinari, John; Preston, Craig, Data Translation; Electronic Design*, 04/16/87, pg 118, 4.5 pgs.
- Processor board recasts PC into 5-MIPS Unix workstation. *Lundell, Jon, et al, Opus Systems; Electronic Design*, 03/05/87, pg 119, 4.5 pgs.
- Programming a PC-based array processor. *Daukas, Stephen C, Data Translation; Digital Design*, 12/86, pg 47, 3.5 pgs.
- Production testing techniques**
Design-for-test techniques suit diverse applications. *Hess, Robert D, et al, Caedent Corp; EDN*, 04/15/87, pg 189, 4.5 pgs.
- Professional associations/issues**
CAE support groups boost designer productivity. *Poniatowski, Martin F, Canaan Computers; Computer Design*, 04/01/87, pg 37, 2 pgs.
- Computer pro says launch-on-warning is technically unsound. *Patton, Carole, Staff Editor; Electronic Design*, 12/11/86, pg 181, 1 pg.
- Former engineers parlay technical expertise into new careers. *Asbrand, Deborah, Staff Editor; EDN*, 12/25/86, pg 169, 3.5 pgs.
- Imaginers know high-tech ego tied to space. *Patton, Carole, Staff Editor; Electronic Design*, 02/19/87, pg 16, 0.5 pgs.
- "Information revolution" may not make jobs. *Patton, Carole, Staff Editor; Electronic Design*, 02/05/87, pg 16, 0.5 pgs.
- The whistle blower's burden: Public approval, corporate exile. *Asbrand, Deborah, Associate Editor; EDN*, 01/08/87, pg 296, 2.66 pgs.
- Programming**
An easier way to build a real-time expert system. *Wolfe, Alexander, Staff Editor; Electronics*, 03/05/87, pg 71, 3 pgs.
- CASE makes strides toward automated software development. *Suydam, William, Contributing Editor; Computer Design*, 01/01/87, pg 49, 11 pgs.
- Design tools race ahead...at a snail's pace. *Schindler, Max, Staff Editor; Electronic Design*, 04/30/87, pg 45, 2 pgs.
- EDIF format brings uniformity to CAE/CAD data. *Marx, Esther, Switzer, Hart, Motorola Inc; EDN*, 01/22/87, pg 153, 5.5 pgs.
- Integrated CAE tools ease software design. *Lehto, Steve; Besemer, Jim, Tektronix; Electronic Design*, 11/13/86, pg 151, 4 pgs.
- Microprocessor experts tackle benchmarking, support and architectural issues in open debate. *Marrin, Ken, Staff Editor; Computer Design*, 01/01/87, pg 21, 5.5 pgs.
- New tools ease development of bit-slice microcode. *Falk, Howard, Contributing Editor; Computer Design*, 02/15/87, pg 48, 2.5 pgs.
- Object-oriented database keeps the house in order. *McCaskey, John, Data General; Electronic Design*, 03/19/87, pg 129, 5 pgs.
- Parallel processing makes compiler advances. *Meng, Brita, Staff Editor; Digital Design*, 03/87, pg 61, 3.5 pgs.
- Smalltalk isn't meaningless chatter. *Ewing, Juanita J; Wirfs-Brock, Rebecca, Tektronix; Computer Design*, 01/15/87, pg 76, 3.5 pgs.
- Software analyzers team up to track down complex bugs. *Ableidinger, Bruce, Northwest Instrument Systems; Electronic Design*, 11/27/86, pg 125, 4 pgs.
- Software simulation programs power factory applications. *Cashen, Frank, Contributing Editor; Computer Design*, 02/01/87, pg 50, 2.5 pgs.
- Software-development environments grow interactive. *Suydam, William, Contributing Editor; Computer Design*, 04/15/87, pg 45, 5 pgs.
- Structured programming makes parallel processing easier. *Squires, Michael, Sequent Computer Systems; Electronic Design*, 11/20/86, pg 99, 3 pgs.
- Suddenly, work-station makers unite on a windowing standard. *Manuel, Tom, Staff Editor; Electronics*, 01/22/87, pg 58, 2 pgs.
- The Pentagon unveils aid for Ada. *Wolfe, Alexander, Staff Editor; Electronics*, 11/27/86, pg 31, 0.5 pgs.

EDN TECHNICAL-ARTICLE DATABASE

μ P simulators let you debug software on an IBM PC. *Wright, Maury, Regional Editor; EDN, 12/11/86, pg 196, 6.5 pgs.*

Prototyping boards/systems

Behavioral models and hardware modelers simulate pc boards containing VLSI devices. *Freeman, Eva, Associate Editor; EDN, 11/13/86, pg 65, 5.33 pgs.*

Tools help you retain the advantages of using breadboards in gate-array design. *Shear, David, Regional Editor; EDN, 03/18/87, pg 81, 4.33 pgs.*

R

Relays

Compact pc-board relays boost speed while trimming costs. *Bernhard, Bob, Electronic Design, 11/20/86, pg 39, 3.5 pgs.*

Resistors

Without standards, surface-mounted parts struggle for an audience. *Michaels, Ian, Electronic Design, 11/13/86, pg 101, 4 pgs.*

Rigid-disk drives

5 $\frac{1}{4}$ -in. rigid drives move to higher capacity applications. *Mayer, John H, Staff Editor; Computer Design, 04/15/87, pg 119, 6 pgs.*

A designer's decision: System or device level for peripheral interfaces? *Fifield, Brian, Emulex; Electronic Products, 11/17/86, pg 39, 3.5 pgs.*

A way to rewrite data on magneto-optic disks. *Staff; Electronics, 02/05/87, pg 76, 1.5 pgs.*

Half-height 5 $\frac{1}{4}$ -in. CD ROM to personalize data bases. *Moes, Robert J, Laser Magnetic Storage International; Electronic Products, 01/15/87, pg 46, 1 pgs.*

Intelligent peripheral interface standard permits data-transfer rates of 10M bytes/sec. *Wright, Maury, Regional Editor; EDN, 01/08/87, pg 105, 6 pgs.*

Optical-disk drives target standard 5 $\frac{1}{4}$ -in. sites. *Leibson, Steven H, Regional Editor; EDN, 12/25/86, pg 42, 9 pgs.*

Robotics

Microcontrollers teach robots to learn. *Cormier, Denny, Staff Editor; Digital Design, 03/87, pg 38, 3 pgs.*

S

Scientific computer systems

A work station that runs Unix and MS-DOS side by side. *Staff; Electronics, 11/13/86, pg 63, 3 pgs.*

Parallelism breeds a new class of supercomputers. *Mokhoff, Nicolas, Staff Editor; Computer Design, 03/15/87, pg 53, 10 pgs.*

Programming a PC-based array processor. *Daukas, Stephen C, Data Translation; Digital Design, 12/86, pg 47, 3.5 pgs.*

Vector processing comes to the desktop. *Manuel, Tom, Staff Editor; Electronics, 03/05/87, pg 69, 2 pgs.*

Screen printers

Quality and reliability screens impact the cost of owning ICs. *Denton, Donald L, Texas Instruments; Electronic Design, 11/20/86, pg 105, 4.5 pgs.*

Semicustom/custom ICs

A compiler for semicustom solutions. *Staff; Electronics, 02/05/87, pg 62, 3 pgs.*

ASIC verification: New tester breed builds design security. *Milne, Bob, Staff Editor; Electronic Design, 04/16/87, pg 71, 7 pgs.*

Analog arrays speed design and lower cost of uhf chips. *Heyes, Gary L; Shier, John S, VTC; Electronic Design, 12/11/86, pg 119, 4 pgs.*

Analog-IC arrays can field board-level circuitry. *Moore, Bruce D, Raytheon; Electronic Products, 02/01/87, pg 43, 3 pgs.*

Analog-cell libraries stretch for standard-product performance. *Goodenough, Frank, Staff Editor; Electronic Design, 04/87, pg 29, 8 pgs.*

Board designers benefit from cell-based ICs. *Collett, Ronald, Staff Editor; Digital Design, 12/86, pg 52, 4 pgs.*

Built-in testability helps to clear some stubborn IC bottlenecks. *Seaton, John; Chu, Louis, Tangent Systems; Electronic*

Design, 11/27/86, pg 101, 4 pgs.

Complex circuits sharpen need for faster on-chip testing. *Bursky, Dave, Staff Editor; Electronic Design, 11/13/86, pg 38, 2 pgs.*

ECL arrays sprint to the forefront. *Collett, Ron, Staff Editor; Digital Design, 04/87, pg 35, 6 pgs.*

Fast, low-power logic array unites CMOS and bipolar. *Lin, Liang-Tsai; Spehn, Richard, Applied Micro Circuits; Electronic Design, 04/16/87, pg 82, 5.5 pgs.*

GaAs cells simplify high-speed communications. *Schappacher, Jerry B; Davis, Richard T, Harris Microwave Semiconductor; Digital Design, 02/87, pg 57, 3 pgs.*

Here come the tools to design 50,000-gate ASICs. *McLeod, Jonah, Staff Editor; Electronics, 02/05/87, pg 55, 4 pgs.*

Improved process yields densest ECL-gate array. *Drobac, Stan, Fairchild Semiconductor; Electronic Design, 04/30/87, pg 97, 5 pgs.*

LSI Logic's big bag of ASIC design tools. *Staff; Electronics, 02/05/87, pg 59, 3 pgs.*

Layout tool streamlines full-custom IC design. *Staff; Electronics, 12/18/86, pg 80, 3 pgs.*

Linear array captures spirit of discrete design. *Ritmanich, Will; Gill, Harry, Raytheon, Semiconductor Division; Electronic Design, 01/22/87, pg 99, 4.5 pgs.*

Linear-array semicustom ICs compete at high volumes. *Kadis, Albert L; Soliven, Marcello, Exar; Electronic Design, 04/87, pg 43, 4.5 pgs.*

Mixed analog/digital technologies pack complete systems on-chip. *Martin, Steven L, Contributing Editor; Computer Design, 04/01/87, pg 39, 6 pgs.*

Motorola grabs lead in ECL density, using Mosaic III. *Cole, Bernard C, Staff Editor; Electronics, 02/19/87, pg 71, 3 pgs.*

PLDs provide fast lane to semicustom designs. *Martin, Steven L, Contributing Editor; Computer Design, 03/01/87, pg 28, 6.5 pgs.*

Parameterizable cells strike middle ground between fixed and compiled cells. *Bloom, Michael, Contributing Editor; Computer Design, 11/01/86, pg 24, 5.5 pgs.*

Partition custom ICs along technology lines. *Huehne, Karl J, United Technologies Microelectronics Center; EDN, 03/04/87, pg 163, 4.5 pgs.*

Second-generation compilers optimize semicustom circuits. *Rowson, Jim; Trimberger, Steve, VLSI Technology; Electronic Design, 02/19/87, pg 92, 5 pgs.*

Silicon compilation to win more users and vendors. *Uvelli, David A; Whitner, Stephen M, Seattle Silicon; Electronic Products, 01/15/87, pg 44, 2 pgs.*

Standard cells raising their sights to VLSI. *Gabay, Jon, Staff Editor; Electronic Products, 01/15/87, pg 31, 4 pgs.*

Standard-cell libraries grow in complexity. *Kates, Geoffrey, Contributing Editor; Computer Design, 01/01/87, pg 30, 3.5 pgs.*

Tool simulates ASICs made from analog and digital cells. *Caldwell, Jim, Sierra Semiconductor; Electronic Design, 11/13/86, pg 121, 3 pgs.*

Versatile schematic capture set caters to custom-IC designers. *Benedict, J Stanley; Ruotsi, Wendell, CAECO; Electronic Design, 03/05/87, pg 96, 4.5 pgs.*

EDN TECHNICAL-ARTICLE DATABASE

ard, Staff Editor; *Computer Design*, 01/01/87, pg 37, 5 pgs.
Hardware modeling: The real stuff's role in system simulation. Leonard, Milt, Staff Editor; *Electronic Products*, 04/15/87, pg 37, 4 pgs.

Mixed analog/digital simulation: Here it comes. Collett, Ronald E, Staff Editor; *Digital Design*, 12/86, pg 24, 1 pg.

Mixed-mode simulators bridge the gap between analog and digital design. Bloom, Michael, Contributing Editor; *Computer Design*, 01/15/87, pg 51, 11.5 pgs.

Modified simulation files meet tester needs. Den Beste, William E, Test Systems Strategies; *Computer Design*, 02/01/87, pg 85, 4 pgs.

More needed in accelerators for multilevel simulation. Bloom, Michael, Contributing Editor; *Computer Design*, 04/01/87, pg 26, 7 pgs.

Simulator environment handles mixed designs. Sarin, Harish, et al, Daisy Systems; *Computer Design*, 01/15/87, pg 67, 5.5 pgs.

Software models simulate 68010 and its peripherals. Billowitch, William D, Quadtree; *Electronic Design*, 02/05/87, pg 113, 4.5 pgs.

Software simulation programs power factory applications. Cashen, Frank, Contributing Editor; *Computer Design*, 02/01/87, pg 50, 2.5 pgs.

Tool simulates ASICs made from analog and digital cells. Caldwell, Jim, Sierra Semiconductor; *Electronic Design*, 11/13/86, pg 121, 3 pgs.

µP simulators let you debug software on an IBM PC. Wright, Maurry, Regional Editor; *EDN*, 12/11/86, pg 196, 6.5 pgs.

Sockets

Socket twists add versatility to a designer's repertoire. Costlow, Terry, Staff Editor; *Electronic Design*, 03/87, pg 31, 6.5 pgs.

Speech synthesis/recognition

Consider standard features when selecting codecs. Barnes, Brady, Inter-Tel; *EDN*, 04/30/87, pg 211, 6 pgs.

Speech technology finding real applications. Martin, Steven L, Contributing Editor; *Computer Design*, 03/01/87, pg 38, 4.5 pgs.

Standards

Implementations may blossom for design interface standards. Goering, Richard, Staff Editor; *Computer Design*, 02/01/87, pg 24, 4 pgs.

Open systems free users from hardware constraints. White, Lisa D, Cadnetix; *Computer Design*, 03/15/87, pg 73, 5 pgs.

Standard proposal opens can of WORMs. Meng, Brita, Staff Editor; *Digital Design*, 01/87, pg 26, 1 pg.

The optical-disk industry gropes for standards. McLeod, Jonah, Staff Editor; *Electronics*, 03/19/87, pg 82, 4 pgs.

X-Windows potential aid to network connectivity. Williams, Tom, Staff Editor; *Computer Design*, 03/15/87, pg 44, 2.5 pgs.

Surface-mounting devices/techniques

Surface-mounting poises for a military takeover. Reynolds, Robert A, Texas Instruments; *Electronic Design*, 03/87, pg 43, 3 pgs.

Without standards, surface-mounted parts struggle for an audience. Michaels, Ian, *Electronic Design*, 11/13/86, pg 101, 4 pgs.

Switches

Ubiquitous conductive-rubber switches adapt to fit your application and budget. Conner, Margery, Regional Editor; *EDN*, 04/30/87, pg 91, 4 pgs.

Switching circuits

Integrated current sensing simplifies MOSFET designs. Young, Sean, International Rectifier Corp; *EDN*, 11/13/86, pg 215, 5 pgs.

Magnetic compensation gives new life to transformer-based SLICs. Stacey, Chris, National Semiconductor Corp; *EDN*, 04/30/87, pg 149, 5 pgs.

T

TTL logic

Use of check list prevents problems in TTL systems. Sokal, Nathan O, Design Automation Inc; *EDN*, 11/13/86, pg 253, 8 pgs.

Technology/research, other

Does Catalyst have the key to smart cards? Staff; *Electronics*,

12/18/86, pg 59, 4 pgs.

ECL gains ground in battle against CMOS. Leibowitz, Bob; Taylor, Greg, Bipolar Integrated Technology; *Computer Design*, 04/01/87, pg 91, 5 pgs.

Executive outlook: No technology slowdown. Staff; *Electronics*, 12/18/86, pg 86, 10 pgs.

Here comes the billion-transistor IC. Cole, Bernard C, Staff Editor; *Electronics*, 04/02/87, pg 81, 5 pgs.

Motorola grabs lead in ECL density, using Mosaic III. Cole, Bernard C, Staff Editor; *Electronics*, 02/19/87, pg 71, 3 pgs.

Smart card: Will it create a billion dollar IC business? Barney, Clifford, Staff Editor; *Electronics*, 12/18/86, pg 55, 4 pgs.

Superconductor R&D moves ahead on several world fronts. Iversen, Wesley R, Staff Editor; *Electronics*, 02/19/87, pg 54, 3 pgs.

Use statistics to test communications systems efficiently. Cobb, R F, Harris Corp; *EDN*, 01/08/87, pg 143, 9 pgs.

West Germany grabs the lead in X-ray lithography. Gosch, John, Staff Editor; *Electronics*, 02/05/87, pg 78, 3 pgs.

Telecommunications

Digital video data can now travel by Taxi. Vesuna, Sarosh; Price, Simon, Advanced Micro Devices; *Computer Design*, 02/01/87, pg 79, 4.5 pgs.

ISDN gains ground as needed ICs emerge. Mokhoff, Nicolas, Staff Editor; *Computer Design*, 11/15/86, pg 43, 4.5 pgs.

ISDN terminals simplify data transmissions. O'Toole, Tony, Advanced Micro Devices; *EDN*, 01/22/87, pg 167, 8 pgs.

Modem prices drop as chips absorb more functions. Chester, Michael, Staff Editor; *Electronic Products*, 03/01/87, pg 28, 6 pgs.

Variety reigns supreme in ISDN chip sets. Spadaro, Joseph J, Staff Editor; *Electronic Products*, 03/15/87, pg 55, 3.5 pgs.

Terminal controllers

Token-ring bus controller simplifies network design. Erickson, Ivan, Motorola Inc; *EDN*, 04/30/87, pg 159, 7.5 pgs.

Terminals

Selecting a low-cost color graphics terminal. Hershiser, Don; Ireland, Tom, Tektronix; *Electronic Design*, 11/20/86, pg 127, 4 pgs.

Timer ICs/circuits

The quickening (beat) of the quartz crystal. Chin, Spencer, Staff Editor; *Electronic Products*, 11/03/86, pg 65, 4 pgs.

Touch-screen devices

A practical guide to programming for touch screens. Logan, James, Micro Touch Systems; *Electronic Products*, 04/01/87, pg 53, 2 pgs.

Hardware choices in touch screen design. Leland, Brad; Boyd, Ray, John Fluke Manufacturing; *Electronic Products*, 04/01/87, pg 50, 2.5 pgs.

Track/hold amps

Fast A/D converters accelerate the development of sample/hold amplifiers. Fleming, Tarlton, Associate Editor; *EDN*, 03/31/87, pg 59, 4 pgs.

Transformers

Magnetic materials provide the final piece to the high-frequency switching-supply puzzle. Small, Charles H, Associate Editor; *EDN*, 03/04/87, pg 79, 2.33 pgs.

Transmitter/receiver circuits

Synchronous-network circuit boosts network flexibility. Vesuna, Sarosh N, Advanced Micro Devices; *EDN*, 11/13/86, pg 231, 6 pgs.

Trigger circuits

Consider how TTL outputs work during power-downs. Taylor, Mark A, Hewlett-Packard Co; *EDN*, 11/27/86, pg 221, 3 pgs.

V

Video

A moment in the sun for TI's 34010 graphics processor. Cole, Vera Jean, Staff Editor; *Electronic Products*, 03/15/87, pg 19, 2 pgs.

Interface options enhance fast video converter. Price, John; Morgan, Dennis, Motorola Semiconductors; *Electronic Products*, 12/15/86, pg 31, 4 pgs.

Video codecs send full-motion CGA images over the phone.

Solve special decoupling problems

MICRO/Q capacitors with special pinout configurations give you design flexibility you can't get with standard techniques to solve decoupling and routing problems. Choose MICRO/Q for 8-, 16-, or 32-bit microprocessors, ECL devices, and many other devices where power and ground are not at conventional positions. You'll get superior noise suppression and design ease.

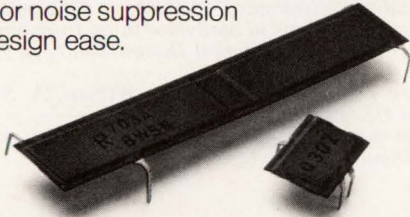

CIRCLE NO 14

Improve existing board performance

MICRO/Q capacitors can be retrofitted to solve noise problems on existing boards. Because MICRO/Q caps share mounting holes with existing IC pins, no board redesign is required. Effective decoupling becomes a matter of adding one insertion step.



CIRCLE NO 53

Simplify board layout and get a choice

MICRO/Q ceramic decoupling capacitors share board mounting holes with IC pins. You don't have to waste space on additional holes, as you do for standard caps. Simplifying board design opens up two very attractive options. Add more active devices with increased packaging density in the same space, or design the same package on a smaller board.

Either way, you win with MICRO/Q.

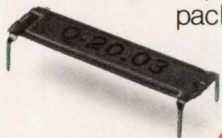

CIRCLE NO 92

Design noise out of PGA and LCC packages

PGA MICRO/Q capacitors provide effective solutions to noise problems with VLSI PGA packages and LCC sockets. Design effective decoupling on complex multi-layer board layouts by fitting PGA MICRO/Q capacitors under PGA or LCC sockets. They occupy no additional board space and provide the low-inductance, high-frequency decoupling required by today's VLSI packages. Available in a range of pinout configurations.

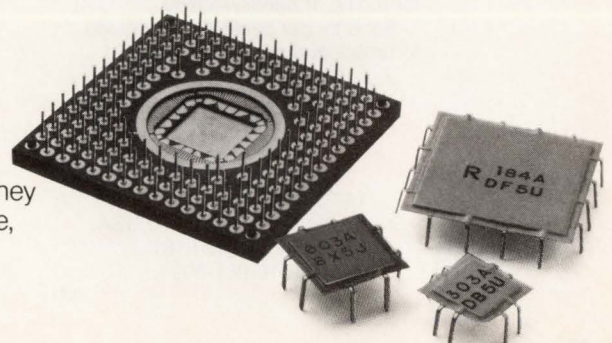

CIRCLE NO 131

*noise problems...
space problems...*

TOP THIS.

Rogers MICRO/Q® decoupling capacitors reduce voltage noise spikes in IC's, often by as much as a factor of ten. And since they're easily mounted *underneath* the IC, MICRO/Q capacitors conserve valuable board real estate, too. A range of configurations makes MICRO/Q flat capacitors especially effective at reducing noise on:

- 64K RAMS
- Video RAMS
- EPROMS
- Microprocessors
- Bus drivers/buffers
- Other IC's where noise spikes create performance problems
- Boards that need EMI/RFI fix
- CAD/CAM/CAE
- Telecommunications
- Minicomputers
- Printers and copiers
- Single-board computers

Find out how MICRO/Q capacitors reduce noise and provide better board density. Get the full story and a free sample. Call a Rogers MICRO/Q Product Specialist today, at (602) 967-0624.



ROGERS

Rogers Corporation
Circuit Components Division
2400 South Roosevelt Street
Tempe, AZ 85282

Distributed in the U.S. by the Genie Group; in Europe by Mektron NV, Gent, Belgium; in Brazil by Rogers Coselbra, São Paulo.

CIRCLE NO 100

Come
where the
power
is.

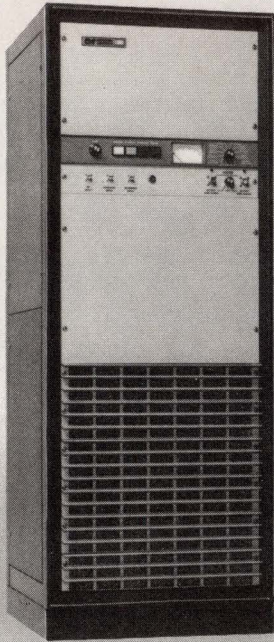

Broadband capability from some very powerful amplifiers. Power from one watt to ten kilowatts. Frequencies from 10 kHz to 1 GHz. Gain that's flat and reliable.

For example, our Model 2000L, shown above, delivers 2000 watts minimum cw saturated power over a bandwidth of 10 kHz to 220 MHz. In pulse mode you can almost double that rated output.

We rate most of our amplifiers by minimum power—users can be certain that their 10-watt or 2000-watt amplifier will always deliver at least its rated output at any point in its frequency band.

AR amplifiers are unconditionally stable, immune even to worst-case load mismatch without damage or shutdown. The full bandwidth is instantly available—there's no need for tuning or bandswitching.

Send for our booklet, "Your guide to broadband power amplifiers."

AR AMPLIFIER
RESEARCH

160 School House Road
Souderton, PA 18964-9990 USA
Phone 215-723-8181
TWX 510-661-6094

8288

EDN DATABASE

Cormier, Denny, Staff Editor; Digital Design, 04/87, pg 93, 2 pgs.

Video hybrid digitizes images at RS-170 rates. *Hansford, Alan, Analog Devices; Digital Design, 03/87, pg 50, 3 pgs.*

Vision systems

Applications determine architectures for imaging. *Wilson, Andrew C, Staff Editor; Digital Design, 04/87, pg 51, 3 pgs.*

High-powered desktop image processing gets closer. *Staff; Electronics, 02/19/87, pg 62, 3 pgs.*

How long will it take image processing to blast off? *Lineback, J Robert, Staff Editor; Electronics, 02/19/87, pg 65, 2 pgs.*

Imaging boards put algorithms in hardware to up throughput. *Weir, Tony, Vision Systems; Digital Design, 03/87, pg 55, 3 pgs.*

Imaging hardware gets software support. *Wilson, A, Staff Editor; Digital Design, 12/86, pg 21, 1 pg.*

Solid state sensors capture bigger images. *Wilson, Andrew C, Staff Editor; Digital Design, 12/86, pg 43, 2 pgs.*

W

Wire/cable

Power planes increase wire-wrapped circuit speeds. *Visco, P Anthony, Mupac Corp; EDN, 11/27/86, pg 225, 3 pgs.*

EDN INFO CARDS

The Fastest,
Most Cost-Effective Way
to Generate Sales Leads!

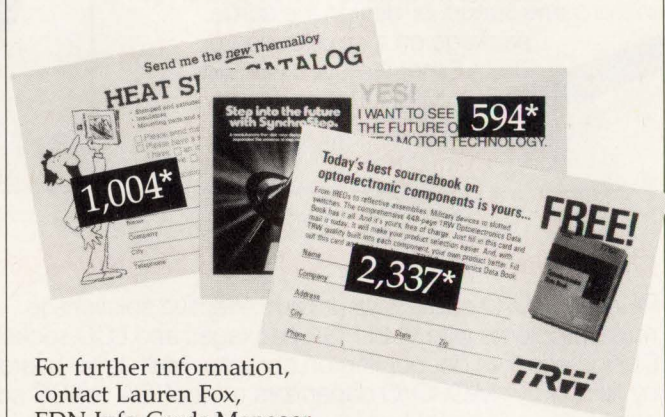

For further information,
contact Lauren Fox,
EDN Info Cards Manager,
at (203) 328-2580.

* Numbers represent actual
responses

New Data Acquisition Systems Communicate with Microprocessors Over 4 Wires

As board space and semiconductor package pins become more valuable, serial data transfer methods between microprocessors (MPUs) and their peripherals become more and more attractive. Not only does this save lines in the transmission medium, but, because of the savings in package pins, more function can be packed into both the MPU and the peripheral. Users are increasingly able to take advantage of these savings as more MPU manufacturers develop serial ports for their products^[1-3]. However, peripherals which are able to communicate with these MPUs must be available in order for users to take full advantage. Also, MPU serial formats are not standardized so not all peripherals can talk to all MPUs.

The LTC1090 Family

A new family of 10-bit data acquisition circuits has been developed to communicate over just 4 wires to the recently developed MPU synchronous serial formats as well as to MPUs which do not have serial ports. These circuits feature software configurable analog circuitry including analog multiplexers, sample and holds, bipolar and unipolar conversion modes. They also have serial ports which can be software configured to communicate with virtually any MPU. Even the lowest grade device features guaranteed ± 0.5 LSB linearity over the full operating temperature range. Reduced span operation (down to 200mV), accuracy over a wide temperature range and low power single supply operation make it possible to locate these circuits near remote sensors and transmit digital data back through noisy media to the MPU. Figure 1 shows a typical hookup of the LTC1090, the first member of this data acquisition family. For more detail, refer to the 24-page LTC1090 data sheet.

Included are eight analog inputs which can common-mode to both supply rails. Each can be configured for unipolar or bipolar conversions and for single-ended or differential inputs by sending a data input (D_{IN}) word from the MPU to the LTC1090 (Figure 1).

Both the power supplies are bypassed to analog ground. The V^- supply allows the device to operate with inputs which swing below ground. In single supply applications it can be tied to ground.

The span of the A/D converter is set by the reference inputs which, in this case, are driven by a 2.5V LT1009 which gives an LSB step size of 2.5mV. However, any reference voltage within the power supply range can be used.

The 4 wire serial interface consists of an active low chip select pin (\overline{CS}), a shift clock (SCLK) for synchronizing the data bits, a data input (D_{IN}) and a data output (D_{OUT}). Data is transmitted and received simultaneously (full duplex), minimizing the transfer time required.

The external ACLK input controls the conversion rate and can be tied to SCLK as in Figure 1. Alternatively, it can be derived from the MPU system clock (e.g., the 8051 ALE pin) or run asynchronously. When the ACLK pin is driven at 2MHz, the conversion time is 22 μ s.

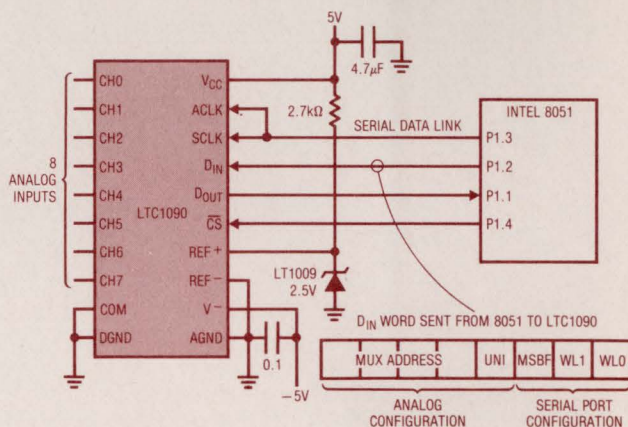

Figure 1. A Typical Hookup of the LTC1090

Advantages of Serial Communications

The LTC1090 can be located near the sensors and serial data can be transmitted back from remote locations through isolation barriers or through noisy media.

Several LTC1090s can share the serial interface and many channels of analog data can be digitized and sent over just a few digital lines (see Figure 2). This could, for example, be used to simplify the communications between an instrument and its front panel.

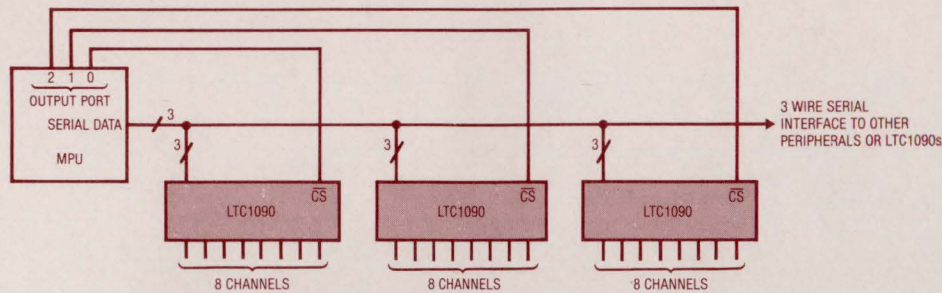

Figure 2. Several LTC1090s Sharing One 3 Wire Serial Interface

Using fewer pins for communication makes it possible to pack more function into a smaller package. LTC1090 family members are complete systems being offered in packages ranging from 20 pins to 8 pins (e.g., LTC1091).

Speed is Usually Limited by the MPU

A perceived disadvantage of the serial approach is speed. However, the LTC1090 can transfer a 10-bit A/D result in $10\mu\text{s}$ when clocked at its maximum rate of 1MHz. With the minimum conversion time of $22\mu\text{s}$, throughput rates of 30kHz are possible. In practice, the serial transfer rate is usually limited by the MPU, not the LTC1090. Even so, throughput rates of 20kHz are not uncommon when serial port MPUs are used. For MPUs without serial ports, the transfer time is somewhat longer because the serial signals are generated with software. For example, with the Intel 8051 running at 12MHz, a complete transfer takes $80\mu\text{s}$. This makes possible throughput rates of approximately 10kHz.

Talking to Serial Port MPUs

By accommodating a wide variety of transfer protocols, the LTC1090 is able to talk directly to almost all synchronous serial formats. The last 3 bits of the LTC1090 data input (D_{IN}) word define the serial format. The MSBF bit determines the sequence in which the A/D conversion result is sent to the processor (MSB or LSB first). The two bits WL1 and WL0 define the word length of the LTC1090 data output word. Figure 3 shows several popular serial formats and the appropriate D_{IN} word for each. Typically a complete data transfer cycle takes only about 15 lines of processor code.

Talking to MPUs without Serial Ports

The LTC1090 talks to serial port processors but works equally well with MPUs which do not have serial ports. In these cases, \overline{CS} , SCLK and D_{IN} are generated with software on 3 port lines. D_{OUT} is read on a fourth. Figure 3 shows the appropriate D_{IN} word for communicating with MPU parallel ports. Figure 1 shows a 4 wire interface to the popular Intel 8051. A complete transfer takes only 33 lines of code.

Sharing the Serial Interface

No matter what processor is used, the serial port can be shared by several LTC1090s or other peripherals (see Figure 2). A sepa-

rate \overline{CS} line for each peripheral determines which is being addressed.

Conclusions

The LTC1090 family provides data acquisition systems which communicate via a simple 4 wire serial interface to virtually any microprocessor. By eliminating the parallel data bus they are able to provide more function in smaller packages, right down to 8 pin DIPs. Because of the serial approach, remote location of the A/D circuitry is possible and digital transmission through noisy media or isolation boundaries is made easier without a great loss in speed.

Hardware and software is available from the factory to interface the LTC1090 to most popular MPUs. The LTC1090 data sheet contains source code for several microprocessors. Further applications assistance is available by calling the factory.

| LTC1090 D_{IN} Word | | | | | | | | | |
|--|---------------------|----------------------|---|---|---|---|------|-----|-----|
| Type of Interface | LTC1090 Data Format | Analog Configuration | | | | | MSBF | WL1 | WL0 |
| All Parallel Port MPUs | MSB First 10 Bits | X | X | X | X | X | 1 | 0 | 1 |
| National MICROWIRE* MICROWIRE/PLUS* | MSB First 12 Bits | X | X | X | X | X | 1 | 1 | 0 |
| Motorola SPI | MSB First 16 Bits | X | X | X | X | X | 1 | 1 | 1 |
| Hitachi Synchronous SCI | LSB First 16 Bits | X | X | X | X | X | 0 | 1 | 1 |
| TI TMS7000 Serial Port | | X | X | X | X | X | 0 | 1 | 1 |

Figure 3. The LTC1090 Accommodates Both Parallel and Serial Ports

*MICROWIRE and MICROWIRE/PLUS are trademarks of National Semiconductor Corp.

Bibliography

- [1] Aleaf, Abdul, and Richard Lazovick, "Microwire/Plus," National Semiconductor, Santa Clara, CA, Wescon '86, Session 21.
- [2] Derkach, Donald J., "Serial Data Transmission in MCU Systems," RCA Solid State, Somerville, NJ, Wescon '86, Session 21.
- [3] Kalinka, Theodore J., "Versatile Serial Peripheral Interface (SPI)," RCA Solid State, Somerville, NJ, Wescon '86, Session 21.

For LTC1090 literature call **800-637-5545**. For help with an application call (408) 432-1900, Ext. 361.

Linear Technology Corporation
1630 McCarthy Boulevard
Milpitas, CA 95035-7487



DESIGN IDEAS

EDITED BY TARLTON FLEMING

Add balanced signal to a variable voltage

Robert D Walker
Dowty RFL Industries, Boonton, NJ

To provide pulse-width modulation of a control variable, some process-control circuits add a triangular waveform to the control-variable voltage. (The low signal frequencies of these circuits precludes the use of ac-coupling capacitors.) By first considering a conventional way of combining the sawtooth and control voltages (Fig 1), you'll better appreciate the circuit of Fig 2, in which the oscillator's dc component continuously tracks the input voltage.

Output V_3 in this traditional circuit is

$$V_3 = \left(\frac{R_2}{R_1 + R_2}\right)V_1 + \left(\frac{R_1}{R_1 + R_2}\right)V_2,$$

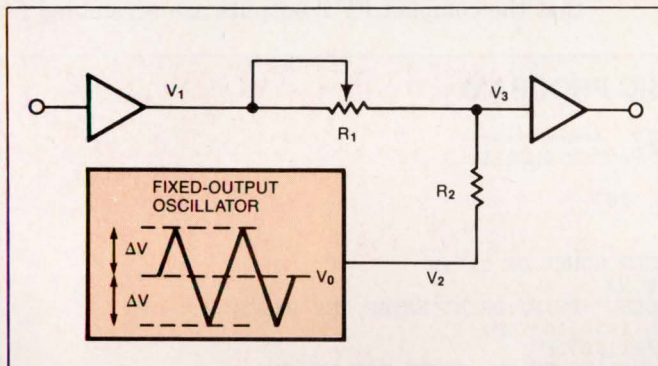

Fig 1—In this circuit, which is similar to Fig 2 except that the oscillator output is fixed, the sawtooth's dc component creates an offset error in V_3 .

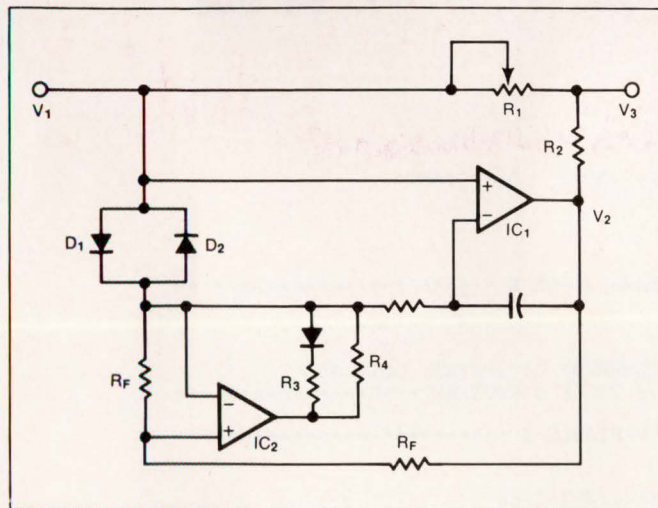

Fig 2—This circuit combines the input voltage V_1 with a sawtooth waveform in which the sawtooth's dc component matches and tracks V_1 .

where V_1 is the control variable (a slowly varying dc signal), and V_2 is the sawtooth-oscillator output $V_0 \pm \Delta V$. The dc component of V_3 is

$$V_{3(DC)} = \left(\frac{R_2}{R_1 + R_2}\right)V_1 + \left(\frac{R_1}{R_1 + R_2}\right)V_0.$$

You can see that the oscillator's fixed dc component, V_0 , contributes an offset-error term that varies as you adjust R_1 . Because this offset error affects V_3 , it appears in the system as a change in the control variable V_1 . This spurious change in V_3 can be significant: As R_1 varies from zero to full value, the shift is

$$V_{3(DC)} = \frac{R_1}{R_1 + R_2}(V_1 - V_0).$$

As an added drawback, you have to provide compensation for the signal attenuation of the resistors.

In Fig 2, the oscillator's dc component V_0 tracks the input V_1 , thereby eliminating the offset error in V_3 . Comparator IC₂ changes state each time V_2 differs from V_1 by more than one diode drop, creating a linear sawtooth waveform V_2 at the output of integrator IC₁:

$$V_2 = V_1 \pm V_D + \frac{1}{2}\Delta V_D,$$

where V_D is the average forward-voltage drop for diodes D_1 and D_2 ($\frac{1}{2}(V_{D1} + V_{D2})$), and ΔV_D is the mismatch in diode drops.

Output V_3 still has an error component caused by ΔV_D :

$$V_3 = V_1 + \left(\frac{R_1}{R_1 + R_2}\right)V_D + \frac{1}{2}\left(\frac{R_1}{R_1 + R_2}\right)\Delta V_D.$$

To minimize this error, you must select diodes with a narrow spread of forward voltages. Rectifier diodes such as 1N4000s are well suited to this purpose; they have a typical spread of 20 mV at 1 mA. To further minimize error, you must select the resistor values of R_3 and R_4 to produce equal current in the diodes D_1 and D_2 over V_1 's anticipated range; that is, the current in D_2 when the comparator output is high should equal the current in D_1 when the comparator is low. **EDN**

To Vote For This Design, Circle No 746

Program aids analysis of FFT algorithms

Richard G Lyons
SEDC, Sunnyvale, CA

When engineers use standard software routines or hardware devices to perform FFTs, they're mainly concerned with providing the proper inputs and correctly interpreting the outputs. When developing non-standard FFTs for harmonic-analysis or DSP applications, however, you'll find it necessary to analyze and modify the internal "twiddle factors" inherent in the FFT.

The Basic program of **Listing 1** contains an algorithm for analyzing the internal signal flows in an FFT by monitoring the angle associated with each of the complex twiddle factors. Often, you have to determine the twiddle factors for a specific subset of the butterflies in a given N-point FFT. (In the array of twiddle factors

for smaller FFTs, the pattern is apparent, but the pattern becomes bewildering as you increase the FFT size.) The program returns the phase angles associated with twiddle factors of an arbitrary butterfly.

Further, the program directly obtains twiddle-factor angles for any or all butterflies in an arbitrary N-point FFT; you needn't re-evaluate the equations of the discrete Fourier transform each time you change the size of the FFT. The program's algorithm draws upon the following characteristics of the Decimation-In-Time (DIT) radix-2 FFT algorithm:

- An N-point FFT has M stages ($M = \log_2 N$), in which each stage is composed of N/2 butterflies.
- A single butterfly is defined as shown in (**Fig 1a**).
- As defined in **Fig 1a**, a single butterfly ensures that the complex FFT outputs are scrambled (in

LISTING 1—BASIC PROGRAM

```

30 ' ***** PROGRAM: BUTTER.FLY *****
40 ' CALCULATES FFT TWIDDLE FACTOR ANGLES
50 '
60 ' R.G. LYONS/SEDC (JUNE 1987)
70 '
80 CLS 'CLEAR SCREEN
90 INPUT "ENTER SIZE OF THE FFT (INTEGER POWER OF 2)";N
100 GOSUB 320: 'FIND M [LOG(base 2) OF N]
110 PRINT:PRINT "THE FFT HAS";M;" STAGES.":PRINT:PRINT"ENTER THE RANGE";
120 PRINT " OF FFT STAGES OF INTEREST, ( 1 -to-";M;")"
130 INPUT "[SEPARATE BY A COMMA]";JSTART,JSTOP
140 PRINT:PRINT "THERE ARE";N/2;" BUTTERFLIES/STAGE. ENTER THE RANGE"
150 PRINT "OF BUTTERFLIES OF INTEREST, ( 1 -to-";(N/2);")"
160 INPUT "[SEPARATE BY A COMMA]";KSTART,KSTOP:PRINT:PRINT
170 LPRINT "TWIDDLE FACTORS FOR";N;"-POINT FFT"
180 LPRINT "J IS THE STAGE INDEX ( FROM 1 TO";M;") OF THE FFT,"
190 LPRINT "K IS THE BUTTERFLY INDEX ( FROM 1 TO";(N/2);") FOR EACH STAGE."
200 FOR J=JSTART TO JSTOP
210 LPRINT:LPRINT
220 FOR K=KSTART TO KSTOP
230 Z=INT(((2^J)*(K-1))/N)
240 GOSUB 390: ' BIT REVERSE Z
250 AUP=ZBR
260 ART=ZBR+N/2
270 LPRINT "J=";J;"K=";K;" Aup=";AUP;" Art=";ART
280 NEXT K
290 NEXT J
300 END
310 '
320 '***** FIND LOG(base 2) OF N *****
330 FOR M=2 TO 40
340 IF 2^M=N THEN RETURN
350 NEXT M
360 PRINT:PRINT "SELECTED N IS NOT A POWER OF 2!":PRINT: GOTO 90
370 '***** END OF LOG(base 2) OF N ROUTINE *****
380 '
390 '***** BIT REVERSE VARIABLE Z. *****
400 ZBR=0
410 FOR KK=(M-2) TO 0 STEP -1
420 IF Z>=2^K THEN ZBR=ZBR+2^(M-KK-2):Z=Z-2^K
430 NEXT KK
440 RETURN
450 '***** END OF BIT REVERSE ROUTINE *****

```

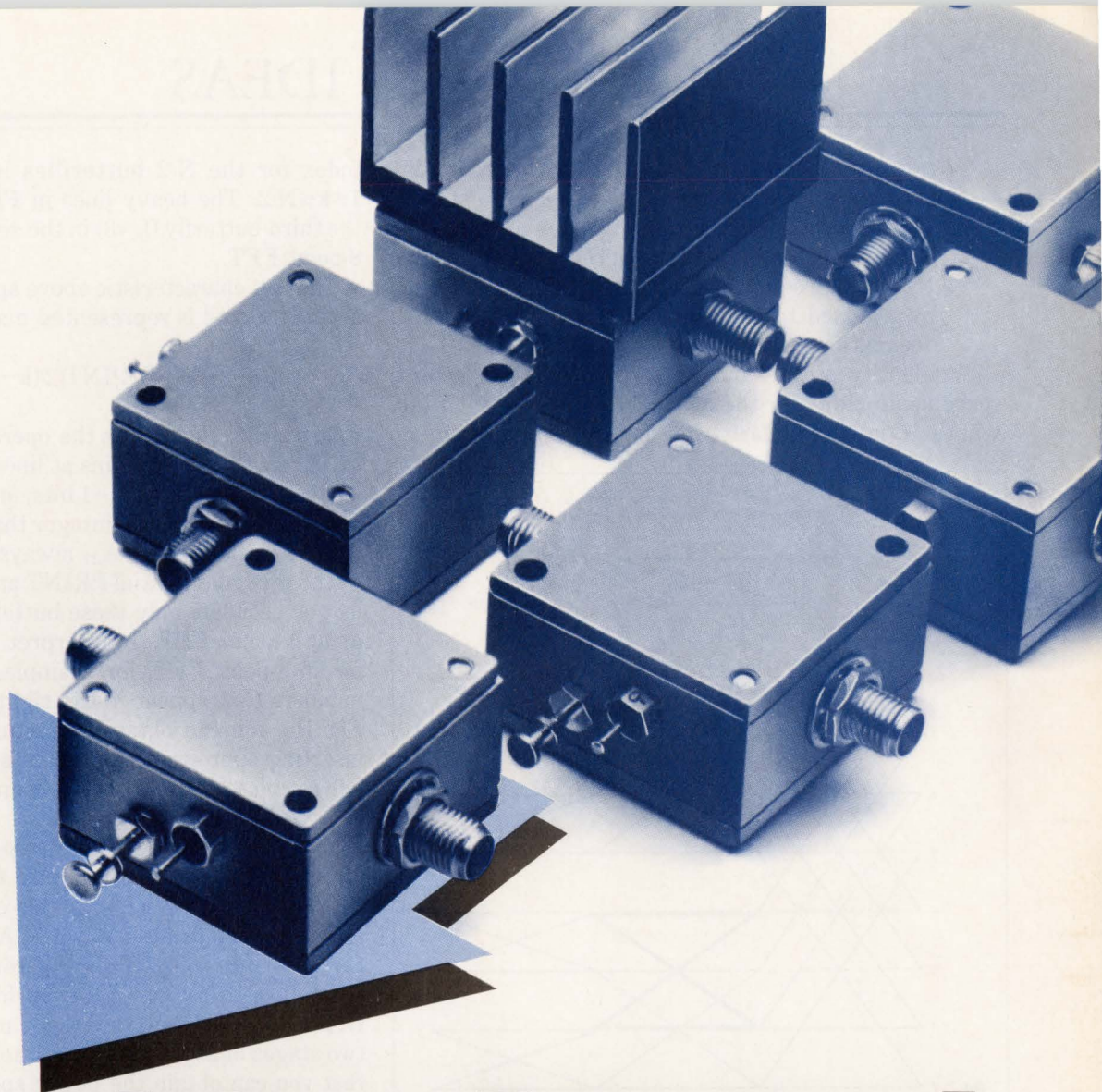
Amplifier Arsenal

50KHz—2000MHz, Low Noise 100mW output Gain Controlled from **\$69.95**

Our ZFL-2000 miniature wideband amplifier hit a bulls-eye when we introduced it last year. Now we've added more models to offer you a competitive edge in the continuing battle for systems improvement.

The ZFL-2000, flat from 10 to 2000MHz, delivers +17dBm output and is priced at only \$219.

Need more output? Our ZFL-1000H, flat from 10 to 1000MHz, delivers +20dBm output.

Is low noise a critical factor: Our ZFL-500LN and 1000LN boast a 2.9dB NF.

Variable gain important? Our ZFL-1000G, flat from 10 to 1000MHz, delivers +3dBm output with 30dB gain control while maintaining constant input/output impedance.

Searching for a high-quality, low-cost amplifier? Our ZFL-500 flat from 50KHz to 500MHz, delivers +10dBm output for the unbelievable low price of only \$69.95. Need to go higher in frequency? Consider the ZFL-750, from 0.2 to 750MHz, for only \$74.95. Or the \$79.95 ZFL-1000, spanning 0.1 to 1000 MHz.

One week delivery...one year guarantee.

SPECIFICATIONS

| MODEL | FREQUENCY MHz | GAIN, dB (min.) | MAX. POWER OUTPUT dBm(typ) | NF dB(typ) | PRICE \$ Ea. Qty |
|------------|------------------|--------------------|----------------------------------|---------------|---------------------|
| ZFL-500 | 0.05-500 | 20 | +9 | 5.3 | 69.95 1-24 |
| ZFL-500LN | 0.1-500 | 24 | +5 | 2.9 | 79.95 1-24 |
| ZFL-750 | 0.2-750 | 18 | +9 | 6.0 | 74.95 1-24 |
| ZFL-1000 | 0.1-1000 | 17 | +9 | 6.0 | 79.95 1-24 |
| ZFL-1000G* | 10-1000 | 17 | +3 | 12.0 | 199.00 1-9 |
| ZFL-1000H | 10-1000 | 28 | +20 | 5.0 | 219.00 1-9 |
| ZFL-1000LN | 0.1-1000 | 20 | +3 | 2.9 | 89.95 1-24 |
| ZFL-2000 | 10-2000 | 20 | +17** | 7.0 | 219.00 1-9 |

* 30dB gain control **+15dBm below 1000MHz

finding new ways...
setting higher standards

Mini-Circuits

A Division of Scientific Components Corporation
P.O. Box 350166, Brooklyn, New York 11235-0003 (718) 934-4500
Fax (718) 332-4661 Domestic and International Telexes: 6852844 or 620156

DESIGN IDEAS

the bit-reversed sense), provided that the FFT inputs are ordered samples.

- The twiddle-factor phase angle for an arbitrary butterfly is the bit-reversal of the integer (modulo N) of the product: The butterfly index, multiplied by 2 raised to the power of the FFT's order of decimation.

To identify stages and butterflies, let the letter j serve as an index for the M stages of an N -point FFT, where $1 \leq j \leq M$. Similarly, let the letter k serve as an

index for the $N/2$ butterflies in each stage, where $1 \leq k \leq N/2$. The heavy lines in **Fig 1b**, then, illustrate the third butterfly ($k=3$) in the second stage ($j=2$) of an 8-point FFT.

The last characteristic above appears in the program at line 230 and is represented mathematically as

$$A_{UP} = BR\{INT[2^j(k-1)/N]\},$$

where $BR\{z\}$ represents the operation of the bit-reversal subroutine that begins at line 400 in **Listing 1**. The quantity z consists of $M-1$ bits, and $INT[z]$ is a function that returns the lowest integer that is less than or equal to z . The phase angle A_{RT} always equals $A_{UP} + N/2$.

The program's initial PRINT and INPUT statements let you calculate only those butterfly angles of interest in an N -point FFT. To interpret the program's output for an 8-point FFT, for example, compare it with the numbers that appear in the rightmost four columns of **Fig 1b**. You can obtain the actual twiddle factors by inserting appropriate statements after line 260, which will calculate and print the sine and cosine of A_{UP}/N and A_{RT}/N .

You can also obtain the radix-2 FFT's bit-reversed output order by selecting only those butterflies contained in the last stage ($j=M$) of an arbitrary FFT. Note that the printed A_{UP} and A_{RT} values are exactly the indexing order of the bit-reversed FFT outputs. After further review of the twiddle-factor angles for a DIT FFT, you'll see that you can implement the first two stages of any DIT FFT without multiplication, and that you can obtain the power spectral-density results for an 8-point FFT without any sine or cosine multiplication.

EDN

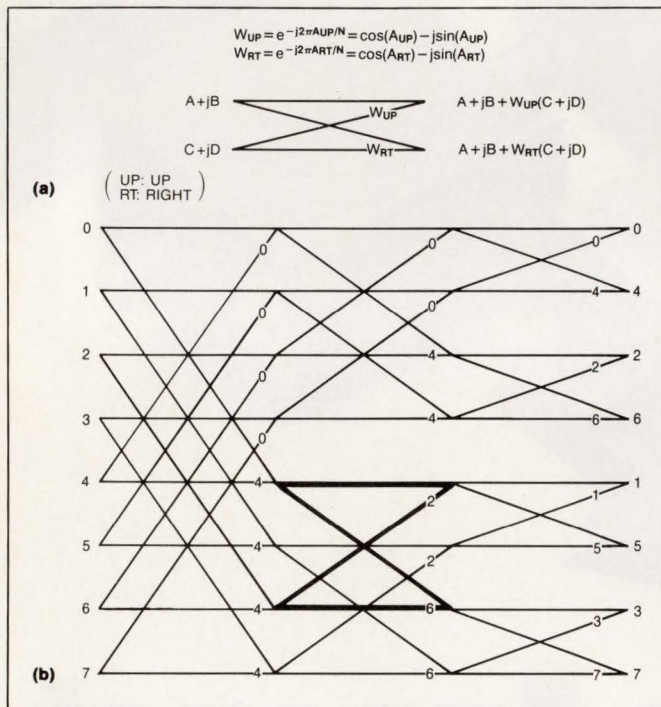

Fig 1—The standard butterfly operation (a) accepts the inputs $A + jB$ and $C + jD$ on the left and returns the quantities on the right. The numbers on the 8-point-FFT figure (b) (right four columns only) represent the output from **Listing 1** when it is applied to the 8-point FFT.

To Vote For This Design, Circle No 750

Receiver guards against current-loop shorts

R Mark Stitt
Burr-Brown, Tucson, AZ

The receiver circuit in **Fig 1** uses a current-protector device to guard against short circuits in the current-loop lines. Although such modern receiver circuits use a 50Ω sense resistor (R_1) that develops only 1V at 20 mA (compared with older designs that used a 250Ω resistor

and developed 5V at 20 mA), this lower voltage exacts a penalty: More fault current flows in the event of a short circuit. In a circuit using $\pm 18V$ supplies, for example, the 50Ω resistor dissipates 26W when a short circuit occurs, and the supply must deliver 1A.

In **Fig 1**, an IC difference amplifier senses the current signal and R_3 protects the circuit by providing foldback current limiting following a short circuit in the



Faint, illegible text block, likely bleed-through from the reverse side of the page.

Faint, illegible text block, likely bleed-through from the reverse side of the page.

Faint, illegible text block, likely bleed-through from the reverse side of the page.

Faint, illegible text block, likely bleed-through from the reverse side of the page.

Faint, illegible text block, likely bleed-through from the reverse side of the page.

Faint, illegible text block, likely bleed-through from the reverse side of the page.

Faint, illegible text block, likely bleed-through from the reverse side of the page.

The World Leader in White Noise Testing!



Write for detailed literature ... and how you can obtain a copy of "The White Noise Book". This hard cover book is designed to aid in the understanding of the technology associated with multi-channel FDM systems with emphasis on the practice of White Noise Testing. Charts and tables are also included to enable the engineer involved in NPR loading to apply measurement corrections for maximum accuracy.

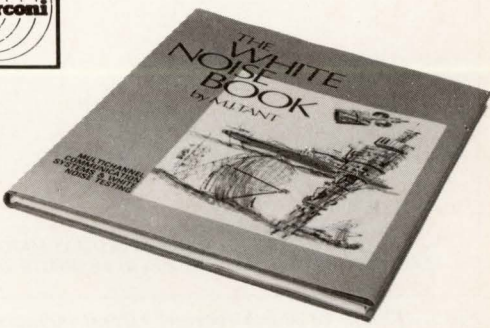

MARCONI INSTRUMENTS, 3 Pearl Ct., Allendale, NJ 07041, 201-934-9050 • 1-800-233-2955

DESIGN IDEAS

current loop. The loop current develops a signal across R_1 ; connecting this resistor to the negative rail makes full use of the current transmitter's dynamic range. The difference amplifier shifts the signal level to ground and also rejects any common-mode signals caused by fluctuations in the power supply.

Resistor R_2 preserves the amplifier's CMR by providing a source impedance at terminal 3 similar to the impedance at terminal 2. A 5% tolerance for R_2 maintains 86-dB CMR, but note that R_1 's tolerance has a direct effect on the output's gain accuracy. V_{OUT} 's range is -0.2 to $-1V$ for a 4- to 20-mA input. By interchanging the amplifier's inputs, you can obtain a positive 0.2 to 1V range. The circuit can also serve as a receiver for current loops connected to the negative rail; you simply swap connections to the positive and negative rails.

R_3 isn't actually a resistor but a protection circuit dubbed the PTC by its manufacturer; its only function is to protect R_1 . When a short circuit in the current loop places a supply voltage across R_1 and the PTC, current through these components increases sharply. The higher current heats the PTC, triggering a change in resistance (from less than 2Ω to about 3 k Ω) that limits the R_1 current to about 10 mA. The response time depends on the supply voltages: about 0.6 sec for $\pm 18V$; about 1.4 sec for $\pm 15V$ (Fig 2). When you remove the short circuit, the PTC resets to its low-resistance value.

The material in the PTC current protector is a homogeneous mixture of carbon granules in a polyolefin

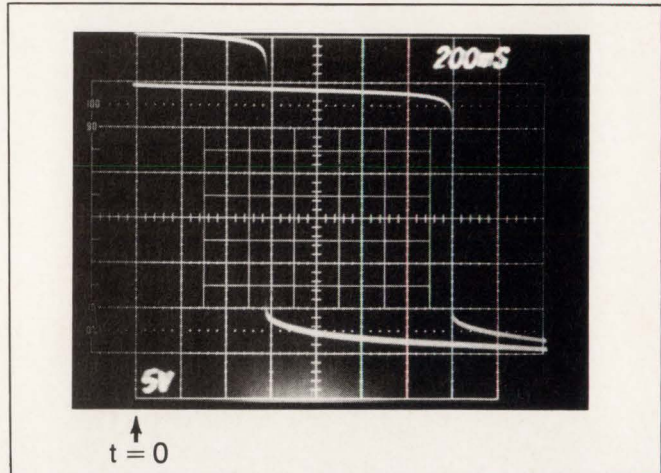

Fig 2—These waveforms from Fig 1 show how the PTC causes a change in the voltage across R_1 following a short in the current loop at $t=0$. This double-exposure photo illustrates the circuit's response to two operating conditions: $\pm 18V$ supplies, 0.6-sec response; $\pm 15V$ supplies, 1.4-sec response.

polymer base. During normal PTC operating currents, the granules are in contact with each other, forming a low-resistance path through the device. At the trip current (300 mA), the polyolefin expands and separates the granules, which raises the resistance. **EDN**

To Vote For This Design, Circle No 748

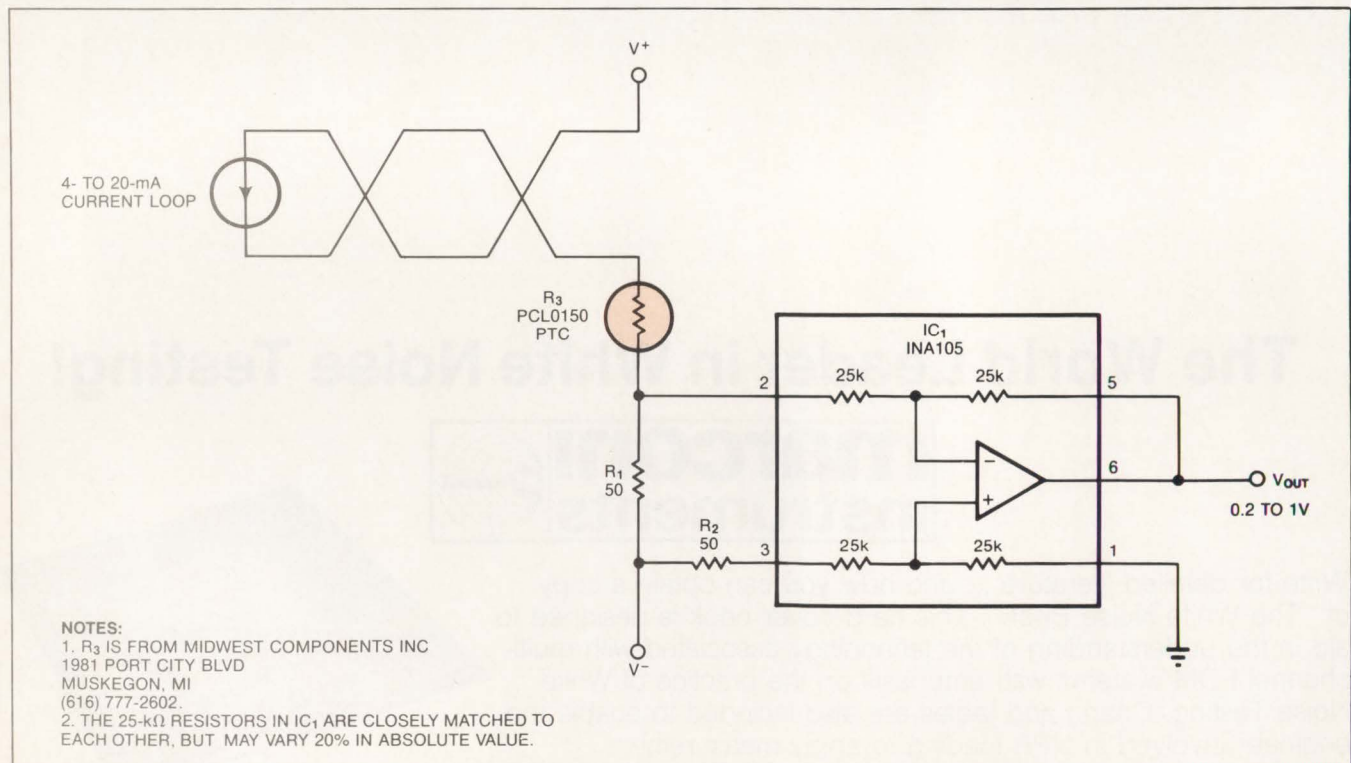
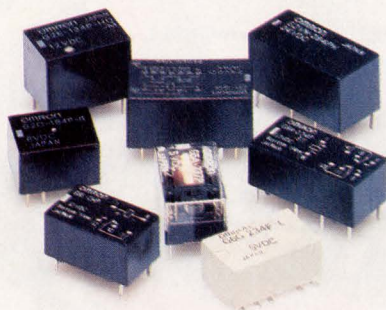

Fig 1—This 4- to 20-mA receiver circuit includes a current-protection device, R_3 , whose resistance increases if a short circuit occurs in the current loop.

Omron responds to your PCB relay needs with reliability and miniaturization



Omron's efficient PC board relays reduce power consumption and provide greater switching capacity while saving valuable board space. Omron relays reduce nominal power consumption by two-thirds—to as low as 150mW—for lower heat dissipation and closer board spacing.

Ideal for high density designs, Omron relays can be spaced as close as .039 inches apart without operating characteristic changes. One pole relays start as small as .136 sq. in., two pole at .246 sq. in., and four pole at .536 sq. in.. With a service life of up to 100 million operations, an Omron PCB relay can provide the reliability demanded in high repetition applications.

Our G5Y provides exceptional high frequency characteristics for **mobile telephone, data transmission and other broadcast applications.** Available in both SPDT and DPDT versions, pickup power consumption of the G5Y is rated at just 110mW. Plastic sealed construction protects the G5Y from harsh environments, while its DIP-type footprint simplifies board layout.

For **consumer electronics applications** such as smoke detectors, personal computers, security monitoring, alarm and energy management systems, our G5A provides compact size and low power consumption. Nominal power consumption is rated at 200mW, yet the G5A occupies only half the volume and two-thirds the board space of conventional armature-type relays. Our unique Moving Loop System reduces magnetic interference and contact bounce time.

Test, measurement and instrumentation application needs are met by our low profile G6E relay. Measuring just 0.33 inches high, the G6E has 200mW rated power consumption with pickup coil power of 98mW. Featuring pre-soldered terminals, the single-pole G6E also comes packaged for use with automatic insertion machines.

Whatever your PC board application, Omron relays respond with reliability and miniaturization. Call or write Omron for more information today.

1-800-62-OMRON.

OMRON[®]

Responsive Innovation

Toko coils and filters attack RF design problems before they come to life!

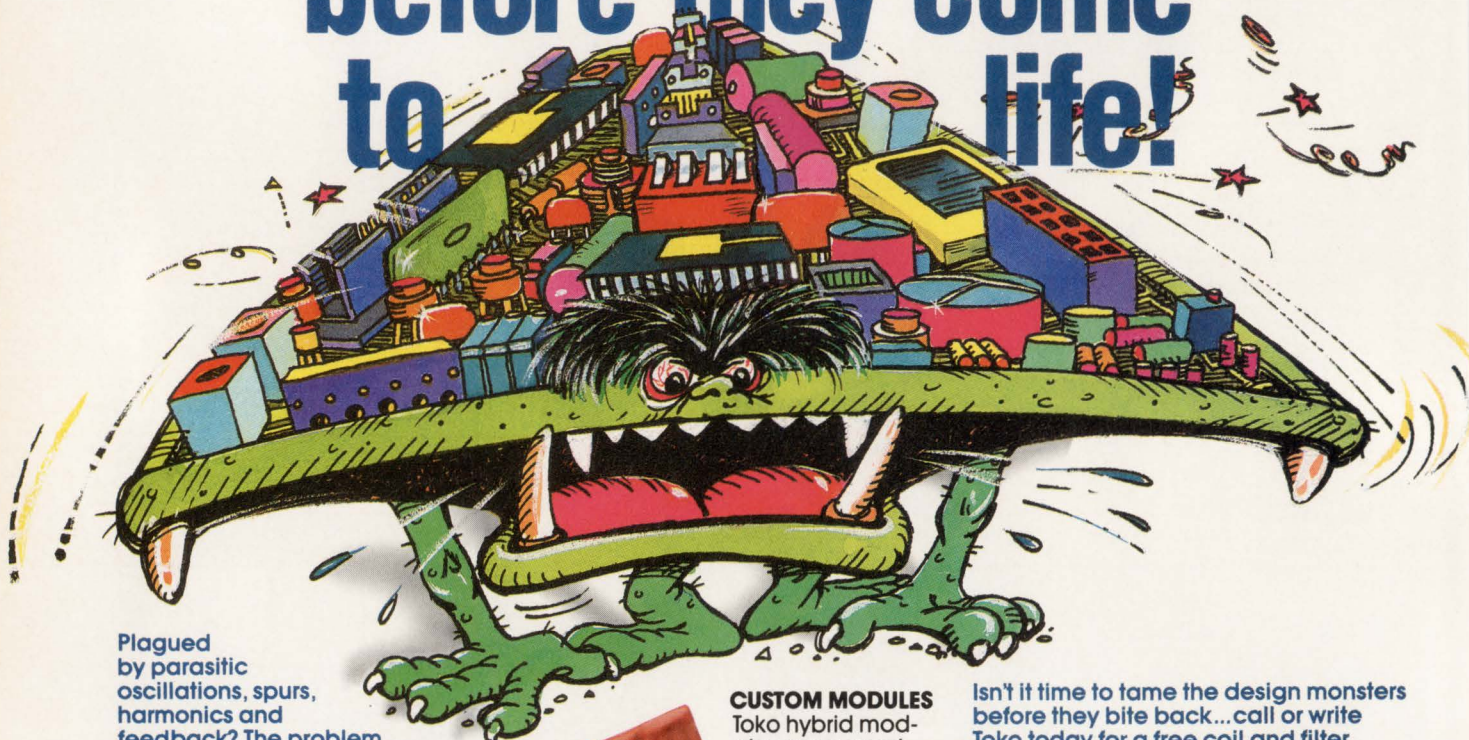

Plagued by parasitic oscillations, spurs, harmonics and feedback? The problem may not be your design, but the coils and filters you selected. Toko is the world's largest manufacturer of quality small coils and filters, with a selection so large, you're sure to find the right components to neutralize your rf design problems.



SUBMINIATURE ADJUSTABLE AND FIXED

Toko has what you need, so you won't need to compromise... subminiature adjustable coils and transformers, molded coils, radial fixed coils and fixed coils with axial leads. Toko high-Q coils are engineered in sizes from 5mm to 15mm, and inductance ranges from .02 μ H to 500 mH.

CHIP AND ADJUSTABLE SMD

Need to reduce the size of your products or automate production? Toko solves these problems with a wide range of surface mountable coils and LC, ceramic and helical filters in fixed and adjustable configurations. Packaged for automatic insertion and available for reflow or solder dipping.



For Subminiature Adjustable & Fixed Circle 81
For Chip and Adjustable SMD Circle 126

CUSTOM MODULES

Toko hybrid modules are a great way to simplify design and production tasks. With short lead time,

Toko can develop compact custom modules utilizing a variety of components, surface mounted on a ceramic substrate. One module replaces dozens of components.



FILTERS

For i-f or tuned rf circuitry. Toko filters simplify attenuation of out-of-band signals, while cleanly passing your desired signal. Ultra-miniature ceramic and LC filters at popular i-f frequencies fit tight spaces and tight budgets. With frequencies up to 1.2 GHz Toko helical filters are the right choice for communications transceivers.

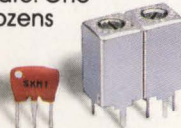

ACTIVE FILTERS

If you're advancing the state-of-the-art in digital audio or PCM products you'll appreciate Toko active filters. Especially designed for small size and low distortion, they're also very cost-effective.

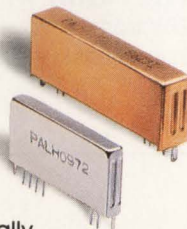

For Custom Modules Circle 158
For Filters Circle 163

Isn't it time to tame the design monsters before they bite back... call or write Toko today for a free coil and filter catalog or a quote on your needs. No matter what Toko coils and filters you choose, you can be assured of exceptionally high quality control at economical prices.

For Active Filters Circle 196

Quality and workmanship that add value and performance to your product.

TOKO
TOKO AMERICA, INC.

(CORPORATE HEADQUARTERS)
1250 Feehanville Drive
Mt. Prospect, IL 60056
(312) 297-0070, Telex: 724372, FAX (GIII):
(312) 699-7864

(Western Branch) 10080 N. Wolfe Rd., SW3-361,
Cupertino, CA 95014
(408) 996-7575, FAX (GIII): (408) 996-7280

(Eastern Branch) 6 Corporate Park Drive,
Suite 307, White Plains, NY 10604
(914) 694-5618, FAX (GIII): (914) 694-6280

(Southeastern Branch) Executive Plaza,
555 Sparkman Drive, Suite 820-C,
Huntsville, AL 35816
(205) 830-0952, FAX (GIII): (205) 830-5399

PLD implements permutation addressing

James L Tolles
Tolles Engineering, Simi Valley, CA

To allow a system's mother board to select among circuit cards plugged into a backplane, you have a choice of several addressing techniques. You can connect a separate strobe line to each card, for example, but this technique complicates the backplane wiring and requires the main board to generate a separate strobe output for each card. Or, you can use the familiar technique of binary addressing, which requires a set of address lines connected to each card in parallel. Each card includes an address decoder and a device for manually setting the card's address assignment (such as a DIP switch). This approach provides each card with a unique address that stays with the card regardless of its slot position. However, if your application involves a moderate number of cards and a dedicated slot position for each, then the option of permutation addressing may be the most effective.

In permutation addressing, the system defines a valid address by setting a specified number of address lines low. In Table 1, for example, three lines low on an 8-line bus provides access to any one of 34 card slots. Different 3-line combinations define each address, and you hard-wire each group of three to the appropriate card connector. Because the address for all cards is the same (000), a 3-input NOR gate on each card serves as the address decoder, providing a high-strobe signal when the card's address is active. Fig 1a shows the lines you connect to the first six card connectors.

Fig 1b shows a PLD (IC₁) that generates permutation

TABLE 1—PERMUTATION ADDRESSES

| LOCATION | PERMUTATION ADDRESSES (THREE BITS LOW DEFINES A VALID ADDRESS) | | | | | | | |
|----------|---|-----|-----|-----|-----|-----|-----|-----|
| | PA7 | PA6 | PA5 | PA4 | PA3 | PA2 | PA1 | PA0 |
| 0 | 0 | 0 | 0 | 1 | 1 | 1 | 1 | 1 |
| 1 | 0 | 0 | 1 | 0 | 1 | 1 | 1 | 1 |
| 2 | 0 | 0 | 1 | 1 | 0 | 1 | 1 | 1 |
| 3 | 0 | 0 | 1 | 1 | 1 | 0 | 1 | 1 |
| 4 | 0 | 0 | 1 | 1 | 1 | 1 | 0 | 1 |
| 5 | 0 | 0 | 1 | 1 | 1 | 1 | 1 | 0 |
| 6 | 0 | 1 | 0 | 0 | 1 | 1 | 1 | 1 |

addresses in response to a 6-bit address. The address can originate from a counter or an address bus. In this example, a 6-bit counter drives the PLD, and the resulting output addresses provide sequential access to 34 cards at 500-nsec intervals. The Enable PA signal prevents change on the output (O) lines until all the input (I) lines have settled, thereby eliminating glitches on the O lines.

The PLD also saves board space. An alternative system, for example, required five 74LS138s to generate the separate strobes for each of the 34 cards. **EDN**

To Vote For This Design, Circle No 747

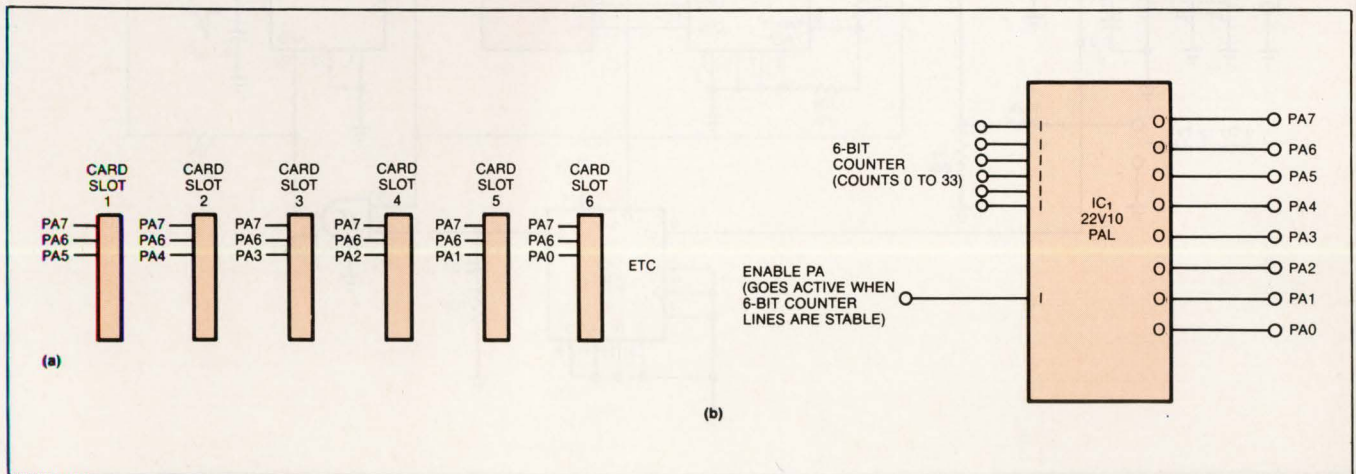

Fig 1—A space-saving PLD generates permutation addresses in response to a 6-bit input address. Address lines connect to the backplane card slots as shown in a.

Talking meter gives dc-voltage readings

Ricardo Jimenez-G

San Diego State University, Callexico, CA
and Francisco Meza and Jose J Lara
Mexicali Technological Institute, Mexicali,
Baja California, Mexico

The Fig 1 circuit is a low-cost (\$30) dc voltmeter that measures a positive 0 to 12.7V input and then voices the result in English. The meter can monitor a dc voltage automatically, thereby freeing a user for other tasks. Its resolution is $\pm 0.1V$.

Resistors R_1 and R_2 attenuate the input voltage, and an 8-bit A/D converter (IC_4) converts the result to a

decimal equivalent at the outputs DB_0 - DB_6 . This 7-bit word drives the EPROM's upper address lines A_6 - A_{12} , selecting a block of memory within the EPROM. Counter IC_3 then scans those memory locations in sequence by driving the lower address bits A_0 - A_5 . As a result, the EPROM delivers a preprogrammed sequence of instructions to the speech processor chip (IC_6).

Timer IC_2 is configured as a monostable monovibrator. When you depress the test switch, S_1 , the monostable generates a 1.1-msec pulse that sets the Q output of flip-flop IC_7 high. The resulting negative transition at the speech processor chip's ALD input (pin 20) loads the current EPROM output and causes the

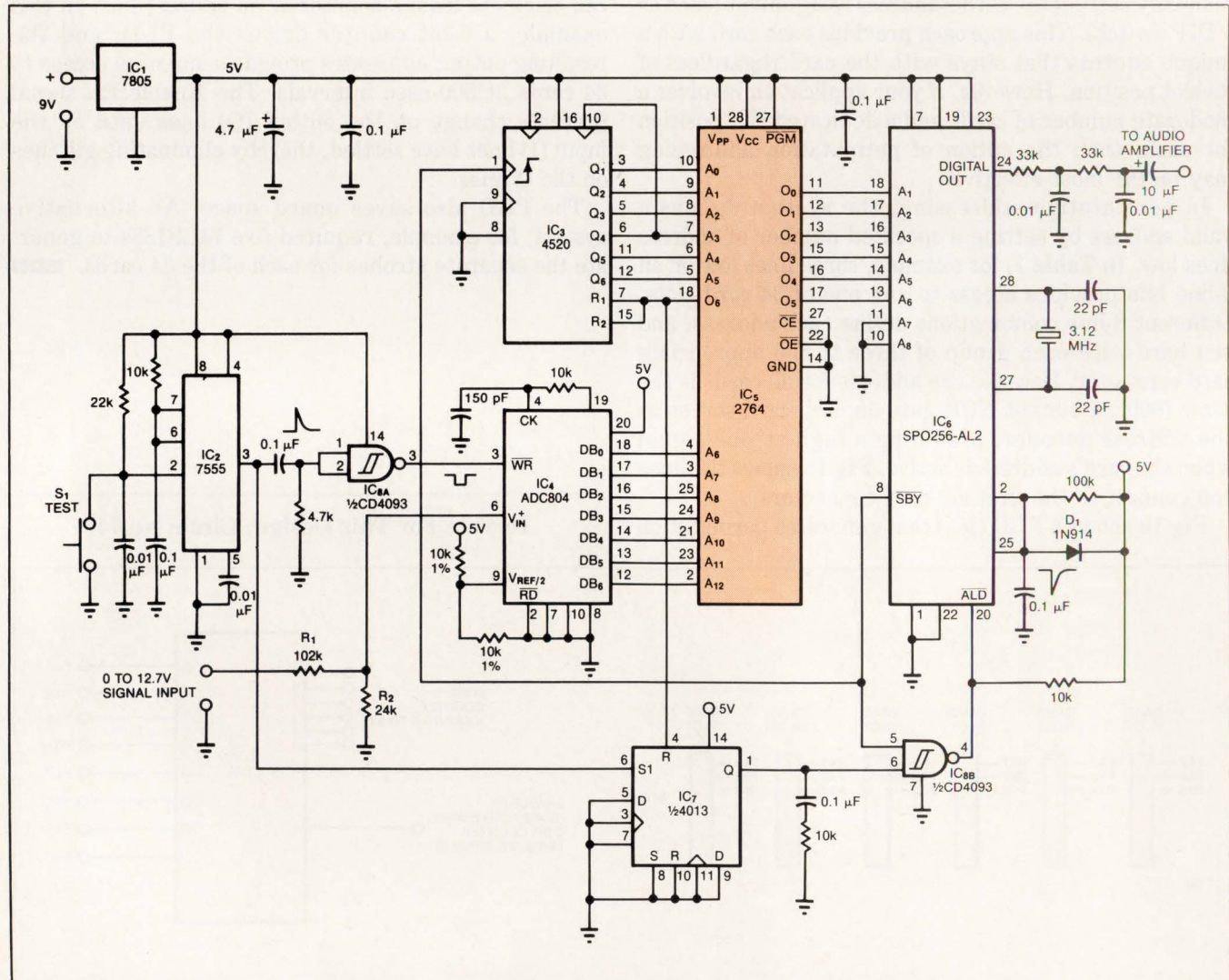

Fig 1—Once you connect an audio amplifier and speaker to this talking voltmeter, the circuit will call out measurements (in English) following each closure of the test switch, S_1 . The meter's range is 0 to 12.7V dc; its measurement resolution is $\pm 0.1V$.

You're not gambling with quality when you buy low-cost T70 relays from P&B.



Quality at just 77 cents

UL recognized and CSA certified, Potter & Brumfield's T70 relay switches from 1 milliamp through 10 amps, resistive, on printed circuit boards. All with the same reliability and performance that have made P&B relays the industry standard. And the T70 costs as little as 77 cents in 25,000 piece quantities.

Broad range of ratings

Gold-plated fine silver or silver-cadmium oxide contacts are available in a single pole, double throw configuration. Contacts of either material are UL recognized to switch motor loads up through 1/4 horsepower at 120 volts AC. Silver-cadmium oxide contacts are also rated for 5 amp tungsten lamp loads at 120 volts AC, while silver is rated 3 amps tungsten.

Reliability? Of course!

The T70 relay features simplified construction that enhances reliability while holding cost down. A sealed version is designed for immersion cleaning, and a plastic dust cover model is also available.

Off-the-shelf service

With 20 different T70 models available from stock at P&B, the unit you need is probably available off-the-shelf. Your P&B distributor or sales representative will gladly help you select the model that's just right for your application. Call toll-free 1-800-255-2550 for the name of an authorized Potter & Brumfield distributor or sales representative serving your area. Or call your P&B regional office.

Write for free sample

Write us on your company letterhead, briefly describing your potential application for T70 relays, and we'll rush you a free sample and complete specifications. Potter & Brumfield, A Siemens Company, 200 South Richland Creek Dr., Princeton, Indiana 47671-0001.

Regional Sales:

Braintree, MA, 617/848-6550;
Mission Viejo, CA,
714/582-1231;
Princeton, IN,
812/386-2130;
Bristol, England,
(0454) 616263.

Potter & Brumfield A Siemens Company

CIRCLE NO 83

Potter & Brumfield Inc., 200 S. Richland Creek Dr.,
Princeton, IN 47671-0001

Please send more information about P&B T70 relays.

Name _____ Title _____
Firm _____
Address _____
City _____ State _____
Phone _____ Zip _____

8701A

EDN 080687

The Most Powerful Instrument of its Kind in the World Today.



The New Data 6100 is The Most Comprehensive, Most Powerful Solution Available For Your Advanced Signal Acquisition and Processing Applications.

Take the pure processing power of over 40 pre-programmed and resident functions for both time and frequency domain measurements. Add total acquisition flexibility with digitizing plug-ins covering the entire dc to 1GHz bandwidth. Include accuracies

to better than 0.01% and resolutions up to a true 16 bits.

Now combine them all with the impressive signal acquisition and processing expertise and experience of Data Precision. What you'll get is the Data 6100 the world's best stand-alone solution for transient analysis, spectrum analysis, vibration analysis, ATE, FFT analysis and digital storage oscilloscope applications. And, you can get it NOW.

Call our **SOLUTIONS HOT LINE** at 1-800-343-8150. In Massachusetts call 617-246-1600. Give us the opportunity to tell you just how the Data 6100 or our other test instruments can be an affordable solution for you.

ANALOGIC ■

DATA PRECISION®

DATA PRECISION, Division of Analogic Corporation, Electronics Avenue, Danvers, MA 01923. Tel: 617-246-1600. Telex: 6817144.

ANALOGIC, Ltd., The Center, Weybridge, Surrey, England KT138BN. Tel: 0932-56011. Telex: 928030 ANALOG G.

ANALOGIC GmbH, Daimlering 2, 6200 Wiesbaden-Nordenstadt, W. Germany. Tel: 06122-70060, Telex: (17)6122969 ANA D.

DESIGN IDEAS

TABLE 1—SAMPLE REPORT

| DECIMAL ADDRESS | HEX ADDRESS | HEX DATA | ALLOPHONE | PHRASE |
|-----------------|-------------|----------|---|---------|
| 64 | 40 | 2F | ZZ | "ZERO" |
| 65 | 41 | 3C | YR | |
| 66 | 42 | 35 | OW | |
| 67 | 43 | 2 | 50-mSEC PAUSE | "POINT" |
| 68 | 44 | 9 | PP | |
| 68 | 45 | 5 | OY | |
| 70 | 46 | B | NN1 | |
| 71 | 47 | 11 | TT1 | |
| 72 | 48 | 2 | 50-mSEC PAUSE | "ONE" |
| 73 | 49 | 39 | HH2 | |
| 74 | 4A | F | AX | |
| 75 | 4B | F | AX | |
| 76 | 4C | B | NN1 | |
| 77 | 4D | 4 | 200-mSEC PAUSE; RESETS IC ₆ | |
| 78 | 4E | 44 | 200-mSEC PAUSE; RESETS IC ₃ & IC ₇ | |

processor to assert a low logic level at the \overline{SBY} output (pin 8). This action changes the IC_{8B} output to a logic one, causing the processor to hold \overline{SBY} low for an interval appropriate to that particular allophone. Note that you must connect an audio amplifier and speaker to the output as indicated.

The processor initiates the next allophone cycle by driving \overline{SBY} high. Each audible report requires three to 20 allophones, which you can get from the dictionary that accompanies the speech-processor package (available at Radio Shack). In essence, you must program the EPROM in 200 blocks of 3 to 20 bytes each.

An input of A₆-A₁₂=1000000 (corresponding to a 0.1V input), for example, produces the words "zero point one" from the audio amplifier. You store the allophones representing these words in the EPROM as shown in Table 1. After each report, the hex-data instructions 4 and 44 internally reset the speech processor, and via the processor's 06 output they reset the counter and the flip-flop as well.

(Ed Note: Mr Jimenez-G has a 2764 EPROM that contains the data required for this circuit. If you send him a 2764 device and the necessary postage, he will return a programmed EPROM to you. Or, he'll be glad to send you a Xerox of the EPROM program if you send him a self-addressed envelope with two \$0.22 stamps. His address is 96 Carmen Rivera Ave, Mexicali, Baja California, 21280 Mexico.)

EDN

To Vote For This Design, Circle No 749

Design Entry Blank

\$75 Cash Award for all entries selected by editors. An additional \$100 Cash Award for the winning design of each issue, determined by vote of readers. Additional \$1500 Cash Award for annual Grand Prize Design, selected among biweekly winners by vote of editors.

To: Design Ideas Editor, EDN Magazine
Cahners Publishing Co
275 Washington St, Newton, MA 02158

I hereby submit my Design Ideas entry.

Name _____

Title _____ Phone _____

Company _____

Division (if any) _____

Street _____

City _____ State _____ Zip _____

Design Title _____

Home Address _____

Social Security Number _____

(Must accompany all Design Ideas submitted by US authors)

Entry blank must accompany all entries. Design entered must be submitted exclusively to EDN, must be original with author(s), must not have been previously published (limited-distribution house organs excepted), and must have been constructed and tested.

Exclusive publishing rights remain with Cahners Publishing Co unless entry is returned to author or editor gives written permission for publication elsewhere.

In submitting my entry, I agree to abide by the rules of the Design Ideas Program.

Signed _____

Date _____

Your vote determines this issue's winner. All designs published win \$75 cash. All issue winners receive an additional \$100 and become eligible for the annual \$1500 Grand Prize. **Vote now**, by circling the appropriate number on the reader inquiry card.

ISSUE WINNER

The winning Design Idea for the May 14, 1987, issue is entitled "Nonlinear load extends PLL frequency range," submitted by Basel F Azzam and Christopher R Paul of Coherent Communications (Hauppauge, NY).

Digital has it now.



“It’s access – fuller, easier information access that’s at the heart of our success in selling Digital’s networked desk-top computing,” states Tom Curry, vice president of Marketing at McDonnell Douglas Manufacturing and Engineering Systems Company. “Architectural engineers now realize that the isolated PC is not the answer.”

In Mr. Curry’s view, Digital’s ability to network, plus compatibility from individual workstations to huge processors are ideal for the architectural community. “For any building project to progress smoothly, there has to be a coordinated effort. The group working on lighting, for example, needs to share information

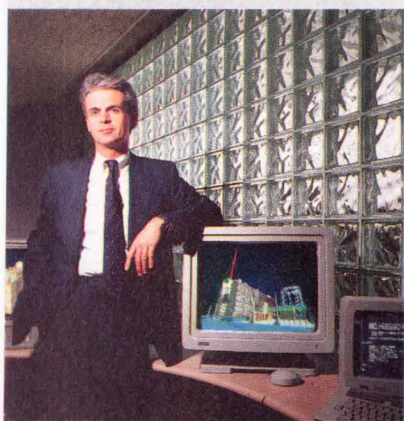

“With Digital’s networked desk, McDonnell Douglas is giving architectural engineers a more productive way to build.”

with those designing heating and ventilation. In the Digital environment, that’s exactly what they do.”

“In our own marketing efforts,” adds Mr. Curry, “Digital offers two enormous competitive advantages. Planning for the future is easier because of Digital’s commitment to compatibility. And we do very little selling of Digital to our customers – engineers are already sold.” To get your competitive advantage now, write: Digital Equipment Corporation, 200 Baker Avenue, West Concord, Massachusetts 01742. Or call your local Digital sales office.

digital™

**HOW TO
BUILD A BETTER
BAUD.**

Thomson-Mostek introduces the 300 to 9600 baud MODEM solution.

Now you can build a simple MODEM solution for any system speed from 300 to 9600 baud. Here's how.

For 300 to 1200 baud applications, you start with the Thomson-Mostek TSG 7515 single-chip MODEM, featuring:

- Compatibility with both 212A/103 and CCITT V.22
- Call progress detection
- CMOS technology for battery-powered applications
- DIP or PLCC packaging

Next, for just \$450, you get the complete TSG 7515 development kit – everything you need to help construct a single-chip MODEM for Bell 212A and V.22 A/B applications. The kit contains a users' guide featuring logic description and schematics, microcontroller coding plus a preassembled half size IBM® PC board, with software, for system evaluation.

And for 2400 to 9600 baud applications, Thomson-Mostek is now in production with the only working commercial silicon set in the world for the full range of ultrafast 2400/V.22 Bis to 9600/V.32 full duplex MODEMS.

How can we achieve such a broad speed range? The answer is in our exclusive

Digital Signal Processor and MAFE (Modem Analog Front End) technology. Each CMOS MAFE chip set consists of an analog transmit interface, an analog receive interface and a digital clock generator. To attain V.22 Bis 2400 baud operation, you simply use one DSP chip and MAFE set. Add another DSP and reach 4800 baud. And with a third chip, you can double your speed again – to a full duplex 9600 baud. So you get complete system upgrades easily, by adding DSP power.

To assist in the development of your 2400 to 9600 baud DSP-based solutions, Thomson-Mostek offers in-circuit emulator hardware and software tools. In addition, specific application notes are available for Echo Cancellation as well as FFT and Filtering.

So if MODEM speed is important to you, now there's a quick way to get the baud you've always wanted. The new full family of MODEMS, exclusively from Thomson-Mostek.

For more information, write to Thomson Components-Mostek Corporation, 1310 Electronics Drive, Carrollton, Texas 75006 MS 2205. Or call (214) 466-6316.

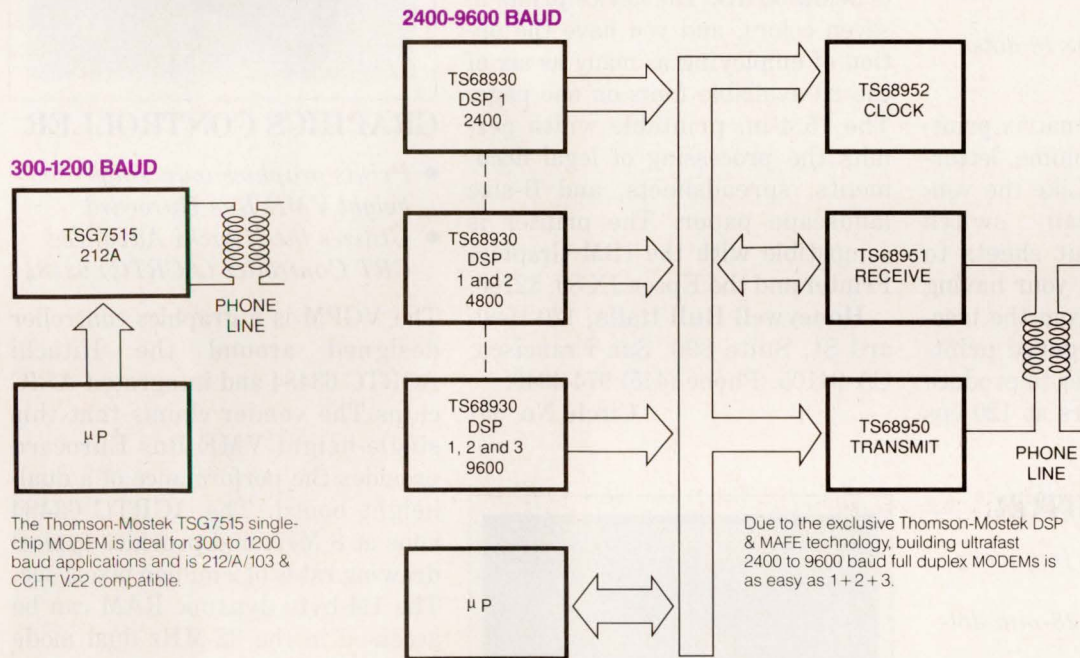

The Thomson-Mostek TSG7515 single-chip MODEM is ideal for 300 to 1200 baud applications and is 212A/103 & CCITT V.22 compatible.

Due to the exclusive Thomson-Mostek DSP & MAFE technology, building ultrafast 2400 to 9600 baud full duplex MODEMS is as easy as 1+2+3.

U.S. and Canadian Sales Offices

Western Area:

Santa Clara, CA
408/970-8585

Irvine, CA
714/250-0455

Woodland Hills, CA
818/887-1010

Seattle, WA
206/632-0245

Longmont, CO
303/449-9000

Scottsdale, AZ
602/998-1580

Tigard, OR
503/620-5517

Eastern Area:

Burlington, MA
617/273-3310

Marlton, NJ
609/596-9200

Huntsville, AL
205/830-9036

Liverpool, NY
315/457-2160

Poughkeepsie, NY
914/454-8813

Dublin, OH
614/761-0676

Greensboro, NC
919/292-8396

Norcross, GA
404/447-8386

Central Area:

Carrollton, TX
214/466-8844

Bloomington, MN
612/831-2322

Schaumburg, IL
312/397-6550

Austin, TX
512/451-4061

Canada:

Montreal, Quebec
514/288-4148

Brampton, Ontario
416/454-5252

Semiconductor Distributors

Add Electronics
Advent Electronics
All American
Semiconductor
Almac Electronics Corp.
Almo Electronics, Inc.
Dixie Electronics
Future Electronics
Greene-Shaw
Hammond Electronics
Integrated Electronics
Corp.
ITAL Sales
Kierulff Electronics
Lionex Corp.
Marshall Industries
Nu-Horizons Electronics
Pioneer Technologies
Group
Pioneer-Standard
Quality Components
(Q.C.-SW)
Quality Components
(Q.C.-SE)
ITT Multicomponents
Schweber Electronics
Solid State, Inc.
Zentronics
Zeus Components, Inc.



In addition to MODEMS, Thomson-Mostek manufactures a broad selection of MOS and bipolar devices for both commercial and military applications: microcomponents, ASIC, memories, telecom/datacom and linear circuits as well as Discrete, RF and microwave transistors and passive components. IBM is a registered trademark of International Business Machines Corporation.

NEW PRODUCTS

COMPUTERS & PERIPHERALS

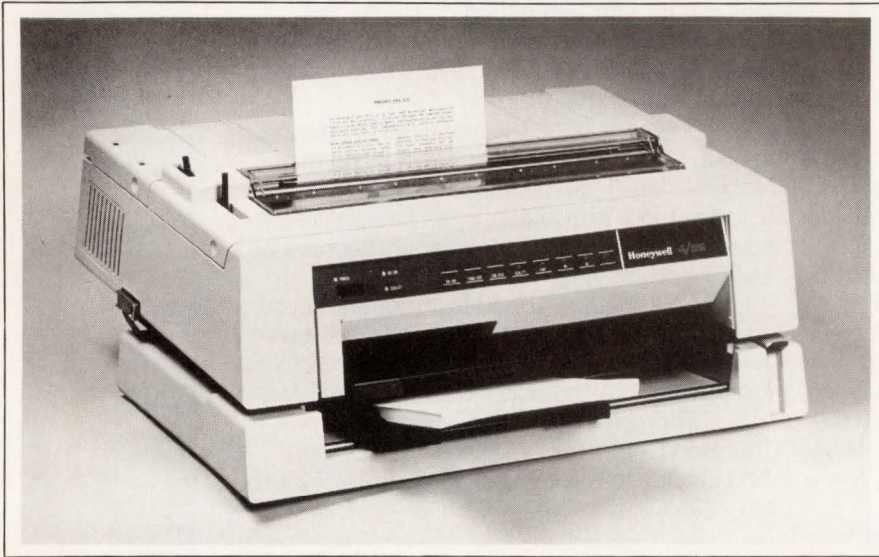

COLOR PRINTER

- Provides letter-quality print at 120 cps
- Has resolution of 60×18 dots/character

The 4/62 is a color dot-matrix printer designed for high-volume, letter-quality office output. Like the vendor's 4/66, it can switch automatically from cut sheets to fanfold paper, without your having to remove the paper from the tractor. An 18-wire staggered print-head permits the printer to produce letter-quality characters at 120 cps

in a single pass. Its resolution is 60×18 dots/character; its noise level is below 55 dB. The device prints in seven colors, and you have the option of employing as many as six of the 20 available fonts on one page. The 15.4-in. printable width permits the processing of legal documents, spreadsheets, and B-size landscape paper. The printer is compatible with the IBM Graphics Printer and the Epson JX 80. \$2160.

Honeywell Bull Italia, 120 Howard St, Suite 800, San Francisco, CA 94105. Phone (415) 974-4340.

Circle No 351

PS/2 COLOR MONITOR

- Has automatic scan frequency synchronization
- Features a 12-in., 0.28-mm dot-pitch CRT

The Ultrasync is an RGB color monitor for the IBM Personal System/2 Series computers; the IBM PC, PC/XT, PC/AT, and compatibles; and Apple's Macintosh II. The monitor can automatically synchronize with any horizontal scan frequency from 15 to 35 kHz and, most notably, with any vertical scan frequency from 50 to 120 Hz. Measuring 12

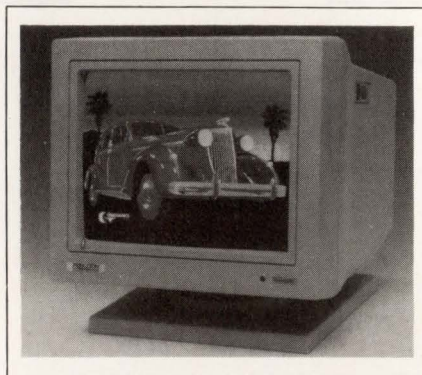

in. diagonally, the monitor is compatible with the IBM MDA, EGA, CGA, and PGC; Hercules graphics card; and Persyst BOB. Its dot pitch

is 0.28 mm; its resolution is 770×570 pixels max. The monitor offers eight, 16, or 64 colors for TTL inputs and has an infinite color palette for analog inputs. It features a 30-MHz video bandwidth and a built-in tilt-and-swivel base. \$795.

Princeton Graphics Systems, 601 Ewing St, Bldg A, Princeton, NJ 08540. Phone (800) 221-1490; in NJ, (609) 683-1660. TLX 821402.

Circle No 352

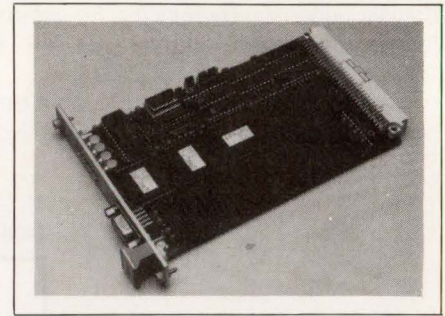

GRAPHICS CONTROLLER

- Prints graphics on a single-height VME Bus Eurocard
- Utilizes the Hitachi Advanced CRT Controller (ACRTC) 63484

The VGPM is a graphics controller designed around the Hitachi ACRTC 63484 and integrated ASIC chips. The vendor claims that this single-height VME Bus Eurocard provides the performance of a dual-height board. The ACRTC 63484 runs at 8 MHz and provides typical drawing rates of 2 million pixels/sec. The 1M-byte dynamic RAM can be accessed in the 32-MHz dual mode or the 64-MHz single mode; the board is compatible with 20-in. flickerless-screen monitors. The board's horizontal and vertical frequencies are programmable via the ACRTC, and its graphics resolution is programmable to 1280×1024 pixels. The controller uses bit-block transfers to generate characters rapidly. The controller provides 16 colors with 4 bits/pixel; an optional

VI-200™ Series

VICOR Component Solutions For Your Power System

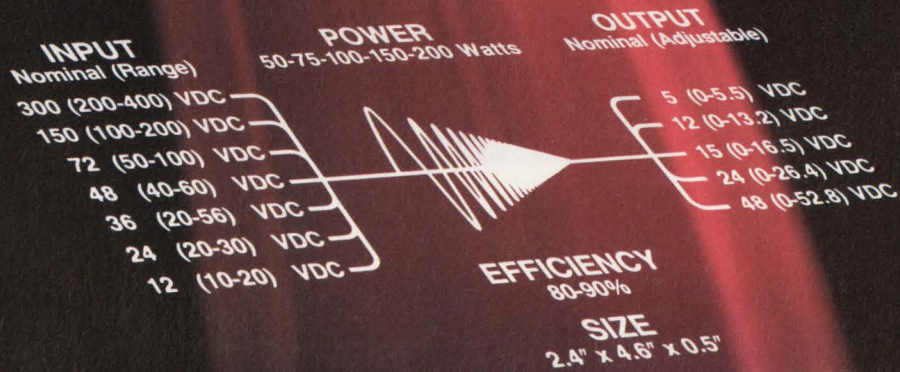

No Room Left For Your Power Supply? Talk To VICOR!

VI-200's deliver as much as 200W from 5.5 In.³

Write for our application note,
"Power Systems Size Reduction with
High Density DC-DC Converters."



VICOR Corporation, 23 Frontage Road, Andover, MA 01810 Tel: 617-470-2900, TWX: 910-380-5144, FAX: 617-475-6715

CIRCLE NO 85



A Terrific VME SBC!

Lots of I/O; up to 512 Kbytes no-wait SRAM

The DCPU1 is a terrific VME SBC. All CMOS. Two serial ports, 40 parallel I/O lines, 3 timers, real time clock. Up to 512 Kbytes of no-wait static RAM and 128 Kbytes of EPROM. You can even program it on an IBM PC (or compatible) and download, to cut development time and costs. 68HC000 CPU device. Under \$1000. A terrific SBC!

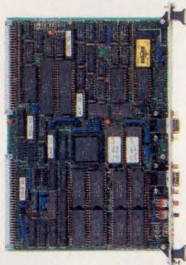

19 Thomas, Irvine CA 92718
800-543-3830, in California 714-855-3235

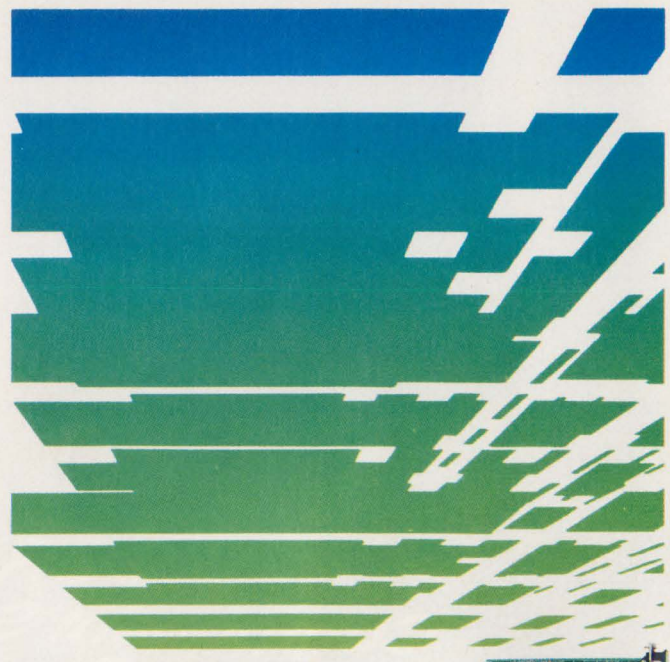

100% CMOS VME!

Low power, low heat

The DCPU1 is the first all CMOS VME SBC available. Low power allows portable applications, the memory and clock are even battery-backed on board. Low heat means you can stack a lot of boards in a card cage without heat problems. 68HC000 CPU, lots of I/O, up to 512 Kbytes of static RAM, can even be programmed on an IBM PC. A terrific SBC!

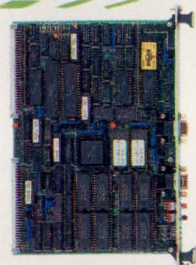

19 Thomas, Irvine CA 92718
800-543-3830, in California 714-855-3235

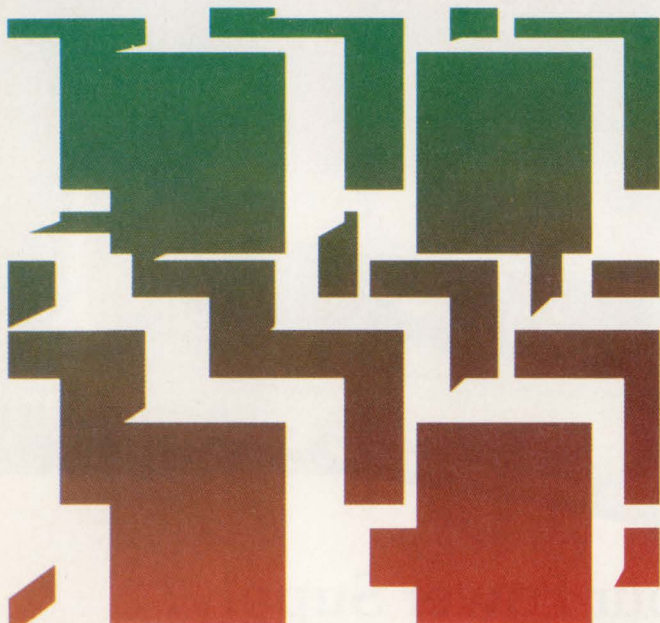

Program VME on an IBM PC!

Simplest programming of any VME SBC

The DCPU1 programming can be prepared on an IBM (or compatible) PC using commercially available languages, then downloaded to the module using software we supply. Makes development simpler, at a much lower cost. All CMOS, 68HC000 CPU, lots of I/O, up to 512 Kbytes of no-wait static RAM. A terrific SBC!

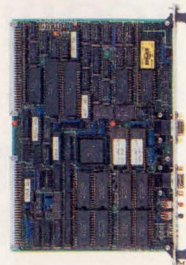

19 Thomas, Irvine CA 92718
800-543-3830, in California 714-855-3235

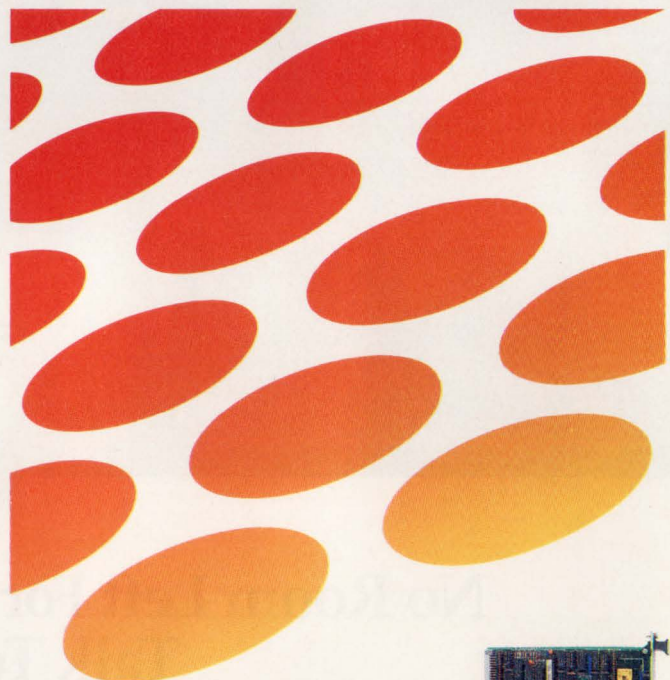

VME under \$1000!

More performance per dollar than any.

The DCPU1 is a terrific VME SBC. All CMOS. Lots of I/O, two serial ports and 40 parallel lines, real time clock and three timers. Up to 512 Kbytes of no-wait static RAM, 128 Kbytes of EPROM. Can even be programmed on an IBM PC. Yet it's actually priced under \$1000!

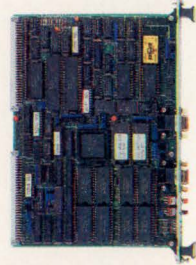

19 Thomas, Irvine CA 92718
800-543-3830, in California 714-855-3235

color look-up table lets you display 16 simultaneous colors from a palette of 4096. The board requires 5V dc at 0.9A typ and operates over 0 to 70°C. \$1499 (OEM qty).

Pep Modular Computers Inc,
600 N Bell Ave, Pittsburgh, PA 15106. Phone (800) 228-1737; in PA, (800) 255-1737. TLX 6711521.

Circle No 353

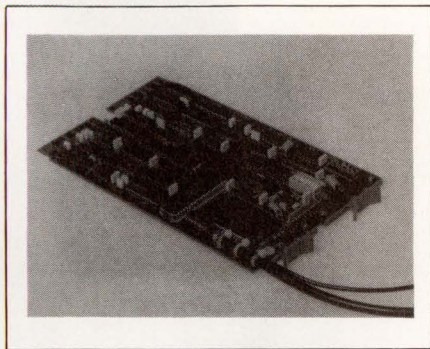

LAN INTERFACE

- Interfaces Q Bus systems to Arcnet LANs
- Provides onboard data buffering

The Q Bus-compatible Q-ARC-01 interface card allows you to connect equipment based on Micro/Vax II, Micro/PDP, or LSI-11 architectures in an Arcnet LAN. You can use the card with the 16-, 18-, and 22-address-bit versions of the Q Bus. The interface is based on the SMC9026 network-controller IC, and it has 2k bytes of onboard dual-port RAM (four 512-byte packet buffers). Both the send and the receive data channels can use these packet buffers in any combination, and you can locate the base address of this buffer memory on any 2k-byte boundary within the Q Bus's memory-address range. You can position the SMC9026's control and status registers on any 4-byte boundary within the Q Bus I/O page. \$1795.

Comedec Ltd, 6a School Lane, Hopwas, Tamworth, Staffs B78 3AD, UK. Phone (0827) 286180.

Circle No 354

C&C Marketing, Box 280, Batavia, IL 60510. Phone (312) 879-2074.

Circle No 355

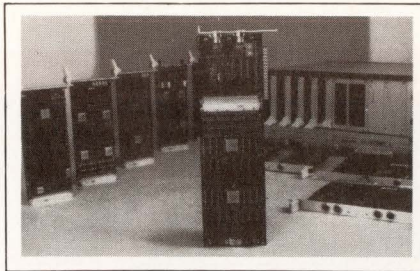

TRANSPUTER INTERFACE

- Allows you to install Transputer boards in IBM PCs
- Provides a bridge between the PC bus and other buses

The Megaframe/IBM adapter card allows you to install any of the company's Megaframe Transputer-based parallel-processing industrial computer boards in a standard IBM PC slot. This facility allows you to use the PC as a Transputer-development system or to operate the Transputer board as an accelerator, improving the PC's processing power. Alternatively, you can plug only the adapter card into the PC and communicate with other equipment via a 20M-bps Transputer link operating at RS-422 levels. This link can be as long as 10m. The vendor offers interface boards that allow you to connect the link's far end into Transputer systems or into VME Bus and Siemens industrial-bus systems. DM 980.

Parsytec GmbH, Julicher Strasse 338, 5100 Aachen, West Germany. Phone (0241) 1822275. TLX 08329659.

Circle No 356

VISION SYSTEM

- Provides image capture on IBM PC/XT and PC/AT
- Allows real-time or post-capture image processing

The IDS512 and IDS542 add-in boards for IBM PC/XTs, PC/ATs, or compatible computers provide 512×512-pixel and 1024×1024-pixel imaging capabilities, respectively. The boards accept three CCIR or NTSC standard composite-video in-

puts, which are digitized to 8-bit/pixel resolution. The boards have internal or external gen-lock facilities, which synchronize the digitization to the video signal. The digitizer output is then fed through an 8-bit input look-up table before being stored in video RAM. The video RAM provides RGB outputs, which pass through separate 8-bit output look-up tables before being converted back to analog signals by three separate D/A converters. A monochrome output is also provided. Feedback from the output to the input allows real-time image processing. PC-bus access to the look-up tables and video RAM allows you to modify the look-up-table data and post-capture image processing. A floppy disk containing a library of image-processing routines—including linear and nonlinear convolutions—and menu-driven vision-system software are provided with the board. From Frfr 55,000.

i2S, BP 76, 33041 Bordeaux Cedex, France. Phone 56291003. TLX 540504.

Circle No 358

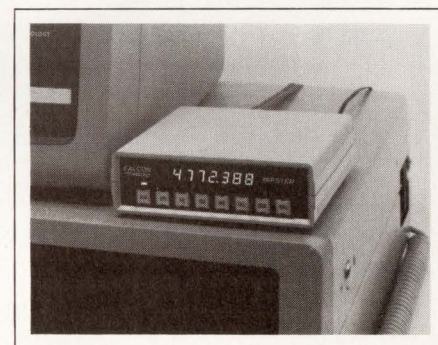

MEASURING INSTRUMENT

- Measures machine speed in thousands of instructions/sec
- Shows results on a 7-segment LED display

The Mipster is a modular measuring instrument for the IBM PC, PC/XT, or any 8086- or 8088-based system. It measures the following system parameters: machine speed (in thousands of instructions/sec), CPU clock frequency (within 0.03% accu-

Text continued on pg 238

Now GE/RCA drives



CMOS into the FAST* lane.

Advanced CMOS Logic: the new industry standard that's fast as FAST.

Now, Advanced CMOS Logic (ACL) gives you speed and drive to match FAST. You get all the advantages of CMOS, with less than 3ns propagation delay (AC 00 NAND Gate) and 24mA output drive current.

Outperforms FACT.*

Our ACL is faster than FACT. GE/RCA ACL uses a 1.5 micron channel length N-well CMOS process resulting in an on-chip gate delay of only 0.7ns.

FAST speed, CMOS low power.

ACL power dissipation is typically less than 25% of a FAST bipolar device. ACL dissipates less than a quarter of one Watt while switching, compared to one full Watt for a FAST IC (transceiver operating at 5 MHz). Quiescent power savings are even more dramatic. ACL idles at 1/1000 the power of a FAST IC (.5mW vs. .5W).

And with lower heat dissipation than bipolar, you can expect ACL to perform more reliably than FAST and AS.

Latch-up and ESD Protection.

Latch-up concern is virtually eliminated. ACL uses a thin epitaxial layer which effectively shorts the parasitic PNP transistor

responsible for SCR latch-up.

And new dual diode input/output circuit provides ESD protection in excess of 2KV.

High Rel and macrocells, too.

Most ACL designs from GE/RCA will be available in our macrocell library for standard cells. And we'll have High Rel versions screened to MIL-STD-883 Class B coming soon.

Expanding product line.

Our line already includes 52 of the most popular types. By year-end, we'll have 124 types (10 SSI, 100 MSI, and 14 LSI) in both AC and ACT (TTL-compatible) versions.

Prices comparable to FAST.

Our ACL line is priced comparably to FAST, so your savings with CMOS low power pay for the cost of switching.

Start your sampling today.

Put yourself ahead in the technology race with free samples. Samples must be requested on company letterhead. Write: GE/RCA Solid State, Box 2900, Somerville, NJ 08876.

For more information, call toll-free: 800-443-7364, extension 11. Or contact your local GE/RCA sales office or distributor.

*FAST and FACT are trademarks of Fairchild Semiconductor Corp.

In Europe, call: Brussels, (2) 246-21-11; Paris, (1) 39-46-57-99; London, 0276-685911; Milano, (2) 82-291; Munich, (89) 63813-0.



racy), number of memory accesses, number of I/O port accesses, and number of times the CPU flushes the instruction-stream queue. A probe, which plugs into the system under test, intercepts and processes the appropriate signals either to or from the CPU. The results are sent to a 7-segment LED display. You can use front-panel keys to select the mode of operation (continuous or triggered), the counting period (1.0 or 0.1 sec), and the system parameter. When operating in the continuous mode, the device refreshes the selected parameter every 1.0 or 0.1 sec; in the triggered mode, it accumulates the parameter once and then displays it. \$495.

Falcon Technology Inc, 664 W Hawthorne St, Glendale, CA 91204. Phone (818) 244-6460.

Circle No 359

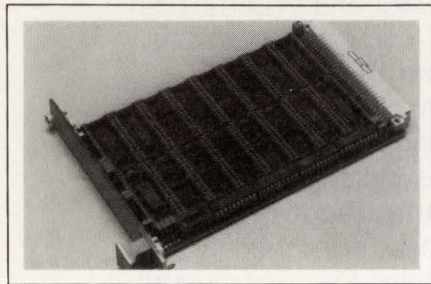

RAM BOARD

- Accommodates as much as 2M bytes of static RAM or ROM
- Provides two memory blocks with different access times

You can load the single-Eurocard VMEM-S1 VME Bus memory board with CMOS static RAM or ROM, or a mixture of static RAM and ROM, to a maximum capacity of 2M bytes. The board has sixteen 32-pin sockets that you can fill with 28- or 32-pin memory devices. The memory is divided into two separate memory blocks, so you can use different access-time devices for each block. The board accommodates devices having access times in the range of 100 to 250 nsec. It provides for the battery backup of static RAM. The board's VME Bus slave interface

includes both address and address-modifier decoding. DM 990.

Pep Modular Computers GmbH, Am Klosterwald 4, 8950 Kaufbeuren, West Germany. Phone (08341) 8974. TLX 541233.

Circle No 360

Pep Modular Computers Inc, 600 N Bell Ave, Pittsburgh, PA 15106. Phone (412) 279-6661. TLX 6711521.

Circle No 361

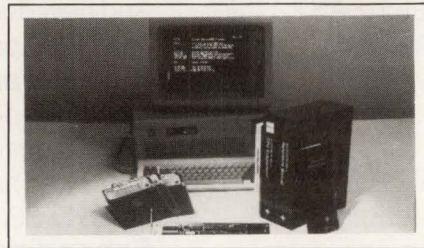

COPROCESSOR BOARD

- For IBM PC-family- or BIOS-compatible systems
- Runs benchmark 2.6 times faster than a VAX 11/780 does

The FB-4016 is a general-purpose coprocessor board that is compatible with IBM PC/AT-, PC/XT-, or BIOS-compatible systems. It combines the polyForth multitasking, multiuser operating system with the Novix NC-4016 high-speed microprocessor, yielding a high-speed coprocessor board for the IBM PC. Running polyForth at 5 MHz, it executes 10 Sieve of Eratosthenes benchmarks in 0.55 sec, which is 2.6 times faster than a VAX 11/780 or a 68020 running C at 16.7 MHz. The board has 128k bytes of RAM with 100k bytes available for applications. Applications needing faster I/O speed than is available through the PC bus can use the device's internal 40-pin high-speed I/O port directly. An extensive math library, database support, and a 1-msec clock for real-time applications are also included. \$3450.

Forth Inc, 111 N Sepulveda Blvd, Manhattan Beach, CA 90266. Phone (213) 372-8493.

Circle No 362

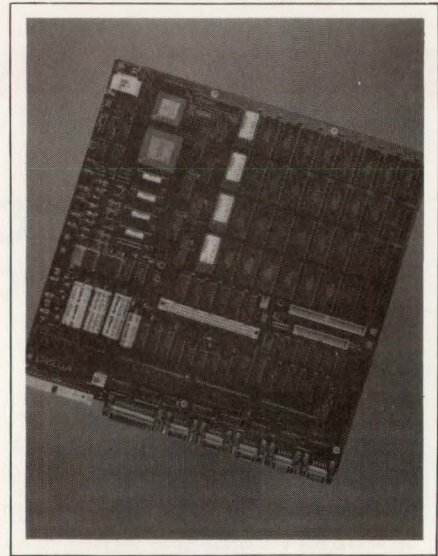

1-BOARD COMPUTER

- Runs a 12.5-MHz 68020 μ P and a 68881 math coprocessor
- Includes serial ports, SCSI-bus and floppy-disk interfaces

The Omega-OEM 32-bit single-board computer features a 12.5-MHz 68020 μ P and a 68881 math coprocessor. It has 1M byte of zero-wait-state, nonvolatile static RAM, and it provides space for as much as 256k bytes of EPROM/ROM. You can expand the RAM to 5M bytes. Its communications ports include five RS-232C serial ports; a Centronics-compatible parallel port; and a 16-bit, bidirectional parallel printer port. The board also has a battery-backed real-time clock/calendar, a SCSI-bus initiator, and a Shugart-compatible floppy-disk controller. Its buffered, 16-bit expansion bus allows you to access 16M bytes of user memory. The board consumes 8W of power and has on-board rectification and power-supply regulators that allow you to power it directly from a transformer. Omega-OEM board, £1395 (100); OS-9/68K operating system, with a C compiler, £520.

Windrush Micro Systems Ltd, Worstead Laboratories, North Walsham, Norfolk NR28 9SA, UK. Phone (0692) 404086. TLX 975548.

Circle No 363

NEW PRODUCTS

INTEGRATED CIRCUITS

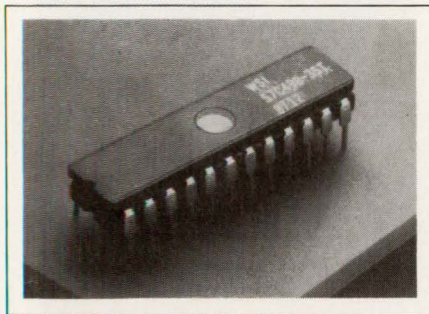

CMOS EPROM

- Offers 35-nsec access time
- Features 8k×8-bit organization

The 35-nsec WS57C49B is the world's fastest 8k×8-bit CMOS EPROM, according to the manufacturer. As a pin-compatible, programmable alternative to bipolar PROMs, the device consumes a fraction of the power (400 mW). Available in a 35-nsec commercial version or a 45-nsec military version, the EPROM comes in a 300-mil-wide ceramic DIP, a 600-mil-wide DIP, or a 28-pin ceramic LCC. 35-nsec version in a 300-mil ceramic DIP, \$29.50 (100).

Waferscale Integration Inc., 47280 Kato Road, Fremont, CA 94528. Phone (415) 656-5400.

Circle No 368

BRIDGE TRANSDUCER

- Maximum nonlinearity is $\pm 0.005\%$
- Offset TC is $\pm 0.07\mu V/^\circ C$

The hybrid 1B32 is the most accurate strain-gauge signal conditioner available, claims the manufacturer. Providing amplification, filtering, and voltage excitation for load cells and other bridge-configuration transducers, the device includes a chopper amplifier, a low-pass filter, and an adjustable transducer-excitation source. The signal conditioner's $\pm 0.005\%$ max nonlinearity error and 140-dB CMR (at 60 Hz, for a gain of 1000) makes it compatible

with requirements for 14- to 16-bit accuracy. Other specs include a $\pm 0.07\mu V/^\circ C$ voltage-offset temperature coefficient (TC), a $\pm 2\text{-ppm}/^\circ C$ gain TC, and 1- μV p-p noise (0.1 to 10 Hz). The 1B32 provides an adjustable $\pm 10V$ offset that lets you null a large load or do tare adjustments. Pin-programmable gains include 333.3 and 500 for 2-mV/V and 3-mV/V load cells, respectively. The device draws 4 mA/-1 mA from $\pm 15V$ supplies and comes in a 28-pin DIP. \$52 (100). Delivery, four to six weeks ARO.

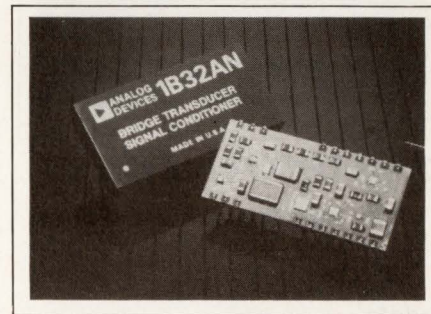

Analog Devices Inc., Literature Center, 70 Shawmut Rd, Canton, MA 02021. Phone (617) 461-3643. TLX 174059. TWX 710-394-6577.

Circle No 369

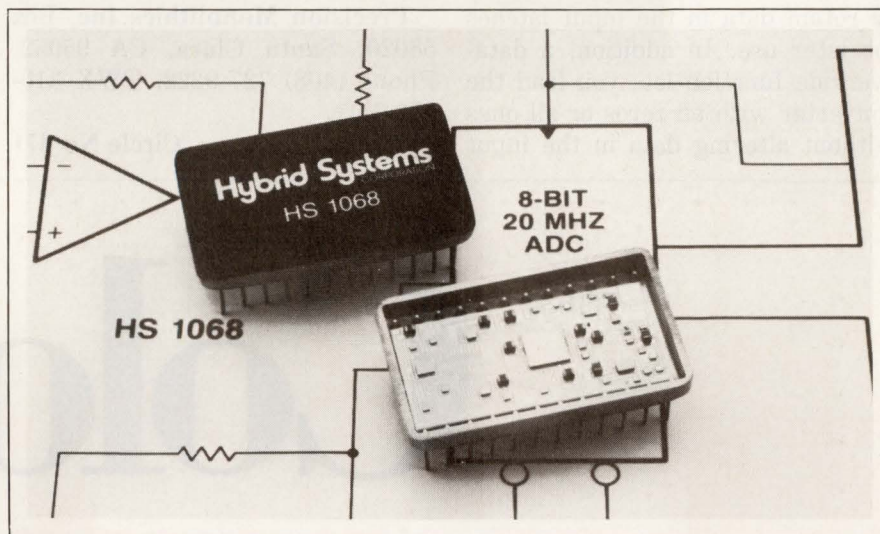

FLASH A/D CONVERTER

- Has 8-bit resolution
- Provides 20M-sample/sec digitizing rate

The HS1068 20M-sample/sec, flash A/D converter includes all necessary analog-support circuitry in the package: a wideband input amplifier, precision 1.2V voltage reference, and a 3-state output register. The 8-bit device comes in a 24-pin DIP that occupies less space than the original 28-pin-DIP TDC1048. You pin-program the converter to accept an input range of either 0 to 1V or $\pm 0.5V$, and you can select straight binary, inverted binary, 2's comple-

ment, or inverted 2's complement output code. Separate digital outputs flag input overranges at zero and full scale. Power supplies are 5V and -5.2V, drawing 101 and 207 mA, respectively. Power dissipation is 1.67W. Other key specs are $\pm 1/2$ LSB integral and differential linearity errors, 60-psec aperture time, 2% differential gain, and 1° max differential phase. HS1068C, \$295; HS1068B, \$375 (100). Delivery, eight to 12 weeks ARO.

Hybrid Systems Corp., 22 Linnell Circle, Suburban Industrial Park, Billerica, MA 01821. Phone (617) 667-8700. TWX 710-347-1575.

Circle No 370

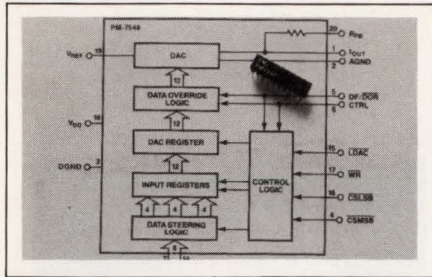

CMOS D/A CONVERTER

- 12-bit resolution; 8-bit-bus compatible
- Accepts left- or right-justified data

The PM-7548 CMOS D/A converter combines 12-bit resolution with an 8-bit data-bus interface that accepts left- or right-justified data. The digital inputs are buffered; you can update the converter immediately or retain data in the input latches for later use. In addition, a data-override function lets you load the converter with all zeros or all ones without altering data in the input

latches. It features $\pm 1/2$ -LSB integral and differential linearity error over temperature, ± 1 -LSB gain error, and 0.03-LSB max zero-scale error. Compared with the original industry-standard equivalent, the converter offers a 30% reduction in glitch energy, a 30% reduction of input capacitance, and a 20-dB improvement in PSR. The internal voltage regulator ensures TTL compatibility while operating with supply voltages from 5 to 15V. The device comes in two electrical grades for each of the commercial, industrial, and military temperature ranges. From \$7.58 to \$30.92 (100). Delivery, eight to 10 weeks ARO for the commercial grade; stock for the industrial and military grades.

Precision Monolithics Inc., Box 58020, Santa Clara, CA 95052. Phone (408) 727-9222. TWX 310-371-9541.

Circle No 371

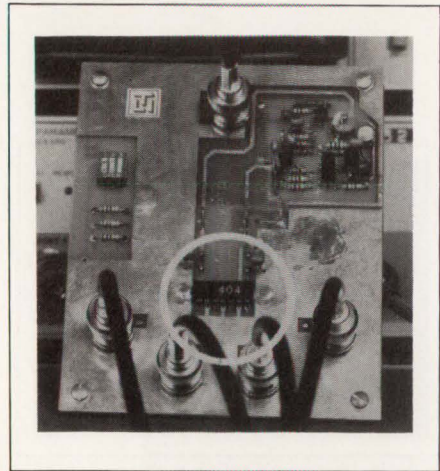

ANALOG SWITCH

- Crosstalk is -77 dB at 10 MHz
- 4×1 crosspoint switch

The LR404 is a 4×1 crosspoint analog switch that comes in a 14-pin plastic DIP. The device is suitable for use in video signal-switching matrices; using multiple devices, you can switch many outputs to a common output. The chip provides

Color by

Watch Apple's new Macintosh II do for color computing what the original Macintosh did for black & white. Our RAMDAC enables Macintosh II to display some of the finest quality graphics available in a personal computer.

differential phase and gain of 0.05° and 0.05%, respectively, at 3.58 MHz. Crosstalk is better than -77 dB at 10 MHz. \$4, moderate quantities.

Linear Technology Inc, Box 489, Station A, Burlington, Ontario, Canada L7R 3Y3. Phone (416) 632-2996. TLX 0618525.

Circle No 372

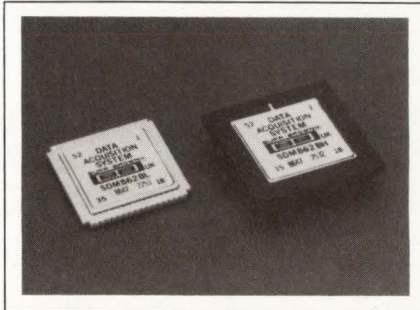

channel differential); an instrumentation amplifier that is jumper-programmable for gains of 1, 10, and 100; an S/H amplifier; an A/D converter with a μ P-compatible interface; and 3-state output buffers. The throughput rate for both devices is 22.22k-samples/sec in the serial mode or 33.33k-samples/sec in the overlap mode. It has input ranges of 0 to 10V, ± 5 V, and ± 10 V, and accuracy grades of 0.024% FSR and 0.012% FSR in the commercial-, industrial-, and military-temperature versions. Both models come in versions qualified

for the requirements of BS9450/CECC63000. To evaluate the LCC versions, you can obtain a Eurocard pc board with an LCC socket from the company. From \$103 (100). Delivery, stock to eight weeks ARO.

Burr-Brown Corp, Box 11400, Tucson, AZ 85734. Phone (602) 746-1111. TLX 666491. TWX 910-952-1111.

Circle No 373

DATA ACQUISITION

- Complete, 12-bit data-acquisition systems
- 45k-sample/sec at 8-bit resolution

The SDM862 and SDM863 are miniature, complete data-acquisition systems, available either in a 68-lead LCC or a 68-lead pin-grid array. They both include an input multiplexer (the SDM862, 16-channel single-ended; the SDM863, 8-

QUAD OP AMP

- 140-dB dynamic range with less than 0.0015% distortion
- Drives 600 Ω loads

Suitable for use in compact-disk players and other digital-audio systems, the LM837 quad op amp generates less than 0.0015% distortion over a 140-dB dynamic range. The output stage can drive a 600 Ω load. The standard pinout (in a 14-pin DIP) lets you upgrade an existing

Text continued on pg 244

Brooktree®



Macintosh II. 640x480 resolution, displays 256 colors simultaneously from a 16.8 million color palette.
Bt453. Triple 8-bit 40 MHz RAMDAC with 256 color lookup table.
 Monolithic CMOS.

Brooktree Corporation, 9950 Barnes Canyon Road, San Diego, California 92121. 1-800-VIDEO 1C or 1-800-422-9040, in California.

Apple® and Macintosh™ II are trademarks of Apple Computer Corporation.



CIRCLE NO 43



The Ultimate Math Machine.

Only from OKI:

The ***Fastest*** Floating Point DSP on the market today!

✓ 100ns Instruction Cycle Time ✓ 40 MHz High-Speed Clock

An outstanding achievement in Digital Signal Processing.

OKI presents the first real technology breakthrough in DSP with the CMOS 6992. A very high speed, very high performance Floating Point Processor which operates over a wide dynamic range—up to 480 dB. And provides pre- and post-normalization – in the first *true* CMOS Floating Point DSP.

The Ultimate Math Machine.

OKI's 6992 puts exceptional flexibility into your hands. A single chip, configurable for floating point format, fixed data format or a logical data format. Easy to interface with 8-bit, 16-bit and 32-bit MCUs.

Fastest development, too. Because OKI, of course, supports the DSP's sophistication with every sophisticated development and debugging tool you need—all PC DOS* compatible.

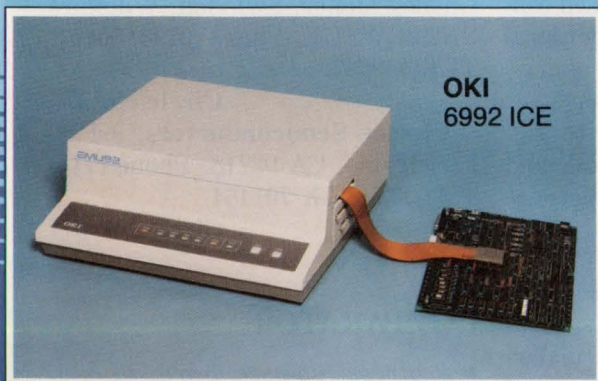

OKI
6992 ICE

You're assured true DSP application ease, speed and cost-efficiency using OKI's special 6992 ICE optimized for realtime emulation. Supplied with a Macro Assembler and a special library of subroutines. Plus a PC add-on Evaluation Board you can order today—to get a *fast start* into advanced CMOS Floating Point DSP.

OKI: the fast track in DSP

for graphics, high-performance modems, image processing, speech processing and robotics applications.

SPECIAL OFFER: OKI 6992 DSP Evaluation Board!

EDN 080687

Please rush _____ OKI 6992 DSP PC Add-on Evaluation Board(s)—125ns version with Assembler and technical data. Special introductory price per Board is \$480.00, including shipping/handling/sales taxes.

Check or money order for \$ _____ enclosed.
(Sorry, no company purchase orders please.)

Send only technical data package on OKI 6992 high-speed CMOS DSP.

Name/Title _____

Company _____

Address _____

City _____ State _____ ZIP _____

Return to: _____ Tel: (_____) _____

DSP Marketing Manager, **OKI Semiconductor**, 650 N. Mary Avenue, Sunnyvale, CA 94086. (408) 720-1900. Offer limited to 3 Boards per customer and expires August 31, 1987. Available only for USA and Canada shipment.

C MODULA 2 PASCAL

Cross-Compiler Systems

- High performance, field-proven software development systems producing extremely compact, fast-executing, ROMable output code.

- Each cross-development package includes:

- C, Modula 2, or Pascal Cross-Compiler
- Macro Relocating Cross-Assembler
- Object Code Librarian
- Object Module Linker
- Hexadecimal Format Loader [S-Records, Intel Hex, TEK Hex]
- Standalone Support Library [EPROMable, with full floating point support]

- All languages can be intermixed with assembly language

- Targets supported:

6301/03
6801/03
6809
68HC11
68000/08/10/12
68020/881/851
32000/32/81/82

- Available for following hosts:

VAX: VMS/UNIX/ULTRIX
 PDP-11: UNIX/TNIX/VENIX
 68000: UNIX System V
 PC,XT,AT: MS-DOS
 PowerNode: UTX/32

UNIX: TM of AT&T Bell Labs.
 VAX, VMS, PDP-11, ULTRIX:
 TM of Dig. Equip. Corp.
 TNIX: TM of Tektronix Inc.
 VENIX: TM of VenturCom
 PowerNode: UTX/32: TM of Gould Inc.

INTROL CORPORATION
647 W. Virginia Street
Milwaukee, WI 53204
(414) 276-2937
FAX: (414) 276-7026

CIRCLE NO 44

INTEGRATED CIRCUITS

system with few or no design changes. The chip is also available in a molded small outline package. Unity-gain stable, the monolithic device specs an 8-V/ μ sec slew rate, a 140-kHz power bandwidth and a 15-MHz gain-bandwidth product. The input-noise voltage is 0.5 μ V rms. \$1.25 (25,000).

National Semiconductor Corp., Box 58090, Santa Clara, CA 95052. Phone (408) 721-5856. TLX 346353. TWX 910-339-9240.

Circle No 374

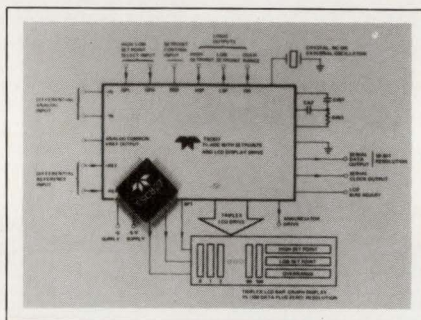

A/D CONVERTER

- Bar-graph and 10-bit-serial outputs
- Two selectable set-points

The TSC827 is a CMOS integrating-type A/D converter that includes on-chip drivers for a 101-segment LCD bar-graph display. The internal resolution is 1000 counts ($\pm 0.1\%$), and the result of each conversion is available as an additional serial digital output for use in driving numeric displays. The converter accepts positive inputs with full scale ranging from 0.1 to 2V, and the differential signal and reference inputs simplify the interface to a variety of signal sources. You can use switches or software programming to specify two setpoints; separate annunciators then flag under- and overrange inputs. The typical conversion rate is 7.5 samples/sec. The device consumes 15 mW and operates from a 9V battery. It comes in a 68-pin PLCC or a 60-pin flatpack. From \$10.80 (100).

Teledyne Semiconductor, Box 7267, Mountain View, CA 94039.

Phone (415) 968-9241. TWX 910-379-6494.

Circle No 375

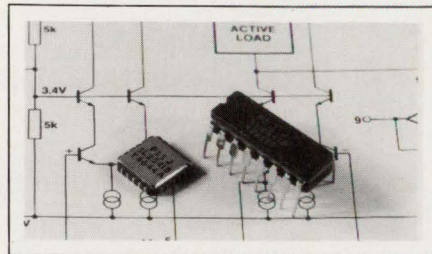

OP AMP

- Achieves a bandwidth of over 800 MHz into 50 Ω loads
- Has several programmable parameters

Featuring output rising- and falling-edge slew rates of 1400 and 900 V/ μ sec, respectively, the SL2541 op amp can directly drive 50 Ω loads with a bandwidth in excess of 800 MHz. The output settling time to 0.5% of final value is 30 nsec, and various parameters, including open-loop gain, output current, supply-voltage range, and output dc offset, are externally programmable. The SL2541 is supplied in a 16-pin ceramic DIP or in a 20-pin leadless chip carrier; both packages operate over the military temperature range. £30.92 (100).

Plessey Semiconductors Ltd., Cheney Manor, Swindon, Wiltshire SN2 2QW, UK. Phone (0793) 36251. TLX 449637.

Circle No 376

Plessey Semiconductors, 9 Parker, Irvine, CA 92718. Phone (714) 472-0303. TLX 701464.

Circle No 377

COMPARATOR

- Features sub-nsec propagation delay
- Contains eight comparators grouped as two sets of four

The SP93808 octal comparator features latched output data, adjustable input hysteresis, and glitch-capture circuitry. The eight compa-

INTEGRATED CIRCUITS

rators within the IC are divided into two groups of four, with each group controlled by a separate buffered clock input. The comparators spec a typical propagation delay of 950 psec, and individual comparator delays within the device are matched to within ± 100 psec. They have a differential input voltage range of $\pm 4V$ and a maximum input offset voltage of ± 2.5 mV. The glitch-capture circuitry allows you to detect and latch glitches independently of the comparator strobe. Input hysteresis is adjustable between 0 and 10 mV, and the comparators can directly drive 50Ω loads. £40.37 (1000).

Plessey Semiconductors Ltd, Cheney Manor, Swindon, Wilts SN2 2QW, UK. Phone (0793) 36251. TLX 449637.

Circle No 378

Plessey Semiconductors, 9 Parker, Irvine, CA 92718. Phone (714) 472-0303.

Circle No 379

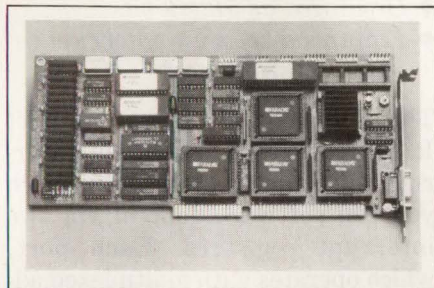

CHIP SET

- PC/AT peripheral-control and CPU functions in four ICs
- 6-, 8-, 10-, and 12-MHz operation

The FE3400 chip set provides PC/AT peripheral-control and CPU functions with only four ICs. Implemented in 2- μ m HCMOS technology, the four chips replace eight support ICs including the 8284 and 82284 clock generators, the 82288 bus controller, two 8237 DMA controllers, two 8259 interrupt controllers, an 8254 timer, and numerous SSI and MSI logic chips. Using the chip set reduces the area of a typical

PC/AT mother board from 142 to 21.5 in² and reduces the typical chip count from 95 to 19. In addition, the chip set reduces the power requirement by 50% (16W). The FE3400 chips operate under the company's copyrighted BIOS to ensure IBM compatibility and are software-programmable for 6-, 8-, 10-, or 12-MHz operation. Starter kits and design-support tools are available. \$118 (100). Delivery, 10 weeks ARO.

Faraday Electronics, 749 N Mary Ave, Sunnyvale, CA 94086. Phone (408) 749-1900. TLX 706738.

Circle No 380

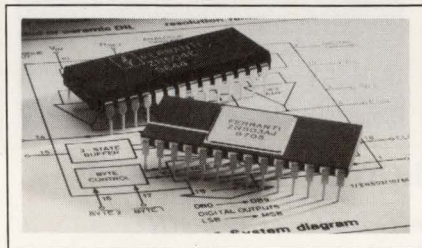

A/D CONVERTERS

- Perform a 10-bit conversion in 15 μ sec
- Feature parallel and serial I/O

The ZN503 and ZN504 are 10-bit successive-approximation A/D converters that feature parallel and serial 3-state outputs. The ZN503 has a linearity specification of $\frac{1}{2}$ LSB, while the ZN504 has a linearity specification of 1 LSB. You can configure the devices' TTL/CMOS-compatible parallel interface for 8- or 16-bit operation. The serial output suits the converters for remote sensing applications by reducing wiring requirements. Both devices have an on-chip 2.5V precision voltage reference, and are pin-programmable to have input ranges of 0 to 2.5V, 0 to 5V, or -2.5 to $+2.5V$. With the addition of two external components, the converters can perform a 10-bit conversion in 15 μ sec. The ZN503 is available only as a military grade part in a 28-pin ceramic DIP and is priced at £22.27 (100). The ZN504 is available in a 28-pin ceramic or plastic DIP.

Microstepping Made Easier

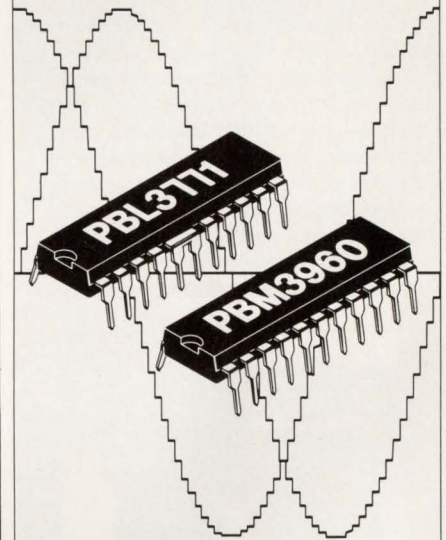

Rifa's new microstepping circuits make it easy. Two ICs, 8 passive components and a voltage reference is all it takes to build a complete microprocessor-compatible, microstepping system for a two-phase stepper motor.

The **PBL 3771**, is a dual switchmode driver, with an output drive capability of 500 mA per phase. Extended low-current linearity, switchable fast/slow current decay and precise matching between the two channels make it ideal for microstepping applications.

The **PBM 3960** is a dual 7-bit + sign Digital-to-Analog converter, specially developed to match the **PBL 3771**. The **PBM 3960** can be programmed to select fast or slow current decay automatically for enhanced high-speed microstepping performance.

It couldn't be easier. Write or call for more information.

RIFA

quality for the future

Greenwich Office Park 3, P.O. Box 3110
Greenwich, CT 06836-3110
Tel: (203) 625-7300/7301
Telex: 221976 ERIAN UR
Telefax (203) 625-7357

ERICSSON  RIFA is a member of the Ericsson Group
Circle Reader Service No. 018

CIRCLE NO 45

IEEE 488 for PCs

Our new Personal488 is the first IEEE interface for the PC to use the full power of a DOS device driver. This means you don't have to load IEEE routines at the beginning of every program, and you can access IEEE devices from all popular languages. Programs written for the Personal488 are shorter and more readable than any other IEEE interface for the PC.

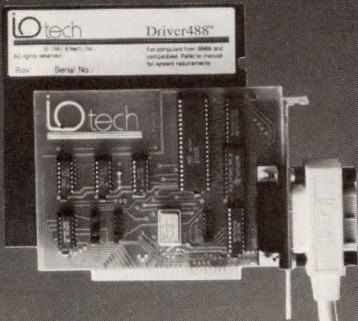

IOtech Personal488

National Instruments PCIIA

- ✓ Hewlett-Packard style commands
 - ✓ Compatible with all popular languages*
 - ✓ Supports program vectoring on SRQ
 - ✓ Automatic error and timeout indication
 - ✓ ✓ Lotus Measure™ & Asyst™ compatible
 - ✓ ✓ DMA transfers over 300K bytes/sec
- * without having to purchase extra drivers

Call or send for your **FREE** 1987 Catalog of IOtech's IEEE 488 converters, controllers, extenders, buffers, & software.



IOtech

IOtech, Inc. 23400 Aurora Road
Cleveland, Ohio 44146 Telex 6502820864
(216) 439-4091

CIRCLE NO 46

INTEGRATED CIRCUITS

ZN503, £22.27; ZN504 ceramic, £14.18; ZN504 plastic, £9.45 (100).

Ferranti Electronics Ltd, Fields New Rd, Chadderton, Oldham, Lancashire OL9 8NP, UK. Phone 061-624 0515. TLX 668038.

Circle No 381

Ferranti Electric Inc, 87 Modular Ave, Commack, NY 11725. Phone (516) 543-0200. TLX 6852104.

Circle No 382

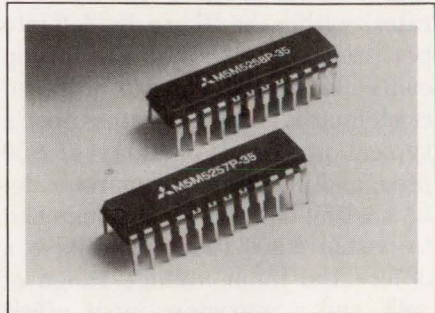

NMOS memory array, the devices are suitable for use in cache and main-memory applications. Both chips are also available in 45- and 55-nsec versions. They come in 300-mil, 24-pin plastic DIPs or plastic SOJ (small-outline J) packages for surface-mount applications. 35-nsec M5M5257P in DIP, \$142; M5M5258P, \$152 (100).

Mitsubishi Electronics America Inc, 1050 E Arques Ave, Sunnyvale, CA 94086. Phone (408) 730-5900.

Circle No 384

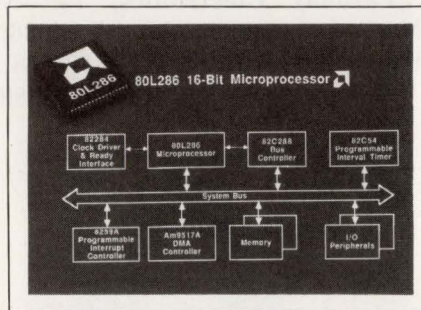

LOW-POWER 80286 μ P

- Operates at 12.5 MHz
- Dissipates 2.2W at 55°C

The 80L286 is a low-power version of the standard 16-bit μ P. It consumes 2.2W (30% less than the standard) and comes in 8-, 10-, and 12-MHz versions. Like the 80286, the 80L286 is compatible with software written for the 8086 and 8088 μ Ps. The company offers support peripherals for the 80L286, as well as the standard 80286. In 12.5-MHz, 68-pin plastic leaded-chip carrier, \$100 (100).

Advanced Micro Devices Inc, Box 3453, Sunnyvale, CA 94088. Phone (408) 732-2400.

Circle No 383

CMOS STATIC RAMS

- 256k \times 1- or 64k \times 4-bit organizations
- Feature 35-nsec access time

The 35-nsec M5M5257 (256k \times 1-bit) and M5M5258 (64k \times 4-bit) are the fastest 256k-bit static RAMs available, according to the manufacturer. Combining silicon-gate CMOS peripheral logic and a high-density

DUAL-PORT RAM

- Organized as 512 \times 9 bits
- Features a separate interrupt output for each port

The MK4511 512 \times 9-bit dual-port RAM features independent interrupt outputs for each port, which you can software control via two interrupt registers. Each port, which operates with multiplexed address/data, can simultaneously access RAM locations. The RAM is available with access times of 120, 150, or 200 nsec. The MK4511 is supplied in a 28-pin DIP or 28-pin plastic leaded chip carrier. From \$9.56 to \$12.65 (1000), depending on access-time rating.

Thomson Semiconducteurs, 45 Ave de l'Europe, 78140 Velizy, France. Phone (1) 39469719. TLX 204780.

Circle No 385

Thomson Components-Mostek Corp, 1310 Electronics Dr, Carrollton, TX 75006. Phone (214) 466-6000. TLX 730643.

Circle No 386

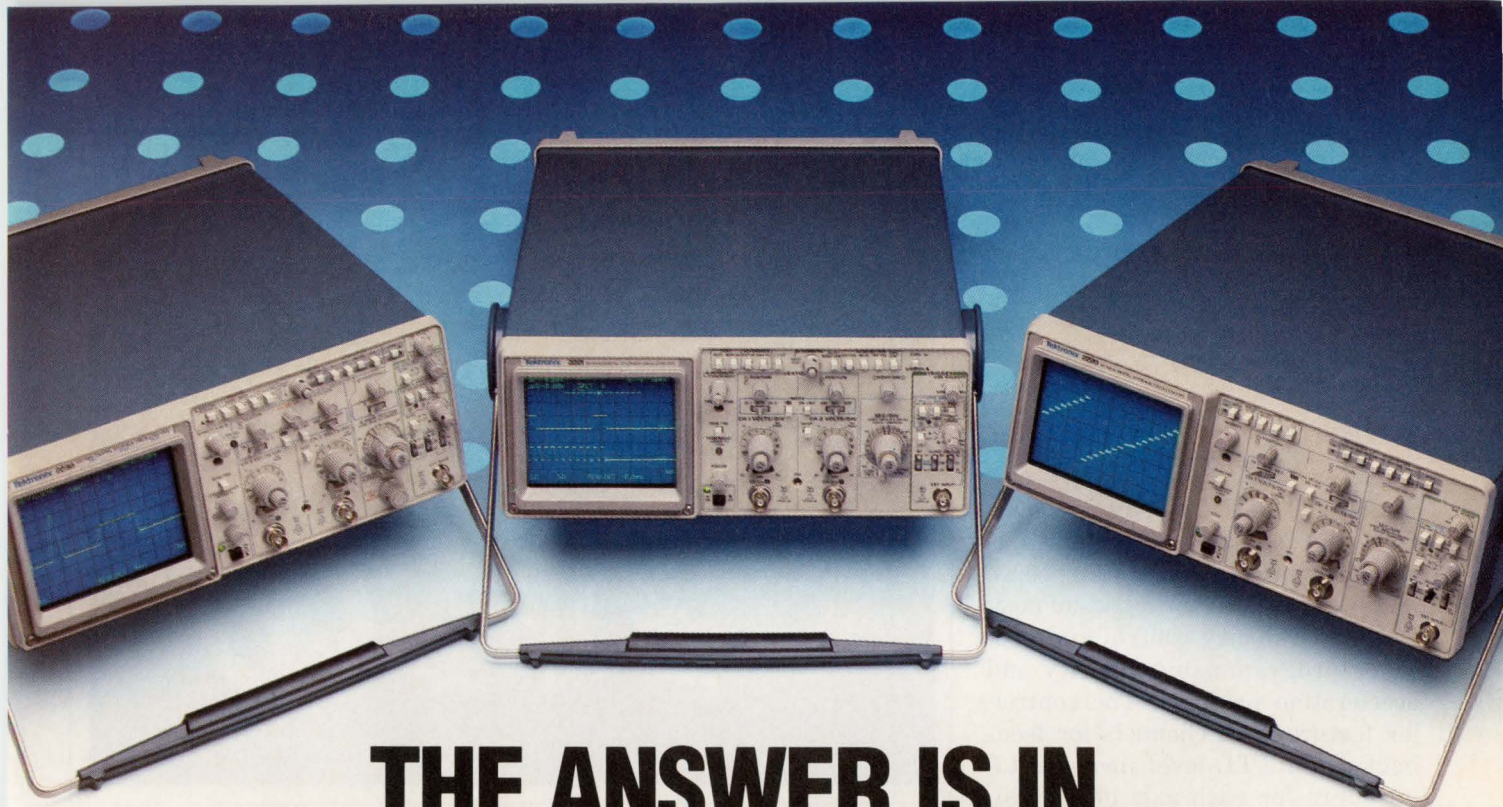

THE ANSWER IS IN TEK DIGITAL STORAGE:

Now! The new 60 MHz Tek 2221 joins the world's best-selling family of digital storage oscilloscopes. All featuring 20 MS/s *digitizing* along with familiar, full-bandwidth analog operation. It's the best of both worlds in an easy-to-use portable.

Discover the potential. With digital storage you can freeze waveforms. Capture events invisible to nonstorage scopes. Find signals buried in noise. And build a library of reference waveforms.

Digital storage display accuracy enhances your confidence in measurements. And all you have to do is push a button for *real-time* display analysis.

Compare the 2230, 2221 and 2220 to each other — and all others. The new 2221 offers such advanced features as CRT readout and measurement cursors. For even more performance and flexibility, there's the 100 MHz, dual time base 2230 with optional battery-backed memory for saving up to 26 waveform sets. And if it's economy you want, choose the 60 MHz 2220 with many of the same features at an even lower cost.

\$2995
\$3995
\$4995

With each scope you can capture events as narrow as 100 ns at any sweep speed thanks to Tek's proprietary peak detect mode. View events prior to or following a trigger event with pre/post trigger. Store waveforms into 4K records. Automate measurements with optional GPIB and RS-232-C interfaces. And output direct to a printer or plotter.

Tek software is available to help you make the most of the 2230, 2221 and 2220 in system configurations.

Call Tek for a free video brochure or to place an order.

Ask about free digital storage application notes and educational materials. Orders include complete documentation, manuals and 3-year warranty on labor, parts and CRT.

Call Tek direct:
1-800-433-2323
for free video brochure for orders/assistance
In Oregon, call collect:
627-9000



| Features | 2230 | NEW! 2221 | 2220 |
|--|--|---------------------------------|-------------|
| Analog/Digital Storage BW | 100 MHz | 60 MHz | 60 MHz |
| Maximum Sampling Speed | 20 MS/s | 20 MS/s | 20 MS/s |
| Record Length | 4K/1K (selectable) | 4K | 4K |
| Peak Detect | 100 ns | 100 ns | 100 ns |
| Save Reference Memory | One, 4K Three, 1K | One, 4K | One, 4K |
| Vertical Resolution | 8 bits 10 bits (AVG mode) 12 bits (AVG mode over the bus) | 8 bits 10 bits (AVG mode) | 8 bits |
| CRT Readout/Cursors | Yes | Yes | No |
| GPIB/RS-232-C Options | Yes (\$750) | Yes (\$500) | Yes (\$500) |
| Battery-Backed Memory (save 26 waveform sets) | Yes (inc with GPIB/ RS-232-C) | No | No |
| Price | \$4995 | \$3995 | \$2995 |

NEW PRODUCTS

COMPONENTS & POWER SUPPLIES

MOTOR CONTROLLER

- Controller is STD Bus compatible
- Offers four modes of position and velocity control

The Model 4327 motor controller is STD Bus compatible. It intelligently controls two dc brush-type servo motors. It offers four modes of position and velocity control and provides programmable velocity and acceleration profiling. The controller features two channels for feedback from TTL-level incremental encoders for each axis of control, and a 24-bit counter keeps track of the motor position. The controller also provides inputs for two limit or stop signals per axis. Onboard am-

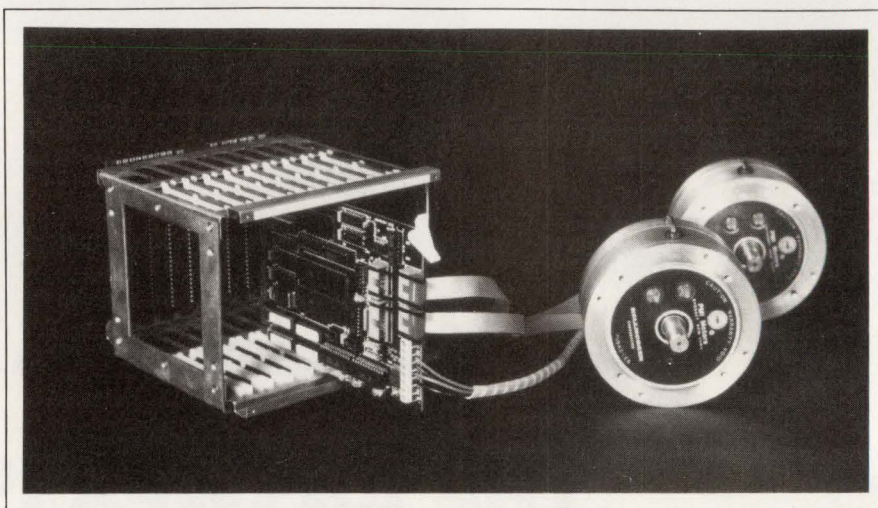

plifiers supply as much as 2A of pulse-width-modulated output. One axis, \$435; two axes, \$550.

Technology 80 Inc, 658 Mendels-

sohn Ave N, Minneapolis, MN 55427. Phone (800) 328-4827; in MN, (612) 542-9545.

Circle No 387

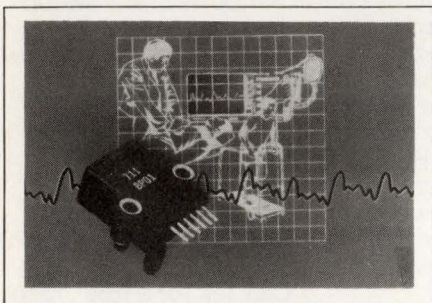

PRESSURE SENSOR

- Calibrated for the normal blood-pressure range
- Maximum tolerance of $\pm 1\%$

The BP01 noninvasive pressure sensor is fully temperature compensated and calibrated to operate over the normal blood-pressure range, 0 to 300 mm of mercury. It has a 6-mm max zero-pressure offset, a 0.2-mm/ $^{\circ}\text{C}$ shift over temperature (from 10 to 50 $^{\circ}\text{C}$), a $\pm 1\%$ guaranteed tolerance, and a maximum 0.2% of FSO (full-scale output) linearity. The span change over temperature is $\pm 0.02\%$ FSO/ $^{\circ}\text{C}$ max. In addition, the 4-k Ω impedance minimizes power dissipation, making the sensor compatible with portable or

battery-backup medical equipment. The BP01 is housed in a glass-filled nylon case that is pc-board mountable; it features barbed pressure ports that can accommodate standard medical-grade tubing. \$25 (OEM qty).

Sensym Inc, 1255 Reamwood Ave, Sunnyvale, CA 94089. Phone (408) 744-1500.

Circle No 388

I/V CONVERTER

- Designed for the Bell 113T1 repeater current loop
- Six-sided shielded case eliminates RFI problems

The Model I60S5.135 I/V converter is designed to operate with the Bell 113T1 repeater current loop and is completely compatible with paragraph 7 of those requirements. It operates from the Bell 60-mA current loop and generates 5V at 135 mA to operate logic circuits in telephone test systems or alarms. You can also use the isolated 5V output as a source of -5V for applications



requiring multiple supply levels or isolated power for a meter. The unit has a 6-sided shielded case that eliminates RFI problems; an internal filter that minimizes current-noise feedback into the current loop; and a post-regulator stage and filter that provides a clean, low-noise output. \$95.

Calex Mfg Co Inc, 3355 Vincent Rd, Pleasant Hill, CA 94523. Phone (415) 932-3911.

Circle No 389

TRANSISTORS

- Suitable for use in off-line switch-mode power supplies
- Eliminate the need for snubber components in some uses

The SGSF323 and SGSF463 bipolar

COMPONENTS & POWER SUPPLIES

transistors have voltage ratings of 1000V and 1300V, respectively, so they eliminate the need for snubber components in many applications. The SGSF323 is suitable for use in power supplies switching between 50 and 75 kHz. In forward-converter circuits, it can produce output power as high as 180W with minimal power dissipation. In the normal base drive configuration, the SGSF463 has a fall time of 50 nsec and a storage time of 700 nsec. In flyback converter circuits, however, you can decrease the storage time to 300 nsec, without affecting the fall time, by performing switching in the emitter circuit with an SGSP362 power MOSFET. SGSF323, \$0.60; SGSF463, \$1.30 (10,000).

SGS Microelettronica SpA, Via C Olivetti 2, 20041 Agrate Brianza, Italy. Phone (039) 65551. TLX 330131.

Circle No 390

SGS Semiconductor Corp, 1000 E Bell Rd, Phoenix, AZ 85022. Phone (602) 867-6100. TLX 249976.

Circle No 391

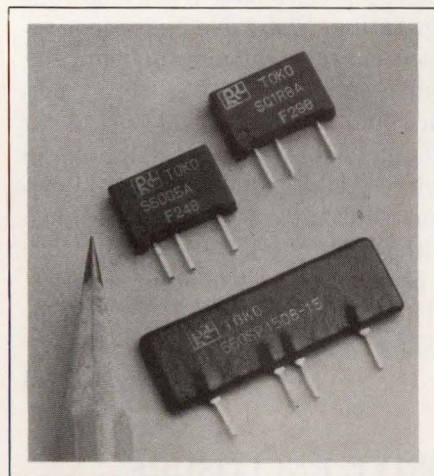

DELAY LINES

- Offer delays to 0.1 nsec
- Suitable for ECL computer applications

The SP, SQ, and SS Series delay lines offer delay capabilities ranging from 0.1 nsec and are suitable for ECL computer applications. The total delay times for SP units start

at 0.1 nsec \pm 0.05 nsec and step in 0.1-nsec increments to 1.7 nsec. The delay times for SQ units start at 0.2 nsec \pm 0.1 nsec and increment by 0.2-nsec intervals to 2 nsec max. The total delay times for SS Series devices range from 1 to 5 nsec in 1-nsec increments. All the parts feature 55 Ω impedance, 10% max waveform distortion, 1 Ω max dc resistance, and 100-M Ω min insulation resistance. SP Series, from \$1.73; SQ and SS Series, \$4.68 (1000).

Toko America Inc, 1250 Feehanville Dr, Mount Prospect, IL 60056. Phone (312) 297-0070. TLX 724372.

Circle No 392

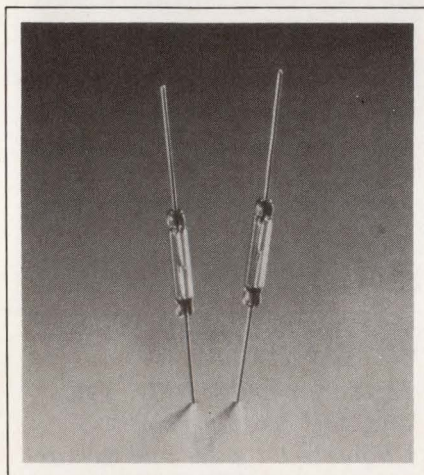

REED SWITCHES

- Available with load power ratings as high as 25W
- Feature low contact resistance and long lifetime

The RI-25 line of micro dry reed switches includes devices with maximum load-switching capabilities of 8, 15, and 25W. However, the switches can also handle load powers as low as 300 mW. They can withstand a voltage of 200V dc or 140V ac and can switch a maximum current of 1A into a resistive load. The reed switches have normally open spst contacts with operating magnetic fields of 8 to 16 At for the 8W switch and 46 to 70 At for the 25W switch. The corresponding release fields are 4 to 14 At and 16 to

Valhalla 2100/2300 Series Digital Power Analyzers



Honest RMS Power

Getting a True RMS Power reading from SCR controlled devices is tricky. But the digital accuracy of the Valhalla 2100 series Digital Power Analyzers tackles the job with ease and integrity.

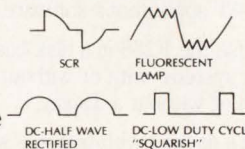

Trust the 2100 series to give you pin-point accurate AC plus DC power measurements - regardless of waveform. Get true readings on fluorescent lamps, pulsed DC devices, low level signals, even switching power supplies.

Or rely on our three phase 2300 series models with selectable current levels up to 100 Amps with basic .25% accuracy.

With Valhalla Digital Power Analyzers you get accurate measurement from DC to 20KHz, analog output (s), BCD, IEEE-488 programmability, starting at less than \$1,000.

Honest. Call 619-457-5576.

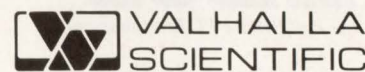

9955 Mesa Rim Rd. San Diego, CA 92121

PC-AT BUS BOARD-LEVEL COMPATIBLE

8 or 10 MHz
Zero wait states

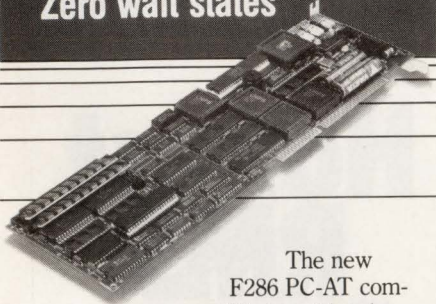

The new
F286 PC-AT com-
patible board-level

CPU from I-Bus gives you a whole new dimension of speed and freedom in PC or PC-AT bus system design.

It's all on a PC add-on-sized board—for use with a passive backplane just like other board-level systems. You just add the expansion cards, put it in a box (I-Bus has loads of backplanes and boxes), and it's ready to execute any PC-AT applications software.

Use the F286 in a disk-based or disk-less system, with or without a keyboard, with or without a display.

It's packed with features such as 10 MHz zero wait state operation. Separately clocked 80287 support (runs at full speed—not half speed as in other AT's). 512K RAM. Battery-backed clock/calendar. Optional PROMDISK to run any application from the F286's user EPROM.

And best of all, it's designed, built and supported by I-Bus—the originators of the passive backplane PC Bus.

If you're into systems, we speak your language. Call us TOLL FREE at:

800-382-4229 (in CA call
(619) 569-0646)

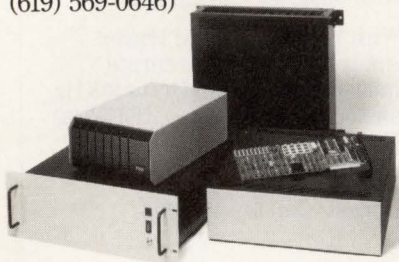

I-BUS

The Full Service PC Bus Company

5780 Chesapeake Court
San Diego, CA 92123 TLX: 910 240 0290

CIRCLE NO 49

COMPONENTS & POWER SUPPLIES

32 At. The initial contact resistance is 70 mΩ typ; it stays close to this value over 10⁹ switching operations. The 8W version costs approximately gld 0.5 in volume quantities.

Philips, Elcoma Div, Box 523, 5600 AM Eindhoven, The Netherlands. Phone (040) 757005. TLX 51573.

Circle No 393

Ampere Electronic Corp, Box 560, Hicksville, NY 11802. Phone (516) 931-6200.

Circle No 394

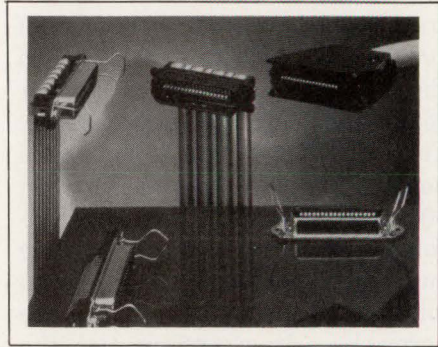

CONNECTORS

- Feature a 3A current rating
- Accept standard 28 AWG flat cable

The DL 50 Series ribbon connectors utilize 0.085-in. centerline contacts on both the mating end and the pc-board interface. They accept standard 28 AWG flat cable, which is terminated by the insulation-displacement method. The connectors are available in 24-, 36-, and 50-position sizes. The series offers metal-shell straight and right-angle receptacles with ball locks, as well as mating plugs and receptacles for use with 0.050-in.-center cables. The connectors spec a 3A current rating; the receptacles have a 500V ac voltage rating. Flat-cable limitations reduce current ratings for the plug and receptacles to 1A. Three contact options are available (8, 15, or 30 μin. of gold over nickel) for all the devices. \$3.23 (1000) for a 24-position right-angle pc-board receptacle with 8 μin. of gold.

Molex Inc, 2222 Wellington Ct, Lisle, IL 60532. Phone (312) 969-4550.

Circle No 396

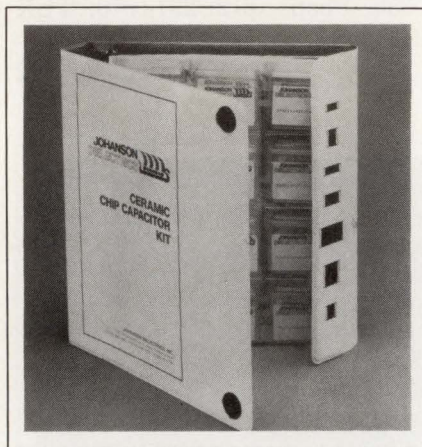

CAPACITOR KIT

- Includes popular NPO, X7R, and Z5U ceramic chips
- Chip-selector guide and technical manual provided

S-920 SMT prototype kits include the most popular values of NPO, X7R, and Z5U multilayer ceramic-chip capacitors. The kit, which is packaged in a special vinyl cover for shelf storage, includes 550 devices in the most popular capacitance values and in sizes 0805 and 1206. Each unit has nickel barrier terminations, and each is individually packed for easy access and immediate identification. The kit also includes a chip-selector guide and a 24-pg technical manual, which discusses the proper application of chip capacitors. \$95.

Johanson Dielectrics Inc, 2220 Screenland Dr, Burbank, CA 91505. Phone (213) 848-4465. TWX 910-498-2735.

Circle No 395

DRIVE ENCLOSURE

- No tools needed for drive installation
- Includes a 100W power supply

The SA-H163 enclosure is designed for applications that require removing, transporting, and storing dual 5¼-in. Winchester disk drives. It features pluggable drive capability along with a removable bracket

COMPONENTS & POWER SUPPLIES

(complete with power and data connectors) that you install on each drive. To remove a drive, you simply loosen two thumbscrews on the hinged cover, pull the handle on the bracket, and release the drive assembly from the docking connector. No tools are required for drive installation or removal. The enclosure also includes a 100W supply, exhaust fan, write-protect switches, and LED indicators for each drive. The front-panel connectors provide daisy-chaining capability for the controllers that support as many as four Winchester disk drives. \$1431.

Sigma Information Systems, 3401 E LaPalma Ave, Anaheim, CA 92806. Phone (714) 630-6553. TLX 298607.

Circle No 397

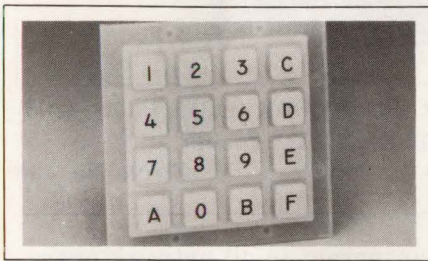

KEYPADS

- Can stand up to severe environmental conditions
- Keypads have a life of 10 million operations

These Sealedswitch keypads are designed to withstand severe environmental conditions and are available in industrial and military versions. The 3×4- and 4×4-in. models feature a 1-piece silicone rubber boot, which wraps around the pc board to form a complete seal when mounted. Switch legends, characters, or symbols are diffused into the key surface, making the entire front panel highly resistant to the effects of solvents, oils, most chemicals, heat, ultraviolet radiation, and scratching. The keypads' electrical specs include a 50-mA/28V dc contact rating, a 10-msec max bounce time, 1Ω max contact resistance, and 10-MΩ min insulation resistance. The me-

chanical specs include a life of 10⁶ operations, a 400g actuation force, and 0.02-in. key travel. The military versions meet or exceed the requirements of MIL-STD-810. \$40.75 and \$50.15 (100) for industrial and military 4×4-in. units, respectively.

IEE Inc, 7740 Lemona Ave, Van Nuys, CA 91409. Phone (818) 787-0311. TLX 4720556.

Circle No 398

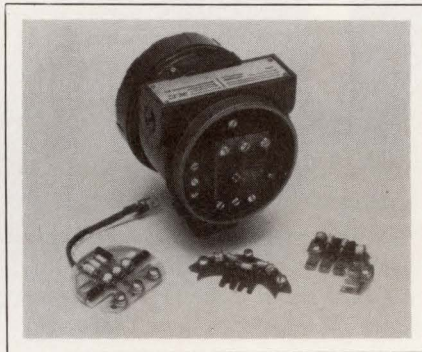

SUPPRESSORS

- Designed to protect analog control-loop transmitters
- 5-μA max standby current

The 420T and 423T transient voltage suppressors are designed to protect temperature and pressure transmitters in analog control loops. These field-installable parts are capable of protecting almost all popular transmitters. Available in four standard models, they provide line-to-line and line-to-ground protection. All of them include devices with maximum operating line voltages of ±25, ±28, ±36, ±50, and ±60V; the respective maximum line-to-ground clamping voltages for these parts are 44, 46, 60, 80, and 95V. They also feature a short-circuit failure mode that provides maximum protection. All the parts have automatic reset. The maximum standby current is 5 μA, and the operating range spans -55 to +100°C. From \$40 (100).

General Semiconductor Industries Inc, 2001 W Tenth Pl, Tempe, AZ 85281. Phone (602) 968-3101. TWX 910-950-1942.

Circle No 399

Valhalla Scientific AC/DC Automatic Calibration Systems

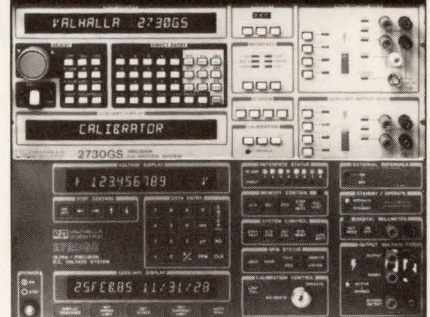

The Task Force

Create a Valhalla Calibration System for high accuracy, AC or DC Voltage, high currents, mobile use, high-speed closed loop testing - any demanding requirements - and be assured of top performance and long-term reliability.

Modularity is the key. Our Calibration Systems can fit any need including: DMM and Watt Meter Calibrations, Phase Angle Calibration, Wide band (50MHz) outputs expandable to 18GHz, AC/DC current (DC voltage to 8½ digits), Resistance and Oscilloscope calibration - to name a few.

Our systems use HP desktop (200 and 300 series) controllers, IBM XT/AT compatible series controllers with both IEEE-488 and RS232C communication capabilities and... the GPIB allows a multi-vendor configuration for special requirements.

Valhalla Automatic AC/DC Calibration Systems and standards free test engineers from manual operation, while providing the fastest, most reliable measurement data available.

Join the Force. Call 619-457-5576.

VALHALLA SCIENTIFIC

9955 Mesa Rim Rd. San Diego, CA 92121

NEW PRODUCTS

CAE & SOFTWARE DEVELOPMENT TOOLS

FORMAT CONVERTER

- Converts waveform data to any of nine formats
- Runs on IBM PCs and compatibles

The R900 Universal File Transfer software runs on IBM PCs, PC/XTs, PC/ATs, and compatible computers equipped with the vendor's data-acquisition or digital-oscilloscope interface boards. You load the R900 UFT software after acquiring a waveform or other real-time data (via one of the vendor's products) and storing the data on disk. The menu-driven UFT software can translate your data into a number of different formats for further processing and analysis. You can currently select the formats for Asyst, Asystant, DADiSP, dBASE III, ILS-PC1, ILS-PC2, Labtech



Notebook, Lotus 1-2-3, or MathCAD. \$199.

Rapid Systems Inc, 433 N 34th

St, Seattle, WA 98103. Phone (206) 547-8311. TLX 265017.

Circle No 400

μP SIMULATOR

- Simulates Clipper μP bus cycles
- Lets you verify timing of system hardware designs

The Clipper SmartModel is a software package that runs on workstations from Mentor Graphics (Beaverton, OR). The software provides a model of the CPU, FPU, and Cache/MMU logic contained in Fairchild's Clipper C100 32-bit μP. With the aid of simple commands that control the model, hardware designers can simulate bus cycles, timing sequences, interrupt processing, and reset processing at the full speed of the μP. Thus, you can repeatedly modify and verify your design without the expense of developing a wire-wrapped prototype board and assembly-language code to exercise it. This hardware-verification model costs \$2500; a full-function version that will execute assembly-language instructions is under

development.

Logic Automation Inc, 19545 NW Von Neumann Dr, Beaverton, OR 97006. Phone (503) 690-6900.

Circle No 401

MAP NETWORK TOOL

- Monitors network performance and collects statistics
- Stores and displays message frames

The token-bus frame analyzer (TBFA) is a software package that monitors token-bus-network performance in real time and lets you collect and store statistics relating to the traffic. You can select any type of ISO (International Organization for Standardization) message header or any segment of the medium-access-control layer as the trigger that initiates data collection. Because the TBFA is not part of the token-passing logical ring, it is

transparent to all network operations and does not interfere with them in any way. The software resides in four PROMs located on the vendor's MVME372 MAP interface module board; in this application, the board operates as a stand-alone processor and requires no backplane bus. The only other items required are a DEC VT100 or equivalent terminal, a modem that matches the network, and a power supply. \$2500.

Motorola Inc, Box 52073, Phoenix, AZ 85072. Phone (512) 440-2140.

Circle No 402

16M BYTES FOR PC/AT

- C and assembly-language programs address 16M-byte RAM
- Allows programs to run in protected mode

DOS/16M is a software package that lets C and assembly-language pro-

grams, running on an IBM PC/AT or compatible machine, address as many as 16M bytes of RAM. The package consists of a run-time library, which contains routines for managing extended memory and for starting and running programs in 80286 and 80386 protected mode under PC-DOS version 3. It also contains a symbolic debugger for protected-mode programs and source code for the run-time library and start-up code. When you use DOS/16M, it adjusts your program for protected-mode addressing, then switches the computer into protected mode before starting to execute the adjusted program. DOS/16M switches the computer back to real mode whenever it needs to service DOS or BIOS system calls or when it must service interrupt requests from devices that don't have protected-mode interrupt handlers. You don't need to rewrite or recompile your programs in order to

use DOS/16M; you need only to re-link them with the run-time library. You may also have to modify any arithmetic operations that your program performs on segment register values, and any parts of your program (such as interrupt handlers) that write into code segments of memory. \$29,000.

Rational Systems Inc., Box 480, Natick, MA 01760. Phone (617) 653-6194.

Circle No 403

CASE TOOL

- *Creates modular, function, and structure charts from a database*
- *Supplements the information from the Modular Design tool*

ProMod/SC automatically creates graphics structure charts from software-design data developed with the aid of the vendor's ProMod/MD CASE tool. The tool can create

three types of charts: modular network, function network, and function structure charts. Modular network charts show the connections between major system structures. Function network charts identify the import, internal, and export functions of the system. Function structure charts show conditional or repetitive calls of a function from the main program, multiple calls from one function to another, and recursive functions. Where appropriate, the graphics linkages show the data types of parameters that are passed over the linkages. You can display the charts on the screen and edit them, or you can send the charts to a pen plotter or laser printer. IBM PC version, \$500; VAX system version, \$1000.

Promod Inc., 23685 Birtcher Dr, Lake Forest, CA 92630. Phone (714) 855-3046.

Circle No 404

NEW RUGGEDIZED SCOPE PROBES

Just a phone call away.

\$35 P6103

50 MHz 10x
Compensation Range
15 to 35 pF

\$58 P6109

150 MHz 10x
Compensation Range
18 to 22 pF

These new passive voltage probes can be used with any oscilloscopes having matching compensation ranges.

Screw in tips mean easy repair, no downtime.

To order call toll free **1-800-426-2200**

In Oregon, call collect (503) 627-9000.

VISA and MasterCharge accepted.

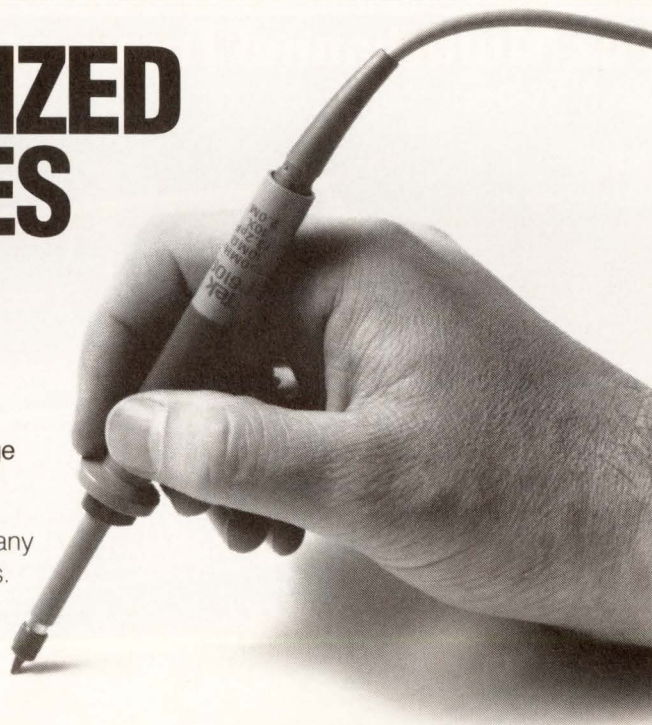

Tektronix
COMMITTED TO EXCELLENCE

LADDER LOGIC on the STD BUS!

The control power you need

- 40 PID loops • 32 stepper drums
- Full 4-function math

The expandability you want

- 416 analog and 1152 digital I/O points

At a price you can afford

Systems start at \$1295

I/O expansion approx. \$3 per point

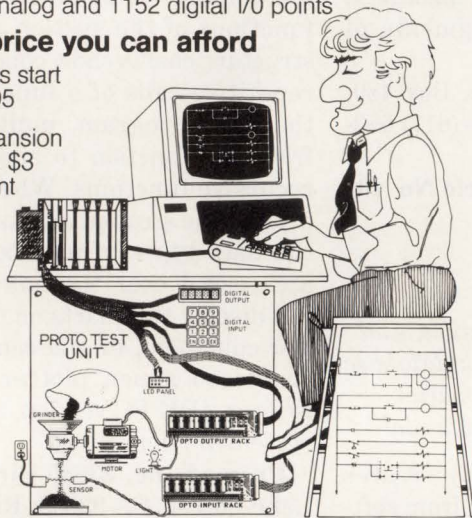

Computer DYNAMICS
COMPUTER DYNAMICS SALES

107 S. Main St., Greer, SC 29651
(803) 877-8700

CIRCLE NO 41

CY525 3rd generation STEPPER MOTOR CONTROLLER

most intelligent controller offers linear ramping, 10,000 steps/sec, unlimited stepping, change rate on the fly, read position on the fly, and much more.

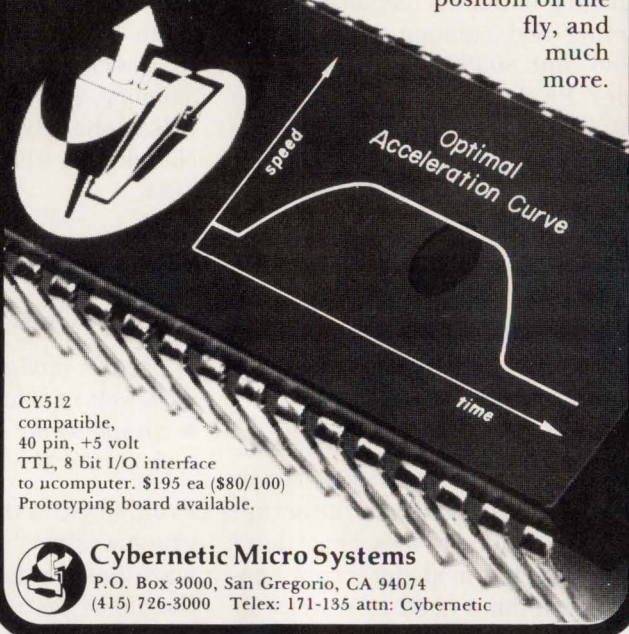

CY512 compatible, 40 pin, +5 volt TTL, 8 bit I/O interface to ucomputer. \$195 ea (\$80/100) Prototyping board available.



Cybernetic Micro Systems

P.O. Box 3000, San Gregorio, CA 94074
(415) 726-3000 Telex: 171-135 attn: Cybernetic

CIRCLE NO 42

Krenz Multichannel Transient-Recorder Series TRC 6000 "Global System Solution"

TRC 6000

- Extensible up to 48 channels
- 0.1% accuracy
- Simultaneous recording
- Up to 50 MHz sample rate
- Up to 512 k-words/channel
- 8, 10, 12 Bit resolution
- Differential input
- Fully computer-controllable
- Block mode
- Window-triggering

Please ask for more detailed information.



TRD 2000

- Ruggedized MS-DOS computer
- Internal monitor 5 x 9 inch
- External monitor 14 inch
- XT/AT-compatible
- Highspeed graphic
- 720 x 348 pixel
- Floppy- and harddisc drive
- IEEE 488/RS 232

Software

- Krenz
- ASYSTANT®
- ILS®



Krenz Electronics

KRENZ ELECTRONICS, Inc.
23132 La Cadena Drive, H
Laguna Hills, CA 92653
Tel. (714) 770-9070
Tlx. 9102503320 ELN 62032333

See us at MIDCON '87 Booth #963

NEW PRODUCTS

TEST & MEASUREMENT INSTRUMENTS

8051 EMULATOR

- *Emulator runs at 12 MHz*
- *Works with NMOS and CMOS versions*

The EC 7000/8051 works with all members of the 8051 family, including the 8051, 8052, 8031, 8751, and 8752. It handles NMOS and CMOS versions. The emulator runs at 12 MHz with no wait states. It features 64k bytes of emulation program memory and 64k bytes of emulation data memory; you can set a breakpoint on each program-memory location. The unit has a 4k×48-bit trace memory and a time stamp with 1- μ sec resolution. For control, the emulator requires an IBM PC, PC/XT, PC/AT, or compatible computer. \$5800.

Applied Microsystems Corp,

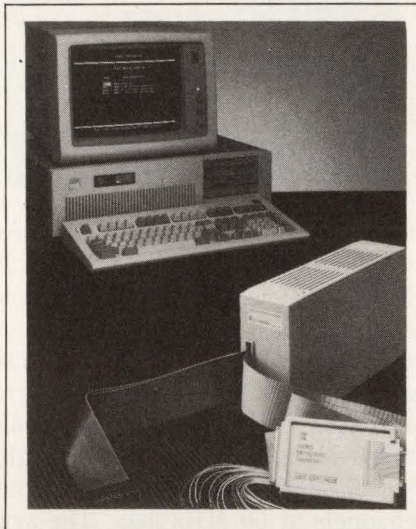

5020 148th Ave NE, Box 97002, Redmond, WA 98073. Phone (800) 426-3925; in WA, (206) 882-2000. TLX 185196.

Circle No 406

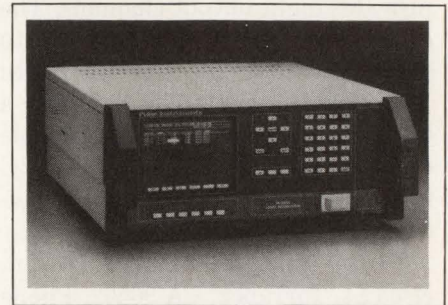

LEVEL TRANSLATOR

- *Programmable level translator accepts TTL input*
- *Output compatible with GaAs, ECL, TTL, and CMOS devices*

The PI-6800 programmable level translator accepts TTL-level input signals and translates them into output that is compatible with GaAs, TTL, CMOS, and ECL devices. The translator's output repe-

Race Card

The HK68/V2F is a high-performance VME microcomputer with race-bred 32-bit power for real-time applications.

High engine output and economical, dependable performance are just the start of the HK68/V2F's standard equipment:

- Up to 25MHz Motorola 68020 CPU
- Up to 4MB of on-board DRAM with parity
- 128K EPROM
- Serial Port
- Mailbox interrupt support
- VSB compatible memory expansion bus

Optional racing equipment includes 68881 Floating Point Coprocessor and no wait-state DRAM.

HEURIKON CORP

Take Heurikon's HK68/V2F for a test-lap today.
Call toll-free: 1-800-356-9602 (ext. 405).

CIRCLE NO 7

3201 Latham Drive ■ Madison, WI 53713

tition rate is 100 MHz max and its rise times are 2.5 nsec min. The device accommodates as many as eight pc boards, and each board provides eight output channels. The output voltage range is $-5V$ to $+10V$ (-0.4 to $+5V$ into 50Ω) with 10-mV resolution. The unit has a built-in CRT and is programmable over the IEEE-488 and RS-232C interfaces. \$6000 to \$13,500. Delivery, eight weeks ARO.

Pulse Instruments, 1234 Francisco St, Torrance, CA 90502. Phone (213) 515-5330.

Circle No 407

BOARD TESTER

- Performs short-circuit, in-circuit, and functional tests
- Software generates some tests automatically

The GR2750 board-test system has a 32-bit CPU. Each pin of the tester can perform analog, digital, func-

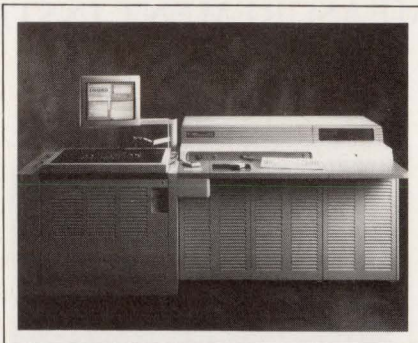

tional, or in-circuit tests. Pins provide digital test rates to 10 MHz (20 MHz multiplexed). Every pin possesses a $16k \times 4$ -bit memory ($32k \times 4$ bits max). The ATE can generate clock signals to 50 MHz and synchronize with external clock signals to 40 MHz. It can also scan eight analog channels at 10 MHz or four channels at 50 MHz max. The system's software automatically generates pc-board short-circuit tests and in-circuit tests for analog and digital components; the software includes the HILO simulator. \$600,000 to

\$1,000,000. Delivery, 90 days ARO. **GenRad Inc**, 300 Baker Ave, Concord, MA 01742. Phone (617) 369-4400.

Circle No 408

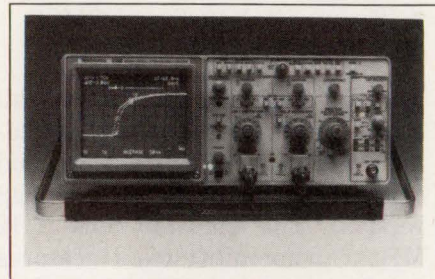

DIGITIZING SCOPE

- Combines digitizer with analog scope
- Drives X/Y plotter directly

The 2221 oscilloscope combines a 60-MHz analog oscilloscope with a 20M-sample/sec digitizer. The digitizer can store 4096 8-bit samples in single-channel mode or two 2048-

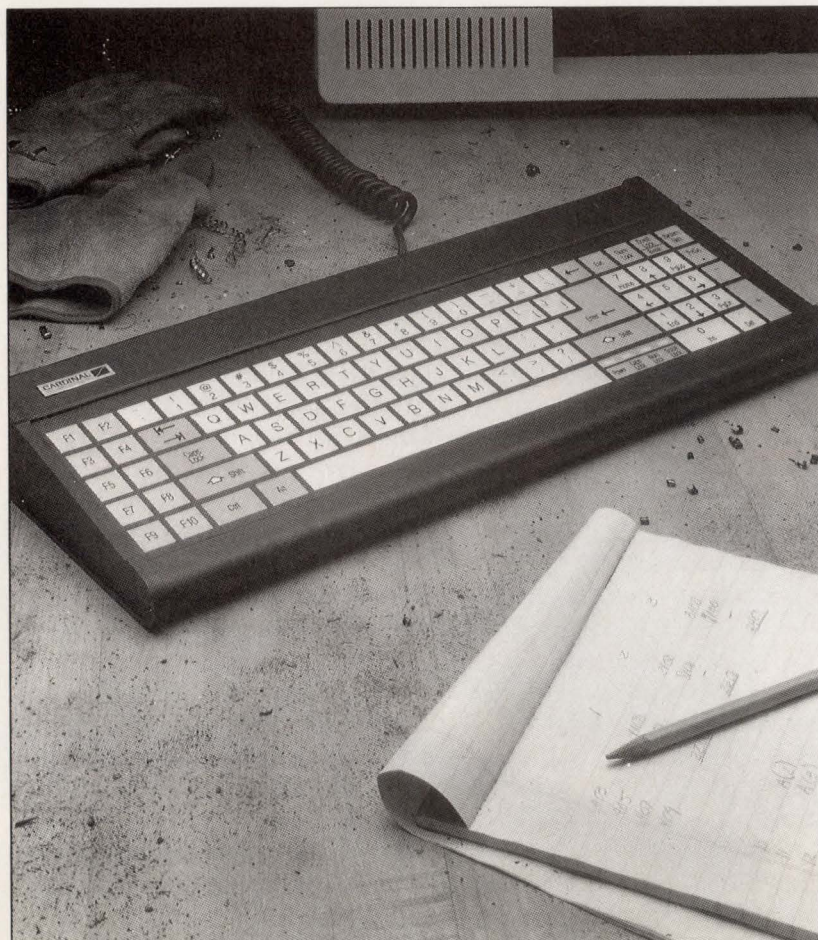

Works Hard Without Breaks.

The new Cardinal KB695 membrane keyboard goes wherever the work is—even into hostile environments that cause standard full-travel units to take frequent breaks for cleaning and service. For industrial controls, robotics, laboratory use, remote data entry, public access—wherever you need reliable, full-featured performance—Cardinal KB695 keyboards keep you on-line.

IBM compatible. A built-in auto-configuring capability allows you to plug in directly to IBM PC, XT, AT, and "clones". No special wiring or interfaces. And Cardinal KB695 keyboards give you all the keys and functions of a full-travel keyboard, so you're ready to go to work immediately.

Tough but easy to use. Rugged flexible-membrane key switches feature finger-positioning overlays for positive feel and light-touch response. Dust, dirt, and other contaminants that can foul and "short" a full-travel keyboard can be quickly removed from the flat membrane surface with a simple wipe. Anodized housings resist corrosion and wear. And large, easy-to-read keypads are color-coded by function for easy operation—even in dimly-lit locations.

Call 800-722-0094 (717-295-6922 in PA) for more information or to order. Or write: Cardinal Technologies, Inc., New Holland Avenue, Lancaster, PA 17604-7628.

IBM and PC, PC/AT, PC/XT are registered trademarks of International Business Machines, Inc.

CARDINAL
TECHNOLOGIES, INC. 

sample records in dual-channel mode. The scope can record 100-nsec glitches. In the so-called envelope mode, it can also display the maximum and minimum excursions of a repeated waveform. The scope drives an X/Y plotter directly; IEEE-488 and RS-232C interfaces are optional. \$3995.

Tektronix Inc., Box 500, Beaverton, OR 97077. Phone (800) 426-2220; in OR, (503) 627-9000.

Circle No 409

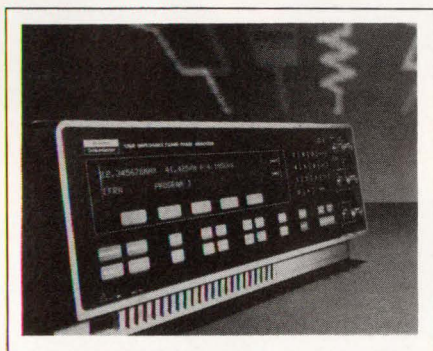

ANALYZER

- *Measures impedance and frequency response*
- *Interfaces to component handlers for batch sorting*

The Model 1260 impedance/gain-phase analyzer measures the impedance of components or electronic circuits and measures their frequency response over the range from 10 μ Hz to 32 MHz. The instrument digitizes input signals to 15-bit resolution on two independent voltage channels and one current channel. It employs a single-sine-correlation technique to provide fast and precise measurement of both amplitude and phase. Its overall frequency-response accuracy is 0.01 dB. You can perform frequency, amplitude, or bias sweeps by using the instrument's built-in voltage and current generators. Its post-measurement processing includes normalization of measured parameters or limit checking against simple or complex limit values. The unit comes with IEEE-488 and RS-232C interfaces, so you can control the unit remotely

and obtain hard-copy printouts of the results. Battery-backed RAM provides nonvolatile storage for as many as nine test programs, and you can protect six more EEPROM-resident test programs with a key-switch. £11,500.

Solartron Instruments, Victoria Rd, Farnborough, Hampshire GU14 7PW, UK. Phone (0252) 544433.

TLX 858245.

Solartron Instruments Inc, 2 Westchester Plaza, Elmsford, NY 10523. Phone (914) 592-9168. TLX 145487.

Circle No 410

Circle No 411

**SOLID-STATE
PRESSURE
SENSORS**

You can't beat solid-state pressure sensors for reliability, size, and price. And they easily interface with the other electronic components in your system. Applications include: industrial, automotive, medical, aerospace, and consumer.

AT THE RIGHT PRICE. We now have a new family of low-cost piezoresistive pressure sensors packaged in both single-in-line and dual-in-line configurations. Models are available for measurement of corrosive liquids and moist air. They are easily mounted on PC Boards, and are interchangeable with either an integral gain-set resistor or current-source resistor. Our pressure sensors are available in standard package outlines, but we can also customize packages for your application.



- 0-2 PSI to 0-5000 PSI
- Gage, Absolute, Differential
- Accuracy from 0.1% Span
- Gases and Corrosive Liquids
- 3x Overpressure
- Temperature Compensated
- 316 Stainless Steel Diaphragm
- Sensors: 100mV & 200mV
- Transducers: 1-6V
- Transmitters: 4-20mA

ICSSENSORS

1701 McCarthy Blvd., Milpitas, CA 95035
FAX: (408) 434-6687 Telex: 350066 Phone: (408) 432-1800

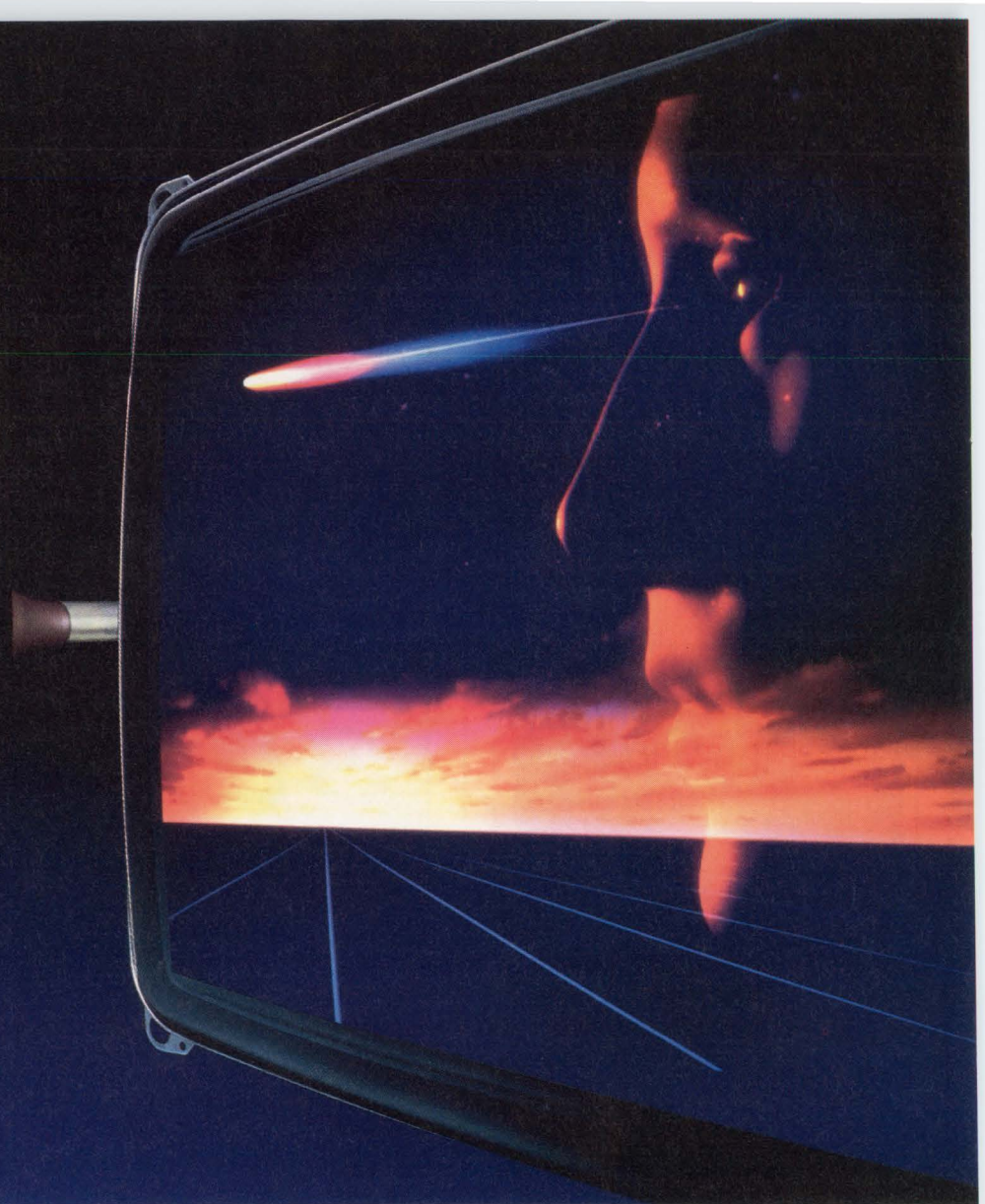
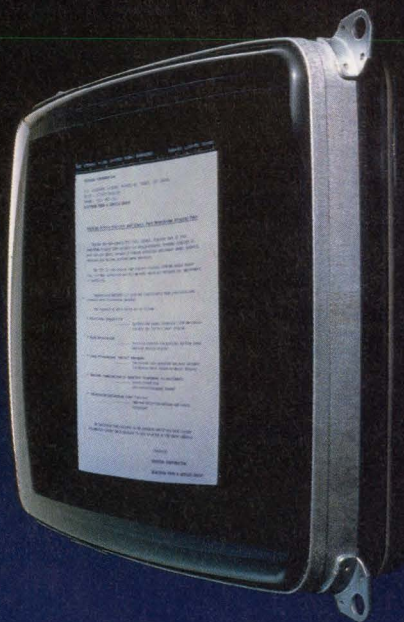

Ergonomic Engineering Reaches a New Height With a Flat Screen and Invar Mask Equipped Display Tube

Toshiba, always in pursuit of greater clarity in displays, has changed the concept of display tube technology. The FS tube was born of our quest for improved ergonomic engineering. It is not only Flat and Square, but it now has an Invar Mask. The results are clarity, brightness and reduced ambient light reflection for fatigue-free viewing. The Toshiba FS display tube also boasts high reliability and high quality and comes in a wide lineup to meet virtually any OA equipment need.

WIDE LINEUP

| | | Screen dot pitch (mm) | Display area (mm) | Display capability (pixels/line) | Faceplate radius (mm) |
|------------------------|--------------|--------------------------|----------------------|-------------------------------------|--------------------------|
| 9" (7.5V) FS | E8075** | 0.28 | 140 × 105 | 460 | 900 |
| 10" (9V) Conventional | E2957 | 0.28 | 170 × 130 | 580 | 495 |
| 13" (12V) FS | E8046/E8077 | 0.36/0.28 | 230 × 170 | 590/760 | 1100 |
| 12" (12V) Conventional | E8001/E8032 | 0.36/0.28 | 220 × 160 | 560/720 | 647 |
| 15" (14V) FS | E2995/E2994 | 0.39/0.31 | 260 × 190 | 610/770 | 1200 |
| 14" (13V) Conventional | E2971/E2894 | 0.39/0.31 | 250 × 180 | 590/740 | 575 |
| 17" (16V) FS | E8162 | 0.26 | 300 × 220 | 1060 | 1370 |
| 16" (15V) Conventional | E2864 | 0.31 | 290 × 210 | 820 | 653 |
| 21" (20V) FS | E8142/E8170* | 0.42/0.31 | 370 × 280 | 810/1100 | 1730 |
| 20" (19V) Conventional | E2862 | 0.31 | 360 × 270 | 1000 | 820 |

*Under development **Full pincushion correction free

TV Picture Simulated

TOSHIBA

Toshiba America, Inc.: 1101 A Lake Cook Road, Deerfield, IL 60015, U.S.A. Tel. (312) 945-1500

EDN PRODUCT MART

This advertising is for new and current products.

Please circle Reader Service number
for additional information from manufacturers.



Integrated with
OrCAD and SCHEMA

EE DESIGNER Layout \$695

Finishes the job that OrCAD and SCHEMA start.

CAE/CAD integrated software package for those needing PCB layout only, or for those already using a schematic design software package. Incorporates many advanced features of the EE DESIGNER II layout module plus true netlist translation and symbol conversion from OrCAD and SCHEMA. Includes netlist entry from keyboard, 12.5 mil grid, and user-definable trace widths. Multilayer capability. For IBM PC, XT, AT or compatibles. 30 day money back guarantee.

Call 1-800-553-1177 today to order your package. Bank cards welcome.

VISIONICS
CORPORATION
343 Gibraltar Drive
Sunnyvale, CA 94089

OrCAD and SCHEMA are registered trademarks of OrCAD Systems Corp. and Omation Inc., respectively.

CIRCLE NO 325

COUNTER/TIMER
INTERRUPT EXPANSION
DIGITAL I/O

\$695.00

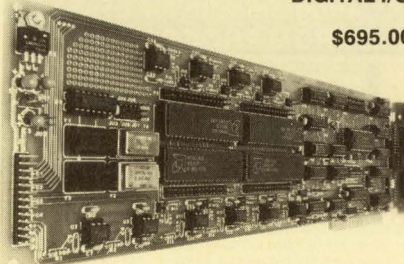

MULTI-PURPOSE CARD FOR PC, XT, AT

FEATURES INCLUDE:

- Four Am9513's provide 20 independent, cascadable 16 bit counters with programmable synchronous command execution.
- Ten High Speed LSTTL optocouplers.
- 8259A Programmable interrupt controller.
- Independent 8 bit Digital I/O channels.

TYPICAL APPLICATIONS:

- Direct counting to 7 MHz.
- Incremental encoder position sensing.
- Event timing.
- Real time interrupt control.
- Pulse and square wave signal generation.

CONRAGAN SYSTEMS COMPANY, INC.
1610 Dell Avenue, Suite Q,
Campbell, California 95008 (408) 866-1278

CIRCLE NO 326

EE/EPROM PROGRAMMER...with
Eraser...the "BEST" for \$1295.*



DIGELEC Model 824

- RAM 512K, upgradeable to 2048K
 - Programs 2716 to 271024, & equivalent
 - MOS, CMOS, 40-pin micro P's, no adapters
 - Programs virtually all mfg's, 220+ devices
 - Time-saving quick-pulse & Int. algorithms
 - Complete stand-alone editing, 16-char. display
 - RS-232 Remote control, translation formats
 - Optional IBM-PC/AT menu-driven S.W.
- * Special US Domestic Introductory Price

digelec PROM & LOGIC
PROGRAMMERS

800-367-8750, NJ 201-493-2420.
DIGELEC, Inc., 1602 Lawrence, Ocean, NJ 07712

CIRCLE NO 327

Cross Assemblers Universal Linker Powerful Librarian

PC/MS DOS
micro VAX
VAX VMS
VAX UNIX/UL TRIX

- Now - High Speed
- Powerful Macros
- Absolute or Relocatable Code
- Compatible with Chip Manufacturer's Assemblers
- Conditional Assembly
- \$295 Up for Complete Packages

Software Tools for Professional
Development



19 Jenkins Ave., Box 1312
Lansdale, PA 19446, U.S.A.
Tel: 215-362-0966
Telex: 4948709 ENERTEC

CIRCLE NO 328

MEMULATOR II™ In-Circuit EPROM Emulator \$375*

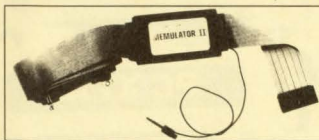

- Download via RS-232 up to 32K bytes in less than 10 seconds.
 - Emulates 2716 - 27C256 devices
 - Accepts Intel hex, Motorola S-record, and straight binary formats.
 - 100ns or *150ns access times.
 - Monitor command set in firmware.
- Inquire about our 16-bit in-circuit EPROM emulator.

MEMOCOM
DEVELOPMENT
TOOLS

1920 Arbor Creek Drive
Carrollton, Texas 75010
214/446-9906

CIRCLE NO 329

A Simple Upgrade to 16/32 Bit Performance

- 10 MHz 68008 processor
- One megabyte linear addressing space
- 68901 Multi-Function Peripheral
 - programmable serial port
 - 8-bit parallel port
 - multi-mode timers
- Both polled and vectored interrupts
- Three "universal" memory sockets
- Battery-backed real time clock
- Optional battery backup for RAM
- Supported by Microware's OS-9 68K operating system
- \$371.00 each in 50-100 quantities

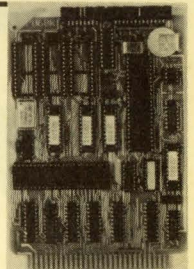

**CPU-68K8
Processor STD
Bus Card**

WZ
ELECTRONICS INC.
Route 12, Box 322
Indianapolis, IN
46236
Phone:
317-335-2128

CIRCLE NO 330

To advertise in Product Mart, call Joanne Dorian, 212/463-6415

PLD PROGRAMMER

\$1295 Including PC software

- * Supports over 200 PLD's, including bipolar, CMOS, and erasables.
- * Universal electronics; software driven from PC/XT/AT or compatible.
- * Convenient upgrades on disk; no firmware or personality modules.
- * Uses standard JEDEC files; supports 128 test vectors and full screen edit.
- * Supported by Nicolet Instruments - over 20 years in high technology.
- * Just \$1295 complete, including new device updates!

Nicolet 800-NICOLET (642-6538)
or 608-273-5008.

CIRCLE NO 331

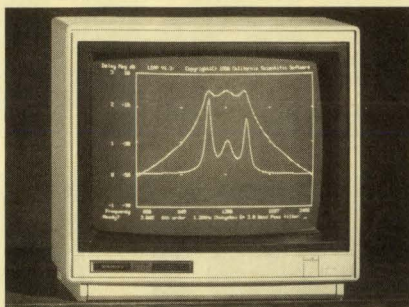

NEW ENGINEERING SOFTWARE

Filter designs active filters up to order 30. Bessel, Butterworth, Chebyshev, Allpass; High, Low Band-pass and Bandstop. Fully menu driven, Filter designs, plots, and selects component values for any filter in seconds. **LSAP analyzes linear systems** producing Bode, Nyquist, Impulse, Step Response and Root-Locus plots. **Micro-CSMP simulates control and servo systems** with full support for non-linear behavior. Filter is \$750, LSAP is \$450, Micro-CSMP is \$900 for the IBM PC.

California Scientific Software
1159 North Catalina Ave, Pasadena, CA 91104
(818) 798-1201

CIRCLE NO 332

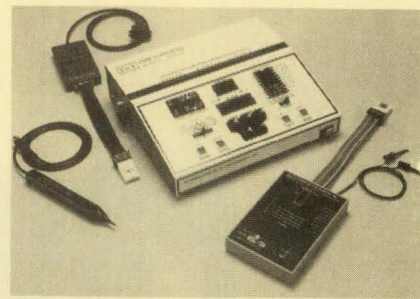

INSTRUMENT PAIR FOR IC IN-CIRCUIT TESTING

M-5700C Logic Scanmaster includes universal logic state indicator, logic pulser and clip, automatic bad level detector, auto-ranging DVM, pin to pin push-button interface of the signal to scope, counter, etc. M-150 Digital Comparator compares known good IC to DUT in-circuit. This instrument combination offers fast, accurate process to troubleshoot digital ICs to component level. Price \$1,695.00

Information Scan Technology
487 Gianni Street, Santa Clara CA 95054
(408) 988-1908

CIRCLE NO 333

PGA & LCC PROTOTYPE

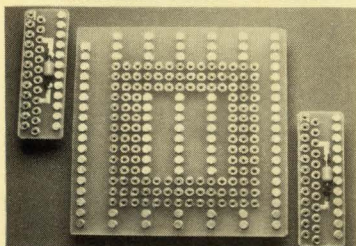

TEST ADAPTORS - VLSI

Ironwood's line of VLSI prototype adaptors allow prototyping of devices from 24 pin (video RAM ZIP), Shrink DIP, to 240 pin PGA, PIP families 80X86 and 680X0 along with many other patterns. **Annotated test adaptors** for 68010, 68020, 80186, 80386. All gold Machined pins / most wirewrap panel patterns.

Customs - quick turnaround.

IRONWOOD ELECTRONICS, INC
P.O. BOX 21-151
ST. PAUL, MN 55121
(612) 431-7025

CIRCLE NO 334

Don't Burn, Shoot, or Blow ... Program with the EP-1 EPROM PROGRAMMER



\$349

- Free PC DOS software or RS-232 to any computer.
- Reads, Programs, and copies over 250 EPROM's and EEPROM's from AMD, Intel, SEEQ, TI, Fujitsu, Hitachi, Toshiba, and 21 others.
- 2716-27512, 27011, 25XX, 28XX, 87XX, 687XX, Including CMOS and -A suffix.
- Programs 87C51, 8749, 8741A, 8742 and other microcontrollers with optional heads.
- Splits 16- and 32-bit files.
- Generates and checks checksums.
- Batch mode operation works with Make.
- Reads and Generates Intel, Motorola, Tekhex, Straight hex, and binary files.
- 30 day money back guarantee.
- UV Erasers for \$34.95.

CALL TODAY FOR MORE INFORMATION

BP MICROSYSTEMS

10681 Haddington, #190 / Dept. E1
Houston, Texas 77043
(800) 225-2102 (713) 461-9430 Telex: 1561477

CIRCLE NO 335

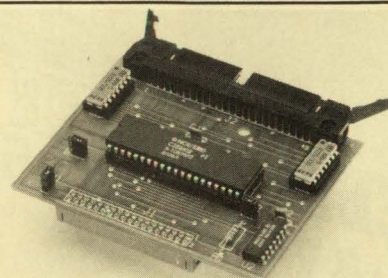

SCSI BUS INTERFACE MODULE

The SBSxSCSI provides the industry standard SCSI interface (ANSI X3T9.2) on a single-width SBX module. Intel iSBX™ multimodule (IEEE P959 I/O Bus) compatibility assures you of a reliable connection to your host board. A software driver example is available to simplify programming.

Call or write for more information.

Single Board Solutions, Inc.
20045 Stevens Creek Blvd.
Cupertino, CA 95014
(408) 253-0250

CIRCLE NO 336

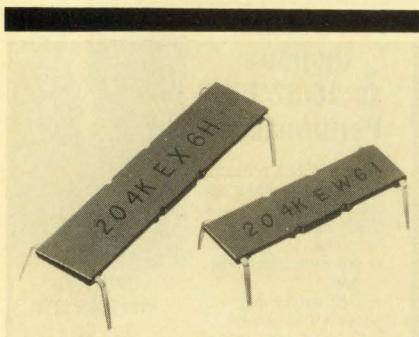

MICRO/Q II

FOR A DECOUPLING CAPACITOR THAT SAVES SPACE, DEFEATS NOISE, IS SUITABLE FOR MILITARY APPLICATIONS AND BEATS HUMIDITY, HEAT AND COLD:

ROGERS MICRO/Q® II
Rogers Corp., 2400 S. Roosevelt,
Tempe, AZ 85282. 602/967-0624

CIRCLE NO 337

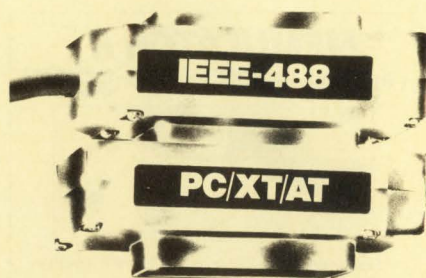

GP-IB, HP-IB CONTROL FROM YOUR PC.

- Control instruments and peripherals.
- Supports BASIC, C, FORTRAN, and Pascal.
- Use with ASYST™ Lotus Measure™
- Fast and easy-to-use. Thousands sold.
- Hardware and software - \$395 complete.



Capital Equipment Corp.
99 South Bedford St.
Burlington, MA. 01803

Call today (617) 273-1818

CIRCLE NO 338

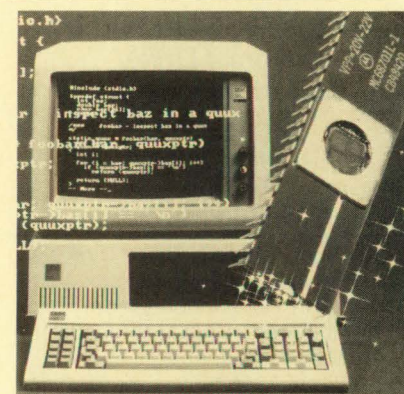

6800-Family Development Software

Combine our software and your editor for a powerful development system. Our C-Compilers feature a complete implementation (excluding bit fields) of the language as described by Kernigan & Ritchie and yields 30-70% shorter code than other compilers. Our Motorola-compatible Assemblers feature macros and conditional assembly. Linker and Terminal Emulator are included. **Wintek Corporation**, 1801 South St., Lafayette, IN 47904. (800) 742-6809 or (317) 742-8428.

CIRCLE NO 339

To advertise in Product Mart, call Joanne Dorian, 212/463-6415

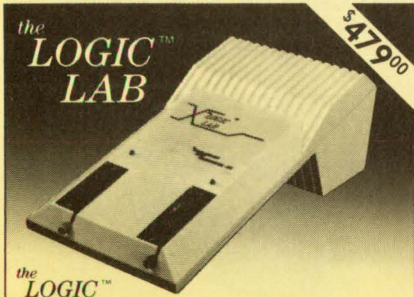

the LOGIC LAB
is a complete logic development system

- FAST MAP™ quickly and easily transforms your logic equations into a JEDEC fuse map.
- The LOGIC LAB™ PROGRAMMER produces programmed GAL® devices to be tested in your prototype circuit.
- The included GAL® devices may be reprogrammed up to 100 times as you refine your design and test new prototypes.
- The LOGIC LAB PROGRAMMER may produce your GAL® devices for production or you may send the JEDEC file to a programming center and produce nearly any manufacturer's PLD.

Demo Disk Available from:
Programmable Logic Technologies, Inc.

P.O. Box 1567 Longmont, CO 80501 GAL is a registered trademark of
Ph. (303) 772-9059 FAX (303) 772-5617 Lattice Semiconductor Corporation

CIRCLE NO 340

A Portable Universal Development System For Only \$1987

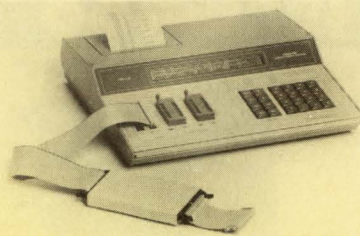

Ideal for in-house development, production & field service. The new MDL-128™ combines: A 40 channels by 4K deep 20 MHz Logic Analyzer, an 8/16 bit 128K byte Emulator, and a dual EPROM Programmer in one slim and easily portable unit. Full of outstanding features!

- Stand-alone or PC-based operation
- Real-time emulation and tracing for 8/16 bit microprocessors
- Single step and breakpoint capabilities
- Multi-level trigger, loop and delay counters
- Fast EPROM programming with no personality modules required
- Powerful and easy to use editing functions
- Disassembler for edit and trace data
- A 40 column internal thermal printer
- Operates on rechargeable batteries or AC adaptor

YU INSTRUMENTS

6534 Teakwood Street, Cypress, CA 90630 (714) 952-4622

CIRCLE NO 341

Drive Your VMEbus or Multibus II

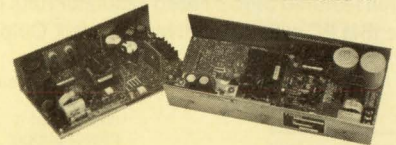

With a TODD Switching Power Supply

- 150 to 700 Watts Outputs—Meet System Needs
- Multiple Output +5 volts, +12 volts, -12 volts
- High Sink Current AC Power Fail
- More Than 100,000 Hours MTBF
- 31% Smaller Packages—Up to 4 watts/in³
- Clean, Simple, Rugged—Reliable in Harsh Environments
- ...and more.

If your job is to design a VMEbus or Multibus system, TODD has the smaller, low-cost, reliable switcher to give your system a competitive edge. Call 1-800-223-TODD, 516-231-3366, or write:

TODD PRODUCTS CORP.

50 Emjay Blvd., Brentwood, NY 11717

CIRCLE NO 342

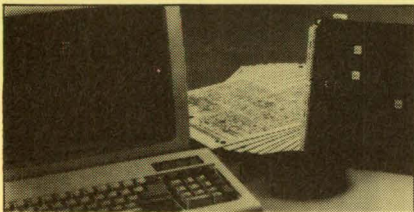

INTRODUCING DC/DESIGN™

Design Computation's complete PCB design package with schematic capture \$975

A true high-end CAE/CAD design tool that every electrical engineer can afford. For IBM PCs and compatibles, DC/DESIGN is feature-packed with schematic capture, parts placement, interactive autorouting and much more.

Our professional one-mil. diagonal autorouter is also available. We challenge you to find a better PCB design package.

30 day money-back guarantee. Call today to place your order or for more information. Demo available.

DESIGN COMPUTATION

Ten Frederick Avenue
Neptune, NJ 07753
(201) 922-4111 TWX: 510-601-8352
Visa and MasterCard accepted

CIRCLE NO 343

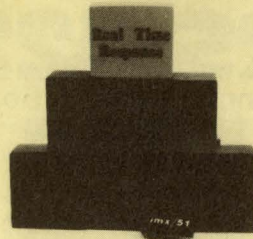

8051 Executive

imx/51® version 2.1 for the 8051 microcontroller series has demonstrated a 28% improvement in task context switch time and interrupt latency while completely compatible with version 1.3. Modeled after VRTX® (a registered trademark of Ready Systems, formerly Hunter & Ready) for the 8086 and 68000 processors, imx/51 provides 21 service calls in a 2K ROM for task control, message passing with mailboxes and queues, interrupt assist, and timing management. The imx/51 package includes manual, four source code examples, and duplicate ROMs containing imx/51. Call Rob Cianci at (305) 869-8168.

IMC

2400 Westwood Drive, Longwood, FL 32779

CIRCLE NO 344

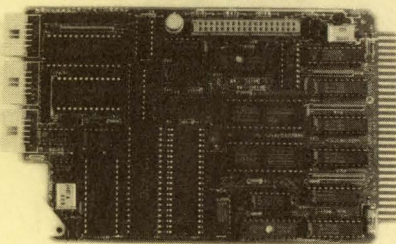

CMOS 80C88 SINGLE BOARD STD BUS COMPUTER

Features the 16-bit 8088 with 8087 coprocessor socket and 1 Mbyte addressing. On-board functions include 2 JEDEC 28-pin memory sockets for up to 128K bytes of RAM, EPROM, or EEPROM. Includes one RS-232/RS-422 serial port, 8259A interrupt controller, 3 16-bit counter/timers, SBX connector, and Watchdog timer. Available in NMOS/TTL or CMOS from

WinSystems, Inc.
PO Box 121361
Arlington, TX 76012
817/274-7553

CIRCLE NO 345

LOW COST DISTRIBUTED DATA ACQUISITION AND CONTROL

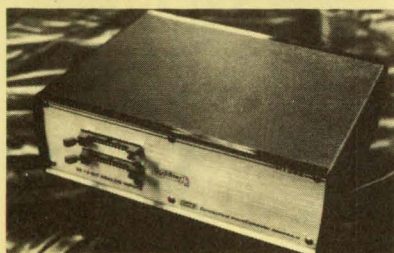

- Analog and digital I/O modules
- Up to 255 modules on one port
- Multidrop up to 4,000 feet
- 8 and 12 bit analog I/O
- Up to 64 digital I/O channels
- On board timer
- Automatic acquisition
- Data buffer to 40960 bytes
- High speed (up to 10,000 pts/sec)
- Stand alone operation
- RS-232/RS-422/RS-485/GPIB
- Prices start at \$495.00

Connecticut microComputer, Inc.
PO Box 186, Brookfield, CT 06804
TEL: 203-354-9395 800-426-2872
TWX: 710 456-0052

CIRCLE NO 346

EPROM/PAL Prog. LOGIC/DATA Analyzer

IBM PC

| | |
|------------------------------------|-------|
| EPROM PROGRAMMER | \$350 |
| 2716 Through 271024 | |
| PAL OPTION | \$250 |
| 20 and 24 Pin Pals | |
| MP OPTION | \$100 |
| 8741/42/48/49/51 | |
| BIPOLAR OPTION | \$350 |
| 16, 18, 20 & 24 Pin Proms | |
| HITACHI/INTEL ADAPTORS | \$ 75 |
| Works with any Generic EPROM Prog | |
| LOGIC ANALYZER | \$995 |
| 50 MHz, 8 Channel expandable to 32 | |
| EPROM SIMULATOR | \$395 |
| Simulates 2716 Through 271024 | |

FREE DEMO DISK

ams 2780 S.W. 14th Street
Pompano Beach, FL 33069
1-800-9PC-FREE 1-305-975-9515

CIRCLE NO 347

DC-DC CONVERTER PULSE TRANSFORMER FILTER BAND PASS

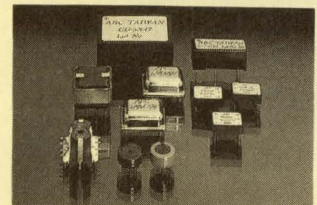

Our DC-DC converters, pulse transformers & band pass filters is now complete with excellent functions. We also supply choke coils, power chokes, linearity coils, toroidal coils, pulse transformers, coupling transformers, power transformers and others. Send for details today!

*OEM and Agent Inquiries Invited



ABC TAIWAN ELECTRONICS CORP.
No. 422, Sec. 1, Yang Fu Rd., Yangmei 32627,
Taoyuan, Taiwan, R.O.C. Fax: (03) 4755503
Tel: (03) 4788088, Telex: 32379 ABCEC

CIRCLE NO 348

To advertise in Product Mart, call Joanne Dorian, 212/463-6415

Analog Circuit Simulation

A full featured SPICE based simulator runs on the IBM PC with interactive Input and Output

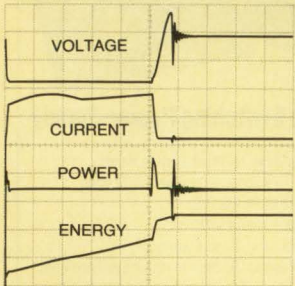

These waveforms show an IS_SPICE analysis of a power supply snubber. Intu_Scope was used for display and computation of power and energy. The output shown used an Intu_Scope plotter utility

PRE_SPICE, \$200.00: Interactive control, Monte Carlo Analysis, Optimization, libraries and parameter evaluation.
IS_SPICE, \$95.00: Performs AC, DC and Transient analysis.
Intu_Scope, \$250.00: Displays, manipulates and plots data. Programs are not copy protected, come with a 30 day money back guarantee and require PC with 640K RAM, fixed disk, coprocessor and CGA or EGA or Hercules graphics.



P.O. BOX 6607
 San Pedro, CA 90734-6607
 Tele: (213) 833-0710

CIRCLE NO 349

IEEE-488

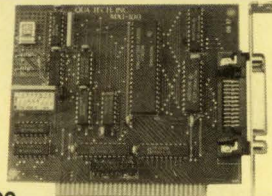

MXI-100

- GPIB controller board for IBM PC/XT/AT
- Control up to 14 Devices
- User friendly Software Commands
- DMA Transfer to 200k byte/sec.

\$345.00 including software
QUA TECH, INC.

478 E. Exchange St. Akron, OH 44304
 (216) 434-3154 TLX: 5101012726

CIRCLE NO 350

IBM COMPATIBLE RS232 EASI-DISK 3 1/2-5 1/2" FLOPPY DATA STORAGE & TRANSFER SYSTEM



Information Transfer to/from Non IBM Compatible Systems to/from IBM & Compatibles: (Over RS-232 or 488 Interface).

- Reads & Writes MS DOS Disks
- RS-232/488 I/O
- Rugged Portable Package/battery option
- ASCII or Full Binary Operation
- Baud Rate 110 to 38.4K Baud

28 other systems with storage from 100K to 35 megabytes.

ANALOG & DIGITAL PERIPHERALS, INC.
 815 Diana Drive Troy, Ohio 45373
 513/339-2241 TWX 810/450-2685

CIRCLE NO 751

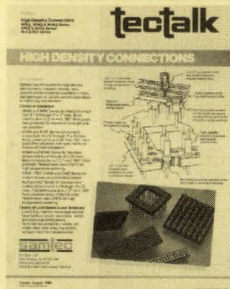

Samtec offers Hi-density Terminal Guide

New 12-page Samtec "Guide to High Density Connectors" describes technical features of high pin count pin grid array connectors. Over 150 standard patterns are shown as well as cross reference chart to match semiconductor part to appropriate mating connectors. Samtec pin grid arrays come in standard 8x8 to 20x20 arrays. Custom patterns are easy to specify in arrays from 2x2 to 20x20. Solid body and open body designs are available with low insertion force with surface mount, low profile, solder or wrap-pin. Request Catalog Supplement 186-04. Contact:

Samtec, Inc.
 P.O. Box 1147, New Albany, IN 47150
 Phone: (812) 944-6733. FAX: (812) 948-5047

CIRCLE NO 752

RS-422 Communications Board

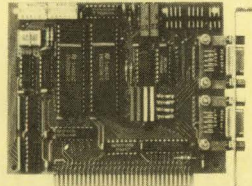

- For IBM-PC/AT/XT and compatibles
- Dual RS-422/RS-485 interface
- Differential drivers to 4000 ft.

Fast Delivery
QUA TECH, INC.

478 E. Exchange St. Akron OH 44304
 (216) 434-3154 TLX: 5101012726

CIRCLE NO 753

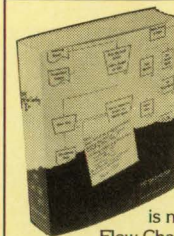

Flow Charting II+ The New Plus for Fast Flowcharting

FLOW CHARTING

is new! It's now

Flow Charting II+, with more speed + more functions + more printing options;

- 10 text fonts; 26 shapes; • Line mode can stop at a shape; • Backspace key can erase a line to its origin; • Free text entry anywhere, or select auto-centering; • Vertical or horizontal printing; one chart or multiple charts.

Used by Fairchild, Bechtel and more than 500 other major corporations. Edit quickly and accurately — even major edits — with Flow Charting II+, the Specialist.

See your retail store or call:

PATTON & PATTON
 Software Corporation
 800/672-3470, ext. 897 California
 800/538-8157, ext. 897 National
 408/629-5044 International)

CIRCLE NO 754



Schematic-Capture Software from Wintek

Create and revise schematics quickly and simply with **HIWIRE**® and your IBM PC. With a click of the mouse button, select a symbol from our extensive library; with a few more clicks, add connecting wires. Netlist, bill-of-materials, and **smARTWORK**® cross-checking utilities included. **HIWIRE** is \$895 and comes with a 30-day money-back guarantee. Credit cards accepted.

Wintek Corp.
 1801 South St., Lafayette, IN 47904
 (800) 742-6809 or (317) 742-8428

CIRCLE NO 755

WAVEFORM SYNTHESIZER

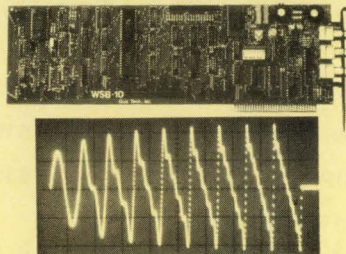

- For IBM-PC/XT/AT and compatibles
- Generates user-definable signal
- Up to 2000 points per envelope

\$795.00
QUA TECH, INC.

478 E. Exchange St. Akron OH 44304
 (216) 434-3154 TLX: 5101012726

CIRCLE NO 756

68000
 NEW! **68010**
Z80 Z80+
8085 8088
NSC800

In-Circuit Emulators

- * Real time or single step execution.
- * Small enough to plug into µP socket.
- * RS-232 interface to terminal or PC.
- * Up/download HEX/S-record files.
- * Hardware or software break points.
- * \$550 to \$1995!

Nicolet 800-NICOLET (642-6538)
 or 608-273-5008

CIRCLE NO 757

To advertise in Product Mart, call Joanne Dorian, 212/463-6415

IEEE 488 INTERFACE FROM A PERSONAL COMPUTER TO A PERSONAL CONTROLLER... ...FOR \$195.00

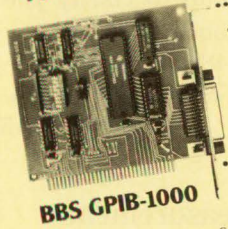

BBS GPIB-1000

- For PC XT/AT or compatibles
- Routines, sequences and terminology similar to HP-85
- Won't 'hang up' bus during use
- BASICA, assembly language,

Microsoft & Lattice C and compiled basic support packages available

Need additional information on pricing, volume discounts, or technical information?

Call us toll free at (800) 227-7317

In Ohio (216) 349-3444.



6200 SOM Center Rd. • Suite C23
Solon, OH 44139

CIRCLE NO 758

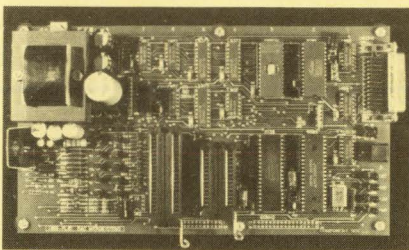

UNIVERSAL EPROM PROGRAMMER KIT FROM \$95!

- On board power supply, 110/220 VAC;
- Menu selection; No personality modules;
- Built in monitor for easy I/O debugging;
- User friendly softw; Full tech. support;
- Detailed 50 page manual with schematics;
- Quick pulse algorithm: 27256 under 60 sec
- All 24/28 pins to 27011 & CMOS E(E)PROMS
- Micros: 8741, 48, 48H, 49, 49H & CMOS
- Auto baud RS232 to 19.2k; Free PC drivers
- Offset/split Hex, Binary, Intel & Motorola 8, 16 & 32 bit files; 2 board cased unit \$495!

B&C Microsystems

355 W. Olive Ave, Ste 103, Sunnyvale, CA 94086
Ph(408)730-5511 800-642-7617 Visa & MC

CIRCLE NO 759

NEW

CMOS CONTROL COMPUTER

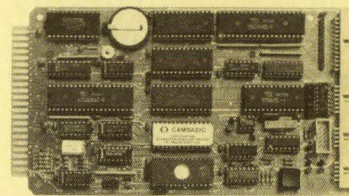

SBS-1000 has turbo speed, 20K industrial BASIC. Runs 5 times faster than BASIC-52 systems. All CMOS with Z80 CPU, EPROM/EEPROM programmer, 96K static RAM, 2 RS-232C serial ports, 32 lines digital I/O, 4 channels-12 bit A/D, battery backed calendar clock, keypad and display ports, expansion port, autorun mode, interrupts handled by BASIC, industrial quality, 5V and stand alone operation. From \$396 in 100s.

For Immediate Response: **303-426-8540**

OCTAGON SYSTEMS CORPORATION

6510 W. 91st Ave.
Westminster, CO 80030

CIRCLE NO 760

OEM188 SBC DEVELOPMENT SYSTEM FOR PRODUCT APPLICATIONS

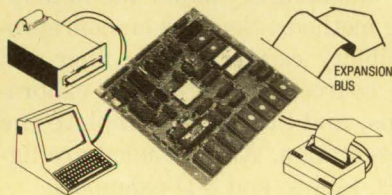

The **OEM188** - designed to bring your product to market in the fastest possible time - through the most productive software development environment available & cost effective hardware.

- The OEM188 boots MS-DOS or CP/M-86. Write your program in Assembler, Forth, Basic, C, Fortran or Pascal.
- ROM your code. The EPROM programmer is onboard and fully integrated into the hardware and software.
- Develop your code quickly with Vesta's ROMmed languages designed for control tasks.

Size 8" x 8"; FDC for 4 drives, Dual UART with RS-232, TTL and RS-422 I/O, Bus - IBM, Printer port, Watchdog, Battery backed real time clock and up to 256 K static RAM/ROM. Programmer interface - terminal. Various I/O boards available. Prices starting as low as \$329 each

VESTA TECHNOLOGY, INC. • 7100 W. 44th Ave. • Suite 101
Wheatridge, CO 80033 • (303)422-8088 • VISA & MC

CIRCLE NO 761

C See how well you can program for **Z80** or **HD64180** with **Hi-Tech™ "C."**

Starting at: **\$195**

This professional, IBM-PC based, compiler is a complete implementation of the "C" language for the Z80 or HD64180 microprocessor. Includes features such as: function prototyping, 31-character names, single precision floating point, full library source, exploits Z80 instruction set, reentrant code, M80-L80 and SLR Systems compatibility, tight/fast code, excellent compile time error checking, etc., etc.

Z-World

2065 Martin Ave. #110
Santa Clara, CA 95050
(408) 980-1678



"Z80 Family Specialists"

In Germany: iSystem Tel: 08131/1687

CIRCLE NO 762

LOW-COST UNIVERSAL PROGRAMMER

From the **World's Largest** supplier of low-cost programming equipment

FROM \$995.00



Get the FACTS about E/PROM/PLD/MICRO programming and UV ERASER products from the only company that has managed to supply low-cost quality equipment for years and maintained superb customer support. All products 100% made in U.S. 14 day money back guarantee.

LOGICAL DEVICES INC.
TOLL FREE 1-800-331-7766
1321 NW 65TH PLACE
Ft. Lauderdale, FL 33309
FL (305) 974-0967
Telex 383142

CIRCLE NO 764

GANG/SET EPROM MULTIPROGRAMMER™

only \$695.00

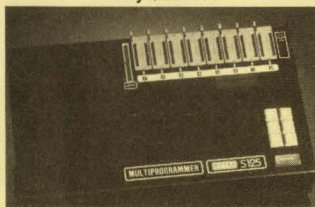

The **BYTEK S125 GANG WRITER** is perfect for the production EPROM programming environment. 32 char. LCD provides extremely User Friendly operation. Standard Features Include:

- * **GANG PROGRAMMER:** Duplicates up to 8 devices at one time.
- * **SET PROGRAMMER:** Copies up to 4 Masters (each with different data) simultaneously.
- * Programs virtually all EPROMs, (MOS/CMOS/HMOS) & EEPROMs including MegaBit Devices.

ONE YEAR WARRANTY.
FREE SOFTWARE UPDATES.

CALL: 1-800-523-1565
In FL: (305) 994-3520

BYTEK Corporation
1021 S. Rogers Cir., Boca Raton, FL 33431
FAX: (305) 994-3615 TELEX: 4998369 BYTEK

CIRCLE NO 765

ANALOG I/O and DSP

ideal for PC based Measurement/Test, Control, Acoustics, and Signal Processing

MODELS

- PC-12E** • 16 SE or 8 DF inputs, programmable gain amplifier, precision sample and hold, 12-bit A/D, four 12-bit D/A, 10-bit digital out, memory mapped I/O. \$550
- PC-DAC** • 12-bit single or dual channel D/A with smoothing filter and crystal timer, ideal for voice output from PC, one channel voice input optional. \$275
- PC-DMA** • 12-bit A/D and D/A to 100 KHz, dual-channel DMA controller for concurrent I/O capability, programmable H/W timer for zero timing jitter, I/O filters, programmable gain and offset amplifier, 16-channel auto-scan multiplexer, 8-bit digital I/O, etc. \$1250
- PC-DMA16** • Features compatible to PC-DMA, but with 16-bit A/D and dual 16-bit D/A. \$1595
- PC-DSP** • 22-bit floating point DSP board for PC, compatible to the above PC-DMA boards for R/T DSP, 1K complex FFT in 10msec.

Menu-driven S/W packages available, including Sample-to-Disk for continuous sample transfer to and from harddisk. 80286 based workstation packages available.

CANETICS, Inc.
PO Box 70549, Pasadena, CA 91107
(818) 584-0438

CIRCLE NO 766

To advertise in Product Mart, call Joanne Dorian, 212/463-6415

SAVE BIG ON TEXAS INSTRUMENTS CALCULATORS

The NEW TI-95 Procalc™

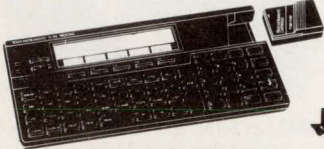

STATE OF THE ART Scientific Calculator

- Introduces "windows" to programmable-calculators! Display windows identify the operations performed by the TI-95's redefinable function keys.
- Packs an unprecedented 200-plus functions in a menu-oriented, easy-to-use package.
- 8K RAM expandable to 16K
- Up to 900 data registers. Or up to 7200 program steps. Or up to 6200 bytes of file space for storing custom programs or data.
- An unprecedented set of built-in scientific functions including permutations, combinations, least common multiple, prime factors, random number generation, metric conversions, hyperbolic trigs and cubic- and quadratic-equation evaluation.
- Straightforward keystroke language includes branching, subroutines, tests, flags, file operations and alpha capability.
- Full program control of redefinable function keys
- AOST™ algebraic operating system
- The TI-95 comes with a comprehensive user's guide, a programming guide, a sturdy hard-plastic carry case, and 4 AAA size batteries
- Constant memory feature 3.75" x 8" x 1"

Mfr. Sugg. Ret. \$200

\$139

TI-74 Basicalc™



- It's an advanced scientific calculator, with 70 functions—and a BASIC programmable calculator, with 113 commands.
- AOST™ algebraic operating system
- 8K bytes of built-in RAM, plus optional 8K
- Display shows up to 31 large alphanumeric characters (scrolls left or right to 80) and 14 status indicators. Adjustable contrast.
- Comes with user's guide and a BASIC programming reference guide.
- Scientific functions include common and natural logarithms and antilogarithms, reciprocals, powers, roots, factorials, and trigonometric calculations, including inverses, in degrees, radians or grads.
- Constant memory feature 4.2" x 8.3" x 1.3"

Mfr. Sugg. Ret. \$135

\$94

| TI-74 and TI-95 Accessories | Mfr. Sugg. Ret. | Elek-Tek Price |
|---------------------------------|-----------------|----------------|
| TI-8K Constant Memory Cartridge | \$ 50.00 | \$34.00 |
| TI-PC 324 Printer | 115.00 | 69.00 |
| TI-CI-7 Cassette Interface | 35.00 | 22.00 |

Software Cartridges

| | | |
|------------------------------|---------|----------------|
| TI-74 Learn Pascal Cartridge | \$45.00 | \$29.00 |
| TI-74 Statistics Cartridge | 45.00 | 29.00 |
| TI-74 Mathematics Cartridge | 45.00 | 29.00 |
| TI-95 Mathematics Cartridge | 50.00 | 33.00 |
| TI-95 Statistics Cartridge | 50.00 | 33.00 |

**TEXAS
INSTRUMENTS**

CALL TOLL FREE 800-621-1269
Except Illinois, Alaska

Canadian Toll Free 800-458-9133

Corporate Accts. Invited. Min. Ord. \$15.00. Visa or MasterCard by Mail or Phone. Mail Cashier's Check, Mon. Ord., Personal Check (2 wks. to clear) Add \$4.00 1st item. (AK, HI, P.R., Canada add \$10.00 first item) \$1.00 ea. add'l shpg. & hand. Shipments to IL address add 7% tax. Prices subj. to change. WRITE for free catalog. RETURN POLICY: Defectives Only: Most products replaced within 30 days of purchase with identical merchandise only. Computer and large peripherals replaced only when defective on arrival (within 3 work days of delivery). Other problems covered by mfr. warranty. ALL ELEK-TEK MERCHANDISE IS BRAND NEW, FIRST QUALITY AND COMPLETE. Immediate delivery on all above items. DUNS #09-718-0517

ELEK-TEK
6557 N. Lincoln Ave., Chicago, IL 60645
312-677-7660

CIRCLE NO 55

LITERATURE

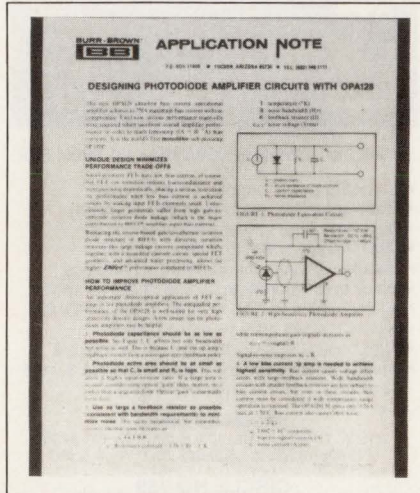

Note on amplifier circuit design

The 2-pg application note AN-151, *Designing Photodiode Amplifier Circuits with OPA128*, explains how to minimize the tradeoffs and improve the performance when designing photodiode amplifier circuits. Specific topics include photodiode capacitance, feedback and diode shunt resistance, photo-voltaic vs photoconductive modes, shielding, and oscillation suppression.

Burr-Brown, Box 11400, Tucson, AZ 85734.

Circle No 414



IC solutions for communications

The 1987-1988 IC Product Handbook provides technical descriptions and application notes for more than 20 ASICs, including eight new products. It lists analog speech scramblers, delta modulation codecs, 1200-baud min shift-key modems, switched-capacitor filters, selective calling devices, and encoders/decoders. Illustrations, tables, figures,

and schematics help to clarify the product descriptions.

MX-Com Inc, 4800 Bethania Station Rd, Winston-Salem, NC 27105.

Circle No 415

Fiber-optic measurements

The 25-pg booklet, *How to Make Accurate Fiber Optic Power Measurements*, contains six sections. The introduction presents the current status of fiber optics, the measurements of optical power, and the company's HP8152A power meter. The next two sections deal with accuracy limits due to the detector and amplifier and accuracy limits due to coupling methods. Sections on nonreproducibility caused by the fiber and the source, standards and calibrations, and literature complete the presentation. Also included are figures, tables, and 3-D examples.

Hewlett Packard Co, 1820 Embarcadero Rd, Palo Alto, CA 94303.

Circle No 416

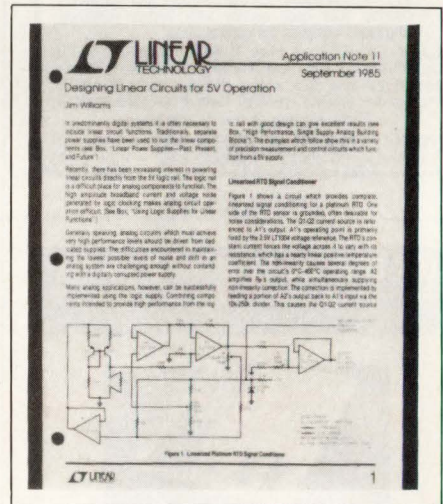

App note describes analog-circuit design

The 16-pg application note, *AN-11: Designing Linear Circuits for 5V Operation*, provides circuit schematics and descriptions of various linear functions that can be incorporated with digital functions on a pc board, using a common 5V supply. The applications discussed include a linearized-platinum signal condi-

LITERATURE

tioner; a linearized-output methane detector; a cold-junction, compensated thermocouple signal conditioner; an instrumentation amplifier; and a strain-gauge signal conditioner. Other applications described include a tachless motor-speed controller, a 4- to 20-mA current-loop transmitter (with a floating-point option), an isolated limit comparator with a gain of 100, and an isolated A/D converter.

Linear Technology Corp, 1630 McCarthy Blvd, Milpitas, CA 95035.

Circle No 417

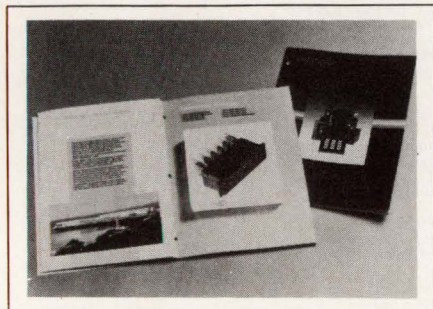

Listing of digital switches

This catalog describes a wide range of switches, including Digiswitch, Minilever, Digi divider, and Digi-decade switches, as well as Minikey keypad systems. Its easy-reference format guides you through military and commercial switch selection and includes a feature and options chart, truth tables listed by product series, engineering parameters, and layout drawings. It covers thumb-wheel switches, lever/toggle switches, pushbutton switches, special-custom products, accessories, and switch-and-assembly ordering instructions.

Digitran, 3100 New York Dr, Pasadena, CA 91107.

Circle No 418

Report explains reliability testing

Product Reliability Report, RR-1C, describes the steps the vendor has taken to reach new reliability standards for analog and data-conversion products. The procedures and mate-

rial presented in the 7-pg report are based on an audit by the accounting firm of Coopers & Lybrand. The two tutorials included in the report present the theory behind the computation of an acceleration factor and the determination of a failure-in-time rate.

Maxim Integrated Products, 510 N Pastoria Ave, Sunnyvale, CA 94086.

Circle No 419

How to create a mouse menu program

The *Microsoft Mouse Programmer's Reference Guide* explains how to write mouse menu programs and how to design a mouse interface for the applications you write. The guide has two main sections. The first section tells you how to create a mouse menu program that allows you to use the vendor's mouse with an application that doesn't have built-in mouse support. The second part explains how to build mouse support directly into one of your own applications. The guide also contains the tools and technical information you need to make direct calls to the driver. \$25.

Microsoft Corp, Box 97017, Redmond, WA 98073.

INQUIRE DIRECT

Coaxial products catalog

Catalog #587 is a 29-pg listing that features a full line of coaxial adapters, connectors, attenuators, terminations, and cable assemblies. The newly featured line of coaxial attenuators includes BNC, "N", SMA, and TNC. Both flexible and semirigid cable assemblies are available. It includes technical specifications and pricing for more than 1000 standard catalog items.

Pasternack Enterprises, Box 16759, Irvine, CA 92713.

Circle No 421

WORLD'S SMALLEST DIP SWITCH

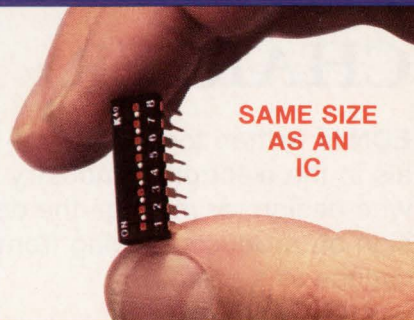

SAME SIZE AS AN IC

BETTER HEAT CONVECTION.

OLD DIP SWITCH



HIGH DIPS SHADOW LOW IC'S

NEW DIP SWITCH



THE LOW PROFILE K40 DIP IS THE SAME SIZE AS AN IC

NO MORE HAND LABOR.



YOU CAN USE AUTOMATIC INSERTION EQUIPMENT!

If you don't have automatic insertion equipment, we're banking that some day you will. To prove that, we'll charge you the same low price for all your purchases—no more need for the low-volume premium prices you're paying now.

AVAILABLE IN 2, 3, 4, 5, 6, 7 & 8 POSITIONS

FREE SAMPLE!

WITH STAPLED BUSINESS CARD TO YOUR LETTERHEAD

AMERICAN RESEARCH & ENGINEERING

1500 EXECUTIVE DRIVE
ELGIN, IL 60123
312-888-7245



America can do it better!

BUSINESS/CORPORATE STAFF

EDN's CHARTER

EDN is written for professionals in the electronics industry who design, or manage the design of, products ranging from circuits to systems.

EDN provides accurate, detailed, and useful information about new technologies, products, and design techniques.

EDN covers new and developing technologies to inform its readers of practical design matters that will be of concern to them at once or in the near future.

EDN covers new products

- that are immediately or imminently available for purchase
- that have technical data specified in enough detail to permit practical application
- for which accurate price information is available.

EDN provides specific "how to" design information that our readers can use immediately. From time to time, EDN's technical editors undertake special "hands-on" projects that demonstrate our commitment to readers' needs for useful information.

EDN is written by engineers for engineers.

EDN

275 Washington St
Newton, MA 02158
(617) 964-3030

F Warren Dickson
Vice President/Publisher
Newton, MA 02158
(617) 964-3030
Telex 940573
Diann Siegel, Assistant

Peter D Coley
Associate Publisher/
Advertising Sales Director
Newton, MA 02158
(617) 964-3030
Mary E Frissora, Assistant

NEW ENGLAND
John Bartlett, Regional Manager
Chris Platt, Regional Manager
199 Wells Ave
Newton, MA 02159
(617) 964-3730

STAMFORD 06904
George Isbell, Regional Manager
8 Stamford Forum, Box 10277
(203) 328-2580

NEW YORK, NY 10011
Daniel J Rowland, Regional Manager
249 West 17th St
New York, NY 10011
(212) 463-6419

PHILADELPHIA AREA
Steve Farkas, Regional Manager
487 Devon Park Dr
Suite 206
Wayne, PA 19087
(215) 293-1212

CHICAGO AREA
Clayton Ryder, Regional Manager
Randolph D King, Regional Manager
Cahners Plaza
1350 E Touhy Ave, Box 5080
Des Plaines, IL 60017
(312) 635-8800

DENVER 80206
John Huff, Regional Manager
270 St Paul St
(303) 388-4511

DALLAS 75243
Don Ward, Regional Manager
9330 LBJ Freeway
Suite 1060
(214) 644-3683

SAN JOSE 95128
Walt Patstone, Regional Manager
Bill Klanke, Regional Manager
Philip J Branon, Regional Manager
Mark Holdreith, Regional Manager
3031 Tisch Way, Suite 100
(408) 243-8838

LOS ANGELES 90064
Charles J Stillman, Jr
Regional Manager
12233 W Olympic Blvd
(213) 826-5818

**ORANGE COUNTY/
SAN DIEGO 92715**
Jim McErlean, Regional Manager
18818 Teller Ave, Suite 170
Irvine, CA
(714) 851-9422

PORTLAND, OREGON 97221
Pat Dakin, Regional Manager
Walt Patstone, Regional Manager
1750 SW Skyline Blvd, Box 6
(503) 297-3382

UNITED KINGDOM/BENELUX
Jan Dawson, Regional Manager
27 Paul St
London EC2A 4JU UK
44 01-628 7030
Telex: 914911; FAX: 01-628 5984

SCANDINAVIA
Stuart Smith
27 Paul St
London EC2A 4JU UK
01-628 7030
Telex: 914911; FAX: 01-628 5984

FRANCE/ITALY/SPAIN
Alasdair Melville
27 Paul St
London EC2A 4JU UK
01-628 7030
Telex: 914911; FAX: 01-628 5984

WEST GERMANY/SWITZERLAND/AUSTRIA
Wolfgang Richter
Sudring 53
7240 Horb/Neckar
West Germany
49-7451-7828; TX: 765450

ISRAEL
Igal Eilan
Eilan Marketing Group
13 Haifa St, Box 33439
Tel-Aviv, Israel
Tel: 972-3-268020
TX: 341667

EASTERN BLOC
Uwe Kretzschmar
27 Paul St
London EC2A 4JU UK
01-628 7030
Telex: 914911; FAX: 01-628 5984

FAR EAST
Ed Schrader, General Manager
18818 Teller Ave, Suite 170
Irvine, CA 92715
(714) 851-9422; Telex: 183653

TOKYO 160
Kaoru Hara
Dynaco International Inc
Suite 1003, Sun-Palace Shinjuku
8-12-1 Nishishinjuku, Shinjuku-ku
Tokyo 160, Japan
Tel: (03) 366-8301
Telex: J2322609 DYNACO

TAIWAN
Acteam International
Marketing Corp
4F, No 87, Kwang-Fu N Rd
Taipei, Taiwan ROC
760-6209 or 760-6210
Telex: 29809
FAX: (02) 7604784

KOREA
Korea Media Inc
Rm 110, A-11 Bldg 49-4,
Hoihyundong 2-Ka, Chung-Ku
CPO Box 2314, Seoul, Korea
Tel: 82-2-755-9880
Telex: K26249

SINGAPORE
Cheny Tan Associates
1 Goldhill Plaza
No 02-01
Newton Rd
Singapore 1130
Tel: 2549522
Telex: RS 35983 CTAL

PRODUCT MART
Joanne Dorian, Manager
249 West 17th St
New York, NY 10011
(212) 463-6415

**CAREER OPPORTUNITIES/
CAREER NEWS**
Roberta Renard
National Sales Manager
103 Eisenhower Parkway
Roseland, NJ 07068
(201) 228-8602

Janet O Penn
Eastern Sales Manager
103 Eisenhower Parkway
Roseland, NJ 07068
(201) 228-8610

Dan Brink
Western Sales Manager
18818 Teller Ave
Suite 170
Irvine, CA 92715
(714) 851-9422

Diann Siegel
Boston Sales Representative
Newton, MA 02158
(617) 964-3030

Maria Cubas
Production Assistant
(201) 228-8608

Cahners Magazine Division
William Platt, President
Terry McDermott, Executive Vice President
Frank Sibley, Group Vice President
Tom Dellamaria, VP/Production & Manufacturing

Circulation
Denver, CO: (303) 388-4511
Sherri Gronli, Group Manager
Eric Schmierer, Manager

Reprints of EDN articles are available on a custom printing basis at reasonable prices in quantities of 500 or more. For an exact quote, contact Joanne R Westphal, Cahners Reprint Service, Cahners Plaza, 1350 E Touhy Ave, Box 5080, Des Plaines, IL 60018. Phone (312) 635-8800.

Users groups and their vendors: The ins and outs of a partnership

Deborah Asbrand, *Associate Editor*

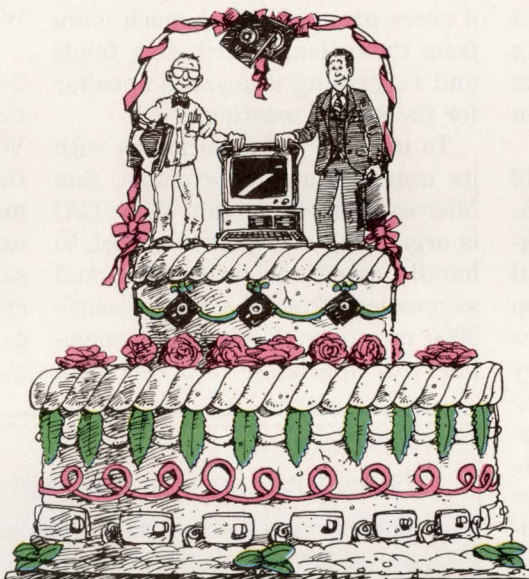

Jon McIntosh

Simon Favre, a modeling engineer for LSI Logic, cites three reasons for belonging to the Mentor Graphics Users Group, which is called MUG. First, he finds the exchange of information with other users of Mentor Graphics' workstations fruitful, and he also enjoys such membership benefits as the group's software exchange.

The third of Favre's reasons for belonging to MUG is perhaps the most important: MUG membership gives him the chance to influence the development of Mentor Graphics products—something he would not be able to do as an isolated, individual user. "If you get 200 people at a users-group meeting who say they don't like something, Mentor will sit up and take notice," says Favre, who runs Mentor's Idea Station software on the Apollo DN 3000.

Many members of other users

groups agree on the relatively weak impact of the lone voice. "Requests from an individual user don't carry much weight," says David Austin, manager of computer-aided design at Integrated Technology Corp (ITC) in Tempe, AZ, and a member of an organization for users of Cadnetix Corp's CAE workstations. "As a result, the group is the only way that users can effectively communicate what they want in terms of new features."

Users of PC-level equipment are often attracted to general-purpose computing groups by their regular meetings and the chance to swap tips and software. But users of higher-level machines want much more. Engineers want users groups to open the door to discussions with the manufacturers' engineers about the current crop of products and the design decisions behind them as

well as features planned for the next generation of products.

Nurturing a happy relationship between a manufacturer and the engineers who use its equipment, however, can be tricky. "It's a courtship and marriage type of situation," says Stan Nissen, MUG president. Indeed, after easily agreeing that some form of partnership is a good idea, a vendor and its users group must then tackle the more difficult tasks of managing two often differing sets of opinion, communicating regularly, and maintaining their independence.

Manufacturers and customers alike agree that users groups are beneficial. For manufacturers, sponsoring a users group provides a handy source of reference for design and marketing questions. It can also take the pressure off customer-support services. For users, the group

PROFESSIONAL ISSUES

Nurturing a happy relationship between a manufacturer and the engineers who use its equipment can be tricky.

provides an educational and practical outlet for the exchange of ideas, tips, and materials.

Opinions on how a users group should operate, though, often diverge. Mentor Graphics users group appeared from the company's viewpoint to be a successful effort. In addition to regularly held regional and national meetings, MUG issues a monthly publication, called "Mugazine," that lists meeting dates and provides a forum for its members to exchange information and offer solutions to problems.

MUG filled most, but not all, of the customers' needs, says Nissen. "Mentor Graphics bent over backwards to make MUG a successful organization that was able to run on its own," he says. Yet the users found something lacking: They wanted to talk directly with Mentor's engineering staff. So MUG decided to hold its 1987 annual meeting in a Beaverton, OR, hotel—just a short drive from Mentor's headquarters.

More than 225 Mentor customers gathered for the 3-day meeting. Even more important, approximately 100 Mentor engineers spread themselves among the technical sessions and open forums to answer questions and talk with users. By all accounts, the meeting was easily the most successful to date: "There was overwhelming interaction between the users and Mentor Graphics' engineering staff," says Nissen, a digital engineer at Raytheon's Missile Systems Division in Bedford, MA. "Users gained a very strong insight into what's behind the scenes at Mentor, and the engineers gained great insight into what users' needs are."

"The users came with moans and gripes, but there's no question that we want and need a relationship with each other," says Peter Hoogerhuis, Mentor Graphics' man-

ager of corporate field support.

Although most manufacturers readily recognize and appreciate the need for customers to communicate among themselves, Mentors' experience shows they can overlook the sophisticated user's need to communicate directly with the manufacturer's engineering staff. Other companies are discovering that sponsoring a users group requires much more from them than contributing funds and furnishing a keynote speaker for the annual meeting.

To improve communications with its users group, for example, Sun Microsystems (Mountain View, CA) is organizing a 12-person council to handle questions, criticisms, and suggestions from the users group's 3000 members. Each council member will specialize in a technical

field, such as compiler development, network support, operating-system development, and window standards. Sun's workstation customers say the council's formation indicates the company's willingness to recognize the importance of their feedback. "It commits the company to the users group in a formal way," says Sun Users Group president William Toth.

A task of equal importance to 2-way communication is preservation of the users' independence. Vendors and customers both say they are sensitive to any attempts to manipulate the users group into an extension of the manufacturer's sales and marketing effort. Sun Microsystems' liaison to its users group, Sanford Meltzer, points out that although he has easy access to

Users groups are not just for novices

Contrary to the beliefs of many engineers that users groups are just for novices, members of users organizations say that they continue to benefit even as they become more skilled.

"Every CAD company has a customer support line, but the information users get from each other is of a much more practical nature," says David Austin, manager of computer-aided design at Integrated Technology Corp in Tempe, AZ. "There's a lot of information traded among users: application notes, bug reports, little pieces of custom software, new software, and lists of equipment to trade."

Users groups by definition should appeal to designers at all levels of advancement, says William Toth, president of the Sun Microsystems Users Group. "Users groups are more than just handholding groups. If anything, a users' group should become increasingly valuable as time goes by," says Toth. Leaders of the Mentor Graphics Users Group, for example, have taken deliberate steps to make membership in their organization as vital for seasoned users of Mentor equipment as for newcomers. They run technical papers in their newsletters and sponsor more advanced technical sessions at their annual meeting.

Tom Provost, a 13-year member of DECUS, the users organization for customers of Digital Equipment Corp, says that among the most important reasons for his long-standing membership are the contacts he makes with users who have similar applications. "I know who to call for help," Provost says.

"3000 of our best customers," Sun has always advocated the group's autonomy. "From the day I was hired, I was given no directions [from Sun] as to where the users group should go. My direction comes from the users group's board of directors."

Other company representatives agree that they should consider users groups as separate entities that complement the company. "It's not just a vendor-user relationship; it's a partnership," says Morris Paserchia, eastern regional technical support manager for Boulder, CO-based Cadnetix and liaison with its 700-member users group.

Seeing the fruits of labor

Once a manufacturer and its users group have established their responsibilities and jockeyed for position, users-group members say they are reasonably successful in influencing product design. "Cadnetix's response is not always immediate, but we do see it," says Ron EuDaly, head of Cadnetix's midwestern users group. EuDaly uses the Cadnetix CDX 50000S and 90100S workstations in his job as a supervisor for communications-equipment maker Xetron (Cincinnati, OH). He's pleased that the company has introduced both a floating-point operation and a drawing package in its latest software release—both enhancements that were recommended by attendees at a meeting of northeastern users that EuDaly attended last year.

Digital Equipment Corp's users group has acquired a reputation in users-group circles because of its substantial influence within the company. That influence stems in no small part from its size—55,000 members—and its considerable resources. Digital Equipment employs a staff of 35 to manage the activities of the group, called the Digital

Equipment Corporation Users Society (DECUS), and its 21 special-interest groups.

Bill Brindley, a 12-year DECUS member and chairman of its special-interest group on networks, says the networks group has made many product recommendations to DEC, most of which have been implemented. "Going back over the years, users would say which capability they'd like to see in the product, and we'd write them up and pass them to DEC. More than 80 to 90% of those features got implemented in future network products."

Most recently, DECUS took Digital Equipment to task for a proposed software-licensing policy. After receiving a letter from DECUS's board of directors stating that the proposal was not in the best interests of the users, DEC abandoned its plans. DECUS is very effective in keeping DEC on track, says Tom Provost, a computer-group leader for MIT's William H Bates Linear Accelerator Center in Middleton, MA. "When DEC is not building the best product for the market, sometimes the users spot that more quickly than DEC."

Though their ability to affect product design may not always be all that they would like, users-group members say that without the backing of the group, they would have almost no chance to effect change. "Cadnetix has stated to us at Integrated Technology Corp as well as to other users that requests from individual users don't have much weight," says Austin. Observes DECUS member Provost, "Feedback has to be organized in order to carry weight."

EDN

Article Interest Quotient
(Circle One)
High 503 Medium 504 Low 505

VGEN™

STIMULUS PATTERN GENERATION FOR:

VALID MENTOR GRAPHICS TEGAS
DAISY **TEKTRONIX/CAE** **LDS**
SILOS **HILO**

LOGIC SIMULATORS.

VGEN, a stimulus generation language, can reduce the time it takes to create and modify simulation stimulus files by up to **80%**! VGEN provides a powerful high-level language interface for the pattern generation task.

For many logic simulators, stimulus pattern generation and modification has long been a monotonous, error-prone process. Flexibility in emulating and modifying system timing has been almost nonexistent. The availability of VGEN, however, radically changes this situation. A designer can now algorithmically generate patterns with precise control over pattern cycle times as well as individual pin timing.

If you are involved with large logic simulations on any of today's popular simulators, let us show you how VGEN can improve your productivity and enhance your overall simulation effectiveness.

Write or call TODAY: (408) 374-1941

MENTOR GRAPHICS is a trademark of Mentor Graphics Corporation. VALID is a trademark of Valid Logic Systems, Inc. DAISY is a trademark of Daisy Systems Corporation. HILO is a registered trademark of GenRad Corporation. SILOS is a trademark of Simucad. Tegas is a trademark of G.E. Calma Company. LDS is a registered trademark of LSI Logic Corporation. VGEN is a trademark of Source III, Inc.



SOURCE III, INC.
170 KNOWLES DRIVE, #209
LOS GATOS, CALIFORNIA 95030

CIRCLE NO 56

EDN INFO CARDS

Cost Less Than 1½¢ Per Name to
Reach More Than 121,500
U.S. Specifiers and Buyers of
Electronic Products!



For further information,
contact Lauren Fox, EDN
Info Cards Manager, at
(203) 328-2580.

* Numbers represent
actual responses.

CIRCLE NO 117

McDATA Corporation

McDATA Corporation is the designer and manufacturer of information system products which effectively integrate communications, computing and data management.

Our rapid growth has created the following positions at our facilities in Broomfield, a northern suburb of Denver.

SOFTWARE ENGINEERS

Will be involved with all or part of the following communications controller development:

- Asynchronous communications and terminal emulation
- Local and wide area networking interfaces and connectivity solutions
- Diagnostic software for manufacturing and customer service
- Communications and network software test and verification
- Software development tools

These positions require 2-10 years of development experience, preferably in data communications systems, "C" language and Intel microprocessor experience with a BSCS/BSEE. Position level to correspond with experience.

MECHANICAL ENGINEER

Will define, design, and develop mechanical systems including generation of complete product documentation, tool development, vendor liaison and attainment of product design and cost goals.

Requires 7 years of product design with emphasis on electronic package methods and BSME. CAD work station experience preferred.

McDATA is committed to a smoke free environment.

To the selected candidates we offer a competitive salary, excellent benefits package, plus an opportunity to grow in an exciting fast paced and results-oriented environment.

If you are interested in becoming a part of a dynamic, progressive, people-oriented organization, please submit resume including salary history to:

McDATA CORPORATION
295 Interlocken Blvd
Broomfield, CO 80020
Attention: Robert E. Bales
Manager of Personnel

We are an equal opportunity employer

McDATA

CORPORATION

CAREER OPPORTUNITIES

1987 Editorial Calendar and Planning Guide

| Issue Date | Recruitment Deadline | EDN Editorial Emphasis | EDN News |
|------------|----------------------|---|---------------------------------------|
| Sept. 3 | Aug. 13 | Analog ICs; CAE; ASICs | |
| Sept. 17 | Aug. 27 | Memory Technology; Communications Technology; Software | Closing: Aug. 20 Mailing: Sept. 10 |
| Oct. 1 | Sept. 10 | Surface-Mount Technology; Computers & Peripherals; Industrial Product Showcase | Closing: Sept. 3 Mailing: Sept. 24 |
| Oct. 15 | Sept. 24 | Test & Measurement Special Issue; Analog ICs; ASICs | Closing: Sept. 17 Mailing: Oct. 8 |
| Oct. 29 | Oct. 8 | Computers & Peripherals; ICs & Semiconductors; Wescon '87 Product Preview | Closing: Oct. 1 Mailing: Oct. 22 |
| Nov. 12 | Oct. 22 | Wescon '87 Show Issue; ICs; Computers & Peripherals | Closing: Oct. 15 Mailing: Nov. 5 |
| Nov. 26 | Nov. 5 | Microprocessor Technology Report & Directory; Analog ICs; Sensors & Transducers | Closing: Oct. 29 Mailing: Nov. 19 |
| Dec. 10 | Nov. 19 | Product Showcase-Volume I; ICs and Semiconductors; Software | Closing: Nov. 12 Mailing: Dec. 3 |
| Dec. 24 | Dec. 3 | Product Showcase-Volume II; Computers & Peripherals; Test & Measurement Instruments | Closing: Nov. 26 Mailing: Dec. 17 |

Call today for information.

East Coast Janet O. Penn (201) 228-8610
 West Coast Dan Brink (714) 851-9422
 National Roberta Renard (201) 228-8602

DEVELOPMENT ENGINEER

Applicant will perform research, design and development of sophisticated equipment and controls for paper, color and protection of the printing press system, including microprocessor controls consisting of both hardware and software. Ph.D. of Electrical and Computer Engineering or Master Degree plus three (3) years experience in the job offered. 40 hours per week. 8:00 A.M. to 5:00 P.M. — \$980.77 per week. Please send resumes to: Illinois Department of Employment Security, 401 South State Street - 3 South, Chicago, Illinois 60605, Attention: Robert S. Felton, Reference #V-IL-7110F, An Employer Paid Ad.

EDN

First in Readership Among Design Engineers and Engineering Managers in Electronics

Imagine

Working In A Company With Innovative Products Resulting In A Compound Annual Growth Rate of 100%.

At QMS, we create, manufacture and market intelligent graphics controllers for laser printers. We also offer an extensive line of impact printers used in industrial graphics and barcode labeling applications.

Our 10 year history of solving tough printing problems in the impact and non-impact worlds, has resulted in a rapid growth of nearly 100% per year and a reputation as a dynamic, innovative corporation.

Senior Level Engineers Engineering Managers Program Managers

To continue our growth in this explosive market, we have immediate positions available for individuals preferably from a larger commercial electronics company. Your 8+ years experience will provide leadership to a young, energetic, engineering staff. BSEE/BSCS required. Advanced degrees preferred.

A few positions are available for outstanding individuals with less experience.

QMS representatives will be interviewing for: **Engineering Managers, Hardware Engineers, Software Engineers, Quality Assurance Engineers, Mechanical Packaging Engineers, Product Publication Manager, Documentation Specialist.**

Applicants should be familiar with most of the following: Structured Programming, UNIX, C, 68000, Microprocessor Family Design, PAL Design, RIP Design, CAD/CAE, Worst Case Design Analysis/Simulation, PERT, MTBF Analysis, Surface Mount Technology.

At QMS, our technical people make major impacts on the success of the corporation. Please send resumes to: Ted Labay, Human Resources, Dept. EDN 8/6, QMS, Inc., One Magnum Pass, Mobile, AL 36618. Equal Opportunity Employer.

QMS[®]

Where Imagination Leads

MATERIALS & EVALUATION LAB ENGINEERS

ITT AVIONICS offers the kind of environment that will enable you to utilize your skills and experience to full advantage. Put yourself at the forefront of technology to assure your growth in an Engineering career. That forefront is Avionics and ITT is one of the leaders... a prime mover in the think-ahead world of military electronic defense systems. Currently we are seeking individuals in reliability and qualification testing and manufacturing screening of electronic systems and physical sciences. Secure your future now by joining ITT AVIONICS especially if you are involved in any of the following areas:

MS / PhD Chem. All positions require secret clearance. 5-8 years experience inorganic chemistry / materials. Background in testing, chemical analysis, materials identification, administration of lab personnel, and computer literate.

BS / MS ME. 3-5 years experience engineering background. Knowledgeable in reliability / qualification testing, administrative responsibility, manufacturing oriented and computer literate.

BS / MS EE. 5-7 years experience. Knowledge of electrical test and test equipment design for environmental tests, experience in qualification and reliability testing, computer literate, hands-on, supervision of testing facility.

BS / MS MET / Chem. 3-6 years experience. Materials specialist-inorganic chemical analysis-areas of expertise-chemistry, inorganic analytical and instrumentation, metallurgical-electronic materials: materials studies and investigations-supervision, materials selection, computer literate, military electronics.

At ITT AVIONICS you will enjoy attractive salaries and generous benefits; medical, dental and life insurance, 100% advanced tuition payment, 401K savings and investment plan. We provide an excellent relocation package to assist you in your transition period. Our extremely pleasant campus-like location is accessible to New Jersey's famous beaches, mountains, sports and cultural facilities, and just a short drive from the attractions of New York City. Few other sites can offer the quality and diversity of lifestyles available here in the Garden State.

For immediate consideration, please send your resume, in confidence, to:

**BEVERLY DeANGELO
PROFESSIONAL EMPLOYMENT
ITT AVIONICS
390 WASHINGTON AVENUE
NUTLEY, NEW JERSEY 07110**

An equal opportunity employer M / F • U.S. Citizenship Required

ITT AVIONICS



We Offer You Something Few Companies Can.

It's the opportunity to join the rapidly growing medical technology industry as part of a team that applies technology to the goal of saving lives. Nellcor's non-invasive medical monitors give an added margin of safety to critical care and surgical procedures. Our sales have grown steadily since our first product introduction in 1983 and our stock just went public in an initial offering.

You can make a contribution in a supportive environment, one that rewards innovation, by applying now for one of the following positions:

Circuit Design Engineer—Design instrumentation circuits from conception to manufacturing. Circuits are in the low- to medium-frequency, low noise front end circuits and basic signal processing designs. Requires proven expertise in analog circuits with good knowledge of recent advances in linear circuit products. BS/MSEE and background in medical instruments are preferred.

Product Engineer—Provide primary technical support in the development of product until release to manufacturing. Lead meetings, assign tasks and act as an intelligent filter for design group in problem handling. Provide training to manufacturing personnel on new products. Requires a BSEE or equivalent and a good understanding of electronic

design and manufacturing. Ability to motivate others and knowledge of complex tradeoff issues are essential.

Test Design Engineer—Design test equipment and procedures for system-level tests of complex, new microprocessor-based products. BS/MSEE and 3+ years' experience.

Instrument Design Engineer—Design, build and evaluate prototype optical instruments; develop computer interfaces; test and evaluate prototype instruments. BS/MSEE with 4+ years' instrumentation experience or a BS/MS in physics with extensive fabrication experience.

Signal Processing Engineer—Develop and test signal processing algorithms for processing of biological data and biochemistry sensors. Provide signal analysis support and direction to various ongoing research projects. PhD in scientific area involving signal processing. Training and experience in digital signal processing, discrete Fourier transforms, fast Fourier transforms and non-stationary process transformations.

Software Engineer—Design, code and checkout software components and systems. Support and expand software for existing products. Investigate and improve instrument performance. May lead other software engineers on projects. Requires 3+ years' experience in software generation, including experience in real-time systems and ROM-based software. BS or MS preferred.

What Have You Got to Offer?

Nellcor would like to find out. We're prepared to offer competitive salaries and an array of benefits including profit sharing, bonuses and more. Inside and out, our modern facility located in Hayward, California, reflects our emphasis on providing the best for our employees. For immediate consideration, send your resume to NELLCOR, Ad #07-07, 25495 Whitesell Street, Hayward, CA 94545. EOE, m/f/h/v.

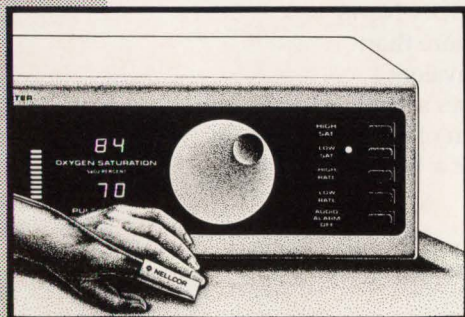

Technology With A
Human Touch

NELLCOR®

Digital has it now.

Challenge.

At Digital's Semiconductor Acquisition and Test group, our engineers are always looking to meet the challenges of today using the technology of tomorrow. And, we're always on the lookout for experienced, dedicated professionals who can thrive in the first class environment of our facility in Marlboro, Massachusetts.

SENIOR ENGINEER

Our packaging group needs a senior engineer to design, develop and verify high pin count ASIC packages. Major emphasis will be on signal integrity and development of electrical characterization methodologies including electrical measurement and simulation techniques.

You will consult with design groups desiring high performance packages and will also work with semiconductor vendor package development groups.

To be part of this fast paced, multi-disciplinary engineering development group, you must have excellent knowledge of transmission line characteristics, RF/high frequency applications, and simulation tools for electrical characterization of semiconductor packages.

Experience in the design of controlled impedance semiconductor packages, and knowledge of electrical characterization equipment are also desired.

If you are looking for an exciting new challenge, send your resume to: **Vicki Coleman, Dept 0806 7820, Digital Equipment Corporation, 111 Locke Drive, LMO2/P30, Marlboro, MA 01752.**

We are an affirmative action employer.

digital™

THE EDN MAGAZINE/EDN NEWS Recruitment Package

The most cost-effective way to reach the most professionals!

EDN reaches more than 137,000 engineers and engineering managers, the largest circulation in the electronics field. EDN News reaches EDN's U.S. circulation of more than 121,500. And, when you place equivalent space in both the *Career Opportunities* section of EDN, and the *Career News* section of EDN News in the same month, you'll get a 1/3 discount off the EDN News rate!

EDN MAGAZINE/EDN NEWS

Where Advertising Works.

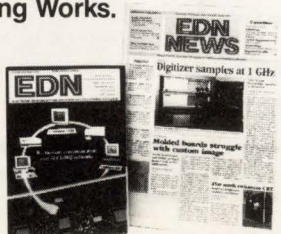

Involvement through Innovation.

That's the success tradition at Rockwell International's Telecommunications Businesses.

We create traditions that evidence involvement. The fruit of our lateral integration strategy, for instance, offers the opportunity to work across the entire technological spectrum. By placing product planning, advanced technology, R&D, manufacturing and quality in one central location we achieve a focus on technical excellence.

Our far-reaching commitment to R&D and innovation is reflected by our market leadership position. We were the first leading equipment maker to offer completely digital systems and helped pioneer both analog and digital microwave systems. Today, product lines that include the most advanced, high performing one gigabit fiber optic transmission systems, digital and analog multiplex systems, and 1.7 to 19.7 GHz frequency microwave communications systems are the foundation of our strong reputation in telecommunications.

Our development teams pursue lightwave, microwave and digital innovation combining technology, involvement and company support. To become involved, consider the following:

Process Engineers

Should possess a BS or MS in EE, Physics or Chemistry with 5 years experience in semiconductor processing technology. This Team Leader position provides technical direction, work-flow control, and hands-on expertise while coordinating the Process Team efforts in pilot production and InGaAsP/InP devices research and development. Requires understanding of processing techniques and equipment, such as: photolithography, wet and dry etching, dielectric and metal deposition, diffusion and alloying. Prefer experience with InGaAsP/InP material.

High Speed Digital Engineers

BSEE or MSEE and a minimum of 4 years experience in digital logic circuit design. Position involves digital circuit design on a switch matrix. Requires 40-50 mhz CMOS or TTL discrete logic circuit design, and SRAM, DRAM high speed memory design. Knowledge of switch matrices is desirable.

Digital Circuit Design Engineers

BSEE and a minimum of 4 years experience in high frequency analog and digital circuit design. Position requires experience in discrete amplifier design (15mhz+), clock recovery circuit design, phase lock loop design (15mhz+) and line conditioning for line buildout circuits. Telephony background and knowledge of DS1-DS3 signals are required. Experience in functional partitioning is desirable.

Coherent Optics Engineers

MS or Ph.D in EE or Physics with at least 2 years experience or equivalent combination required. Involves conducting independent investigation of optical amplification and/or integrated optics. Will function as part of advanced technology team investigating feasibility of coherent optical communications utilizing multiple gigabit technologies.

High Speed Modem Engineers

MSEE/Ph.D with 4-6 years experience. Position involves performing hardware design of digital modems with data rates in the 1 to 180 Mb/s range. Knowledge of digital signal processing theory and implementation methods required. Effective communication skills needed.

Opto-Electronic Device Design Engineers

Requires a PhD/MSEE/Physics with 5-10 years of opto-electronic device experience. Should be familiar with longwave length (1.2-1.6 microns) InP based source and/or detectors design and characterization. Position involves design and characterization of devices including PIN photodetectors, GaAs avalanche photodiodes, semiconductor lasers and LED's. Record of scientific accomplishment and publication is desirable.

Digital VLSI Engineers

Requires BSEE/MSEE with 6-8 years experience in telephony digital hardware design. Experience with CMOS or ECL logic design, VLSI gate array design, and Daisy CAE Design techniques necessary. Desire experience with 40-50 mhz CMOS, DS3 and/or DS1 signals and modulation techniques. Recognized ability to address systems redundancy, signal integrity and system monitor and control must be demonstrated.

Software Engineers

Positions call for a BSCS or BSEE and 5 years software architecture/design experience OR an MSCS or MSEE and 3 years software architecture/design experience. Involves software development for distributed microprocessor network control systems. Experience in circuit switched and packet switched network control is necessary. Team software development experience for Motorola 68000 systems is desirable. Candidates with "C", UNIX™, ADA and OSI data communications experience will be given special consideration.

Power Supply Designers

BSEE with minimum of 3-4 years experience in the design of switching power supplies and associated experience in power distribution. Experience in EMI criteria is required.

Rockwell International's compensation package includes a saving/stock ownership plan, comprehensive medical coverage, dental insurance, retirement plan, tuition reimbursement and much more!

We are interested in hearing from you immediately. Please send your resume to: **Richard Skelnik, Rockwell International, Telecommunications, M/S 401-152, #8538, P.O. Box 10462, Dallas, Texas 75207.** Permanent Residency Required. Equal Opportunity Employer M/F.



Rockwell International

...where science gets down to business

™ UNIX is a trademark of AT&T Bell Laboratories.

ADVERTISERS INDEX

| | | | | | |
|---|--------------------|---|--------------------|--|------------------------------------|
| ABC Taiwan | 263 | Information Scan Technology | 262 | S-MOS Systems* | 60-61 |
| Acopian Corp* | 192 | International Rectifier | C3 | Sony Corp of America | 136 |
| ADE Inc | 132 | Introl Corp | 244 | Sophia Systems Co Ltd | 8 |
| ADPI | 264 | Intusoft | 264 | Source III | 271 |
| Advanced Micro Computer | 263 | I/O Tech | 246 | Spectrum Software | 133 |
| Advanced Micro Devices | 12-13 | Ironwood Electronics | 262 | Sprague Electric Co | 62 |
| American Research and Engineering | 267 | John Fluke Manufacturing Co Inc | 6, 34 | Targa Electronics Systems Inc | 154 |
| Amplifier Research | 212 | Kepeco Co | 183 | TEAC Corp** | 165 |
| Applied Microsystems Corp | 14-15 | Krenz Electronics | 256 | Tektronix Inc | 32-33, 71-72, 247-248, 249, 255 |
| AT&T Technologies | 120-121 | Lectromagnetics Inc | 80 | Teradyne Inc | 40-41 |
| BBS | 265 | Linear Technology Corp | 213-214 | Texas Instruments Inc | 67 |
| B&C Microsystems | 265 | Logical Devices | 265 | Thomson Components- Mostek* | 88-89, 230-231 |
| Bogen Communications Inc | 164 | LTX Corp | 50-51 | Todd Products | 263 |
| BP Microsystems | 262 | Marconi Instruments* | 219 | Toko America Inc | 222 |
| Brooktree Corp | 240-241 | Masscomp | 204-205 | Toshiba Corp | 260 |
| Burr-Brown Corp* | 117, 165 | Maxtor | 30, 31 | TRW/LSI Products Div | 23 |
| Bytek | 265 | Memocom | 261 | Universal Data Systems | 180 |
| California Scientific | 262 | Mentor Graphics Corp | 10-11 | Valhalla Scientific | 251, 253 |
| Canetics | 265 | Mepco/Centralab | 52-53 | Versatec, A Xerox Co | 69 |
| Capital Equipment Corp | 262 | MetaLink Corp | 155 | Vesta | 265 |
| Cardinal Technologies Inc | 258 | Mini-Circuits Laboratories | 26-27, 217, 280 | Vicor Corp* | 233 |
| Casio Inc | 64 | Monolithic Memories Inc | 16-17 | Visionics | 261 |
| Central Data Corp | 156 | National Instruments | 104 | VLSI Technology Inc | 56-57 |
| Ciprico Inc | 186 | NCR Corp | 46 | Wavetek San Diego Inc | 3 |
| Comair Rotron Inc | 47 | NEC Corp | 176 | Winsystems | 263 |
| Computer Dynamics | 256 | NEC Electronics Inc | C3 | Wintek | 262, 264 |
| Connecticut Microcomputer | 263 | Nicolet | 25, 262, 264 | Wyse Tech | 199 |
| Conragan | 261 | NJR | 164 | XYZ Electronics Inc | 261 |
| Control Data | 137-144 | Northwest Instrument Systems | 20 | YU Instruments | 263 |
| Cooper Tools* | 81 | Nova Tran Corp | 203 | Ziatech Corp | 104 |
| Cubit/Proteus Industries Inc | 105 | Octagon Systems | 265 | Zilog Inc | 75 |
| Cybernetic Micro Systems | 256 | OKI Semiconductor | 242-243 | Zoran | 122 |
| Cypress Semiconductor | 54 | Omron Electronics Inc* | 221 | Z-World | 265 |
| Data Delay Devices | 47 | Orion Instruments | 200 | | |
| Data Display Products | 87 | Outlook Technology | 166 | | |
| Data I/O Corp | C4 | Patton & Patton | 264 | | |
| Data Precision Corp | 226 | PEP Modular Computers | 88 | | |
| Data Translation Inc | 76 | Philips Elcoma Div** | 42-43 | | |
| Design Computation | 263 | Philips Test & Measuring Instruments Inc** | 81, 89 | | |
| Digelec | 261 | Plessey Microsystems | 175 | | |
| Digital Equipment Corp* | 228-229 | Plessey Semiconductor | 106 | | |
| Dynatem Inc | 234 | Potter & Brumfield | 225 | | |
| Elek-Tek | 266 | Power-One Inc | 45 | | |
| Elfab Corp | 107 | Powertec Inc* | 176 | | |
| Emcor Products | 74 | Precision Monolithics Inc | 119 | | |
| Enertec | 261 | Programmable Logic Technologies | 263 | | |
| Epotek Corp | 44 | Pro-Log Corp | 4 | | |
| Farnell International Ltd** | 219 | Qualidyne Systems Inc | 44 | | |
| Fujitsu America Inc/ Storage Products* | 191 | Quatech | 264 | | |
| Fujitsu Microelectronics Inc* | 83-85 | Quelo | 265 | | |
| GE/RCA Solid State | 18, 58-59, 236-237 | Rifa Inc/Power Products | 245 | | |
| GTEK Inc | 154 | Rogers Corp | 211, 262 | | |
| Harris Semiconductor Products | 184-185 | Samsung Semiconductor | 193-196 | | |
| Heurikon Corp | 257 | Samtec | 264 | | |
| Hewlett-Packard Co | 35-38, 48-49, 91 | SBE Inc | 103 | | |
| Hitachi America Ltd* | 42-43 | Seagate Technology | 108-109 | | |
| Hughes Aircraft Co | 110 | SGS Semiconductor Corp | 92-93 | | |
| Hypertronics Corp | 206 | Siemens AG** | 83, 84-85, 230-231 | | |
| I-Bus Systems Inc | 252 | Signetics Corp | 134-135 | | |
| IC Sensors* | 259 | Silicon Systems Inc | 78, 79 | | |
| IMC | 263 | Single Board Solutions | 262 | | |

Recruitment Advertising

| | |
|---------------------------------------|-----|
| Digital Equipment Corp | 276 |
| Illinois Dept of Employment | 276 |
| ITT Avionics Division | 274 |
| McData Corp | 272 |
| Nelcor | 275 |
| QMS | 273 |
| Rockwell | 277 |

*Advertiser in US edition

**Advertiser in International edition

This index is provided as an additional service. The publisher does not assume any liability for errors or omissions.

LOOKING AHEAD

EDITED BY CYNTHIA B RETTIG

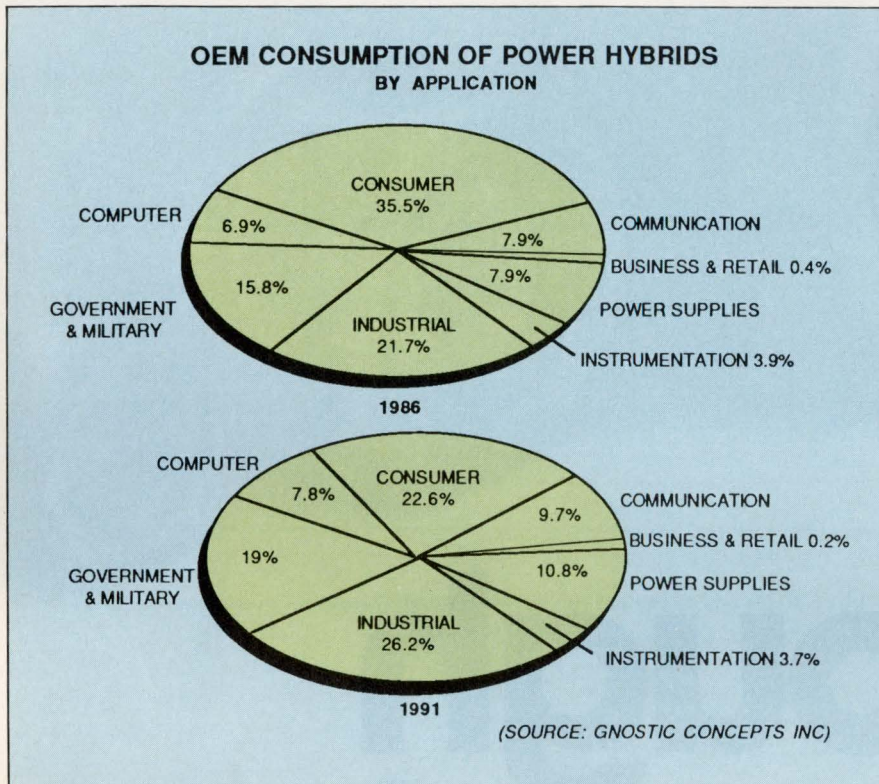

Miniaturization move aids power-hybrid market

The rush to miniaturize is causing hybrids to lose some ground to power ICs, but their use as replacements for discrete components will at least offset that loss, according to Gnostic Concepts Inc, a San Mateo, CA, market-research and consulting firm. Power hybrids provide denser configurations and require fewer discrete components than do discrete devices. They also have the advantage over power ICs of greater power dissipation. Furthermore, you can produce custom circuits in low volumes. Gnostic Concepts estimates power-hybrid sales will grow from \$186.3 million in 1986 to \$392.5 million in 1991—a 16.1% annual growth rate.

For its study, the market-research firm defined power hybrids as hybrid circuits that dissipate at least 5W per square inch. They further distinguished power hybrids from high-voltage hybrids, which can have a relatively low current flow.

Three application areas dominate the market for “smart” power hybrids: motor controllers, programmable voltage regulators, and automotive ignition systems. Because of their extensive use in robotics, motor controllers will be the pre-eminent application through the remainder of the decade. An increased interest in smart power supplies will boost the demand for programmable voltage regulators. Growing dependence on electronics in automobiles has contributed to power-hybrid use in automotive ignition systems, where they are employed to sense changes in various parameters and to thereby maximize engine performance.

Of the eight major end markets, Gnostic Concepts predicts the power-supply segment will grow the fastest, averaging 23.6% annually through 1991. The most dramatic change will involve the industrial- and consumer-electronic segments. Whereas the industrial-electronic segment claimed 21.7% of the market in 1986, it will have the largest

share—26.2%—by 1991. On the other hand, the consumer-electronics share will drop from 35.5% in 1986 to 22.6% by 1991.

Delivery delays clog LVDT market

Users of displacement sensors are complaining of long lead times and back orders, especially in the delivery of LVDTs (least voltage coincidence detectors), and the inadequate production capacity will continue to face increasing demand over the next few years, according to Venture Development Corp (Natick, MA). Valued at \$328 million last year, the total market for linear-proximity and displacement sensors should reach \$691.6 million in 1991. Annual growth rate will average 16% over the period.

Availability problems are acute in the military and aerospace industries, which use large quantities of custom-made LVDTs. The ongoing conversion to fly-by-wire (tethered) technology, particularly in military aircraft, has substantially contributed to the growth in LVDT demand. The use of that technology necessitates more feedback about position of control surfaces, engine components, and landing gear. The tendency toward redundant systems—which increase reliability by using several LVDTs in single loops that previously would have employed only one—has stimulated growth as well.

Response to the delay crisis to date has been mixed. At least two OEMs now have in-house production facilities for LVDTs or, as a substitute, for precision potentiometers. And there's some chance that others will follow, by developing their own facilities, or perhaps, through acquisition. Two of the major manufacturers of the devices have already expanded their capacity in order to meet current and expected demands.

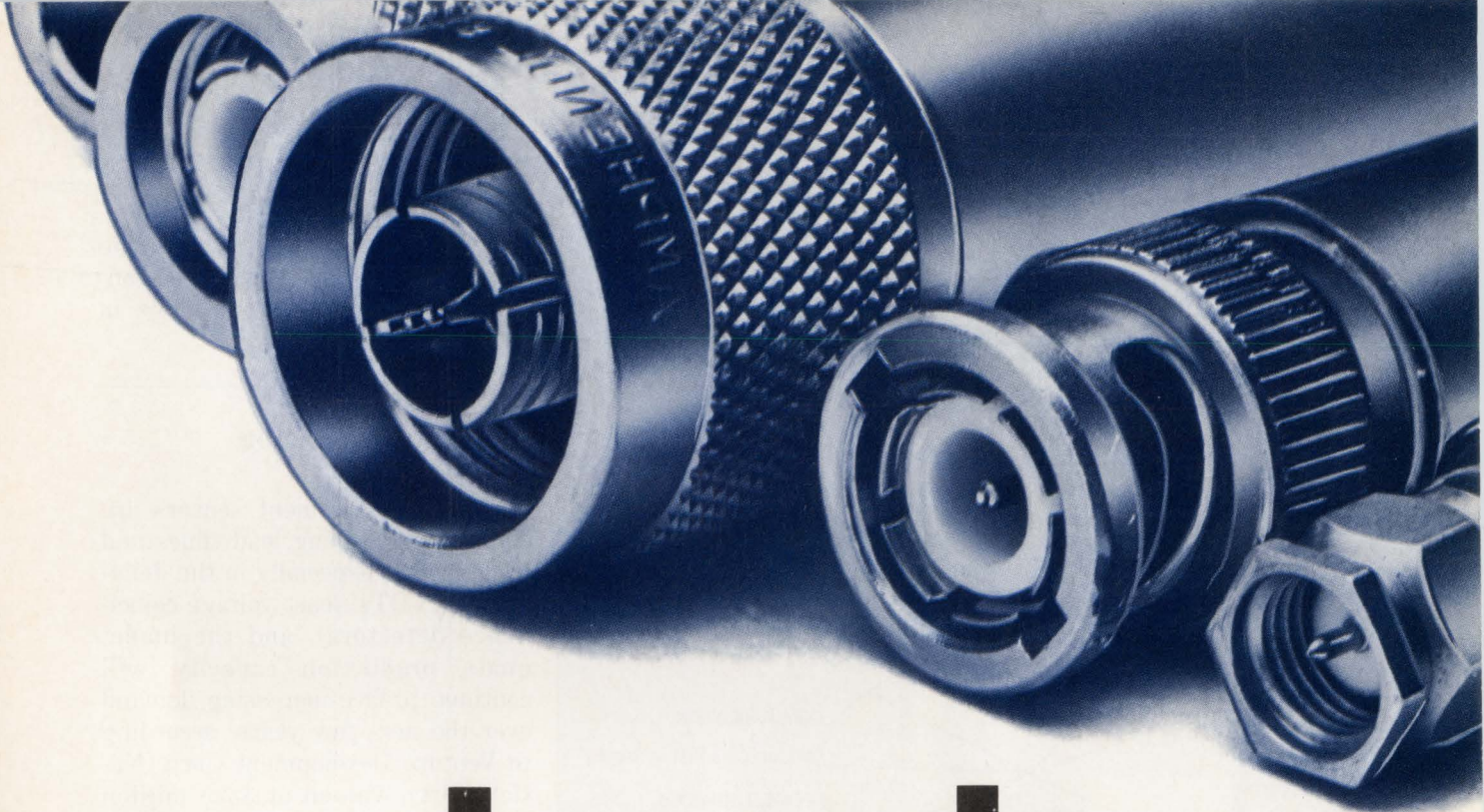

tough attenuators

\$11.95
(1-49)

one-piece design defies rough handling

- Each unit undergoes high-impact shock test
- Unexcelled temperature stability, .002 dB/°C
- 2W max. input power (SMA is 0.5W)
- BNC, SMA, N and TNC models
- Immediate delivery, one-year guarantee
- **50 ohms, dB values,** 1, 2, 3, 4, 5, 6, 7, 8, 9, 10, 12, 15, 20, 30, and 40
- **75 ohms dB values,** 3, 6, 10, 15, 20 BNC only
- **Price** (1-49 qty.)
 CAT (BNC) \$11.95 SAT (SMA) \$14.95
 TAT (TNC) \$12.95 NAT (N) \$15.95

| *Freq. (MHz) | Atten. Tol. (Typ.) | Atten. Change, (Typ.) over Freq. Range | | VSWR (Max.) | |
|--------------|--------------------|--|-----------|-------------|---------------|
| | | DC-1000 | 1000-1500 | DC-1000 MHz | 1000-1500 MHz |
| DC-1500 MHz | ±0.3 | 0.6 | 0.8 | 1.3 | 1.5 |

*DC-1000 MHz (all 75 ohm or 30 dB models) DC-500 MHz (all 40 dB models)

Model Availability

SAT (SMA) CAT (BNC) NAT (N) TAT (TNC)

Model no. = a series suffix and dash number of attenuation.

Example: CAT-3 is CAT series, 3 dB attenuation.

Precision 50 ohm terminations only \$6.95 (1-24)
 DC to 2 GHz, 0.25W power rating, VSWR less than 1.1
 BNC (model BTRM-50), TNC (model TTRM-50)
 SMA (model STRM-50), N (model NTRM-50)

finding new ways ...
setting higher standards

Mini-Circuits

A Division of Scientific Components Corporation

P.O. Box 350166, Brooklyn, New York 11235-0003 (718) 934-4500

Fax (718) 332-4661 Domestic and International Telexes: 6852844 or 620156

C 92 REV. C

EDN August 6, 1987

**Cost-effective
high voltage
power MOSFETs
you can
depend on**

1000V HEXFETs

Some so-called high voltage power MOSFETs just can't seem to deliver what they promise. But HEXFETs offer exceptional stability in three new *optimized* high voltage families: 800V, 900V and 1000V. Each voltage is paired to a specific $R_{ds(on)}$ value for the best cost-per-amp ratio. So you can spec just what you need without straining your design budget.

Our high voltage TO-3 HEXFETs can handle your heavy industrial and hi-rel requirements. For less demanding applications, you can choose TO-220 or TO-3P case styles.

No matter how you mix and match these HEXFETs, they all provide faster switching and high blocking voltage capabilities. Plus *guaranteed* repetitive avalanche and dynamic dv/dt ratings – two extra safety margins at no extra cost.

The complete HEXFET power MOSFET line is described in our new 1987 catalog. Write for your free copy. Or call (213) 607-8842.

NOW

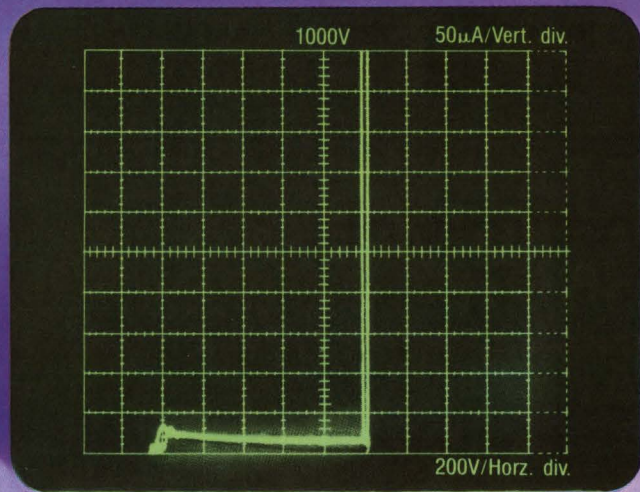

Example of 1kV HEXFET Stability: After 1000 hours of HTRB testing, TO-3 device performs beyond rated voltage with no current leakage.



Most HEXFETs now in stock
for immediate delivery!

Available Packages With Corresponding $R_{ds(on)}$ Values

| Voltage Ratings | TO-3, TO-3P and TO-220AB | | TO-3 and TO-3P | |
|-----------------|--------------------------|------|----------------|------|
| | | | | |
| 800V | 6.5Ω | 3.2Ω | 2.0Ω | 1.2Ω |
| 900V | 8.0Ω | 4.0Ω | 2.5Ω | 1.6Ω |
| 1000V | 11.5Ω | 5.6Ω | 3.5Ω | 2.0Ω |

Number 1 in
power MOSFETs

**International
Rectifier**

WORLD HEADQUARTERS: 233 KANSAS ST., EL SEGUNDO, CA 90245, U.S.A. (213) 772-2000. TWX 910-348-6291. TELEX 472-0403
EUROPEAN HEADQUARTERS: HURST GREEN, OXTED, SURREY RH8 9BB, ENGLAND TELEPHONE (0883) 713215. TELEX 95219

Power MOSFETs • CMOS Power ICs • Commercial/Custom Power Packages • Schottkys Rectifier Diodes • Thyristors (SCRs) • Diode Bridges • Molded Circuits • Assemblies

CIRCLE NO 123

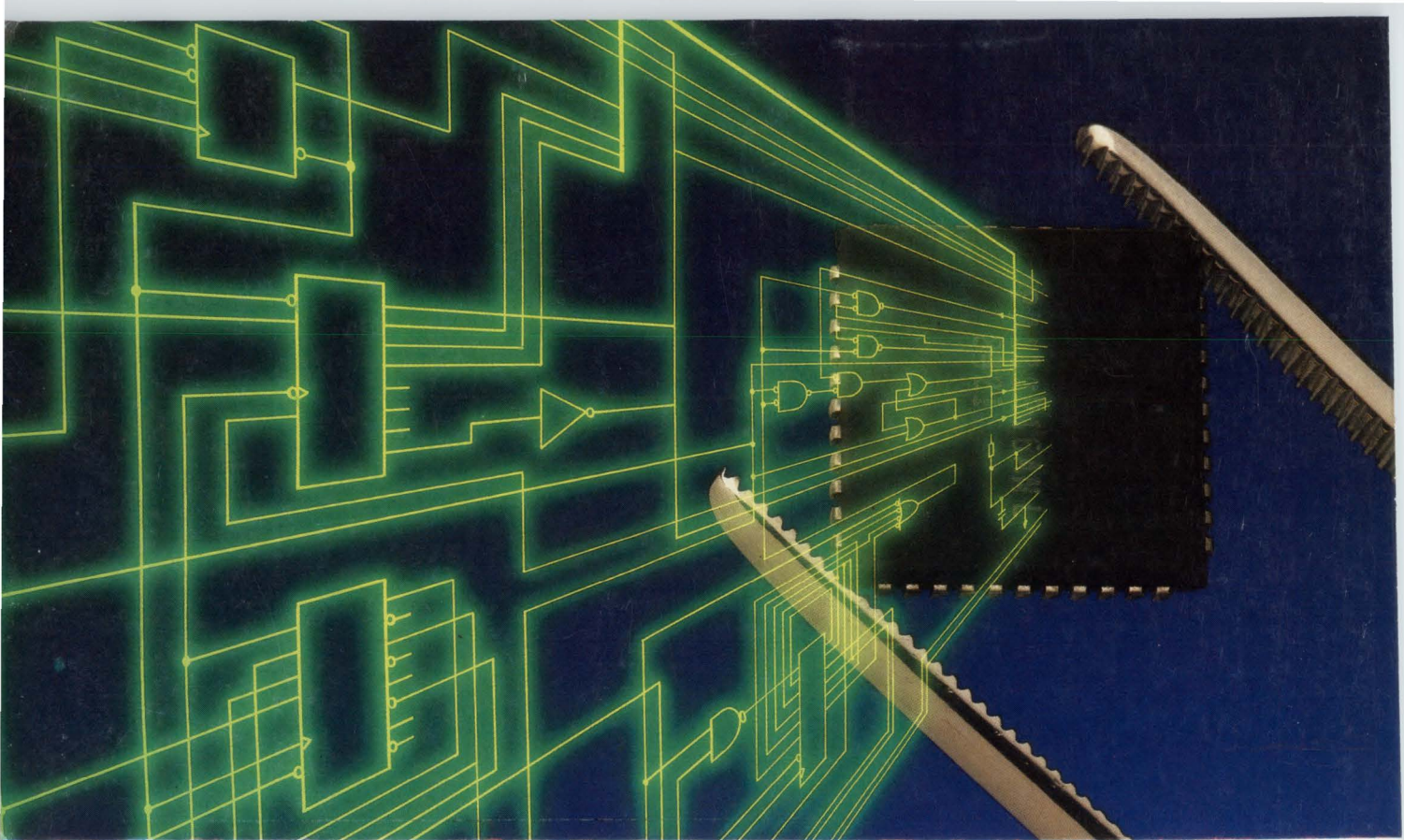

THE FIRST PROGRAMMER WITH A SINGLE SITE FOR EVERY DEVICE.

NEW UNISITE 40 HANDLES LEADING-EDGE DEVICES WITH SPEED AND EASE.

Now you can program and test the latest programmable devices and packages, fast and accurately — all in a single site. The first true universal pin drivers support any device of a given package type in the same site. The UniSite™ 40's single DIP socket handles any device up to 40 pins, including PLDs, PROMs, IFLs, FPLAs, EPROMs, EEPROMs, and microcontrollers. The same site accommodates the most popular PLCCs and SO packages. A 16-bit processor, coupled with custom ICs and high-speed RAM, set new speed records for programming and testing.

TIMELY ACCESS TO TOMORROW'S DEVICES. With universal pin driver electronics hardware, device-specific instructions can be loaded from one



3 1/2" micro-diskette. When new devices are introduced, you simply load a new master diskette, and the UniSite 40 is quickly updated.

MENUS MAKE PROGRAMMING EASY.

Use your cursor to select any function. Menus prompt you step-by-step and HELP messages assist you

throughout operation. A built-in listing of devices speeds part selection. The UniSite 40 can even save your most frequently used parameters for instant recall.

SHORTCUTS SPEED SETUP. More frequent users can bypass menus and zoom directly to specific operations by selecting key commands. Special software commands, like the ones in our QuickCopy™ mode, are also available to streamline your programmer operation.

DESIGN FREEDOM FOR TOMORROW. Call today and get the design freedom only the UniSite 40 can provide.

1-800-247-5700
Dept. 802

DATA I/O

Data I/O Corporation 10525 Willows Road N.E., P.O. Box 97046, Redmond, WA 98073-9746, U.S.A. (206) 881-6444/Telex 15-2167
 FutureNet 9310 Topanga Canyon Boulevard, Chatsworth, CA 91311-5728 (818) 700-0691/Telex 910-494-2681
 Data I/O Canada 6725 Airport Road, Suite 302, Mississauga, Ontario L4V 1V2 (416) 678-0761/Telex 06968133
 Data I/O Europe World Trade Center, Strawinskylaan 633, 1077 XX Amsterdam, The Netherlands (20) 622906/Telex 16616 DATAIO NL
 Data I/O Japan Sumitomosaimi Higashishinbashi Bldg., 8F, 2-1-7, Higashi-Shinbashi, Minato-ku, Tokyo 105, Japan
 (03) 432-6991/Telex 2522685 DATAIO J