

DATAMATION®

DECEMBER 1980 USA

GALLERY OF SYSTEMS SOFTWARE

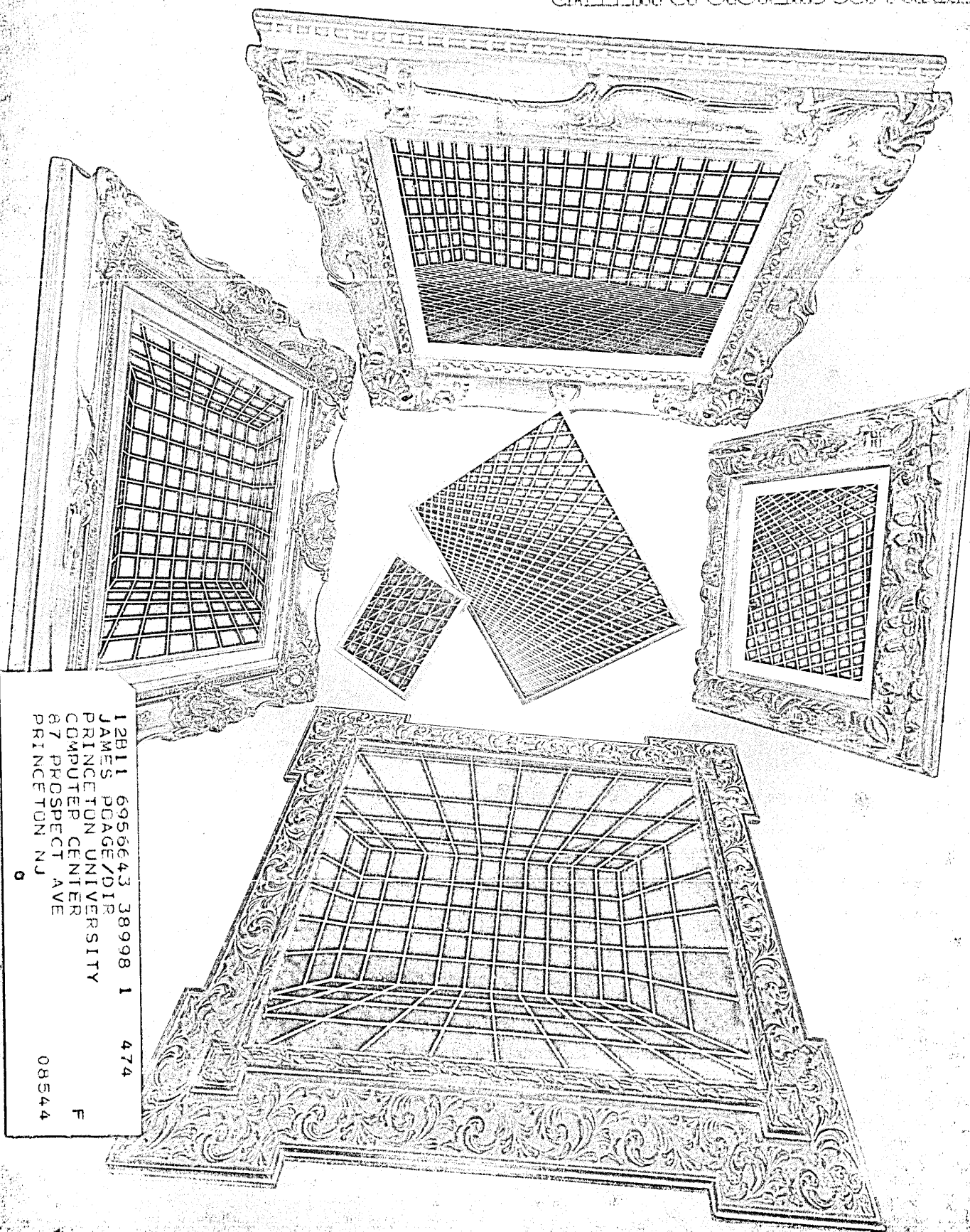

12811 6956643 38998 1 474
JAMES PDAGE/DIR
PRINCETON UNIVERSITY
COMPUTER CENTER
87 PROSPECT AVE
PRINCETON NJ 08544

F

2X the speed, 3X the density, 4X the capacity, 1/3 the cost.

The first low cost GCR Tri-Density Tape System offering large system performance.

Kennedy is, and has always been, the leader in peripheral tape technology. With Model 9400, Kennedy has done it again. For instance:

2X the speed. Model 9400 is a dual speed transport, operating at 45 ips in the GCR mode and 75 ips in the PE/NRZI modes with a maximum rewind speed of 500 ips.

3X the density. The drive utilizes Group Coded Recording at 6250 BPI along with previous industry standard densities of 1600 BPI/PE recording and 800 BPI/NRZI recording.

4X the capacity. In GCR mode, the Model 9400 can store up to 180M BYTES of data (four times more capacity than the traditional 1600 BPI drive).

More? The Model 9400 features multiple processors to separate data handling and control functions. An 8088

processor provides overall system control and accommodates a variety of industry standard interfaces.

Among the many features of the 9400 is its RS-232 communication port and complete internal software which permits off-line diagnostic operations via a terminal, the host computer or by a remote test facility with a phone modem.

1/3 the cost. Best of all, the Model 9400 is priced at about 1/3 the cost of a conventional GCR tape system. Kennedy Company... designers of the finest peripheral tape products for 20 years.

KENNEDY

An Allegheny International Company

1600 Shamrock Ave., Monrovia, CA 91016

(213) 357-8831 ITT TELEX 472-0116 KENNEDY

CIRCLE 1 ON READER CARD

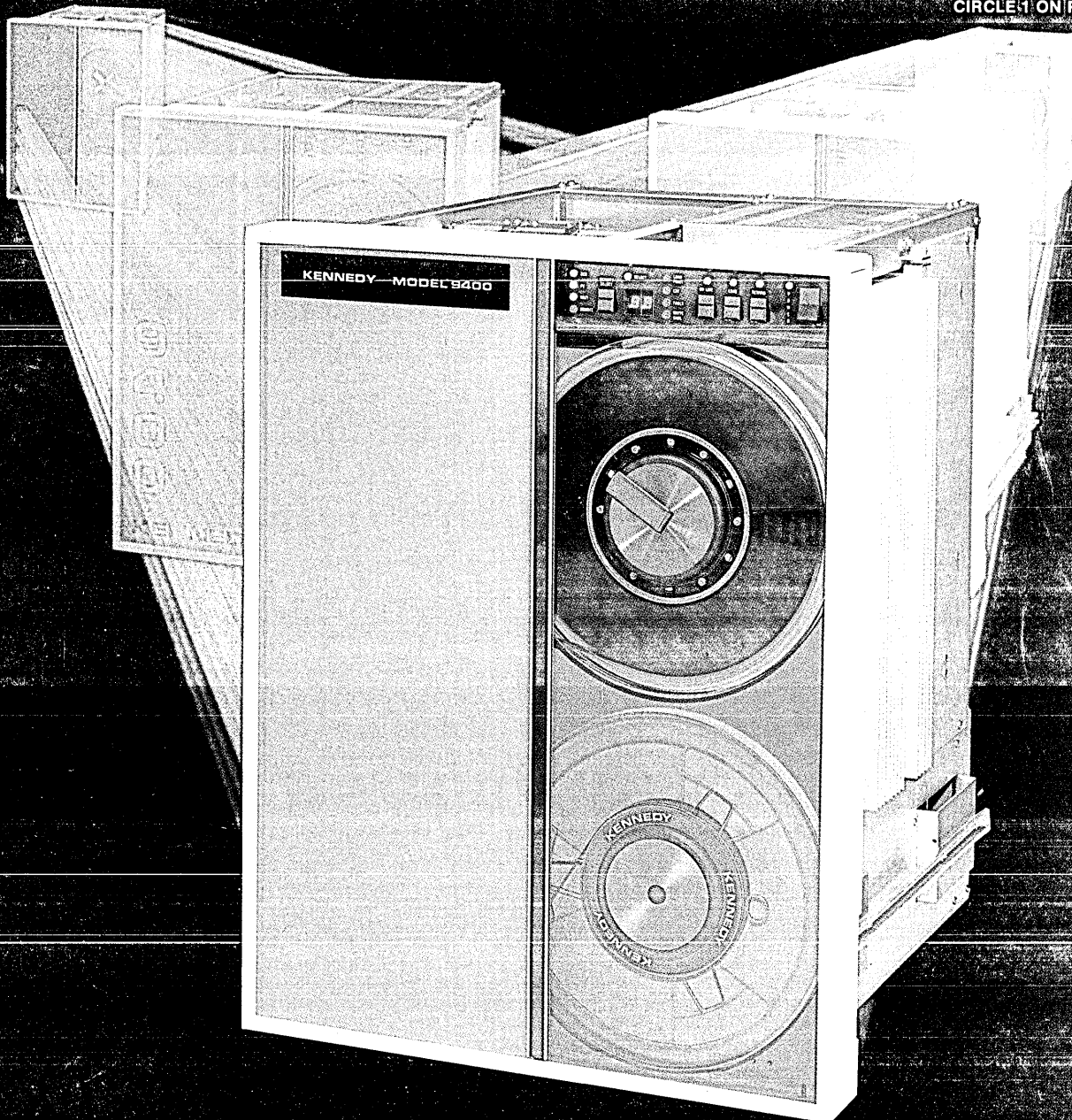

KENNEDY • QUALITY • COUNT ON IT

Our IBM Protocol Converter is not the same under the skin.

MICOM's new Micro7400 is very, very different from any other protocol converter. It provides a gateway for quite asynchronous terminals to access IBM mainframe applications. It goes far beyond the basic capabilities of IBM 3270s and other protocol converters. *It's even easy to use.*

Since MICOM is the world's largest volume manufacturer of data concentrators—thanks to its Micro300/2 "Orange Box" family—its computerized IBM/MICOM protocol converter should include the same features and capabilities that made the data concentrators so popular and popular for asynchronous terminal users wishing they could connect to IBM mainframes, and for mainframe DB managers looking for less expensive terminals, adding concentrator features to a converter makes for a surprisingly effective hybrid.

All Standard IBM 3270 Features

Functioning as an IBM 3274 Model 5/30 Cluster Controller using either Bisync or SNA/SBC protocol, the Micro7400 allows AS/400 terminals (or personal computers emulating terminals) to perform as 3270s. Display terminals emulate IBM 3270s, printer terminals emulate IBM 3270s. And special software allows printer terminals to interact with full-screen programs originally developed for 3270s.

Plus Extra Capabilities

The Micro7400 also offers features not available in the IBM 3270 line, including direct access to the protocol con-

verter terminal-related diagnostics, and not-yet-official channel configuration for setting terminal-related parameters like parity.

Support for IBM Rational Computers

IBM PCs connected to the Micro7400 can emulate IBM 3270 terminals too for communicating with mainframes. Diskette-based MICOM software makes it easy.

Switching Between Multiple Hosts

Users can switch between two IBM hosts, or between an IBM host and asynchronous ports or one or more mainframe computers—completely under terminal control.

Command Port

Unique among protocol converters, the Micro7400's Command Port allows a network manager to dynamically alter operating parameters like priority assignment, as well as providing monitoring, diagnostic, and control facilities.

As Low As \$400 Per Channel

Even the pricing is more like a concentrator. Standard models are available in support from two to 12 channels, at prices as low as \$400 per channel. A budget-minded 2-channel "Lite" model is also offered, as are cost-saving versions with built-in modems. And there's much more. Call today for a price list and a 12-page color brochure, or use the Reader Service Number below.

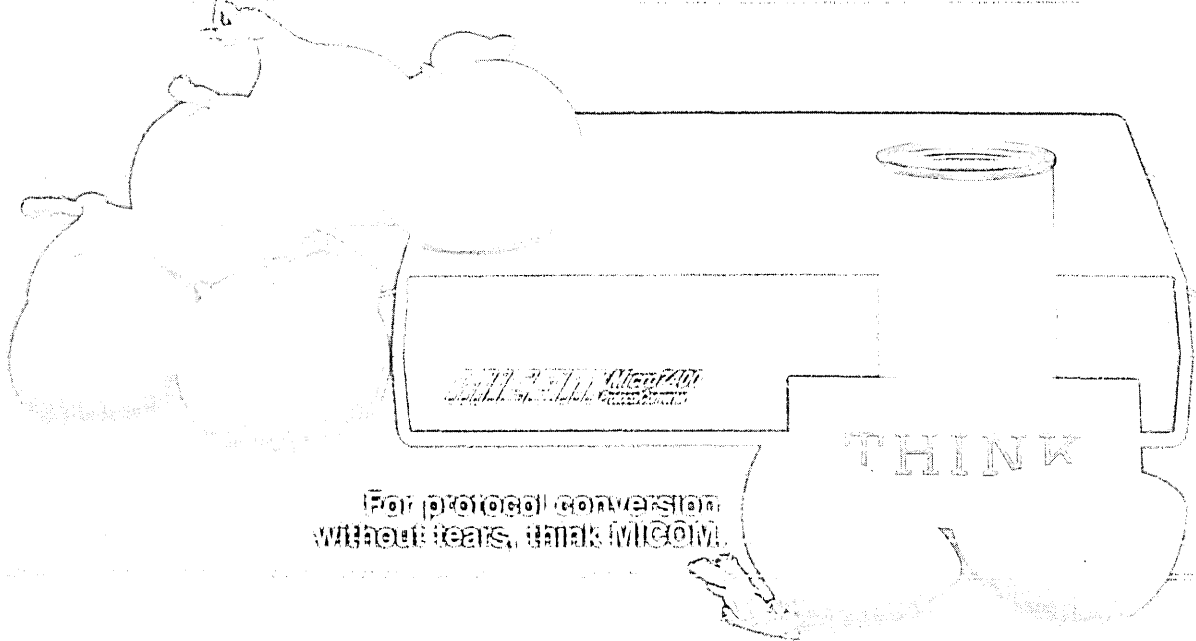

For protocol conversion without tears, think MICOM.



MICOM SYSTEMS, Inc. • 20151 Nordhoff Street • Chatsworth, CA 91311 • Telephone (214) 992-3824 • TWX 910/494-4910
 Regional Sales/Service • Atlanta, GA • (404) 485-2999 • Boston, MA • (617) 527-4010 • Chicago, IL • (612) 789-2450
 Dallas, TX • (214) 258-0774 • St. Louis, MO • (314) 576-7626 • Tarrant, TX • (204) 886-4000
 MICOM EUROPE Ltd. • Bal Gouni • 15 Gladock Road • Reading, Berkshire RG2 0JW, England • (0734) 866804 • Telex 8474165

Available now from these stocking shops.

AK: Appleton (609) 238-7770; AL: Birmingham (205) 788-6100; CA: Anaheim (714) 639-7300; CA: San Francisco (415) 435-4551; CA: San Jose (415) 251-7220; CO: Colorado Springs (303) 534-0300; FL: Ft. Lauderdale (305) 777-9771; GA: Atlanta (404) 251-5520; IL: Chicago (612) 789-2450; IN: Indianapolis (317) 251-5770; IA: Des Moines (319) 281-2000; MD: Baltimore (301) 251-5770; MI: Detroit (313) 251-5770; MN: Minneapolis (612) 789-2450; MO: St. Louis (314) 576-7626; NY: New York (212) 688-2255; OH: Columbus (614) 462-2255; OH: Cleveland (216) 425-4455; OH: Cincinnati (513) 251-5770; OH: Dayton (513) 251-5770; OH: Toledo (419) 251-5770; OK: Oklahoma City (405) 228-3125; PA: Allentown (610) 262-2200; PA: Erie (814) 835-2000; PA: Harrisburg (717) 251-5770; PA: Philadelphia (215) 261-2255; PA: Pittsburgh (412) 789-2450; RI: Providence (401) 251-5770; SC: Columbia (803) 732-2200; TN: Memphis (901) 251-5770; TX: Dallas (214) 258-0774; TX: Houston (713) 251-5770; TX: San Antonio (512) 351-7725; UT: Salt Lake City (801) 488-5522; VA: Richmond (804) 251-5770; WA: Seattle (206) 251-5770; WI: Milwaukee (414) 251-5770; WY: Cheyenne (307) 251-5770.

CIRCLE 4 ON READER CARD

Candle Introduces EPILOG™/MVS

MVS PERFORMANCE IN 3 EASY STEPS

The EPILOG™/MVS Installation Performance Management System will allow you to easily analyze and manage your performance and capacity concerns.

Step 1

Discover your problems. Ask EPILOG/MVS to plot TSO response times or batch job run times (yesterday, last week, last month) on your CRT. After analyzing the workload for problems, simply place a "d" next to the problem time period and press enter. In this example, July 12 is the problem day.

DATE	RESPONSE
7/8	4
7/11	5
7/12	10
7/13	4
7/14	5
7/15	4
7/19	3
7/20	4

Historical TSO plot for the month of July

Step 2

The result is a display of degradation reasons for that time period. Now you know the major causes of poor response. In this case, paging caused 60% of response time problems. But what is causing the degradation? Place an "r" on the problem line and press enter.

USING CPU	8%
PAGE-IN WAIT	60%
WAITING FOR CPU	12%
DISK SYS 001 ACTIVE	5%

Detailed analysis of TSO response time problem for July 12.

Step 3

EPILOG/MVS will automatically bring you the information needed to help analyze degradation for that time of day. In this example, Step 3 shows an analysis of paging activity where a paging device has contention from another system.

Use EPILOG/MVS for monitoring: trends, capacity, TSO response time problems, batch job run times, effects of changing hardware, and effects of making tuning changes. It's as easy as 1-2-3.

TOTAL PAGES/SEC=160
DEVICE PAGE01
% IN USE=15%
% RESERVE DELAY=60%

Analysis for paging on July 12

- Please send me more information on EPILOG/MVS.
 Please enter my free subscription to the Candle Computer Report.

Name _____ Title _____
Company _____
Address _____
City/State/Zip _____
Phone _____

!Candle® Dept MI · 10880 Wilshire Blvd., Suite 2404 · Los Angeles, CA 90024

A-201

!Candle®

10880 Wilshire Boulevard Suite 2404
Los Angeles, CA 90024
213 · 207 · 1400

CIRCLE 5 ON READER CARD

DATAAMATION®

DECEMBER 1983/\$4.00 U.S.A.
VOLUME 29 NUMBER 12
This issue, 176,285 copies

FEATURES

30 IN FOCUS

Which PC deserves to print out "I feel pretty"? Industrial designer Marc Harrison has the answer in "Mirror, Mirror, on the Wall."

104 SYSTEMS SOFTWARE SURVEY Data Decisions

The pictures at the exhibition were packages, the critics were more than 5,000 users, and the reviews were mostly good.

152 ALAN TURING: THE ENIGMA Andrew Hodges

An excerpt from the new book about the unsung, unfathomed father of programming.

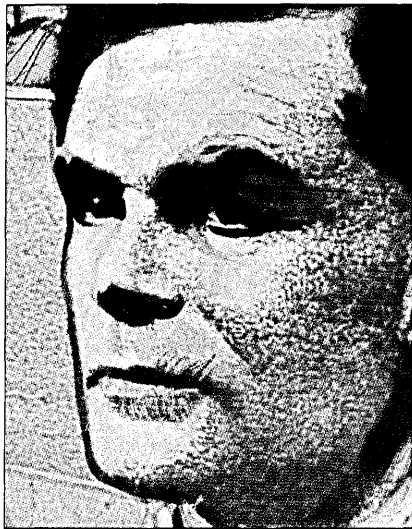

178 DP CAREER PATHS Kate M. Kaiser

Frustrations and opportunities for systems professionals abound in a field with no clear roads to advancement.

193 WINNERS AND LOSERS IN THE FIFTH GENERATION Frederic G. Withington

Predictions concerning the futures of four of the major information technologies.



212 THE POLITICS OF SYSTEMS Samuel H. Solomon

Dp managers must attend to machinations as well as machines.

220 PAIRING FOR THE FUTURE Edwin R. Coover

Although X.25 and SNA are very different, they'll be a double standard for datacom in the '80s.

235 THE SOFTWARE REHEARSAL John G. Seddon

User participation and live data help prepare a business for installation of a new package.

240 END-USER GAME PLAN Hugh Ryan

Suggestions for making the user's computing environment friendly and productive.



NEWS IN PERSPECTIVE

- 46 **USERS' CONCERNS**
Honeywell opts for NEC.
Avoiding local loops.
- 55 **SOFTWARE**
Comserv does its books.
ADAPSO in the desert.
- 71 **DISTRIBUTED PROCESSING**
Who believes in heros?
IBM ponders Unix.
- 82 **OFFICE AUTOMATION**
IBM targets OA.
- 88 **GOVERNMENT**
Going too far.
- 99 **EFTS**
Is real POS coming?
- 100 **BENCHMARKS**

DEPARTMENTS

- 8 **LOOKING BACK**
- 13 **LOOK AHEAD**
- 18 **CALENDAR**
- 23 **LETTERS**
- 29 **EDITORIAL**
Painting the world blue.



- 247 **PEOPLE**
- 251 **HARDWARE**
- 267 **SOFTWARE & SERVICES**
- 281 **SOURCE DATA**
- 292 **ADVERTISERS' INDEX**
- 300 **MARKETPLACE**
- 304 **ON THE JOB**
- 309 **READERS' FORUM**

INTERNATIONAL 246-1

- 3 **HOLD THE PHONE**
- 11 **LOCAL AREA SETBACKS**
- 15 **BUSINESS COMMUNICATIONS' BRAVE NEW WORLD**
- 24 **JAPAN'S DIGITAL DRIVE**
- 29 **TELECOM 83 —TRENDS AND TOPICS**
- 32 **PRODUCT SPOTLIGHT**

OEM SUPPLEMENT 247-1

- 3 **1984 MARKET FORECAST**
- 11 **THEY'D RATHER SWITCH THAN FIGHT**
- 21 **IMPORTANCE OF HIGH TOUCH**

COVER PHOTOGRAPH BY ROBERTO BROSAN

Once a month isn't enough.

Beginning in April, 1984, *Datamation* will increase its frequency to twice a month, 24 times a year.

I'd like you to know the reasons behind this change, and why I believe it represents such an important benefit to you, the *Datamation* reader.

For 26 years, *Datamation* has been dedicated to covering every vital aspect of the computer industry for the information processing professional. And with a worldwide circulation of over 163,000, we're the largest publication serving this important audience.

But today, your role as an information processing professional is being rapidly redefined and broadened. Unprecedented growth and change are taking place.

Decentralization, the personal computer, the microprocessor, advances in data communications, fourth generation languages, office automation... these are just a few of the forces converging to reshape the information processing industry.

So, in order for *Datamation* to provide the scope of information, analysis, and advice you've come to rely on, we need to grow. Not to a 700-page "phone book", but to more frequent issues.

With two issues each month, *Datamation* will provide even more quality editorial. Expanded departments. And more timely topics.

I'd like to thank you for your loyalty to our publication. And I promise you that starting this April, *Datamation* will be twice the magazine it is today.

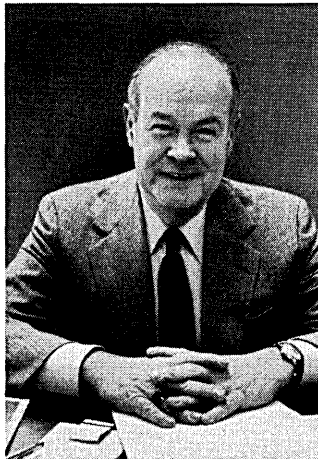

Best regards,

James M. Morris
Publisher

DATAMATION.
875 Third Avenue, New York, NY 10022
212-605-9400

DATAMATION*

Editor John L. Kirkley
Managing Editor Becky Barna
Senior Editor Larry Marion
News Editor John W. Verity
Features Editor Kenneth Klee
Copy Editor Florence Lazar
New Products Editor Michael Tyler
Assistant Features Editor Deborah Sojka
Assistant Copy Editor Harriet Sigerman
Assistant Editor Lauren D'Attilio
Editorial Assistant Donna Lyons
Bureau Managers
San Francisco Edward K. Yasaki
Los Angeles Edith D. Myers
Minneapolis Jan Johnson
Boston Ralph Emmett
Washington Correspondent Willie Schatz
Editorial Advisor Robert L. Patrick
Technical Advisor Lowell Amdahl
Advisory Board Howard Bromberg,
Philip H. Dorn, Joseph Ferreira,
Bruce W. Hasenyager, David Hebditch,
John Imlay, Louis Naugès, Terry G. Mahn
Angeline Pantages, Malcolm Peltu,
Russell Pipe, Carl Reynolds, F. G. Withington,
Amy Wohl.
Contributing Editors Pamela Archbold,
Laton McCartney, Hesh Wiener
International Editor Linda Runyan
European Managing Editor Paul Tate
Technology Editor, Europe Fred Lamond
Correspondents
London John Lamb
Paris James Etheridge
Oslo Peter Hidas
Sydney, Australia Norman Kemp

Art Director Kenneth Surabian
Assistant Art Director Susan M. Rasco
Production Manager Dottie Viebig
Assistant Production Manager Bettye Wright

EDITORIAL OFFICES

Headquarters: 875 Third Ave., New York, NY 10022. Phone (212) 605-9400; telex 429073. **New England:** 1 Chaucer St., RFD 2, Sandwich, MA 02563, (617) 888-6312. **Midwestern:** 3607 Garfield Ave. S., Minneapolis, MN 55409, (612) 827-4664. **Western:** 1801 S. La Cienega Blvd., Los Angeles, CA 90035, (213) 559-5111; 2680 Bayshore Frontage Rd., Suite 401, Mountain View, CA 94043, (415) 965-8222. **International:** 130 Jermyn St., London SW14UU, England, (441) 839-3916, telex 914911; 13 Stanley Place, Budd Lake, NJ 07828, (201) 691-0592, telex 499-4308.

CIRCULATION

875 Third Avenue, New York, NY 10022

Circulation Manager Joseph J. Zaccaria
Operations Manager Patricia Adamo
Research Director Laurie Schnepf
Publisher James M. Morris

Technical Publishing

✓BPA Circulation audited
by Business Publications Audit

★ABP Member American Business Press, Inc.

DATAMATION (ISSN 0011-6963) Magazine is issued monthly on or about the first day of every month. Published by Technical Publishing, a company of The Dun and Bradstreet Corp., John K. Abely, President. Executive, advertising, editorial offices, and subscription departments, 875 Third Ave., New York, NY 10022. Published at Lincoln, Neb. Annual subscription rates: U.S. and possessions: \$42; Canada: \$60; Japan, Australia, New Zealand: \$100; Europe: \$90 air freight, \$190 air mail. All other countries: \$90 surface, \$190 air mail. Reduced rate for qualified U.S. students, public and school libraries: \$30. Single copy: \$4 in U.S. Special *Datamation/Dataguide* issue: \$25. Sole agent for all subscriptions outside the U.S.A. and Canada is J. B. Tratsart, Ltd., 154 A Greenford Road, Harrow, Middlesex HA13QT, England, (01)422-8295 or 422-2456. No subscription agency is authorized by us to solicit or take orders for subscriptions. Second-class postage paid at New York, NY 10001 and at additional mailing office. ©Copyright 1983 by Technical Publishing Co., a Division of Dun-Donnelley Publishing Corp., a company of The Dun and Bradstreet Corp. All rights reserved. "Datamation" registered trademark of Technical Publishing Company. Microfilm copies of *Datamation* may be obtained from University Microfilms, A Xerox Company, 300 No. Zeeb Road, Ann Arbor, Michigan 48106. Printed by Foote & Davies/Mid-America, POSTMASTER: Send address changes to *Datamation*, 875 Third Avenue, New York, NY 10022.



Choropleth Map of Products

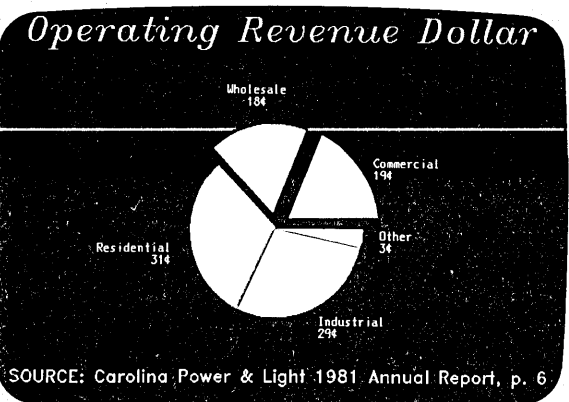

Pie Chart of Revenue

TELEPHONE EXPENDITURES FOR TELEMARKETING

(Estimated Figures)

(In Millions)

	1980	1976
Residential originated local calls	\$ 569	\$ 232
Residential originated toll calls	689	269
Business originated local calls	4,144	3,045
Business originated toll, WATS, 800 calls	4,443	2,502
TOTAL	\$9,845	\$6,048

SOURCE: DMMA Fact Book on Direct Marketing

Telephone Expenditures

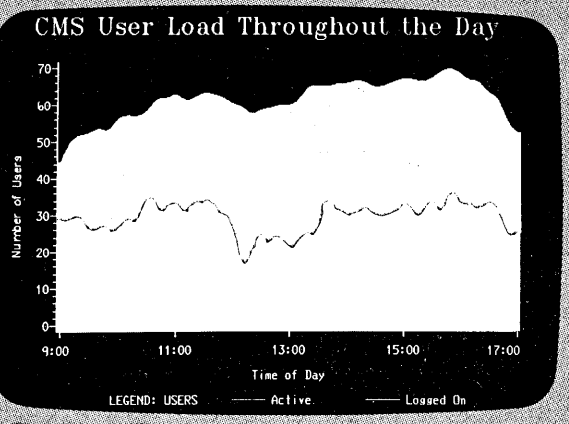

Plot of Load*Time

SAS/GRAPH

Brings you Instant Replay

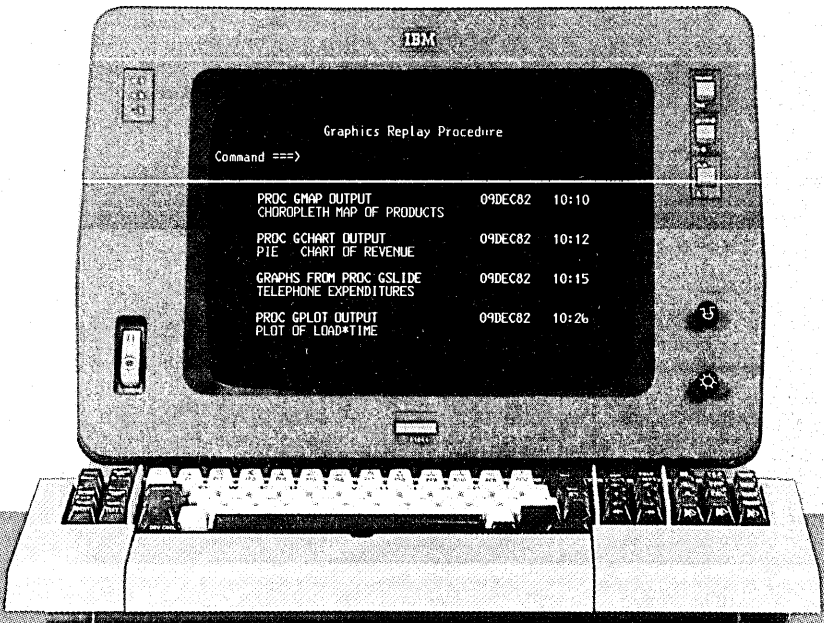

Since its introduction in 1980, SAS/GRAPH has provided "state of the art" software for business graphics. Now SAS/GRAPH brings you a new decision support tool—instant replay.

With the menu-oriented replay facility in SAS82 (our newest release) your DSS group can

- 1 generate numerous graphical analyses and store the results. Then you can
- 2 choose the best graph—charts, plots or maps—from the annotated selection SAS/GRAPH provides and
- 3 instantly display the graph with the touch of one PF key on your IBM 3279.

It's as simple as 1 + 2 + 3. And that adds up to a big time-savings.

Think of the flexibility instant replay adds to your operation. Your DSS staff can run overnight batch jobs to graph CPU utilization reports, sales totals and production figures.

The reports are ready for display at your desk the next morning.

Best of all SAS/GRAPH™ is integrated into the SAS system, so you can get the benefits of SAS for data management, statistical analysis and report writing; SAS/ETS™ for econometric forecasting and modeling; SAS/FSP™ for data entry, editing and letter-writing; and SAS/IMS-DLI™ for interfacing to IMS data bases. The SAS system operates on the IBM 370 Family and compatible machines at more than 500 OS/MVS, VM/CMS, DOS/VSE and SSX sites around the world.

Call or write today SAS Institute Inc., Box 8000, Cary, NC USA 27511-8000. Phone (919) 467-8000. Telex 802505.

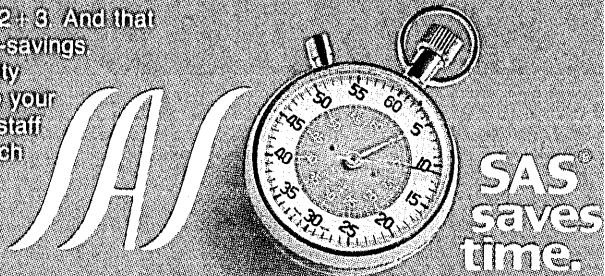

SAS® saves time.

Introducing COMPAQ PLUS, the first high-performance portable personal computer.

The makers of the COMPAQ™ Portable Computer, the industry standard, announce another breakthrough—the COMPAQ PLUS™ Portable Personal Computer. No other personal computer can handle so much information in so many places.

The new COMPAQ PLUS offers the power of an integrated ten-megabyte fixed disk drive in a portable. You get problem-solving power that no other personal computer can match.

Plus a bigger payload

How much is ten megabytes?

Enough to tackle jobs that can't be conveniently handled on most personal computers.

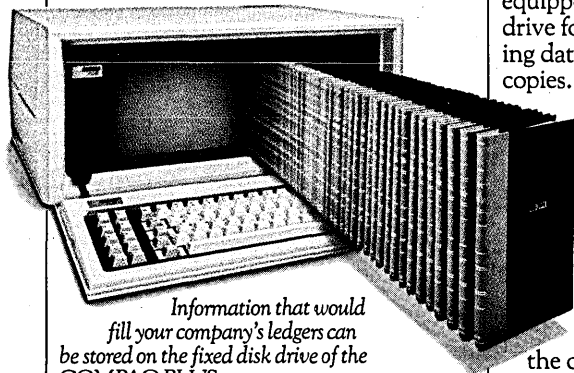

Information that would fill your company's ledgers can be stored on the fixed disk drive of the COMPAQ PLUS.

A mailing list of 100,000 names, addresses, cities, states, and Zip codes.

A full year of daily prices for every stock on the New York exchange.

Inventory records on a quarter million items.

The entire San Francisco phone book. And room left over for Peoria.

The fixed disk drive keeps all the information seconds away, ready to be searched, sorted, retrieved, analyzed or updated.

Plus better use of your time

The integrated fixed disk drive will store programs. That means your most

used programs and data can be permanently kept in the COMPAQ PLUS, ready to call up and run.

With programs permanently stored, the COMPAQ PLUS becomes a well-informed traveling companion, a tool to help you apply your best thinking anytime, anywhere.

You could store a complete library of accounting programs on the disk—payables, receivables, general ledger, and payroll—with the company's books.

You could store an inventory control program with your inventory records and a list management program with your mailing list and a filing program with your personnel files.

The COMPAQ PLUS is also equipped with a 360K byte diskette drive for entering new programs, copying data files, and making backup copies.

Plus more programs

More programs means more versatility. And the COMPAQ PLUS is impressively versatile because it runs all the popular programs written for the IBM® Personal Computer XT, available in computer stores all over the country. And they run as is, with no modification whatsoever.

And the high-capacity portable multiplies the productivity of every program it runs. Your inventory and its



The COMPAQ PLUS runs all the popular programs written for the IBM Personal Computer XT.

control programs can go with you to the factory. Your books and your accounting programs can go with you to a board meeting. Your building specs and your project management programs can go with you to the construction site.

You're buying a computer to solve problems. Why not have more problem-solving programs to choose from?

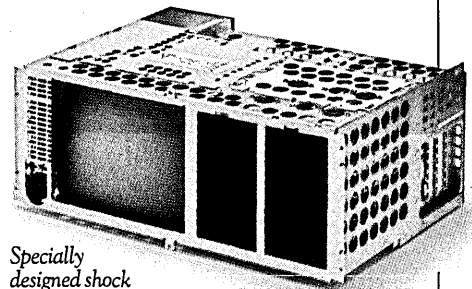

Specially designed shock isolation system protects the fixed disk from jolts.

Plus a traveler's toughness

Life can be tough on the road. A true portable has got to be tougher. The COMPAQ PLUS is.

Its integrated fixed disk drive is unique, designed specifically to travel. Rough roads and hard landings don't bother it because of a specially designed shock isolation system that protects the disk from jolts and vibration.

All the working components are surrounded by a uniquely cross-membered aluminum frame. This structure, common in race car design technology, strengthens it side-to-side, front-to-back, and top-to-bottom.

The outer case is made of LEXAN®, the same high-impact polycarbonate plastic used to make bulletproof windows and faceplates for space suit helmets.

Does a portable personal computer really have to be this tough? Take a good look at your briefcase and then decide.

Plus ease of use

The COMPAQ PLUS is big where it counts.

The display screen is big. Nine inches diagonally. Big enough to show a full 25-line-by-80-character page that's easy to read even if you're leaning back in your chair.

The keyboard is full-sized and typewriter-style for easy control.

With its built-in display, the COMPAQ PLUS makes a smooth, low profile on your desk, not an obstacle that you have to talk around.

Plus an easy way to get started

If you're buying your first personal computer and you're not sure how much capacity you need, your choice is easier now.

Start with the COMPAQ Portable with single or double 320K byte diskette drives. If you need more capacity later, upgrade to the COMPAQ PLUS. A conversion kit is available that turns the COMPAQ Portable into a COMPAQ PLUS, complete in every detail and capability.

Plus a lot more

The COMPAQ PLUS also works with optional printers, plotters, and communications devices designed for IBM's personal computer family.

It has two IBM-compatible slots for adding optional expansion boards. With companion programs, they'll let you share information with a network of personal computers in your office, communicate with your headquarters computer files while you're away, or add memory capacity if your needs grow.

The COMPAQ Portable, the industry standard in portable personal computers. ▼

The problem-solving power of a high-performance desktop personal computer can now go where you need it.



It's got high-resolution graphics and text on the same screen. A detached keyboard. Programmable function keys. Expandable memory. Dozens of other features that simply make it do a better job of personal computing.

And when you see all that the COMPAQ PLUS has to offer, you'll be pleasantly surprised by the price. The fact is, it costs hundreds less than comparably equipped desktop personal computers.

See the first high-performance portable personal computer. The COMPAQ PLUS—performance, programs, productivity. Plus problem-solving power.

The new COMPAQ PLUS, the first high-performance portable personal computer. ▼

COMPAQ PLUS Specifications

Storage

- One integrated 10-megabyte fixed disk drive
- One 360K byte diskette drive.

Software

- Runs all the popular programs written for the IBM XT.

Memory

- 128K bytes RAM, expandable to 640K bytes

Display

- 9-inch diagonal monochrome screen
- 25 lines by 80 characters
- Upper- and lowercase high-resolution text characters
- High-resolution graphics

Interfaces

- Parallel printer interface
- RGB color monitor interface
- Composite video monitor interface
- RF modulator interface

Expansion board slots

- Two IBM-compatible slots

Physical specifications

- Totally self-contained and portable
- 20"W x 8½"H x 16"D

For the name of the Authorized Dealer nearest you, call 1-800-231-0900.

©1983 COMPAQ Computer Corporation
COMPAQ™ and COMPAQ PLUS™ are trademarks of COMPAQ Computer Corporation.
IBM® is a registered trademark of International Business Machines Corporation.
LEXAN® is a registered trademark of General Electric Company.

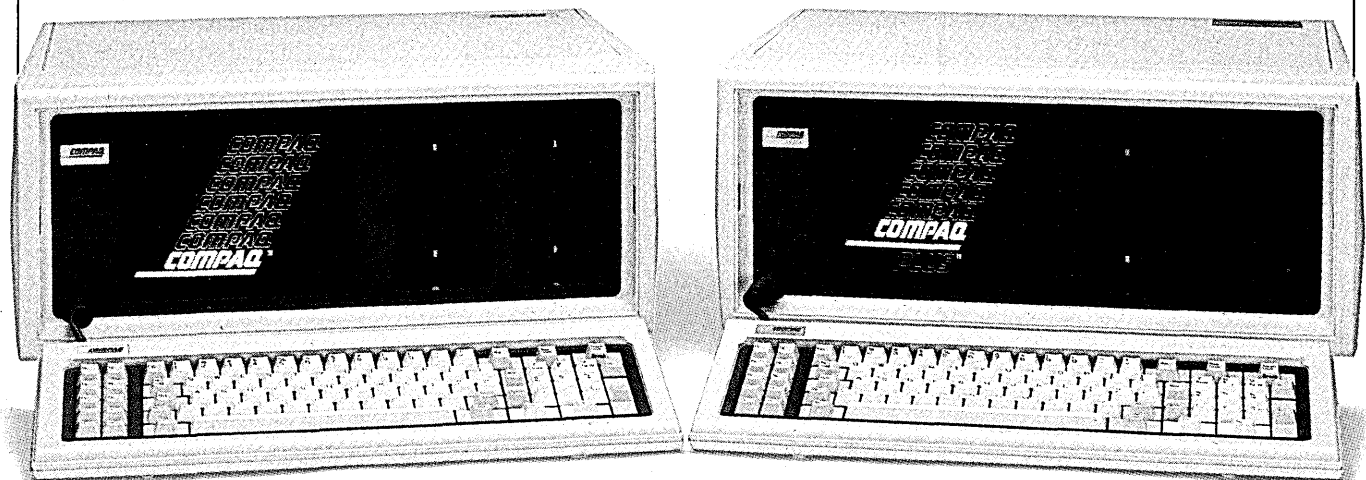

COMPAQ

PLUS™

VM

Software Inc.

**INFORMATION
CENTER?**

**DEVELOPMENT
CENTER?**

WE'VE GOT IT!

VM Software, Inc. has exactly the software products you need to be effective with VM from the start. . . As much or as little as you need. From the undisputed leader in VM products.

VMACCOUNT Provides collection, costing and reporting for the VM environment.

VMBACKUP Allows full or incremental dumps of both CMS and non CMS data, saving system programmer, support personnel, CPU, and tape resources.

VMTAPE Provides flexible control for managing tape volumes and drives, saving tapes and operator and librarian time.

VMARCHIVE Provides space management tool to end users, saving disk space and tapes.

VMSECURE Provides comprehensive security and directory management for the VM environment, ensuring data protection.

VMDEFER Permits users to schedule any event on any basis, facilitating load balancing of CPU.

VMLIB Allows users to share files without duplication, saving disk space.

Call Us
703/821-6886
or Write

Name _____

Title _____

Company _____

Address _____

City _____

State _____ Zip _____

Phone (_____) _____

CPU _____

VM Software Inc.
2070 Chain Bridge Road
Suite 355, Vienna, VA 22180

CIRCLE 8 ON READERCARD

Twenty Years Ago/Ten Years Ago

LOOKING BACK

PRAYER

December 1963: As the magazine went to press, President John F. Kennedy was fatally shot. News of the assassination traveled quickly, and many Americans feared we might be attacked in our weakened state, or even that panic within our own military could set missiles off.

The tension of the first hour following the shooting prompted Robert Patrick to write a special Editor's Readout, "Prayer of a Computer Specialist": "We who introduce the military to the developing technology fail sometimes to properly weigh the benefits of stability, training, and discipline. O Lord, bless them for their judgment when our peril was great. May your wisdom descend on us as we design our new systems for command and control; may we control the response and retain such judgment in our computer-based systems. . . ."

YOU CAN COUNT ON THEM

An inventory of dp equipment in the federal government showed 1,248 computers operating during fiscal 1963, with expenditures of \$705 million for personnel, hardware, and other costs. The Department of Defense soaked up 63% of that figure, with the Air Force getting \$179 million; the Army, \$133 million; and the Navy, \$94 million.

STRUCTURED GENESIS

December 1973: DATAMATION greeted the dawn of structured programming with five articles devoted to the new method that promised to bring a revolution in programmer productivity, and the project that brought it into the public eye.

IBM had taken on the task of designing the *New York Times's* vast information bank. The programming team developed over 83,000 lines of original high-level lan-

guage source code. The complete project took just 22 months, half the amount of time that normal programming techniques would have required.

The team working on this complex information retrieval system consisted of a few highly skilled programmers under the direction of a chief programmer. Two factors were deemed central to the success: a development support library, in which all programs under development were maintained by a programming secretary in a visible, standardized form; and the use of structured programming, which defined a top-down sequence for program unit creation and testing and a technical standard for the coding of each unit.

While it was not yet clear whether a single definition existed to describe structured programming, several threads seemed to run through all the discussions. A 1966 paper by C. Bohm and G. Jacopini proved that it was possible to write any program using only three structures:

1. Simple sequence: in the absence of instructions to the contrary, statements were executed in the order written.

2. IF-THEN-ELSE: combined with statement brackets (begin and end) so that groups of statements could be included in the THEN and ELSE clauses, which could then include any of the three structures recursively.

3. A loop control mechanism such as DO-WHILE or DO-UNTIL.

Using these three constructions, programs could be read from top to bottom without ever branching back to something earlier. It also eliminated the use, for the most part, of the GO TO statement. In this manner, programs became much easier to read and understand, produced fewer errors, and as a result, took a lot less time.

—Lauren D'Attilo

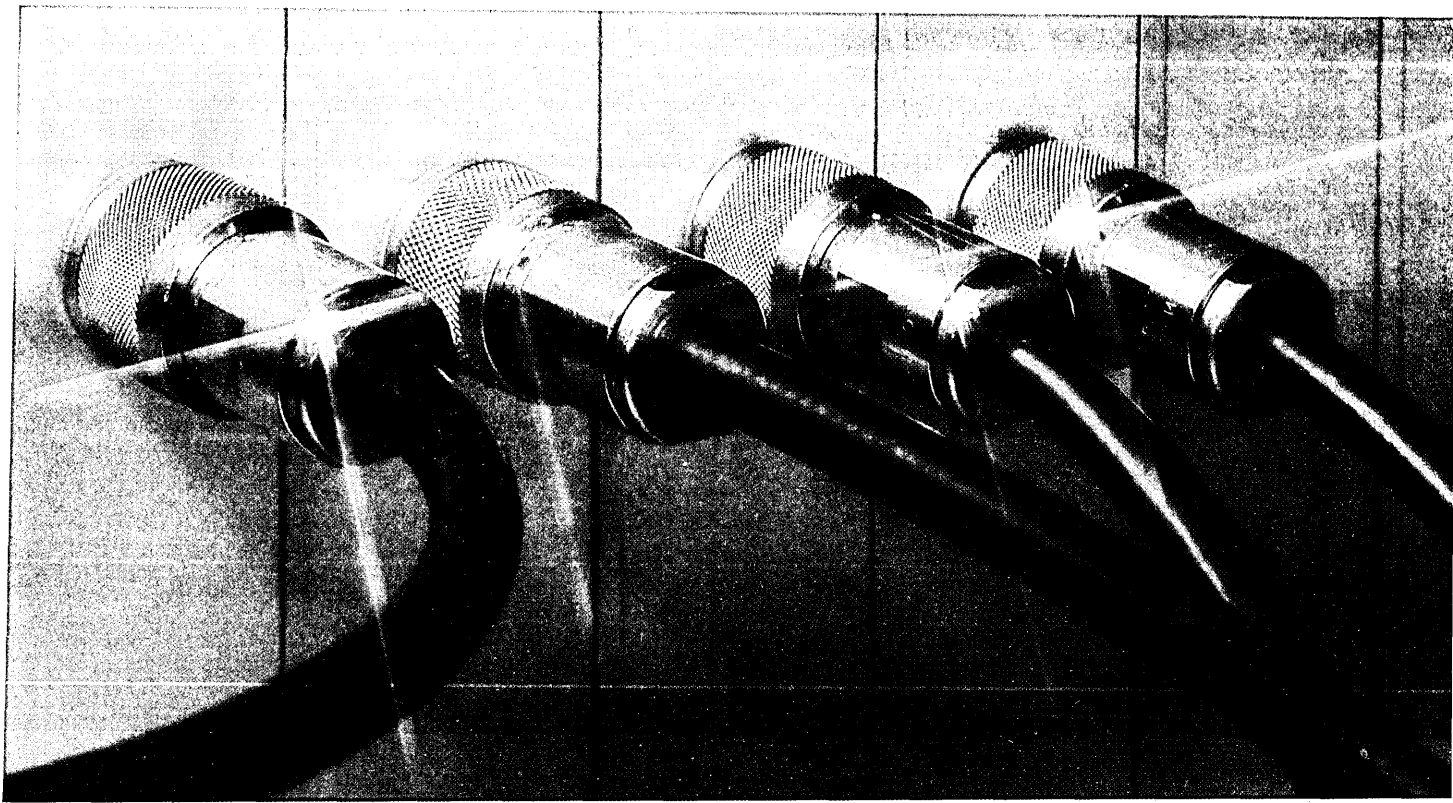

IBM MAKES THE SYSTEMS 34, 36 AND 38. WE MAKE THEM BETTER.

The Systems 34, 36 and 38 are very impressive IBM computers. But they're even more impressive when they're using Decision Data's compatible family of computer peripherals.

Take our work stations. With tiltable, non-glare screens that provide automatic dimming, cursor-position and error-message displays. Keyboards are movable and offer comfortable palm rests.

Or look at our printers. A 300 lpm matrix line printer with dual print heads and paper position adjustments. Or a band printer that operates at 700, 1100 or 1400 lpm, and which can be upgraded in the field. It is also a lot easier to operate.

Our cluster controller expands mainframe capabilities. It includes 4 ports, a single cluster feature, an EIA interface and an expansion feature which doubles the number of ports. All standard from us, all extra from IBM.

Decision Data is your primary source for computer

peripherals which enhance the productivity of your IBM computer system.

Decision Data equipment does more work, more quickly, more easily, for less money. And it's reliable — backed by nationwide and international service.

When people think of computers, they think of IBM. But when they think of the best family of peripherals, they come to Decision Data.

And that's a very smart Decision.



**Decision
Data
Computer
Corporation**

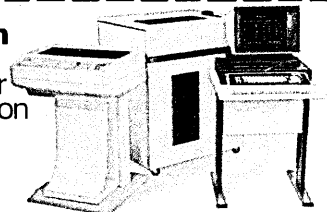

Box 3512
100 Witmer Road
Horsham, PA. 19044

- Tell me more about your productive peripherals.
- Work Stations Printers Cluster Controller.
- I want to know more now. I'll phone (800) 523-6529.
In PA call: (215) 674-3300.

Your Name _____
 Company _____ Telephone _____
 Address _____
 City _____ State _____ Zip _____

WE MAKE THE RIGHT DECISIONS

CIRCLE 9 ON READER CARD



PETROLIM LIFE Personal Loan Letter #

To: Robert W. Adams
18 Lovell Place
Concord, MA 03302

Dear Mr. Adams:

Enclosed you will find the contract we will
use to fund a loan to you under the company
program. We encourage you to read the contract
carefully. It contains all the terms of the
coverage it describes.

Remember that this loan has been a "flexible"
loan. The first policy we issue will have
coverage that has been lowered your cost.

In the event that you would like to
discuss the particulars of this policy, or
if you have any questions, please call for an appointment.

Honeywell

A network of Honeywell computers to improve customer service.

When Metropolitan says they stand by you—believe them.

One way to upgrade customer service is to do more to help the sales representatives responsible for that service.

So the Metropolitan Insurance Companies are installing over 1000 Honeywell DPS 6/40 small computers in their personal insurance offices throughout the U.S. and Canada.

By decentralizing computerized sales support functions, Metropolitan is giving its sales representatives instant access to data that once took days to get.

For instance, they can now obtain sales illustrations and price quotes and process service transactions just by going to a terminal.

The system also helps reps by maintaining their policyholder files and generating quality sales letters and timely reminders for client calls. What's more, Metropolitan's managers benefit by being able to measure sales against objectives

more easily. The system is a strong decision support tool. Indeed, its word processing, electronic mail, and other office automation capabilities will go a long way toward speeding operations and decreasing paperwork overall.

The Metropolitan Insurance Companies chose the DPS 6/40 for its reliability, expansion capability, ease of use, and the quality of support available from Honeywell. They also liked its combination of price/performance, local processing power, and communications.

Metropolitan has always been dedicated to the best possible customer service.

We think it's a wise policy.

For more information on how Honeywell computers can help solve your problems, call 800-328-5111, Ext. 2705. (In Minnesota, call collect, 612-870-2142, Ext. 2705) or write Honeywell Inquiry Center, MS 440, 200 Smith Street, Waltham, MA 02154.

Together, we can find the answers.

Honeywell

NEW
REALTIME ACCOUNTING CONTROL

NO OTHER GENERAL LEDGER MEASURES UP

We've just enhanced the industry standard, and we're confident it's the most advanced general ledger on the market.

Selective Realtime ability provides precise feedback from your general ledger. Immediately, Realtime maximizes the efficiency of your accounting operations.

Comprehensive system security and audit controls are built into the system to ensure data integrity. You control who can enter, review and make changes to your financial information. Audit trails allow you to trace the source of transactions.

Our Variable Report Writer lets you design, maintain and control every report that comes out of your system. The automatic building of reporting structures allows you to rapidly address your company's reporting requirements. An extensive standard format library eliminates the need to design basic financial reports. You can also use a common format across reporting entities. No other general ledger provides as much easy-to-use reporting power and online access to information.

With our powerful online inquiry ability, you can query your financial database at a summary or detail level to immediately trace the source of a variance or an account balance.

Our package design accommodates your chart of accounts, not vice versa. You can design any account num-

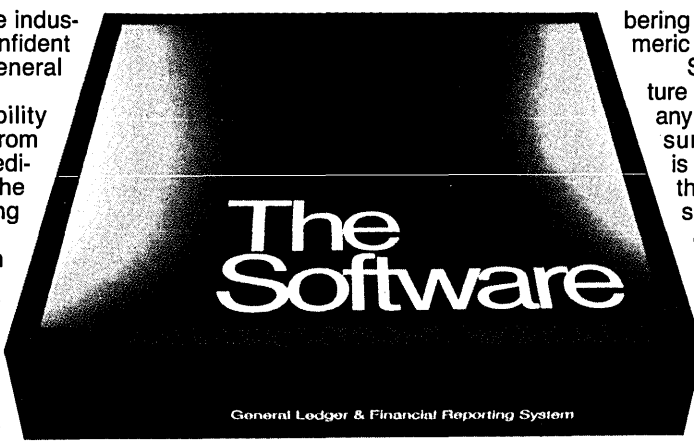

bering system, up to a 24 alphanumeric free-format account number.

Sophisticated system architecture provides benefits not found in any competitive product. Detail and summary financial information is as accurate and up-to-date as the last physical posting to the system. System design can automatically reflect corporate changes and reorganizations in company reports.

Software International has been installing and supporting high quality financial application packages for almost two decades. Currently, our General Ledger and Financial Reporting Sys-

tem is hard at work for more than 4,000 of the best run businesses in the world—firms like E.I. Dupont, R.J. Reynolds and Miller Brewing. Hundreds of Fortune 500 Companies have selected our General Ledger over the competition's. As a wholly-owned subsidiary of General Electric Information Services Company, we are part of a worldwide family of more than 5,000 computer and business professionals.

For more information, call us today. Or write our Corporate Headquarters at One Tech Drive, Andover, MA 01810. When you take a closer look, you'll see that no other general ledger measures up to ours. We're continually improving our product to stay at the leading edge of software technology, and to serve the changing needs of the business world.

After all, you don't remain the industry standard by standing still.

CONFIDENCE IN EVERY PACKAGE

CALL TOLL FREE 1-800-343-4133
(IN MASSACHUSETTS 1-800-322-0491)



**SOFTWARE
INTERNATIONAL**

CIRCLE 11 ON READER CARD

LOOK AHEAD

PBX FROM BURROUGHS?

Word has it that Burroughs is testing a Plessey digital private branch exchange, the IDX, for possible marketing in the U.S. The Detroit main-framer is currently without a PBX to offer its customers and the IDX would seem a logical choice as it is said to be largely compatible with IBM communications schemes. The machine was the focus of a suit brought against the British Plessey group by Rolm Corp., which claimed the hardware had been partially copied from Rolm engineering designs.

A TAXING ISSUE FOR IBM

The big question in the computer leasing business these days is whether or not IBM Credit Corp. (ICC) will make the \$350 million year-end goal it set for itself. And if it does, will it all really be good business for IBM? The economic upturn has put the squeeze on third-party lessors as they compete for the tax shelter business of companies and individuals whose incomes have been driven into higher brackets. According to "Computer & Communications Buyer," a New York City newsletter, the frenzy of tax shelter activity has made leasing cheaper for computer users but may hurt ICC's bottom line as it strives for market share.

IBM GOES AI

Not to be outdone by the rash of startups in the expert systems business (October), IBM has its own artificial intelligence project under way at the Yorktown Heights research lab. One of the small team's first goals is to build a real-time advisor for operators of large-scale MVS computers. The proposed system would help operators schedule jobs, perform maintenance tasks, and reconfigure peripherals. Also being worked on is an algebra system that would perform high-level mathematics for engineers, scientists, and mathematicians. The company emphasizes that the AI efforts are for research purposes only and do not represent product development.

TALES OF JUPITER

The effects of Digital Equipment's cancellation of its Jupiter project to develop follow-ons for the highly successful DECsystem series continue to be felt. DEC chief Kenneth Olsen was heard to say at the recent stockholders' meeting that users of the 36-bit machines love the TOPS operating system so much that DEC will "have to force them to leave it." The company is understood to have taken a seven-figure write-off on Jupiter and is now hoping to lure TOPS users to the aging VAX

LOOK AHEAD

MULTI-USER COBOL FOR PC/XT

line. One DEC watcher, Sonny Monosson, expects a healthy used-system market to develop as DECsystem users migrate. Monosson, however, also expects many users to move to IBM machines, which he thinks may satisfy timesharing needs better than do VAXs.

A Delray Beach, Fla., company has developed an ANSI COBOL software package that enables the sharing of applications between IBM Series/1 minicomputers and the IBM PC/XT. VM-86, as Advanced Software Products' \$1,000 package is called, provides multi-user capability on the XT as well as support for large, hard disk drives not supported under PC/DOS. The company has determined the XT's performance with VM-86 is roughly equal to a Series/1 4954 processor.

ADAPSO AND THE PIRATES

"How can we stop the Boy Scout troops from stealing and exchanging our software?" asks an official at ADAPSO, the software and services trade group. While it may not be able to take any merit badges away, the association is doing all it can to answer what the official says is "the question closest to our hearts." Among other things, ADAPSO has been lobbying the legal offices of large corporations to make employees aware of the illegality of ripping off office software packages for home use. It is also watching closely the outcome of efforts in the courts to crack down on video cassette recorders, and is monitoring the development of software protection devices.

MICROSOFT LOSES UNIX DEAL

Microsoft Corp., Bellevue, Wash., has apparently dropped the ball in porting Unix to Intel's 286 microprocessor. The job has been taken over by Digital Research, Pacific Grove, Calif., which is known for its CP/M operating system. Word has it that DR will develop the System 5 version of Unix for the 286, deriving the code from the version currently operating VAX minicomputers. The 286 is expected to surface in a large number of machines next year, the most notable of which is to be a Unix-based workstation from IBM that will fill the gap between the P.C. line and the System/36.

RUMORS AND RAW RANDOM DATA

Reports that IBM will finally introduce its Ocotillo tape drive, an 18-track machine designed to replace the aging 3420 line, have reached a crescendo lately. Industry observers, however, have been predicting the product's introduction regularly for the past three years....Look for Dun & Bradstreet Corp. to bring out a version of its Nomad DBMS for the new IBM XT/370.



C.I.TOH ELECTRONICS HAS SOME NEW IDEAS ABOUT DOING BUSINESS IN THE WORLD.

Worldwide business relationships, national growth, and a new, ever-changing marketplace requires a willingness to try something new. To bring the technology of marketing up to the technology of the 80's.

At C.Itoh Electronics, that means more than offering the latest product advancements. It means using the latest advertising and capital resources necessary to bring those products to the world.

That's why, from the very beginning, C.Itoh Electronics has consistently maintained a strategy of total involvement in the high technology and electronics markets. This includes a commitment to research and development, cross licensing and venture capital investing.

In addition to developing and marketing its own unique products, C.Itoh Electronics buys products from many international manufacturers and sells them through U.S. sales offices, sales representatives, distributors and OEM's. More than 10 Japanese manufacturers who market their products in the U.S. are currently represented.

C.Itoh Electronics also procures products from more than 30 U.S. based manufacturers and markets them worldwide, mainly to Japan, where these products are then distributed through C.Itoh's affiliate companies. C.Itoh Electronics is always searching for new products

to develop and bring to market.

No other company is better at bringing high technology to market. Perhaps, because in addition to exploring new ways of doing business, few other companies can draw on the experience and global resources of C.Itoh & Co., Ltd., our parent company. This multi-national organization has more than 125 years of business experience and thousands of employees linked through a worldwide network of 181 offices in 81 nations. These include 41 offices in Japan and 403 affiliated companies around the world — with annual sales exceeding \$10 billion.

It also means that when it comes to bringing high technology products to C.Itoh Electronics, and then to the

C.I.TOH ELECTRONICS

A World of Quality

CIRCLE 12 ON READER CARD



The new IBM Modem.
It stacks up as never before.

The new rack-mounted IBM 3868 Modem saves you space. And money. And effort.

Space, because IBM's new one-inch-wide vertical package allows you to mount up to 12 modems in one enclosure that fits a standard 19-inch rack.

Money, because each enclosure needs only one power supply and cooling system to support all of its modems.

And you manage your network with less effort because the IBM 3868 Modem has the same high availability and rock-steady reliability as other modems in the 386X Series—plus an enhanced Link Problem Determination Aid (LPDA).

Working with software available for many IBM host systems, the LPDA performs greater end-to-end management. Now line conditions are identified further downstream from the host, and in more detail. For example, conditions in any multi-point circuit can be pinpointed to a particular leg, including tailed configurations off multi-plexed links.

In fact, to help you keep your network humming, the LPDA and host software monitor and provide you with a line quality value, a receive signal level, an error-to-traffic ratio and modem self-test results to help you isolate line problems. Now you can more precisely communicate them to your communications carrier.

And because the 3868 Modem is so reliable, it's backed by a full three-year warranty.

Try them for up to four weeks: just select 2400, 4800 or 9600 bps line speeds. If you purchase in quantity, discounts are available.

To get your copy of a free brochure, or to arrange to have an IBM representative contact you, call toll-free, 1 800 IBM-2468, ext. 82. Call your IBM representative or return the coupon.

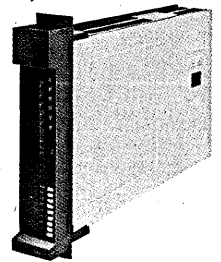

IBM	12-83
DRM, Dept. B0/82 400 Parson's Pond Drive Franklin Lakes, NJ 07417	
<input type="checkbox"/> Please have an IBM representative call me.	
<input type="checkbox"/> Please send me more information on the IBM Modem.	
Name _____	
Title _____	
Company _____	
Address _____	
City _____	State _____ Zip _____
Phone _____	

CALENDAR

DECEMBER

CMG XIV, International Conference on Computer Performance Evaluation.

Dec. 6-9, Crystal City, Va., contact: Computer Measurement Group, P.O. Box 26063, Phoenix, AZ 85068, (602) 995-0905.

Conference on Personal and Small Computers.

Dec. 8-9, San Diego, Calif., contact: Billy G. Claybrook, Publicity Chairman, The MITRE Corp., MS B332, P.O. Box 208, Bedford, MA 01730, (617) 271-2439.

JANUARY

Seventeenth Hawaii International Conference on System Sciences.

Jan. 4-6, Honolulu, Hawaii, contact: Emily M. Yano Jorgensen, Center for Executive Development, College of Business Administration, University of Hawaii, 2404 Maile Way C-202, Honolulu, HI 96822, (808) 948-7396.

6th Annual Pacific Telecommunications Conference.

Jan. 8-11, Honolulu, Hawaii, contact: Fred Smith, Pacific Telecommunications Council, 1110 University Ave., Suite 303, Honolulu, HI 96826, (808) 949-5752.

Southcon/84.

Jan. 17-19, Orlando, Fla., contact: Nancy Hogan, Electronic Conventions Inc., 8110 Airport Blvd., Los Angeles, CA 90045, (213) 772-2965.

Sixth Annual Advanced Semiconductor Equipment Exposition (ASEE '84).

Jan. 24-26, San Jose, Calif., contact: Joyce Estill, Carlidge & Associates Inc., 4030 Moorpark Ave., Suite 205, San Jose, CA 95117, (408) 554-6644.

Communication Networks 1984.

Jan. 30-Feb. 2, Washington, D.C., contact: Louise Myerow, Registration Manager, CN '84, Box 880, Framingham, MA 01701, (617) 879-0700 or (800) 225-4698.

FEBRUARY

1984 Office Automation Conference (OAC '84).

Feb. 20-22, Los Angeles, Calif., contact: Ann-Marie Bartels, American Federation of Information Processing Societies (AFIPS), 1899 Preston White Dr., Reston, VA 22091, (703) 558-3613.

IMPRINTA 84 (International Congress and Exhibition for Communications and Techniques).

Feb. 22-28, Dusseldorf, West Germany, contact: Dusseldorf Trade Shows, 500 Fifth Ave., New York, NY 10110, (212) 840-7744.

MICAD '84.

Feb. 27-March 2, Paris, France, contact: World Computer Graphics Association Inc., 2033 M Street N.W., Suite 399, Washington, DC 20036, (202) 775-9556.

The Hong Kong Personal Business Computer Show.

Feb. 29-March 3, Hong Kong, China, contact: Overseas Exhibition Services Ltd., 11 Manchester Square, London W1M 5AB, England, (01) 486-1951.

MARCH

SaudiComputer 84.

March 18-22, Riyadh, Saudi Arabia, contact: Overseas Exhibition Services Ltd., 11 Manchester Square, London W1M 5AB, England, (01) 486-1951.

Federal Office Systems Expo (FOSE '84).

March 19-22, Washington, D.C., contact: Mary Beth Gouled, National Trade Productions Inc., 9418 Annapolis Rd., Lanham, MD 20706, (301) 459-8383 or (800) 638-8510.

International Symposium on the Performance of Computer Communication Systems.

March 21-23, Zurich, Switzerland, contact: Harry Rudin, IBM Research Laboratory, Saumerstrasse 4, CH-8803 Ruschlikon, Switzerland, (01) 724-2727.

APRIL

Hannover Fair.

April 4-11, Hannover, West Germany, contact: Hannover Fairs Information Center, P.O. Box 338, Route 22 East, Whitehouse, NJ 08888, (201) 534-9044 or (800) 526-5978.

Videotex '84.

April 16-18, Chicago, Ill., contact: London Online Inc., Suite 3314, 1133 Avenue of the Americas, New York, NY 10036, (212) 398-1177.

AUTOFACT Japan Conference & Exhibition.

April 25-27, Kobe, Japan, contact: Public Relations Department, Society of Manufacturing Engineers, One SME Drive, P.O. Box 930, Dearborn, MI 48128, (313) 271-1500.

What to look for in a word processing printer. And what to look out for.

First of all, look for a daisywheel printer. Daisywheels produce crisp, sharp characters that readers can't tell from the finest office typewriter.

They're the best choice for printing letters, proposals, contracts and other important documents that call for a professional look.

We make the DP-55 and DP-35 daisywheels, which print at 55 and 35 characters per second (CPS).

Rule of thumb: Faster is better.

Our DP-55 will print a one-page letter in about a minute. A 12 CPS machine takes five.

You may be happy to wait five minutes for your letter. But remember, while the computer is tied up running the printer, it may not be available for other jobs.

Bad design can make a smart operator look dumb.

People with otherwise normal dexterity sometimes become all thumbs around a computer printer. The fault is usually the machine's.

Our DP-Series printers were designed with the operator in mind. A status display is standard on the DP-55. The printhead mechanism tilts a full 90° to make print-wheel changes a snap.

Industry standard ribbons and plastic or metal printwheels are available from Dataproducts or local office supply stores. More than a hundred

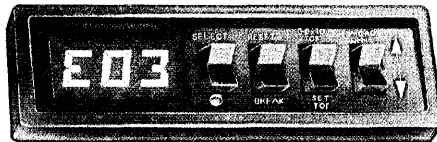

type styles are available, so you can match most any office typewriter.

A printer's no better than the technology behind it.

Some companies are pushing the limits of their technical knowhow and offer little more than souped up typewriters. Dataproducts has decades of experience in the design and manufacture of sophisticated, high-speed computer printers.

Our daisywheel printers are serious business machines, engineered to perform reliably for years and years. And to provide their users the greatest productivity at the lowest cost of ownership.

Depend on the world leader.

Virtually every major computer manufacturer buys printers from Dataproducts, then resells them with their name on them. For them, Dataproducts is synonymous with

quality and reliability.

It's that reputation that made us the largest independent manufacturer of computer printers in the world.

To learn more about Dataproducts DP-55 and DP-35, or for the name of our distributor in your area, call (213) 887-3924. Or send the coupon below.

Look for Dataproducts printers.



Dataproducts Corporation,
6200 Canoga Ave., Woodland Hills, CA 91365

- Send details on Dataproducts' daisywheels.
- I'm shopping for printers now. Send a rep.

Name _____
 Title _____
 Company _____
 Type of business _____
 No. of printers needed _____
 Address _____
 City _____ State _____ Zip _____
 Telephone _____ Ext _____

Send information on: 120-200 LPM matrix printers
 300-1100 LPM band printers 1500-2000 LPM high performance printers Dot matrix graphics and label printers Printer supplies

Dataproducts is a registered trademark. DP-55 and DP-35 are trademarks of Dataproducts Corporation. 12/83-D

DATAPRODUCTS

The Printer Company



Personal Computers have opened up all kinds of possibilities throughout your company. Including some you'd rather not think about. Somehow a balance must be struck between the performance PCs offer, and the control you have to have in a local area network to make sense of the whole system. Somehow, costs, information and information processing resources have to be managed.

**INTRODUCING THE NET/ONE®
PERSONAL CONNECTION. IT'S SMART,
FAST, AND SNA-COMPATIBLE.**

The Net/One Personal Connection™ hardware is a high performance, 10 megabit-per-second, Ethernet-compatible Network Interface Unit (NIU®) in a plug-in board for IBM® Personal Computers. It packs enough microprocessing power on a single 5.25-inch board to offload all networking functions, so it doesn't consume any of the host CPU's resources.

With Net/One SNA Server software, a PC can emulate a 3278, and get a direct SNA route to the top. So the Personal Connection is a far-sighted solution when PCs need to share information and peripherals. And it's the *only* solution when PCs need to be mixed cost effectively into a high-speed corporate network with information processing devices from different manufacturers.

The Personal Connection can do it, because it's the *Net/One* Personal Connection. That means it not only does the job from PC-to-PC, it's the newest extension of Net/One, the general purpose local area network system that can turn *all* the equipment you have now, no matter who makes it, into a fully functional, high performance network. A Big Picture network. Broadband, baseband, fiber optics. Mainframe to mini to micro. Local to remote.

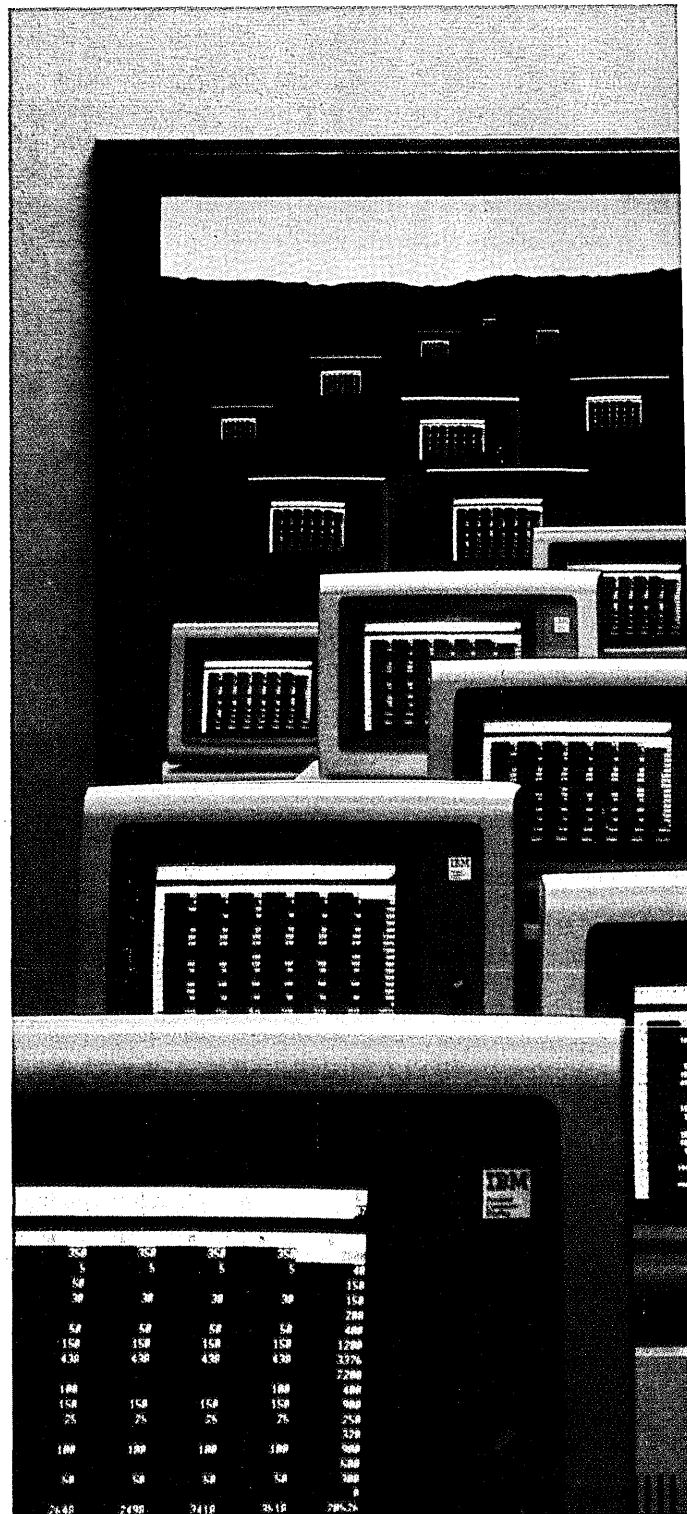

Now PCs can get into without getting



**IT'S POWERFUL ENOUGH TO
PERFORM IN HEAVY TRAFFIC.**

The Personal Connection is impressive even if all you need to do now is hook up a few PCs. Our Diskshare™ software lets one PC act as a disk server and still function fully as a PC. A Printshare™ program lets a number of PCs share a printer effectively. Because the Personal Connection offloads networking functions completely, you're getting every ounce of performance from every machine as well as maximum network performance.

When you connect more than just a few PCs, or a few hundred, the Personal Connection's on-board intelligence and 10 Mbps transmission speed are more than impressive. They're critical.

The ability to handle heavy traffic, fast, and to fully integrate PCs into your corporate network—now, or later—gives you both the high performance and the manageability you need, no matter how many PCs come in the door. You get the shared access, fast response, and easy, transparent operation you're looking for. And you get better management of file storage, applications software, and costs.

**HOW MUCH WOULD YOU PAY FOR
A BOARD THAT DID ALL THAT?**

The Net/One Personal Connection board (Personal NIU™) and operating software are \$850. Surprised?

If you're looking to harness PCs to a high performance network, or trying to solve networking problems of any kind, give us a call.

Ungermann-Bass, Inc., 2560 Mission College Boulevard, Santa Clara, California 95050. Telephone (408) 496-0111.

Net/One from Ungermann-Bass 

the corporate network out of control.

CIRCLE 15 ON READER CARD

A PRINTER FOR EVERY NEED AND EVERY SPEED.

If you're looking for a dependable lineup of printers, look at Printronix. We've got it all in the family.

From Word Processing at 80 LPM, Graphics at 150 LPM, to high-volume Data Printing at 2000 LPM, Printronix printers do it all, without skipping a

beat. In fact, they're the only printers built to take the pressure of continuous duty processing in the most rigorous environments.

And, in addition to industrial durability, our unique hammerbank technologies give you superior

print quality and outstanding graphics capability.

For printers for every need and every speed, come to Printronix. The best printer line for your bottom line.

For more information, please write or call today.

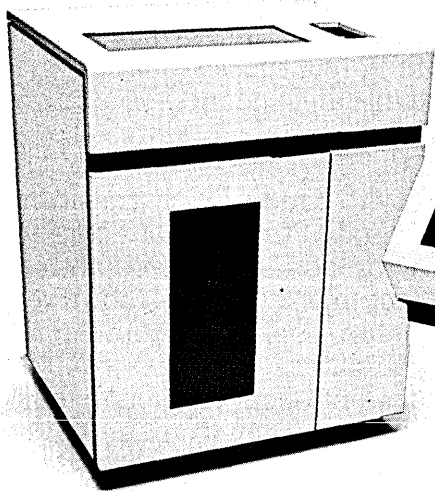

P-Series

The P-Series consists of our proven printer/plotters, the P300 and P600. At 300 LPM, the P300 can combine bar codes, OCR and alphanumerics all in one dependable package to bring you the best in medium-speed line printer capabilities.

And, with twice the throughput of our P300, the extra-rugged P600 is truly an industrial printer, designed for all your heavy-duty processing tasks.

Plus, there's our new P-Series XQ. Enhanced versions of our P300 and P600, delivering high-speed draft print and compressed print in an office-quiet cabinet.



DataPrinter

Our DataPrinter series gives you the most reliable band printer performance available, using a precision hammer actuator system evolved from chain printer technology.

DataPrinter's fully-formed character bands offer superior print quality for your super-mini and mainframe data processing needs, at speeds from 600 LPM to a blistering 2000 LPM.

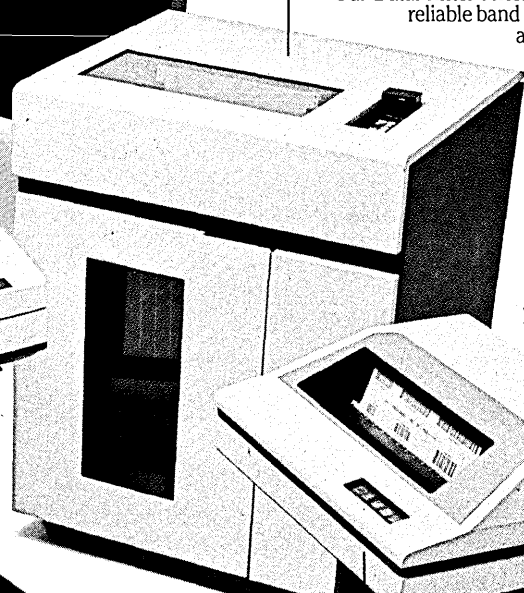

MVP

Our MVP is the business printer that really means business. It's the world's first and only microcomputer line printer which puts the dependability of our P-Series into a smaller package.

The MVP is truly the Most Versatile Printer, with selectable speeds ranging from 80 LPM to 200 LPM, and full graphics capability. It's the perfect printer for all your multi-user, multi-application needs.

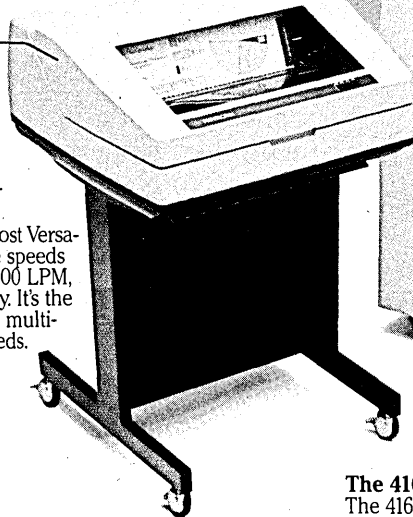

The 4160 GraphicPrinter

The 4160 GraphicPrinter combines the reliability and versatility of Printronix technology with higher dot density. Perfect for applications requiring high resolution graphics.

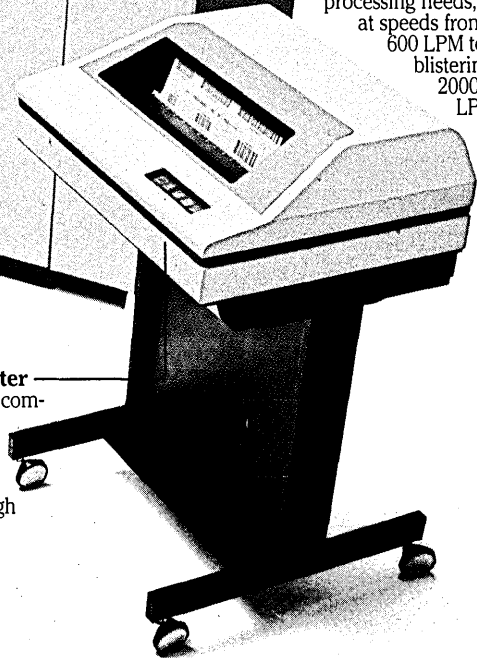

THE FIRST LINE IN PRINTERS.
PRINTRONIX

17500 Cartwright Road
P.O. Box 19559, Irvine, CA 92713
714/863-1900 TWX: 910-595-2535
Outside California: 800-556-1234, ext. 66
In California, 800-441-2345, ext. 66

LETTERS

DOWNER WIT

I enjoyed the bit of Downer wit appearing in DATAMATION.* It proved to me that one's loyalty** can defy rationalization!

PETER KUSHKOWSKI
Manager, Process Computer Engineering
Northeast Utilities
Hartford, Connecticut

*Letters, August, p. 23, "Jersey Raises a Stink" from Whit Downer.

**Secaucus *notwithstanding*!!!!?

Your "Jersey Raises a Stink" response to my "manhattan tastes like New Jersey" letter is a classic, and I don't think I'll cross verbal swords with you again. But the air is sweeter down here in Ocean County!

WHIT DOWNER
Manager, Communications
Electronic Associates Inc.
West Long Branch, New Jersey

INFO CENTERS, INDEED

Being involved in the development of an academic computing information center, I am interested in reading articles such as the one you presented on "The New Info Centers" (July, p. 30). What I think is unfortunate is that the lead-in to your article was neither appropriate nor accurate, to wit, your statement that "walk-in offices for advice on which micro to buy are springing up in companies across the country." While micros are certainly a component of a center, as indicated in your article, the mandate of such a center is to do *much more* than give advice on purchasing micros.

JOHN JOHNSTON
Manager, Academic Computing
Ryerson Polytechnical Institute
Toronto, Ontario, Canada

STANDARD SQUABBLE

The article by William Stallings titled "Beyond Local Networks" (August, p. 166) states that "public access networks, such as Telenet and Tymnet, do not accommodate X.75 links to private networks." Tymnet

does in fact support X.75 and has done so since 1981, but only to connect international public packet networks, since the CCITT has defined X.75 as a public network interconnect protocol.

Tymnet is in compliance with the CCITT X.75 recommendation. The X.75 interface has been enhanced to produce compatible interfaces to the network services of all major public packet switched networks including Datapac, Telenet, KDD Venus network, the British Telecom IPSS service, Telepac, Italcable, Austpac, and Transpac. It is widely used by the international record carriers including RCA, ITT, WUI, TRT, FTCC, OTC, and Teleglobe.

Private networks can be attached to Tymnet via X.25. The only problem with the X.25 attachment is that there is no standard for addressing entities within the private network. CCITT Study Group VII is working on a recommendation for subaddressing in private networks to be included in a revised X.121 standard. There are several different numbering plans vying for approval. Tymnet will support whatever the CCITT recommends on this issue. In addition, the U.S. ANSII Task Groups X3S3.3 and X3S3.7, on which Tymnet is represented, have provided much input to Study Group VII.

The Tymnet X.25 and X.75 interfaces provide access to the packet switching data transmission services of Tymnet and are compatible with recognized international standards. The same interface implementation and procedures may be used to access both private networks and independent public networks that are based on Tymnet technology. The CCITT adopted both X.25 and X.75 as international recommendations in 1976. Since then, the protocols have undergone several changes, the latest of which were approved in November 1980. Tymnet recognizes that it is not possible for all customers to update to the latest version of the standard. To meet all customer and vendor needs and requirements, Tymnet has provided several options that allow for earlier version of the standards. This allows each interface to be totally customized.

JANIS BESSLING
Manager, Sales Support
Private Network Systems
Tymnet Inc.
San Jose, California

A THANK YOU NOTE

I read with great interest the remarks by Michael E. D. Koenig about "Librarians: The Untapped Resource" (September, Readers' Forum, p. 243). You are to be



"Justice may be blind, but she has very sophisticated listening devices!"

LETTERS

commended for recognizing the great resources we do have in professional librarians and the skills and expertise they can bring to bear on present day information needs. You have done this without hauling out of the closet the tired clichés and stereotypes of librarians, and have focused on the positive in an original and enlightening manner.

CARL F. OLDSSEN
Research Specialist
Ohio State University
Columbus, Ohio

AT&T BALKS AT BLOCKING

We at AT&T Information Systems (formerly called American Bell) appreciated being included in the article entitled "Voice/Data PBX Survey" (August, p. 155). Unfortunately, in the table comparing the voice/data switches from 17 vendors on pp. 156 and 157, eight of the 22 entries for American Bell's Dimension System 85 were incorrect. The correct entries are listed in the table below.

In addition, the sidebar on p. 160 titled "Nonblocking Architecture," by Robert L. Patrick, incorrectly portrayed System 85 as a blocking switch. System 85 can be configured to be fully nonblocking (i.e., zero calls blocked) up to about 4,000 lines. However, we believe that most customers can be adequately served by an "essentially nonblocking" (i.e., one blocked call per million attempts) configuration, which costs approximately 20% less than a fully nonblocking configuration.

R. MAGNANI
Product Manager, Dimension System 85
AT&T Information Systems
Morristown, New Jersey

Our information indicates that the Dimension System 85, as announced in January, was small capacity and blocked because it ran out of time slots. This past July (after the deadline for our article), the company announced an upgrade for that system that reduced the probability of blocking and held out a carrot for a further upgrade that would eliminate the possibility of blocking. Both of these promised upgrades are scheduled for first customer ship in 1984. In announcing the improvements, the company inadvertently admitted that the original device did indeed block.—Ed.

COKE IS APL-FREE

Your article, "A New Dawn for APL," by Claiborne Lange (September, p. 129), is one that caught my eye. The second paragraph provides as examples of the "loyal following" of APL users such as Exxon and Coca-Cola.

I think a correction is needed. I worked for Coca-Cola when APL was installed on our in-house system. At that time, we had two users of outside APL services. APL was operational on our in-house computer for over two years with almost no activity. Because of the lack of interest, it was finally canceled and sent back to IBM.

What I saw at Coke is typical of what I have seen in other companies offering APL. There is a very small group of extremely dedicated users, but the average terminal user prefers the services of TSO or VM. I have tried to teach APL, only to find users turned off by the unfamiliar Greek characters. That seems to be the biggest stumbling block to converting people from more traditional languages.

STEVE YATES
Vice President, Information Systems
Pool Company
Houston, Texas

IN THE YEAR 1815 . . .

Thanks for the story on Ada (September, p. 114). I especially enjoyed two sentences right near each other on p. 116: "Ada Lovelace (1818-1851) was a mathematician . . ." and "The military standard specification (MIL-STD 1815) was chosen to reflect the year of her birth."

Happy birthday, Ada, whenever it was!

WILLIAM B. LURIE
Consultant
Delray Beach, Florida

DOING WHAT'S NOT FEASIBLE

The inside story of the development of IMS (September, p. 158) was very interesting reading. Having worked in several different database environments myself, I was particularly interested in William Grafton's comments about the usefulness of IMS in the practical business world.

I would like to point out, however, that the integrated database approach that Grafton says is "not feasible with current technology" is an accomplished fact in our

company. We have implemented MAN FACT II, a real-time manufacturing system fully integrated with INFORMATION, a dictionary-oriented relational database, on a Prime superminicomputer. Using a project team led by our plant manager, we converted from an IBM 4331 in about nine months with no major milestone slipping more than three weeks. During the conversion, and because of the recessionary business conditions of the time, we reduced the MIS expense budget by over 50% and the MIS staff by 80%.

Our software (from COMPUFACT of Santa Ana, Calif.) integrates sales history, order entry, closed loop MRP, payroll, and a full complement of financial applications. Within this application environment, our company is a successful example of end-user computing with Prime's INFORM query and report writing capability. After two hours of classroom instruction and two hours at a terminal, our users now have the capability to access our complete production database. Communications have improved significantly among our operating staff, because users share accurate, up-to-date information, and our management now has access to information that was previously unavailable. System availability is extremely high, with less than five hours of downtime for the past year!

I believe that an environment close to that envisioned years ago is available today with the combination of reliable, integrated software packages, relational databases, and end-user tools. Based on our experience, manufacturing companies that are willing to leave the IBM world could install this type of system for well under \$250,000. Can you imagine the expense to duplicate this degree of integration with IMS?

DAVID L. MAYES
Manager,
Management Information Services
Heatilator Inc.
Mt. Pleasant, Iowa

SETTING THE RECORD STRAIGHT

In your Look Ahead column (August, p. 13), you state that a "joint venture" has been formed between Productivity International Inc. of Dallas and Set Theoretic Information Systems Inc. of Ann Arbor to build a new back-end database machine. The fact is, Productivity International Inc. is an independent engineering services company that specializes in turnkey factory automation systems design and installation, and has not formed a joint venture with anyone. The organization from Dallas that is involved is PDC Venture Group I Inc. Please set the record straight as it is important that we guard our status as an independent systems integrator.

JOHN J. ALLAN III
President
Productivity International Inc.
Dallas, Texas

FEATURE	PRINTED IN DATAMATION	CORRECT ENTRY
Av. Voice/Data Lines Installed	N/A	350
Av. \$Cost per Voice Line	250-400/mo.	700 (purchase)
Av. \$Cost per Voice/Data Line	300-500/mo.	950 (with 10% data)
Redundancy	no	yes
Digitized Voice Handset	no	yes
Synchronous Data Speed	—	19.2 Kbps
Protocol Converters Available	no	yes
Wiring Trace Software	no	yes

**NEW
From PARADYNE**



Can you print 300 pages of data at
your Remote site..In 5 minutes?

Yes, Paradyne's **NEW 8360 Remote Page Printer** Prints as fast as a Page a Second. Paradyne introduces high speed, non-impact remote printing — from one location to any other — at speeds up to 60 pages a minute, depending on line speed and data density.

No Host Remote Teleprocessing Software is Required. Communications requirements are handled through PIXNET®, Paradyne's communication system, and the page printer will operate without any changes to your existing applications programs.

With the 8360 your remote operators have the same functional capabilities as the data center operator. And the 8360 has the same capabilities as the system printer in your computer room.



Uses Standard 8½" x 11" copy paper.

Compact in Size, Highly Reliable and Easy to Use. The 8360 is easy to install and it runs cool — all day long. You'll have a high quality printer designed to blend into your office environment with an operation that's so quiet your operator may have to check to see if it's finished printing.

A Price Breakthrough. Now, Paradyne offers your remotely located offices and plants the convenience of high quality, high speed printing...at a price that's a breakthrough in the industry. **Call 1-800-482-3333** and we'll tell you why. Plus, we'll give you the location of the Paradyne sales office nearest to you.

*Meeting the
Communications
Challenge of
the 80's*

paradyne

Paradyne Corporation P.O. Box 1347
8550 Ulmerton Road, Largo, FL 33540

CIRCLE 17 ON READER CARD

You've got a PC. Now where do you put it?



On a MicroMaster, from Inmac. It eliminates the tangled mess of cables and printout permanently. MicroMaster manages them so your work area stays neatly organized. It's also genuinely portable — with a standard 26½" keying height on sturdy ball-bearing wheels. Best of all, it can be shipped within 24 hours, from the nearest of eight convenient Inmac outlets nationwide. Lifetime warranty, risk-free 45-day trial. \$349, base unit, accessories optional. Call toll-free and order a MicroMaster today.

(800) 547-5444.
In Calif. (800) 547-5447.



Inmac Catalog Dept.
2465 Augustine Drive
Santa Clara, CA 95051
Please be sure to indicate your phone number.

Name _____
Company _____
Address _____
City/State/Zip _____
Phone () _____

15115

Send today for your free 100-page
Inmac catalog.

CIRCLE 6 ON READER CARD

VSAM SPACE MANAGER

VSM
is the
NEWEST

in the family of VSAM
Products from Softworks.
To introduce you to VSM,
we are making a LIMITED OFFER.....

**TEST VSM FOR 30 DAYS
AT NO COST - NO OBLIGATION**

VSM provides OS/VS VSAM users with a means to accommodate nonspecific volume allocation of VSAM space by eliminating the vexing requirement of identifying specific volumes by volume serial number when allocating VSAM space to clusters by means of the IDCAMS DEFINE CLUSTER command. It also provides the availability to "place" (by absolute tracks) heavily accessed VSAM datasets and catalogs for efficient arm movement on a volume. Another feature addresses potential problems associated with integrated Catalog Facility (ICF) environments where the removal of volume ownership by catalogs has opened a "Pandora's Box" in the recovery area.

SOFTWORKS, INC.

Consultants in data processing — specialists in software development

7801 Old Branch Avenue • Clinton, MD 20735 • (301) 868-4221

CIRCLE 7 ON READER CARD

LETTERS

TOO GOOD TO BE TRUE

Your article titled "The OPM Scandal Unmasked" (September, In Focus, p. 34) was interesting reading. I think you missed a good way to summarize the situation, however. If it feels, reads, or smells too good to be true, it probably is.

ED HEINLEIN
Heinlein Associates Inc.
San Rafael, California

FOOLS FOREVER

I was totally amazed to read your inside magazine entitled *Digital Tattler* and dated April 1, 1983 (April, p. 150). At last something refreshing, funny, and subtle appears in your otherwise cold and all-too-serious publication. My only regret is that *Digital Tattler* appears only on April Fool's Day. But then, my hope is for a monthly Fool's Day to come. A copy of DATAMATION costs \$4, but *Digital Tattler* is priceless!

ANDRÉ DELISLE
Aylmer, Quebec
Canada

TALKING FURNITURE HOAX

My compliments on a brilliant exposé of "The OA Hoax" (September, Readers' Forum, p. 246). Perhaps with the elimination of offices, as Alan Krigman suggests, we'll see an end to those annoying memos people get from furniture—"From the desk of. . . ."

PETER KUSHKOWSKI
Manager, Process Computer Engineering
Northeast Utilities
Hartford, Connecticut

HOLD THE PHONE!

A recent Readers' Forum (October, p. 322) included an article called "The Amazing E. G. Ratigan." It was a bogus resumé for a fictitious character but, as it turns out, one part of our piece was real: the toll-free phone number, which belongs to the Hertz Penske Truck Leasing company in St. Louis. Since release of the October issue, Hertz Penske has been receiving phone calls nonstop from jesting DATAMATION readers who are trying to track down our man Ratigan. Apart from the nuisance factor, these phone calls are costing the St. Louis company actual dollars. We urge you to stop the search for Ratigan so that Hertz can keep on truckin'. We offer our sincere apologies to Hertz Penske for this blunder. —Ed.

MISCONCEPTION

The People profile on Lynn Conway (October, p. 263) did not make clear the fact that the "exclusive interview" mentioned was indeed exclusive to the *Palo Alto Weekly* newspaper and not to DATAMATION. Author Michael Doyle supplied us with an adapted version of that earlier interview granted to his California publication. —Ed.

ZEBRA™ RUNS CIRCLES AROUND EVERY COMPUTER IN ITS CLASS.

Zebra™ is the fastest, most powerful multi-user microcomputer system in its class.

Zebbras are friendly too. Because they utilize the PICK™ Operating System. And with ACCESS™ the system's information management and retrieval language, Zebra speaks English. Just like you do. So everyone from a secretary to top management can use it. Without hours of tedious training. Zebra comes complete with software packages for word processing, graphics and financial spreadsheets.

Zebra also speaks to other computers in your company. It can communicate system to system through its local area network. Or talk with other Zebbras in the field through a simple telephone connection.

Zebbras also support most industry standard communications protocols giving Zebra

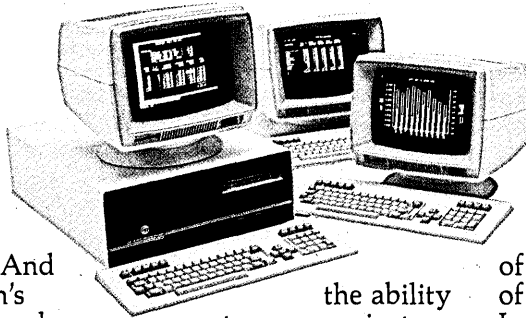

the ability to communicate with major mainframes and minicomputers. Zebra also runs the XENIX™ Operating System so it adapts to an infinite variety of commercial, engineering and scientific tasks.

The MC68000® microprocessor gives Zebra the power to handle dozens of tasks simultaneously. Every Zebra has a unique modular design that allows it to grow as your business grows. Your Zebra can

expand from a single user desktop system, to networked and clustered configurations capable of serving hundreds of users.

Zebra follows in the tracks of over 30,000 satisfied users of GA computers worldwide. In the U.S., service for Zebra is available through SORBUS®, the number one rated service organization in the country.

Find out how Zebra can set a faster pace in your company. Call or write now to GA corporate headquarters. GA, 1045 South East St., P.O. Box 4883, Anaheim, CA 92803, (714) 778-4800, Toll-free 1-800-556-1234, Ext. 41. In California, 1-800-441-2345, Ext. 41.

© 1983 by General Automation, Inc. Zebra is a trademark of General Automation, Inc. PICK is a trademark of PICK SYSTEMS. ACCESS is a trademark of PICK SYSTEMS. XENIX is a trademark of Microsoft, Inc. MC68000 is a registered trademark of Motorola, Inc. SORBUS is a registered trademark of Management Assistance Inc.

ZEBRA BY GA



FOR MORE INFORMATION CIRCLE 18 (ENDUSER)

FOR MORE INFORMATION CIRCLE 19 (RESELLER)

Don't waste your money on modems for local networking.

Whether you're connecting your terminal or personal computer directly to a nearby minicomputer or to a data PABX-based local network, you probably don't need a modem at all.

MICOM's inexpensive Micro400 line drivers and local datasets can substitute for regular modems over distances of several miles and at full-duplex data rates up to 19,200 bps. Then, because they're asynchronous devices, they can allow you to operate at any speed within their total range

(rather than limiting you to one or two data rates as a synchronous device would). And— even better— they're priced at a tiny fraction of the cost of a high-speed modem.

Also unlike conventional modems, MICOM's tiny Models 430 and 431 require no extra cabling— not even a power cord. They simply plug into the back of your terminal or PC.

Looking for a better way to transmit data over your own lines or over metallic circuits supplied by the phone company? Call or send for information on MICOM's Micro400s.

Considering
a bunch of *modems*
for local networking?

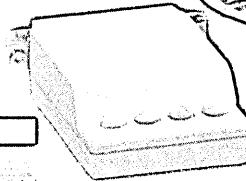
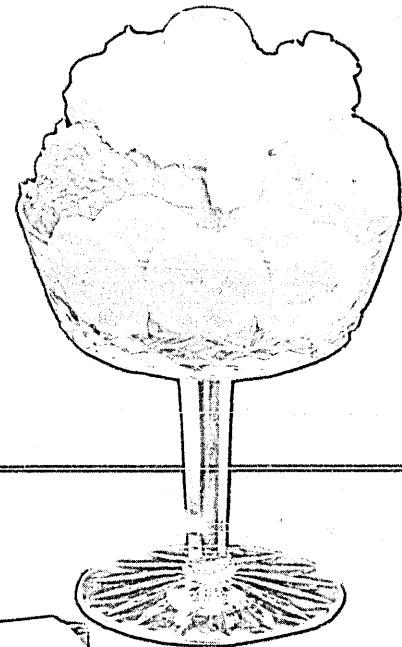
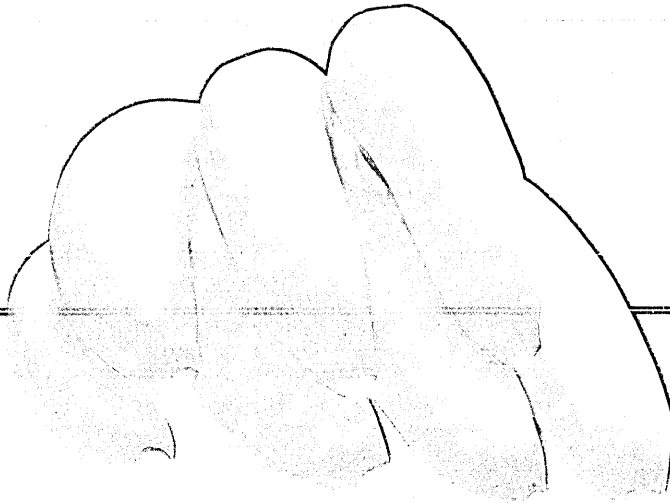

You'll find
our *local datasets*
more appealing.

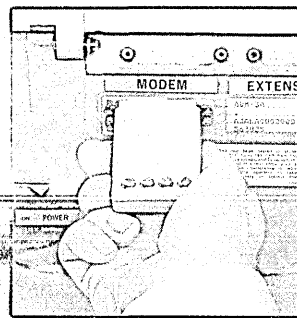

MICOM® *MicroComputers for Data Communications™*

MICOM SYSTEMS, Inc. • 20151 Nordhoff Street • Chatsworth, CA 91311 • Telephone (213) 998-8844 • TWX 910/494-4910
Regional Sales/Service • Atlanta, GA • (404) 485-2999 • Boston, MA • (617) 527-4010 • Chicago, IL • (312) 789-2430
Dallas, TX • (214) 253-0774 • St. Louis, MO • (314) 576-7626 • Teaneck, NJ • (201) 836-4000
MICOM BOREAL Ltd. • Belle Court • 15 Cradock Road • Reading, Berkshire RG2 0UR, England • (0734) 866804 • Telex 847435

Available now from these stocking reps...

AK: Anchorage (907) 561-1778 / Juneau (907) 789-4101 • AL: (800) 327-6600 • AR: (214) 620-1551 • AZ: (602) 994-5400 • CA: Anaheim (714) 635-7600 / Lodi (209) 334-1961 / San Diego (619) 565-1557 / San Jose (408) 298-7290 • CO: Colorado Springs (303) 594-0880 / Denver (303) 777-3070 • CT: (617) 235-5520 • DE: (809) 779-0200
FL: (800) 432-4480 • GA: (800) 327-6600 • HI: (808) 537-9758 • IA: (402) 885-5850 • ID: (801) 466-6522 • IL: (312) 255-4820 • IN: (317) 846-2591 • KS: (616) 252-3700
KY: (502) 228-5401 • LA: (800) 327-6600 • MA: (617) 235-5520 • MD: (301) 261-4344 • ME: (617) 235-5520 • MI: (313) 588-2300 • MN: (612) 425-4155 • MO: Independence
(316) 252-3700 / St. Louis (314) 721-0401 • MS: (800) 327-6600 • MT: (801) 466-6522 • NC: (800) 327-6600 • ND: (612) 425-4155 • NE: (402) 895-5850 • NH: (617) 235-5520
NJ: North (201) 589-2353 / South (609) 779-0200 • NM: Albuquerque (505) 292-1212 / Las Cruces (505) 524-9693 • NV: (714) 635-7600 • NY: Albany (518) 459-5891
Buffalo (716) 662-4568 / New York City (212) 589-2353 / Rochester (716) 442-5631 / Syracuse (315) 638-2042 • OH: Cleveland (216) 624-5930 / Dayton (513) 434-7600
OK: (405) 478-5000 • OR: (503) 224-3145 • PA: East (609) 779-0200 / West (412) 892-2953 • RI: (617) 235-5520 • SC: (800) 327-6600 • SD: (612) 425-4155
TN: (800) 327-6600 • TX: Dallas (214) 620-1551 / Austin (512) 327-8600 / El Paso (915) 542-1762 / Houston (713) 353-7728 • UT: (801) 466-6522 • VA: (801) 261-4344
VT: (617) 235-5520 • WA: (206) 454-2333 • WI: (414) 764-9379 • WV: East (801) 261-4344 / West (412) 892-2953 • WY: (303) 777-3070 • Washington, DC: (301) 261-4344
Puerto Rico: (809) 723-9689

CIRCLE 20 ON READER CARD



EDITORIAL

PAINTING THE WORLD BLUE

IBM is Creating an Umbrella of De Facto Standards

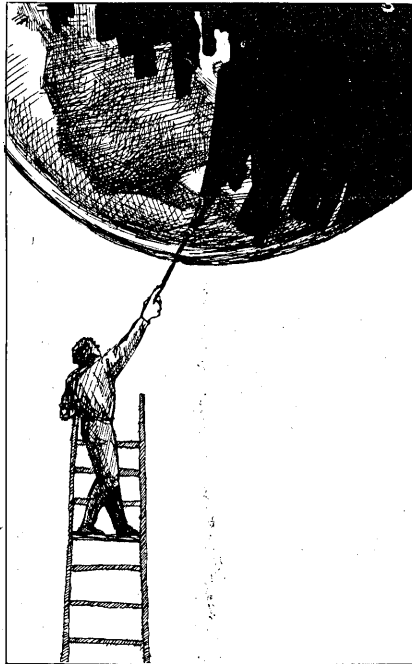

ILLUSTRATION BY AMY SALGANIK

IBM, a company one would never characterize as shy and retiring, has become even more aggressive since the government dropped its antitrust suit in 1982. During the past year it has made a series of product announcements that have delighted users, confounded competitors, sobered venture capitalists, and sent shock waves through Wall Street.

"They're painting the world blue," commented one industry observer, and, indeed, it appears they are. From P.C.*jr* to the 3081, from the dp shops of the Fortune 500 to the home and the classroom, IBM has thrown down the competitive gauntlet. Concerned about the inevitable clash with the Japanese, IBM is clearly seeking a new level of dominance in the information processing industry.

Domestic competitors have been caught in the buzz saw: earnings and stock prices have fluctuated wildly. Like aroused sharks, the financial analysts are circling the industry's largest companies, probing for weakness, anticipating trouble. Some are forecasting the demise of at least one or two of the BUNCH companies; others cast a cold eye on the prospects of such industry stalwarts as Wang, Digital, and the upstart newcomer, Apple.

Above all, IBM has become the primary source of de facto standards, the creator of a pervasive information systems environment that every other firm in the information handling business must reckon with.

These developments should surprise no one. IBM has openly declared its intentions for some time; its stated goals are to be the number one low-cost supplier, to lead in quality and service, and to compete in every area of computing.

Information processing firms that are to survive in this IBM-dominated marketplace must have certain clearly definable characteristics.

First of all, at some level, they will be IBM-compatible—that is, their products and services will fit comfortably within the umbrella of de facto standards that IBM has erected. They will be well capitalized and well managed (worthy of at least a favorable mention in the next edition of *In Search of Excellence*). They must have a broad range of products and a variety of distribution channels to match. Special emphasis will be placed on marketing skills, including a thorough understanding of their customers' needs (engineering solutions that are technically elegant but do not address real world concerns will remain in the lab). Manufacturing facilities must be modern, highly automated, and very efficient. R&D spending will be ample, and overall emphasis will be on long-term goals, not quarterly earnings. Smaller companies will understand that the new business environment is more unforgiving: one major strategic mistake, such as Osborne's, and their exit from the business will be almost inevitable.

Firms with these characteristics will be in a position to take advantage of an information systems marketplace that is projected to grow from its current \$70 billion annual level to \$300 billion by 1990.

With increased industry standardization, de facto and otherwise, we should see more innovation, more entrepreneurs, the growth of a myriad of small- to medium-sized niche companies, and a cluster of stronger, larger companies offering viable products within the IBM environment.

IBM's dominance of our industry is a fact of life, a fact that we will live with for some time to come despite the efforts of the Japanese and AT&T. Whether or not this is the best way for a technology that is profoundly altering our ways of living and working to develop is no longer a pertinent question.

For better or for worse, this is the way it is. *

INFOCUS

MIRROR, MIRROR, ON THE WALL

**Who is the fairest one of all?
An industrial designer looks at
portable computers.**

by Marc Harrison

The exquisite design and style of one's tools can mysteriously add to the pleasure and precision of our work and play, as if they have a power or spirit of their own. Professionals, as well as hobbyists, who use tools revel in owning and using the finest tools of the trade.

These tools usually have an understated design, are constructed of high quality materials and finishes, and effortlessly fit the hand, eyes, and the task. The analogy holds true for the sophisticated new portable computers and the new craftsmen who use them to manipulate words, data, and graphic images.

The visual, tactile, physical, and subjective qualities of personal artifacts like computers can delight and amuse, uplift our spirits, and act as extensions and mirrors of ourselves and as signals to others of our individuality. We all respond to beautiful and elegant objects and tend to temper our choice of automobiles, clothing, home and office furnishings, and almost everything else to our expectations that these products meet not only our practical demands for technical performance but also the demands of our aesthetic sensibilities, emotions, and personal taste.

So too with the computer portables. They are becoming a popular and highly visible and active physical companion to the new craftsmen, who transport them to and from the office, home, and school by auto, airplane, train, and bus, using them in any or all of these varying work environments. Understandably, users fully expect ease of use and precision results, regardless of the conditions.

A product with such inherent power deserves and demands to be a truly magnificent artifact, even a cultural icon of our time. It should be exquisite and visually exciting—an impressive implement that the user can enjoy for its own rational beauty and pragmatic utility.

There are scores of entries in the portable computer category, suggesting the need to employ computer-aided selection for the simple task of sorting out which one of these portables would best serve the user's performance needs. Besides the traditional technical features, prospective purchasers should consider the physical ap-

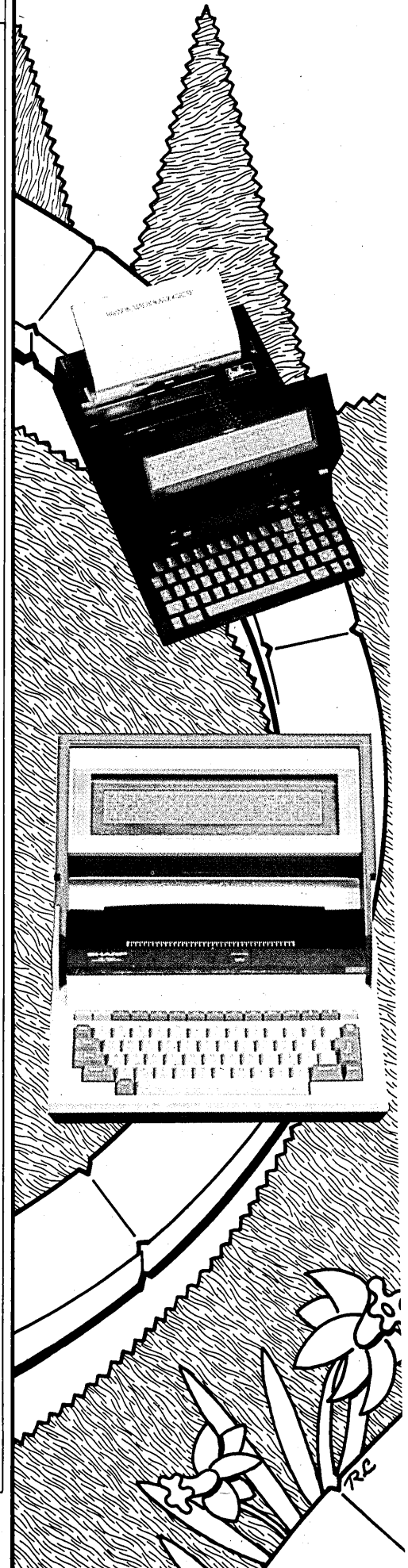

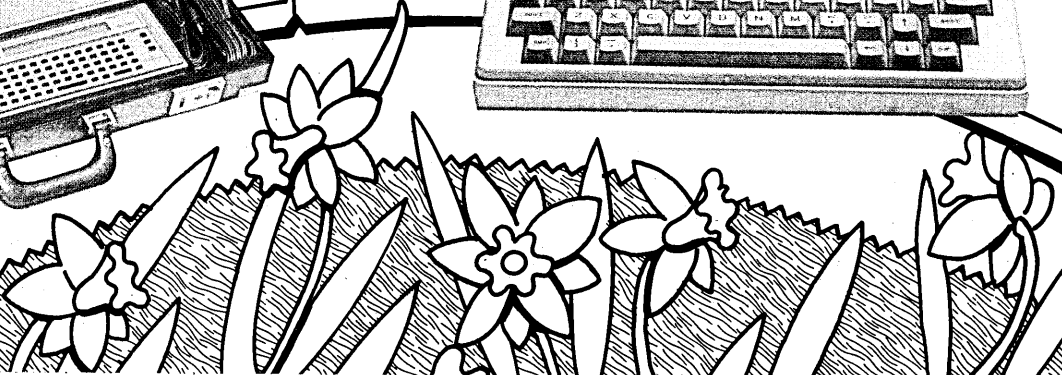
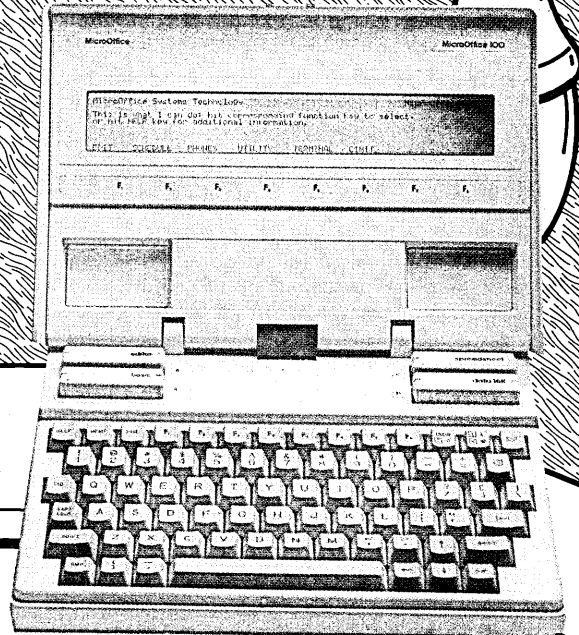
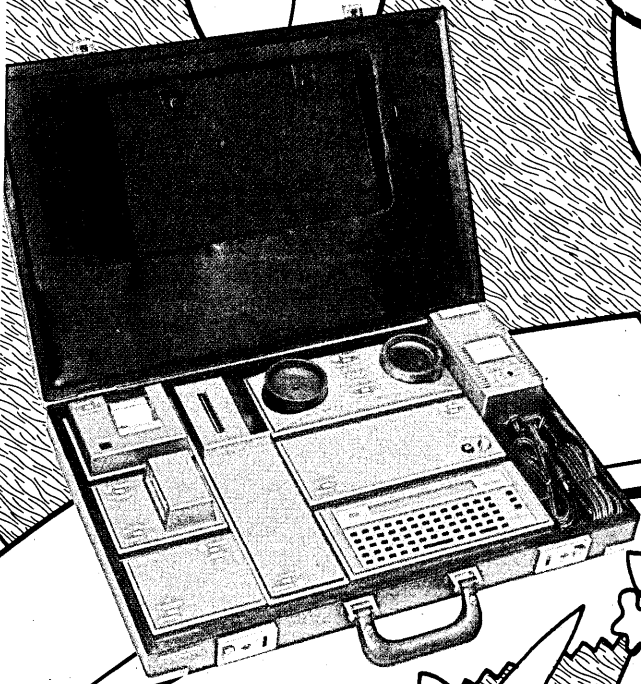
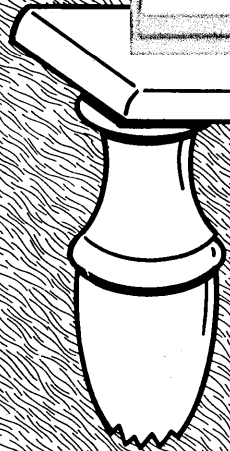
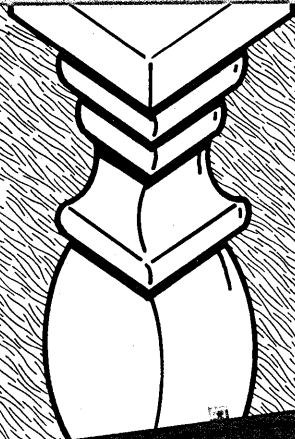
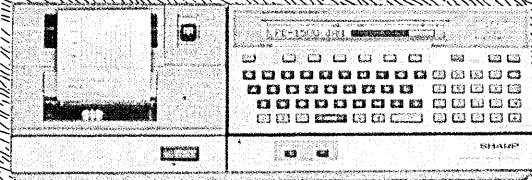
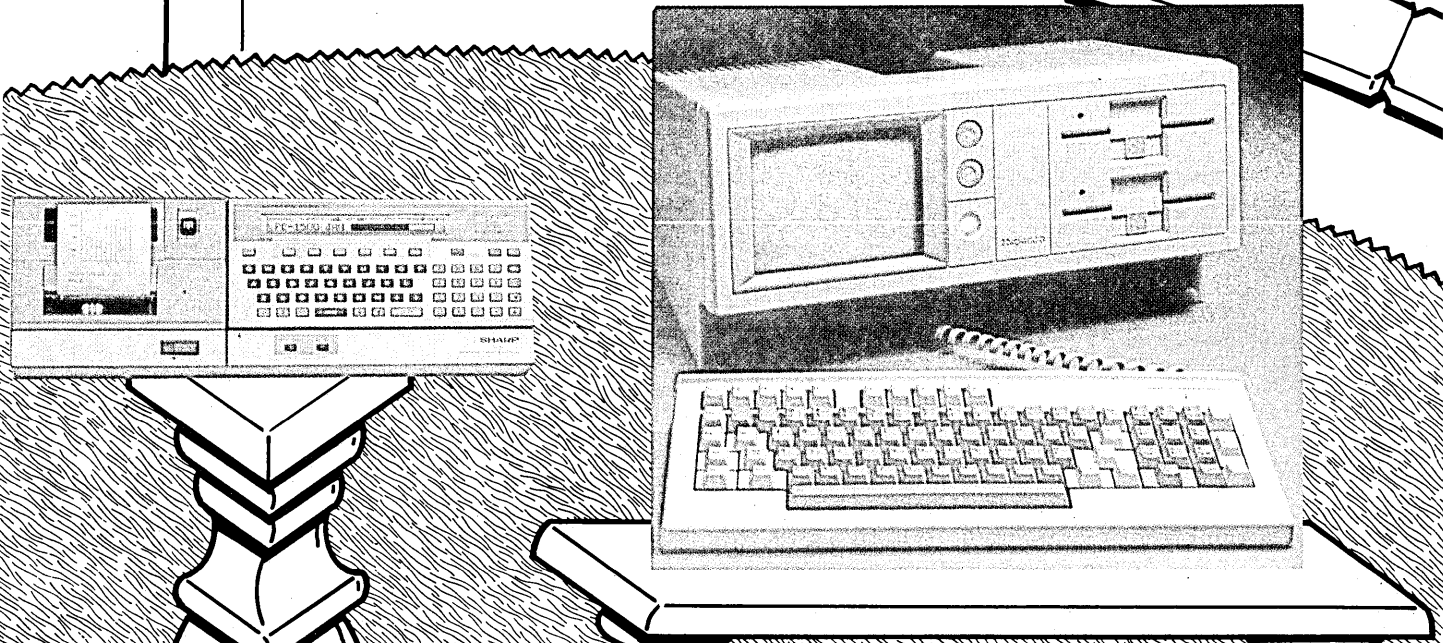
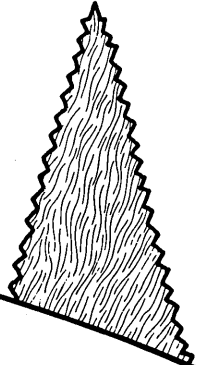
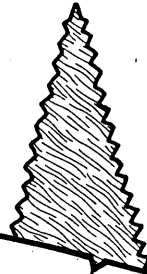
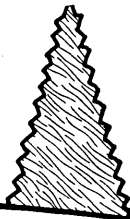
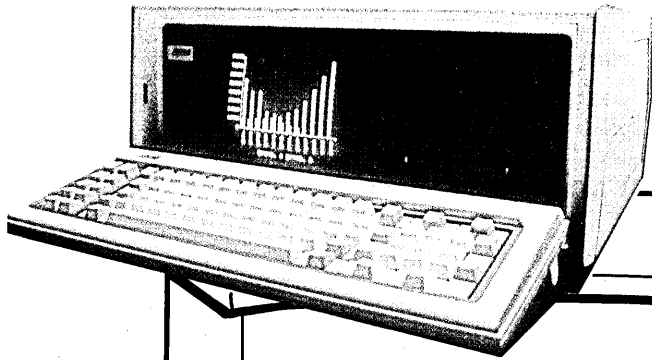

IN FOCUS

pearance. A design review of this product grouping shows that some objects have a visual grace and life, while others with almost identical technical attributes are dull and lifeless.

The criteria for our review were based upon traditional formal questions common to all visual and decorative arts and design. How well has the designer used and integrated appropriate materials, finishes, and markings? Are proportions and scale of the shapes, masses, lines, and silhouette gracefully managed? Does the object have a clear dominant identity with functioning elements supported by subordinate detailing? Have all of these visual qualities been simultaneously incorporated in engineering and ergonomic considerations—making the object fit the user and the task? How legible is the display? Is glare eliminated? Do the keys feel good, and are the markings understandable? These considerations and the authors' aesthetic views were the governing factors.

Of the 45 models we examined, some resembled a technician's test equipment. Many others were respectable but uninspired. Weak product offerings typically had a simple, sheet metal package. Many of the components appeared to be added on in bits and pieces, as if from a catalog of last

Some resemble a technician's test equipment. Others are respectable but uninspired.

minute ideas, and as a result, the portable itself resembled an assemblage of ad hoc parts.

To be fair, and for the sake of convenience, we chose to organize the review of computer portables into three subsets, based upon weight and size.

- *Transportables*—those portables averaging 25 pounds or so. Extremely heavy for long hauls because of built-in disk drives, full keyboards, and crt displays, these tend to approach the full features of desktop units. They need alternating current power or heavy battery packs and are inherently larger. Many transportables resemble portable sewing machines, though some successfully break away from this image.

- *Briefcase* or notebook-sized computers—range from three to 10 pounds and are characterized by low profile. A truly self-powered portable suitable for use in one's lap, these usually embody the flatter liquid crystal or electro-luminescent display and have full keyboards. This category also includes the flip-up display units and specialty systems, designed for specific tasks and market areas.

- *Pocket computers*—can weigh a few ounces to a pound and comfortably fit into a pocket or purse. Fundamental differences between briefcase and pocket computers are keyboard size and layout, display length and width, and of course, the amount of

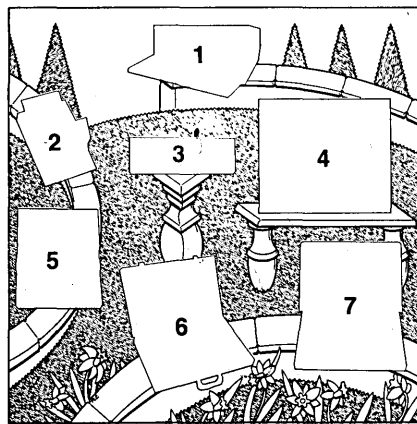

- 1-Compaq: "Clever details."
- 2-Gavilan: "Well proportioned."
- 3-Sharp PC-1500: "Thoughtful, pleasant."
- 4-Hyperion: "Great sensitivity."
- 5-Sharp PC-5000: "Different image."
- 6-Olympia: "Jewel-like quality."
- 7-Roadrunner: "Uncluttered look."

internal memory. Most have single line LC displays and are often used as parts of larger systems. Obviously, some trade-offs must be expected when the computer's size is reduced for the sake of portability. The display size, memory, and keyboard size will be affected, along with the appearance of the total package. Compact, however, does not necessarily mean difficult to use. For example, industry standard keyboards have $\frac{3}{4}$ -inch centers between keys and represent a typical typewriter layout best for touch typing. Those portables with reduced centers and a smaller keyboard force slower data entry, but are satisfactory for non-touch-typists.

Also, a separate numeric pad is a convenience, especially if one requires frequent number entries and calculations. A logical cursor key arrangement is important. The best are directional, with north/south and east/west placements.

Two key types exist. Break keys, which click and feel like a typewriter and have a full travel, are considered best for touch-typing. Soft keys have comparatively less travel, feel stiffer, and take some getting used to. The cathode ray tube display is very legible and good for graphics, but the large and heavy glass tube compromises compactness for clarity and is used mostly in transportables. Smaller displays offer more problems—liquid crystal displays are less legible than crt's, with reduced graphic capabilities. Since they require so little space and are lightweight, the LC is found in many of the notebook and briefcase-type units.

The electroluminescent display is excellent for clarity and graphics because it actually produces light; it is better than the LCD and requires less space than the crt. The ELD is found in few products because of its great expense.

For ease of legibility, especially for

those portables with LCD displays, a good contrast adjustment will help to reduce user fatigue. The display screen should be adjustable to reduce glare. The goal of the display is to approach the quality of the typewritten page, black or white. For legibility, sepia-tone screens, which offer higher contrast, may soon be used.

Optional attachments must also be considered when purchasing a portable computer. System peripherals such as disk drives, modems, printers, and additional displays have their own particular design requirements but should be integrated mechanically, electrically, and visually into the main unit.

The following products are praiseworthy. Much effort and talent obviously went into these elegant products.

The Hyperion, an exceedingly attractive product, has a simple rectilinear shape softened by slightly radial edges, a detail consistently carried out on almost all of the edges of the crt monitor and the separate keyboard. The severity of the pure rectangular form of other models is modified by continuing the two sides to the table surface. This converts the side view from a pure rectangle to a long trapezoid, establishing the correct viewing angle. The lower portion of the side acts to elevate the monitor and create a storage space for the keyboard; two feet retain the keyboard for transport and are a continuation of the entire form.

This product's design has been executed with great sensitivity: it whispers rather than shouts at you. All of the detailing is understated with finely incised lines to quietly define the working component sections of the main processor, disk storage, crt, and adjustment controls. The few details of the adjustment knobs are discreetly set in flush with the surface, and have a slight radiating texture directing the eye to the place for fingers. The same is true of a small textured area that activates the doors of the disk drives.

COMPASS is a masterpiece. It established the prototypical form for a product this size.

The housing's color is a light muted gray, with special attention drawn by a darker gray on the bezel around the screen and on the standard section of the keyboard. This two-tone color signifies that these two parts are the dominant functioning elements that work in unison. The adjustable keyboard is also a single rectangle. The edges of the keyboard caps have been proportioned so that the entire keyboard resides in a rectangular frame without ragged edges. The numeric keyboard is also a darker color. The remaining keys seem to recede since they are the same tone as the case itself.

The main body has a built-in handle

IN FOCUS

molded into the top. The screen is amber phosphor for comfort, which is an excellent color complement to the soft grays of the molded cases and the small red power-on details on the front of the monitor. The keyboard has 84 keys and meets the European ergonomic design standards.

Even the back of the device has been thoughtfully designed in the visual texture created by the cooling slots and line-up of connectors. The device is supplied with a protective carrying case similar to soft-side luggage and weighs 38 pounds, just within the OSHA 40-pound limit.

The DOT is a full-functioned high performance transportable. Special features include a wide screen display, 5" x 9", set into an easy to look at textured black front integrated with the modestly stated disk drives. It has a built-in full width printer that can print whatever is on the crt screen. The printer is simply expressed by a rectangular slot on the top, but a side view of the unit makes a subtle statement of the printer as a rectangle intersecting the wedge shape of the crt housing. A black base lines up with the keyboard at the same latitude, making the unit a visual whole even when seen from the side.

The keyboard is carefully proportioned into two main rectangles, eliminating the annoyance of ragged key arrangement on the edges. The 90 keys are designated by a subtle change in color: the alphanumeric keys and separate numeric keys are a slightly darker shade of gray than the main housings. The black front eliminates glare and calls attention to the wide display. The base, main housing, and keys make a pleas-

The TI pocket computer peripherals are an attractive product on their own.

ant play of light gray, medium gray, and black shapes.

The DOT is more sculptured in appearance than other transportables, with large, softly curved top edges on the main unit and on all four corners of the keyboard. Oddly enough, the DOT has an inconsistently designed hard-molded carrying case, with common handle and latches.

An interesting design and engineering concept is reflected in Compaq Computer's COMPAQ. This transportable has been planned with the entire exterior housing acting as the carrying case with a nondescript luggage-style handle permanently affixed on the back of the unit. The keyboard locks into the front of the display face to become the bottom of the case. A clever detail is the molded tube receptacle for the coil cord connection to the keyboard.

The crt tube and vertically oriented disk drives are set into a glare-free black plane within a light exterior structural frame. The crt and disk drives are treated as slightly recessed rectangular openings with

radius corners. In this design all the exterior edges are treated with the same modest radii to soften the simple rectangular package. On the keyboard, the full keys are set into a black plane that is recessed into a shoulder.

In contrast to the Hyperion and DOT, the COMPAQ's keyboard colors are reversed: the main alphanumeric keys and numeric keys are molded in a light gray, while the function keys have a darker tone in keeping with the darker overall color of the main housings. The keyboard has been proportioned and the keys molded and arranged to create an overall rectangular shape that parallels the exterior structure.

Otrona's Attaché is the smallest conventional transportable and, unlike others, it is within the 9" x 13" x 23" size limit for items that fit under an airplane seat. The Attaché is housed in a no-nonsense rectangular housing as is the detachable keyboard. A crt and two horizontal disk drives are tightly packed. The keyboard occupies real estate up to the borders, though with some subtlety, and the unit resembles a technician's product but in a form acceptable to the executive.

One feature is particularly worth noting. The clever handle rotates to act as the support and simultaneously sets the viewing angle of the crt. The handle is molded with structural ribs and weight reduction holes recalling airplane spars. It is a design that consciously avoids styling, but in a recognizable technical style that is well done. The 18-pound Attaché is supplied with a top-loading soft-luggage knapsack carrying case with a shoulder strap. A rational, understated technical style of design is consistently carried out in the Attaché.

In the notebook and briefcase computer category, one must pay homage to a masterpiece of design, the Compass GRID, which broke new ground and established the prototypical form for this product type. The black magnesium housing contains sophisticated components and the high price limits its appeal. The display is electroluminescent, permitting extremely clear, hard-edge legible displays. The graceful opening and closing action of the covered display is based upon an innovative hinge invention. When closed, the package is a severe black rectangular solid, but when it opens one can only be impressed by the beautiful proportions, fine finish, and subtle detailing and markings. It looks extremely inviting to use. The rich orange-yellow display color is repeated in the logo and in the instructions, along with white and red typography.

The keyboard repeats these color markings. Although closely spaced, the keys have a positive feel. They are subtly sculptured and are partially recessed into the keyboard plane.

Many innovative features distinguish the Compass. The flush latches are elegantly conceived details. The product

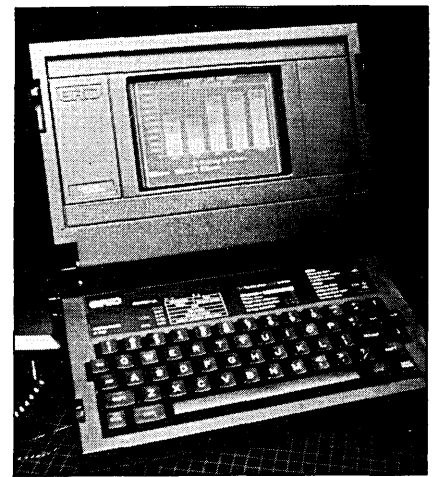

COMPASS: "Elegantly conceived."

has no handle, since it is designed to fit into a briefcase. The black squared-off telephone handset and all other peripheral products match the Compass's sleek design and geometries. A difficult act to follow, the Compass has received many design awards and is currently displayed in the Philadelphia Museum of Art "Design Since 1945" exhibit of distinguished products. It is a living lesson of technical and design innovation and performance, one of the most beautifully designed products seen in years.

A strikingly attractive special function portable, Convergent Technology's Workslate is an exciting new entry in the field. The small 8½ x 11-inch unit is about one inch thick and weighs 3½ pounds. It is a thin, nonglare textured black, slablike plane, with precise detailing on the surface. Caught by the light, a series of incised map lines quietly define and separate the display, speaker, microcassette holder, function keys, and keyboard.

The keys are slightly raised circles, ovals, or diamonds above the slab's surface. They are playfully and effortlessly expressed—the enter key is labeled "Do It." The organization is a remarkably clever and rational placement pattern. The rhomboid or diamond-shaped cursor key stands out visually and physically, with tactile texture at the north, south, east, and west edges. The small, oblong keys under the display are set into areas defined by the incised lines that correspond perfectly with the graphics on the display screen, showing premeditated and thoughtful integration of hardware and software. Yellow, green, white, and gray colored keys add to the lighthearted spirit of this portable. The smaller keyboard is more of the hunt-and-peck variety but the round, raised keys and the colored alphanumeric markings on the black housing on the upper left of each key extends accuracy by separating the moving key target and the fixed markings.

The Workslate is a beautifully proportioned, detailed portable with a sense of humor that delights the eye. It is a product

IN FOCUS

that delivers strong tactile pleasure, one that is enjoyable to hold and use. Destined to be a significant product in its category because of a masterful and deft design effort.

The Gavilan embodies the latest state-of-the-art technological advances, including such devices as a solid state touch pad below the liquid crystal display, which allows the cursor to move as a finger moves across the pad. This product integrates the keyboard, display, and snap-on printer into one simple, well-conceived rectangular package. The printer occupies only 5 inches, but the total unit can fit into a briefcase.

The design understates the sophistication of Gavilan's capabilities. The housing is comprised of well-proportioned basic rectangular and wedge shapes and has an excellent finish and mechanical details. When closed, the housing is a severe rectangle, but the angled planes of the keyboard and flipped-up display create an inviting, easy to understand and use array of three large planes when opened. These three planes place the keys and display into proper viewing and working angles. A beautiful product of unusual capabilities.

The display is a large LCD, and the tilt is adjustable, in 15-degree locking increments, based upon a beautifully conceived spring-loaded post and hinge assembly that attaches the display housing to the computer; when closed, the display housing seals the keyboard. The exposed ribbon cable to the display is a purposely expressed element of the hinge invention, whose ribbing is repeated on the exterior of the housing. The software and memory expansion capsules are cleverly designed to lock into a side opening and disappear as a flush detail. The computer is nonglare black, while the keyboard, LCD, touch pads, and touch-sensitive keys are a lighter gray. The keyboard is full size with separate numeric pad.

A new entry that packs a great deal of computer power in a small five-pound package that fits into half of a briefcase is Micro-Office's Roadrunner. Despite its small size this portable contains a full-sized keyboard suitable for touch-typing (73 keys). The lineup of function keys on the top row line up with corresponding symbols below the LC display to ease user entry. The flip-up cover and display is adjustable for the best viewing angle and presents a clean, uncluttered look when open. Four plug-in program cartridges are expressed three-dimensionally at the top of the keyboard, suggesting their easy-to-replace status. The warm gray color scheme and color shading differences between the alphanumeric keys and slightly darker function keys convey a nonthreatening feeling. The keyboard is set at an angle, with the cover-mounted display set comparatively higher in space than most. A clean, modest, and unassuming product of quiet grace.

The Sharp PC-5000 is an interesting

entry with a different image. Rather than convey the image of a new breed product, this device, when deployed, looks and acts like a typewriter. It has a full-size keyboard, optional printer, and a large LCD screen with eight lines. The keyboard is the familiar QWERTY layout, with the function keys lined up on the top row.

The PC-5000 is characterized by large, unadorned, smooth surfaces conveying a sense of great simplicity and calm. The color scheme is muted with light gray backgrounds and slate gray bands and framing. The alphanumeric keys are a light gray, and the function keys are distinguished by a darker tone. Three muted orange keys provide just enough interest to enliven this otherwise totally subdued product that, in use, recedes in visual importance. The modem that fits in the portable system is an attractive product in its own right, employing the same color scheme and a rational geometric layout of numeric keypad and speaker band. A modest looking but carefully designed product.

Olympia's Portable Computer is a clean, rectangular, solid shape with a mod-

The entry key on the Workslate is playfully labeled "Do It."

est radius on the outer edges that softens the package for the hand. The layout of the keyboard follows a rectangular grid, departing from the typical ragged edge ASCII layout. A clear space surrounds each key, with markings legibly set on the upper left of the fixed surface. Both the keyboard area and LC display are quietly defined as two rectangular frames. The keyboard is subtly recessed, and the tops of the keys are on the same plane as the display surface. Thoughtful attention has been given to understated details, which give this product a jewel-like quality, a mild finish, and delicate proportions.

Of special note is the beautifully integrated family of peripheral products—acoustic modem, tv adapter, serial interface, additional memory, and plotter—which have been carefully dimensioned and detailed to fit, and line up in a rational grid, within an accessory attaché case. The total family is an attractive and visually coordinated consistent assemblage.

While generically resembling competing pocket-sized computers, the Sharp PC-1500 displays fine attention to details that are rationally and pleasantly distributed on the work surface. The keyboard is set out in the conventional typewriter pattern for convenience, but the small size precludes touch-typing. The numeric pad is easy to read and use. Overall, this product has a fine finish appropriate for its scale, good proportions, and a thoughtful and pleasant composition of line and form.

An interesting feature is the manner

in which the computer physically and visually integrates as a total form when connected to the printer. The assembled duo works well together as an attractive, well scaled, and finished product.

While the Texas Instruments CC-40 is closer in size to the notebook computers, its functions place it somewhere between categories. It is a clean design with muted colors and fine finish, giving it the quality of a miniaturized stereo component. The full typewriter-style keyboard is composed of slightly raised rectangular keys, with a separate numeric pad. The various key functions are distinguished with muted shades of gray, with the main keyboard as the dominant shade. Key spacing, however, is necessarily close, thus limiting touch-typing. The function keys line up nicely above the numeric keyboard, and the neatly planned and executed plug-in software cartridges receptacle on the upper right corner completes this quietly designed product.

Perhaps the most delightful aspect of this product is its relationship with the family of products that interface with it. A four-color printer/plotter, RS232 communications interface, Wafertape cassette drive, telephone modem, and video interface are all housed in identically dimensioned and detailed casings. When stacked together, these products create a simple, beautifully proportioned rectangular solid. All of the details line up neatly, culminating with a printer on top that is an understated composition of rectangular lines and opening. Because the soft and mild color scheme is sensitively repeated, the peripherals make an attractive product on their own.

Beautiful products share a common heritage. Each makes a successful visual and technical bridge between art and science. A purely beautiful product with poor function is unacceptable in this arena, while, conversely, a magnificent technical solution cannot be fully operational if it is not designed for hand, eye, and spirit. To accomplish balanced, purposeful, and exciting products, reciprocal dialog must take place among corporate philosophy, technical implementation, and design and human problem solving at the onset of product planning. The products mentioned in this article demonstrate the integration of these quantities. *

Marc Harrison is professor of industrial design at Rhode Island School of Design, Providence, R.I., and president of Marc Harrison Associated, industrial design and engineering consultants, Portsmouth, R.I. He is principal designer for Cuisinarts Inc. and Cadmus Computer Corp., and serves as a consultant to a wide range of medical, industrial, electronic, and consumer product manufacturers. Jill Shurtleff and Bill Hoopes assisted him in writing this article.

DISCOVER THE DYSAN DIFFERENCE

Four Reasons Why The Dysan Difference is Worth Paying For

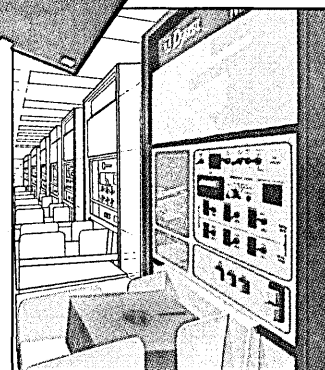
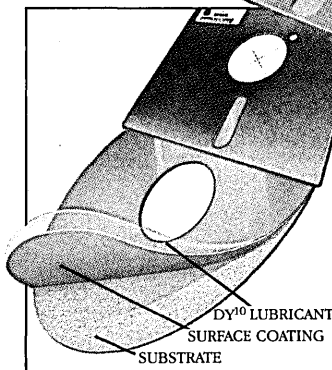
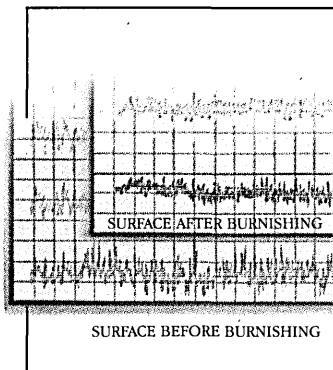
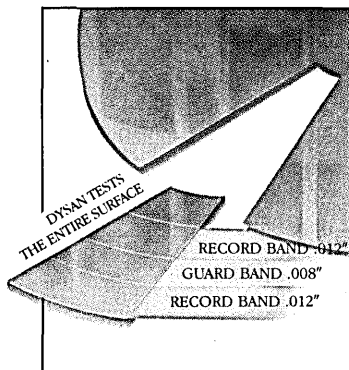

1. 100% Surface Tested

Only Dysan provides fully usable diskette surfaces that are truly 100% error-free across the entire face of the diskette. An exclusive on-and-between the track testing procedure guarantees error-free performance regardless of temperature and humidity distortions or slight head misalignments.

2. Advanced Burnishing Techniques

Dysan's advanced polishing methods create a smoother, more uniform diskette surface. This results in better signal quality on each track, less wear on drive heads and reliable access to data after millions of head passes.

3. DY¹⁰™ Lubricant

Dysan's proprietary DY¹⁰ lubricant complements the advanced burnishing process. Both maximize error-free performance while minimizing headwear. Optimal signal presence is maintained between the head and diskette surface during millions of write/read interfaces.

DY¹⁰ is a trademark of Dysan Corporation

4. Auto-Load Certification

Dysan's unique quality control methods reflect technological leadership in designing, producing and testing precision magnetic media. Each diskette is unerringly certified by Dysan-built, automated and microprocessor controlled certifiers. Your system and data base will benefit from Dysan's diskette reliability and unsurpassed quality.

Select from a complete line of premium 8" and 5 1/4" diskettes, in single or double densities, certified on one or both sides.

CIRCLE 22 ON READER CARD

 **Dysan**
CORPORATION

Corporate Headquarters:
5201 Patrick Henry Drive
Santa Clara, CA 95050
(800) 551-9000



At NASA's Ames Research Center, hundreds of scientists share hundreds of programs on one large computer network:

Digital's.

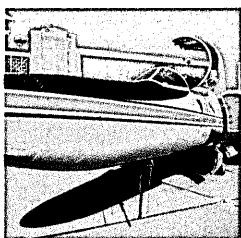

Aircraft design. Space biology. Computational fluid dynamics. Infrared astronomy. Interplanetary exploration.

At NASA's Ames Research Center, the technology couldn't get more advanced. That's why Ames scientists share a network of over 50 of Digital's computers and two large mainframes.



Everyone on the Ames network has access to almost every computer on it. Researchers share not only data, but software, utilities, and peripherals as well. A program written anywhere is often useful everywhere on the network, so there is practically no dupli-

cation of effort and almost no need to retrain users when new programs are added. The savings, in time and money, are substantial.



The Ames network is an open-ended system. It has grown from one computer to over 50 in just eight years, with minimal disruption of service during its continuous expansion. Thanks to Digital's compatibility, even across generations, it wasn't necessary to replace any of Digital's computers. They simply added to them.

So if you're considering a network,

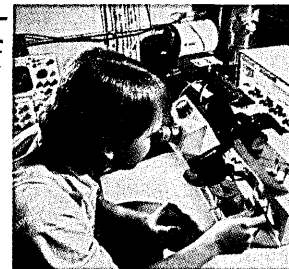

talk to Digital. We'll show you how you can start as small as you want. And grow as large as you need.

digital™

© Digital Equipment Corporation 1983

NEWS

IN PERSPECTIVE

USERS' CONCERNS

H'WELL OPTS FOR NEC

The Minneapolis manufacturer is pegging its future on a Japanese company it once tutored in the making of computers.

by Jan Johnson

In the computer business, at least for right now, there's only one company big enough to be Momma, and many believe that company isn't Honeywell. After years of taking punches from pundits, it appears Honeywell is retreating from at least one front. It is on the verge of signing over the future of its high-end mainframe line, machines beyond the DPS-88, to NEC of Japan. Or at least that's the way some people see it.

Others, including Honeywell, see the NEC deal as merely a means of extending Honeywell product capability into the scientific FORTRAN processing world without extending Honeywell's development budget.

Since the early days, Honeywell management has insisted on a "be all" product strategy, a strategy that has cost the company dearly from the start. Not only did Honeywell pay a hefty price for the 1970 General Electric computer acquisition, it faced the demanding and expensive task of juggling incompatible product lines. Then the market exploded, fragmenting into mainframes, minis, and micros, communications networks, peripherals, and service bureaus. And, of course, the ever-present demands for more and more application software. Honeywell fell behind.

Indeed, a survey of Honeywell users performed earlier this year by Cowen & Co., a Boston investment research company, found that 57% of respondents viewed Honeywell's applications software offerings as inferior to IBM's, up from a reading of about 53% the year before. The same survey found a rather tepid demand for the company's DPS-88 large-scale mainframe and also discovered that 35% of the remaining Level 66 users did not plan to install DPS-8 or DPS-88 mainframes.

Reflecting on that past, retired vice chairman Steve Keating, who became president of Honeywell in 1965 and played a key role in the General Electric acquisition deal, admits that management may have misplayed its hand in those early days: "Had we realized how big a market it would be, we might have tended to develop some niches instead of trying to be every-

thing to everyone. That's a big responsibility in terms of R&D and massive model adaptation. I think everyone underestimated the magnitude of the computer market."

Also underestimated was IBM's impact—specifically, IBM's impact on the third-party software market. It's no secret that Honeywell has suffered a number of big customer defections to IBM. The lack of applications software for Honeywell machines is the most frequently cited reason for the migration to IBM.

"Although we are a large trailer manufacturer we are a small data processing operation," explains Jim Staniforth, vice president of information services at Fruehauf Division, Fruehauf Corp., Detroit. "I need preprogrammed solutions and I need productivity tools." Staniforth, like many others, sees a much broader product offering for IBM machines from third-party vendors, which is why Staniforth is seriously considering leaving Honeywell.

D T Doan, vice president of administration at Central Life Assurance Co. of Des Moines, also cites the lack of applications software as a key factor in moving the company's computing to IBM. In Central Life's case, however, a corporate group with Honeywell gear was merged with a company that had IBM gear.

Even ardent loyalists worry that Honeywell is stretched too thin. "From my perspective they are putting too many dollars into growth areas and not enough into improving what they already have," observes an edp vice president with an East Coast insurance company, who asked not to be identified. "I think they have suffered from trying to go too many ways. They want to come out with a product in every area, but once that product comes out it is done and forgotten and they get going on a new effort."

Less covert about his identity is Carl Bond, vice president of information systems at Farm Bureau Insurance Group, Lansing, Mich. Bond, who said he has no intentions of migrating away from Hon-

Users cite the lack of applications software as the major reason for defecting from the Honeywell fold.

eywell, agrees that Honeywell has a "diversity problem." "In most companies there are resource constraints—that is, in most companies, with perhaps one exception," commented Bond, alluding to IBM.

Since Honeywell professed a "Momma attitude" but was faced with finite corporate resources, a dwindling customer base, and robust IBM third-party software suppliers, something had to give. Some DPS-8 customers suggest it was Honeywell's commitment to the high end. Recalls Staniforth, "Two years ago we were very concerned that Honeywell was not

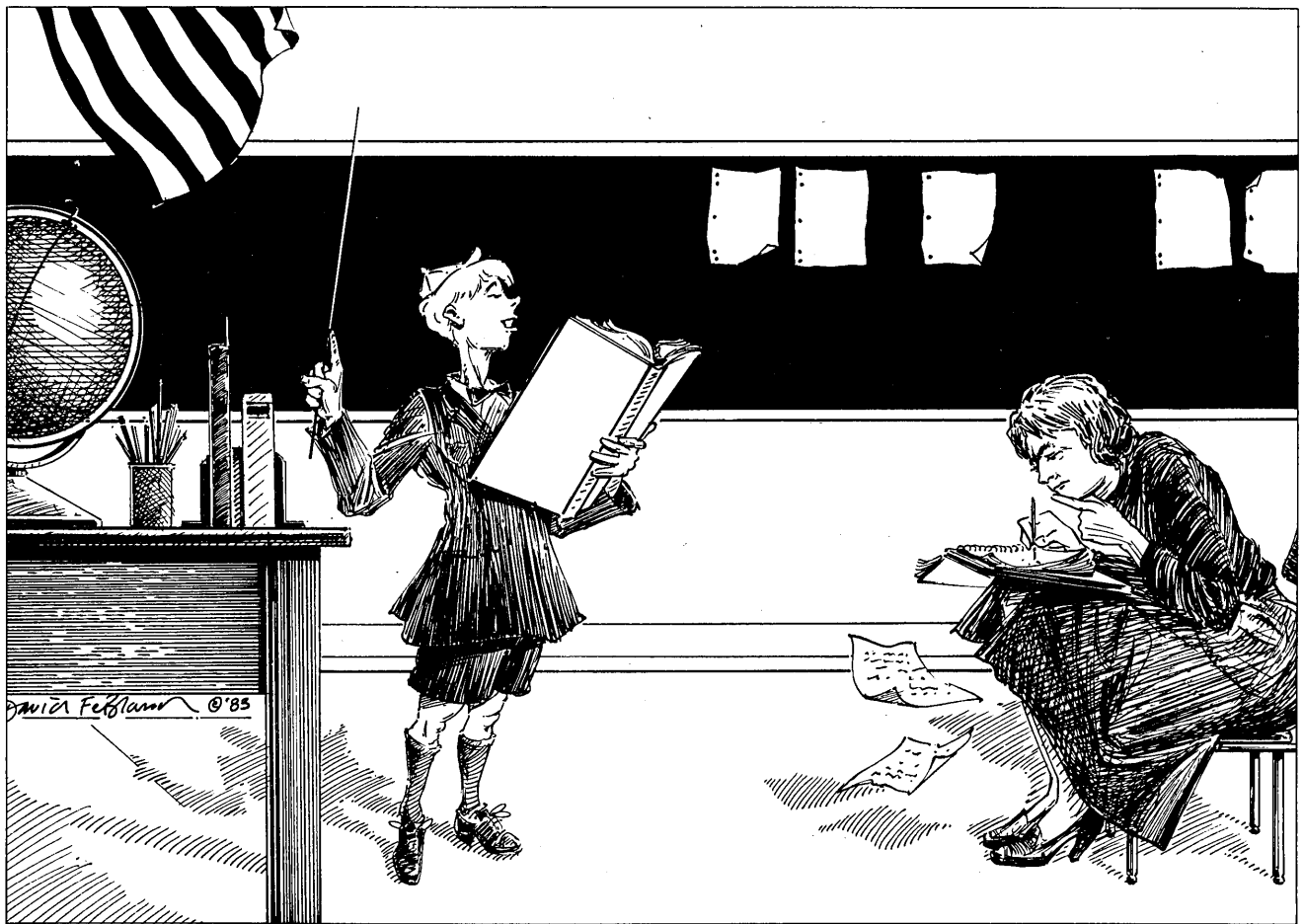

talking about its plans for larger processors, so they took us out to Phoenix to let us see and touch the DPS-88. After that we didn't hear much about large processors anymore." Other users expressed varying degrees of uneasiness about Honeywell's commitment to the high end.

It was also noted that Honeywell appears to be focusing some of its development effort at the low end. "It wouldn't surprise me if Honeywell decided it was going to get out of the large systems business, that it was going to quit trying to provide higher-end processors," says Staniforth.

Enter NEC of Japan, which became a student of Honeywell technology some 20 years ago. Not long after the GE deal, NEC and Honeywell signed a technology exchange agreement. That technology became the predecessor machines to NEC's current ACOS-1000 line, renamed the S-1000. The early agreement also licensed NEC to distribute Honeywell mainframes in Japan. "There was, of course, a reverse flow of patents and copyrights for Honeywell to use regarding NEC's technology," says Deward Manzer, vice president and general manager of Honeywell's large computer products division in Phoenix. "But the flow was certainly more in the other direction," from Honeywell to NEC, he says.

By 1979, the agreement had fallen into disuse. NEC no longer needed Honeywell technology.

Now, the student is at the front of the classroom, challenging its teacher for control. The place of confrontation is, ironically, General Electric's Information Ser-

The proposed agreement covers manufacturing rights for the S-1000 machine and future mainframes.

vices Co. (GEISCO), where 31 Honeywell DPS-8 systems are up for replacement. Talk about a computer industry soap opera—it's a triangle of technology transmutation. The scene: Honeywell, at the feet of its mother, battling it out with its nurtured student.

NEC has Honeywell beat on price and performance. NEC's S-1000 is said to offer 15 MIPS and higher for scientific problems because of its integrated array processor. Honeywell's DPS-88/81 is generally said to be rated at about 7.2 MIPS.

As for price, what is there to argue about? Japan has recently shown it can make equipment cheaper and then sell it for less.

Now wait a minute, counters a technology manager of a large East Coast Honeywell shop who asked not to be identified. The S-1000 may be a speed demon on FOR-

TRAN, but what about I/O? What about COBOL? The DPS-88 is considered to be the better COBOL and better interactive machine, and also to offer better I/O, he maintains.

"In my opinion, we will probably see GE take a mixed approach," says the technology manager. The word is that should Honeywell sign the NEC deal, GE will install a clustered arrangement featuring DPS-88s and offering the S-1000 for specialized processing, such as large FORTRAN problems. Deadline for closing the NEC deal is March 1984, confirms Honeywell's Manzer.

The proposed agreement would be a 10-year pact in which NEC would give Honeywell distribution rights to the S-1000 and future machines in the U.S. and in sales territories covered by its subsidiaries in the U.K., Italy, Canada, Australia, and Mexico. NEC would retain Far East distribution rights, while Honeywell would get non-exclusive rights for parts of the Far East.

The agreement also covers manufacturing rights for the S-1000 and future machines. A lot of details have yet to be hammered out, such as pricing for the S-1000 and a distribution agreement between Honeywell and Honeywell Bull, its French affiliate.

Interpretation of the NEC/Honeywell deal varies. A well-placed Honeywell

NEWS IN PERSPECTIVE

source maintains this is the beginning of the end. The bonus is that Honeywell users are assured a high-end growth path, although it will come from the Far East instead of the Midwest. It's a "graceful exit" for a reluctant Honeywell management that does not want to fund high-end computer development, according to the source. "Graceful" in that the Honeywell hand-off is to NEC and a product line that has its roots in Honeywell technology. From a user's perspective, what better partner for Honeywell to court than NEC? From Honeywell's perspective, "it's a total role reversal," maintains the source. NEC becomes the provider of advanced circuit and packaging technology and Honeywell becomes the distributor, continues the source. The student becomes the teacher.

"The technology required to go to the next step is not there. Honeywell is not willing to invest in the next step," insists the well-placed Honeywell source.

The bonus to Honeywell corporate, suggests this same source, is that Large Systems is able to participate at the high end of the market without funding the high cost of development. The speculation is that Honeywell will focus on a niche, and what better niche than the controls business? The recent shift in top-level management seems to support that theory. Steve Jerrits was replaced by James Renier as president of Honeywell Information Systems. Renier also functions as vice chairman of the company. Previously, Renier was president of Honeywell's control systems business, a post that no longer exists.

"It's my perception that Honeywell has not abandoned the high end, insists the technology manager with the East Coast Honeywell shop. He points to Honeywell's involvement in the Very High Speed Integrated Circuit (VHSIC) project as proof. "It appears to me those products will be used by all divisions," he says.

He sees the NEC machine as a specialty machine with a single, fast processor that will be a nice addition to Honeywell's line of general purpose machines. "I have serious reservations about moving to a machine with one superfast processor. For my needs, I'd rather have several slower processors that are tightly coupled and run under one operating system, which is the approach Honeywell has offered for years: four to six—up to eight at some government installations—tightly coupled Honeywell processors."

All Honeywell has done with the NEC agreement, he states, is offer an array processor as an adjunct to its general purpose line. "What's so bad about going outside to get hardware? IBM did it with the P.C., and everyone praised that as a uniquely creative solution. I think it's good that Honeywell is taking a very active position in going out and acquiring new technology on behalf of its customers."

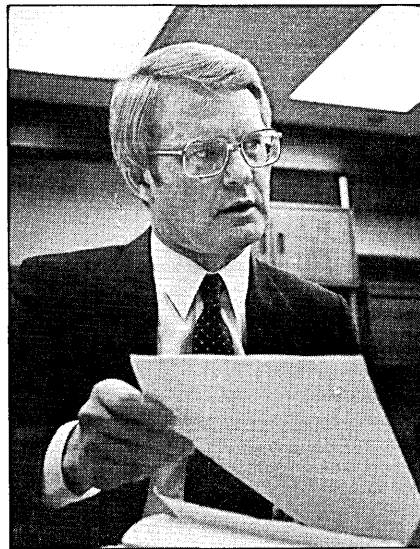

DEWARD MANZER: Phoenix will be a "systems integrator" and will continue to build large and medium-sized mainframes.

Commenting on Honeywell's shift in focus, the user agrees that the company is taking more of an active interest in applying computer technology to its controls business, but he said he views that as positive. "It's a good way for Honeywell to expand its customer base." Once on site, "Honeywell can start selling additional computers for other purposes since part of the interface to the new process control system is a Level 6, which can connect into Honeywell's other products. And customers that already have Honeywell equipment can take advantage of the new process control systems and integrate that into their mainframe operation."

His only major complaint is that Honeywell still has a ways to go in getting

One user points to Honeywell's involvement in the Defense Department's advanced VHSIC circuitry program as proof it hasn't sold its future in computing.

its marketing act together. "The Honeywell sales force was selling iron. They are changing some now, but they are going to have to change more, be more aggressive, have a sales force that is more solutions oriented."

Word from the users' camp is that the majority support the NEC/Honeywell deal, confirms Col. Pat Harris, president of Honeywell's user group and director of NORAD systems software, Peterson Air Force Base, Colorado Springs. Confides the vp of edp with the East Coast insurance company: "If the NEC announcement means Honeywell is going to consolidate efforts in their current equipment, then I think that will be good for me. The worst thing that

could happen would be to have Honeywell get out of the business."

"I would say this move indicates that Honeywell was having problems remaining competitive at the high end," concludes Honeywell user Bond. "But the NEC agreement seems like a rational move, and there certainly is a lot of precedent for expanding a product line through an outside source instead of reinventing the wheel."

What does this mean for Phoenix, a company that employs more than 4,000 people and for which Honeywell has long built large mainframes? Vice president Manzer says the Arizona operation will "focus efforts on successor products below the S-1000," namely the DPS-8 and 88 lines. Just a week before disclosing its discussions with NEC, however, Honeywell said it would reduce the Phoenix work force by about 500 employees, laying off and moving to other divisions a good portion of its systems engineering staff. The official reason for the cutback was the need to reduce production costs and overhead. Manzer says the move has nothing to do with the NEC deal.

When asked about Phoenix's role if the NEC deal does go through—it is currently only an agreement in principle—Manzer again states that the Large Systems division would continue development "on the lower end of the large system spectrum." In addition, he says, there are "options" for manufacturing the S-1000 at Phoenix. Other sources say Honeywell has indicated the S-1000 would be manufactured at Phoenix.

However, the bottom line is that Phoenix's role has shifted to a more software-oriented function. The Honeywell source concurs, saying, "Phoenix's role is now a software role."

Manzer bristles at this characterization but doesn't deny it. He is quick to point out that Phoenix will continue to develop and make the DPS-8, 88, and follow-ons. Yet, when Manzer talks about Phoenix he tends to focus on GCOS-8 development, I/O development, and communications systems development.

As for the fate of GCOS-8, it will become one with NEC's ACOS. "There is no agreement between the two companies to make the two operating systems compatible," asserts Manzer. There are plans, however, to modify GCOS-8 so that it runs on the S-1000. Manzer confirms that the S-1000 will become the upward-compatible member of the Honeywell product line. "But the two operating systems," he stresses, "are not going to be merged, nor is one going to replace the other."

When Manzer talks about Phoenix, he tends to position it as a "systems integrator." That does not mean Honeywell is retreating from its position as a full-service, general purpose computer company, he says.

Retreating? On the contrary, argues

HARD FACTS

ABOUT THE REAL LEADER IN COMPLETE SOFTWARE FOR BUSINESS: RAMIS II FROM MPG

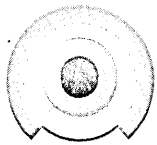

FACT:

RAMIS II Is The One System For All Your Users

To meet the full spectrum of application development and Information Center needs, RAMIS II starts with the most advanced decision support capabilities: a powerful report writer, a complete relational language, full-color business graphics, and much more.

Then we add a data base manager robust enough for high-performance on-line applications, a multitasked TP monitor that minimizes overhead and state-of-the-art screen formatting.

The result is the only integrated data base/data communications system designed for both highly structured transaction processing applications and unstructured decision support systems. And, the only product designed to fully unlock the power of your IBM mainframe, whether it's a 4321 running SSX, or a 3081 running MVS/XA.

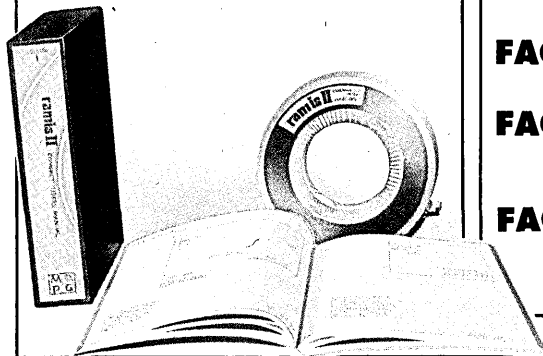

RAMIS II Unlocks Your Existing Data

RAMIS II maximizes the return on your investment in data through ready access to ADABAS, IMS, TOTAL, DL/I and IDMS data bases, as well as VSAM, ISAM and sequential files.

With the most powerful report writer available, plus graphics, RELATE and even English comprehension, RAMIS II unlocks external data easily and efficiently.

The Full Commitment And Support Of Martin Marietta

Leadership takes vision, plus the commitment and resources to turn that vision into bold new products.

FACT: More copies of RAMIS II have been sold than all other 4 GL's combined.

FACT: RAMIS II English comprehension responds to everyday English commands.

FACT: MPG developed the first practical relational language.

FACT: There's no more powerful system for screen-based applications than RAMIS II.

FACT: RAMIS II was the first product designed for both application building and Information Centers.



To achieve our goal of a complete software solution, we have invested an average of 16% of annual revenues in research and development—more than twice the industry average.

Now, as part of Martin Marietta Data Systems, we offer a complete range of information solutions, from software products to professional services, from processing services to integrated systems. And, the financial and technical strength of Martin Marietta, a diversified company with more than \$3½ billion in revenues, is accelerating new product development.

It takes more than a roar to be the leader. When it comes to providing a complete software solution, the facts prove there's only one real leader—RAMIS II from MPG.

To get all the facts, visit one of our regional Product Demonstration Centers, or attend a free RAMIS II seminar. For more information, call your local MPG office or call toll free (800) 257-5171. (In New Jersey call (609) 799-2600, Ext. 2325.)

**Mathematica Products Group
A Martin Marietta
Data Systems Company**
P.O. Box 2392
Princeton, NJ 08540

Copyright ©1983 Mathematica Products Group, Inc.



RAMIS® II...The Leader By Design

Boston (617) 357-9424 Chicago (312) 870-9710 Houston (713) 850-8697 Los Angeles (213) 670-6962 New York (212) 980-9077 Princeton (609) 799-2600
San Francisco (415) 461-6315 Washington, DC (202) 484-5752 Basel (61) 429923 Bergen (5) 32 13 00 Heidelberg (6221) 14051 Hong Kong 5-435714
Kingston (809) 929-7223 London (1) 580-3681 Milan (2) 546-8080 Montevideo (2) 906788 Ottawa (613) 236-8616 Paris (1) 776 41 71 Santiago (2) 31014
Singapore 273 9255 Stockholm (8) 520720 Sydney (2) 923 1677 Tel Aviv (52) 70364 Toronto (416) 226-6613

CIRCLE 23 ON READER CARD

NEWS IN PERSPECTIVE

the East Coast dp technology manager, "Honeywell is broadening its reach by adding an array processor that would be attractive to the scientific user and by pulling in new users from the controls side of the business."

"We are not going to be just a distributor or marketing organization to NEC," insists Manzer. "Our posture is to acquire outstanding products developed outside our own line and integrate them with our internal products, GCOS-8, IO, and communications, in order to bring to the customer the best possible offering we can."

AVOIDING LOCAL LOOPS

That's what bypass technology is all about, but it has risks as well as some major benefits.

by Willie Schatz

There's a new diagram in major corporations' playbooks these days. It's called the end around.

It works just like the one in football. The ball carrier comes from left to right (or right to left, for those who like their politics that way) in an attempt to catch the defense napping.

But this game isn't football. It's called bypass. And the fields aren't just in Pittsburgh or Dallas. They're all over the country. Playing offense are the Fortune 500. On defense are the local telephone companies. So far the game's been fairly even. It's about to become all offense.

"If I were an investor, I'd look hard at putting my money into private microwave," advises Jerry Lucas, president of Telestrategies, a consulting group in Arlington, Va., that recently sponsored a telephone bypass strategies conference. "That's going to be a booming business. Companies that never considered bypass are now actively thinking about it, because the situation for them is only going to get worse."

That's not to say the current situation is bad. Then again, it ain't good. The fault, dear users, lies not in the long run but in the short run. It seems that the telephone company's local loop is throwing users for big losses on almost every play. Thus, the new philosophy: if you can't join them, go around them.

"There is nothing written in stone that the telephone company local loop is the most cost-effective way to provide service to subscriber locations," Lucas says. "There are a host of technologies to use to

substitute for the traditional twisted wire pair service. And most of those, such as private microwave, satellite, and digital termination service [DTS], will generally outperform the local loop."

Thus the rush to bypass. Or at least the steady run to it. This is not a series of long, flashy dashes that eat up a lot of telephone company yardage. It's more like continuous, straight-ahead plunges that gradually wear down the defense. So far, bypass has only taken \$65 million of the phone company's business. But that's just the beginning. There's another \$10 billion waiting to be gobbled up in the next decade. There may even be as much as \$60 billion available.

The amount depends on the kind of bypass. You probably think bypass is as simple as putting up two microwave towers and yapping away. Fat chance. That would be too easy for the economists and theoreticians, so they had to do something. Thus were created economic bypass and uneconomic bypass.

"Economic bypass occurs when something like private microwave or cable television just clearly outperforms the service provided by the telephone company's plant," Lucas explains. "It's simply more economic for the user than the pricing structure he can come up with based on the traditional phone company service."

That type of bypass accounts for the projected \$10 billion market. Lucas estimates that the telephone company can participate in, and possibly even capture, 70% of that business if free enterprise is allowed to go its merry way. But Congress doesn't seem inclined to erect a shrine to that philosophy, at least not in the phone industry.

"Uneconomic bypass occurs whenever the cost of telephone company service is about the true cost of providing that service," Lucas says. "Let's say a state public

Industry observers point to economic and uneconomic bypass situations, depending on the relationship between the user and telephone company.

utilities commission [PUC] determines that the access charges large corporations and interexchange carriers [e.g., MCI and GTE/Sprint] have to pay to hook up to the public network should be used to subsidize local rates. That's the trunk side of the switch.

"There's such political pressure to keep residential rates down that the state PUCs can easily come up with a pricing philosophy such that in order to keep rates down, they'll assess the interexchange carriers and large corporations more for accessing the public network on the trunk side of the switch. Then they'll have to pay a higher price than they normally would if everything were based on cost. So access

on the trunk side subsidizes access on the subscriber side. That encourages uneconomical bypass. Normally that would not be cost-effective, but because of the way the service is priced it will be cost-effective for large corporations and interexchange carriers to use alternatives like private microwave."

Weep not for the bypasser, by the way. In both cases he saves money. It's just that in the so-called uneconomical type the traditional wire pair approach would be more cost-effective if it were really based on actual cost.

But then the phone company's service has never been based on actual cost.

"Costs are totally insensitive to use. Any method of allocation is purely arbitrary and makes no economic sense," says one analyst.

Since Alexander Graham Bell told Watson to get the hell into his office, the residential user has gotten much more than he paid for. Long distance has more than held up its end.

"Costs are totally insensitive to use," John Bain, vice president for telecommunications research for Lehman Brothers, Kuhn, Loeb, told Telestrategies clients recently. "Any method of allocation is purely arbitrary and makes no economic sense. How can you tell how much of [AT&T chairman] Charlie Brown's desk should be allocated to interstate service?"

You can't. Neither can Charlie Brown, for that matter. But the FCC thinks it can, and so does Congress. That's why the former developed an access charge plan for residential and business customers. That's also why the latter, now suddenly and shockingly supported by the Reagan administration through Commerce secretary Malcolm Baldrige, is doing some number crunching of its own. The legislators don't seem to think the regulators can add. They do know their constituents can subtract.

The FCC access charge, originally scheduled to become effective on Jan. 1 but delayed by popular (read political) demand until April 3, would add \$2 to each residential user's monthly bill and \$6 to each business's monthly bill, with the residential amount increasing \$1 per month each year. The business charge would remain constant until the "reevaluation" scheduled for 1986.

The theory is that the access charge would eventually replace the AT&T long distance subsidy now used to prop up local rates. The theory applied to interexchange carriers is that the large discount they currently receive for local Bell System access because that connection is inferior to AT&T's would gradually erode because those carriers would receive equal access.

The reality is that the House passed

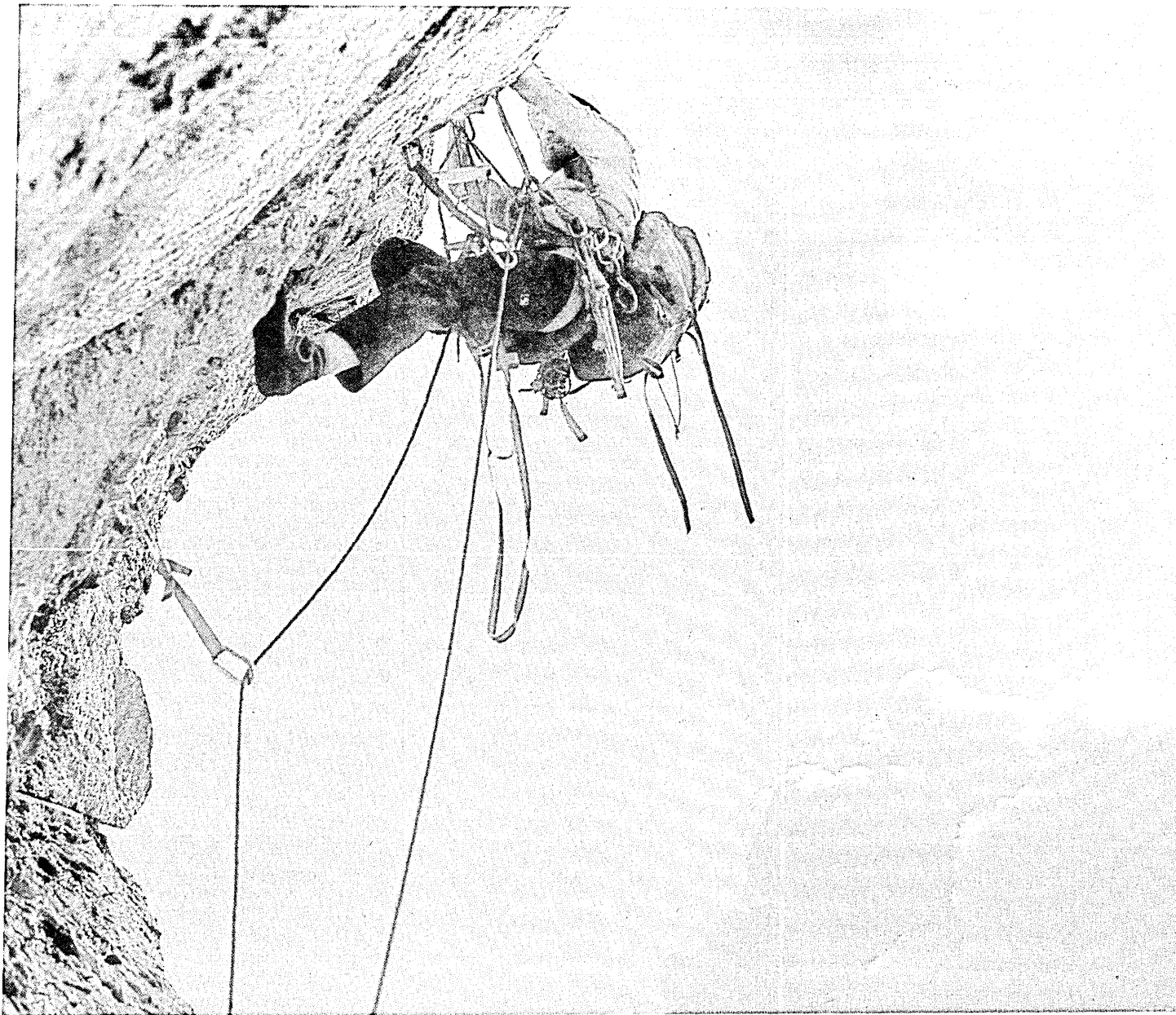

Secure upward mobility – For your links with W&G datacom test equipment

The performance of datacom networks can rise or fall. It will fall by itself. Its quality will rise with fewer transmission errors, less downtime, faster trouble analysis and quick removal of impairments. Hence, test instruments from Wandel & Goltermann can bring you a lot of help.

We have designed 10 powerful measuring instruments for troubleshooting and field service of data links. Covering all common analog and digital parameters. Up to five will fit into the DMS-1, the mix and match field case which permits assembling test capability according to your specific needs. Whether for telephone companies,

or information networks within transportation, insurance and banking organizations, in fact, anywhere where data channels are found – we can help you with



the correct measurement tool.

- ★ Interface Testers (RS-/V. and X. access points)
 - ★ Switching and patching of links-protocol and channel simulation
 - ★ Modem Tester with bit- and block-error rate, bias distortion, timing measurements for V.24/RS-232C interfaces.
 - ★ Data Circuit Measuring Set for impulse noise and drop-out according to CCITT O.71 and O.62.
 - ★ Level Generator and Level and Noise Meter, 15 Hz to 20 kHz.
- From the simple field instrument to the sophisticated protocol analyzer – come to W&G for your test needs. Ask for free information.



Please send me:

Information about the DMS-1

Your "Data Product Line"

An applications engineer

Name

Firm

Address

Street

Tel. No.

W&G Instruments Inc

119 Naylor Avenue
Livingston NJ 07039
Tel. 201-994-0854
Tlx. 710-994-4859w+ginstr.



In Europe contact: Wandel & Goltermann · P.O.B. 45 · D 7412 Eningen · Fed.-Rep. of Germany

CIRCLE 24 ON READER CARD

NEWS IN PERSPECTIVE

H.R. 4102, the universal telephone service preservation act. The bill repeals the FCC's access charge, creates a \$1.25 billion "universal service fund" to provide subsidies for phone service in rural areas and for "lifeline service" for the poor, and im-

"Congress is grossly misinformed. They have no sense of how corporate networks are designed."

poses a \$25 per month charge on privately owned and operated phone systems that

could interconnect with the local phone lines (whether they actually do so or not). There's also a levy of no more than 10% of the special access charge on private lines for those who indirectly interconnect with the exchange carrier (the infamous "leaky PBX").

The bill also provides significant relief to the MCIs of the world.

S. 1660, the Senate contribution to this lovely little war—in which AT&T had spent an estimated \$3 million to defeat the House bill—would defer the FCC access charges on residential customers and sin-

gle-line business users until Jan. 1, 1986. It also directs the federal-state Joint Board created by the bill to establish a schedule for and provide for the collection of surcharges on interexchange carriers, those connecting either directly or indirectly with the local exchange, and bypassers.

With Congress scheduled to take a two-month vacation from Thanksgiving to Jan. 23, no action was expected on S. 1660 until the lawmakers return to Washington.

"What Congress and the White House are overlooking is that local telephone companies have to be put in a viable economic position," Lucas charges. "They can't just arbitrarily say, 'No, you can't raise your rates.' If this is what they want, they'll have to come up with a system that will end up subsidizing the local rate payer.

"Congress is grossly misinformed. I haven't heard one of their discussions that seems to really relate to the realities of telephone networks. They have no sense of how corporate networks are designed and how bypass fits into the corporate telecommunications system. They don't understand the bypass strategies that will evolve as a

AT&T is estimated to have spent about \$3 million in lobbying for its side of the case as Congress debated the bypass issue.

result of their access decision. They're just responding to the constituent who screams loudest about increased phone rates. They ought to be defending the FCC plan, because it puts the charges where they belong. The cost creator is the payer."

The forthcoming strategies will be an endless succession of end arounds. Corporations and large private users, sworn to reduce to the absolute minimum their dependence on service provided by a monopoly or regulated carrier (e.g., the phone company), will go wireless immediately.

At first glance, that hardly seems to be the worst thing in the world. If you can improve your service and your bottom line simultaneously, who's going to argue? Certainly not your stockholders. But some further number crunching indicates that bypassing the phone company just might put it in tap city.

According to what Alan Pearce, president of Information Age Economics, told the Telestrategies meeting, it's what's up front that counts for the local phone companies. To wit: half of all residential and three fourths of all business interstate revenue is generated by the top 10% of people in each category; half of the interstate revenue is generated by the top 1% of the large users; 10% of all households never make a toll call and 30% spend less than \$5 monthly on toll calls; and 50% of users spend more than \$50 monthly on toll calls.

"The impact of bypass on local tel-

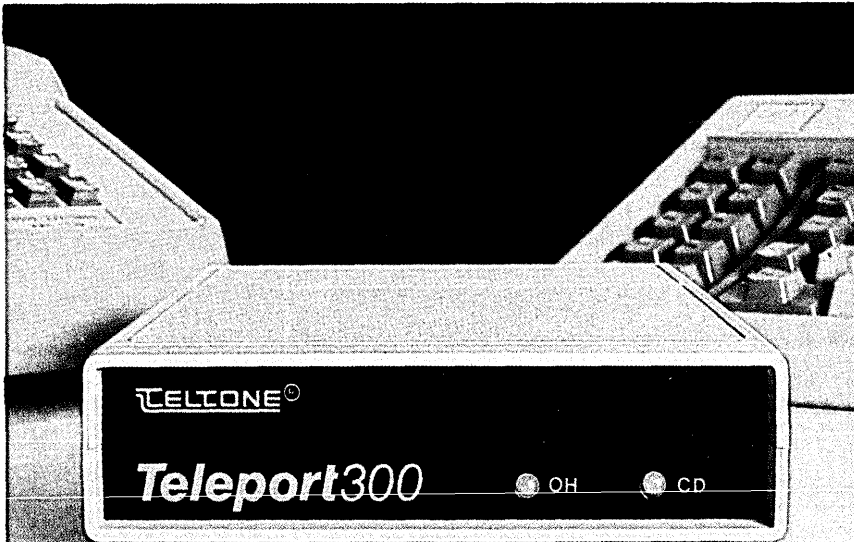

Touch-Tone[®] In... ASCII Out

Turn any Touch-Tone[®] phone into a remote data entry terminal

By combining the capabilities of an intelligent modem with a DTMF to ASCII converter, Teltone has unlocked countless opportunities for you. With a Teleport 300 on your computer, you can use any Touch-Tone[®] phone in the country as a remote data entry terminal, or, if you wish, a control panel.

Imagine the possibilities: Branch office order entry, Inventory control, Remote control of environmental systems, Data logging, Emergency access to process control systems, Credit card authorizations, etc. The list goes on and on.

It's a full-featured smart modem

The Teleport 300 is a fully equipped intelligent modem: Bell 103J compatible, auto answer and originate, with tone and pulse repertory dialing and call progress indications. It's menu driven and user programmable. An internal buffer lets the

Teleport handle DTE speeds from 75 to 9600 baud.

Teleport delivers front end hardware security

You can program the Teleport 300 to respond only to a pre-determined series of DTMF signals. Unless the correct DTMF tones are detected, callers are not connected to your computer. It's an effective hardware barrier in front of any software security scheme you may be using to protect valuable programs and data.

List price is \$399.95.

To get all the Teleport details, call:

1-800-227-3800 ext 1130

Dealer inquiries are invited. Call the Teltone Telcom Components Division: (206) 827-9626 ext 220.

Teltone Corporation
10801 120th Avenue NE
P.O. Box 657, Kirkland, WA 98033
TWX 910 449-2862

Touch-Tone[®] is a registered trademark of AT&T.

TELSTONE[®]

Here's Why Precision Visuals Is Now The Leader In Graphics Software Tools!

One Program Drives Many Devices

This single advantage can save you hundreds of hours of programming time. It enables you to use your hardware (both host computer and graphics devices) to its fullest. It protects your software investment against obsolescence and frees you from exclusive ties to hardware vendors.

Precision Visuals currently offers tailored interfaces for over 30 graphics devices from these companies: AED Applicon Calcomp Calcomp lookalikes Chromatics DEC Digital Engineering HP Houston Instruments IBM Imlac III KMW Megatek Printronix Ramtek Raster Technologies Sanders Selanar Servogor Tektronix Tektronix lookalikes TI Trilog Versatec Visual Technology Zeta.

They Run On Most Popular Computers

Including IBM, VAX, PRIME, Hewlett-Packard, CDC, Honeywell, Data General, DEC 10/20, Harris, Univac, Cray, and DEC PDP-11.

Precision Visuals software tools require a surprisingly small amount of computer resources. Even on smaller machines they provide access to the full capabilities of the CORE graphics standard.

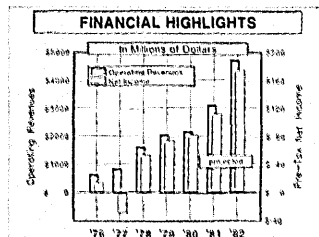

Make better decisions, faster, using GRAFMAKER's specially-placed annotation and color.

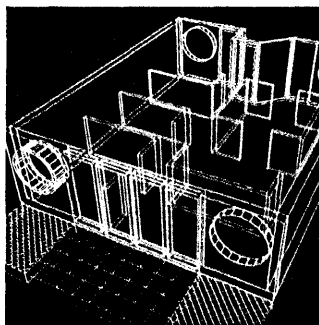

Build highly interactive computer-aided design applications with the DI-3000 core system.

Rich Capabilities Mean Limitless Applications

Precision Visuals software tools are proven in applications such as computer-aided design, business graphics, process control, mapping, geological data analysis, document layout, plus many specialized applications. System integrators (OEMs) use them as the graphics nucleus in turnkey systems and as the graphics component of database management and financial modeling systems.

\$12,000 For Our Most Popular System

DI-3000™, the core system, starts at \$8,000 and goes to \$12,000 for our most powerful and best-selling level. Add \$6,000 for GRAFMAKER™, the business presentation specialty system, and you'll have one of the most versatile graphics systems available at any price. Other popular options include the METAFILE SYSTEM for a device-independent

picture library, and our new CONTOURING SYSTEM for advanced surface graphics.

These are single-CPU, end-user, U.S. list prices. Multiple CPU and OEM discounts are also available.

Find out how Precision Visuals graphics software tools can open a new world of flexibility, economy, and standardization for your graphics applications. Call us at 303/530-9000.

"At Martin Marietta, DI-3000 serves as a common interface between our numerous graphics devices and software applications. We use DI-3000 for applications including structural analysis, business charts, graphs, animation, 3D modeling, and general-purpose graphics."

Karin Bruce
Senior Graphics Software Engineer
Martin Marietta Denver Aerospace



Precision Visuals

6260 Lookout Road
Boulder, Colorado 80301 USA
303/530-9000
TELEX 45-0364/TWX 910-940-2500

Amsterdam: Ponder Associates
Phone 030445352 / TELEX 70634
Sydney: Techway
Phone 02920858 / TELEX 27987
Tokyo: Nichimen Company Ltd.
Phone 032775017 / TELEX 22329
Zurich: Computer Graphix AG
Phone 019323482 / TELEX 875447

CIRCLE 26 ON READER CARD

NEWS IN PERSPECTIVE

cos is badly underestimated," Bain told the conference. "If the top 1% of users go to bypass and the phone company loses 50% of its revenue, it can't get that back by raising prices 100%."

Not only that, once the bypasser goes, he doesn't come back.

"You don't get the bypasser back," admits a telecommunications manager for a Fortune 500 company in the Midwest. "At least not on that particular link. They might get me back on some other link. But I'm not going to go back and throw in 24 tie lines and saw down the [microwave] towers. They work. They're doing a beautiful job."

Indeed. Fed up with what it considered poor service and tie lines that never became untied, this same company erected a 24-channel microwave system in September 1980. Sixteen of those channels are for voice, two are for data, and six are reserved. The 15-mile system was cost justified in two and a half years. Flush with success, the company two months ago installed a second set of towers five miles apart in a different location.

There's plenty more from where this came. Although this particular company has no immediate plans for expansion,

"The interest of investors is to get something in place as quickly as possible that makes economic sense," notes one Wall Street observer.

other corporations are seriously examining bypass technologies such as satellite, cable-phone, cable television, teleports, cellular radio, fiber optics, and dataphone digital service (DDS).

Some of these corporations are bigger than some sizable telephone companies in terms of traffic use. So what they want, they'll get. If that means bypassing the telco local loop with the assistance of the telco, so be it. If that entails throwing up their own microwave towers or buying a rash of cellular radios, that's okay, too.

But that won't be kosher with the phone company. Under economical bypass, they'll certainly survive and quite probably prosper. But faced with an endless series of uneconomical end arounds, they'll have to call a forfeit.

"There are four reasons to go bypass," the telecommunications manager says. "First, you get high-quality service all the time. Second, you control the system yourself. Third, you can plan for backup, have the ability to build in extra slots, and expand in five minutes, not five working days. And fourth, you can save a hell of a lot of money. And that's figuring in no rate increases from whatever time you do it."

Despite Congress's attempts to tax bypassers nearly to death, a few extra bucks won't matter to a company rich enough to go its own way. Instead of doing it "eco-

nomically," they'll bypass "uneconomically."

"That's going to be very beneficial to the technology, but three groups are going to suffer," Lucas says. "The public will be denied the lowest-cost service in the long run. The country will be hurt substantially because technological advances will be totally centered around bypass technology. And the local telco will be denied new markets, limited to being a plain old phone company, and won't be able to modernize because they won't have the money for it."

"The interest of investors is to get

something in place as quickly as possible that makes economic sense," Bain says. "That's a lot closer to what the FCC is doing than to what Congress is doing."

"There really are only two choices here. You either put in a reasonable access charge or tax bypass usage. That would mean more regulation, not less. And how is Congress going to enforce that tax? Do they really think they're going to go out and get a bypass police force to check on who's using the public network when they're not supposed to be?" Probably not. At least it hasn't been written into either piece of leg-

SUPPORT SYSTEMS

"Deluxe System/3 creates the ultimate environment by continually analyzing its own data base"

"Who makes it?"

"Who else?"

COMPUTER

isolation. But even if it were, that wouldn't stop people from bypassing. If it's only economical, expect a flow. If Congress gets its way, look out for the flood.

But hear this word of caution before you run to the nearest microwave vendor and buy up next year's inventory.

"One of the things that should not escape the person looking at bypass is that bypass by its nature means that when you start owning your own telephone equipment you start to take over the responsibility that Bell had—or somebody had—to keep that network running smoothly," the man from

the Midwest warns.

"The good news is that you're rid of those buggers and all their screw-ups. The bad news is there's no one to point the finger at but you. We don't get our number called when we score. We get it called when there's been a personal foul or a penalty. That's a real important reality," he concludes. "You don't have anyone to blame. You can blame the vendors, but you picked them. You didn't pick Bell. You were stuck with them."

You're not anymore. Just run the end around.

SOFTWARE

COMSERV DOES ITS BOOKS

The manufacturing software company has been in the center of a storm over how software development should be accounted for.

by Jan Johnson

It's hard to understand how Comserv Corp., a typically low-key, midwestern company that produces top-notch manufacturing software products, has managed to entangle itself in so many controversies.

To begin with, Comserv is an ardent supporter of the suspect accounting practice of capitalizing software "construction" costs, suspect in that the financial community finds the practice less "clean," less straightforward than the more common practice of expensing construction costs. When capitalized, construction costs are spread over several years' income statements—often four to six years—as an amortized expense. When expensed, the cost of construction is treated as an expense in the year it occurs.

This past summer the Securities and Exchange Commission called for a moratorium on the practice of software capitalization. The upshot was that current users, including Comserv, were allowed to continue capitalizing (IBM, ITT, and Anacomp are also practitioners). But that was it. Everyone else had to go with or stay with expensing. The action smudged Comserv's credibility in the eyes of the financial community.

"Some investors have the impression that the SEC put its foot down because software companies have been wickedly abusing capitalization. Nothing could be further from the truth," observes Curt Monash, software industry analyst with Paine Webber Mitchell Hutchins Inc. Monash and others in the investment community say there have been no documented abuses of capitalization for a decade.

Comserv may be vindicated sometime next year when a special task force of the Accounting Standards Executive Committee (AcSEC) is expected to come out in favor of capitalizing. The task force will advise AcSEC, which will advise the Financial Accounting Standards Board (FASB), whose opinion the SEC is expected to adopt, explains Monash.

"I think most people would agree that the current accounting literature pro-

BY LIEBERT

and won't waste an ounce of energy!"

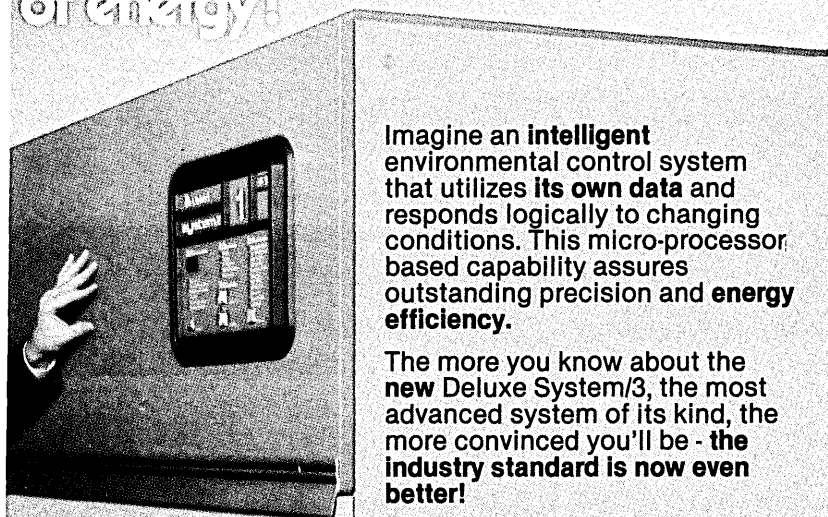

Imagine an intelligent environmental control system that utilizes its own data and responds logically to changing conditions. This micro-processor based capability assures outstanding precision and energy efficiency.

The more you know about the new Deluxe System/3, the most advanced system of its kind, the more convinced you'll be - the industry standard is now even better!



Liebert

World leader in computer support systems

Liebert Corporation, 1050 Dearborn Drive,
P.O. Box 29186, Columbus, Ohio 43229
Phone 614-888-0248 Telex 248655 LIEBERT WOGN

Tell me more about the new Deluxe System/3!

Name: _____

Title: _____

Company: _____

Address: _____

City: _____

State: _____ Zip: _____

Phone: _____ DTM123

Have a salesman call.

CIRCLE 17 ON READERCARD

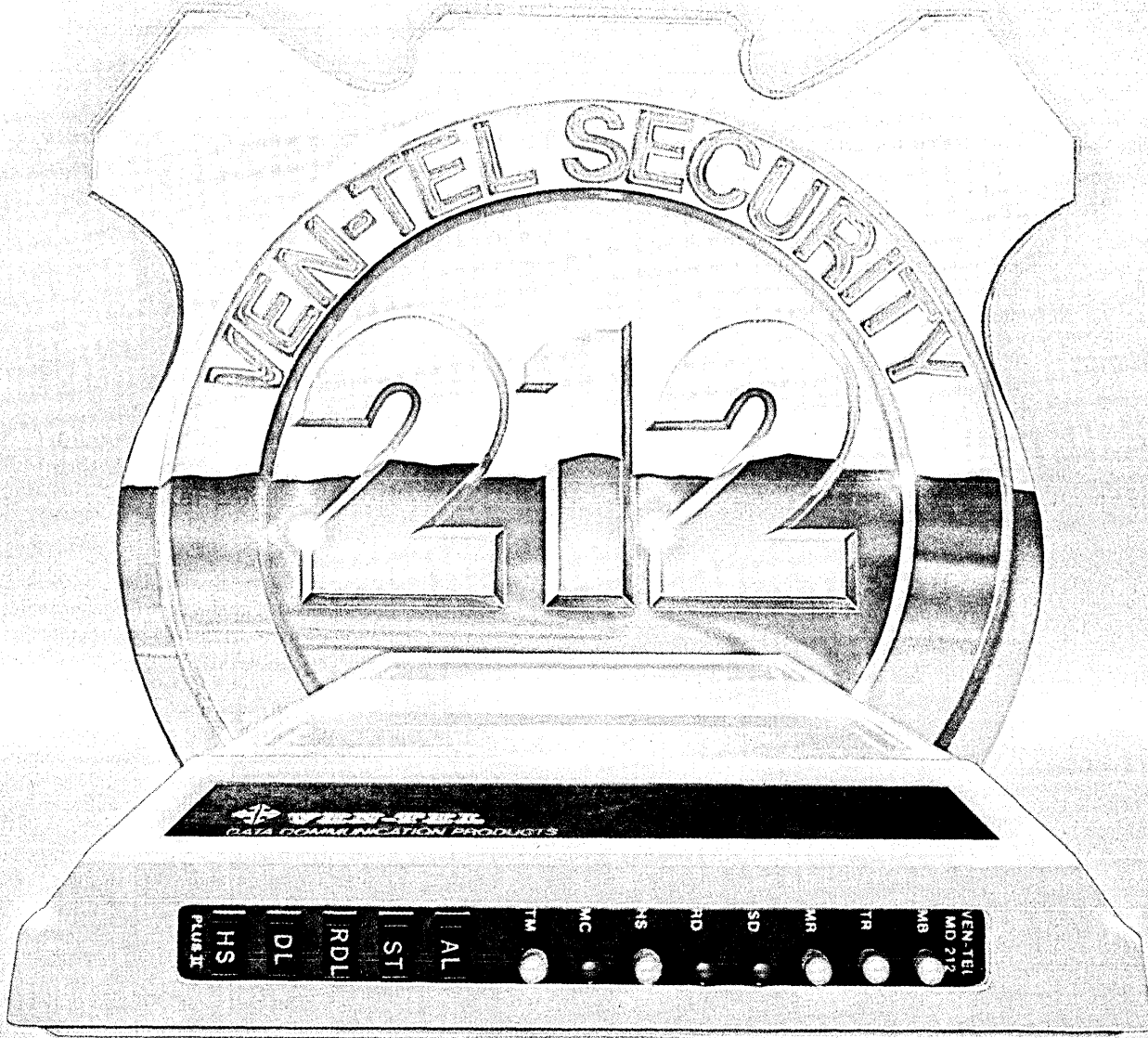

SECURITY

Protect sensitive information with Ven-Tel's 212 SECURITY PLUS. Password restrict any terminal to calling only the destinations and applications you authorize. Telephone numbers, passwords, account numbers, and log-in codes are concealed to prevent unauthorized disclosure or use.

Ven-Tel security is not limited to password protection. You are secure in the confidence that your Ven-Tel modem is the most reliable and dependable in the world.

Security is the assurance that Ven-Tel has committed the investment in research,

development and production facilities necessary to continued industry leadership and provide off-the-shelf delivery.

Security is knowing that the modem you buy from Ven-Tel is the most modern, technologically advanced product available on the market today. It is knowing that when you need help, a Ven-Tel technical support specialist is as close as a telephone call. It is the confidence that Ven-Tel will be there with service and support for your equipment as long as you own it.

For information call: (800) 538-5121.

CUSTOM & OEM CONFIGURATIONS AVAILABLE



Ven-Tel 2342 Walsh Avenue, Santa Clara, California 95051 (408) 727-5721

CIRCLE 28 ON READER CARD

NEWS IN PERSPECTIVE

vides the opportunity for people to capitalize." comments Joseph Lhotka, chairman of the special ACSEC task force wrestling with the software accounting issue. "I don't see us changing that. I think our job is to define more precisely when in the process of construction of software the costs become eligible for capitalization." When not chairing the task force, Lhotka works as partner and director of the accounting and auditing firm of Clifton Gunderson & Co., Denver.

In September, Comserv stumbled into yet another accounting controversy. During a routine quarterly audit review, conducted in conjunction with its auditors, some discrepancies turned up: \$1.7 million reported as fourth quarter '82 revenues should have been reported in 1983.

This was not a case of phantom sales. The sales were real and backed by signed contracts. The problem was traced to some field salespeople who made side deals with customers to accommodate the customer's desired delivery dates. Problem was, some customers did not want to take delivery until 1983.

While sorting out what happened and what to do about it, short-term Comserv president Ted Priem had a "disagreement" with the Comserv board over whether to restate earnings or not. Priem, who succeeded Richard Daly in the post of president in May, left in September. Daly then resumed his function as president in addition to chairman.

The point of confusion is a classic issue within the software industry—when to recognize revenue. Most companies take revenue when they have a signed contract, says Daly. Daly indicates that he leans toward policy, but until he gets more guidance from ADAPSO or related boards on this



RICHARD DALY: Predicted sales turnarounds that never materialized, disappointing Wall Street analysts.

matter, Comserv will take revenue when it has a receipt from an independent shipper.

While Comserv appears to be winning on at least one accounting front, a far more serious situation has arisen in its bread-and-butter business, that of selling \$300,000 manufacturing software packages, trade named AMAPS/Q, to large corporations. Sales have taken an alarming downturn. First quarter 1983 sales were \$3.6 million compared to \$5.4 million in first quarter '82. Second quarter '83 sales were \$4.5 million, compared to \$6.2 million in '82.

Comserv's management aggravated an already bad situation by grossly missing its mark when forecasting 1982 and 1983 sales and earnings. Several times in 1982 and 1983, Richard Daly predicted a sales and earnings gain or turnaround, only to see the company suffer a drop and a loss when the numbers came in. Management's credibility took a nose dive.

"Daly should not make projections," states Henrietta de Veer, vice president of corporate finance at Cralin & Co. Inc., a New York investment bank. "To have the numbers come out so different

No other limited distance modem goes this far and this fast over such a broad range of user-selectable bit rates.

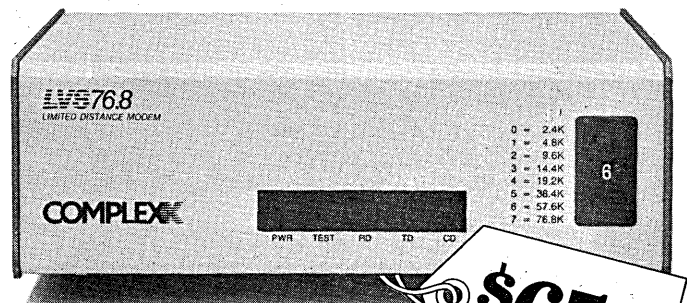

At any price.

The Complexx LVS 76.8 LDM uses a proprietary modulation technology developed for Complexx's XLAN™ local area network products to transmit a broader range of data rates further than previously available products. This modulation and bus transceiver design (for which a patent is pending) provides a simple and reliable method for synchronous data transmission.

This LDM is also unique in providing switch selection of Bell 43401 mode or "private cable" mode for transmitter power/bit rate output envelope. In the Bell 43401 mode, selectable bit rates from 2400 to 9600 are transmitted in complete compliance with Bell requirements. In the private cable mode, selectable bit rates from 2400 to 76.8 K bps are transmitted at a higher power level to permit greater transmission distances for such applications. Tail circuit 56K bps DDS applications are accommodated via external clock slave operation.

The LVS 76.8 operates in half- or full-duplex, multi-drop polled, or point-to-point configurations with common RS-232C interface. So select the application and select the bit rate. All it takes is a flip of the switch.

Why the LVS 76.8 limited distance modem from Complexx? Power. Performance. Price.

See your local dealer or contact Complexx Systems, Inc., 4930 Research Drive, Huntsville, Alabama 35805. 205/830-4310.

COMPLEX

NEWS IN PERSPECTIVE

from the projections is painful. It will probably take the stock two or three years to recover. People don't forget."

Explains Daly: "We were selected on all these contracts, but they were not getting signed off. A year and a half ago, a division of a major company could sign a deal and pay for the \$300,000 contract. Now, a \$500,000 deal needs four signatures and we would have three of them toward the end of a quarter. We had a heck of a time forecasting."

Comserv claims it is taking steps to improve planning and forecasting. A for-

malized reporting process that originates in the field is being put in place "to ensure more grass-roots involvement in the strategic planning process," says Gary Paradise, Comserv vice president, corporate marketing and communications.

The recession, says the company, has caused the slowdown in contract closings. Like other companies selling capital goods to heavy industry or discrete manufacturers, Comserv claims its clients ran out of cash for capital investments, and purchase authorization was kicked up to the director level.

"Decisions were going all the way to corporate, where they had to compete with other needs. We might be selected, but there was a question about when the division would get its money to buy the selected product," explains Daly. Comserv executives see the sales downturn as "short term." When the recession backs off they expect a sales pick-up.

Industry analysts are not so sure it's that simple. Competition has heated up in Comserv's traditional marketplace and the game has become more marketing driven. Competitors to be reckoned with include IBM, Martin Marietta Data Systems, Arthur Andersen, Rath and Strong, MSA, and Cullinet.

No one is questioning the quality of Comserv's product and services. On the contrary, for the past two years Datapro has ranked AMAPS/Q as the top mainframe-based manufacturing software package. And Comserv continues to be recognized as the leader in providing training and education for its packages. What is being questioned is Comserv's marketing abilities against aggressive powerhouses like MSA and Cullinet. "When you ask [Comserv

"I think most people would agree that the current accounting literature provides the opportunity for people to capitalize."

management] if they are worried about those two, they say: 'We have better products than they do,' " remarks Paine Webber's Monash.

Comserv counters that it has been taking steps to compete in a changing marketplace. To cope with clients' cash problems, Comserv instituted an extended payment plan, reflected on its balance sheet as "unbilled receivables." Under the plan, payment can be spread over six to 12 months.

Comserv also slacked off its traditional one cpu-one price strategy. Now the company supports a national accounts program that allows salespeople to negotiate a pricing scheme for multisite clients, said Daly.

Another new direction within Comserv is niche markets. AMAPS/G, a product focused at government contractors, is a prime example. It's a standard version of the traditional AMAPS/Q package, but enhanced to accommodate special reporting and tracking requirements of government contractors.

More important, AMAPS/G was a joint development effort involving six current AMAPS/Q users and Comserv staff. Special interest groups within Comserv's user community are encouraged to band together into development teams, called guide groups, to codevelop new niche products. But there is a catch. It costs money. Each

Marketing Representatives: Who Will Manage Your Income In 1984?

At MSA, our Marketing Representatives manage their own income because our commission plan is designed for the money motivated superstar who wants no limitations on earnings.

MSA is the recognized leader in Applications Software. We design, develop, market and support a complete line of Human Resource Management, Financial Management and Manufacturing Systems. Our products are used by large and medium size organizations throughout the U.S. and internationally. We have grown successfully and profitably at an annual rate of 35 percent during the past 10 years. Our high visibility in the market is exceptional and our future is bright.

Because of our dynamic growth, we are interested in talking to professional Marketing Representatives who are overachievers. If you are an individual whose performance has earned you a position in the top 10 percent of your company and you have a strong desire to accelerate your career growth and earnings, you should talk to MSA.

• Our constant growth offers a fast track to high potential professionals who want to move into positions of greater

responsibility in the future. Management opportunities are created by our growth and our policy is to promote from within.

• Quota goals are realistic and achievable with generous bonuses and accelerators built into the plan. Quota is not "adjusted" during the year and there are no "caps" on earnings.

The ideal candidates for these positions are presently highly successful selling computer services, computer timesharing or computer software. Opportunities to join MSA exist in major cities throughout the U.S. and Canada.

If you are the kind of professional we are looking for and **you want to manage your own income in 1984**, call and talk with Pat Blake, Manager of Corporate Recruiting, in Atlanta at (404) 239-2000 or send your resume to:

Pat Blake
Manager Corporate Recruiting
Management Science America, Inc.
3445 Peachtree Road NE
Atlanta, GA 30326

MSA

The Software Company

NO AGENCIES PLEASE
Equal Opportunity Employer M/F

DEFENDER II.

The Next Generation Dial-Up Computer Access System.

Preventing unauthorized telephone access to your computer while managing the growth of dial-in capability in your organization has never been easy. Until now!

Introducing Defender II: The next generation.

Defender II provides a unified approach to the intelligent management of dial-up modems on your computer site. Any number of Defender IIs can be configured with up to 48 modems each, and all may have their access controlled through centralized back procedures. This means security for yourself and more importantly, for the information in your computer.

Each Defender II modem is monitored on a continual basis. All transactions are reported (to a printer, terminal or/and computer), including telephone call origination and termination times, duration of call, supervisor access and more. This, combined with our least cost routing technique, brings computer phone line costs back under your control.

Moreover, by utilizing Digital Pathways proprietary, bus-controlled 212A modems, Defender II offers something totally unique: the ability to automatically send messages to a prioritized list of phone numbers — especially useful for distributing computer status information, providing maintenance alerts to sales forces or any other cross-site output message. This computer-independent messaging provides an invaluable tool in computer down situations.

If you'd like to know more about how Defender II can help solve your dial-up computer access problems, call or write today for more information.

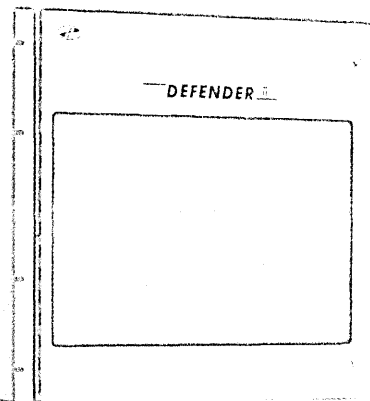

DIGITAL PATHWAYS

1060 East Meadow Circle
Palo Alto, CA 94303
TEL: (415) 498-5544
TWX: 910 379-5684

United States Headquarters
(415) 498-5544

Western Regional Office
(415) 498-5544

Eastern Regional Office
(617) 252-7744

Canada Office
(416) 498-5544

NOW!

- Dial-Up/Call-Back Security.
- Control Of Phone Line Costs.
- Ability To Broadcast Messages.
- Bus-Controlled 212A Modems.
- Prioritized Call-Back Queuing.



to automatically search feeds, so once some of the more important data is extracted for emphasis. And for more graphics emphasis there is also the capability for printing in color.

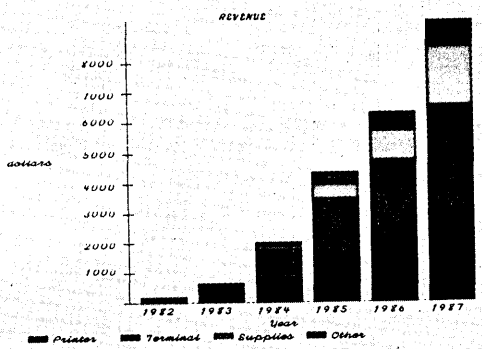

Dual 16-bit microprocessors provide the power needed for high-quality, high-resolution color graphics at 360 dots per inch. The Envision 420's use of four color ribbons, which can be independently replaced, greatly extend ribbon life while providing crisp, sharp multicolor printing.

Envision 651 River Oaks Parkway, San Jose, CA 95134
Printed by the Envision 420 Color Printer

BUSINESS - This segment is broadly defined as applications that convert data into a chart or graph for data analysis, presentation, or a report. Currently, the dominant user groups are technical people who use graphs as tools in their everyday work. It is this group that has written most necessary software which enables non-technical users to begin to use business graphics.

- CAD / CAM
- PROCESS CONTROL
- OTHER



The Computer Graphics Market

The main theme of the book is the importance of having the single state. Similarly, state 3D becomes (n = 3), the D signifies

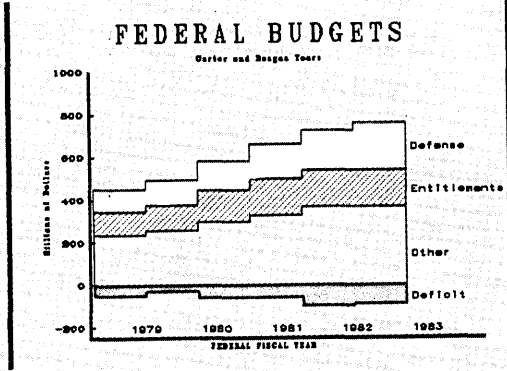

2P
28
Fine structure of the n = 01 HYDROGEN

We return now to our original theme of the state state, obtained from J = 0. That is the implication of moments associated with L.

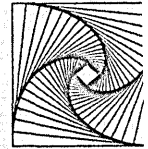

RED HOT DEMO. SEE THE NEW ENVISION 430. IF ITS NOT MORE THAN A COLOR PRINTER, IT'S FREE.

You really can't lose. Because if we can't prove our new Envision 430 Color VectorPrinter™ is more than a color printer, we'll give it to you on the spot. Free.

WHAT YOU DON'T KNOW

What you might not know is that our new 430 has the uncanny ability to print high resolution pen plotter graphics. It can do that because we designed vector-to-raster conversion right into the printer.

And to make our 430 that much better than any other color printer you can buy, we also gave it the ability to print 100 characters per second in letter quality mode or 300 characters per second for drafts. This means our 430 gets your work done a lot faster. It also means you can print high speed drafts, letter quality text, high resolution raster graphics and plot vector graphics—on the same page! So when you buy our new 430, you're really getting four very usable talents in one very versatile printer.

A VERITABLE PARADISE OF COLOR

Even if you're not a Van Gogh, our new 430 gives you the ability to create inspired color graphics. It prints any four colors of red, green, blue, cyan, magenta, yellow or black in a single pass. You can also blend any of these colors to create an entire spectrum.

And because a one-eighth inch solid color band is printed on each pass of the 18-wire printing head, our 430 creates your masterpieces with incredible speed.

UNCOMMON VECTOR/RASTER GRAPHICS

We made our 430 compatible with the Hewlett Packard 7220 pen plotter. That means it's supported by a host of business, engineering, and scientific graphics software packages. And it gives you printed quality that's nothing short of superb. As well it should. Because we designed our 430 with exceptionally accurate horizontal and

vertical registration. It also prints raster graphics at 360x144 dots per inch for the highest resolution or 72x72 dots per inch for maximum speed. And to give you added flexibility, we gave our 430 the ability to print on plain paper and transparencies.

LETTER QUALITY MAGNA CUM LAUDE

When you begin using our 430 you'll quickly discover you don't have to be a wordsmith to create letter quality documents with punch. Any of the character fonts can be mixed or colored using host computer control.

WORDS, 4444 (characters), lines or pages CAN BE PRINTED in any of EIGHT COLORS. One letter quality font in 10, 12, and 18 PITCH and one high speed font in 10 and 12 PITCH ARE STANDARD. This means you can make MESSAGES STAND OUT. You can COLOR specific words or IDEAS.

And our 430 comes with optional letter-quality character fonts like **BOLD**, *italic*, *SCRIPT* and *ORATOR*. Plus you

example, any P state has
 $1/2 = 1/2$, so that inst
 $3/2$ and $2P/2$.
 $1/2$. The 3 means shell 3
 $l = l - s = 2 - 1/2$.

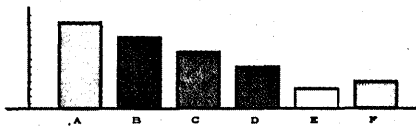

The Envision 430 VectorPrinter uses four separate color ribbon cassettes. Each cassette is advanced only when actually being used for printing, and can be replaced independently reducing printing cost while providing sharp, crisp multicolor text and graphics hardcopy. Fabric or mylar film ribbon cassettes are available in black, red, blue, green, yellow, cyan, and magenta.

The 430 prints graphics at 144 by 144 dots per inch resolution, and accepts graphics data either in raster format, or as VECTORS directly from the host reducing CPU and communications overhead.

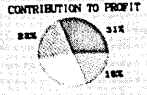
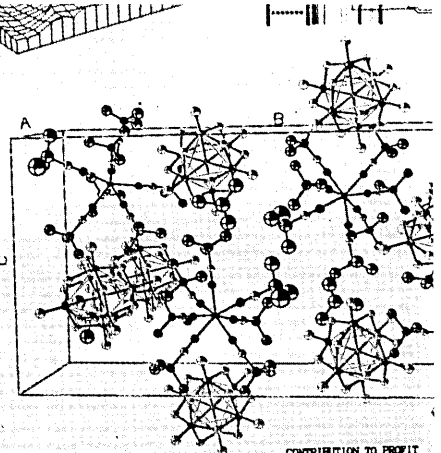
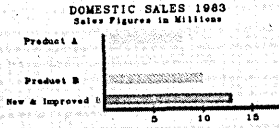
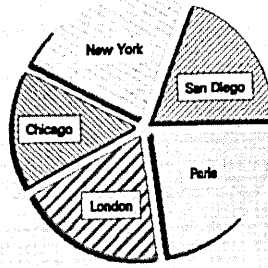
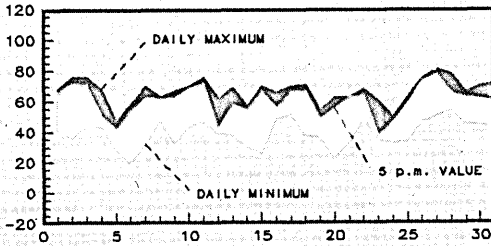

the electron spin effect
 ple, in the 2P3/2
 ite L and B are parallel.
 low that the magnetic dip
 id M_{el} are also parallel.

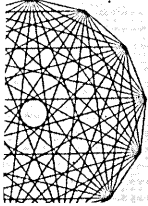

can define up to 196 characters to print both text and graphics. And to add versatility to your text creations we made our 430 compatible with the Diablo 630 ECS. Which means it supports the most popular text and word processing packages.

NO MORE RIBBON WASTE

Another nice little benefit of our 430 you won't find in other color printers is a four-cartridge ribbon system. Our separate color cartridges advance independently as each color is used. By doing things this way you don't end up wasting ribbon or running out of the color you want just when you want it. It also means lower cost per copy for you. Plus you also have a choice of high quality mylar ribbon cartridges and longer life nylon ribbon.

YOU DON'T HAVE TO PASS UP SPEED FOR QUALITY

Our 430 has been designed with an 18-wire printing head. This means that instead of having to pass over a line more than once to achieve high quality, our 430 prints letter quality characters in a single pass. It also does this with a great deal more speed because it never has to retrace the same line.

And while we're talking about speed, you should know we built our 430 with

a print control microprocessor which tracks the carriage through a unique closed-loop servo system and adjusts for carriage speed and direction during dot placement. That permits it to print while the carriage accelerates. Which is another reason it gets your job done a lot faster.



THE 430's UNFORGETTABLY EFFICIENT

If you tear down our 430 you'll find two 16-bit microprocessors. One of them controls the printing mechanism; the other takes care of the host interface and command interpretation.

They both share a 128K-byte bit-map memory. So while you're busily telling the 430 what to print next—it's busily printing what you told it to print last.

A RED HOT DEMO

We think you'll be impressed when you see our 430. But that's not enough to get you to pick up your telephone and call. So if we can't prove it's more than a color printer, we'll give you a 430. Free.

Show a little sporting interest and take us up on our offer. You'll get a red hot demo and a chance to buy a printer and a plotter. Send us the coupon or call. Envision, 631 River Oaks Parkway, San Jose, CA 95134, (408) 946-9755 or Telex: 176437.

Text and graphics samples courtesy of: ISSCO, Megatek, Molecular Structure Corporation, and Precision Visuals, Inc.

OK, ENVISION... PROVE IT TO ME. PLEASE CONTACT ME REGARDING A DEMO.

NAME _____
 TITLE _____
 COMPANY _____
 ADDRESS _____
 CITY _____
 STATE, ZIP _____
 PHONE _____



CIRCLE 32 ON READER CARD

Hewlett Packard 7220 is a registered trademark of Hewlett Packard.
 Diablo 630 ECS is a registered trademark of Diablo Systems.

D 12/83

1983. A Very Good Year.

**NCR introduced the 9300,
a roomful of computer
power in a 50-pound box.**

NCR closes out its first century with its most impressive technological achievement, the NCR 9300. It's the first full 32-bit VLSI mainframe designed for business applications. The 9300 delivers the power of a mainframe at the price of a mini.

VLSI, Very Large Scale Integration, really means very, very small. The technology for the 9300's micro-processor chip, developed by NCR's Microelectronics Division, put 70,000 electronic devices on a chip the size of your little fingernail. This VLSI technology serves as the catalyst for significant reductions in size and weight, increased reliability,

quick and easy servicing and dramatically improved price/performance.

This faster, more reliable computer does more for less. Even when you add a printer, disk drive, terminal and operating software to the 9300, you can have a fully configured 32-bit mainframe system for less than \$46,000. And the 9300's main memory is expandable from one megabyte to an impressive four megabytes.

The 9300 is in volume production now.

In 1983 NCR introduced more major data processing products than any high tech company. We wanted to get a good start on our second hundred years. For more information call your local NCR office, or 1-800-CALL-NCR. In Ohio, 1-800-543-4470.



The 9300 fits in anywhere you can fit a two-drawer file cabinet. You can even hang the NCR 9300 on a wall.

NCR

Shaping the way business
does business for 99 years.

CIRCLE 33 ON READER CARD



NEWS IN PERSPECTIVE

AMAPS/G group member paid \$160,000 for the privilege of participating in the development. A Comserv source estimates the company spent about \$8 million of its own money. The advantage to participants is that they get the product sooner and without paying the standard \$300,000 price tag.

From Comserv's perspective, the guide groups may serve as a safety net. As Comserv pulls back on project development funding, it is hoped the guide group will "pick up the slack," a Comserv executive explains.

The pull back, however, got started a little earlier than planned. When Comserv's financial situation began to seriously deteriorate in 1982, a hiring freeze was imposed in July of that year. That freeze marked a radical departure from the past. It was the first sign that Comserv was cutting back on product development. "The reason we reported a good year that year was because we did so well internationally," explains Daly.

No white knight appears in sight for 1983, however. Sales continued to deteriorate, so tight expense controls were enforced. Since Comserv does not expense software construction, the cutback had far less effect on the company's aggressive product development schedule than it would have had on a company that expensed all product costs.

In the past two months, cost-cutting measures became more severe and the specter of layoffs loomed everywhere. The company was taking another direct hit on product development—reducing people. One insider figures that about 100 positions were "reduced" during 1983, many by attrition, but increasingly by layoffs.

Next year Comserv's product investment program will officially slow down and the strain on the company's financial health may ease. "We are doing this a year earlier than planned," confides Daly, refer-

"To have the numbers come out so different from the projections is painful. It will probably take the stock two or three years to recover," one analyst says.

ring to a company plan put in place in 1981. Assuming sales come in as expected, Daly expects to move into a positive cash flow position this quarter. He expects to operate in a positive cash flow next year and fund product construction out of operations.

"You can't take a product construction program from \$2 million [1981] to \$8.5 million [1983] and expect to fund it out of operations. That is the crux of the whole thing," he states in defense of his negative cash flow management strategy.

The hope for 1986 "is that new product construction costs as a percentage of revenue will be about equal to what we are amortizing," says Daly. "Then the impact on the bottom line will be awash." That's assuming the company recovers its financial health.

Immediate cash infusions stand ready in the form of a \$12 million line of credit and \$13 million from a mortgage transaction on the company-owned, headquarters building. "It only cost \$12 million to build [which the company covered itself] and the land is worth about \$25 million," confides Daly. In addition, the company is selling its old building for about \$700,000.

Meanwhile, Comserv is not depending on its traditional product line and marketplace for health. It's diversifying into minicomputer-based products for medium-sized companies, and, down the road, into microcomputer-based products that could fit into a distributed shop floor environment. Comserv is also capitalizing on its training expertise, creating yet another new business direction.

Like Comserv, Ask has not been resting on its laurels. It too has pushed into new grounds. This month Ask begins offering a VAX-based version of its manufacturing package. "We've also added on-line documentation to our product," says Kenneth Fox, Ask vice president, R&D. "That

DEBUGGED.

ONE OF THE REASONS **UNIX*** SYSTEM V WILL BE THE NEW STANDARD FOR MICROCOMPUTERS.

Developed by Bell Laboratories over the last decade, UNIX System V incorporates over one thousand modifications and enhancements that were requested by users of previous releases. As a result, UNIX System V is an extremely high-quality production operating system. One that's been proven in use on thousands of CPU's.

Western Electric will continue to enhance and improve future releases of UNIX System V. From microcomputers to mainframes, UNIX System V will help you meet the demands of growth and change in the eighties and beyond.

Put UNIX Operating Systems to work for you. For more information on UNIX Operating Systems licenses, training or support services, write to AT&T Western Electric Software, P.O. Box 25,000, Greensboro, N.C. 27420 or call collect (919) 697-6530.

*Trademark of Bell Laboratories



Our software is bug-free because it's properly screened.

No matter how good a software product is, all it takes is one bug for you to get a bad reaction. That's why at On-Line Software International we screen our software very carefully.

The creators of our software go over it with a fine tooth comb. They make sure the software does everything it's designed to do and nothing that it shouldn't. Then our quality assurance group goes to work. Operating out of our data center, they search for bugs using InterTest, the most effective testing and debugging aid in the world. When they're confident that it's bug-free, the software is sent to test sites around the country. There it's put through

vigorous production use in actual business environments. Our software has to pass all these screening tests with flying colors before we release it.

Sure it's a lot of extra work. But at On-Line Software, we don't believe in letting bugs out of the house.



**ON-LINE
SOFTWARE**
INTERNATIONAL

Fort Lee Executive Park
Two Executive Drive, Fort Lee, NJ 07024
(201) 592-0009, Toll Free (800) 526-0272

NEWS IN PERSPECTIVE

move was really triggered by the fact that we were rewriting the package to run on the VAX." By year-end 1984, the two products are expected to contribute equally to revenues, "about neck and neck," speculated Fox.

Looking at Ask's strategy, some industry watchers worry that Comserv, aiming for the "technologically superior product," might be going for overkill. Observes Ask's Fox: "You have to have a simpler package for the small company. Rather than port down, you leverage your knowledge. Being oriented toward the smaller business, you have to remember they don't need as many options, they don't need as much capability. You don't want to make it too complex for them."

Comserv, however, claims it is targeting above the typical Ask user. In fact,

AMAPS/3000's introduction date slipped from June 1983 till this month because of "integration problems."

one Comserv executive hopes to see some Ask users grow out of Ask and into AMAPS/3000.

What about the future? The key question is where can Comserv fit in the automated factory? "I think the issue is the distributed factory," observes de Veer of

Cralin. "How much function will be based on the mainframe and terminals; how much will be distributed? I think companies like Comserv are going to have a hard time deciding how they are going to fit into the future factory."

"Distributed" at Comserv translates into microcomputers. Ideally, Comserv would like to get a guide group going to explore "distributed shop floor control systems." Already it has queried users on this subject. "We need, and so do our customers, to have a capability where we can distribute function," said Comserv's senior planning guru, Bowman. "There could be a data input device, like a bar-code reader, that sends data to a micro, which could have attached to it a database of information that came down from the host. Or you could have a work-in-progress file on the micro and have on-line data input and inquiry to the host. The micro could function stand-alone or be one or many workstations to a host. We are in the process of defining various directions now."

Ask is also thinking about ways of "carrying our knowledge forward onto micros," says vp Fox. Within two years, he expects to have either ManMan moved onto a smaller machine or to have an equivalent package on a smaller machine than an HP 3000.

"We are expanding our educational

products area into a general manufacturing educational series called The Manufacturing Series," says Daly. Comserv has already signed a deal with ASI, a large distributor of corporate education materials.

"They are going to include our product in their product library," Daly says. Comserv will receive royalties from the use of its product.

The great revenue source for the near term, however, is AMAPS/3000, designed for the HP 3000 and targeted at man-

Comserv is competing head on with Ask Computer Systems of Los Altos, Calif., which sells a very successful package called ManMan.

ufacturing companies in the \$20 million to \$60 million range. Comserv appears to be positioning the 3000 product slightly above Ask Computer Systems' ManMan product. It's higher priced and, generally speaking, aimed at larger companies, Daly claims.

Off to an ominous start, AMAPS/3000's introduction slipped from June 1983 till this month, because of "integration" problems. Integrating an outside purchased accounting package and redesigning the database for AMAPS/3000 took a lot longer than anticipated, explains Phil Logan, corporate vp, minicomputer products.

FLEXIBILITY.

ONE OF THE REASONS **UNIX*** SYSTEM V WILL BE THE NEW STANDARD FOR MICROCOMPUTERS.

UNIX Operating Systems are compatible with any vendor's hardware. So you won't be locked into any particular system. And while the hardware you buy today may become obsolete, your software will be reusable on any new equipment. This translates into real productivity improvements, since costly and time-consuming recoding of applications software is eliminated. With this flexibility, you can design a system using different models and even different brands of equipment. Something to keep in mind if you later need to update your hardware.

Sophisticated, multiuser systems developed by Bell Laboratories, UNIX Operating Systems are another example of Western Electric's commitment to quality.

Put UNIX Operating Systems to work for you. For more information on UNIX Operating Systems licenses, training or support services, write to AT&T Western Electric Software, P.O. Box 25,000, Greensboro, N.C. 27420 or call collect (919) 697-6530.

*Trademark of Bell Laboratories



NEWS IN PERSPECTIVE

Typically Comserv, the goal was a "technologically superior" product. The result is a good product, says one analyst who has seen it. It offers three modes of processing: real time; delayed processing, where the data is queued and processed in background mode; and batch processing. When a user needs help, there is on-line documentation. To accommodate beginners and more advanced users, there are, respectively, two forms of navigation: hierarchical menu screens and function keys. Pricing is between \$100,000 and \$150,000. "AMAPS/3000 has all the functionality of the mainframe product," and then some, claims Jerry Bowman, senior vice president responsible for business planning.

Do not confuse AMAPS/3000 with a previous Comserv product, the HP version of AMAPS, introduced in 1978 and sold through the existing mainframe-oriented sales force. AMAPS/3000 is a very different product, stress company executives. The company has also changed its sales strategy. "We thought our existing salespeople could handle it but it didn't turn out that way," says Daly. The mini product requires a top management sell instead of a manufacturing sell, he explains, so a dedicated AMAPS/3000 sales force has been created.

Comserv's prime competitor in the mini market is the well-established, healthy Ask Computer Systems, Los Altos, Calif. Not only does Ask sell its systems for less, it offers Asknet, a dial-up computer service running the Ask manufacturing software.

ADAPSO IN THE DESERT

Microcomputers were the topic of conversation as the software and services trade group met recently in Palm Springs, Calif.

by Edith Myers

Whoever first said "Plus ça change, plus c'est la même chose" could have been talking about ADAPSO, the software and services trade group.

ADAPSO's 59th Management Conference in late October in Palm Springs, Calif., was its largest ever, with 700 participants. Many said this was because of the "micro people." ADAPSO created a Microcomputer Software Association as a section at its 1982 Management Conference in San Diego, and the section had a major presence in Palm Springs.

Indeed, 12 sessions had micros as their primary focus, and the term inevitably came up in all the other 24. Microcom-

BROKE BUT NOT BEATEN

It's rare when an industry association pays tribute to one of its own who hasn't in the generally accepted sense "made it big."

The Association of Data Processing Services Organizations (ADAPSO) did just that at its management meeting in Palm Springs when, led by former president Bernard Goldstein, now with Broadview Associates, Ft. Lee, N.J., it paid tribute to Leonard Palmer, who had died a week earlier of cancer in San Francisco. Goldstein called it "a tribute to an entrepreneur."

Palmer, whose age at time of death was estimated by friends as "late 40s or early 50s," was president of ADAPSO in 1968. He was described by Goldstein as "a pioneer of the computer services industry." He died practically broke.

He got into the service bureau business in 1958, even before computers did, as a salesman for Statistical Tabulating Corp. Earlier, he had worked for the State of California Department of Motor Vehicles as a decollator operator, served in the Army, and worked with electronic accounting machines for both Dalmo Victor Co. and the San Francisco Naval Shipyard, where he trained as a programmer on the Univac I.

In 1960, Palmer was named western regional manager for Recording and Statistical Co., a subsidiary of Sperry Rand Corp. Palmer ordered a Burroughs B 260 card system for R&S, which was the beginning of a convoluted relationship.

He joined Burroughs in 1963 as national director of service center market activities and from there, inspired by a trouble call from a Burroughs salesman in Greenville, S.C., made his first entrepreneurial move. He took over an ailing service bureau in Asheville, N.C., and as president turned it into Computer Servicenters Inc., a nine service center operation with \$3.5 million in annual business.

In 1968, he left to form CompuTerminal in San Francisco, with ambitious plans to offer a full range of services, plus free program conversion, to small system

puters, once perceived as a threat by many ADAPSO members, now seem to be looked upon as an opportunity.

Edward I. Metz, senior vice president of Input Inc., a Mountain View, Calif., research firm, said an industry study his firm conducted for ADAPSO showed some firms still listing microcomputers as a threat to growth but behind such problems as turnover of employees, competition, and the economy.

On the other hand, he said, many companies surveyed put microcomputer products high on the list of keys to growth and major opportunities. ADAPSO members seem to be getting involved with micros for reasons as varied as the companies themselves. Remote service offerings are being

users for around \$5,000 per year. His network was designed to avoid long-line costs and dial-up and multiplexing problems. On Feb. 13, 1970 he signed a \$43 million contract with Burroughs, which was then called the industry's largest commercial computer sale ever. On the same day, he ordered 1,200 Cope terminals and 40 controllers worth \$70 million from University Computing Co.

These large orders brought him some attention at the time but not nearly as much as did his five years of litigation with Burroughs in which two separate juries awarded him more than \$3 million in damages in antitrust actions.

Palmer contended his former employer was in violation of the Sherman Antitrust Act in diverting its customers to a third service bureau when Burroughs abandoned the service bureau business in the San Francisco Bay area. Two juries agreed with him and awarded him first \$3.8 million in trebled damages and later \$3.48 million. It was money he never received. The awards were set aside by judges and, in February 1977, a final opinion by federal judge Charles E. Wyzanski determined, "not only did Burroughs not violate federal antitrust law but also . . . nothing actually done by Burroughs was a cause of even nominal loss sustained by CompuTerminal."

The experience left Palmer broke and in debt. "I've even lost all my credit cards," he said in mid-1977. It didn't dampen his enthusiasm for the service bureau business, to which he'd always hoped to return.

Palmer's final years were spent as a consultant, primarily to Control Data Institute. Toward the end of his two-year illness, Bernard Goldstein recalled, "he was redesigning a computer system for the hospital that was treating him as an outpatient. He was going to let them have it at no cost but he would retain rights to the software. He was an entrepreneur to the end."

expanded to include micros. Software firms are concerned, among other things, with micro-to-mainframe links. Systems integrators see micros as another candidate for integration.

Computer Concepts & Services Inc., St. Cloud, Minn., sees the machines as a foot in the door for the mainstream of its business. Monte Westphal, executive vice president of the central Minnesota firm, which specializes in the local government marketplace, said, "We see them [micros] as an easy entry into new areas. We have clients who are instituting micros, and if we don't help them someone else will."

For new customers, he said, "micros get us into a unit and allow us to expand. If a prospect is only interested in mi-

cross, though, we don't spend much time with him."

In a session on host-micro connectivity, Roger Mathews, manager of product marketing at the Systems Center Inc., noted that MIS managers are getting more involved in micro strategies. "You used to have to explain why the corporate MIS guy had to get involved. No more. Users used to be the driving force, but now it's corporate MIS. He [the corporate MIS manager] wants to control data processing power and access to the corporate network. It's becoming the distributed processing area, and that's not new to MIS. The personal computer is the ultimate distributed processor. With minis, corporate MIS had to write the programs but not with micros." Mathews said that he sees terminal emulation by micros as appropriate for the short-term micro-to-mainframe link. "We have to begin that way, but this does not move processing off the host. We want program-to-program communications so that related functions appear to a user as if they are one function."

Since the ADAPSO conference was held the same week as IBM's 3270/P.C. and XT 370 announcements were made, discussions of mainframe-to-micro linking abounded. Member reaction was generally positive. "IBM has blessed the concept," said one participant. Speakers at almost all sessions were asked their reactions to the

announcements, but all had "wait and see" answers.

While micro talk was ubiquitous at the conference, not everyone thought that micros were such a good thing. "We used to have to try to convince people of the importance of personal computers," said Peter Cunningham, president of Input. "Now there's an overemphasis on personal computers. You don't send a boy to do a man's job."

In an ADAPSO session titled "Industry Projections," Cunningham said information services, which encompass the

The meeting took place the same week as IBM introduced its XT/370 and 3270 P.C. products, which fueled further discussion.

offerings of all of ADAPSO's member companies, grew 77% more than the computer industry as a whole in 1982 and "probably is accelerating." He sees much of this acceleration coming from "a resurgence of innovation from the federal government."

On the surface it would seem that the Palm Springs meeting was a far cry from a two-hour meeting held in New York in April 1960 at which 10 men gathered to consider starting an organization of computer services companies. But was it?

Writing about the 1960 meeting in the March 1970 issue of DATAMATION, Jerry Dreyer, now president of ADAPSO, said: "Superficially, it would appear that a lack of commonality existed and that a divisive atmosphere might come into play. More likenesses than differences among the ADAPSO membership were discovered, however—likenesses and common interests that have endured." This would seem to be true today. There are certainly more differences but equally more likenesses as well.

In 1960, the fledgling association was called Data Actuating Technical Association (DATA). The name was changed to ADAPSO on June 22, 1960, and incorporation was accomplished in 1961 with 16 companies listed as members.

As the computer services industry evolved from the traditional data processing center concept, special sections were set up within ADAPSO. A timesharing section composed exclusively of timesharing companies was established in Dec. 1968 with five member firms.

A software section was slower in developing. "The slowness in the development of our software section is particularly vexing to us," wrote Dreyer in 1970. "We have solicited this important segment of the computer services industry on numerous occasions, and the results, as of this writing, have been somewhat disappointing. I

PORTABILITY.

ONE OF THE REASONS **UNIX*** SYSTEM V WILL BE THE NEW STANDARD FOR MICROCOMPUTERS.

Because of its portability to everything from microcomputers to mainframes, UNIX System V is the basis for standardized software. The modular design of UNIX System V, coupled with its "C" language base, eliminates expensive, time-consuming recoding of existing software on newly-introduced computer technology.

Developed by Bell Laboratories, UNIX System V is designed to evolve with your system in an orderly manner. The portability, power and versatility that Western Electric has incorporated into UNIX System V make it the system of choice.

Put UNIX Operating Systems to work for you. For more information on UNIX Operating Systems licenses, training or support services, write to AT&T Western Electric Software, P.O. Box 25,000, Greensboro, N.C. 27420 or call collect (919) 697-6530.

*Trademark of Bell Laboratories



AT&T
Western Electric

CIRCLE 34 ON READER CARD

The quintessential T-1 connection

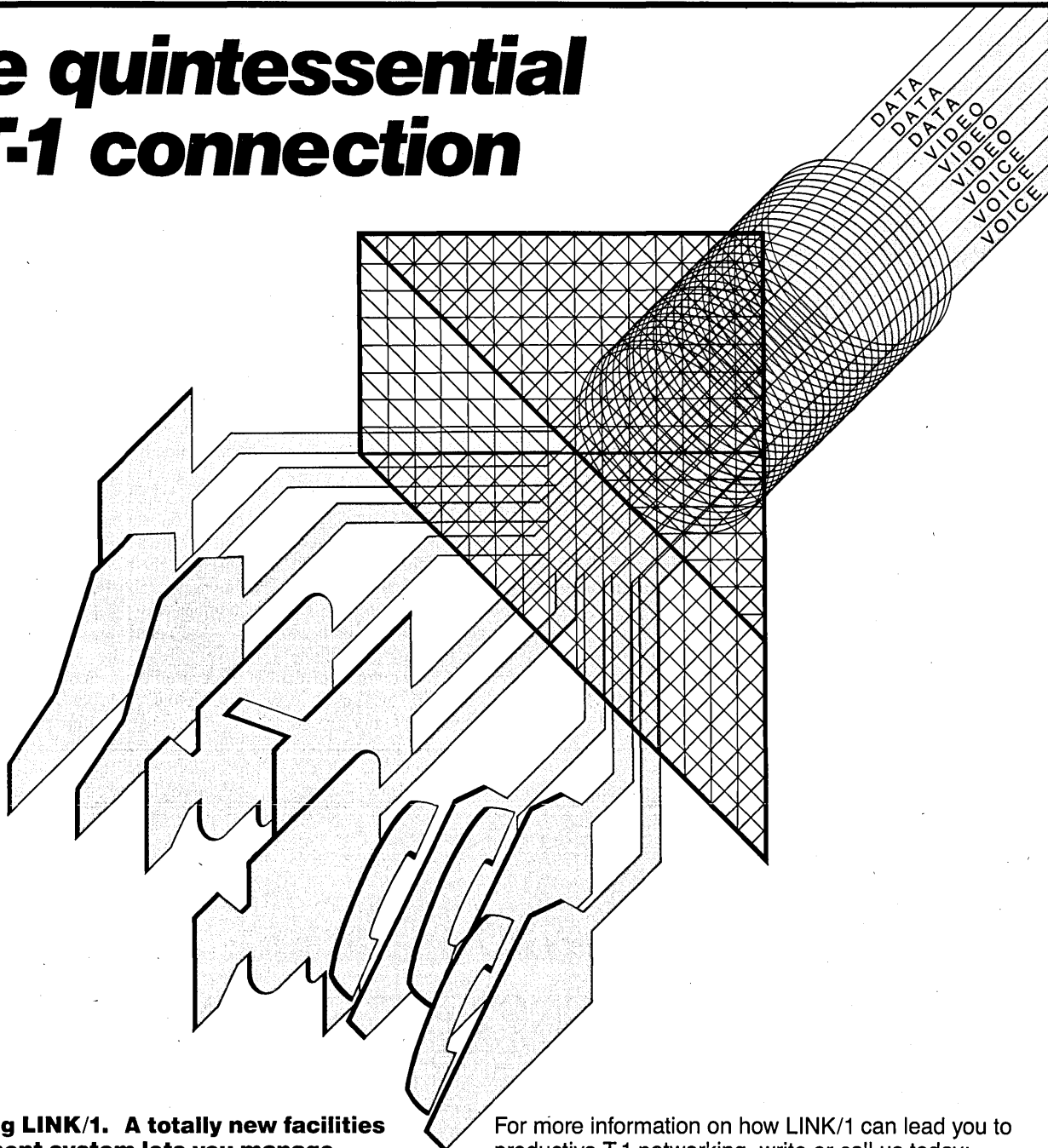

Presenting LINK/1. A totally new facilities management system lets you manage, multiplex and maintain combined data, voice and video networks sharing 1.54 Megabit T-1 transmission facilities.

When you plug the big T-1 pipe into LINK/1, you get single point control of a fault tolerant network... with full redundancy and multiple data link capability.

LINK/1 makes possible cost-effective, ultra-wideband networks and brings you closer to the true promise of future office services.

For more information on how LINK/1 can lead you to productive T-1 networking, write or call us today:
Timeplex, Inc./400 Chestnut Ridge Road
Woodcliff Lake, N.J. 07675/Phone: 201-930-4600
Attention: Corporate Communications

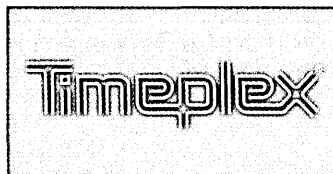

NEWS IN PERSPECTIVE

personally attribute the inadequate response to a surprising lack of cohesion and sophistication among too many of the software entrepreneurs, who seem to understand the mysteries of Wall Street better than the obvious merits of cooperation."

For a time, ADAPSO wooed the now defunct Association of Independent Software Companies (AISC) to join it as a semi-autonomous software division. This didn't work, but in October 1971, ADAPSO did launch a software section with 15 software house members. It has become one of ADAPSO's most active sections.

Today, ADAPSO has six sections: microcomputer software, processing services, professional services, systems integrators/oems, remote processing services, and software products.

Since many of the issues concerning the association transcend the sections, it also has a number of committees, including bank relations, CPA relations, vendor and industry relations, AT&T interface, IBM interface, domestic communications, government affairs, international relations, procurement, software protection, taxation, academic relations, compensation study, contracts, financial practices, and standards.

Some of the issues that might seem to be new are not. As early as July 1978, ADAPSO formed a mini-micro committee

"to address the concerns of the developing software products and turnkey system industry using micro and minicomputers." The issues the committee was to address were "marketing of software, software support, software protection, technology transfer and training, taxation, pricing, product standards, and user groups."

Back in 1968, ADAPSO attacked the software protection issue when it surveyed its members to find out how they were protecting proprietary software against misuse by customers and employees.

At the Palm Springs conference, Ron Palenski, associate general council, ADAPSO, told a software protection session that "there will be a lot of legislative and administrative activity in 1984 [on software protection], and ADAPSO intends to be involved." He noted that ADAPSO has a software piracy clearinghouse through which members are encouraged to exchange protection ideas.

Kennedy B. Dwight Jr., president, the Teleprocessors Inc., Houston, offered an alternative to protection, which he sees as creating an "us versus them" climate. "Look at their [software pirates] profiles. It's the same as for shoplifters." He said that retail merchants in the Houston area had successfully combated shoplifting by hiring an ad agency to develop a logo and slogan and conduct a campaign to promote

customer loyalty. He suggested software companies could try a similar approach.

ADAPSO general counsel Milton R. Wessel suggested this approach could be "antitrust sensitive."

Palenski called for "point, counterpoint. We should think of a multifaceted approach."

At a 1979 ADAPSO management conference, a major concern was Ma Bell. The worry then was that Bell would move aggressively into the software business.

In 1983, worries about Bell have focused on current and future costs. Don Fostle, a principal consultant with Input, said that in 1981 and 1982 "overall telecommunications costs for computer service companies increased two times as fast as operating costs." He told of one firm that netted out its telecom expenses and found that it would have increased its earnings per share by 21% without them.

As in 1960, ADAPSO is concerned with how it is perceived by potential members. Last summer it commissioned Input to study potential nonmembers with an eye toward determining why they hadn't yet joined. The study of 80 executives was completed in September. More than 70% of the interviews in the study were conducted at the presidential and vice presidential level. Input concluded there were several "significant" misconceptions about ADAPSO's

SYSTEM SUPPORT.

ONE OF THE REASONS **UNIX*** SYSTEM V WILL BE THE NEW STANDARD FOR MICROCOMPUTERS.

Western Electric's experienced support staff is backed by years of expertise with UNIX Operating Systems. Our "hot line" puts you in direct contact with this staff to keep your system up and running efficiently.

You also have access to an active problem reporting system, newsletters, and the latest updates on UNIX System V software documentation. This extensive support system from Western Electric and Bell Laboratories is one of the reasons UNIX System V is emerging as the new standard operating system for the eighties.

Put UNIX Operating Systems to work for you. For more information on UNIX Operating Systems licenses, training or support services, write to AT&T Western Electric Software, P.O. Box 25,000, Greensboro, N.C. 27420 or call collect (919) 697-6530.

*Trademark of Bell Laboratories



AT&T
Western Electric

CIRCLE 34 ON READERCARD

ONLY ONE SUPERMICRO KNOWS 13 LANGUAGES.

The keys to your success, now and for the future, are flexible systems with a breadth of languages that protect your software investments. These languages save you time, minimize effort, and give you a powerful tool, particularly useful for the many end users looking at updating their hardware.

Considering all this; consider the Pixel 80. Not only do we have a catalog of programming languages and developmental aids that is unmatched in the 68000-Unix™ world, we have a wide range of data base management systems, word processors, spread sheets, and ready-made applications packages.

HARDWARE POWER TO MATCH SOFTWARE POWER

A few hard facts:

1. The Pixel 80 has a multi-processor architecture. A 10 MHz Motorola 68000 runs the operating system and user programs. It can fetch memory as fast as a 68000 can go.
2. With up to 6 million bytes of no-wait-state RAM combined with hardware memory mapping, the Pixel 80 makes possible applications that could never before be run on a microcomputer.
3. Winchester and floppy disk drives combined with cartridge tape back-up and software file management techniques allow for flexible growth and expansion.

ALL THIS AND IT'S EASY TO USE.

Our Unix operating system includes Berkeley, PWB, and Pixel enhancements. It's powerful, portable and very, very friendly.

PIXELBASIC +	APL. 68000
MUMPS	FORTRAN-77
TOMBASIC™	C
LISP	PASCAL
SMC BASIC	TeleSoft Ada™
LEVEL II COBOL™	
RM/COBOL™	
SIBOL™	

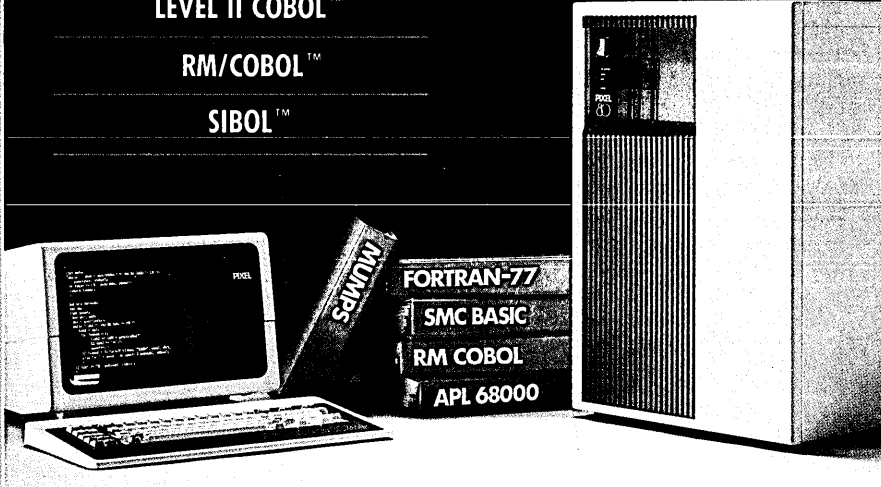

LOOK TO THE FUTURE.

Something to consider: while the Pixel 80 almost matches the VAX 780 in raw computing power, it is less than half its price. Yet, as attractive as our price/power ratio is, we maintain that the ultimate reasons for considering us are our unmatched range of languages and great software support. Because, when the technological fall-out has fallen out, the ones still standing will be the ones who know the most, and speak the best. With Pixel 80 you've already got a good jump on the future.

For more information, write Pixel Computer, Inc., 260 Fordham Road, Wilmington, MA 01887, or call (617) 657-8720.

PIXEL COMPUTER

LEVEL II COBOL is a trademark of Micro Focus, Inc.
RM/COBOL is a trademark of Ryan McFarland Corporation.
SIBOL is a trademark of Software Ireland, Ltd.
TeleSoft Ada is a trademark of TeleSoft.
UNIX is a trademark and service mark of Bell Laboratories.
TOMBASIC™ is a trademark of TOM Software.

KNOWLEDGE IS POWER.

NEWS IN PERSPECTIVE

orientation, including too much leaning toward large firms and too much concentration on remote and batch processing and on commercial as opposed to government emphasis.

The study showed that ADAPSO is best known by software products firms and least well known by integrated systems companies. Less than half of the integrated systems companies interviewed were familiar with the association.

Some surprising (to ADAPSO) individual comments came up in the survey. George Dougherty, president, Information Dynamics, said, "ADAPSO is self-serving to large processing firms and unable to help small businesses." Harvey Coleman, vice president of communications, Madic Corp., said, "ADAPSO serves processing more than software companies."

Peter Smart, president, Applied Microcomputer Systems, said, "ADAPSO services needs of large mainframe processors, not the micro software industry."

A most surprising comment came from Harold Newmark, director of corporate communications at Logicon, who thought his firm belonged to ADAPSO. When he learned it didn't, he concluded, "ADAPSO is not striving hard enough for membership."

Needless to say, ADAPSO is working hard to change these opinions.

DISTRIBUTED PROCESSING

WHO BELIEVES IN HEROS?

Mohawk Data Sciences has a new workstation based on N-Gen, but it also has a problem: who's paying attention?

by Michael Tyler

When Mohawk Data Sciences (MDS) introduced its Hero intelligent workstation to a skeptical audience in New York last month, the company's biggest problem became quite apparent: it—and particularly its largest component, the Systems Division responsible for Hero—suffers from a substantial credibility gap.

Here is a company, after all, that is bringing to market the first production incarnation of Convergent Technologies' touted N-Gen workstation, has integrated N-Gen into a comprehensive distributed processing strategy, and has given N-Gen the ability to access 3270 networks and a

proprietary electronic mail service, WINC.

But it is also a firm whose earnings have fallen for two straight years on small revenue increases, and whose performance through the first half of 1983 gives no indication that any improvement is around the corner. It is a company whose flagship product, the Series/21 eight-bit distributed processing system, has been on the market for over six years in an era in which product life cycles can be as short as 18 months. And it is a company whose new product announcements have in the past promised more than they delivered.

So it should be no surprise that many outside observers see the company as not much more than a peddler of obsolete data entry equipment. Indeed, several securities analysts, such as Carol Muratore at Prudential Bache and William Shattuck at Montgomery Securities, have stopped following the company entirely. "There's simply not that much to be excited about," Shattuck says.

The introduction of Hero, then, poses two significant challenges that the Parsippany, N.J., company must meet by the time Hero starts shipping in February. First, it must ensure that Hero, by itself, inherently makes the entire Series/21 system more competitive on a technical level. And, second, the company must convince users and analysts that the resulting product

PRODUCTIVITY.

ONE OF THE REASONS **UNIX*** SYSTEM V WILL BE THE NEW STANDARD FOR MICROCOMPUTERS.

Programmers frequently spend as much as 50% of their time recoding software to fit other vendors' hardware. But because UNIX Operating Systems are machine independent, your software isn't limited to one vendor's hardware. As a result, time-consuming recoding is significantly reduced. So newly introduced hardware can be set up and working almost immediately. Productivity is further enhanced because your software will operate with different pieces of hardware.

Designed by Bell Laboratories, the reliability and compatibility of UNIX System V will make your system more productive. Without adding to the cost of your operation.

Put UNIX Operating Systems to work for you. For more information on UNIX Operating Systems licenses, training or support services, write to AT&T Western Electric Software, P.O. Box 25,000, Greensboro, N.C. 27420 or call collect (919) 697-6530.

*Trademark of Bell Laboratories



AT&T
Western Electric

CIRCLE 34 ON READERCARD

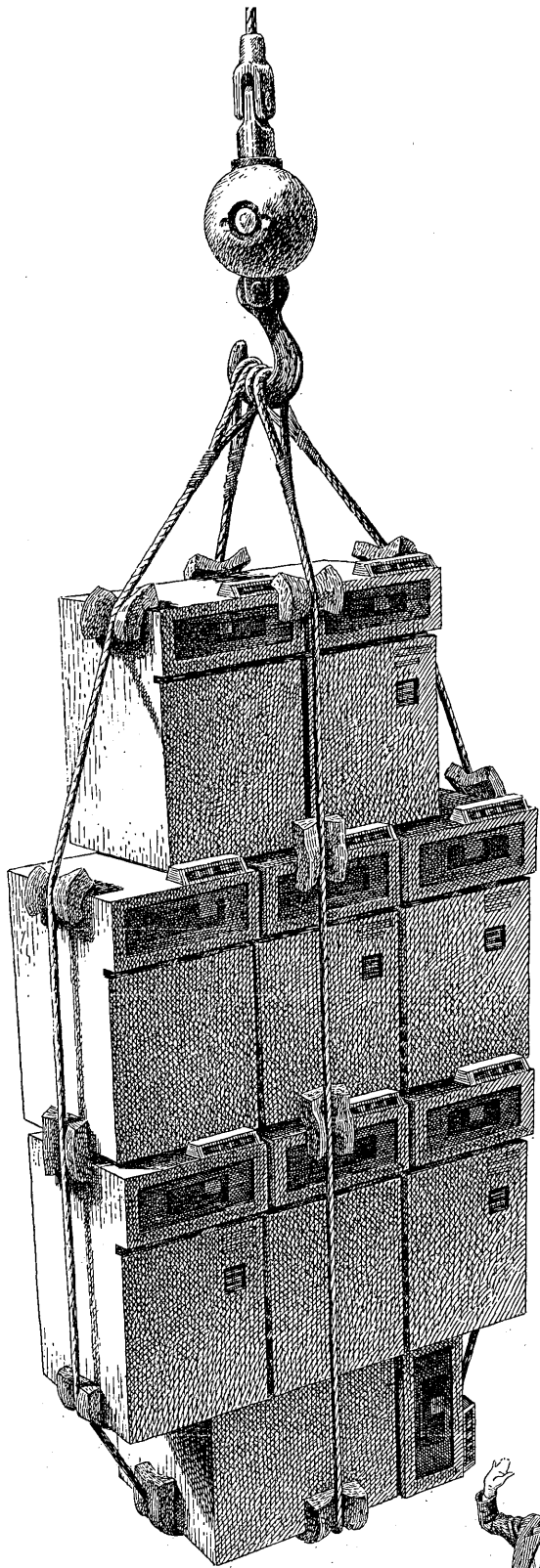

How to put 640 square feet of computer disk storage in a 7' x 3' space.

It's impossible to store all that data in such a small space using disk drives, even 3380 class. You have to use a different kind of data storage technology: Masstor System's M860 Mass Storage System.

The M860 stores data on-line at one-quarter the cost of disk... using less than 4% of the floor space. It automates tape operations making processing much faster and much less expensive.

The M860 is a third storage alternative for your IBM and other plug compatible mainframes. One that offers more on-line storage capacity for new applications and requires no conversion of your existing programs. If you have Sperry, Honeywell, DEC/VAX or CDC mainframes, Masstor Systems also has an M860 solution.

The M860 is just one of a family of Masstor Systems strategic products that allows you to store, share and move data efficiently and economically.

To find out more, contact Dave Ball at Masstor Systems Corporation, 541 Lakeside Drive, Sunnyvale, CA 94086. (408) 737-2500. And cut your data storage problems down to size.

MASSTOR SYSTEMS

Strategic solutions to storing, sharing and moving data.

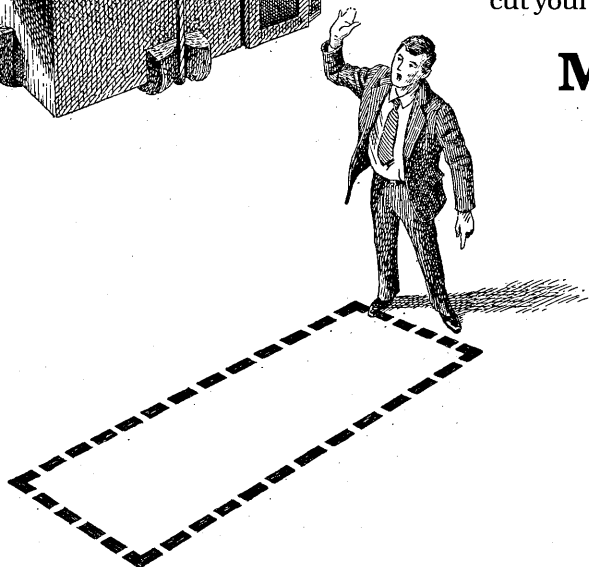

NEWS IN PERSPECTIVE

line really is "a clear alternative to IBM," as senior marketing vice president Brian Gaylord told a press conference.

Mohawk's technical challenge with Hero goes beyond producing a competitive electronic workstation; many other vendors have been selling similar products for over a year, and still others, such as Raytheon Data Systems, Prime Computer, and Four-Phase, will be selling the identical N-Gen product. In fact, Mohawk advanced the announcement date of Hero by two months to ensure that it would be the first to premiere a production version of N-Gen. The larger part of the challenge, then, is in using Hero to make the Series/21 competitive again.

The Series/21 was introduced in 1977 as an eight-bit distributed processor intended primarily for data entry. That was where MDS had been strong in the past, and at the time the Series/21 was indeed a technically strong machine. Says John McManus, an analyst with Bear, Stearns who has followed MDS for several years, "Mohawk Data had products that were competitive in the late 1970s, but no longer are. They have not been able to keep up with the changing technology."

Although the Series/21 has undergone a dozen enhancements since its debut, it is still an 8-bit system in a 16-bit world. And it is still a centralized system in an era of decentralized personal computers. Even



CHECKING IT OUT: Ralph O'Brien (left), chairman, and Robert J. Amman, president of the Systems Division, inspect Hero, Mohawk Data Sciences' new workstation, which is based on N-Gen hardware from Convergent Technologies. Mohawk hopes the new product will help it compete more effectively with IBM.

its Personal Computing/21 facility, introduced last May, is centralized; it merely provides users with access to CP/M programs through the Series/21 host. No

access to the dominant MS/DOS 16-bit applications world is available. As McManus says, "They still need an intelligent workstation."

Hero goes a long way to bringing the Series/21 up to date. As a standalone personal computer, it has a 16-bit Intel 80186 microprocessor running at nearly twice the clock rate of the IBM Personal Computer, up to a megabyte of main memory, a pair of serial ports and a printer port, a 98-key DIN-spec keyboard, and a 12-inch monochrome monitor with a 29-row by 80-character display. It runs Convergent Technologies' CTOS operating system in native mode, and can provide both MS/DOS and CP/M-86 emulation. (Neither emulation is fully compatible with the IBM P.C. because of differing screen and disk formats, however.) It also supports a pair of 5¼-inch floppy disk drives or a hard disk. A basic configuration costs \$3,000 without disks or \$4,500 with dual floppies, and a configuration similar to an IBM P.C. XT is tagged at about \$7,000.

While Hero finally gives Mohawk a standalone PC of its own, the machine's true value lies in the way it connects with the Series/21. The company announced a 16-bit controller board for the Series/21 cpu that allows eight Hero workstations to connect to the host. Another eight workstations can be either dumb terminals or Heros. The controller board, Mohawk's first 16-bit

UNIVERSAL.

ONE OF THE REASONS **UNIX*** SYSTEM V WILL BE THE NEW STANDARD FOR MICROCOMPUTERS.

As more and more computers and their applications software appear, the need for a universal software standard has never been greater. Universally known and accepted, UNIX Operating Systems are emerging as just such a standard. They have been part of university curricula for ten years. A large pool of computer specialists are not only familiar with UNIX Operating Systems, they are also sold on their power and capabilities.

Designed and refined by Bell Laboratories, applications of UNIX Operating Systems go well beyond the nation's telecommunications system. With the worldwide respect of an entire generation, Western Electric's UNIX System V is becoming the newest standard—the universal standard.

Put UNIX Operating Systems to work for you. For more information on UNIX Operating Systems licenses, training or support services, write to AT&T Western Electric Software, P.O. Box 25,000, Greensboro, N.C. 27420 or call collect (919) 697-6530.

*Trademark of Bell Laboratories

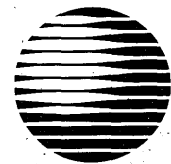

AT&T
Western Electric

CIRCLE 34 ON READERCARD

DECEMBER 1983 73

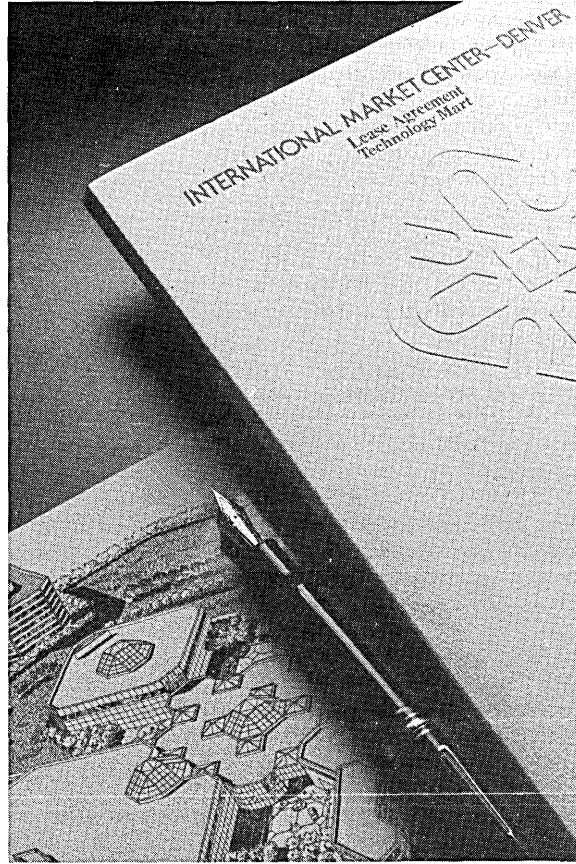

An average sales call costs \$300.

You've watched it happen for a long time. Identifying your prospect, getting to him and finally selling him is getting more costly and less efficient.

The Technology Mart at Denver's new International Market Center offers you a profitable alternative to the old, exhausting process. As part of a state-of-the-art exhibit, educational and executive conference facility, the Mart will offer programs designed to attract qualified buyers. It's the one alternative that can lower both your cost per sale and your blood pressure, while supporting existing channels of distribution.

Most importantly, the new mart

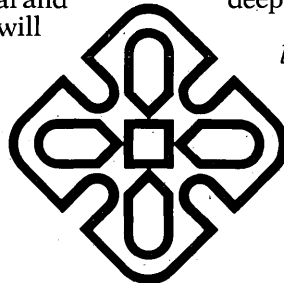

Now you can beat the averages.

is strategically located in the heart of a burgeoning 11-state region that stretches from Mexico to Canada. It's a region with a proven growth rate in the consumption of technology products and services. The International Market Center Technology Mart offers an affordable, efficient way to penetrate this deep buyer base.

Leasing rates are most attractive now for late fall 1985 occupancy. To find out how your company can beat the averages, contact Bob Okonski, Vice President Technology Mart, International Market Center-Denver, 7951 East Maplewood Avenue, Suite 300, Englewood, Colorado 80111 (303) 694-1966.

INTERNATIONAL MARKET CENTER In Denver

Incomparable. World Class. At last.

A development of The Bill L. Walters Companies

Why two when one will do?

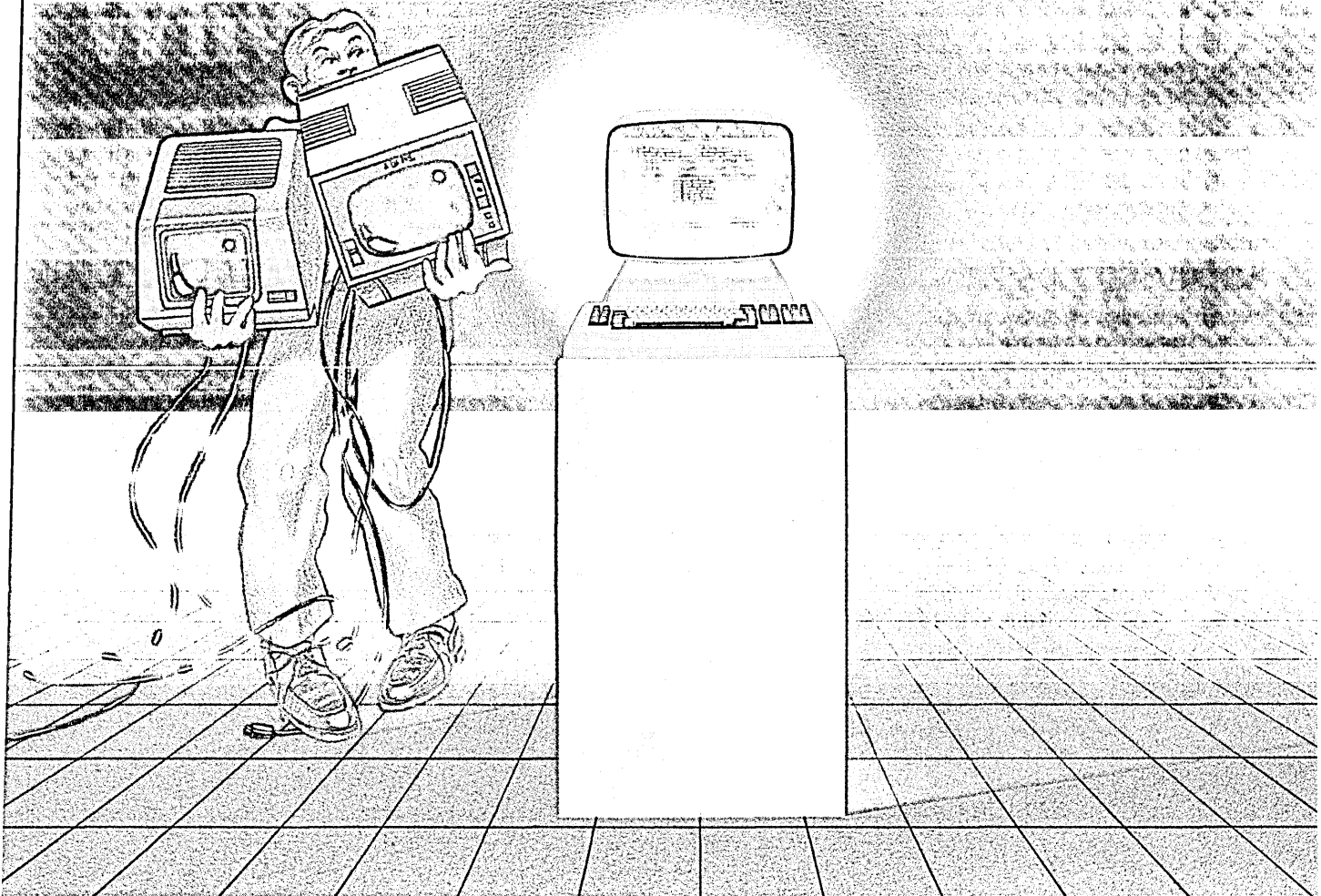

Lee Data's universal terminal system design provides access to both 3270 and VT100 applications.

Now with Lee Data's new 3270/Async Communication System (Series 400) you can eliminate the cost and inconvenience of needing separate displays for access to 3270 and VT100 applications.

The Lee Data universal terminal system approach is another innovative Lee Data design that allows a single Lee Data display to access applications and data from an IBM CPU, a non-IBM system such as DEC, H-P or Prime, and timesharing services. And a simple command entered from the display keyboard is all that is required to switch from 3270 to VT100 operating mode and back again. What could be easier?

The Series 400 System incorporates a new hybrid approach to system operation that is simpler and more efficient than

protocol conversion. This approach allows a Lee Data controller to provide dedicated 3270 and VT100 processors for concurrent, but independent application access.

In addition, a single Lee Data controller provides you 3270 compatibility via either a remote BSC or SNA/SDLC or a local SNA or non-SNA interface, as well as 1 to 16 RS232C ports for your asynchronous application needs. Line speeds available are from 300 to 19,200 BPS.

The Series 400 System also provides you support for up to 32 devices, including Lee Data's unique All-In-One display that offers dynamic selection of 4 screen sizes—three 80-column and one 132-column. Lee Data's 3279-compatible color displays and a full line of printers are

also available as part of the 32-device complement.

3270 and VT100 capabilities combined in a single terminal system—a reality with the new 3270-plus-Async system from Lee Data.

Discover what our system can do for your company's terminal network. Call our system specialists toll free:

800/328-3998.

**Designers of innovative systems
for the information worker**

**LEE DATA
CORPORATION**

**7075 Flying Cloud Drive
Minneapolis, MN 55344**

NEWS IN PERSPECTIVE

product for the Series/21 host, permits disk and file sharing among workstations, providing users with a local area network facility. Because the Series/21 emulates the IBM 3276 cluster controller, the new board also gives the Hero workstation user a direct connection to IBM mainframes as a vir-

MDS must convince users that Hero makes the entire Series/21 more competitive and that the product really is "a clear alternative to IBM."

tual terminal. Finally, the board also allows the Hero to communicate over Mohawk's WINC worldwide electronic mail service.

These capabilities reflect the changing direction in the Series/21's evolution. Once a data entry system, the Series/21 is now being positioned as a cluster controller directly competing with IBM's 3276. Says Robert J. Amman, president of the MDS Systems Division, "Office automation will only come about by building on 3270 networks, not by giving lots of individuals little toys. We made a conscious decision some time ago to enter the 3270 intelligent workstation market, and we are still committed to working within the 3270 environment. That must be the starting point."

Gaylord adds, "Everybody's been deluded a little into buying personal com-

puters. We've found that there is a real mix of needs, from dumb terminals to intelligent workstations. For us to come out with a standalone PC would not have made sense. We have to communicate using the protocols of other vendors if we are to be a competitive company."

Hero clearly fits in with this overall strategy. The larger concern, which ultimately is the biggest cloud on Mohawk's horizon, is convincing the world to buy the idea and the product. "Our biggest challenge is to be known in the first place," Amman concedes.

To accomplish the goal of gaining recognition and ensuring that the resulting perception of the company is accurate, MDS is launching a mammoth ad campaign this month that plays on the "hero" theme. But, as was the case with the Personal Computing/21 product, the ads may promise more than the product can deliver. In the earlier instance, MDS promoted the product as a personal computer tied to the Series/21, when in fact the product could not act in a standalone mode at all. With Hero, ad mockups declare, "Heros are immortal." That may not fly with users who keep hearing about short product life cycles, however—especially when they hear Amman admit that Hero is, in many respects, a replacement for the six-month-old Personal Computing/21.

Such overstatement makes it more difficult for Gaylord's marketing force to make its point clear. And even if it does succeed in convincing users and analysts that Series/21 with Hero is now a serious and technically comparable competitor to IBM cluster controllers, the job is only half over. Says Amman, "We're not talking about replacing one IBM controller in one location. We're talking about implementing a major portion of a company's dp network. We're looking at a more complex situation than simple plug-for-plug compatibility. Our customers are changing or building networks, which take many years to plan and execute."

Part of the marketing pitch in developing such complex sales is an emphasis on

"For us to come out with a standalone PC would not have made sense," Gaylord says. "We have to communicate using the protocols of other vendors."

the company's research and development expenditures. Chairman Ralph O'Brien notes that five years ago "only about 3½% to 4% of our sales went to R&D. We've increased our spending there by about 25% per year since then, so that now we're spending 7% or 8% of revenues per annum.

Wait 'til management sees is doing to the

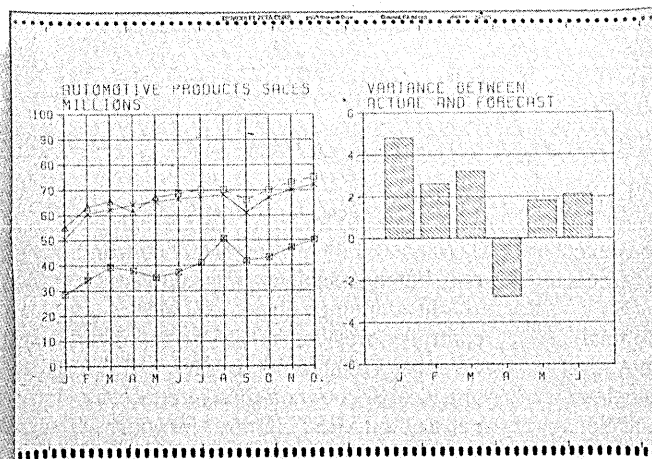

Before ISSCO

With ISSCO graphics software your computers can produce artist-quality charts and graphs. No more fuzzy letters and frazzled images. ISSCO computer graphics are always sharp

and clear. What's more, you'll enjoy layout freedom and can choose from a variety of graphic enhancements that let you tailor a chart exactly to your needs.

ISSCO software is especially

useful for management presentations. It lets you access data directly from your computers and reproduce it on paper, overhead transparencies or 35mm slides. And you'll always get professional results.

We felt very strongly that because of the speed of the industry the new products had to be there and we had to spend money to develop them."

Ironic, then, that Hero comes to market not through internal development but through a contract with Convergent Technologies. "We defined what we wanted for an intelligent workstation that would integrate with the Series/21," Gaylord says. "We prioritized what we wanted, and then looked at about a dozen vendors as well as what we could do ourselves, before choosing Convergent." In so doing, MDS tacitly admitted that its expanded R&D effort was still far enough behind the industry to warrant going outside for products.

The growth of R&D—small though it may seem compared to competitors that have spent upwards of 10% of their revenues on R&D all along—may yet result in new products, however. While the company won't discuss specific plans for Hero's successors, it does say that the product is the first in a new 3300 series of terminal workstations. "I wouldn't be surprised if in six months we have a new set of terminals for the 3300 from someone else or from ourselves. We're not hung to Convergent at all," Gaylord says.

Moreover, with the introduction of Hero behind it, Mohawk is shifting its resources to spending a smaller percentage of

its revenues on R&D, and more on marketing. O'Brien says, "We've reached a point now where we don't have to spend that much on product development anymore, and in the next two or three years we will cut the rate of increase. We will very much accelerate the amount of money we spend on marketing, although it may not show up as a percentage of revenue."

Mohawk is hoping that the combination of increased marketing spending and Hero will enable it to wedge itself into more dp installations. Wall Street analysts see

Mohawk is hoping that the combination of increased marketing dollars and Hero will enable it to wedge itself into more accounts.

this thrust as coming none too soon, particularly in the insurance industry. Mohawk has traditionally been strong with insurance companies, notes Bear, Stearns analyst McManus, and last year won a contract from Nationwide Insurance Co. for over 3,500 Series/21 clusters to be installed at a rate of 80 per month. Still, he says, "their results in the insurance industry have been disappointing. They have been unable to leverage that Nationwide contract, and that's at least partly the fault of their marketing people." (Apparently, Hero has

since made some progress in that regard. Nationwide recently concluded an agreement with MDS extending its original contract to include several Hero workstations. At press time, the value of the deal was unknown.)

O'Brien believes that Hero will continue to boost Series/21 sales, and predicts that the resulting gain in revenue will enable the company to post its first quarterly earnings increase in 2½ years this January. If that happens, he says, Wall Street may once again pay attention to the company, closing the credibility gap.

"When our earnings turn around, our stock price will react. Wall Street is harsh to people whose earnings go down, and we've been no exception. Wall Street so far has not treated us unfairly, I think." Mohawk's price has dropped from a high of \$32 in 1980 to a current level of about \$13.

Perhaps more important than Hero's growth in determining Mohawk's profit picture are the company's European and Asian operations, which generate some 45% of revenues for the corporation. The strength of the dollar has so diluted earnings, O'Brien says, that "if the dollar had stayed at the same rate it was in 1980, our earnings would have been up substantially each year instead of down. We've been hit severely by the devaluation of foreign currencies."

what the D.P. department company's image.

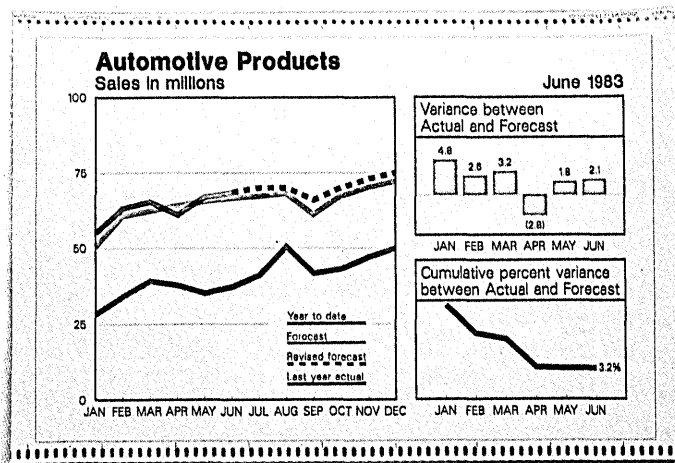

After ISSCO

Isn't it time you got the credit for making the company look good? For more information about artist-quality graphics and a free copy of our 40-page manual, "Choosing the Right Graphics Devices," write ISSCO,

10505 Sorrento Valley Road, San Diego, CA 92121. Or call (619) 452-0170.



Draw faster conclusions with ISSCO



EVERY COMPUTER COMPANY TALKS SERVICE UP FRONT. BUT HOW MANY OF THEM CAN BACK IT UP?

These days, you've got to be real careful that the service a company promises you is more than just lip service.

Because if something goes wrong with your new equipment, and their service isn't right, you've just bought yourself a real headache.

At ITT Courier, we've been around long enough to know you can't sell customers short when it comes to service.

So we back up every ITT product with 150 service centers in North America alone.

We staff every one of those ITT Service Centers with field engineers who get their training at our state-of-the-art service school, not on your equipment.

And we give every ITT customer the security of a 24-hour service hotline, seven days a week.

Of course, no company can promise you a fail-safe product. But at ITT Courier, we're very proud of how quickly we can rise to the occasion should your system ever go down.

ITT Courier Service. It's one important reason we'll be around long after a lot of those other companies are long gone.

Contact your nearest ITT Courier Representative. Or call the ITT Courier Sales Support Department at 1-800-528-1400, toll-free.

ITT
COURIER

YOU KNOW WE'LL BE AROUND.

NEWS IN PERSPECTIVE

Partly as a reaction to the currency fluctuations, partly through a new emphasis on U.S. sales in the Systems Division, and partly through the acquisition of Qantel in 1980, the percentage of Mohawk's business generated overseas has declined in the past few years, from a high of 55%. "This company was out of balance. We didn't sell enough in the U.S.," O'Brien says.

The company has no intention of letting sales slip any more in foreign markets, however. "I think our mix is about right now, because we couldn't exist without overseas sales at the rate we now have," O'Brien notes. That's because the 45% of revenues generated overseas counts for fully 60% of Mohawk's pretax profits, making the overseas operations far healthier than the U.S. operations.

The emphasis on foreign markets is also apparent in the Series/21 support of X.25 and Sperry UTS protocols. "These two protocols are strictly for the European market, where we find Sperry and other computers coresident with IBM mainframes," Gaylord says. "But 3270 is still our primary strategy. We will not offer other protocols except on a secondary basis for coresident computers." The European emphasis is also apparent in Mohawk's decision to inaugurate a second WINC electronic mail service bureau routing center in London; previously, all WINC messages were routed through a central Connecticut facility. And, of course, Hero will be distributed outside the U.S. as well.

Mohawk's traditional strength overseas is clearly no longer sufficient to sustain corporate earnings. While Hero attempts to boost the U.S. contribution, competition will still be severe—perhaps more than a company with a credibility gap can bear.

IBM PONDERS UNIX

The industry leader is expected to make a move into the Unix market soon, but it has to tread carefully.

by Ralph Emmett

The question of IBM's possible adoption of AT&T's Unix operating system continues to perplex the industry: will the computer giant position itself away from the relatively open system or will it embrace the software, which is rapidly gaining de facto industry standard status?

The answer is probably known for sure only within the apple orchards of Armonk, N.Y., where IBM planners are

known to have been studying the issue for several years. It has been learned, however, that IBM has several Unix-related product plans under way, one of which may bear fruit as early as this month.

The most likely introduction of Unix by IBM will be as a "guest" operating system under the firm's VM/370 control program, which has become increasingly popular in recent months and which got a major boost with the October introduction by IBM of the XT/370 personal computer, a desktop VM/CMS machine. This implementation, industry observers say, will enable IBM to tap the vast Unix market while maintaining its own operating system investment. The Unix-related market is projected to hit \$5 billion in 1985, according to Gnostic Concepts, a Menlo Park, Calif., research house.

It is most important for IBM, observers point out, to stay out of the clutches of AT&T, which has recently boosted its marketing efforts for Unix in preparation for entering the general purpose small computer market. AT&T has not only made significant enhancements to its operating system but has also struck deals with leading semiconductor houses to embed Unix in silicon in future systems. Unix is the wedge with which AT&T will try to gain control of the hardware and software market and is thus a competitive threat that IBM cannot choose to ignore.

Other computer makers, too, have had to reckon with Unix, which, in variant forms, has begun showing up on microcomputers as well as the traditional minicomputer-class machines for which it was originally written. Digital Equipment, Data General, and Hewlett-Packard, among others, have made Unix key products in their marketing efforts. In many cases, these companies have implemented Unix in their virtual machine operating systems. "This enables them to preserve their native environments and at the same time look like AT&T on the outside," says Jim Isaak, marketing director at Boston-based Charles River Data Systems, which builds Unix hardware.

Many of the Unix look-alike vendors have banded together to form a user group (Sept., p. 71) and are attempting to create a Unix-like portable standard that reflects not only AT&T's input but their own as well. Sources in the group reveal close interest by IBM, which has provided input through one of the committee members.

So, the big questions have been: Would IBM become just another AT&T licensee like so many of the Unix standards group, or will it use its own virtual machine kernel to support Unix-like user and program interfaces? Sources reveal that a Unix marketing task group assembled at White Plains, N.Y. in early 1980 pondered these same questions. Another option, namely, staying out of the Unix business altogether,

has been strongly advocated within IBM by the developers of VM/370's usual "guest" front end and Unix challenger, CMS (Conversational Monitor System).

George Colony, president of Forrester Research, Boston, points out that CMS has now been announced with IBM's new 370 "on a desk," the XT/370, to create a homespun alternative to a Unix virtual workstation. "IBM's VM/CMS developers are telling IBM's management that, as a result, the company doesn't need to offer Unix, and to offer it would be to undermine CMS and aid AT&T's standards efforts," Colony claims.

Sources say that, though IBM has been sympathetic to the pleas of its own people to "resist or block" the surge to Unix, which experts now say accounts for

Several observers expect IBM to bring up Unix under the VM/370 operating system, which runs on 4300s and 308X machines.

more than 150,000 U.S. installations, it finally decided on a policy of using this momentum to its own ends. It will offer the market a Unix-like front end under VM/370.

"If anything is clear about IBM at this point," says Amy Wohl, who has been tracking IBM's plans to automate the office at her company, Advanced Office Concepts, Bala Cynwyd, Pa., "it is that they want *all* the business—including the lion's share of Unix."

Sources reveal that IBM has decided to offer both CMS and its own version of Unix as guests under VM/370 and let the market decide which it wants. Though it could not be confirmed by press time, it is believed that IBM's Unix-like software was written by Interactive Systems, Santa Monica, Calif., in cooperation with IBM's Endicott, N.Y., facility. Both companies declined comment.

The VM/Unix combo could be announced for use on the new XT/370 as early as Dec. 15, sources confide. "They seem to have planned a Unix-with-everything period," says one insider, "because they also will soon make their 9000 series Unix micro available as a commercial product through the NAD [National Accounts Division]." The 9000 Series machine was developed by IBM's Instrumentation Division at Danbury, Conn., and features a Unix port called Xenix from Microsoft. IBM plans to give a large number of 9000s to Carnegie-Mellon University so that faculty and students can develop new applications that will eventually enrich the IBM portfolio.

Charles River's Isaak says members of the Unix standards committee have been hoping that IBM will go along with whatever they recommend. "Now, however, it could well be that whatever IBM announces could become a de facto [standard] in its own

WHAT TO WEAR TO WORK IF YOU BUY THE WRONG DBMS INSTEAD OF OUR MODEL 204.

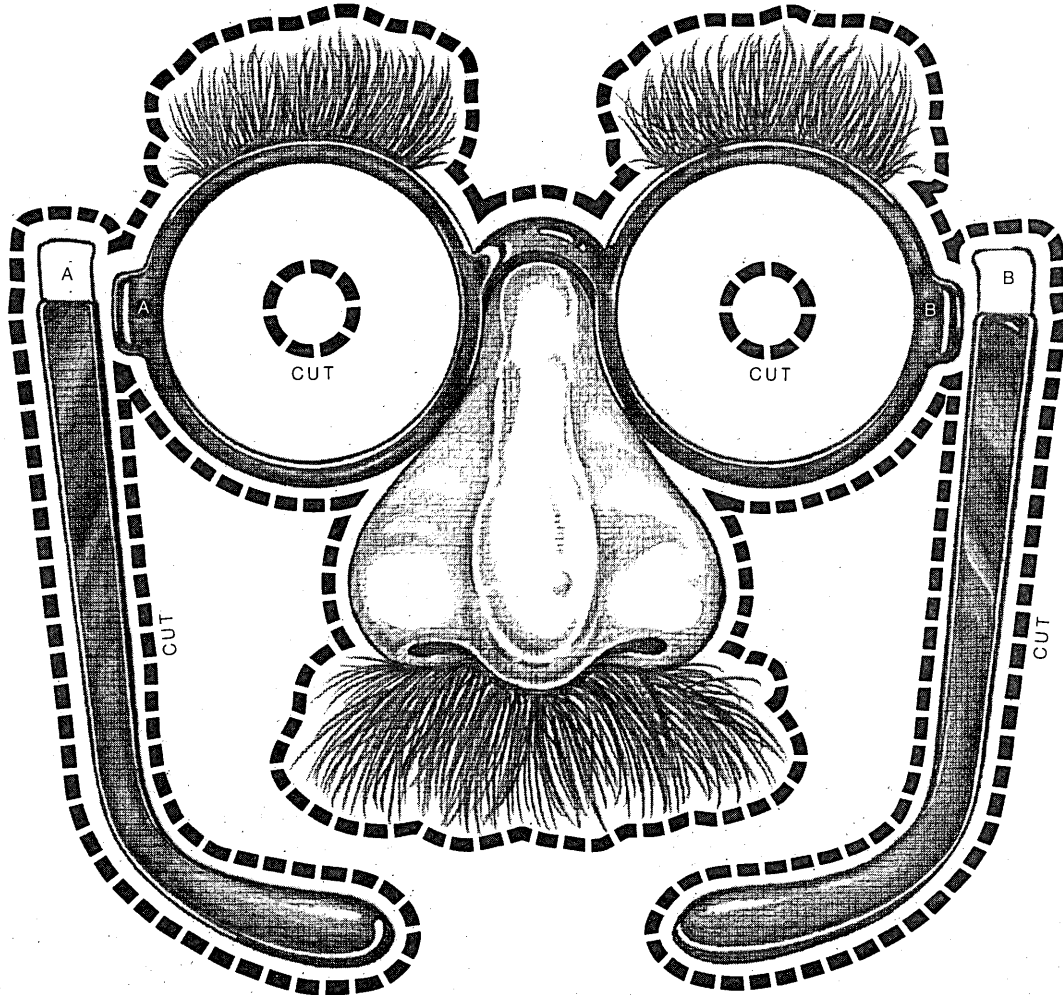

Picking the best, most productive DBMS for an OS, DOS or CMS environment requires the use of all your faculties. Because many DBMSs never live up to their promises. And sooner or later those deficiencies are bound to catch up with you. Leaving you looking for something to hide behind.

Computer Corporation of America doesn't have to put on an act to convince you. Our MODEL 204 DBMS is the only commercial DBMS ever designed from scratch for online systems. Every other DBMS was converted from batch. And that means new applications come up faster with MODEL 204. In fact, 5 to 50 times faster. And your applications and databases are much easier to maintain.

What about performance? If you end up with a DBMS that can barely carry a few million records and a dozen or so users, you won't be able to mask the fact forever. Especially if someone finds out that MODEL 204 can handle up to 513 billion records and 999 concurrent updates.

Now the advantages of MODEL 204 are available for the DOS/VS(E) and native CMS environments. Without sacrificing either performance or productivity.

In the DOS world, MODEL 204 is the only DBMS with a direct teleprocessing interface. Which saves the resources and

productivity costs of a terminal monitor.

Our native CMS implementation outperforms other DBMSs because it utilizes its own I/O routines without modification to either VM or CMS.

Finally, two other things that no other DBMS can say. MODEL 204 received the highest overall rating in a recent *Datapro* survey: 3.5.¹ And it's the fastest growing system for IBM mainframes from an independent vendor.²

Now faced with these facts wouldn't you look silly buying anything but MODEL 204 DBMS?

MORE ON MODEL 204 DBMS.

DM-12-G

- Make a presentation. Let's put MODEL 204 in and benchmark.
 Send me a brochure. Send me info on free DBMS seminars.
 Operating Environment: OS DOS CMS

NAME _____ TITLE _____
 COMPANY _____
 ADDRESS _____
 CITY _____
 STATE _____ ZIP _____
 TELEPHONE _____

**Computer
Corporation
of America**

Four Cambridge Center, Cambridge, MA 02142 (617) 492-8860

1. *Datapro*: "User Ratings of Proprietary Software-COMLETE" November 1982. 2. *Computerworld*: December 20, 1982.

Other Offices: New York, Houston, Dallas, Los Angeles, San Francisco, Chicago, Philadelphia, Washington, D.C., Morristown, NJ, Stamford, CT/Representatives: Canada, U.K., Europe, Australia, Japan, Saudi Arabia.

CIRCLE 46 ON READER CARD

NEWS IN PERSPECTIVE

right" he concedes. He alludes to the existence of CP/M as the standard for micros before IBM's adoption and support of Microsoft's MS/DOS on its PC. Now that IBM's

Digital Equipment and Data General have embraced the AT&T operating system, each in its own way.

370 on a desk, the XT/370, has become a reality, its eager reception by IBM's base could catapult an IBM Unix to the same elevated heights.

"The most important thing from IBM's point of view," says Gnostic Concepts director Bob Katzive, "is that it prevents AT&T from setting its Unix standard in concrete—or should I say silicon?—at this early stage." AT&T has signed deals with Motorola, Zilog, and Intel to set its version of the Unix kernel in silicon so that a third-party applications industry can develop around the chips. At the same time, AT&T has developed its own 32-bit Unix processor that it will build into a series of computer and communications products scheduled to be announced next year. Katzive, Isaak,

and others point out that any future revisions and updates to Unix could be embedded in silicon by AT&T, thus forcing the industry to buy AT&T hardware to run Unix applications.

"With an IBM alternative at this stage, the scene seems to be set for a battle of the architectures: AT&T with Unix and telecoms, and IBM's Unix supported by SNA," says Katzive. "AT&T will try to avoid a direct confrontation with IBM, and will push its solutions through the telecommunications side of the large corporation. IBM, true to form, will capitalize on its dp connections."

Companies such as DEC and Data General want to keep their Unix options open, and will tailor their software to suit whichever of the two environments, IBM's or AT&T's, they want to sell into. Like AT&T and IBM, both companies are intent on compacting their virtual machine operating systems to run on desktop workstations. IBM and DEC announced their workstations on the same day in October: XT/370 (see related box) and the MicroVAX 1, respectively.

DEC's VMS (soon to be Micro VMS) operating system can now run on a two-board machine exclusive of system memory. In six months or so, DEC is expected to unveil both Micro VMS (for under \$20,000) and a one-board VAX implementation, including memory that will run VMS—the MicroVAX 2.



VS-90/100 USERS SAVE OVER \$4,000/MB

Wang charges \$12,000,
EMC only \$7,900.

We're far and away the leading supplier of super-mini 32 bit main memory. And price is only one reason.

Superior quality and reliability is the best reason. We give every one of our memories a 100-hour burn-in, a worst-case test on our dedicated testers, and a final test on a Wang system.

Because our memory uses less energy, you can cut operating cost up to \$1,000 per year per megabyte.

And you save another \$1,200-to-\$2,400 per year by avoiding monthly maintenance charges.

We take trade-ins.

If you've got a chassis full of 256KB boards, we'll take them in trade and replace them with 1MB boards, so you can increase your memory fourfold.

Buy a pair, rent a spare for next to nothing.

Call to see if you qualify for a free trial loaner.

For more information, call today
1-800-222-EMC2
in Mass. call (617) 653-6600
or write EMC Corporation, 12 Mercer Rd.
Natick, MA 01760

EMC²

*Registered Trademark of WANG Laboratories, Inc.

OFFICE AUTOMATION

IBM TARGETS OA

The industry leader seems determined to penetrate the office automation market as never before.

by Ralph Emmett

After a decade littered with "total office solutions" from such companies as Exxon, Xerox, Wang Labs, and Datapoint, IBM is set to step in with its first integrated approach to office automation.

It should be noted right off that IBM itself was not particularly successful in office automation in the 1970s, primarily because of the fragmented quality of its disparate product lines. The company made no claims of integration, however, and therefore could not be compared directly to its more ambitious competitors. Now, with the Personal Computer at the vanguard of its attack, the industry leader is gathering all of its forces to provide integrated office automation.

CIRCLE 47 ON READER CARD

ANNOUNCING THE NET RESULTS.

Linking micros to mainframes is one of the most pressing problems facing DP managers today. How do you bring all the computers in your company together so they can share information, resources, programs, and access the corporate data base without any loss of security?

you gain more power instead of losing it.

Our broadband bus offers more flexibility. So you can add more users whenever and wherever you want.

By adding microprocessor-based workstations and CP/M-86, SyFAnet gives you more functionality, too. You can upgrade easily without costly

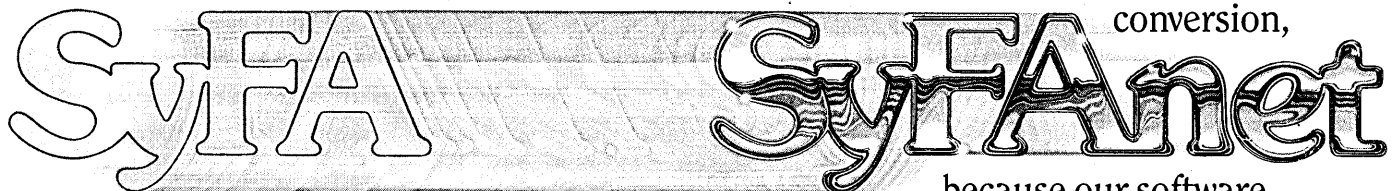

conversion,

because our software

remains the same at all levels.

And while *you* might get confused by the flurry of message traffic in the office, SyFAnet never does. Its unique version of collision avoidance means data doesn't get lost in the shuffle.

Because business doesn't stop at borders anymore, SyFAnet was designed with the whole world in mind. SNA and X.25 capabilities connect you to mainframes and networks around the world.

SyFAnet. Ready to solve your networking problems today and tomorrow. It's the network that works.

For more information, write or call today.

Networking is a nice concept but it won't work unless you have a system that works.

SyFAnet™ (System For Access network) is the network that works. The only complete solution on the market, ready to meet all your networking needs now.

SyFAnet gives you everything you ever wanted in a network: the ability to link PCs together, multi-function workstations, industry-standard software, global information access and unlimited expansion capabilities. All fully-integrated, and built upon a foundation of proven hardware and software.

Picture a powerful processor for every purpose—one for applications, another for sharing resources. This special architecture makes SyFAnet a more reliable network, with no single point of failure. Every time you add a terminal,

 **ComputerAutomation®**
Commercial Systems Division

1800 Jay Ell Drive/Richardson, TX 75081
(214) 783-0993/TLX: 4630023

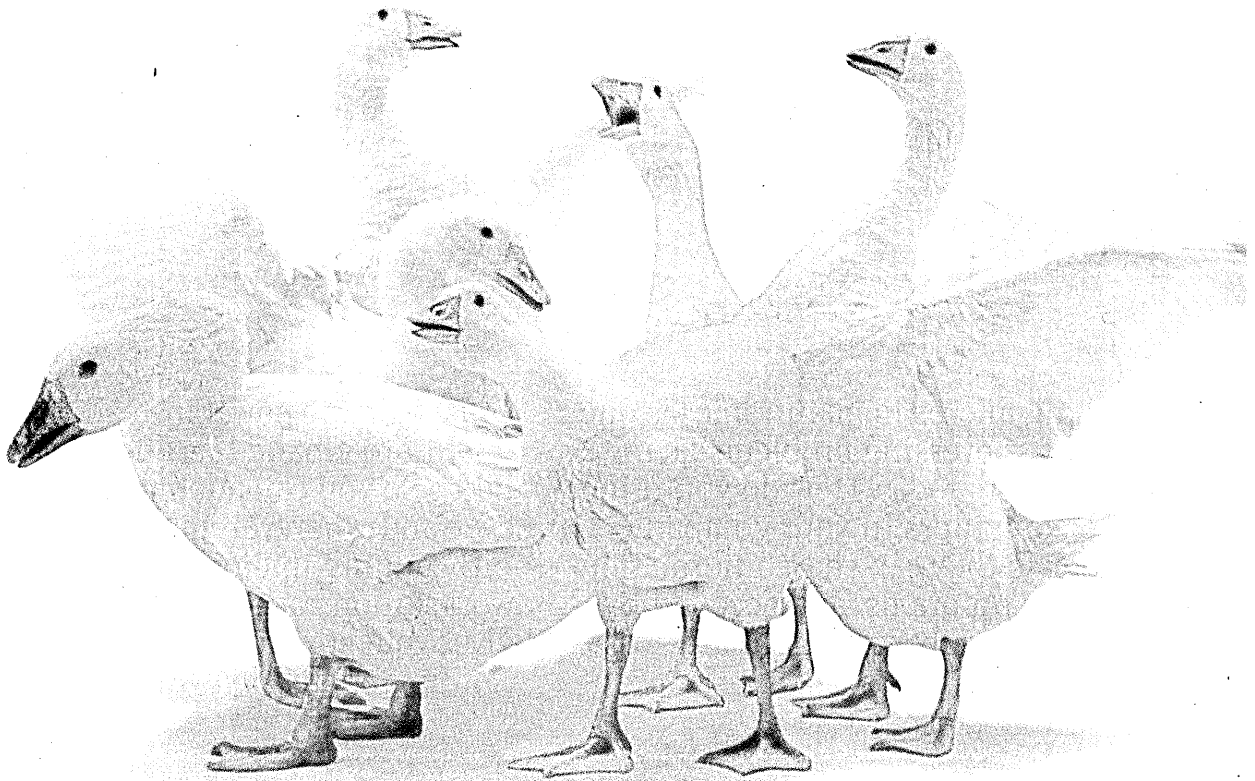

While everyone else has been squawking about private networks, one company has been quietly building them.

Today, with dozens of new companies and hundreds of unproven products all promising to perform networking miracles, the noise level has become exceedingly loud.

And the job of finding the right company to build your network has become more confusing than ever.

Meet BBN Communications. In the midst of the noise and confusion, we've been quietly building networks for government agencies and major corporations around the world. In fact, we built the world's first packet-switched computer network back in 1969.

But what sets us apart even more than our experience is the way we work. Instead of the usual short-term "fixes," we're committed to providing long-term solutions. So before we design your network, our communications consultants will analyze your specific needs—present and future. And based on them, establish your optimum network configuration. Then we'll build your network. Of course, even after everything is working to your satisfaction, we'll still be around to help with your future needs.

It takes more than computers to make a computer network.

Another thing that makes us different is that we manufacture a full line of our own proven networking hardware and software, not just a few isolated products. Including packet switches, terminal access



Our communications processors are the most advanced available today.

devices, and electronic mail systems. All of which simply means we can supply everything you need.

What's more, our entire product line is fully X.25 compatible and easily interfaces with public data networks.

But state-of-the-art technology is just the beginning. We also provide a network operations center so

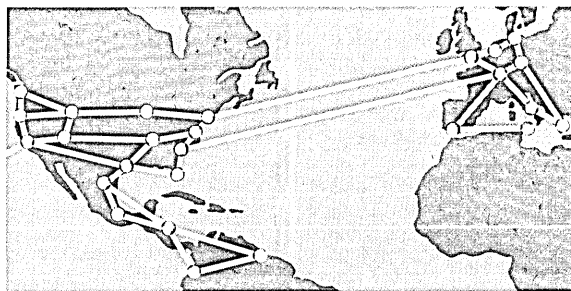

Packet-switched networks built by BBN Communications link companies with offices around the world.

you can monitor your entire network at a glance and control it almost as easily. We'll even run the center for you if you like. And to ensure maximum network reliability—and uptime—we offer round-the-clock field service by the most experienced communications engineers in the business.

Just because we're the networking leader, don't think for a minute that we're resting on our accomplishments. Our R and D effort is one of the largest in the industry, with major programs in protocol development, network control, and future network applications. And, of course, our customers receive the full benefits of every breakthrough we make.

We're the networking leader.

Fifteen years ago, we pioneered packet-switching technology to build the Arpanet, the world's first packet-switched computer network. Today, Arpanet supports 10,000 users and over 300 different computers in the United States and Europe, and the technology we invented for it has become a cornerstone of the data communications industry.

As the networking leader, our customers include major financial, manufacturing, and industrial corporations from all over the world. Recently we've even been selected to build and run the U.S. Defense Department's major new computer network, the Defense Data Network.

So if you're tired of all the squawking, consider BBN Communications. We think it's about time you got your network, and some peace and quiet, too.

For a brochure on our complete networking capabilities, contact BBN Communications Corporation, 33 Moulton Street, Cambridge, MA 02238, (617) 497-2800.



BBN Communications Corporation

NEWS IN PERSPECTIVE

In anticipation of IBM's impending shift, Wang, seemingly the only "total office" vendor to thrive so far, is hastily scrambling to reposition itself around IBM compatibility and an open as opposed to proprietary network architecture.

The shift in emphasis is essential, say Wang insiders, because IBM's 370 architecture, which has spawned an applications software base worth billions, has finally reached desktop level and "is ready to seed a whole new generation of third-party software."

As Amy Wohl at Advanced Office

Concepts, Bala Cynwyd, Pa., says, "IBM can use the 370 desktop [the XT/370] to blanket end users who are already pushing upwards for 370 compatibility in OA, database management, and communications. The new office applications software will follow naturally as a result of this joining."

This strategy, which Boston-based Yankee Group refers to as IBM's "pincer" movement, is based on the emergence of VM/370 as the standard operating system and bridge between IBM workstations and mainframes.

"Without VM/370, neither the XT/

370 nor a coherent OA approach could be attempted at this time. VM is the lifeblood of IBM in the distributed arena," notes Yankee Group's research director, Dale Kutnick.

Interestingly, IBM's VM strategy was telegraphed by insiders of the West German 4300 pcm, Nixdorf (Feb. 1982). They intimated that the preliminary to a three-phase implementation of VM/370 in the office was the creation of a 370-compatible desktop using Motorola 68000 boards.

The first phase would then be to offer IBM's Conversational Monitor System (CMS) on the 370 micro. CMS is used by many of the estimated 8,000 to 10,000 VM/370 installations as a timesharing system for program development, usually running on a 4300.

It was suggested that in the second phase a Unix-like applications front end would be offered on the XT/370, running, like CMS, as a "guest" under VM/370. At the third stage, the sources concluded, the whole VM/370 capability would be offered through a workstation.

As predicted, IBM unveiled in October a \$10,000 370 machine, running CMS. Sources reveal that a Unix-like version could be announced as early as Dec. 15 (see

Yankee Group researchers estimate some 35,000 XT/370 machines could be shipped next year.

related story). IBM is believed also to be readying two new low-end 4300-class processors, one at its Boeblingen, West Germany, site as part of its Olympia Series (Nov., p. 66), and built from IBM chips, and the other at its Endicott center, this time using Motorola 68000s. The machines, to be offered as office workstation controllers, will perform at about 0.3 MIPS and be priced at about \$45,000. Unlike the XT/370, which is estimated to perform at 0.1 MIPS (commercial) or 0.4 MIPS (scientific), the new office processors will host a miniaturized VM/370 as well as the CMS/Unix streams.

Nixdorf, for its part, has begun to show its hand. Enlisting the services of two young ventures, it has commenced a tack parallel to IBM's. The Bedford, Mass.-based Spartacus Computers has already shrunk CMS and VM/370 as well as produced attendant local networking software. Spartacus has just begun to market the software on its own processor and workstations. Next year, following a two-year-old deal with Spartacus, Nixdorf will begin to do the same with its German/Israeli (Elbit) hardware.

For the time being, at least, the XT/370 is the name of the game for IBM. Yankee Group estimates that some 35,000 of the machines could be shipped next year, beginning in volume late in the second quarter. "The number of VM/370 licenses could easily soar to 18,000 next year. If

CompuStat™

Economical EDP workstations

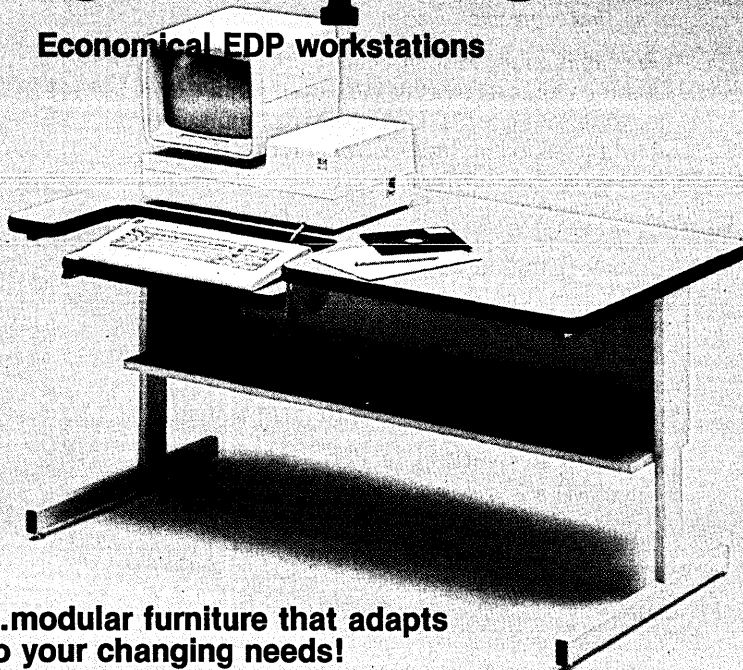

...modular furniture that adapts to your changing needs!

Economically priced, CompuStat furniture quickly adapts to changing workstation needs. Turn a few knobs to raise, lower, or tilt keyboard pads. And...CompuStat lends itself to easy expansion or workstation change. The result... greater efficiency, a smoother work flow, less operator fatigue.

CompuStat offers a full complement of connectable work surfaces, returns, printer stands, and accessories in easy-to-use modules and popular sizes.

Call or write for the latest brochures and pricing.

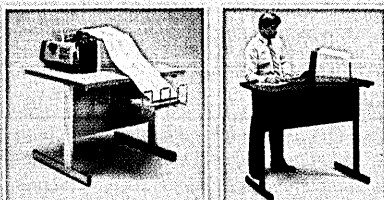

krueger

P.O. Box 8100
Green Bay, Wisconsin 54308
telephone (414) 468-8100

CIRCLE 50 ON READER CARD

SIMPLE.

Instant networking, independent of computer and peripheral brands.

Creating a micro and mini computer network has been costly and confusing. Communications hierarchy has prevented many types and various kinds of equipment from sharing information. Until now.

Introducing StationMate. One unit that joins mini computers, micro computers, terminals, and printers. It's transparent. So different brands and types of computers and peripherals can easily interface. StationMate allows you to construct a comprehensive communications network. *Inexpensively.*

Users can select the information they need from the unit they want. StationMate can

StationMate provides local area networking with XLAN™, the simple communications con-

only \$1,450.00. StationMate makes communications simple. *Incredibly.*

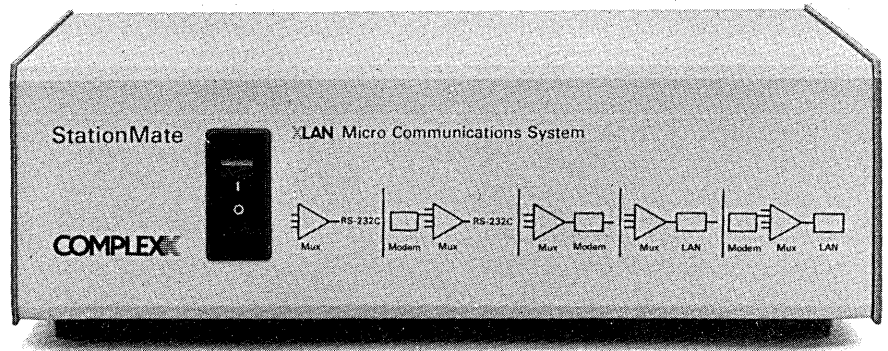

cept from Complexx. All you need is StationMate and an inexpensive shielded-pair cable. Besides local area net-

StationMate. The link you've been missing. See your local dealer or contact Complexx for the name

Teleprocessing

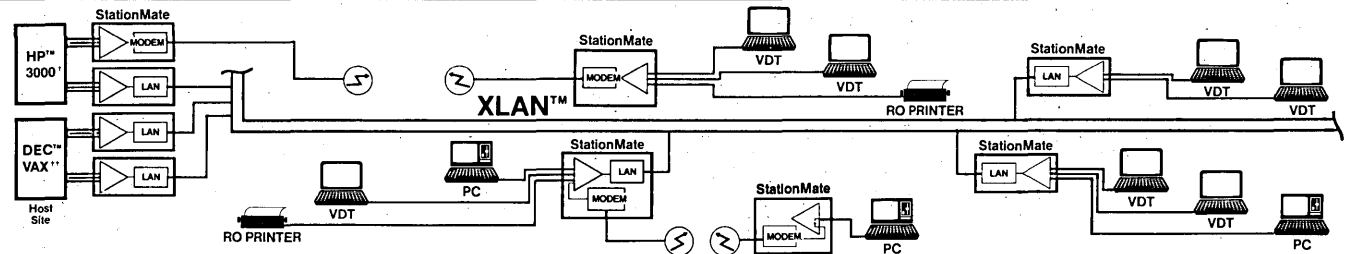
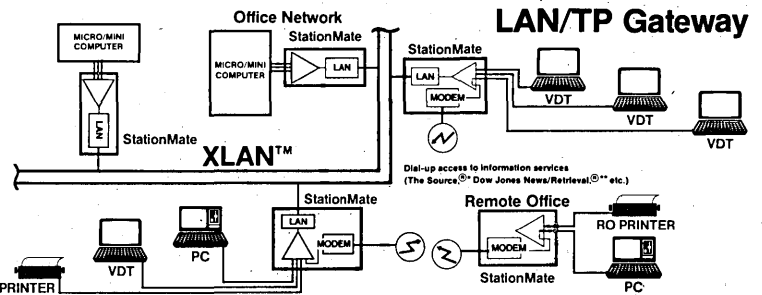
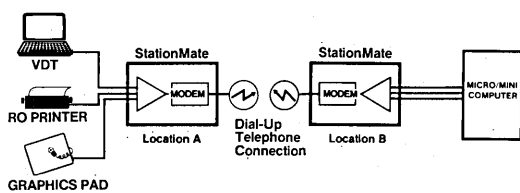

Local Networking

address any port in the network either by its assigned digital code or by its common identifying name. So everyone has access to all the local or remote computers, mass storage files, and peripheral devices connected in the network. *Immediately.*

working, StationMate permits access to remote workstations via an internal dial-up modem. And it serves as a gateway for teleprocessing access to all LAN resources. You couldn't get all of this in one unit. Until now. And the suggested retail price is

of the dealer or distributor nearest you. *Complexx Systems, Inc., 4930 Research Drive, Huntsville, AL 35805. 205/830-4310.*

COMPLEX™

*The Source is a registered trademark of the Source Telecomputing Company, a subsidiary of the Reader's Digest Association. **Dow Jones News/Retrieval is a registered trademark of Dow Jones & Company, Inc. †HP 3000 is a registered trademark of Hewlett Packard. ††DEC VAX is a registered trademark of Digital Equipment Corporation.

NEWS IN PERSPECTIVE

only a couple of program developers at each VM/370 installation take the machine, you'd get that sort of number," said the company's IBM watcher, Frank Gens. "When you take IBM's requirement for chips, disks, and the like, it would probably feel comfortable with that number."

Because of the XT/370, 1984 will be the year when applications developers—end users and third-party software firms—begin to focus on VM/370 in a big way. "Many of the companies, such as Microsoft, Lotus, and Visicorp, that have written for the IBM P.C. XT under MS/DOS will attempt to convert their programs for use under VM, or write entirely new ones," predicts Chuck Tesler, former VM/CMS developer at IBM, and now head of his own company, VM/CMS Consulting Services Inc., in Los Angeles. "Some will adapt to the VM 'gestalt' or pattern, and some won't. Either way, there could be a big shakeout in the microcomputer business software market."

George Colony of Forrester Research, Boston, agrees: "Many young software ventures will be seduced by the prospect of selling to the new VM/370 environment, especially in the office. As a result, MS/DOS, which is not as powerful or user friendly as CMS or Unix, could wither on the vine."

Admitting an obvious bias, Tesler adds: "There's just no comparison. I've done a lot of programming in CP/M and MS/DOS, and like everyone in the IBM world who has used it, I can't wait to get back to CMS."

The runaway success of IBM's P.C. XT in offices raises the question of what happens to the existing pieces of IBM's OA challenge: the 8100, 5520, Displaywriter, and Scanmaster, for example.

According to Colony, a new version of the IBM P.C. (the P.C. 2) will take care of many of these discrepancies. "This system is based on Intel's 186 processor, which is more powerful than the 8088 used in the P.C. With the addition of a text pack this P.C. will run both the Displaywriter and 5520 software, and replace both machines next year." Colony predicted that P.C. 2 with hard disk would sell for around \$4,500 and could be announced as early as the first quarter of 1984.

Kutnick adds that IBM does have other options up its sleeve. "You don't really need a whole new P.C. All you have to do is add another board to the current P.C. or XT to handle the Displaywriter text pack and office protocols."

Industry observers say the Displaywriter has been a very successful standalone system, with some 50,000 to 60,000 units sold. Combining it with an estimated 2 million to 3 million P.C. XTs by next summer gives IBM an instant, de facto word processing standard. And as Wang insiders point out, there are now clear signs that IBM intends to capitalize on this by linking the

new P.C. to a recently disclosed set of standards for document content and interchange known as DIA/DCA.

The DIA/DCA specifications were revealed last summer as part of Dissos, IBM's library of office services which disperses, delivers, and sorts electronic messages. DCA, for example, specifies the necessary protocol transformations that must occur among the incompatible 8100, 5520, Displaywriter, and Scanmasters to enable them to work together in the office.

Wang responded at a splashy Oct. 4 press conference, proposing its own alternative to DIA/DCA in an effort to control the present office standards environment. With its current 150,000 text-oriented workstation base and an anticipated 75,000 of its own PCs (Professional Computer) on-line by next summer, Wang is "currently the de facto standard, so it seems logical that we should make this move," said company president John Cunningham.

Currently, Dissos and DIA/DCA do not encompass IBM's P.C., but this is expected to change with a new version (release 2.4) of Dissos, anticipated by sources in the latter half of next year. Wang, though clearly not rejoicing in the prospect, is not blind to it either, and said it would support IBM's DIA/DCA standards if users require them. "This is the end of a proprietary Wangnet, and the first step to an open access policy," said Cunningham.

"Wang and the others have about a year to get their acts together," says Kutnick. "You can see IBM's loop beginning to close."

GOVERNMENT

GOING TOO FAR

Proposed federal legislation regulating publicly funded R&D has universities and small business groups up in arms.

by Willie Schatz

It seemed like a good idea at the time. All the myriad laws telling vendors how to do business with the federal government would be combined into one code. With surprising logic, the new creation would be called the Federal Acquisition Regulations (FAR).

Almost six years later, it is an idea whose time has finally come. Make that almost come. Though much of the 700 pages released for comment last May was acceptable to the commentators and, of course, the authors, some of the proposed rules on patents, data, and copyrights aroused considerable ire in the university

and small business communities, as well as in Sen. Robert Dole (R-Kans.). For them, the FAR was just too far out.

It all has to do with the dissemination of R&D work done with public money at universities. Sections 27 and 52.227 of the FAR package are so close and yet so far from joining the rest of the rules in getting approved and implemented. The sound and fury accompanying the release of the draft version has resulted in those two sections being "reserved" in the final version issued in the Sept. 19 *Federal Register*. So it's back to where it all began. A committee of 12 agencies chaired by the General Services Administration (GSA) is poring over the comments and will issue another version, perhaps by January. There will be more comments on that one. Then maybe there will be a third version, followed by more comments. Then . . . well, you get the idea. So don't hold your breath for FAR to become effective next April 1, as scheduled.

"This was not a surprise," admits Lawrence Rizzi, director of the FAR Project. "We knew for five years that patents, data, and copyrights were the biggest bag of worms in the whole thing."

"Will we make the deadline? Who can say? If it were any subjects other than these, we'd make it easily." Rizzi isn't even sure the panel will make the interim January deadline.

The draft proposal "was a lousy piece of work written by some guys who wanted the government to own everything," charges George Bush of the Council on Government Relations (COGR). The council is an autonomous arm of the National Association of College and University Business Officers (NACUBO). From the moment the draft proposal hit the streets, NACUBO, which University of Washington Provost Bob Gillespie characterizes as "our early warning system," was on the alert.

The issue, as always, is money, and in this case the currency is patent rights. The University and Small Business Patent and Procedures Act (Public Law 96-517, passed in 1980) was designed to reverse previous government patent policy for small businesses and universities. The law was supposed to allow small businesses and universities to retain the patents for products they developed under government research and development. To hear the university people tell it, the proposed FAR governing that subject was straight out of 1984, as it would reverse P.L. 96-517 and give patent control back to the government.

"P.L. 96-517 was a change the world welcomed except the patent attorneys for the Department of Energy, the Department of Defense, and NASA," Bush says. "These guys wrote the draft and the university and business communities screamed and hollered. Everybody and his brother had terrible things to say about Section 27."

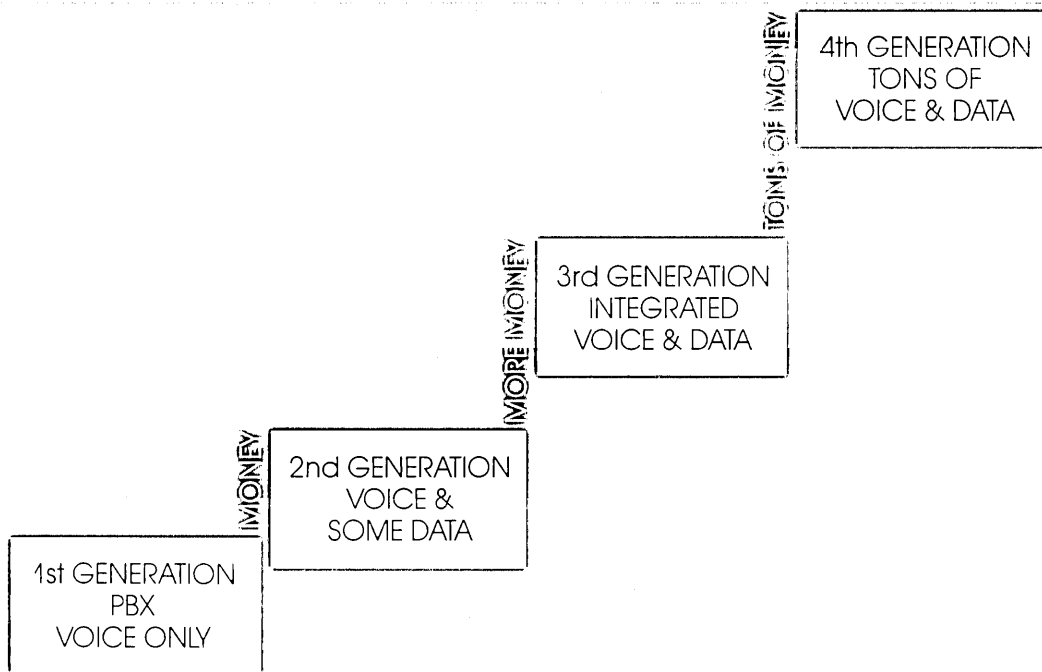

Are the steps
killing you?

More than twice the bandwidth of other systems. 4.4 billion bits per second of information handling capacity to serve more than 10,000 users. Distributed architecture via fiber optic internode links.

You won't get all that with any other PBX. **ROLM**

The end of the end of the line.

The ROLM® Ramp cures FUD: Fear. Uncertainty. Doubt. The recurring nightmare that you may be buying a communications system that can't grow, can't change, or has a big gee-whiz capability missing.

With CBX II™, that can't happen. It's totally modular and absolutely expandable. You can move up The Ramp smoothly, easily, painlessly from 16 to more than 10,000 users.

If you need more power, just add a

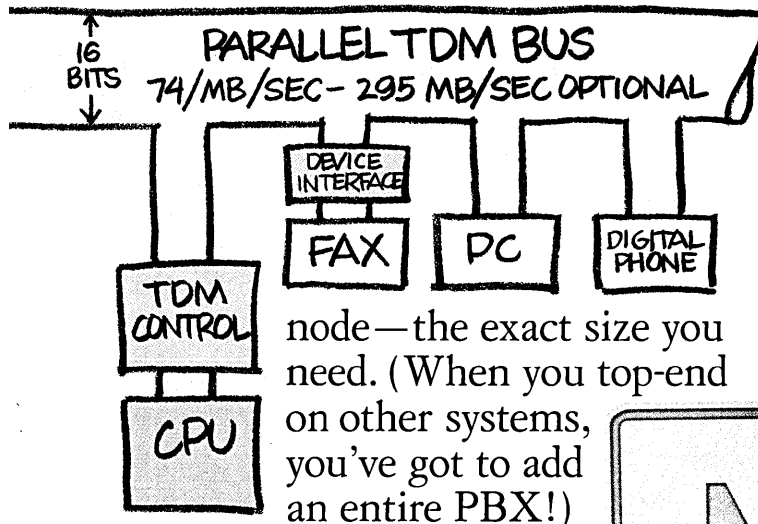

node—the exact size you need. (When you top-end on other systems, you've got to add an entire PBX!)

Buy CBX II, get a free LAN.

The parallel bus architecture brings enough communication power to the

desk to not only network most common digital critters, but to let you a high-performance devices such as graphics terminals, IBM PCs, Lisas or host processors. With this kind of power, you could even handle video.

CBX II architecture can deliver information to the desk at speeds way beyond the much-discussed

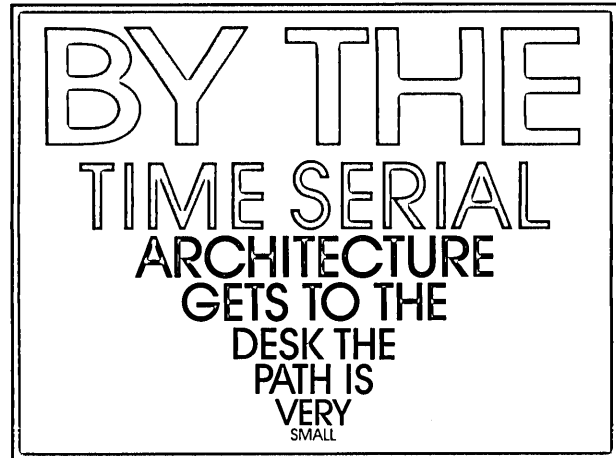

56Kbps—hundreds of kilobits using existing telephone wiring, megabits using other media. (Try that with serial architecture!)

IBM meet Tymnet.
DEC meet WANG.

CBX II is compatible with ASYNC SYNC, SNA/SDLC at speeds up to 64Kbps. It also supports X.25 and T1/D3 network standards. You name it, we connect it.

We're working with IBM, HP, DEC, Data General and all the other movers and shakers to make sure that, as other standards are developed, they will be supported by the system.

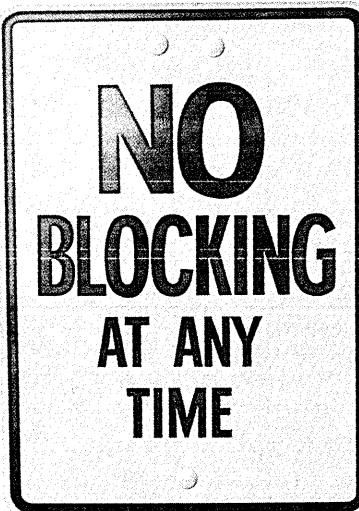

NEWS IN PERSPECTIVE

Maybe even worse than terrible. Take, for instance, a letter to Rizzi from Stanford University vice provost Gerald Lieberman:

"If adopted as currently proposed, these regulations would jeopardize this country's progress and leadership in science and technology. FAR seeks to impose government ownership and censorship over information developed in the course of contract research; it would inhibit the free and open dissemination of unclassified research results which is essential in order for the United States to maintain its scientific and technological progress."

That was just for openers. Then Lieberman got down to business.

"Prior written censorship by government officials would be required for the dissemination of research results in any other copyrighted form such as books, monographs, unpublished papers, graduate student theses, and other informal means of scholarly exchange," he said of a section that would permit copyrighted publication without prior government approval *only* of "scientific and technical articles . . . in an academic or technical journal."

The proposed software regulations also drew Lieberman's wrath. The provisions "singled out" software as items to be owned by the government and not items to be released by university contractors.

"Our software is merely the embodiment of research data in a copyrightable medium," wrote Lieberman. "More and more research results are taking the form of computer software. Stanford recently established a distribution center designed to insure timely and efficient dissemination of research software. FAR would prohibit such dissemination, without even giving government officials the discretion to authorize release."

In the midst of all this noise, the computer community remained relatively quiet. The controversy, if not immaterial, was at least irrelevant.

"This isn't something that really concerns us," says a spokesman for ADAPSO. "The ownership issue is settled up front in the contract. If it's custom programming, which is sort of what the universities are talking about, the parties settle it themselves. If the seller wants to retain the rights, he cuts the price. If the buyer wants to own it, he has to pay more. We're also talking about R&D contracts, which very few companies can afford to do on their own. That's fairly far removed from the commercial marketplace."

"People in the dp community won't be affected by it," says David Cohen, a leading procurement lawyer in Washington. "It's not an issue of burning concern to people who sell to the government."

It is an extremely hot topic for people who are the government, however. It did not take long for word of academia's

and small business's dissent to reach some powerful ears. The groups found they had some friends in mighty high places.

Following the passage of P.L., 96-517, a presidential directive had been issued at the behest of the Department of Commerce. The message was clear. All agencies were to implement the policies and procedures of P.L. 96-517.

"The purpose of that directive was to tell the drafters of FAR to follow the lead of 96-517 in developing the government agencies' patent procedures," says Doug

"FAR was a lousy piece of work written by some guys who wanted the government to own everything," says one critic.

Comer, chief counsel for the Senate Judiciary Committee's subcommittee on courts. "They did not do that."

No kidding. So Dole, a cosponsor of P.L. 96-517 along with then-Senator Birch Bayh, wrote a letter to Vice President Bush. The senator reminded the Vice President of the directive to members of Congress involved with drafting the FAR. "I was therefore quite disturbed to learn that the draft FAR are being used as a fast track by some agency patent staffs to attempt to roll back the clock of patent policy in viola-

tion of the intent of the 1980 act," Dole wrote Bush. Bush wrote back, expressing similar concern and promising Dole that Part 27 would be withdrawn from the proposed revision.

"The draft regulations that were to be published were completely screwed up and did not follow the act," Comer says. "In fact they were written in such a way that they undermined the provisions of 96-517 both as to small business and the universities. The purpose was to stop that in its tracks and go back to square one."

That's exactly where we are. It's several thousand pages and six months later, but everything essentially remains the same. One difference between the upcoming journey through the FAR wilderness and the one just completed is some new writers. The original authors had their chance and apparently blew it. Whether their successors can turn FAR into what it's supposed to be, no one knows for sure.

"What most of us were hoping FAR would really do is be a one-for-one translation reducing the number of regulations, not just reducing what the regulations say," says Bill Harris, formerly director of industry/government affairs for Boeing Computer Services and now managing director of Interex, a consulting firm in Washington. "It's a very difficult job. They've taken a large, immovable mess and made it into a

dBEST.™



dBASE II® is, quite simply, the bestselling database management system (DBMS) made for *any* computer.

Doctors and lawyers, accountants and salespeople, stockbrokers and students, big business and small—over 150,000 users around the world are all managing their data better with dBASE II.

Books have already been written about it. Hundreds of independent businesses are based on it. And other microcomputer programs measure themselves against dBASE II.

For the name of your nearest dBASE II dealer, contact Ashton-Tate, 10150 West Jefferson Boulevard, Culver City, CA 90230. (800) 437-4329 ext. 217. In Colorado, (303) 799-4900. In the U.K., (0908) 568866.

ASHTON-TATE □™

© Ashton-Tate 1983.
dBASE II is a registered trademark of Ashton-Tate.
dBASE II has a suggested retail price of \$700.

It took over 100 years for America to do for the football what Zilog Systems did for the computer in just three.

The next time you think about buying a computer system, think about the football. Because the evolution of its design clarifies the important distinction between too much and too little.

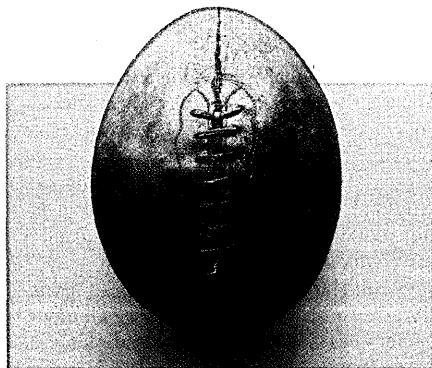

In 1869, when Rutgers beat Princeton in the first intercollegiate football game ever played, the ball was a pig's bladder wrapped in leather — an inflated brown pumpkin. Like the mainframe computer, it was fine for a ground-breaking game, but showed some pretty serious limitations. So someone came up with a different solution.

On a cold day in 1874, Harvard played Montreal with a slimmer, oval-shaped ball. This new ball was okay for running, but had the aerodynamics of a watermelon. It was tough to pass, and tougher to catch. The game ended in a scoreless tie. Like the personal computer, that ball was all right for individual effort, but didn't do much for teamwork.

The moral is that somewhere between pumpkin and watermelon was a solution just right for any game situation — the modern football. Likewise, between too much and too little computer is a system that offers the right solution for most business applications — Zilog's System 8000 supermicros. They're much more powerful and versatile than personal computers, yet priced far less than mainframes and minis. It's been a winning game plan for us, because it helps our customers win at theirs.

Between too much and too little computer is the System 8000, the right solution for most business applications.

Today, there are thousands of installations of our high-performance,

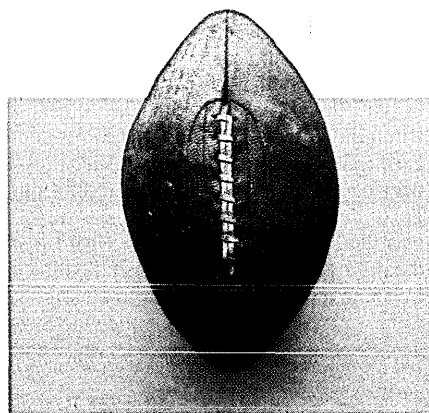

Old footballs courtesy of the College Football Hall of Fame.

16-bit multi-user supermicros. They've proven themselves in environments from offices to oil tankers — and provide everything you need... except a high price. Like software migration tools to protect your existing investment in software. Like the UNIX* operating system, which gives you portability of your applications, so you're not locked into one hardware vendor. Plus, access to a growing body of third party software suppliers through our RSVP, Referred Software Vendor Program.

System 8000 provides portability of your applications, so you're not locked into one hardware vendor.

Then there's our quality service and support. Zilog Systems offers the best service at every level — local, regional and national. Our support programs include a Software Subscription Service, timely documentation,

and in depth technical support, both in the field and at our home office. And that's not all.

It's hard to outgrow the System 8000. Our family of supermicros are modular, general-purpose computers — each model an easy upgrade to the next. Best of all, your first System 8000 can cost less than \$15,000. A surprisingly low figure for a computer that rivals the performance of much more expensive machines. But not surprising from a company who is also the leader in microprocessor technology.

It took more than 100 years for the right football to come along. Fortunately, you won't have to wait that long for the right solution in a computer system. It's here today from Zilog Systems. A company that will be around for a long time, thanks to our people, resources and experience.

Find out how Zilog's System 8000 can help your business. Call Zilog Systems at (800) 841-2255. Or write: Zilog Systems, Corporate Publications, 1315 Dell Avenue, MS C2-6, Campbell, CA 95008.

*UNIX is a trademark of Bell Laboratories. Zilog, Inc. is licensed by Western Electric, Inc.

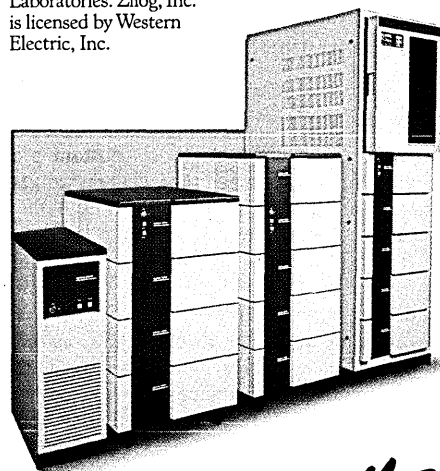

Zilog Systems

Zilog is an affiliate of EXON Corporation

CIRCLE 53 ON READER CARD

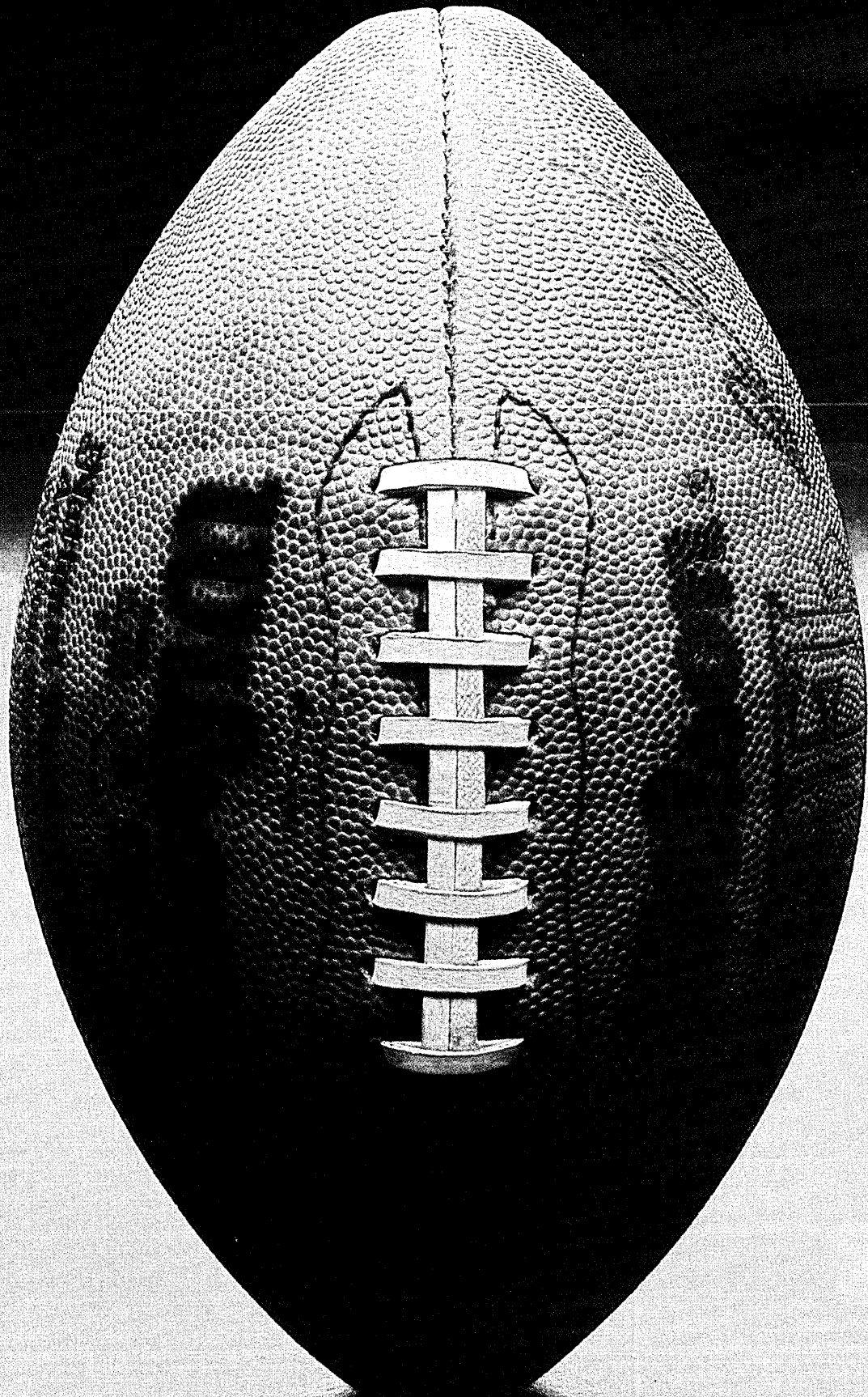

1983. A Very Good Year.

**NCR introduced the Tower,
a UNIX™ based microcomputer
with the power of a mini.**

NCR designed the Tower for UNIX, today's de facto operating system standard for multi-user 16-bit microcomputers. Then NCR made a number of enhancements to make the Tower easy to use at any level of computer sophistication.

NCR added a full featured, menu-driven database that you create in English. The Tower can be programmed in BASIC, Pascal, COBOL, and FORTRAN as well as UNIX's own language, "C". Spreadsheets, word processing and color graphic software are available now from NCR as well as from third-party UNIX software developers.

The Tower can communicate with any existing computer system from desktops to mainframes. Communications capabilities include SNA, X25, RBS, Tower-to-Tower, and Tower-to-Terminal networking.

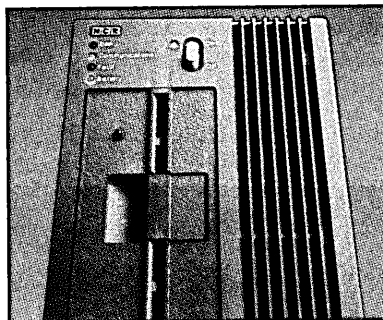

The Tower. A lot of power in a 29" x 27" x 7" box.

Optional add-ons include a streaming tape drive for disk storage backup.

The Tower has power. Internal memory can be expanded to two million bytes, external storage from our standard 30 million to over 200 million. Its operating speed is an impressive 10 MHz. NCR enhancements include detailed diagnostics, battery backup, error correcting code and a new memory management system. A typical four-user configuration, including operating system and the "C" language, would cost only \$16,495.

The Tower is in volume production now.

In 1983 NCR introduced more new data processing products than any other high tech company. We wanted to get a good start on our second hundred years. For more information call your local NCR office, or 1-800-CALL-NCR. In Ohio, 1-800-543-4470.

NCR

Shaping the way business
does business for 99 years.

CIRCLE 54 ON READER CARD

Up to 16 users can access the Tower at the same time.

UNIX is a trademark of Bell Laboratories.



NEWS IN PERSPECTIVE

complicated mess. They've accomplished something worthy of praise."

Pardon the university community if it doesn't join that chorus. While the change in authors may make the group slightly less paranoid, it won't make it less vigilant.

"This is a fight over R&D funds," says procurement expert Terry Miller of Government Sales Consultants. "Should the government have 100% of a discovery made under a contract which it supported, or should business be allowed to go out with it on its own? My sympathies lie with the government. If they paid for it, why shouldn't the public own it? But the university people figure that if it was their brains that did it, they should get the benefits."

"We won the battle," says COGR's Bush. "The question now is how does the war come out?"

It's going to take longer than anyone expected to find out the answer.

EFTS

IS "REAL" POS COMING?

Plans are afoot once again to connect cash registers to retailers' and customers' bank accounts.

by Edith Myers

Is "real" POS (point of sale) about to take off?

Probably not this year, but many see it happening soon. When EFT (electronic funds transfer) and POS aficionados talk about real POS, they're not talking about automating checkout counters, which has already taken off in a big way. They're talking about a direct debit of a customer account and a credit to a merchant account being activated at the point of sale.

The proliferation of what many call POS terminals—which are hooked up to in-store controllers or minicomputers for speedy checkout as well as for accounting and inventory control functions—is one reason often given by those who see real POS on the horizon.

"Complete POS is in the offing," said Jon Poppen, senior vice president of Booz Allen & Hamilton, at an American Bankers Association Bank Card Conference in Los Angeles in September. "All those stores with electronic cash registers for other reasons can do it with little investment."

A recent report by Creative Strate-

gies International Inc., San Jose, Calif., said EFT will be the most important factor influencing new POS systems in what Creative sees as a "dynamic" new phase for the systems.

The report said advances in EFT are bringing banks and retailers closer and providing added convenience to the consumer. "As terminals capable of handling bank credit card account numbers are installed and the necessary communications interfaces implemented, EFT applications will become widespread."

The study predicted that 75% to 85% of nonfood retail chains will accept bank cards into their POS systems by 1985 and that integration of retailing subsystems will develop further in the '80s and lead to more networking by all types of stores.

In California's highly competitive banking community, five of the state's largest banks have combined forces to form a nonprofit corporation to set up a shared point-of-sale network to be called Interlink.

The fact that retailers are moving to install sophisticated transaction equipment is one reason for the combined effort, according to Steve Yotter, vp of electronic product development at the Retail Marketing Division of Bank of America, one of the participants. He said lack of this equipment in the retail world, rather than an opposition to sharing, kept something like Interlink from being tackled earlier.

Participating with B of A are the Crocker Bank, First Interstate Bank of California, Security Pacific Bank, and Wells Fargo Bank. The system is expected to be operational late next year. Other banks will be invited to use the network but not to join the corporation.

John Fisher, senior vice president of Banc One Corp., Columbus, Ohio, pondered the future of such regional shared net-

works at the Bank Card conference. "Do we have to keep cookie cutting such systems as Interlink across the country?"

Poppen of Booz Allen thinks the complete POS networks of the future will be national. "Only those banks and nonbanks with nationwide networks can do it. Technology is reducing the opportunities for players to bring value to the customer. There soon will be very few players."

He wonders who these will be. "Perhaps the owners of the technology, the IBMs, the phone company, or maybe Sears or Penney with their networks."

Fisher told an audience at the Bank Card conference that "debit systems are being driven by network people, data processing people, not by you."

Ronald Wean, senior research scientist at Battelle Columbus Laboratories, Columbus, Ohio, said he sees the most activity with "real" POS in the petroleum industry.

Estimates by Battelle, based on an interest rate of 10% and the current volume of credit card purchases, put the total loss in float for the petroleum industry at more than \$411 million per year. Credit card purchases also produce significant losses in fraud and unauthorized purchases.

An alternative such as direct debit and credit from the point of sale is a natural for the petroleum industry. Wean said there are 23 pilot tests under way. "Arco has four. Chevron has thousands of NCR 2950s that can be upgraded to POS. Exxon has a test going in Houston with NCR. Gulf intends to install 3,000 POS devices and have them operable by the end of 1984. Phillips is just beginning with one up and it intends to have 4,000 stations automated by 1984. Texaco is just starting with one station in Houston it is testing with its employees," he said.

PENNEY'S NEW VENTURE

Stuart MacIntire is a banker turned retailer, temporarily, and now he's wearing what he calls a "joint hat."

In late September at an American Bankers Association Bank Card Conference, MacIntire talked of a new business he's forming. At that time he was director of Videotex Services for J.C. Penney Co., Inc., Minneapolis. Earlier he had been an officer with First Bank of Minneapolis. He was working at Penney's, he said, to form a new company to be owned primarily by Penney and a group of major banks, and, in a smaller way, by two unidentified firms.

The purpose of the new business: "To prepare to provide nationwide information and transaction service for financial institutions and their customers." MacIntire declined to reveal the name of the new venture or many details of its plans. He said it would begin operation this month.

While at First Bank, MacIntire was involved with a nine-month home banking

experiment with farmers in Fargo, N.D., in which, he said, he learned that home banking by itself is not enough. "You need a broad base of information and transactional capability to make it worthwhile." He said he also learned that "vendors will pay for access to Videotex subscribers."

He said Penney chose to become involved with the banks, because "banks have the customer bases, credibility, trust, and professional sales staffs." He feels the biggest barrier to the kind of system his new company hopes to develop is "how you price, package, and distribute—the total marketing function."

Reliability, MacIntire said, is another essential. "Our goal is: we'll allow one breakdown every three years and that one can't last more than three seconds!"

His new company's system isn't going to fall into place overnight, but "it's gonna happen. Not in '83 and not in '84 but by the end of '85 and the beginning of '86."

NEWS IN PERSPECTIVE

BENCHMARKS

CHILLED OUT: IBM surprised the industry in early November by letting it be known that it was no longer pursuing Josephson junction switching technology for high-speed computing. The technology had for many years been seen as far surpassing the capabilities of silicon semiconductors, because of its superconducting nature, which stems from operation at extremely low temperatures. IBM periodically publicized its work in the technology, publishing numerous technical papers that suggested Josephson circuits would eventually come to market in supercomputing architectures. Other manufacturers, including Honeywell, ICL, and AT&T, were known to have done research in the area as well. Meanwhile, former IBM researcher Sadeg Faris has formed a company named Hypres Inc. in Elmsford, N.Y., to build Josephson-based signal processing equipment. The company is backed by \$2 million in initial funding and has licensed IBM patents in superconducting semiconductor technology.

COUNTERSUIT: Software Arts Products Corp., the Wellesley, Mass., developers of the popular VisiCalc spreadsheet package, filed an \$87 million suit against VisiCorp, charging the latter with breach of contract, misrepresentation, and fraud. The suit follows VisiCorp's \$50 million breach of contract and fraud suit against Software Arts, which alleged failure to convert VisiCalc to run on the IBM Personal Computer, Digital Equipment 350, and other personal computers (Nov., Benchmarks). Software Arts seeks \$29 million in compensatory damages, which would be trebled if it won, and a ruling that VisiCorp's VisiOnCalc, the spreadsheet component of the VisiOn window manager, is covered by the two firms' original marketing agreement and royalty provisions. In general, Software Arts alleges that VisiCorp has not promoted VisiCalc as strongly as it once did and that as a result Software Arts has lost revenues. VisiCorp said it planned to defend itself "vigorously" against the charges.

TURNED DOWN: Transamerica Corp. was turned down by the Supreme Court in an attempt to appeal a lower-court ruling that IBM had not acted illegally against Transamerica in the computer peripherals business. Transamerica had entered the peripherals business in the early '70s but, along with more than a dozen other competitors, had suffered huge losses. The company filed suit, claiming IBM had engaged in illegal practices such as shifting the profits from outboard peripherals to in-board hardware and cutting prices. In 1978, Transamerica's lawsuit, one of many filed against IBM by competitors, ended after more than four months, when the jury remained deadlocked for 10 days. The trial

judge took over the case and ruled in favor of IBM. On appeal, Transamerica lost again last February, when an appeals court in the Ninth Circuit ruled that IBM had not illegally limited competition. The Supreme Court made its decision without comment.

CHAPTER 11: Computer Devices Inc., the troubled Burlington, Mass., maker of portable computers and terminals, filed for protection from creditors under Chapter 11 of the federal bankruptcy laws. The company also laid off another 40% of its work force, or about 80 employees, and replaced its president. Computer Devices experienced a \$5 million loss for the first half of fiscal 1983, ended July 2, caused primarily by sluggish sales of its DOT portable computer. The machine was designed to run the MS/DOS operating system, similar to that used on IBM's P.C., but was unable to use the same diskettes as IBM's standard-setting machine. Seaforth Lyle, the last remaining member of a Digital Equipment Corp. management team brought in to turn the company around, was replaced by executive vice president Robert Moore. Meanwhile, the company has been looking for a merger partner but has apparently found no takers. Computer Devices raised \$10 million in a public offering in the summer and then, when its financials slumped and a 40% lay-off was made, the firm was hit by an investor lawsuit. In its Chapter 11 filing, Computer Devices listed assets of \$18.5 million and liabilities of \$7.5 million. Only 500 of the DOT computers had been sold, it was noted.

VICTOR NO VICTOR: With a massive third quarter loss looming, Victor Technologies, Scotts Valley, Calif., laid off another 300 employees, bringing the total layoffs for the year to some 1,600 persons. The troubled maker of personal computers dug in its heels after a second quarter loss of \$11.1 million, which was expected to be exceeded in the third quarter. The company, which says it owes industry suppliers \$90 million, declined comment when asked if it was considering filing for Chapter 11 protection from creditors. It would only say that the fourth quarter is expected to show a loss as well, caused, it was claimed, by IBM's dominance of the personal computer market at a time when Victor was expanding its sales force and marketing efforts. The company, headed by Chuck Peddle, designer of the 6502 microprocessor and the Commodore PET microcomputer, went public early this year but has been in the red ever since. The majority of its sales are said to come from abroad, particularly in Europe where the company sells under the name Sirius.

FOR THE HOME: Productivity and business packages will beat out entertainment and software in the home market, says

Microcomputer Research Group, Mountain View, Calif., a four-person research and consulting organization. The statement is based on preliminary findings in a survey that ultimately will have queried 10,000 randomly selected U.S. households by phone. The study is scheduled to be completed by March 1984. The researchers also predict that home computer software sales will grow from \$900 million in 1982 to \$5.4 billion by 1987 and that the average unit price during that period will decline from \$90 to \$61. The end-user survey is also including key decision makers at 100 Fortune 500 corporations and will include statistics from publishers, distributors, and dealers. Members of Microcomputer Research Group are Dr. William Coggshall, president and founder of Software Access International Inc. and a cofounder of Dataquest Inc.; Dr. David E. Gold, president of David E. Gold Corp., a consulting firm serving the investment community and the computer industry; Ronald F. Kopeck, president of Kopeck & Associates, a technology consulting firm; and Charles A. Pesko, president of C. A. Pesko Associates, a market research firm specializing in information processing.

DELAYED: The N-Gen, Convergent Technologies' heralded intelligent workstation, was late getting off the blocks, according to one of the Santa Clara, Calif., firm's oems. Prototype units suffered from a power imbalance on the proprietary X-bus that connects the processor/RAM module to the disk modules. Apparently, rearranging or separating the modules caused the system to crash even when the power was turned off—only if the power source was completely disconnected could individual modules be moved around, according to sources. Production models were delayed a couple of weeks while engineers worked on the problem, and finally started shipping in late October—without the problem.

NEEDS HELP: Sniping at the management of Digital Equipment Corp. continues in the wake of its financial and product problems. Recently an analyst made the unheard-of public suggestion that Ken Olsen, DEC president and cofounder, step aside from day-to-day operations. "There is little likelihood of radical improvements at DEC until a major structural change occurs," wrote L.F. Rothschild analyst Frederick Cohen. "We have the highest regard for Olsen, but, while he has surrounded himself with very able lieutenants both in management and on the board, he dominates DEC more than any other ceo does in any company of DEC's size. Without being presumptuous, we believe that the appointment of a powerful chief operating officer who would tighten operations would be a welcome development for DEC's friends, customers as well as industry analysts."*

The man who designs software for American Can, American Greetings, Armour-Dial, Allied Van Lines, B. Dalton Booksellers, ComputerVision, Heublein, Hoover, Fairchild Industries, Masonite, Ore-Ida, Rand McNally and Lever Brothers.

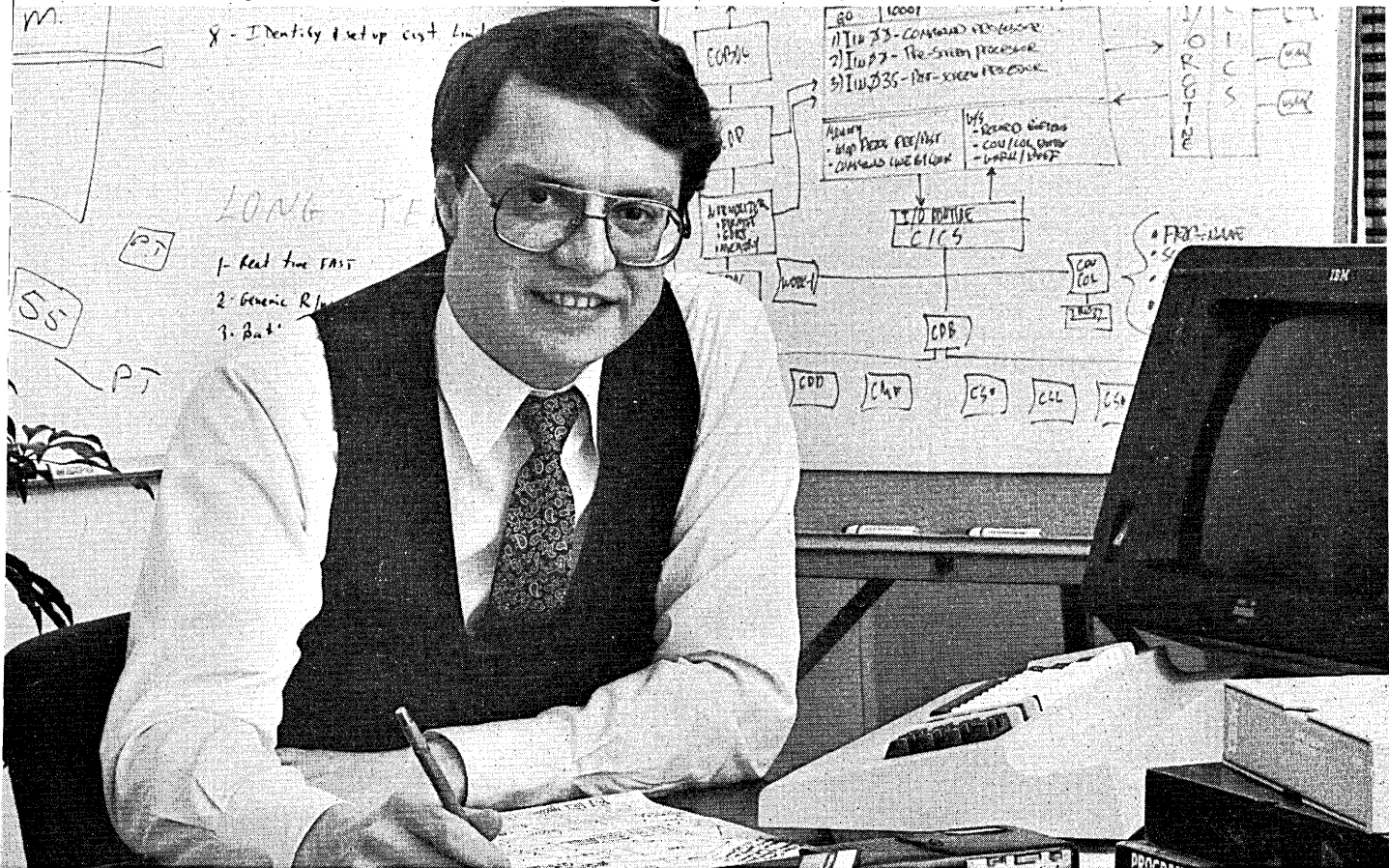

John Landry, Senior Vice President, Research and Development

He's a member of the McCormack & Dodge software design team, recognized as the best in the world by many of the world's best companies. Companies whose standards for internal financial performance are so high that any software but the fastest and most powerful is simply out of the question.

McCormack & Dodge has never restricted the research process by tying it to product marketing. We see real research as pure research. Research without limits. Dedicated to elevating the state of the art, not just the profits in a particular package.

As a result of our R&D, we now routinely offer systems that our competition is still talking about offering. Borderless query that lets you choose an audit trail and follow it to completion, criss-crossing data bases as you go. Interactive PC link that lets you upload and download information to the mainframe from your own desk.

There's a world of difference between today's software tomorrow and tomorrow's software today. Because we offer the latter, there's a world of demand for McCormack & Dodge.

Tomorrow's software today.

- | | |
|---|--|
| <input type="checkbox"/> Payroll/Personnel | <input type="checkbox"/> General Ledger |
| <input type="checkbox"/> Accounts Payable | <input type="checkbox"/> Purchase Order Management |
| <input type="checkbox"/> Fixed Asset Accounting | <input type="checkbox"/> Capital Project Analysis |

1-800-343-0325*

*Telex 174002

McCormack & Dodge

DB a company of
The Dun & Bradstreet Corporation

McCormack & Dodge Corporation, 1225 Worcester Road, Natick, MA 01760. Sales and support offices throughout North and South America, Europe, Asia, Australia and Africa.

CIRCLE 55 ON READER CARD

You'll be
impressed with
your Honeywell
computer.

If you
need service...
even more
impressed.



In evaluating a computer system, many users put service at the top of their list. So do we.

We start by making one individual responsible for your system's performance. He's highly trained

and knows you and your operation first hand. And he's the focal point of a person-to-person approach that makes communication more effective and the entire program more responsive.

The Honeywell service program includes varied resources to assist your representative

in meeting every eventuality. Like our National Response Center, operating 24 hours a day, seven days a week. Your one call here is all it takes to trigger action.

All of the historic data on your system is at their fingertips, all resources at their disposal.

Among these are our Technical Assistance Centers. Staffed by hardware and software

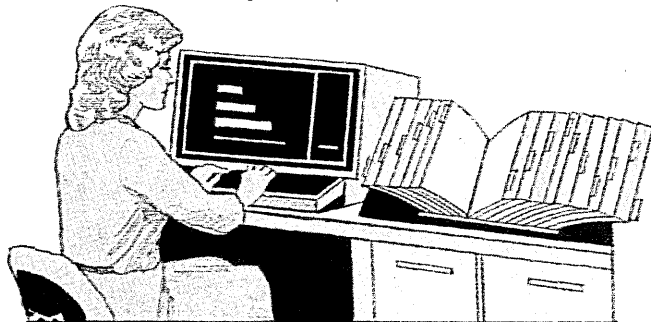
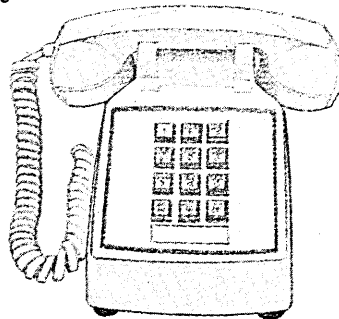

experts, each TAC is equipped with system documentation libraries and advanced capabilities to quickly diagnose your problem remotely.

If spare parts are required, you'll get them. Fast. Our nationwide on-line inventory tracking system and network of stocking centers allow us to locate and ship any part. Quickly.

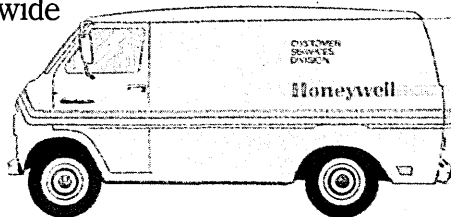

Still another element of our customer service is training. In addition to such basics as programming, we conduct classes in advanced areas such as data communica-

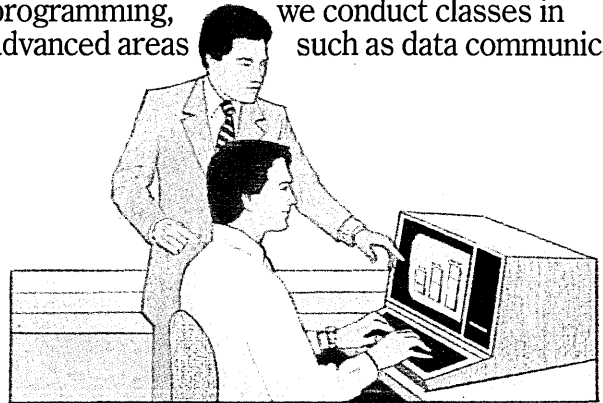

tions and database design. Using the latest computer-assisted learning techniques, these classes can be conducted at your facilities or ours.

There are no compromises in the quality of our service. But there are varying levels of service available that can be tailored to meet your system availability requirements. Our Customer-Assisted Maintenance Program (CAMP), for example, provides tools

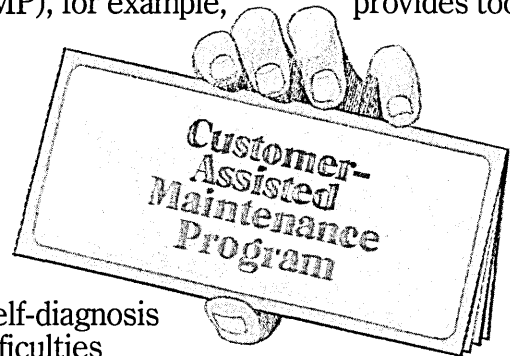

for self-diagnosis of difficulties and offers additional economies through parts replacement arrangements that include carry-in, mail-in, or call-in options for expedited delivery.

We call this comprehensive approach to system support TotalCare™ service. It represents all that we've learned in more than 25 years of serving the needs of customers all over the world.

For more information, call 800-328-5111, ext. 2702 (in Minnesota call collect 612-870-2142) or write Customer Services Division, Honeywell, MS 440, 200 Smith Street, Waltham, MA 02154.

Together, we can find the answers.

Honeywell

CIRCLE 56 ON READER CARD

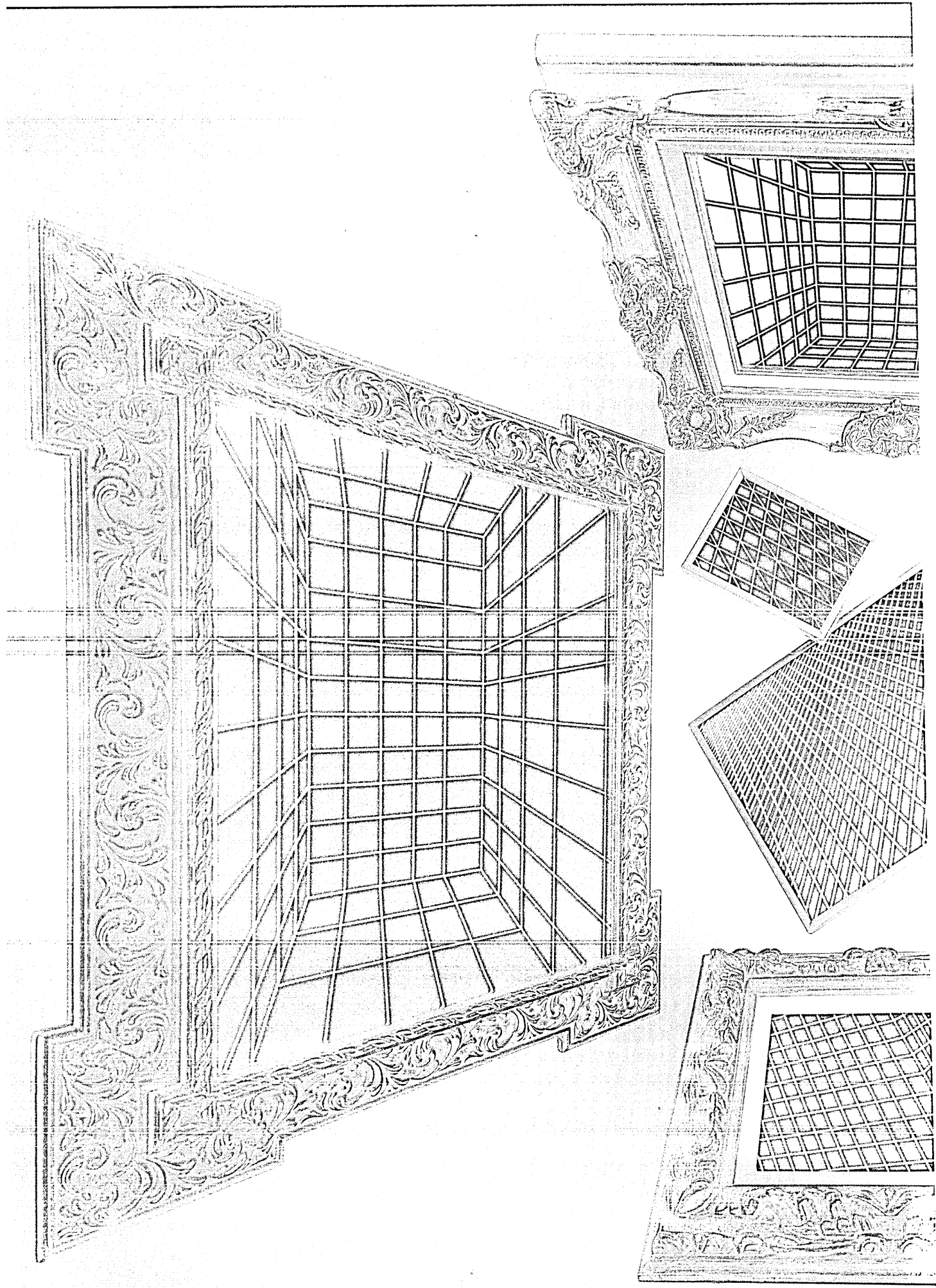

Users who made purchases from the gallery of systems software gave enthusiastic reviews of package performance and support.

SYSTEMS SOFTWARE REVIEW

Users who made purchases from the gallery of systems software gave enthusiastic reviews of package performance and support. The survey, conducted by Robert Brown, a principal analyst at the research firm, found that 85% of the respondents were satisfied with the performance of the software they had purchased. The survey also found that 80% of the respondents were satisfied with the support they received from the software vendors. The survey was conducted in the second quarter of 1992. The survey included 100 respondents who had purchased systems software in the past 12 months. The survey included questions about the performance of the software, the support they received, and their overall satisfaction with the purchase. The survey also included questions about the respondents' demographics, such as their age, gender, and occupation. The survey results are summarized in the following table:

The survey also found that 80% of the respondents were satisfied with the support they received from the software vendors. The survey was conducted in the second quarter of 1992. The survey included 100 respondents who had purchased systems software in the past 12 months. The survey included questions about the performance of the software, the support they received, and their overall satisfaction with the purchase. The survey also included questions about the respondents' demographics, such as their age, gender, and occupation. The survey results are summarized in the following table:

Users who made purchases from the gallery of systems software gave enthusiastic reviews of package performance and support. The survey, conducted by Robert Brown, a principal analyst at the research firm, found that 85% of the respondents were satisfied with the performance of the software they had purchased. The survey also found that 80% of the respondents were satisfied with the support they received from the software vendors. The survey was conducted in the second quarter of 1992. The survey included 100 respondents who had purchased systems software in the past 12 months. The survey included questions about the performance of the software, the support they received, and their overall satisfaction with the purchase. The survey also included questions about the respondents' demographics, such as their age, gender, and occupation. The survey results are summarized in the following table:

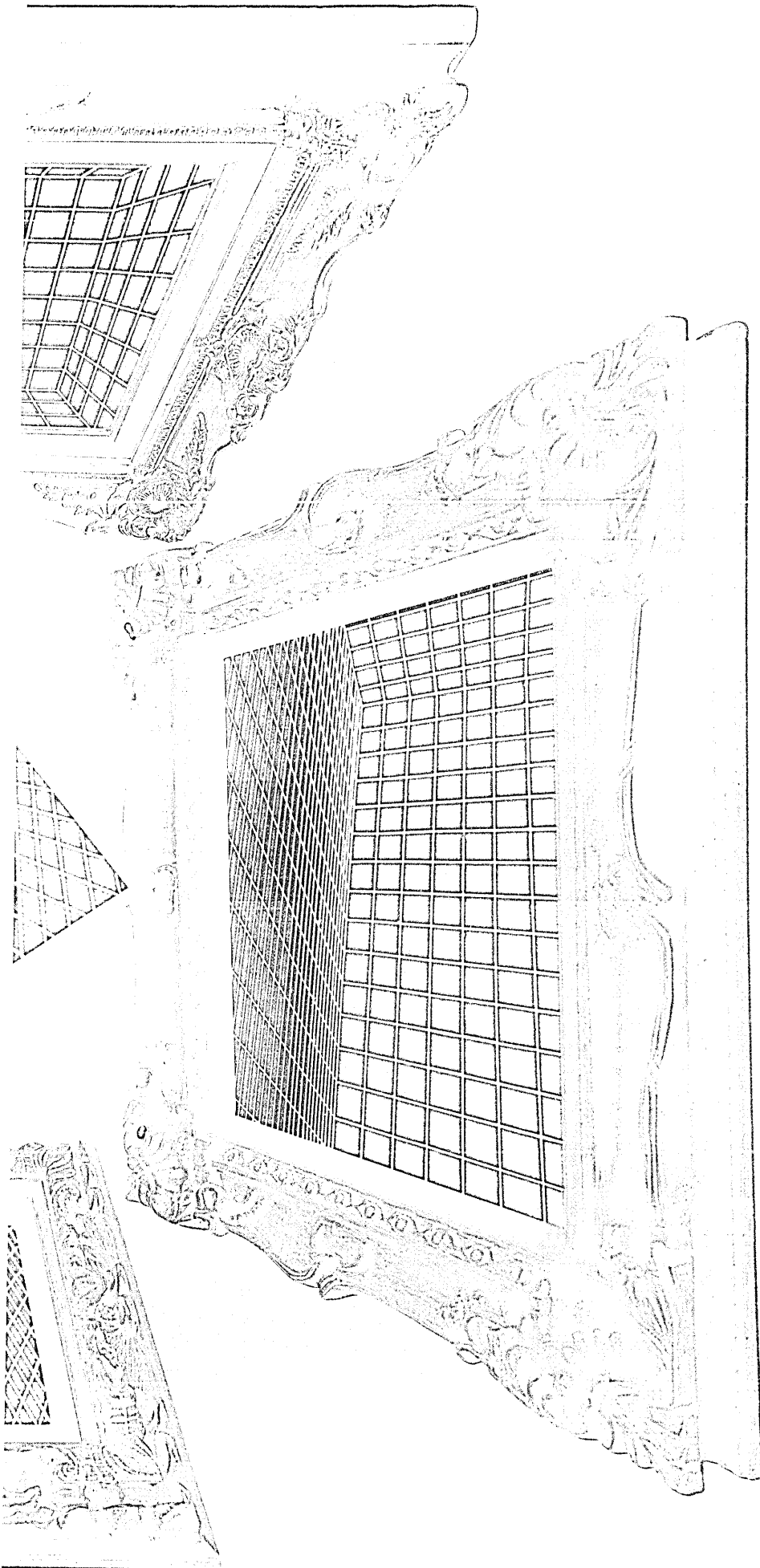

PHOTOGRAPH BY ROBERT BROWN

Support for communications packages received low ratings.

that 90% of the users reported that the packages met or exceeded the promised performance.

The SAS database management package, from SAS Inc., was the highest rated product, with a 9 out of 10. Other best of category packages, and the categories, are: Dylakor's DYL-280, with an 8.4 rating compared to other query and report writers; ADR's Vollie, with an 8.2 rating in the program development aids and utilities category; Westinghouse's WESTI, with a 7.9 for the communications category; Innovation Data Processing's Fast/Dump/Restore utility enhancement package; and Candle's Omegamon, with an 8.8 for the monitoring and performance aid category.

Product performance and vendor support ratings were consistent in all but one case. Communications software presents a paradox—the products rated 6.8 on average, but support lagged at 5.9. Many teleprocessing monitors from independent vendors no longer receive a vote of confidence, while some of the terminal support products are just starting to attract attention. Perhaps the developers of IBM compatible communications monitors have decided to leave the market to IBM and its CICS and retrench into other software product lines.

Throughout the survey, two categories consistently scored high. Utilities and monitoring aids received high ratings, 7.5 and 7.1 respectively, and no wonder. By their very nature, they are simple, straightforward, no-nonsense packages that offer the user quick installation and use. Very little training is required, documentation is usually adequate, and under normal circumstances, enough of these packages have been installed to minimize bugs and errors. Usually no special hardware is needed so the package makes no additional demands. Also, their high ratings can be explained as expected, given their limited and clearly defined capabilities.

SLIGHTLY LOWER SCORES

On the other hand, communications software usually requires special equipment and a highly trained individual to implement the package. The relative complexity of communications software, and the wide range of activities it addresses, would lead one to expect the slightly lower performance figures—group average of 6.6—that these packages received.

The popularity of monitoring and performance aids may be the result of the profusion of large IBM MVS-type systems—users have found it essential to employ control systems to optimize system resources. Monitoring products such as Candle's Omegamon, with over 500 sites, and Morino Associates' TSO/MON, with over 400 sites despite the fact

that it runs only on MVS, are becoming household words in the homes of large system operators. These products must be doing the job since they are so popular.

Database management systems (DBMS) are becoming more comprehensive than anyone had originally expected. They now include data dictionaries, query languages, maintenance and control utilities, and, in many instances, associated applications software. Vendors of these expensive systems have even set up interfaces for transaction processing on a local and/or remote basis.

Much attention has been paid to DBMS technology over the past five years. However, with the arrival of fourth generation languages and interactive development tools, the software-acquisition emphasis has shifted slightly from these large-scale products. The more popular DBMS vendors have responded to this shift and are beginning to provide micro-mainframe DBMS/DMS interfacing products. This approach has already been implemented by ADR and Cullinet. Relational versions of the more popular nonrelational DBMSs will also become more prevalent as the user-friendly (albeit resource intensive) nature of the relational system becomes more accepted.

In this survey data management and database management systems were combined in the same category. There may be some who feel that data management systems are less sophisticated, and in some instances this may be true. The data management systems of today, however, are much more complex than many people think. In fact, it is often difficult to determine where the data management function ends and the database management function begins.

While DBMS vendors are modifying their products to meet changing needs, standalone query and report writer systems are finding it difficult to compete both with DBMSs and with new application development tools now being introduced. Not too many years ago, every sophisticated data processing installation had its favorite query/report writer system, but, as users moved to a centralized processing environment, the capabilities of these products were incorporated into totally integrated systems. Coupled with this, new application development tools encourage people without data processing backgrounds to start programming reports that had previously been done by the dp department. The introduction of the microcomputer, with its spreadsheet packages and other programming tools for the nontechnical user, has all but stolen the glamour from the standalone query/report writer systems. In many cases, vendors have integrated these older products into other packages in their product line and

sold them as a unit.

Copy routines, file reconstruction routines, sort programs, and other utilities are the backbone of every reasonably-sized data shop. There are companies that have enjoyed great success marketing only these packages, and as long as we use complex and sophisticated operating systems, they will continue to be in much demand. Their simplicity of function and ease of installation and support result in consistently higher average ratings than for any other categories. In the Data Decisions study, nine products in the utility category attained average mean scores of 8 or higher while only six products received comparable ratings in all the other categories combined.

The replacement operating system market is another story. There are relatively few replacement systems, and these too may well disappear from the scene. Aside from the very real problem of what to do with existing applications, the complexity of the IBM operating system environment makes it financially infeasible for a competitor to try to capture an appreciable market segment.

More action can be seen among products that address disk space management, library control and maintenance, and generalized data manipulation/resource management activities. They will always rate high because their limited operating capabilities are so well delineated that the user doesn't attempt anything beyond the defined scope of the product's design. These products fill today's needs, and, in the foreseeable future, they will probably remain a mainstay of the medium- to large-scale user shop.

The charts that follow indicate how the various kinds of products fared against one another in areas such as performance, vendor maintenance, and operations. User thoughts on the product and the support services overall are also included.

HOW THE PRODUCTS PERFORMED

As for specific ratings, Performance was the first addressed. Users were asked to rate, on an ascending scale of 1 to 10, their product's economy and efficiency in terms of hardware resource utilization, ease of use, freedom from program bugs and errors, and the time required for initial installation. With 1 representing the lowest and 10 the highest score, the average performance composite for all packages was 7.0. However, because the six categories differ significantly in terms of function, sophistication, and complexity, the group averages for individual categories are more significant: utilities and operating systems enhancements had a 7.4 group average; program development aids and programming utilities received a 7.1 rating overall; monitoring and performance aids also scored a

AT THE FOREFRONT OF THE REVOLUTION IS THE MULTIFUNCTION WORKSTATION.

Seven years ago, DATAPOINT ignited a revolution in business communications with the introduction of ARC® (Attached Resource Computer®), the original local area network. Today the ARC local area network is the most thoroughly proven system of its kind, bringing distributed processing and desktop computing to businesses around the world. The 8600 multifunction

workstation is a vital part of that success, leading the continuing revolution in communications, software, processing power, and ease of operation.

The DATAPOINT 8600 high-performance processor features data processing, word processing, data communications, business applications software, and system operations in one compact unit. It can communicate

with your existing mainframes as well as with other DATAPOINT equipment. When attached to an ARC local area network, it becomes the basis of a system that can expand as far and as fast as your business expands.

If your company wants to join the revolution, talk to our worldwide sales and service force about the 8600. It could put a spark of the revolution in your office.

THE DATAPOINT 8600.

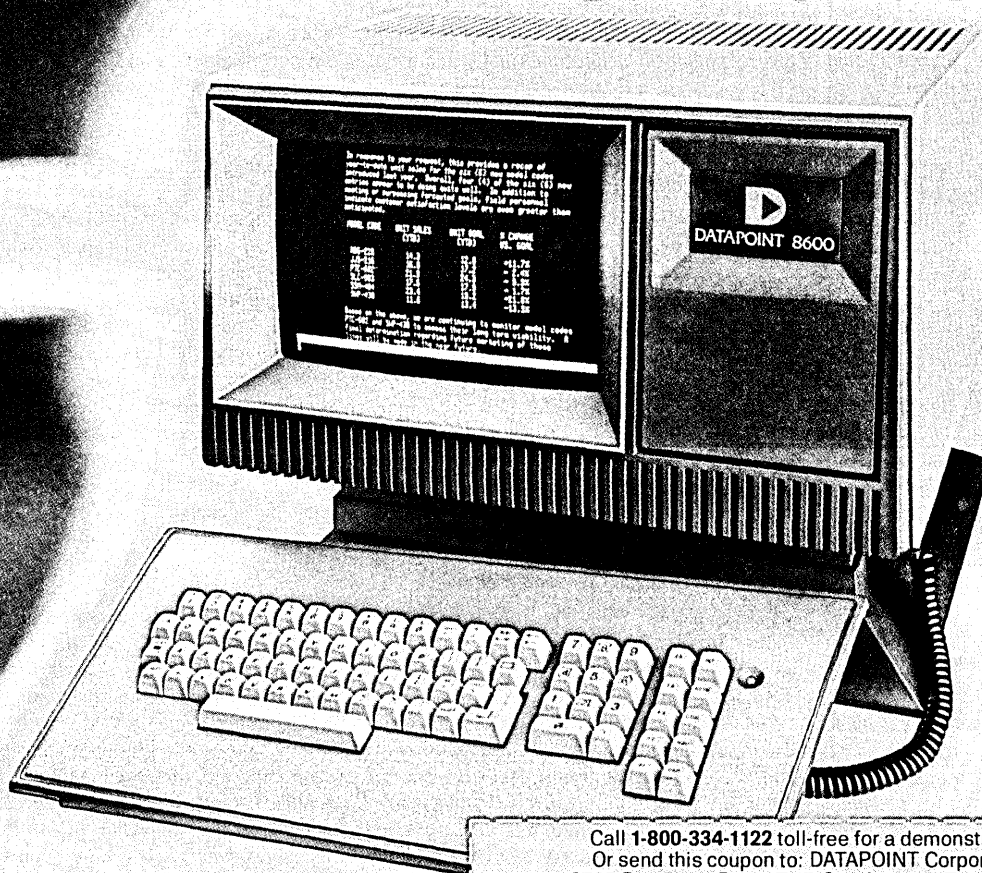

Call 1-800-334-1122 toll-free for a demonstration. M051
Or send this coupon to: DATAPOINT Corporation,
9725 Datapoint Drive, T-47, San Antonio, Texas 78284

Name _____ Title _____

Company _____

Address _____

City _____ State _____ Zip _____

Telephone (_____) _____

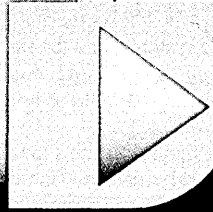

DATAPOINT

We sparked the revolution.

About 30% of the communications software users said they may change vendors.

7.1; database and data management packages rang up a 6.8; query and report writers and DBMS aids, 6.6; and communications software, a 6.6.

The ratings assigned to database management and data management systems are a healthy sign that vendors are providing users with what they need. The high rating for the program development aids/programming utilities category (which includes development languages) indicates that significant performance improvements can be realized from their use.

The Vendor Support section contains responses to questions on the vendors' responsiveness to users' needs, the effectiveness of the training supplied (where training is applicable), and the quality and usability of the documentation. The composite average for all packages was 6.3. The individual group support averages were utilities and operating systems enhancements, 6.5; monitoring and performance aids, 6.4; program development aids and programming utilities, 6.3; database and data management systems, 6.2; query and report writers and DBMS aids, 6.1; and, communications software, 5.8.

Understandably, the degree of support often correlates with the complexity of the product, and this factor is evident in the results. Support for relatively simple products such as utilities is usually judged less harshly than support for more sophisticated, complex, products such as DBMSs and communications software. The operations category dealt with how well the package handled expanding processing volume, backup/recovery, and security. The average composite for all packages was 6.7. The individual group averages were utilities and operating systems enhancements, 7.2; monitoring and performance aids, 6.8; program development aids and programming utilities, 6.8; communications software, 6.4; database and data management systems, 6.4; and, query and report writer and DBMS aids, 6.3.

DBMSs and communications systems software are the major categories where backup/recovery and security are of major concern, and the relatively low ratings achieved by these types of systems should be construed as a warning signal to vendors of transaction-oriented products.

After respondents rated specific characteristics, they were asked to give an overall satisfaction rating on the package itself and on the quality of the vendor's support. They gave the products a rating of 7.1. The rating for support services, however, was only 6.4.

Utilities and operating systems enhancements received a product average of 7.5 and a support average of 6.7. Database and data management packages received a 7.1 for products and a 6.3 for support. Program de-

velopment aids and programming utilities received a 7.1 for the product and a 6.4 for support. As for monitoring and performance aids, the average was 7.0 for the product and 6.5 for support. Communications software received a 6.8 and a 5.9, and query and report writers and DBMS aids received a 6.8 and a 6.2, respectively.

The survey identified four basic types of support commonly offered by software vendors: on-site support; telephone hot line; on-line support, where the user's computer is remotely hooked into a diagnostic computer at the vendor's support site; and mail. In many cases, the respondents were using more than one form.

The database/data management product from SAS Inc. had the highest rating for vendor support with an 8. It was followed by the query, report writer, and DBMS package of Dylakor, with a 7.9 rating. Runners-up for support were Vollie, from ADR, with a 7.4; Tone 3 from Tone Software, and WESTI, from Westinghouse, tied at 7.2; Fast/Dump/Restore, from Innovation Data Processing, with an 8.5; and TSO/MON, from Morino Associates, with an 8.

A total picture of how each package measured up against the average for its category and for all the products in the survey is provided by the bar graphs at the end of this article.

PHONE RESPONSE POPULAR

The most popular form of quick response support was telephone consulting, used by 90% of the respondents. Because of the high level of diagnostic expertise available at most vendor installations, this makes sense. More surprising, perhaps, is the fact that over half the respondents, 54%, still use the mails, and that their rating of this support is still relatively high, 6.1.

Another figure that could be considered surprising is the 41% response showing the use of on-site support. It is not uncommon for a vendor to assign someone from a nearby support office to attend to a large customer's needs, and vendors are trying to expand their sales and support capabilities so they can be within easy reach of any major account. Although on-site support is very expensive, users are obviously taking advantage of the proximity of available assistance. Clearly many users are willing to pay big money to deal with one person who knows the staff, the idiosyncracies of the systems, and the ins and outs of the applications it is running. And the average rating of 6.5 shows that the level of satisfaction is relatively high.

On the other hand, on-line support, a technique that several vendors (including IBM) attempted to sell to large system users,

has never become particularly popular. The number of users employing it is low, only 14%. Even more important, the average rating of 5 shows that performance in this area is only "acceptable," while all other types of support were rated "very good." Some of the reasons could include the cost of establishing the original hookup, or the interface may be too complex. The lack of human interface might pose psychological problems for the customer. How many times have you hung up the phone when a machine asks you to start talking when you hear the beep?

Needless to say, certain types of software lend themselves more to one type of support than to another. As one might expect, users of the more complex software products, such as DBMSs and communications systems, were significantly more likely to use on-site support than were users of other types of products—55% versus an average of 41%.

In addition, DBMS users utilize on-line problem diagnosis at a rate of 26%—almost double that for any other type of user. The two categories with support services rated higher than the others—utilities, monitoring, and performance aids—are also the two with the lowest percentage of users utilizing on-site support.

Smart managers are always looking for products that deliver value for the dollars they spend. To determine whether our systems software users felt they had realized this goal, Data Decisions asked them to characterize the value of their packages. Overall, 49% of the users of the average package felt they had received excellent value for their investment; 35% said their package offered outstanding features, while 14% reported that the package provided good features at a low price. Respondents who felt they had acquired good value made up 43% of the response. This includes 8% who felt they had packages with outstanding features, but at a high price; 32% who said they had acquired good features at a comparable price; and 3% who reported that their acquisitions lacked features but were priced low enough to make them worthwhile. Only 4% thought their packages were poor values. This total was split equally among those who felt they had installed packages with good features, but at a very high price, and those who had installed systems that lacked necessary features and were overpriced as well.

Thus, over 90% of the respondents regarded their packages as excellent or good value for the money, and over 80% said their acquisitions contained good or outstanding features at comparable or low prices. Competition among software suppliers has had much to do with these results, but we shouldn't overlook the more educated selection processes being incorporated in many installa-



We're not big in OS software.

We're Giants.

Just because Computer Associates is the world's dominant DOS software company, maybe you thought we weren't much of a factor in OS software. The fact is, our very first product was developed for the OS system, and we've been developing OS software for over ten years.

We have a product line of OS packages that's positively gigantic, backed by awesome service capabilities.

Best of all, our software products are integrated — they can talk to each other. The benefit to you is far greater productivity than from any programs acting alone.

The integrated approach to diverse software has

made Computer Associates the pre-eminent systems software company in the world. We have over 13,000 satisfied customers, over 24,000 products installed, and over 50 OS/DOS and VM products combined — of which over 20 are designed specifically for the OS data center.

But just because we're big doesn't mean we're too big for our britches. We're ready and anxious to service even the smallest data processing department to help increase its productivity.

Take a giant step forward for your company. Contact your local CA Account Manager now. Or call 800-645-3003. In NY: (516) 333-6700.

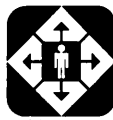

COMPUTER ASSOCIATES

Computer Associates International, Inc.
125 Jericho Turnpike Jericho, New York 11753

CIRCLE 58 ON READER CARD

Previous experience with the same vendor doesn't count for much.

tions. This combination of competition and increasingly sophisticated buyers should keep these vendors on their toes and ensure that they continue to deliver the types of products up-to-date users demand at a price that is fair and equitable.

Every data processing manager has been involved in a software package selection process. During this exercise, much time is spent listening to salespeople describe what the company needs and how the package will meet those needs. Sometimes, however, after the sale has been made, the salesperson has to rush back to the development site and prod the resident genius into figuring out how to modify the product to meet the claims. If the customer is lucky, the modifications are made with little or no effect on the installation. In some instances, however, the modifications are never done, or they have an undesirable effect on the performance of the package. To help clarify this problem, respondents were asked to judge whether three areas of package performance exceeded, met, or failed to meet vendor promises. The response was overwhelmingly positive. Installation time exceeded promises in 9% of the cases; met promises, 81%; and did not meet promises, 6%. As for features and capabilities, the packages exceeded promises 9%, delivered 83% of the time, and failed 5%. In performance, speed, and efficiency, the rates were 8%, 81%, and 7%, respectively.

PACKAGES FULFILLED PROMISES

With over 90% reporting that their packages either met or exceeded the performance promised by the vendor, the chance of a major mismatch based on promised capability seems far less likely today than it was in previous years.

Although the responses from users of all six types of packages closely followed the percentages reported for the overall survey, some interesting deviations occurred. For example, the percentage of respondents who said their products did not meet promises in terms of performance was higher in the database/data management group than in any other (12%), and users of query/report writer/DBMS aids felt almost the same way (10%). Ten percent of the communications software users responding to this question reported that their acquisitions did not meet vendor promises when it came to installation time. Again, we see that the more complex software entities carry with them high expectations but less-than-expected results.

To determine how much influence various factors have on the selection process, users were asked about seven points of consideration likely to come into play during the selection process. Then they were asked questions that explored pre- and postacqui-

sion procedures. Finally, users explained why they were thinking of replacing their packages.

The capability and features of the package were cited as the major influence by 81% of those polled, with 10% considering features a minor influence and 3% responding with no influence. Productivity and ease of use were cited as a major influence by 66%, with 22% saying "minor influence" and 6% saying "no influence." Compatibility was a major influence for 60%, a minor influence for 20%, and of no influence for 14%. Vendor presence and reputation is less of a factor than everyone assumes—37% say it is a major influence, 41% say it is a minor influence, and 16% say it has no influence. The costs and implementation time is a major consideration for 30%, a minor influence for 41%, and of no influence for 22%. Prior experience with the vendor is a major influence for 20%, a minor influence for 18%, and of no influence to the majority, 55%. The least important influence is advice from others—13% say a recommendation is a major influence, 18% say it is likely to be a minor influence, and 62% say a good word from a third party is of no influence.

It seems likely that a good experience with a vendor with whom one has had previous dealings would carry more weight than the 55% "no influence" rating, but today's better informed users don't seem to let past experiences influence current selection processes. This means that vendors continually have to prove themselves and their products.

Although most of the percentages within the six groups followed patterns similar to those shown in the overall breakdown, there were some interesting deviations. In the monitoring and performance group, 88% of those answering the question felt that specific features and capabilities were of the utmost importance. This was a solid 7% greater than the average and may indicate that, when selecting this type of package, the user has well-defined expectations concerning improvement and is looking for features that will deliver these capabilities.

A rousing 22% of the respondents rating database/data management packages indicated that software compatibility had no influence on their selection. This is not too strange, when one considers that installing a DBMS normally implies that new applications would have to be written to accommodate it.

Finally, 73% of the respondents rating program development aids indicated that productivity and ease of use were the major influences governing their decision. This high percentage was balanced by a low of 56% in the monitor and performance aids group who felt that ease of use was of major importance. The very nature of the user-

friendly software promised by most developers of these tools probably accounts for the 7% above average figure, while the users of fine-tuning tools expect specialists to interpret the results and are not necessarily looking for ease of use. Also, monitors and performance aids are not directly involved in productivity, only indirectly as a result of the analyses performed by them.

61% SAW OTHER PACKAGES

How many of us go out and buy the first item we see? Not many. Fortunately, the same holds true for most installations in the market for software products. Users were asked whether they had evaluated alternative packages, from either the computer manufacturer or independent software vendors, before acquiring the package being rated, and to indicate the number of prior reviews in both cases. It turned out that 61% had evaluated alternative packages; 33% had evaluated an average of 1.6 packages from computer manufacturers; and 50% had evaluated an average of 2.5 packages from independents.

Historically, independent software suppliers have provided more efficient, less expensive, and generally more effective alternatives to the manufacturers' products. The poll indicates that this is still true. It appears that, in the communications software area, computer manufacturers are actively competing with the independents—44% of the users checked out vendor alternatives. On the other hand, independent utilities and report writers seem to be clear favorites, with 50% and 58% of the users evaluating their alternatives—a trend that has been observed for many years. The monitoring and performance aids marketplace has been dominated historically by independent software suppliers such as Boole & Babbage, Morino Associates, and, more recently, by companies such as Candle, so there is less evaluation of alternatives in this area—only 52% of the users—than in any other. This is undoubtedly because the technology is relatively new, and there are relatively few independent vendors.

The growth of software technology is so dynamic that one must continually compare packages being used against those that have become available since their acquisition. As for postacquisition evaluation, it turned out that 22% had evaluated alternative packages after acquisition; 9% had evaluated an average of 1.3 packages from manufacturers; and 14% an average of 2.1 packages from independents. Thus, almost a quarter of the respondents are involved in some form of postacquisition review, and they seem to be looking more toward the independents than to manufacturers for possible replacements. Of course the reason for this might be that most

Everyone in favor of office automation, raise your hand.

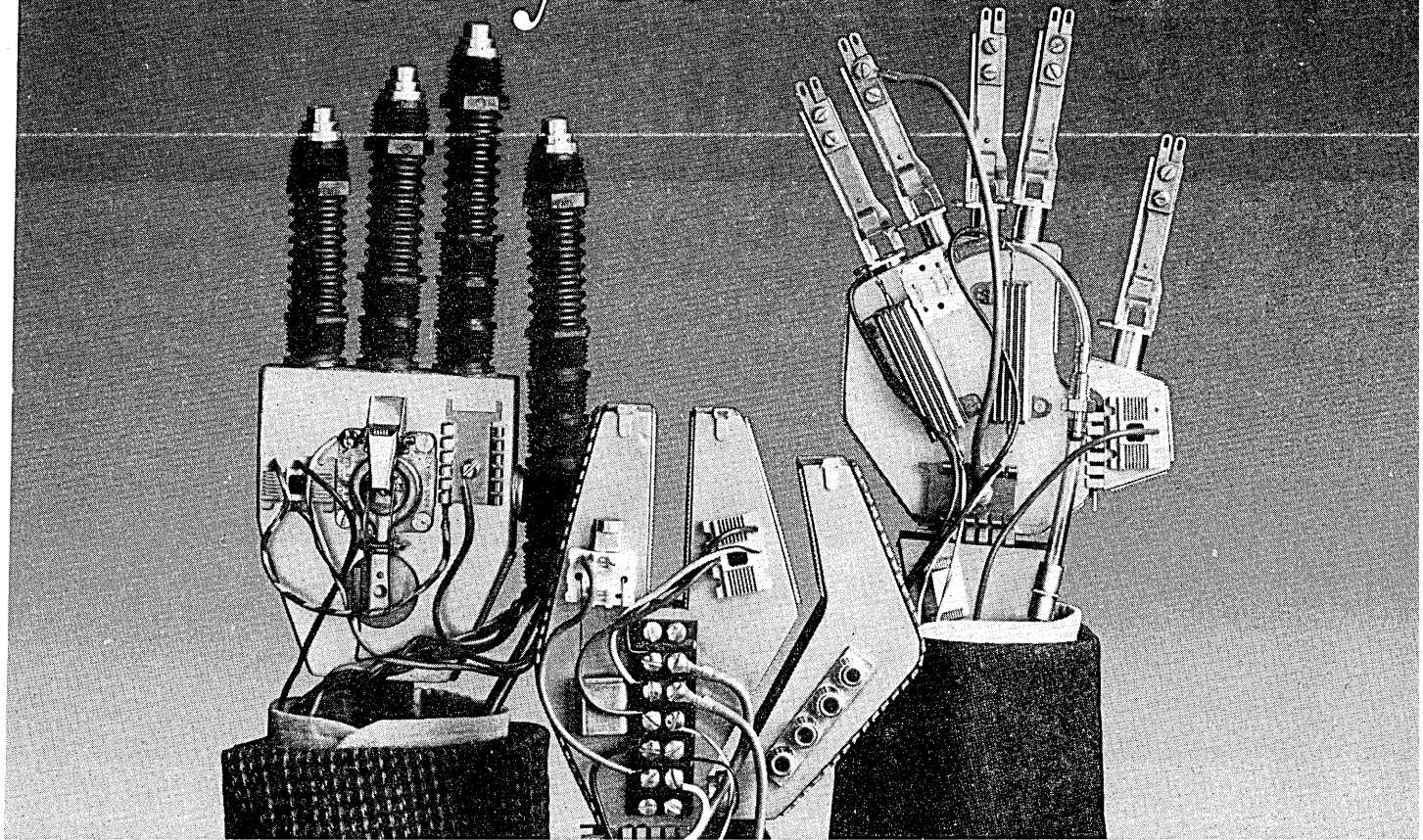

If people were more like machines, office automation might work a little better.

Fortunately there's a new alternative. Office Humanation™ helps people work a little better.

It means computers do things the human way, instead of humans doing things the computer way. It means information at your command, instead of at your inconvenience. It means machines you can train, so you don't have to be retrained.

CXC replaces automation with humanation. We've created the Rose™, a single central nervous system for your office that relates to

the way humans work. It handles all voice and data communications on one revolutionary integrated local area network and telephone switching system.

We've created the Rose Personal Teleterminal™, bringing voice and data to your desk in a single compact unit. It embodies the productivity of a computer—and the simplicity of a telephone.

And we've made possible dramatic savings. In dollar costs. In people costs. Because a job worth keeping is a job worth keeping human.

The Office Humanation Company. **CXC**

CXC Corporation, 2852 Alton, Irvine, CA 92714 (714) 760-7171. Personal Teleterminal™, Office Humanation™, Office Humanation Company™ and Rose™ are registered trademarks of CXC Corporation.

CIRCLE 59 ON READER CARD

If you don't we can c

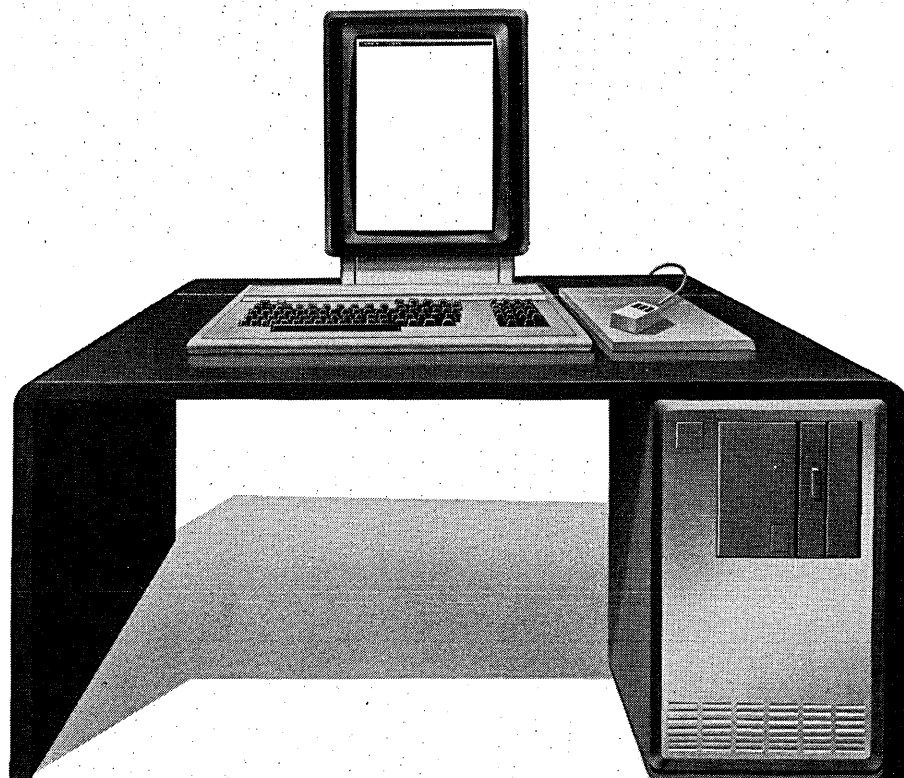

PERQ IS A TRADEMARK OF PERQ SYSTEMS CORPORATION. UNIX™ IS A TRADEMARK OF BELL LABORATORIES. ETHERNET™ IS A TRADEMARK OF XEROX CORPORATION. PERQ 2 IS A JOINT DEVELOPMENT PRODUCT OF ICL AND PERQ SYSTEMS CORPORATION.

As you can probably tell from the picture, this is an advertisement for one of the world's most advanced graphics workstations. It's called PERQ 2.

Now imagine that instead of looking at this ad in a magazine, it was up there on PERQ's screen.

The headline's wrong.

Too large, perhaps. Or in the wrong place. PERQ can change that at the push of a puck.

The wrong typeface, maybe? PERQ

a full implementation on PERQ of the UNIX™ operating system. This *de facto* international standard gives access to the large body of UNIX-compatible applications.

And we could enthuse about PERQ's extended networking capabilities via the industry standard Ethernet™ Local Area Network. And we still wouldn't have told you everything.

I don't like the style.

Suit yourself. PERQ places a whole box of graphics tricks at your fingertips.

like this ad, change it.

PERQ can model in 3D, for example, or function as an electronic airbrush, or magnify sections in detail. Again, not enough words, we're afraid.

will help you design a new one of your very own. And PERQ's ultra-high resolution graphics display will let you dot the minutest "i's" and cross the tiniest "t's."

The picture's wrong.

Hardly does PERQ justice, does it?

Well, you could ask PERQ to turn the picture upside down, or back to front, or inside out, or bring it to life and animate it...

There aren't enough words.

An unlikely complaint. But we could fill dozens of ads this size with details of all the applications PERQ offers for CAD/CAM, structural analysis, 3D modelling, drafting, simulation, circuit design, electronic publishing, and so on and so on.

Then we could tell you about PNX,

The whole ad's wrong.

Of course it is. Why on earth should you be interested in a computer that can simply shove around the component parts of a magazine ad?

But there again, next time you're designing and laying out a technical report, or analyzing structural stresses, or planning a new highway, wouldn't it be nice to be able to test your work, modify it, and improve it as easily as PERQ can change the page you're looking at right now?

No wonder PERQ 2 has already changed one thing absolutely: the standard by which all future graphics workstations will be judged.



We should be talking to each other.

The overwhelming majority—91%—of packages are still supported by the original vendor.

users bought the manufacturer's package originally, and therefore have to seek an alternate elsewhere.

When asked whether they are thinking of replacing their packages, 15% said yes, with 5% citing the need for features not available in the current package. Four percent indicated that they were upgrading or changing to a new computer system, 2% claimed that execution speed was too slow, 2% claimed that the package was generally unsatisfactory, and 1% claimed that it would cost too much to upgrade or expand the current package.

Why this general lack of activity? For one thing, software packages for mainframes and many minis can be a big investment, even for a large dp installation. When a user spends over \$100,000 for a database management system and many thousands more on implementation, application development, and other tasks, there is going to be great hesitance about replacing it. This might be one reason why relatively few are considering replacement, though many users are examining their options.

Another reason might be that, in many cases, the increasing speed of hardware compensates for certain throughput concerns that might have existed earlier. Finally, the low percentage of respondents considering replacement for generally unsatisfactory performance could be interpreted as a plus for the science of initial package selection. Don't forget, however, that the longer a package is installed in a production environment, the more dependent the operations become on that package since changing systems or operating system environments can involve great effort and cost.

A significant statistic reflected in the individual bar charts is that 30% of the communications software respondents indicated that they were considering changing their packages. This figure exceeds that for any of the other groups, where the figures ranged from a low of 10% for program development aids to a high of 17% for database management packages. A possible reason could be the dynamic nature of protocol and office automation communications advancements, which necessitate constant review of existing communications hardware and software.

In light of recent mergers, acquisitions, takeovers, and general realignment of the vendor/developer marketplace, is the original vendor still supporting the package, or is it being supported by a third party or by the user's in-house staff? The overall survey response showed that the overwhelming majority—91%—of the packages are supported by the original vendor, with only 4% supported by a third party and 3% by the in-house staff.

The bar charts show the response to questions on overall satisfaction, installation and initial use, vendor service and support, and operations criteria. Graphs are presented for all 106 packages that were sampled.

The overall satisfaction-product bar encompasses factors such as satisfaction with package features, capabilities, and utility and the frequency of failures requiring extra effort for recovery. Overall satisfaction-support services reflects the user's appraisal of installation, documentation, modification, and training support.

The bar labeled performance reflects economy/efficiency factors such as hardware resource utilization, ease of use, freedom from bugs/errors, and time required for the initial installation. The bar labeled vendor support gauges the vendor's responsiveness to user needs, effectiveness of training, and quality of documentation. The operations bar is a measure of the package's ability to handle expanding processing volumes, backup/recovery, and security.

Note: In split-bar presentations, the solid bar indicates package scores and the open bar the common group average.

Ratings Summaries

DATABASE/DATA MANAGEMENT PACKAGES—23 packages studied.

Mean Score

- 9.0—SAS Inc. SAS
- 8.0—Software House System 1022
- 7.9—Burroughs Corp. DMS-II
- 7.8—Hewlett-Packard Image
- 7.7—Cullinet IDMS, Information Builders Focus, Software AG ADABAS
- 7.1—Group Average**, ADR Datacom/DB, Cincom Total, Mathematica RAMIS II
- 7.0—Henco INFO, Honeywell DM-IV
- 6.9—Infodata Inquire
- 6.8—Sperry DMS-1100, Tominy Data Base Plus
- 6.7—National Information Systems DPL
- 6.6—Oceanic Systems Extracto
- 6.5—IBM IMS/DB, Intel System 2000
- 6.4—Advanced Data Management DRS
- 6.1—Applications Software Inc. ASI-ST, IBM SQL/DS
- 5.7—IBM DL/I DOS/VS

QUERY/REPORT WRITERS/DBMS

AIDS—13 packages studied.

Mean Score

- 8.4—Dylakor DYL-280
- 7.9—Dylakor DYL-260
- 7.2—Cullinet EDP Auditor/Culprit
- 7.1—Manager Systems Products (MSP) Datamanager, Pansophic Easytrieve
- 6.9—H&M Systems Keyfast
- 6.8—Group Average**, Computer Associates CA-EARL, University Computing UCC TEN

- 6.6—TSI Int'l. Key/Master
- 6.5—ADR Datadictionary
- 6.1—TSI Int'l. Data Analyzer
- 5.7—TSI Int'l. Data Catalogue 2
- 5.4—Informatics General Inquiry/IV

PROGRAM DEVELOPMENT AIDS/PROGRAMMING UTILITIES—13 packages studied.

Mean Score

- 8.2—ADR Vollic
- 8.0—On-Line Software Int'l. Intertest
- 7.8—Altergo Quota II
- 7.5—Cincom Mantis, IMSL Inc. IMSL Libraries
- 7.4—Pansophic O-W-L, Software AG Natural
- 7.1—Group Average**
- 7.0—Oxford Software UFO
- 6.8—Altergo CPG
- 6.4—ADR METACOBOL
- 6.3—Informatics General Mark IV
- 5.4—ADR Autoflow II

COMMUNICATIONS SOFTWARE—13 packages studied.

Mean Score

- 7.9—Westinghouse WESTI
- 7.6—Tone Software Tone 3
- 7.5—Altergo Shadow II
- 7.4—ADR Roscoe
- 7.3—Burroughs NDL
- 6.9—IBM CICS/VS
- 6.8—Group Average**, IBM IMS/DC, Software AG COM-LETE
- 6.7—Cincom Environ/1
- 6.6—IBM ICCF
- 6.2—Polygon Systems Intercomm
- 5.9—ADR Datacom/DC
- 4.8—TSI Int'l. Task/Master

UTILITIES/OPERATING SYSTEMS/ENHANCEMENTS—34 packages.

Mean Score

- 8.9—Innovation D.P. Fast/Dump/Restore
- 8.7—Corodale System/Manager
- 8.6—Macro 4 Logout/Multilog
- 8.5—Synsort Inc. SYNCSORT, Westinghouse Disk Utilities
- 8.4—Cambridge Systems Group ACF2, Software Pursuits DOS/MVT/VSE
- 8.2—Computer Associates CA-Sort
- 8.1—Software Module Marketing—DMS/OS
- 7.9—CGA/Allen Super-MSI, Computer Associates CA-RAPS, Compuware Abend-Aid
- 7.7—Informatics General Shrink, University Computing UCC One
- 7.6—ADR the Librarian
- 7.5—Group Average**, Computer Associates CA-DYNAMT, Minicomputer Systems MICOS, SDI EPAT, University Computing UCC Seven

At any moment it can happen:

A power outage wipes out your computers, and when it does, you lose big—in time, money and in important data.

What's more, power fluctuations are not only a problem for computers, but for many other types of sensitive electronic equipment. Telecommunications systems,

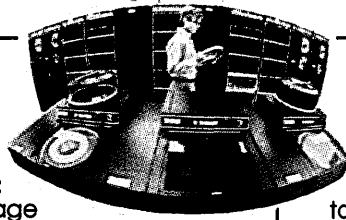

Available in models ranging from 400 VA to 25 kVA single-phase and 10 to 50 kVA three-phase, Elgar UPS feature full kVA load rating from 0.7 lagging to 0.9 leading P.F. All three-phase and single-phase units rated 15 kVA and higher include a full electronic static switch as a standard feature. Other models are available with the static switch as an option. Elgar can deliver the right



This sight strikes terror in the hearts of all computers.

security equipment, process-control devices and laboratory instruments—

all rely on clean, continuous power.

Elgar has the solution—an Uninterruptible Power System (UPS) that provides total protection against out-of-the-ordinary power conditions for your AC line. In addition to blackout protection, an on-line UPS constantly filters the utility and regulates the output voltage, eliminating virtually every power line problem without interruption or switching.

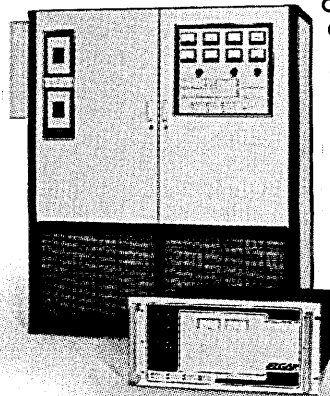

system for you—from the Mini-UPS, designed primarily for low power applications such as microprocessor-based

systems, data acquisition equipment and smaller microcomputers—to the large 50 kVA UPS employed with large data processing equipment or other sensitive systems.

To put it simply, when you order a UPS from Elgar, we'll deliver complete, continuous power from clean-up to back-up—and a much rarer commodity: peace of mind.

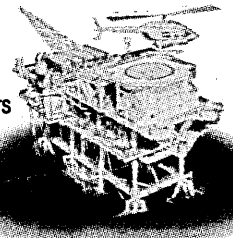

Powerful Solutions for Advanced Technology

Call today for complete information:

1-800-854-2213

ELGAR

An Onan/McGraw-Edison Company

8225 Mercury Court
San Diego, California 92111
Telephone (619) 565-1155
TWX: 910-335-1246 Telex: 6834028

The packages in this year's survey were installed, on average, for 39 months.

- 7.4—Cambridge Systems Group ASM2, Computer Associates CA-DYNAM/D, Johnson Systems OS/DOS/JARS, Pansophic Panvalet, University Computing UCC Eleven
- 7.1—Tower Systems D/Fast
- 7.0—Computer Associates CA-TLMS
- 6.9—SDI Grasp, Tower Systems T/Fast
- 6.8—Johnson Systems UMAX
- 6.7—Nixdorf EDOS, Pace KOMAND

- 6.3—Computer Associates GA-Jasper, University Computing UCC Two
- 5.5—Computer Associates CA-Scheduler

MONITORING AND PERFORMANCE

- AIDS—10 packages studied.
- Mean Score
- 8.8—Candle Omegamon
- 7.8—Morino Assoc. TSO/MON
- 7.3—ADR Look

- 7.2—BGS Systems Best/1
- 7.1—BGS Systems Capture/MVS
- 7.0—Group Average
- 6.9—Boole & Babbage Control/IMS/Realtime
- 6.7—Boole & Babbage TSA/PPE
- 6.5—Boole & Babbage CMF/Monitor, Resolve-Resolve/CICS
- 5.1—Value Computing Comput-A-Charge

METHODOLOGY

The survey, designed by Data Decisions, was conducted in July 1983. Packages from independent vendors were selected using the Million Dollar list from International Computer Programs, Indianapolis, as a source. Only vendors with packages identified by ICP as having grossed \$5 million or more in sales were included. Packages from hardware manufacturers were included if at least 30 user sites were recorded on a database supplied by Computer Intelligence Corp., La Jolla, Calif.

Where possible, user site samplings were obtained directly from the vendor. A special delivery letter was sent to each company asking for a list of the 125 most recent customers who had had the designated package installed and running for at least six months as of June 1, 1983. If a package didn't have that many qualified users, the company was asked to supply its complete customer file. Companies were also asked to certify that the list provided actually represented their most recent customers and that they would make no attempt to contact those customers with regard to the survey. (Respondents were also asked whether they were contacted by the vendors.) A minimum of two follow-up telephone calls were made to each company to encourage it to participate. If a vendor failed to provide a site list, Data Decisions contacted the sites registered on the CI list.

The Mailing

In total, 9,961 questionnaires were sent to identified users of 108 packages during the last week of July 1983. As an incentive to respond, a \$1 bill was included.

About 57%, or 5,667, of the questionnaires were returned; 105 questionnaires were undelivered by the post office. To ensure a minimum response rate of 40% and a minimum user base of 15 interviews for each package, Data Decisions conducted telephone interviews among those who didn't respond. The questionnaire used was identical, and 88 telephone interviews were completed. This brought the number of survey responses to 5,755, for an overall response rate of 58%. Seventy-four additional interviews conducted on two products

resulted in less than 15 user responses per product, and these products were dropped from the survey and eliminated from the overall package totals. This brought the total response to 5,681 completed questionnaires on 106 packages.

The Questionnaire

A questionnaire was mailed to the key vendor contact at each installation, usually the data processing manager or head of the dp operation for the company. The questionnaire first qualified the respondent as a bona fide user and then explored the factors that resulted in the ratings.

Types of Packages Surveyed

This year, the packages were installed, on average, for 39 months, with a low of 31 months for monitoring and performance aids and a high of 54 months for communications software. The overwhelming majority of the packages were running on IBM machines.

Eighty percent of the respondents stated that the principal system for the package was installed on IBM. Amdahl and DEC accounted for an additional 3% each; NAS and Burroughs accounted for 2% each; and Magnuson, Sperry, Hewlett-Packard, Honeywell, Data General, Control Data, and IPL Systems each registered 1%. Adding to-

gether all the IBM-compatible systems—Amdahl, NAS, Magnuson, and IPL Systems—reveals that approximately 87% of the 106 packages in the survey run on IBM-class systems.

The packages included in this year's survey have been divided into six categories on the basis of their functions: Database/Data Management Packages, Query/Report Writers/DBMS, Program Development Aids/Programming Utilities, Communications Software, Utilities/Operating Systems/Enhancements, and Monitoring and Performance Aids. Users were asked to rate them on various capabilities, using a scale of 1 to 10, with 9 to 10 for superior, 6 to 8 for very good, 3 to 5 for acceptable, and 1 to 2 for inadequate. Entries are arranged in descending order by mean score. Although these figures give a good general indication of the relative popularity of the various packages, minute gradations should not be taken too literally. Without further investigation one would be hard put to say that a package with a score of 7.0 was definitely better than one with a score of 6.8. If the original vendor is not the current vendor of the package, the original vendor's name is shown in parentheses after the name of the current vendor.

AV. TOLERANCES FOR 68% CONFIDENCE LEVEL

SAMPLE SIZE	OVERALL SATISFACTION			SPECIFIC ATTRIBUTE RATINGS		
	6.0 or Under	7.0	8.0 or Over	6.0 or Under	7.0	8.0 or Over
60 or more	.25	.20	.15	.30	.25	.20
40 to 59	.30	.25	.20	.35	.30	.25
30 to 39	.35	.30	.25	.40	.35	.30
Under 30	.45	.30	.25	.50	.45	.35

The chances are approximately two in three that a reported rating differs by no more than the indicated tolerance from the rating that would have been obtained had all eligible sites been surveyed. For example, suppose a sample of 38 sites gives a software package rating of 7.0 for Overall Satisfaction. The table indicates a tolerance of .30 on this estimate. Thus, the chances are two in three that the interval 6.70 to 7.30 includes the rating that would have been obtained had all eligible sites been surveyed.

Ratings Values

10-9: Superior
8-6: Very Good

5-3: Acceptable
2-1: Inadequate

Legend

■ Specific Product Rating
□ Group Average Rating

OVERALL SUMMARY

Average—All Packages • 106 packages
5,171 responses • 79% judged package and 66% judged vendor outstanding • 15% actively seeking to replace package, with 2% citing unsatisfactory performance as reason.

DATABASE/DATA MANAGEMENT PACKAGES

Group Average • 23 packages
1,089 responses • 77% judged package and 64% judged vendor outstanding • 17% actively seeking to replace package, with 3% citing unsatisfactory performance as reason.

DRS • Advanced Data Management, 15-17 Main Street, Kingston, NJ 08528 • 609-799-4600

39 responses • 67% judged package and 49% judged vendor outstanding • 21% actively seeking to replace package, with 8% citing unsatisfactory performance as reason.

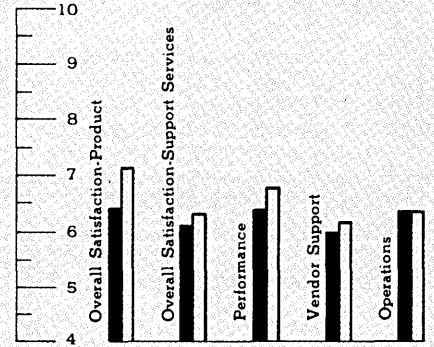
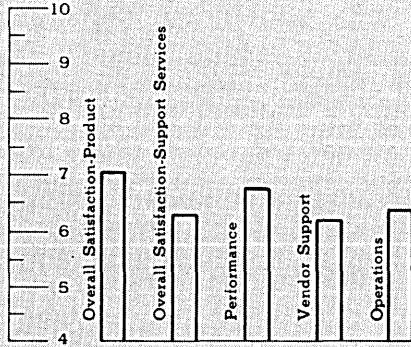
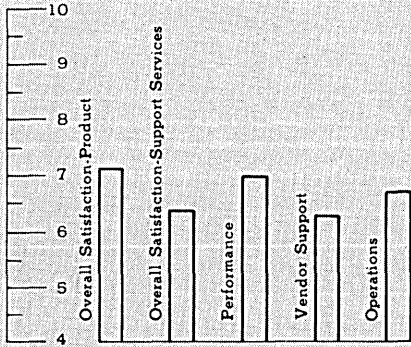

ASI-ST • Applications Software, Inc., 21515 Hawthorne Blvd., Torrance, CA 90503 • 213-540-0111

16 responses • 63% judged package and 69% judged vendor outstanding • 25% actively seeking to replace package, with 12% citing unsatisfactory performance as reason.

ADR/DATACOM/DB • Applied Data Research, Rt. 206 & Orchard Road, CN 8, Princeton, NJ 08540 • 201-874-9100

53 responses • 79% judged package and 59% judged vendor outstanding • 17% actively seeking to replace package, with 4% citing unsatisfactory performance as reason.

DMS-II • Burroughs Corporation, Burroughs Place, Detroit, MI 48232 • 313-972-9127

54 responses • 89% judged package and 59% judged vendor outstanding • 9% actively seeking to replace package, with 2% citing unsatisfactory performance as reason.

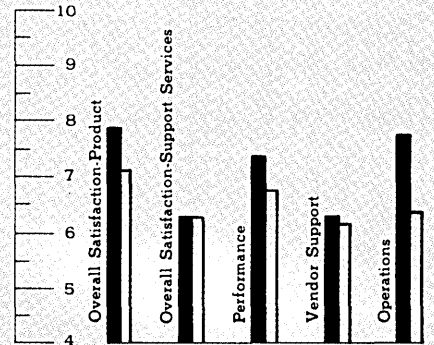
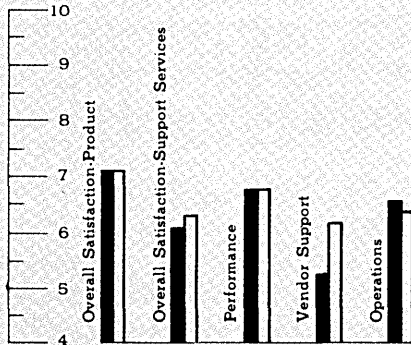
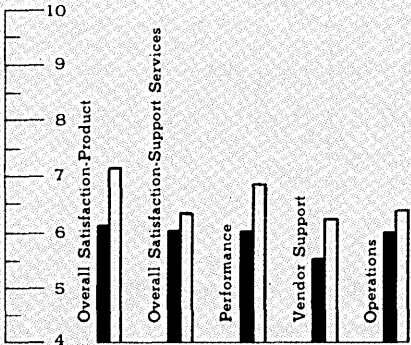

TOTAL • Cincom Systems, Inc., 2300 Montana Avenue, Cincinnati, OH 45211 • 513-662-2300

53 responses • 79% judged package and 58% judged vendor outstanding • 38% actively seeking to replace package, with 4% citing unsatisfactory performance as reason.

IDMS • Cullinet, 400 Blue Hill Drive, Westwood, MA 02090 • 617-329-7700

61 responses • 90% judged package and 79% judged vendor outstanding • 2% actively seeking to replace package, with 0% citing unsatisfactory performance as reason.

INFO • Henco, 100 Fifth Avenue, Waltham, MA 02154 • 617-890-8670

50 responses • 82% judged package and 60% judged vendor outstanding • 12% actively seeking to replace package, with 6% citing unsatisfactory performance as reason.

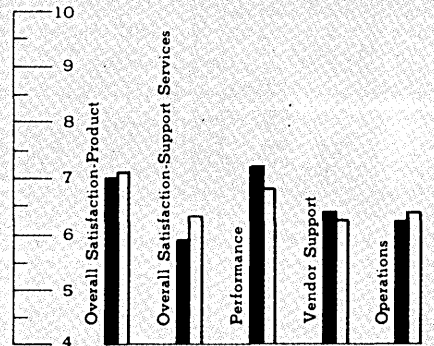
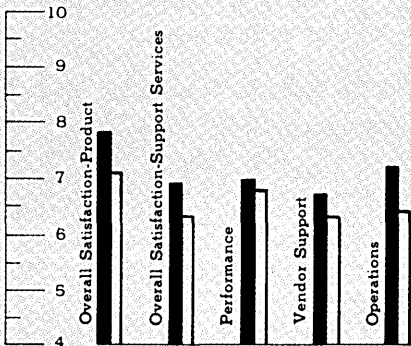
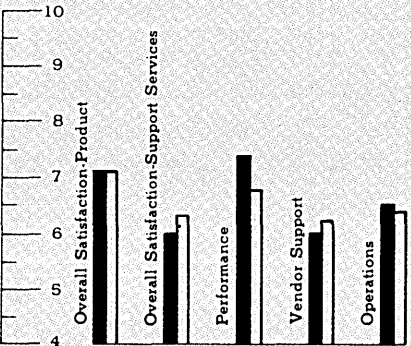

Ratings Values

10-9: Superior
8-6: Very Good

5-3: Acceptable
2-1: Inadequate

Legend

■ Specific Product Rating
□ Group Average Rating

IMAGE • Hewlett-Packard Co., General Systems Division, 978 E. Arquet Avenue, Sunnyvale, CA 94086 • 408-735-1550

59 responses • 86% judged package and 76% judged vendor outstanding • 5% actively seeking to replace package, with 0% citing unsatisfactory performance as reason.

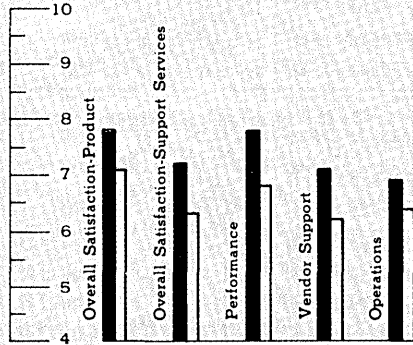

DM-IV • Honeywell Information Systems, Inc., 200 Smith Street, Waltham, MA 02154 • 617-890-8400

29 responses • 72% judged package and 59% judged vendor outstanding • 24% actively seeking to replace package, with 0% citing unsatisfactory performance as reason.

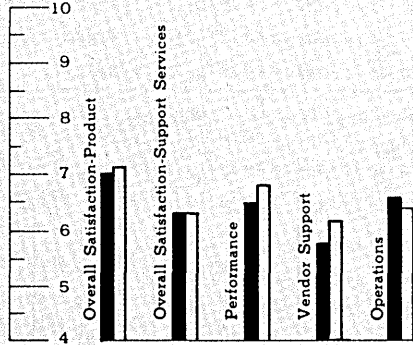

DL/1 DOS/VS • IBM, National Accounts Division, 1133 Westchester Avenue, White Plains, NY 10604 • 914-696-1900

48 responses • 56% judged package and 58% judged vendor outstanding • 27% actively seeking to replace package, with 10% citing unsatisfactory performance as reason.

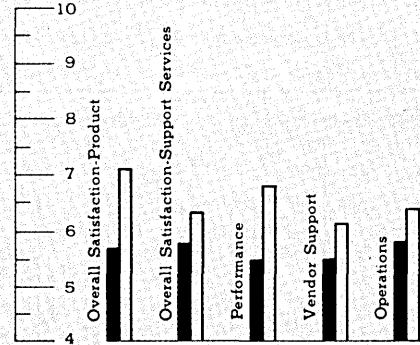

IMS/DB • IBM, National Accounts Division, 1133 Westchester Avenue, White Plains, NY 10604 • 914-696-1900

35 responses • 66% judged package and 54% judged vendor outstanding • 11% actively seeking to replace package, with 0% citing unsatisfactory performance as reason.

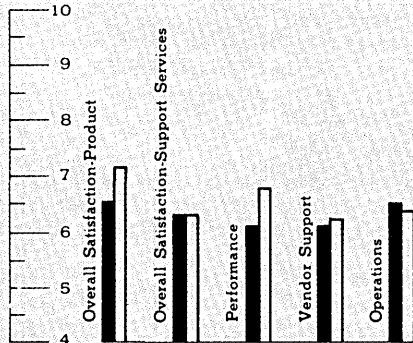

SQL/DS • IBM, National Accounts Division, 1133 Westchester Avenue, White Plains, NY 10604 • 914-696-1900

37 responses • 64% judged package and 60% judged vendor outstanding • 16% actively seeking to replace package, with 8% citing unsatisfactory performance as reason.

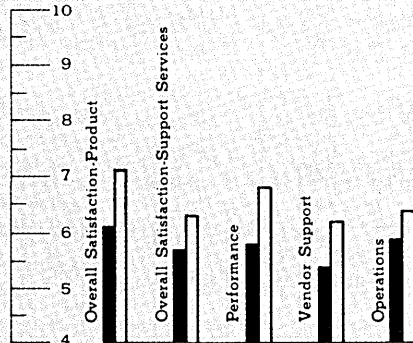

INQUIRE • Infolata Systems, Inc., 5205 Leesburg Pike, Falls Church, VA 22041 • 703-578-3430

57 responses • 75% judged package and 67% judged vendor outstanding • 10% actively seeking to replace package, with 4% citing unsatisfactory performance as reason.

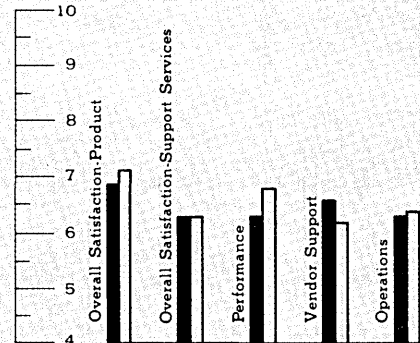

FOCUS • Information Builders, Inc., 1250 Broadway, New York, NY 10001 • 212-736-4433

58 responses • 90% judged package and 57% judged vendor outstanding • 9% actively seeking to replace package, with 0% citing unsatisfactory performance as reason.

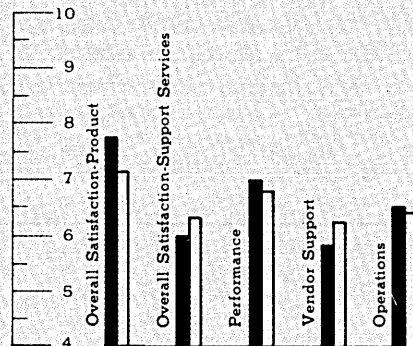

SYSTEM 2000 • Intel Corporation, 12675 Research Blvd., P.O. Box 9968, Austin, TX 78766 • 512-258-5171

51 responses • 69% judged package and 74% judged vendor outstanding • 18% actively seeking to replace package, with 6% citing unsatisfactory performance as reason.

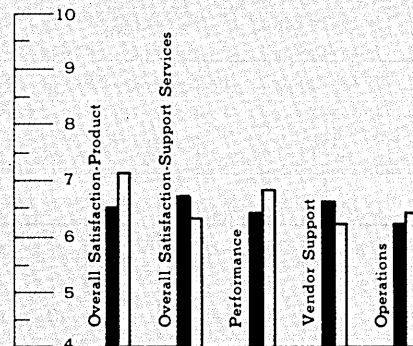

RAMIS II • Mathematica Products Group, Inc., P.O. Box 2392, Princeton, NJ 08540 • 609-799-2600

59 responses • 83% judged package and 76% judged vendor outstanding • 8% actively seeking to replace package, with 2% citing unsatisfactory performance as reason.

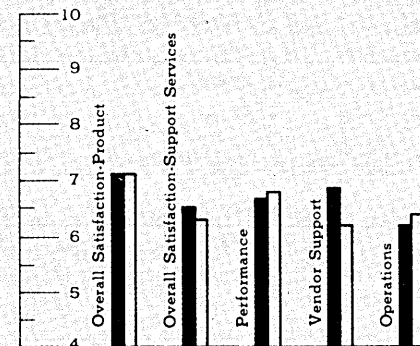



“GET IBM 3270, 3780 AND HASP COMMUNICATIONS—ADDING A ONE-BOARD PROCESSOR TO MY PC?”

“YOU CAN WITH PERSYST.”

The Persyst DCP/88. The only compatible front end communications processor that can support a range of IBM communications.

It's a Persyst exclusive. The DCP/88 distributed communications processor. A one-board computer that can be configured by software to handle communications between a PC and another computer system.

In fact, the DCP/88 enables the IBM or TI PC to support a range of sophisticated IBM communications—all with just one processor.

So it gives corporate users unprecedented, low-cost flexibility to incorporate the PC into virtually any environment.

Convert any PC into an IBM 3270 terminal. An IBM 2780/3780 RJE workstation. Or a HASP/RJE workstation—instantly.

Just combine the DCP/88 with Persyst software—and you can connect your PC to any compatible host mainframe or minicomputer.

PC/3270 enables your PC to emulate an IBM 3274 Cluster control unit and 3278 terminal, supporting up to four additional devices. Including a printer and

three other PCs functioning as 3278 terminals.

PC/3780 converts your PC into a 2780/3780 remote job entry terminal that can send and receive batch files to and from the host.

And with PC/HASP, your PC instantly becomes a full-function HASP/RJE workstation that can support up to seven input and seven output multi-leaved job streams concurrently.

Capability to support your communications needs now. And in the future.

Because the DCP/88 supports bisync, SDLC, HDLC and async protocols, it is the only communications processor you'll ever have to buy.

Use it to connect your PC to an expanding network of IBM communications. Configure your system to meet virtually any communications need—without adding another piece of hardware. Or expense.

All of which makes the DCP/88 as practical as it is powerful.

The Persyst Coax/3278. Still another way to expand your IBM communications.

Here's another fast way to incorporate the PC into existing SNA or bisync data processing installations.

The Coax/3278. A single-slot expansion board that converts your PC into an IBM 3278 display terminal. And with its high-speed coaxial port, you can connect the PC directly to IBM 3274 or 3276 cluster controllers.

Sophisticated communications products for the corporate user. Insist on Persyst.

Persyst communications products are designed to make corporate information systems more powerful. And more efficient.

Write or call Persyst today for complete information.

PERSYST™

Persyst Products, Personal Systems Technology, Inc., 15801 Rockfield Blvd., Suite A, Irvine, CA 92714. Telephone (714) 859-8871. Telex: 467864.

PC/HASP Dynamic design lets you assign incoming I/O streams to different devices—disk files, printers and RS-232 ports.

PC/3270 and PC/3780 transmit data at speeds up to 9600 baud.

Dedicated 8088 micro-processor gives the DCP/88 processing power equivalent to the IBM PC itself. You can execute two programs simultaneously.

High-speed line printer option—up to 600 lines per minute.

128 character FIFO printer buffer improves the efficiency of data transfer to the printer.

Supports SDLC, Bisynchronous, HDLC and Asynchronous protocols.

Two or four channel communications.

Full modem support, plus modem eliminator option.

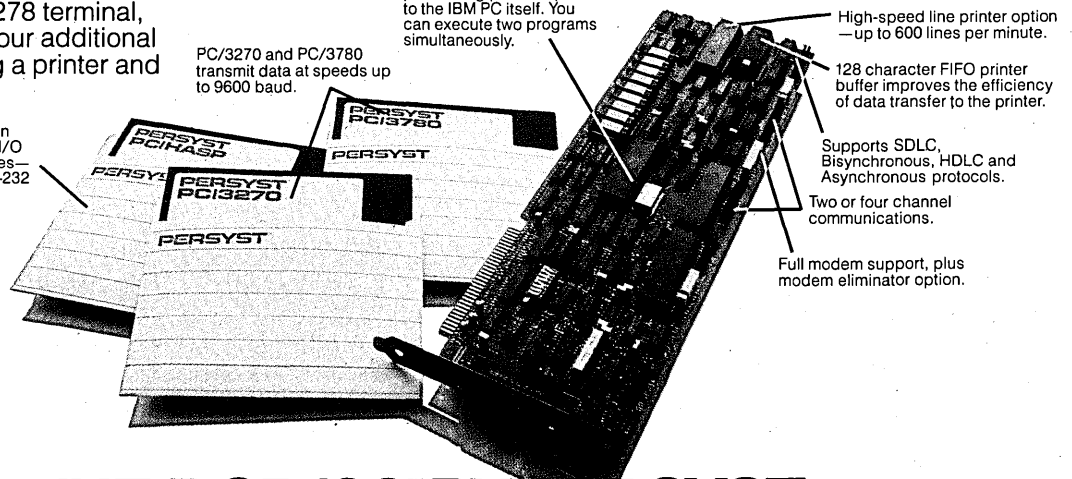

THE DCP/88™ BY PERSYST.

CIRCLE 62 ON READER CARD

A sure cure for the problem of information bottleneck.

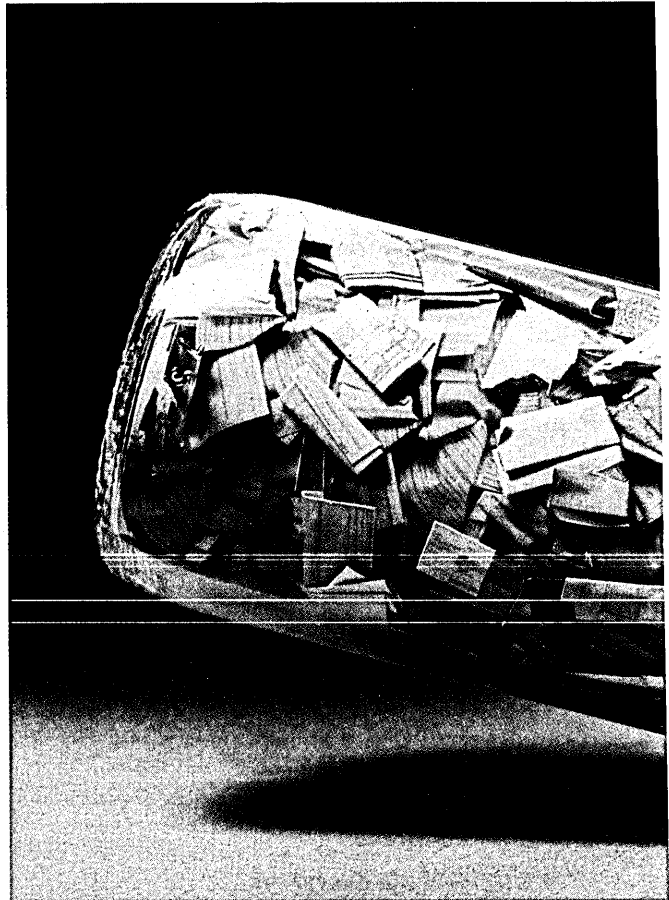

Programming backlog is the source of the problem. Eliminate it, and you eliminate the bottleneck.

Which is precisely what Sperry has done with the MAPPER™ System.

With MAPPER, you work with the computer directly. You ask questions in plain English. And you get immediate answers.

And if the information you get raises other questions, you can ask them right away. With no delay for programming. Or reprogramming.

MAPPER is that powerful. It allows you to manipulate information in almost any way you want. And, interesting to note, it can even help your programmers become more productive.

AN AFFORDABLE SYSTEM.

You don't have to be a large company to have a MAPPER System. MAPPER can be scaled to the real and present needs of just about any size company. The cost of a MAPPER System makes it practical for even a department

MAPPER is a trademark of Sperry Corporation. © Sperry Corporation, 1983

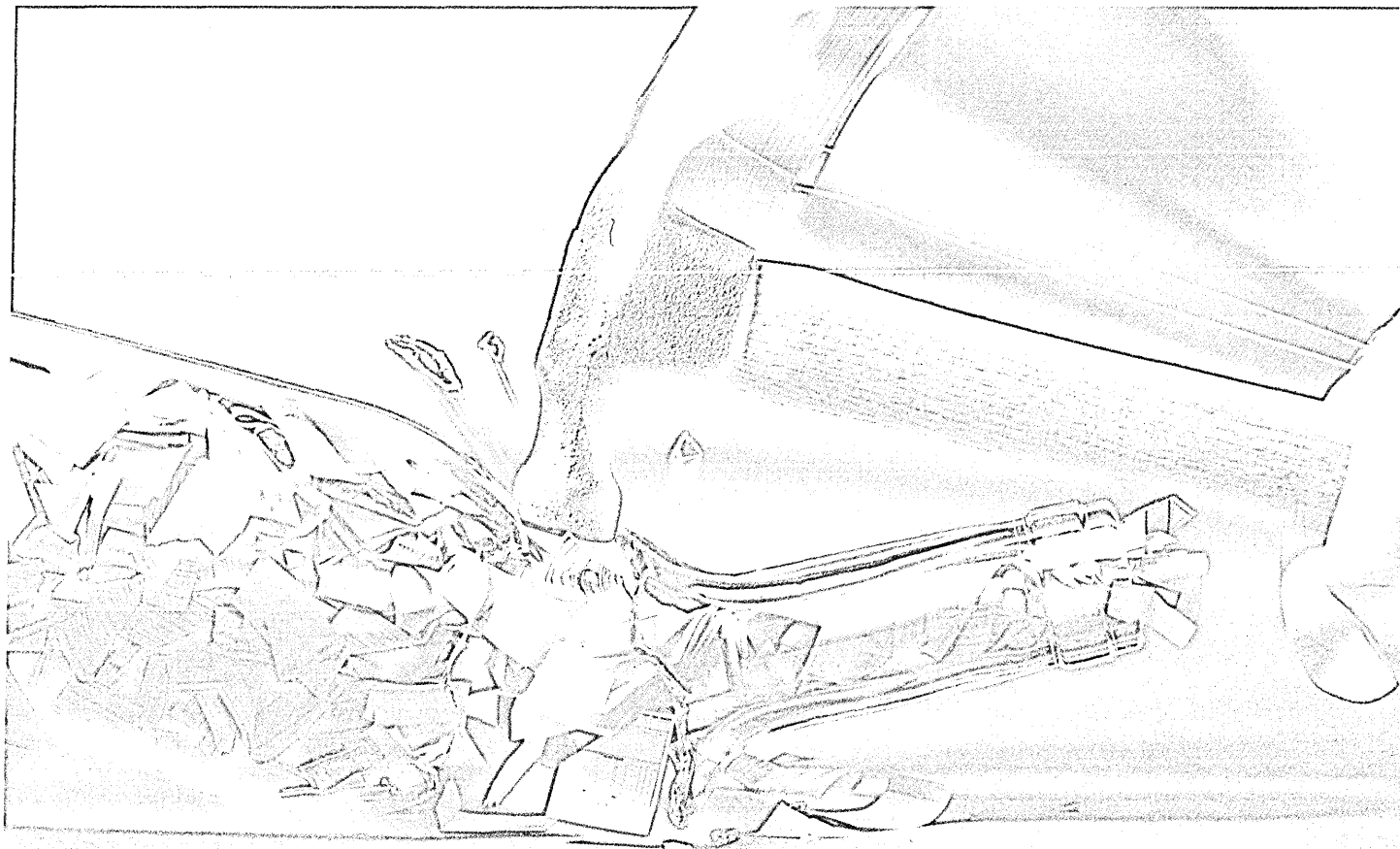

MAPPER™ SYSTEM

within a company to own its own system. Or you can time-share through a Sperry service bureau.

What you get for your money is a whole new order of efficiency in your day-to-day management tasks. Because you'll have the information you need right at your fingertips. Literally.

SEEING IS BELIEVING.
We've made some promises

here that may sound extravagant. But if anything, our claims are on the conservative side. And to prove it, we offer you the opportunity to see a demonstration of MAPPER at work.

800-547-8362

But first, you might want to look over our MAPPER brochure. A copy is yours for the asking. Call toll-free:

800-547-8362 (9 a.m. to 5 p.m. E.S.T.). Or send us the coupon.

Sperry Corporation
Computer Systems
Department 100
P.O. Box 500
Blue Bell, PA 19424
Please send me a brochure on the
MAPPER System.

DA 12 83-13

Name _____

Title _____

Company _____

Address _____

City _____ State _____ ZIP _____

Telephone _____

We understand how important it is to listen.



Ratings Values
 10-9: Superior
 8-6: Very Good

5-3: Acceptable
 2-1: Inadequate

Legend
 ■ Specific Product Rating
 □ Group Average Rating

DPL • National Information Systems, Inc., 20370 Town Center Lane, Suite 130, Cupertino, CA 95014 • 408-257-7770

41 responses • 71% judged package and 51% judged vendor outstanding • 46% actively seeking to replace package, with 5% citing unsatisfactory performance as reason.

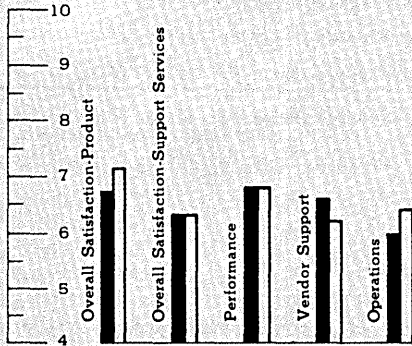

EXTRACTO • Oceanic Information Systems, Inc., 2197 Leon-Harmel, Quebec City, Quebec, Canada G1N 4N5 • 418-681-7741

23 responses • 57% judged package and 57% judged vendor outstanding • 35% actively seeking to replace package, with 9% citing unsatisfactory performance as reason.

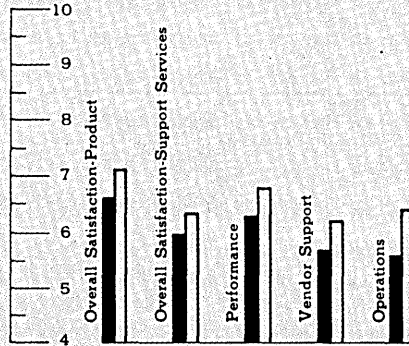

SAS • SAS Institute, Inc., SAS Circle, P.O. Box 8000, Cary, NC 27511-8000 • 919-467-8000

78 responses • 96% judged package and 88% judged vendor outstanding • 1% actively seeking to replace package, with 0% citing unsatisfactory performance as reason.

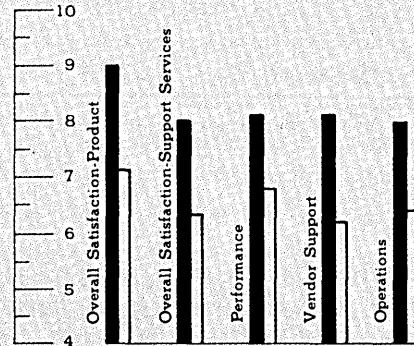

ADABAS • Software AG of North America, International Center, 11800 Sunrise Valley Drive, Suite 1517, Reston, VA 22091 • 703-860-5050

65 responses • 91% judged package and 63% judged vendor outstanding • 2% actively seeking to replace package, with 0% citing unsatisfactory performance as reason.

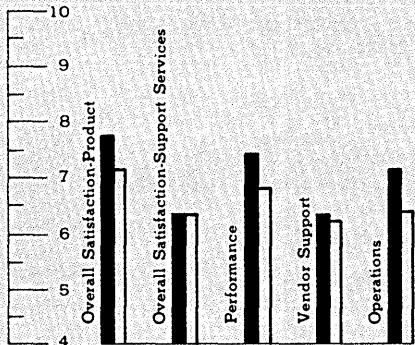

SYSTEM 1022 • Software House, 1105 Massachusetts Avenue, Cambridge, MA 02138 • 617-661-9440

61 responses • 93% judged package and 80% judged vendor outstanding • 15% actively seeking to replace package, with 0% citing unsatisfactory performance as reason.

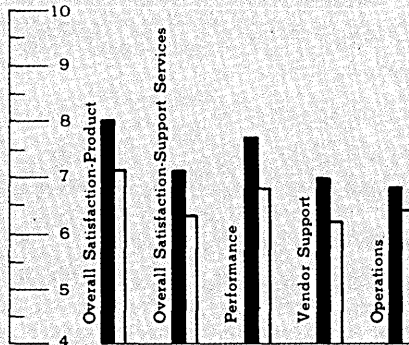

DMS-1100 • Sperry Corporation, P.O. Box 500, Blue Bell, PA 19422 • 215-542-4011

45 responses • 76% judged package and 56% judged vendor outstanding • 9% actively seeking to replace package, with 0% citing unsatisfactory performance as reason.

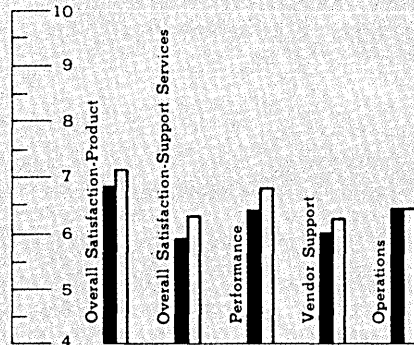

DATA BASE PLUS • Tominy, Inc., 4221 Malsbary Road, Building One, Cincinnati, OH 45242 • 513-984-6605

29 responses • 72% judged package and 59% judged vendor outstanding • 28% actively seeking to replace package, with 3% citing unsatisfactory performance as reason.

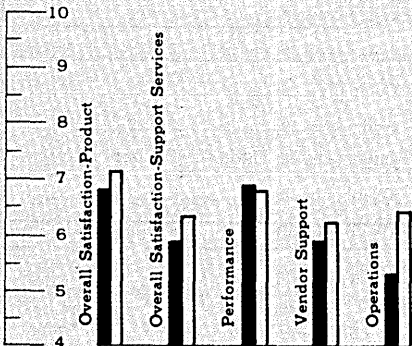

QUERY/REPORT WRITERS/DBMS AIDS

Group Average • 13 packages

675 responses • 73% judged package and 61% judged vendor outstanding • 13% actively seeking to replace package, with 2% citing unsatisfactory performance as reason.

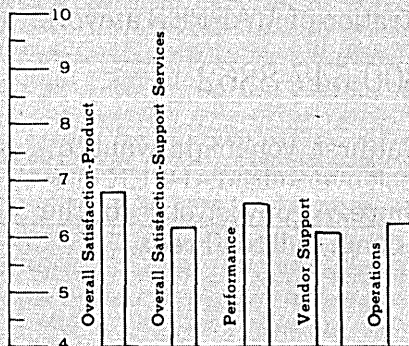

DATA DICTIONARY • Applied Data Research, Rt. 206 & Orchard Road, CN8, Princeton, NJ 08540 • 201-874-9100

49 responses • 67% judged package and 57% judged vendor outstanding • 8% actively seeking to replace package, with 2% citing unsatisfactory performance as reason.

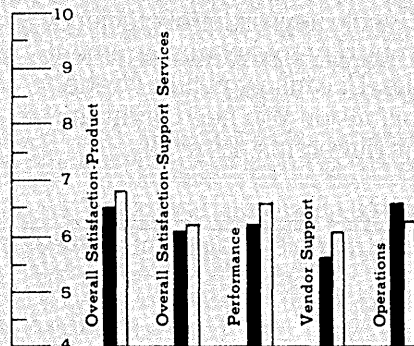

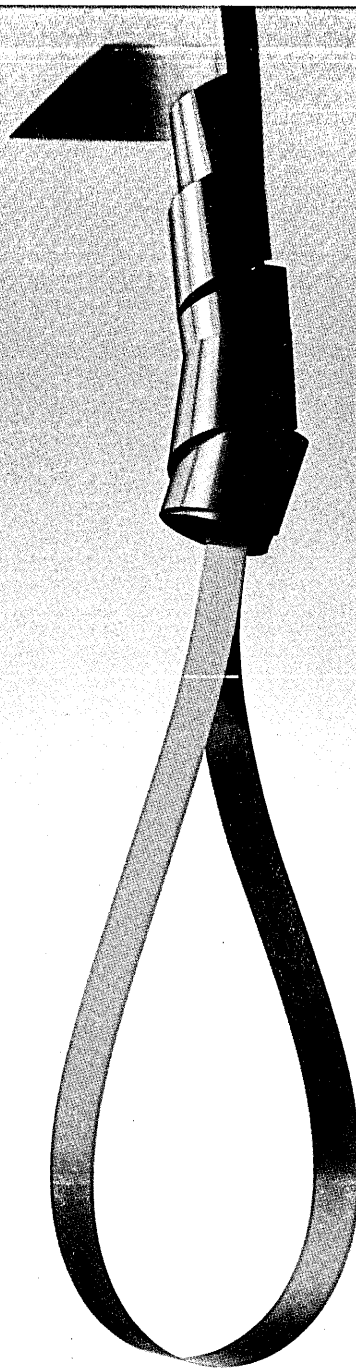

So what's a few inches of bad tape?

"Tape's tape," you say.

That's true unless the tape you write on now can't be read later. Then things could get really hung up.

Sure, tape's the last thing you want to think about; but it's often the first thing you hear about when things go wrong. So start off right.

With Memorex.[®]

Every inch of Memorex computer tape is tested to give you the greatest data security. And while some companies scrape away imperfections—calling it "certification"—we'd rather reject them. To keep you on the safe side.

Now Memorex has two newly formulated tape products that take our well-known quality a step further. Both are engineered for durability and

dependability in the critical 6250 bpi and 1600 bpi worlds. And each is backed by a 25-year warranty.

QUANTUM[®]II. Our new premium tape features higher output and that extra margin of safety for your critical data. It's write/skip free at 6250 bpi.

MRX[®]V. The new high-output, multi-purpose tape provides excellent value and dependability.

Don't take chances with your data. Trust it to Memorex Tape. We won't leave you hanging.

For more information, call 800-222-1150.

MEMOREX
A Burroughs Company

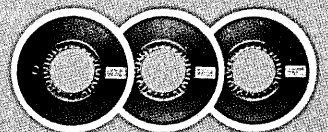

Ratings Values

10-9: Superior
8-6: Very Good

5-3: Acceptable
2-1: Inadequate

Legend

■ Specific Product Rating
□ Group Average Rating

CA-EARL • Computer Associates International, Inc., 125 Jericho Turnpike, Jericho, NY 11753 • 516-333-6733

53 responses • 79% judged package and 58% judged vendor outstanding • 19% actively seeking to replace package, with 6% citing unsatisfactory performance as reason.

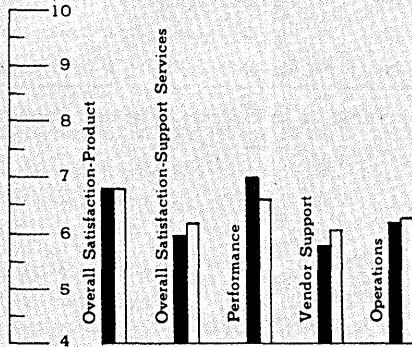

EDP AUDITOR/CULPRIT • Cullinet, 400 Blue Hill Drive, Westwood, MA, 02090 • 617-329-7700

54 responses • 79% judged package and 79% judged vendor outstanding • 4% actively seeking to replace package, with 2% citing unsatisfactory performance as reason.

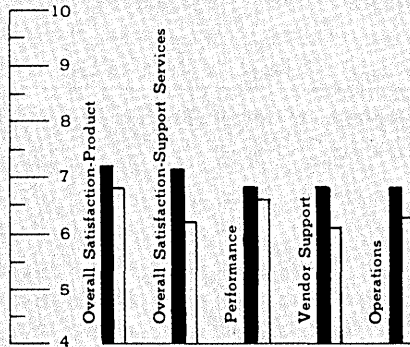

DYL-260 • Dylakor, 17418 Chatsworth Street, P.O. Box 3010, Granada Hills, CA 91344 • 213-366-1781

55 responses • 85% judged package and 80% judged vendor outstanding • 9% actively seeking to replace package, with 2% citing unsatisfactory performance as reason.

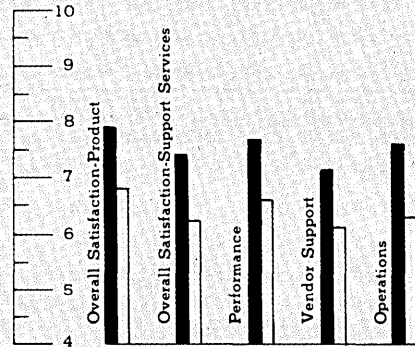

DYL-280 • Dylakor, 17418 Chatsworth Street, P.O. Box 3010, Granada Hills, CA 91344 • 213-366-1781

69 responses • 94% judged package and 90% judged vendor outstanding • 1% actively seeking to replace package, with 0% citing unsatisfactory performance as reason.

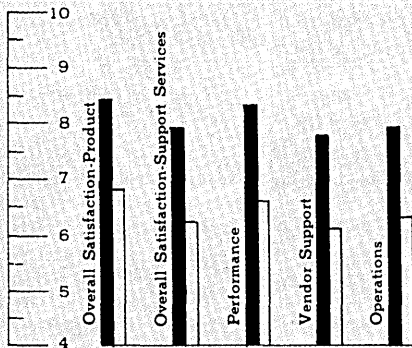

KEYFAST • H&M Systems Software, Inc., 351 Evelyn Street, Paramus, NJ 07652 • 201-599-9111

71 responses • 79% judged package and 51% judged vendor outstanding • 6% actively seeking to replace package, with 1% citing unsatisfactory performance as reason.

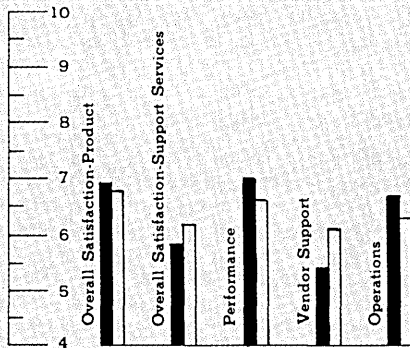

INQUIRY/IV • Informatics General Corp., 9441 LBJ Freeway, Dallas, TX 75243 • 214-231-1400

33 responses • 36% judged package and 24% judged vendor outstanding • 21% actively seeking to replace package, with 9% citing unsatisfactory performance as reason.

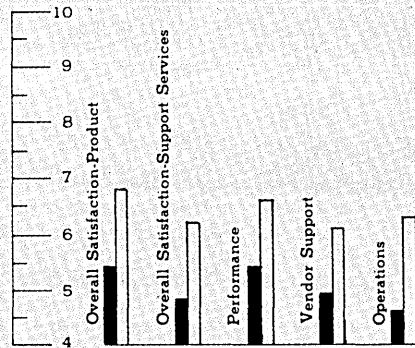

DATA MANAGER • MSP, Inc., 131 Hartwell Avenue, Lexington, MA 02173 • 617-861-6130

63 responses • 84% judged package and 72% judged vendor outstanding • 6% actively seeking to replace package, with 0% citing unsatisfactory performance as reason.

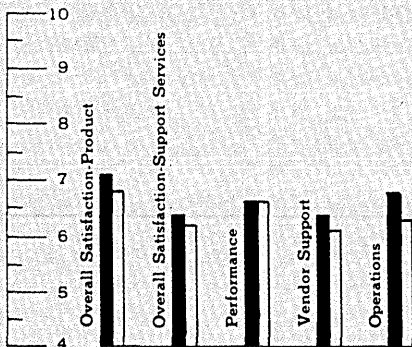

EASYTRIEVE • Pansophic Systems, Inc., 709 Enterprise Drive, Oak Brook, IL 60521 • 312-986-2263

60 responses • 78% judged package and 76% judged vendor outstanding • 10% actively seeking to replace package, with 0% citing unsatisfactory performance as reason.

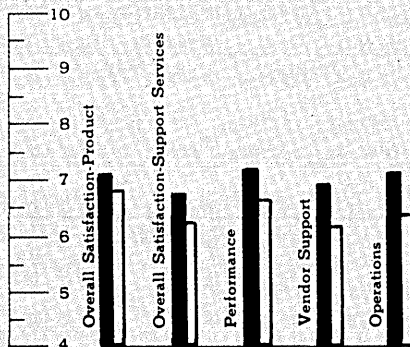

DATA ANALYZER • TSI International, 187 Danbury Road, Wilton, CT 06987 • 203-853-2884

53 responses • 57% judged package and 51% judged vendor outstanding • 26% actively seeking to replace package, with 6% citing unsatisfactory performance as reason.

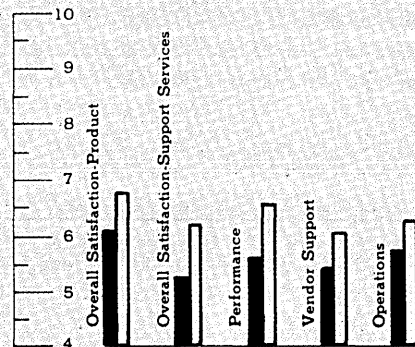

WHICH TWIN HAS THE TANDBERG?

The big screen terminal that's sooooo easy on the eyes

If your operators are getting eye-strain and headaches from staring at small, fuzzy screens all day long, chances are, you haven't yet heard of the Tandberg Data TDV 2200.

The TDV 2200 features a 15-inch screen with big, flicker-free, green-on-green characters; a patented Equalite™ Video system that displays both vertical and horizontal lines with equal intensity; and true character definition across the entire 15-inch screen. The TDV 2200 also tilts, swivels, raises and lowers for easy readability in any room light, at any angle.

But there's a lot more to the TDV 2200 than meets the eye. There are sixteen soft switches called PUSH keys that recall previously stored words, phrases, or code sequences. A single keystroke can recall up to 48

characters. This not only saves time, but also eliminates the possibility of error when entering this data. Up to 416 characters can be stored and recalled from the terminal or host computer.

There's also a simplified menu protocol that cuts set-up time in half; full editing capability; up to eight screens of memory; semi-graphic display; character, page, block or line/field transmission and a host of other features.

The Tandberg Data TDV 2200 family is available in a number of models that will emulate virtually any popular terminal including the DEC VT100 and VT52, Data-point 3600 and 8200, IBM 3101,

Data General 6053 and D200, H-P 2622, Basic Four and others. An advanced performance model is also available for the development of application-tailored OEM terminals.

To truly appreciate this outstanding combination of graceful ergonomic design, functional capabilities and performance features, you should really try one for yourself. Just call or write for a demonstration. You'll see that there's a lot more to the TDV 2200 than meets the eye. Tandberg Data, Inc., P.O. Box 99, Labriola Court, Armonk, N.Y. 10504. Phone: (914) 273-6400. Telex: 137357 Tandberg Arnk.

TANDBERG DATA
Tandberg Data, Inc.

CIRCLE 65 ON READER CARD





Speed. Convenience. Productivity. All good intentions. All up in smoke. All because too many personal computers proved too much of a good thing. And caused problems for your people. Incompatible programs, inaccessible information, inconsistent data, uncoordinated efforts. But we can put out all those fires with our Integrated Personal Business Computer. Because our IPBC contains all the hardware and software you need to combine the convenience of personal computing with the power of your corporate data base. With our IPBC, your people can access all the complete, consistent information in your corporate computer and use it in their personal computers. And vice versa. Without rekeying. Without errors. And without giving up their favorite programs. Because, as a 16-bit personal computer, our IPBC runs the new MS-DOS™ based programs for the IBM-

The road to hell is paved with good intentions.



PC™ Right off the shelf. And it runs all the popular CP/M® based programs too.

Then at the touch of a button, the IPBC becomes a terminal that lets your people run programs on most host computers, including IBM, DEC and HP.

Which means that with just one piece of hardware from one supplier, you can give everybody what they expected from personal computing. And what you expect from your

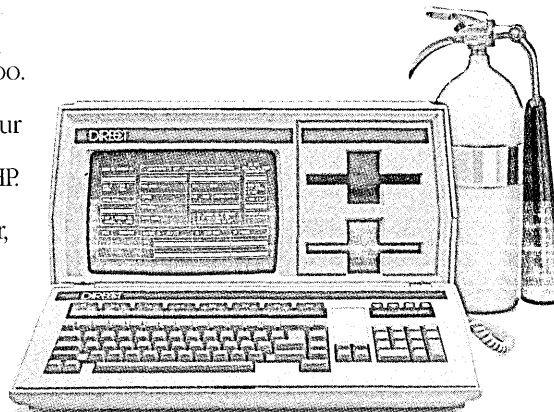

corporate MIS investment.

So call Direct at (408) 980-1414, extension 315. Or write us at 4201 Burton Drive, Santa Clara, California 95054. We'll show you how to travel the road to Integrated Personal Business Computing.

Without getting burned.

DIRECT

CIRCLE 66 ON READER CARD

Ratings Values

10-9: Superior
8-6: Very Good

5-3: Acceptable
2-1: Inadequate

Legend

■ Specific Product Rating
□ Group Average Rating

DATA CATALOGUE 2 • TSI International, 187 Danbury Road, Wilton, CT 06987 • 203-853-2884

40 responses • 47% judged package and 28% judged vendor outstanding • 20% actively seeking to replace package, with 10% citing unsatisfactory performance as reason.

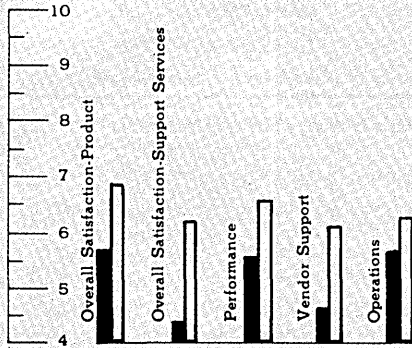

KEY/MASTER • TSI International, 187 Danbury Road, Wilton, CT 06987 • 203-853-2884

53 responses • 72% judged package and 66% judged vendor outstanding • 13% actively seeking to replace package, with 2% citing unsatisfactory performance as reason.

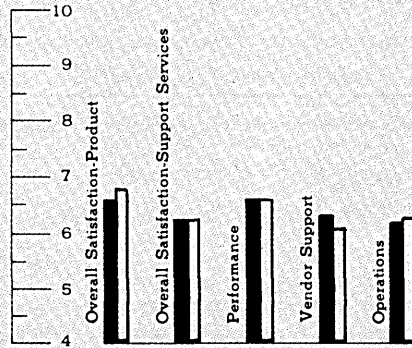

UCC TEN • University Computing Co., UCC Tower, Exchange Park, Dallas, TX 75235 • 214-353-7150

22 responses • 86% judged package and 64% judged vendor outstanding • 18% actively seeking to replace package, with 0% citing unsatisfactory performance as reason.

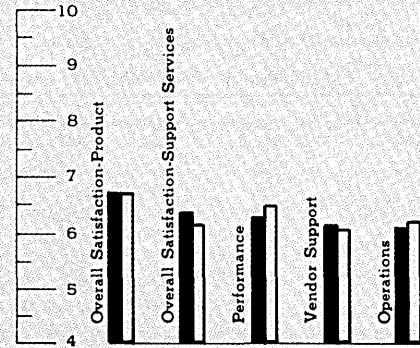

PROGRAM DEVELOPMENT AIDS / PROGRAMMING UTILITIES

Group Average • 13 packages

618 responses • 78% judged package and 66% judged vendor outstanding • 10% actively seeking to replace package, with 1% citing unsatisfactory performance as reason.

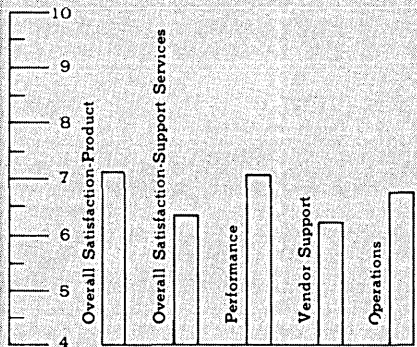

QUOTA II • Altergo Products, Inc., 400 W. Cummings Park, Suite 6900, Woburn, MA 01801 • 617-938-8811

24 responses • 97% judged package and 67% judged vendor outstanding • 17% actively seeking to replace package, with 4% citing unsatisfactory performance as reason.

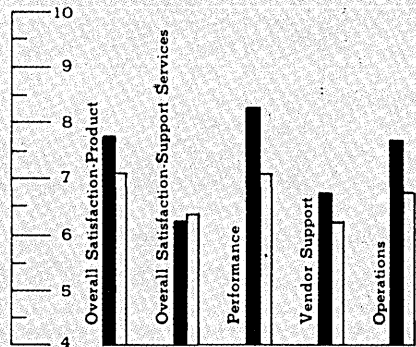

CPG • Altergo Products, Inc., 400 W. Cummings Park, Suite 6900, Woburn, MA 01801 • 617-938-8811

54 responses • 72% judged package and 52% judged vendor outstanding • 22% actively seeking to replace package, with 6% citing unsatisfactory performance as reason.

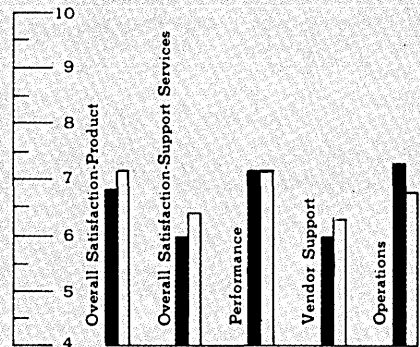

AUTOFLOW II • Applied Data Research, Rt. 206 & Orchard Road, CN 8, Princeton, NJ 08540 • 201-874-9100

22 responses • 36% judged package and 46% judged vendor outstanding • 5% actively seeking to replace package, with 0% citing unsatisfactory performance as reason.

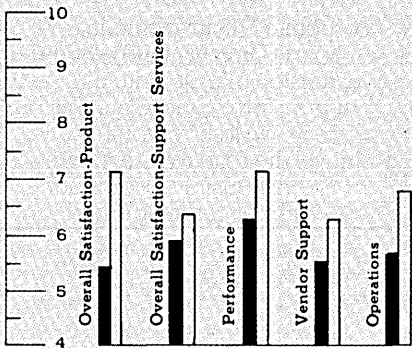

METACOBOL • Applied Data Research, Rt. 206 & Orchard Road, CN 8, Princeton, NJ 08540 • 201-874-9100

31 responses • 58% judged package and 68% judged vendor outstanding • 10% actively seeking to replace package, with 3% citing unsatisfactory performance as reason.

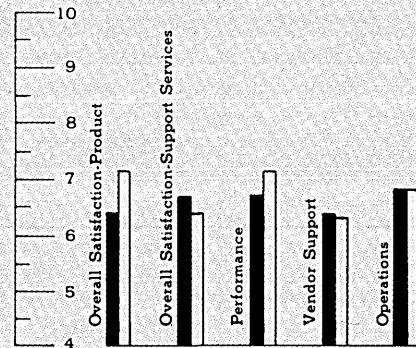

VOLLIE • Applied Data Research, Rt. 206 & Orchard Road, CN 8, Princeton, NJ 08540 • 201-874-1900

61 responses • 97% judged package and 89% judged vendor outstanding • 11% actively seeking to replace package, with 0% citing unsatisfactory performance as reason.

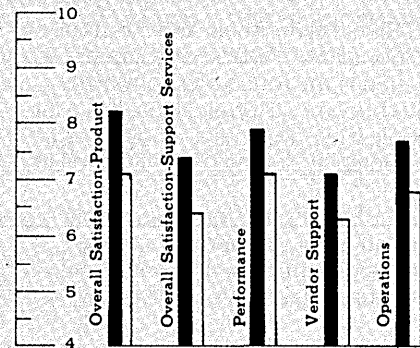



THE TRAPIX 5500 SOLVES ANOTHER TOUGH IMAGE PROCESSING PROBLEM

— With digital images now having a million or more picture elements (pixels), it is more important than ever for image processors to operate on images as efficiently as possible. That's why we place image memory in the address space of the Q-Bus or Unibus, so that when your LSI-11/23 or VAX issues an instruction, the CPU executes directly on the pixel. DMA devices, such as disks, may read and write image data directly on the bus. Thus, no time is wasted moving images into the CPU and then back again. In addition, the overhead of downloading commands to be interpreted by a microprocessor controller is eliminated.

High speed processing modules are also incorporated on two video rate buses associated directly with the image memories. With this architecture many image processing functions may be performed in real-time simultaneous with display and computer access.

The TRAPIX Real-Time Image Processor delivers in record time. But, speed is just one reason you should consider the TRAPIX; we offer a host of features that outdistance the competition.

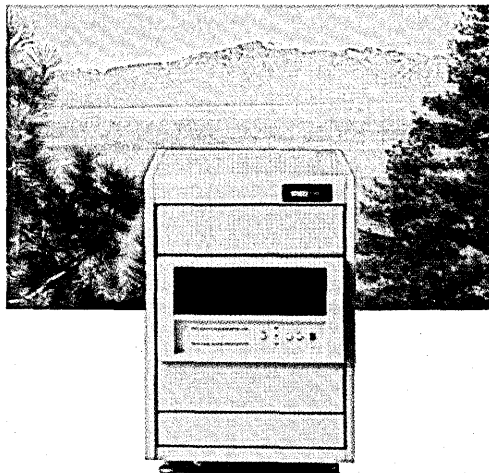

- Very low noise and stable 8, 10 or 12 bit video digitizers.
- Time base correction providing direct VCR operation.
- 1024 x 1024 images acquired and processed at 7.5 frames per second.
- Interface to area or line arrays up to 2048 x 2048 at rates from DC to 12.5 MHz.

- 32 bit Pixel Processor.
- Hardware Histogram Calculator.
- Up to 8MBytes of dual ported image memory.
- Optional stand alone systems.
- Communication connections to ETHERNET, DECNET AND NET 488 (IEEE 488).
- Real-Time Image Processing Software for VMS, RSX11 and RT11.

For information about today's cost-effective solution to your image processing needs, contact Recognition Concepts, Inc. Write to us on your company letterhead to receive a video taped demonstration.

VMS, RSX11, RT11, LSI-11/23, VAX, Q-Bus and Unibus are registered trademarks of Digital Equipment Corp. ETHERNET is a registered trademark of Xerox Corp.

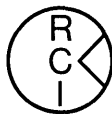

RECOGNITION CONCEPTS, INC.

924 INCLINE WAY, P. O. BOX 8510, INCLINE VILLAGE, NEVADA 89450 (702) 831-0473 TELEX: 170058

INNOVATORS IN IMAGE PROCESSING

CIRCLE 67 ON READER CARD

INTRODUCING IBM'S NEW PERSONAL COMPUTER.

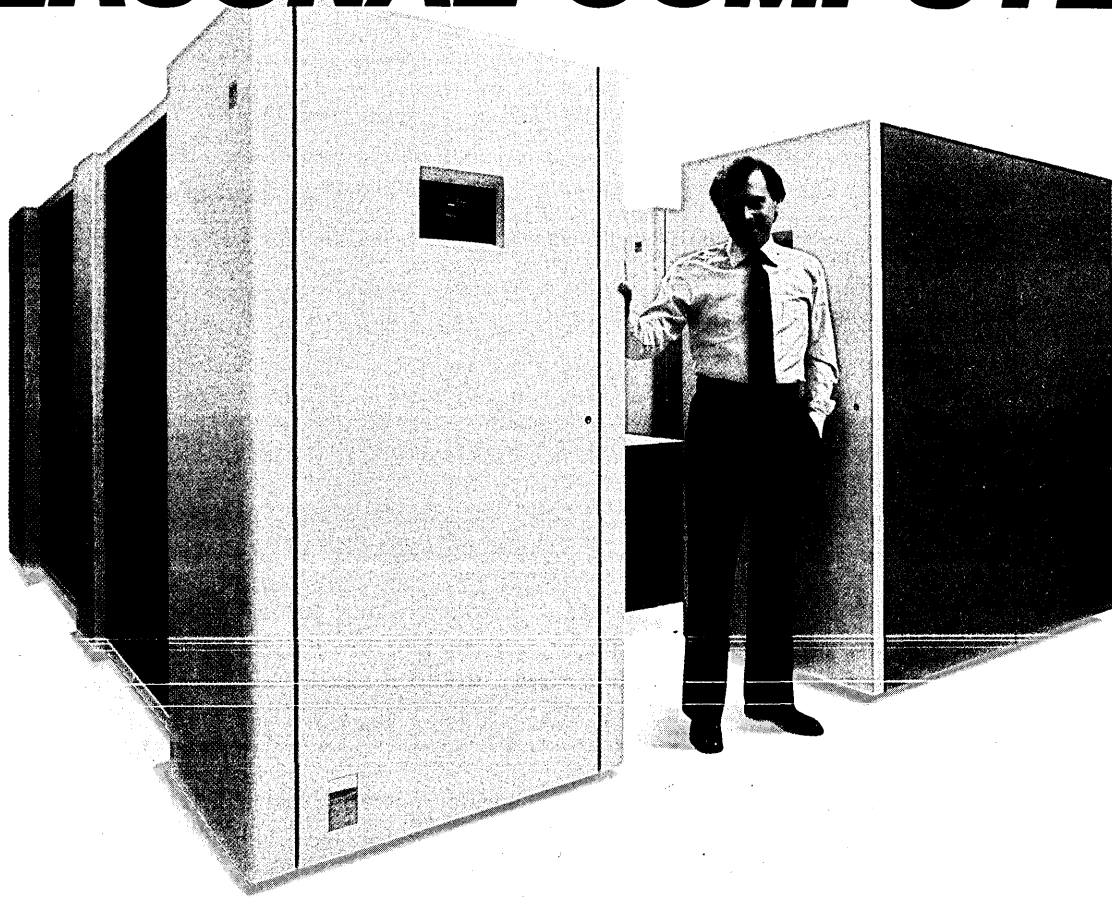

If your company has an IBM or IBM-compatible mainframe, you'll discover it's all the personal computer most of your end-users need.

Sure, right now they think they want a "real" personal computer. But their main priority is probably electronic spreadsheet capabilities for management planning. Other capabilities, like accounting or word processing, just aren't as frequently used or needed.

And you don't need problems with networking compatibility, mainframe communications, security and accuracy of vital corporate data, and the hidden costs of maintaining a large inventory of PCs.

OMNICALC™ TURNS EVERY TERMINAL IN YOUR COMPANY INTO A PERSONAL COMPUTER.

Now there's advanced spreadsheet software for your mainframe. One that's already been tried, tested, and loved by thousands of end-users. One that lets each of your end-users enjoy powerful forecasting and modeling capabilities without the expense and problems that come with personal computers.

OmniCalc lets managers easily analyze financial schedules, budgets, cash forecasts, planned expenses, sales forecasts, and a whole lot more.

And since OmniCalc is backed by the power of your mainframe, it's far more capable than the micro-based spreadsheets like VisiCalc.*

Of course, there are those in your organization who do need word processing and other capabilities. For them, we're working on an expansion of OmniCalc which will be available soon.

Discovering that you already own a large inventory of IBM personal computers can be highly profitable for your company. And so can all the other advanced software products powered by Tower. OmniCalc runs in CICS, VM/CMS or TSO environments. For complete details in California, Hawaii, and Alaska, call (714) 752-8263. In the rest of the continental United States, call toll-free (800) 854-7551. 19782 MacArthur Blvd., Suite 365, Dept. OCB, Irvine, CA 92715.

*VisiCalc is a registered trademark of VisiCorp.

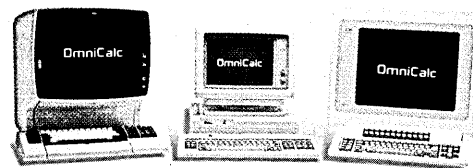

TOWER SYSTEMS INTERNATIONAL

Advanced Software Powered by Tower.

Ratings Values

10-9: Superior
8-6: Very Good

5-3: Acceptable
2-1: Inadequate

Legend

■ Specific Product Rating
□ Group Average Rating

MANTIS • Cincom Systems, Inc., 2300 Montana Avenue, Cincinnati, OH 45211 • 513-662-2300

29 responses • 76% judged package and 66% judged vendor outstanding • 17% actively seeking to replace package, with 0% citing unsatisfactory performance as reason.

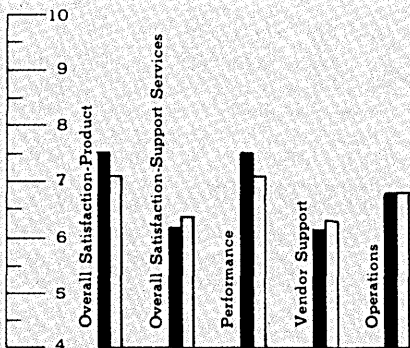

CA-OPTIMIZER • Computer Associates International, Inc., 125 Jericho Turnpike, Jericho, NY 11753 • 516-333-6733

38 responses • 92% judged package and 76% judged vendor outstanding • 8% actively seeking to replace package, with 0% citing unsatisfactory performance as reason.

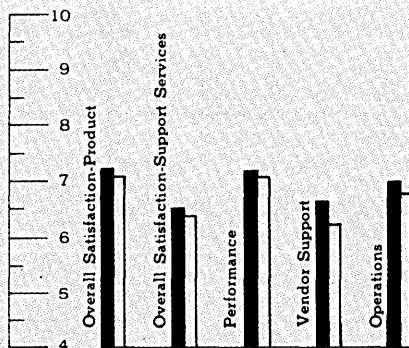

IMSL FORTRAN LIBRARIES • IMSL, Inc., Sixth Floor, NBC Building, 7500 Bellaire Boulevard, Houston, TX 77036 • 713-772-1927

44 responses • 89% judged package and 66% judged vendor outstanding • 2% actively seeking to replace package, with 0% citing unsatisfactory performance as reason.

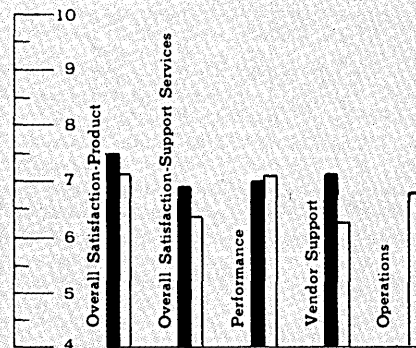

MARK IV • Informatics General Corp., 9441 LBJ Freeway, Dallas, TX 75243 • 214-231-1400

55 responses • 62% judged package and 56% judged vendor outstanding • 18% actively seeking to replace package, with 5% citing unsatisfactory performance as reason.

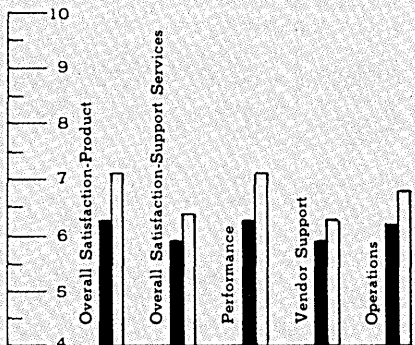

INTERTEST • On-Line Software International, Fort Lee Executive Park, Two Executive Drive, Fort Lee, NJ 07024 • 201-592-0009

65 responses • 94% judged package and 83% judged vendor outstanding • 2% actively seeking to replace package, with 0% citing unsatisfactory performance as reason.

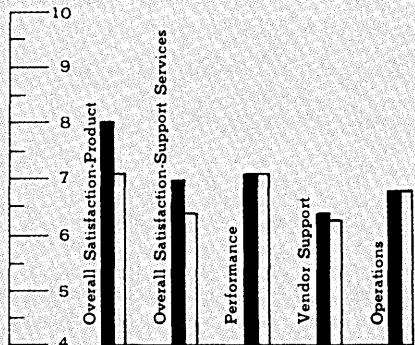

UFO • Oxford Software Corp., 174 Boulevard, Hasbrouck Heights, NJ 07604 • 201-288-1515

68 responses • 79% judged package and 57% judged vendor outstanding • 9% actively seeking to replace package, with 3% citing unsatisfactory performance as reason.

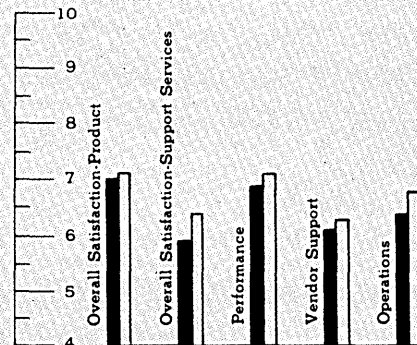

O-W-L • Pansophic Systems, Inc., 709 Enterprise Drive, Oak Brook, IL 60521 • 312-986-2263

70 responses • 86% judged package and 61% judged vendor outstanding • 13% actively seeking to replace package, with 4% citing unsatisfactory performance as reason.

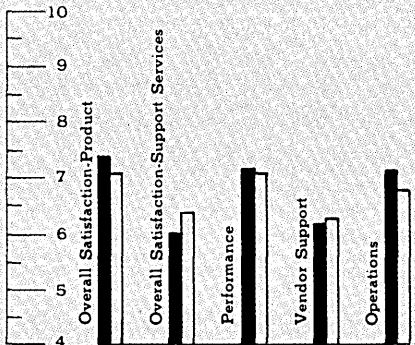

NATURAL • Software AG of North America, International Center, 11800 Sunrise Valley Drive, Suite 1517, Reston, VA 22091 • 703-860-5050

57 responses • 88% judged package and 65% judged vendor outstanding • 2% actively seeking to replace package, with 0% citing unsatisfactory performance as reason.

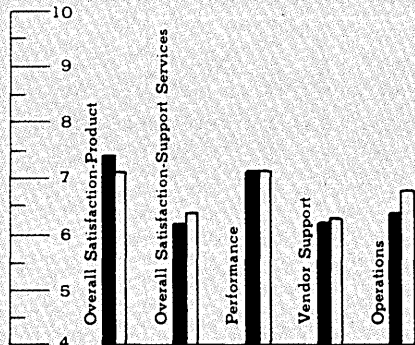

COMMUNICATIONS SOFTWARE

Group Average • 13 packages

543 responses • 73% judged package and 59% judged vendor outstanding • 30% actively seeking to replace package, with 3% citing unsatisfactory performance as reason.

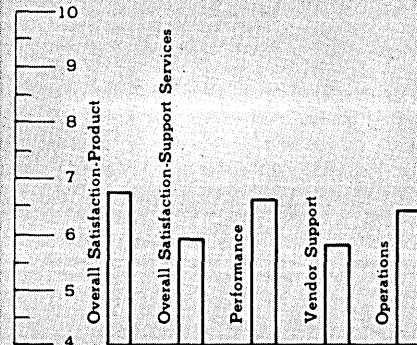

Announcing the State of the Smart.

IBM 3270 Personal Computer



If you're looking for a personal computer that will satisfy your company's professionals and managers, IBM now has exactly what you need.

The new IBM 3270 Personal Computer.

The fact is, many personal computers can be *too* personal for many business environments. Not the IBM 3270-PC. Its strength is the ease with which it communicates with IBM hosts and office systems—in the next room or around the globe.

The IBM 3270 Personal Computer is designed to accommodate the way people actually work. It can display in color up to seven windows of information at one time. Four with data from host computer applications (on the same or different hosts), two electronic notepads and one IBM Personal Computer session. And despite its impressive capabilities, the IBM 3270-PC is small enough to sit on a desk without taking it over.

The information windows can be moved, just as a person moves papers on a desk. They can be made bigger or smaller, put on top for immediate atten-

tion or temporarily hidden when not in use. Information on the screen can be processed, printed or exchanged between windows. And the IBM 3270-PC can be programmed by the data processing professional to meet the needs of each end user or department.

The IBM 3270 Personal Computer offers outstanding price/performance. And volume discounts are available. It could turn desks throughout your company into very Smart Desks.

To arrange to have an IBM marketing representative contact you, call toll free **1 800 IBM-2468**, Extension 82. Or send in the coupon.



IBM	12-83	
DRM, Dept. BR/82 400 Parson's Pond Drive Franklin Lakes, NJ 07417		
<input type="checkbox"/> Please have an IBM representative call me.		
<input type="checkbox"/> Please send me more information on the 3270 Personal Computer.		
Name	Title	
Company		
Address		
City	State	Zip
Phone		

The Smart Desk from IBM.

CIRCLE 69 ON READER CARD

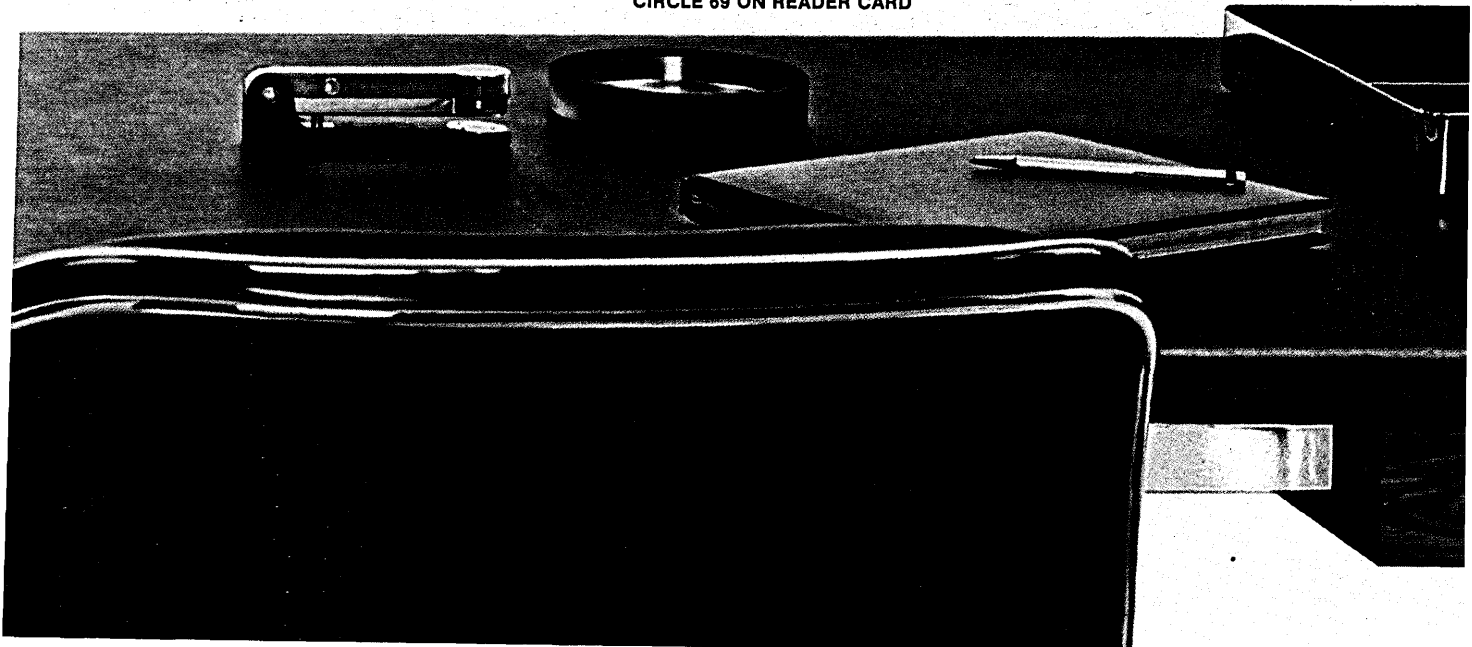

Ratings Values

10-9: Superior
8-6: Very Good

5-3: Acceptable
2-1: Inadequate

Legend

■ Specific Product Rating
□ Group Average Rating

SHADOW II • Altergo Products, Inc., 400 W. Cummings Park, Suite 6900, Woburn, MA 01801 • 617-938-8811

52 responses • 83% judged package and 69% judged vendor outstanding • 44% actively seeking to replace package, with 6% citing unsatisfactory performance as reason.

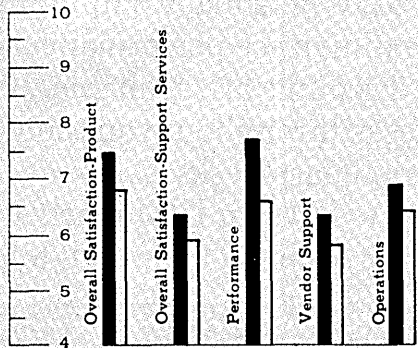

ADR/DATACOM/DC • Applied Data Research, Rt. 206 & Orchard Road, CN 8, Princeton, NJ 08540 • 201-874-9100

51 responses • 57% judged package and 37% judged vendor outstanding • 24% actively seeking to replace package, with 10% citing unsatisfactory performance as reason.

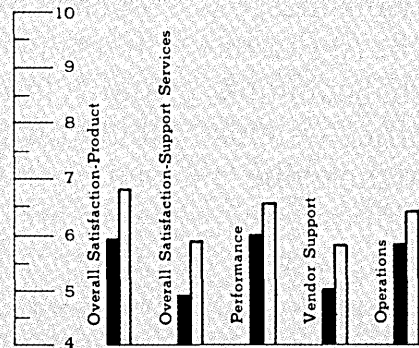

ADR/ROSCOE • Applied Data Research, Rt. 206 & Orchard Road, CN 8, Princeton, NJ 08540 • 201-874-9100

51 responses • 86% judged package and 71% judged vendor outstanding • 4% actively seeking to replace package, with 0% citing unsatisfactory performance as reason.

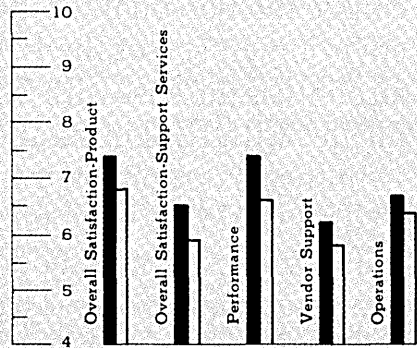

NDL • Burroughs Corporation, Burroughs Place, Detroit, MI 48232 • 313-972-9127

48 responses • 81% judged package and 69% judged vendor outstanding • 10% actively seeking to replace package, with 0% citing unsatisfactory performance as reason.

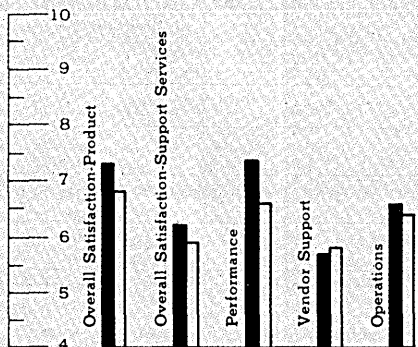

ENVIRON/1 • Cincom Systems, Inc., 2300 Montana Avenue, Cincinnati, OH 45211 • 513-662-2300

54 responses • 74% judged package and 54% judged vendor outstanding • 43% actively seeking to replace package, with 4% citing unsatisfactory performance as reason.

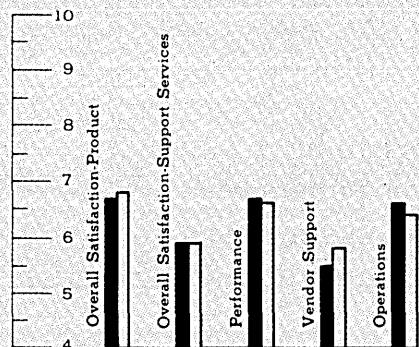

CICS/VS • IBM, National Accounts Division, 1133 Westchester Avenue, White Plains, NY 10604 • 914-696-1900

35 responses • 83% judged package and 68% judged vendor outstanding • 3% actively seeking to replace package, with 0% citing unsatisfactory performance as reason.

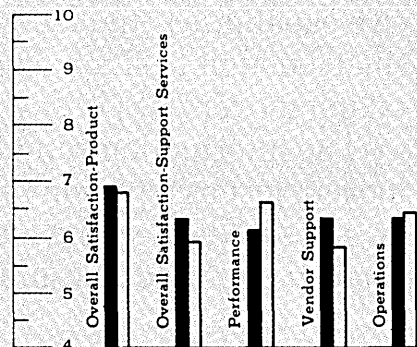

ICCF • IBM, National Accounts Division, 1133 Westchester Avenue, White Plains, NY 10604 • 914-696-1900

31 responses • 68% judged package and 52% judged vendor outstanding • 23% actively seeking to replace package, with 0% citing unsatisfactory performance as reason.

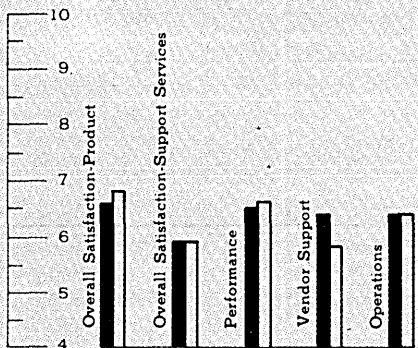

IMS/DC • IBM, National Accounts Division, 1133 Westchester Avenue, White Plains, NY 10604 • 914-696-1900

24 responses • 83% judged package and 79% judged vendor outstanding • 4% actively seeking to replace package, with 0% citing unsatisfactory performance as reason.

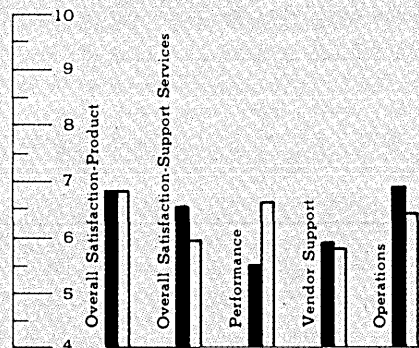

INTERCOMM • Polygon Systems, 71 Fifth Avenue, New York, NY 10003 • 212-741-5200

31 responses • 65% judged package and 45% judged vendor outstanding • 71% actively seeking to replace package, with 13% citing unsatisfactory performance as reason.

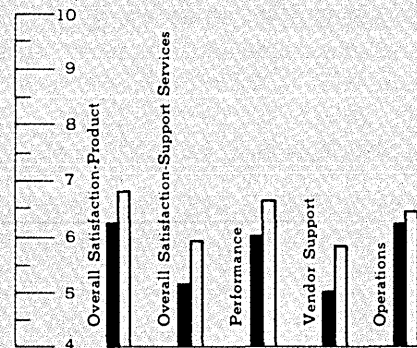

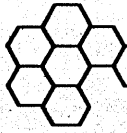

We Keep Companies Processing

We're saving Blue Cross/Blue Shield of North Carolina \$500,000 in processing costs... and reducing the load on their IBM mainframe.

How? With Topper work stations... intelligent, programmable terminals that work off-line as advanced personal computers supporting error checking, data entry programs. On-line, as versatile communication consoles accessing host programs from the keyboard or transferring data files to the host using Beehives WSL™ program, all without changes to your host interactive application programs.

Topper terminals help Blue Cross/Blue Shield process claims

CP/M® is a registered trademark of Digital Research, Inc.

significantly faster and more accurately saving \$500,000 per year in processing costs.

And with a CP/M® operating system and built-in floppy disk drives, Topper can handle a multitude of programs from data entry, to management and MIS data base programs.

Minimize IBM Mainframe Stress

Off-line processing has reduced Blue Cross/Blue Shield's dependence on their IBM mainframe. That's boosting productivity and extending the useful life of the central computer.

Take The Cure

If you want to insure your processing functions from suffering with IBM mainframe dependence follow Blue Cross/Blue Shield policy.

For more details contact: Beehive, 4910 Amelia Earhart Drive, Salt Lake City, Utah 84125, Toll Free Number: 1-800-453-9454.



BEEHIVE™

CIRCLE 70 ON READER CARD

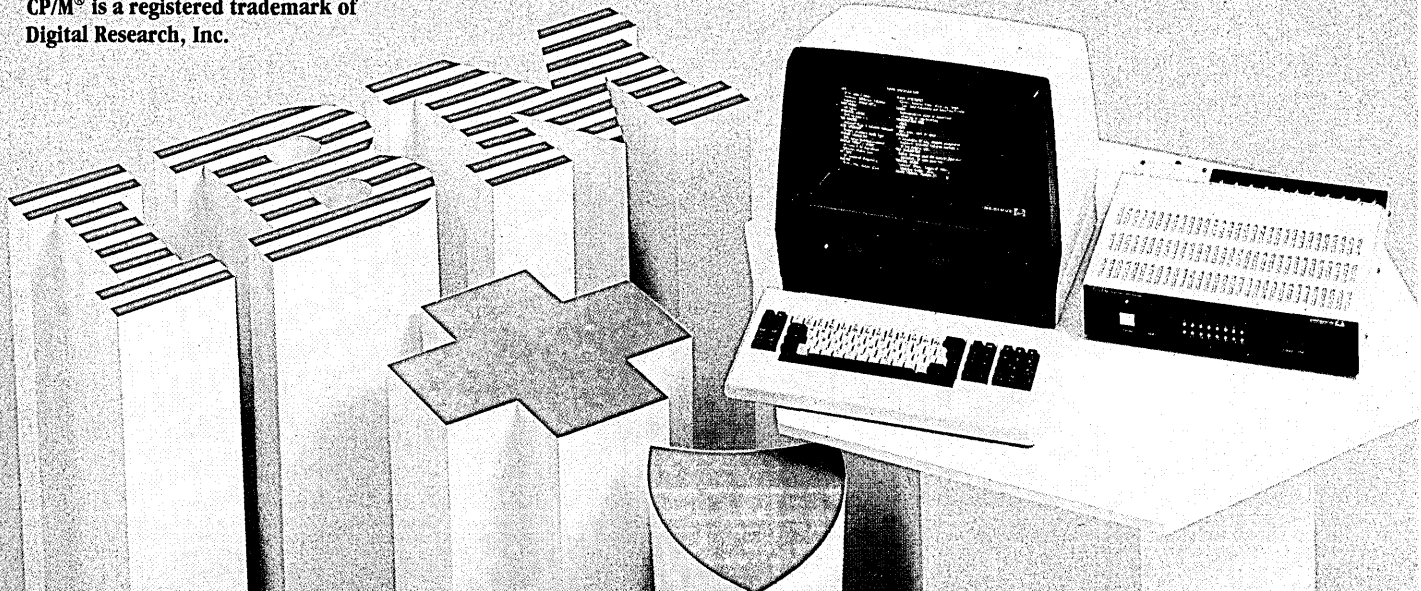

Sales Offices:

CALIFORNIA Costa Mesa 714/544-4404, Sunnyvale 408/738-1560 • FLORIDA Hollywood 305/920-2711 • ILLINOIS Arlington Heights 312/593-1565
MASSACHUSETTS Woburn 617/926-0202 • MISSOURI Independence 816/356-4422 • NEW JERSEY Colon 201/9883 • NORTH CAROLINA Greensboro 919/854-2694
TEXAS Dallas 214/239-3330 • UTAH Salt Lake City 801/355-6000 • WASHINGTON DC (VA) Falls Church 703/261-1261

Ratings Values

10-9: Superior
8-6: Very Good

5-3: Acceptable
2-1: Inadequate

Legend

█ Specific Product Rating
□ Group Average Rating

COM-LETE • Software AG of North America, International Center, 11800 Sunrise Valley Drive, Suite 1517, Reston, VA 22091 • 703-860-5050

48 responses • 71% judged package and 54% judged vendor outstanding • 15% actively seeking to replace package, with 4% citing unsatisfactory performance as reason.

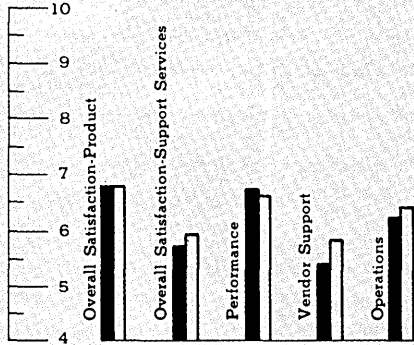

TONE 3 • Tone Software Corporation, 1735 S. Brookhurst, Anaheim, CA 92804 • 714-991-9460

19 responses • 84% judged package and 74% judged vendor outstanding • 37% actively seeking to replace package, with 0% citing unsatisfactory performance as reason.

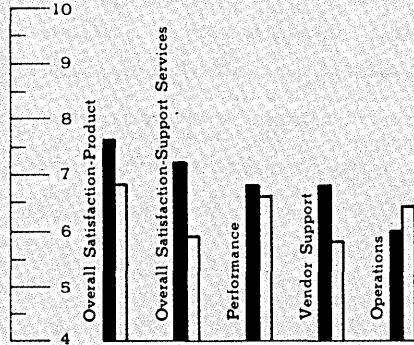

TASK/MASTER • TSI International, 187 Danbury Road, Wilton, CT 06987 • 203-853-2884

23 responses • 30% judged package and 13% judged vendor outstanding • 83% actively seeking to replace package, with 35% citing unsatisfactory performance as reason.

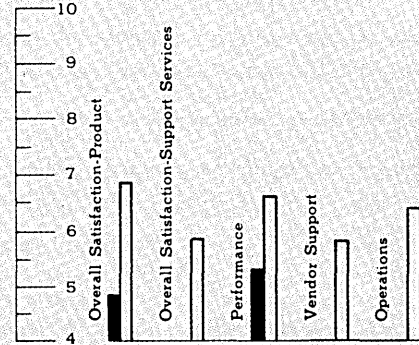

WESTI • Westinghouse Electric Corp., 2040 Ardmore Boulevard, Pittsburgh, PA 15221 • 412-636-3100

76 responses • 88% judged package and 83% judged vendor outstanding • 26% actively seeking to replace package, with 0% citing unsatisfactory performance as reason.

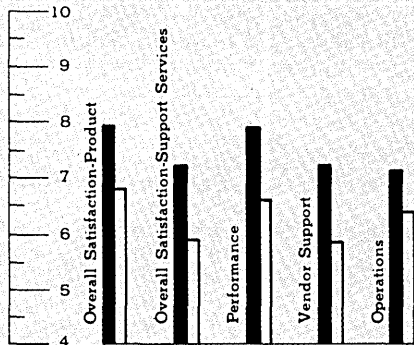

UTILITIES/OPERATING SYSTEMS/ENHANCEMENTS

Group Average • 34 packages

1,813 responses • 86% judged package and 71% judged vendor outstanding • 10% actively seeking to replace package, with 1% citing unsatisfactory performance as reason.

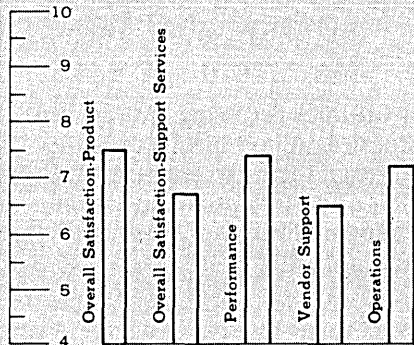

THE LIBRARIAN • Applied Data Research, Rt. 206 & Orchard Road, CN 8, Princeton, NJ 08540 • 201-874-9100

49 responses • 94% judged package and 78% judged vendor outstanding • 0% actively seeking to replace package

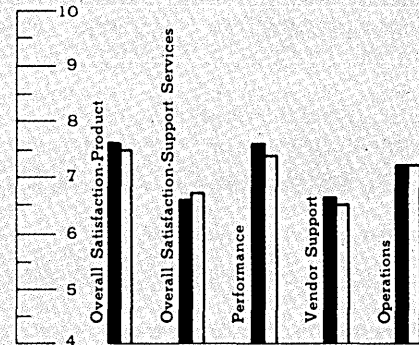

ACF2 • The Cambridge Systems Group, 24275 Elise Court, Los Altos Hills, CA 94022 • 415-941-4558

72 responses • 96% judged package and 81% judged vendor outstanding • 4% actively seeking to replace package, with 0% citing unsatisfactory performance as reason.

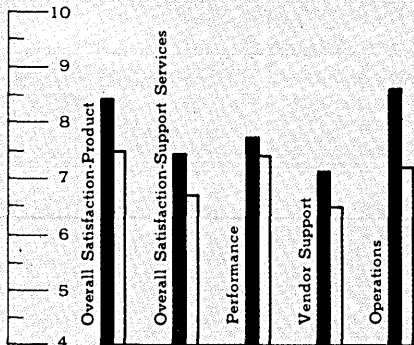

ASM2 • The Cambridge Systems Group, 24275 Elise Court, Los Altos Hills, CA 94022 • 415-941-4558

64 responses • 89% judged package and 70% judged vendor outstanding • 11% actively seeking to replace package, with 0% citing unsatisfactory performance as reason.

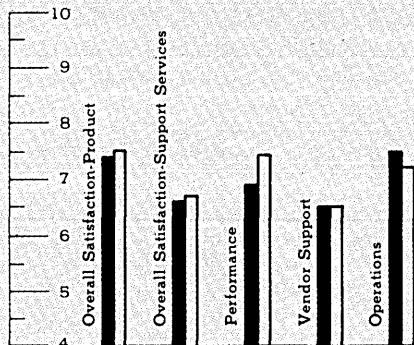

SUPER-MSI • CGA Software Products Group, 1370 Piccard Drive, Rockville, MD 20850 • 301-948-9600

48 responses • 92% judged package and 73% judged vendor outstanding • 8% actively seeking to replace package, with 2% citing unsatisfactory performance as reason.

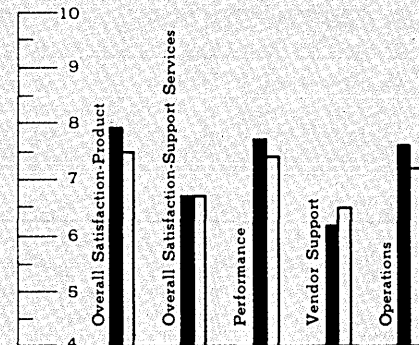

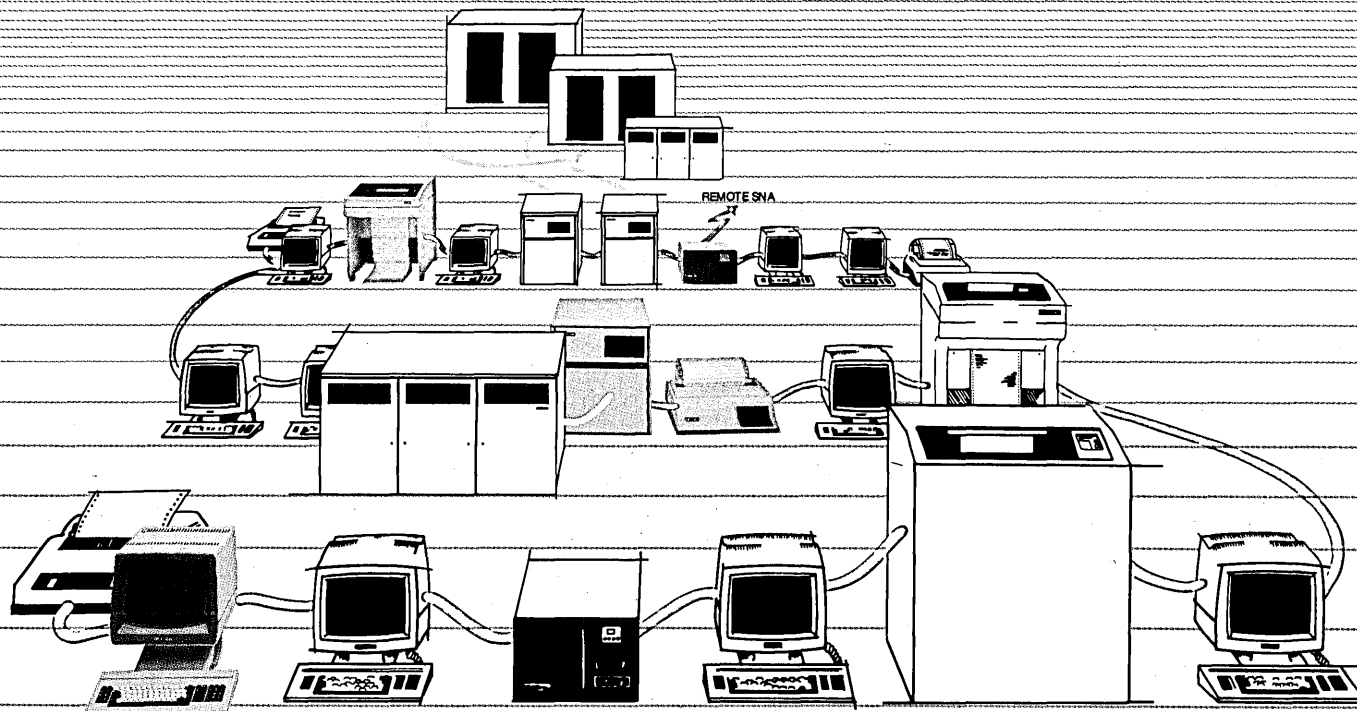

3270 Networking: No More No Man's LAN.

Imagine. 3270 Processing. IBM-Compatible Personal Computing. Local Area Networking. And SNA Compatibility. In One System.

Imagine a system that successfully settles the uncharted territory of 3270 local networking—that "no man's LAN" of unlinked and unrealized potential.

Imagine a system that delivers the power of 3270 processing, and the flexibility to build two local area networks from a single controller. Imagine being able to attach up to 120 devices to that controller. Or attaching four distinct controllers—and multiple coaxial links of up to 10,000 feet each—to any of those LANs.

Imagine the economies of a system that handles that networking with standard 3270 coax. That requires no commitment to special architectures or non-standard LAN technologies. And that, thanks to a multi-drop, station-to-station design, can eliminate thousands of feet of new coax.

Of course, such a system would have SNA compatibility. But it would also have a set of capabilities to dramatically increase throughput, while reducing hardware and support costs in *any* environment. Capabilities like multi-host and multi-personality support, application and address switching, and system printing.

This system would have multi-user personal computing "built into" the network—allowing you to

assign true 16-bit computing power, maintain overall MIS control, and share expensive disks and printers.

Such a system would boast an intelligent display station that displays a mastery of ergonomic and aesthetic design. With multi-screen formats, anti-glare screen, low-profile keyboard, and a tilt-and-swivel pedestal with the smallest footprint in the industry. Such a system would also include a full line of printers.

Imagine. 3270 processing. IBM-compatible personal computing. Versatile, economical, powerful local area networking. In one system.

Braegen *has* imagined just such a system. They have designed it. Built it. And called it the ELAN™ System.

If such a system sparks your imagination, give us a call. We know the feeling. The Braegen Corporation, 525 Los Coches Street, Milpitas, CA 95035, (408) 945-8150; TWX: 910-338-7332.

*Braegen
has
designed
it.*

BRÆGEN

*ELAN is a trademark of The Braegen Corporation.

The Texas Instruments
Quite simply, the best
on the market today

"This is the machine IBM
should have designed.

It is the optimum
personal computer."

Popular Computing
October 83

TEXAS INSTRUMENTS

H-Centering

Bright

Power

On

Off

On

Off

On

Off

On

Off

On

Off

On

Off

On

Off

On

Off

On

Off

On

Off

On

Off

On

Off

On

Off

On

Off

On

Off

On

Off

On

Off

On

Off

On

Professional Computer. personal computer And tomorrow.

For your best performance and productivity,
rely on the TI Professional Computer.

Critics have called it "the machine IBM should have designed." And "the optimum personal computer." And thousands of demanding business and professional people have had similar praise for the design, software availability and dependability of the Texas Instruments Professional Computer. Here's why.

Best internal design.

With the TI Professional Computer, you avoid the possibility of computer underbuy or overbuy. Unlike IBM, our standard PC can grow to XT capability — so you don't have to choose between a PC or an XT. If you need more computer after you buy the standard TI Professional Computer, add features like internal memory up to 768K RAM. And internal 10 megabyte Winchester disk. Or other expansion capabilities which you can add using our 5 built-in option slots. So you get more computer without buying a new one.

Best graphics.

Our high resolution monitors give you some of the sharpest displays available, 3-plane graphics and the capability for 8 simultaneous colors or monochrome shades (IBM and Apple give you only 4). Plus, unlike IBM, the same software runs on either the color or monochrome monitor.

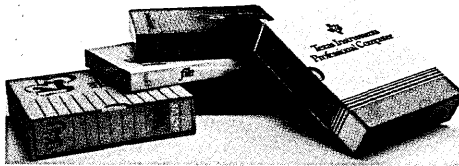

Best software available today.

Literally hundreds of third-party software packages are available for the TI Professional Computer. Including the best-sellers like Lotus 1-2-3™. TI and leading third-party software suppliers are committed to developing new programs to help keep your business ahead.

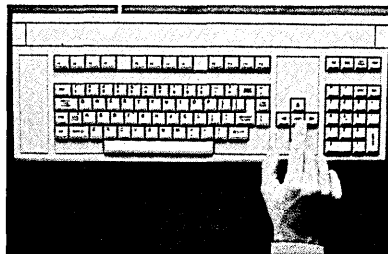

Best keyboard.

Superior design makes this the easiest to use keyboard. You get 12 programmable function keys for faster, easier use. Separate numeric keypad and cursor controls. And isolated edit/delete keys to prevent accidental loss of data.



Best new features for the future.

Come in to a participating dealer today for a demonstration of the TI Professional Computer using our revolutionary speech recognition† capability. Soon you will be able to add the recently announced Speech Command™ option to the TI Professional Computer. This will enable you to operate the computer with simple voice commands. Which lets you work a lot faster and easier.

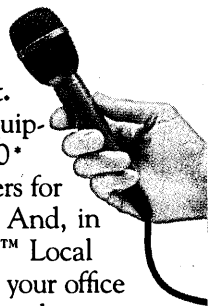

Best support equipment.

We offer companion equipment like the OMNI 800* Model 850 and 855 printers for reliable hard copy output. And, in early 1984, the EtherLink™ Local Area Network to connect your office workstations. All backed by the TI worldwide network of service and support.

See the TI Professional Computer for yourself. It is, quite simply, the best. Today and tomorrow. Now at participating ComputerLand stores and independent dealers. For the location nearest you, and answers to questions about your computing needs, call 1-800-527-3500.



**TEXAS
INSTRUMENTS**
Creating useful products
and services for you.

* OMNI 800 and Speech Command are trademarks of Texas Instruments Incorporated.
EtherLink is a trademark of 3Com Corporation.
1-2-3 is a trademark of Lotus Corporation.

† Now being demonstrated nationwide. Available early 1984.
Copyright © 1983 Texas Instruments 2773-04OPC

Ratings Values
 10-9: Superior
 8-6: Very Good

5-3: Acceptable
 2-1: Inadequate

Legend
 ■ Specific Product Rating
 □ Group Average Rating

CA-DYNAM/D • Computer Associates International, Inc., 125 Jericho Turnpike, Jericho, NY 11753 • 516-333-6733

56 responses • 91% judged package and 73% judged vendor outstanding • 7% actively seeking to replace package, with 2% citing unsatisfactory performance as reason.

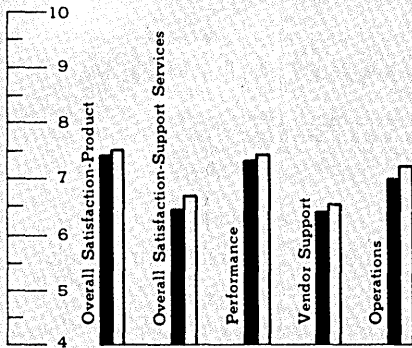

CA-DYNAM/T • Computer Associates International, Inc., 125 Jericho Turnpike, Jericho, NY 11753 • 516-333-6733

65 responses • 85% judged package and 71% judged vendor outstanding • 8% actively seeking to replace package, with 0% citing unsatisfactory performance as reason.

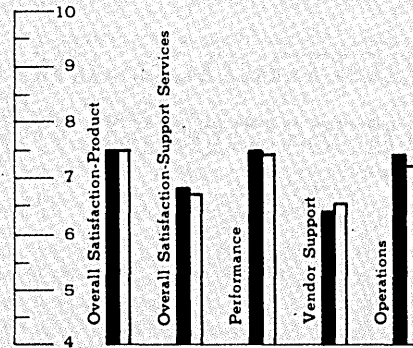

CA-JASPER • Computer Associates International, Inc., 125 Jericho Turnpike, Jericho, NY 11753 • 516-333-6733

48 responses • 58% judged package and 56% judged vendor outstanding • 4% actively seeking to replace package, with 0% citing unsatisfactory performance as reason.

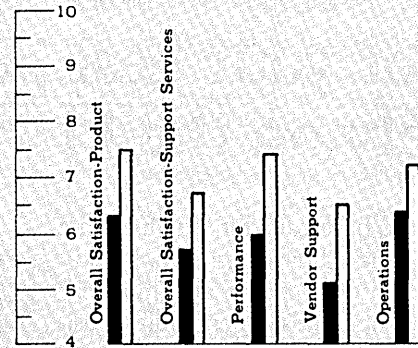

CA-RAPS • Computer Associates International, Inc., 125 Jericho Turnpike, Jericho, NY 11753 • 516-333-6733

58 responses • 93% judged package and 69% judged vendor outstanding • 10% actively seeking to replace package, with 0% citing unsatisfactory performance as reason.

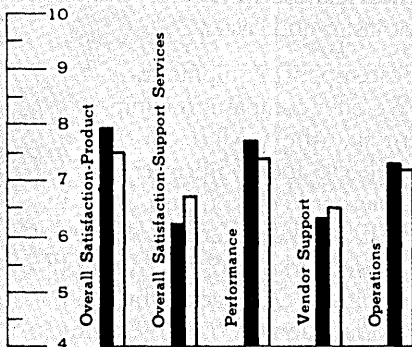

CA-SCHEDULER • Computer Associates International, Inc., 125 Jericho Turnpike, Jericho, NY 11753 • 516-333-6733

29 responses • 52% judged package and 35% judged vendor outstanding • 10% actively seeking to replace package, with 7% citing unsatisfactory performance as reason.

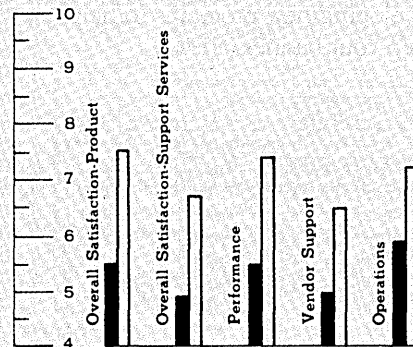

CA-SORT • Computer Associates International, Inc., 125 Jericho Turnpike, Jericho, NY 11753 • 516-333-6733

65 responses • 94% judged package and 85% judged vendor outstanding • 6% actively seeking to replace package, with 0% citing unsatisfactory performance as reason.

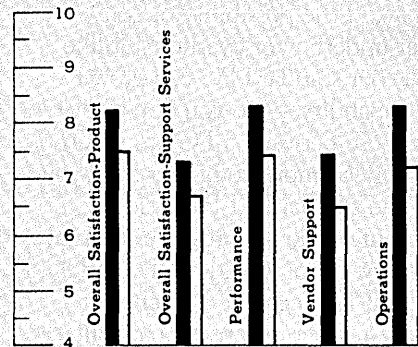

CA-TLMS • Computer Associates International, Inc., 125 Jericho Turnpike, Jericho, NY 11753 • 516-333-6733

44 responses • 75% judged package and 54% judged vendor outstanding • 14% actively seeking to replace package, with 2% citing unsatisfactory performance as reason.

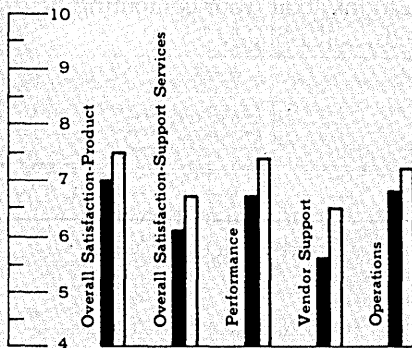

ABEND-AID • Compuware, 32100 Telegraph Road, Birmingham, MI 48010 • 313-540-0900

55 responses • 93% judged package and 76% judged vendor outstanding • 0% actively seeking to replace package.

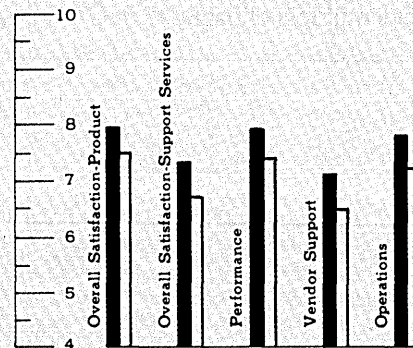

SYSTEM/MANAGER • Corodale, Inc., 211 Congress Street, Boston, MA 02110 • 617-426-8780

69 responses • 100% judged package and 96% judged vendor outstanding • 10% actively seeking to replace package, with 0% citing unsatisfactory performance as reason.

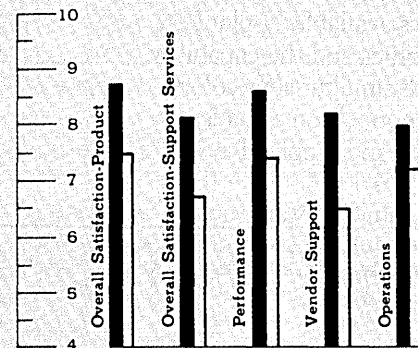

Fill in your IBM micro/mainframe communications picture.

AST Research, the leader in IBM PC enhancement products, brightens your micro/mainframe communications picture with a full palette of economical, integrated hardware/software masterpieces. With AST Products, you can emulate IBM terminals or create PC-based Local Area Networks.

AST improves your office operating cost picture.

AST communications products give your IBM PC the flexibility to act as a terminal for your host system or as a stand-alone computer for smaller tasks. Your PC won't bog down the mainframe with unnecessary small jobs and local computing on the PC eliminates phone line charges too. Get the power of a mainframe when you need it and personal computer convenience right at your fingertips.

Applications solutions that are strokes of genius.

AST keeps pace with your ever-changing applications requirements with reliable, high quality, cost effective communications products. AST products provide support for Bisync and SNA/SDLC communications protocols as well as networking multiple PC's for sharing resources.

Choose AST products — by the numbers.

These AST communications packages are currently available:

1. **AST-SNA™** emulates a 3274/3276 controller and 3278 or 3279 display terminal using SDLC protocol.
2. **AST-BSC™** emulates 2770 batch RJE and remote 3270 display terminals using 3270 Bisync protocol.
3. **AST-PCOX™** allows your PC to connect to an IBM 3274/3276 cluster controller via coax cable and emulates a 3278 or 3279 display terminal.
4. **AST-3780™** emulates 2770, 2780, 3741, and 3780 RJE workstations using Bisync protocol.
5. **AST-5251™** emulates a 5251 Model 12 remote workstation connected to an IBM System 34, 36 or 38.
6. **PCnet™** is the first Local Area Network designed specifically for the IBM PC or XT and the PC-DOS 1.1 or 2.0 operating system.
7. **CC-232™** is a user-programmable dual-port card capable of communicating in Async, Bisync, SDLC, or HDLC protocols.

CIRCLE 72 ON READER CARD

Discover how well AST can fill in your micro/mainframe communications picture. For descriptive data sheets, write or call: AST Research Inc., 2121 Alton Ave., Irvine, CA 92714. (714) 863-1333. TWX: 295370ASTRUR

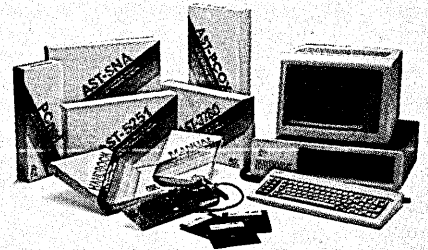

AST
RESEARCH INC.

**Number One Add-Ons
For IBM PC.**

IBM is a registered trademark of International Business Machines Corporation. PCnet is a registered trademark of Orchid Technology, Inc. AST-3780 is a product developed by AST Research, Inc., and Wilmot Systems, Inc. AST-5251 is a product developed by AST Research, Inc., and Software Systems, Inc., of Jefferson City, MO. PCOX is a product developed by CXI Inc.

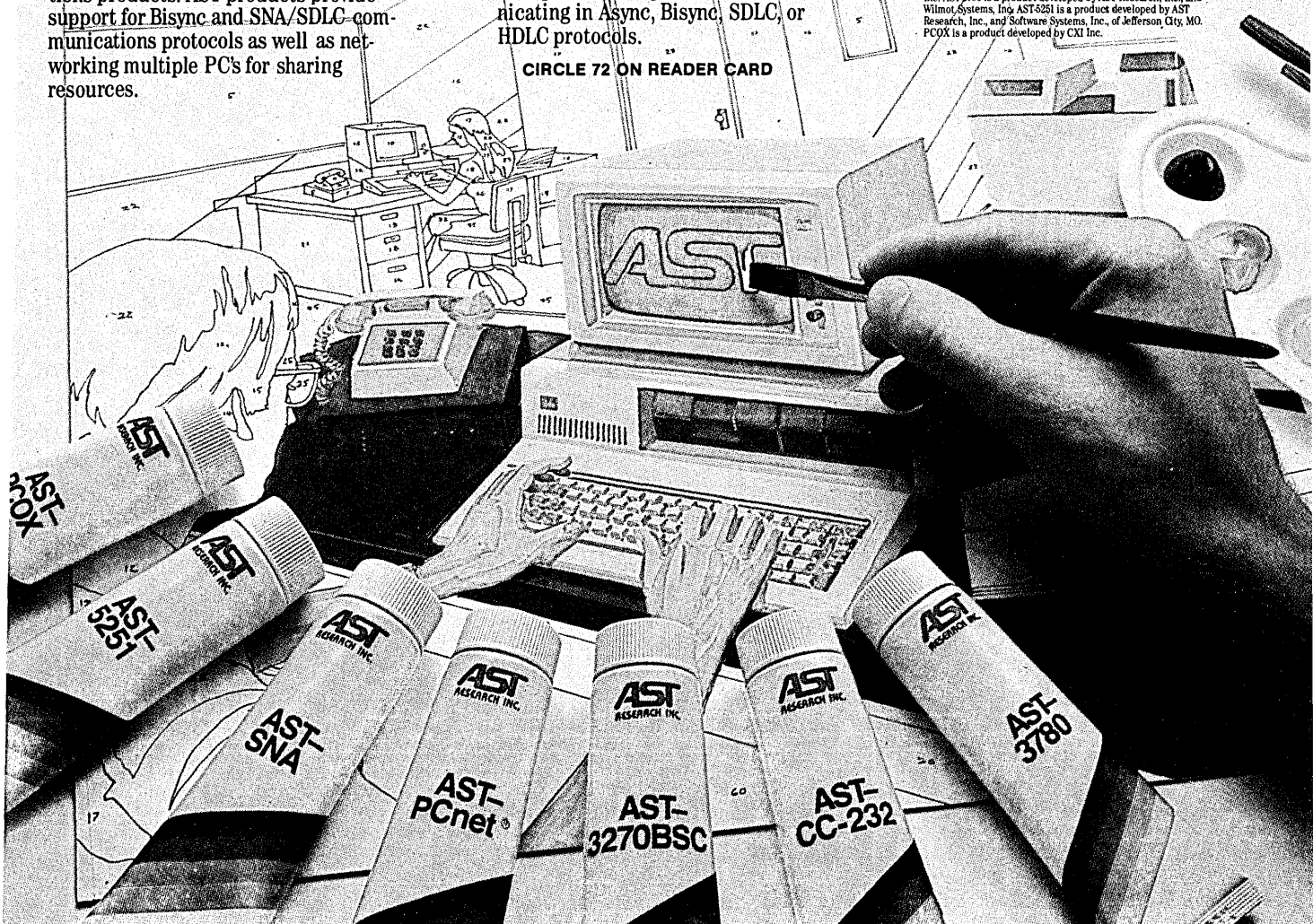

Ratings Values

10-9: Superior
8-6: Very Good

5-3: Acceptable
2-1: Inadequate

Legend

■ Specific Product Rating
□ Group Average Rating

SHRINK • Informatics General Corp., 9441 LBJ Freeway, Dallas, TX 75243 • 214-231-1400

42 responses • 93% judged package and 69% judged vendor outstanding • 5% actively seeking to replace package, with 2% citing unsatisfactory performance as reason.

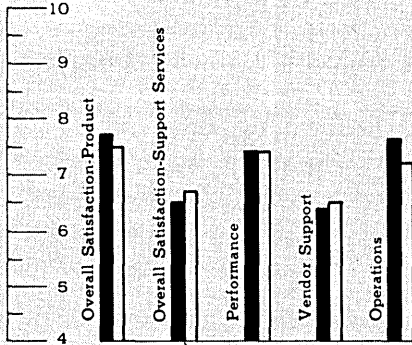

FAST/DUMP/RESTORE (FDR) • Innovation Data Processing, Inc., 970 Clifton Avenue, Clifton, NJ 07013 • 201-777-1940

74 responses • 99% judged package and 96% judged vendor outstanding • 1% actively seeking to replace package, with 0% citing unsatisfactory performance as reason.

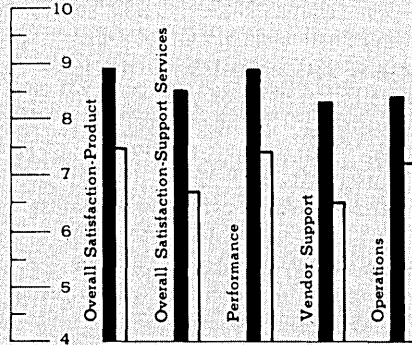

OS/DOS JOB ACCOUNTING SYSTEMS (JARS) • Johnson Systems, Inc., 8300 Greensboro Drive, Suite 700, McLean, VA 22102 • 703-821-1700

65 responses • 86% judged package and 69% judged vendor outstanding • 6% actively seeking to replace package, with 2% citing unsatisfactory performance as reason.

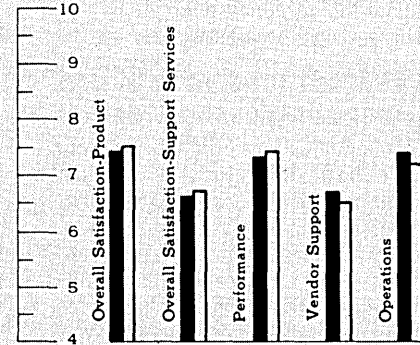

UMAX • Johnson Systems, Inc., 8300 Greensboro Drive, Suite 700, McLean, VA 22102 • 703-821-1700

47 responses • 81% judged package and 68% judged vendor outstanding • 6% actively seeking to replace package, with 2% citing unsatisfactory performance as reason.

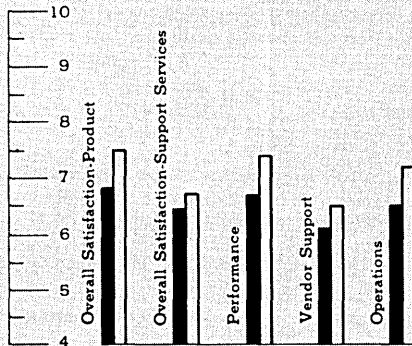

LOGOUT/MULTILOG • Macro 4, Inc., 1 West Hanover Avenue, Mt. Freedom, NJ 07970 • 201-895-4800

75 responses • 99% judged package and 91% judged vendor outstanding • 7% actively seeking to replace package, with 0% citing unsatisfactory performance as reason.

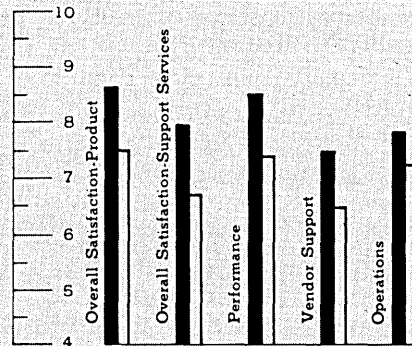

MICOS • Mini-Computer Systems, 399 Fairview Park Drive, Elmsford, NY 10523 • 914-592-8812

28 responses • 82% judged package and 61% judged vendor outstanding • 21% actively seeking to replace package, with 7% citing unsatisfactory performance as reason.

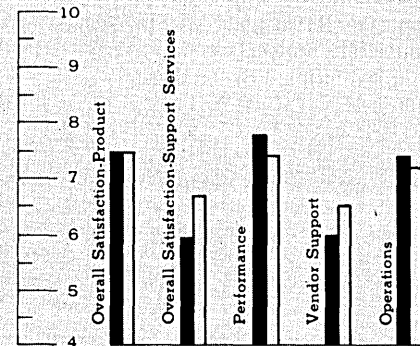

EDOS • Nixdorf Computer, 300 Third Avenue, Waltham, MA 02154 • 617-890-3600

27 responses • 74% judged package and 41% judged vendor outstanding • 37% actively seeking to replace package, with 7% citing unsatisfactory performance as reason.

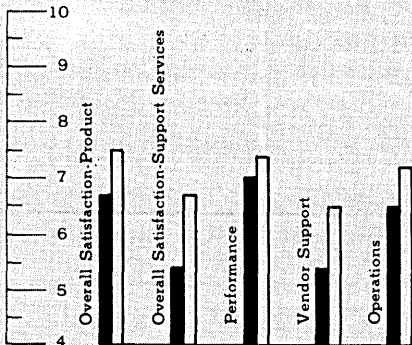

KOMAND • Pace Applied Technology, 7900 Sudley Road, Suite 602, Manassas, VA 22110 • 703-369-3200

45 responses • 76% judged package and 62% judged vendor outstanding • 11% actively seeking to replace package, with 4% citing unsatisfactory performance as reason.

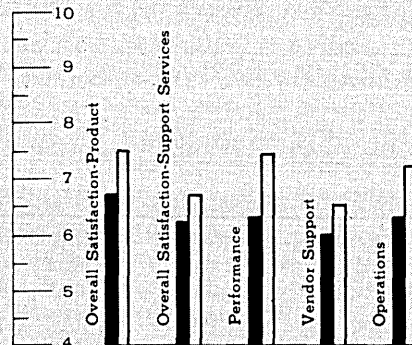

PANVALET • Pansophic Systems, Inc., 709 Enterprise Drive, Oak Brook, IL 60521 • 312-986-2263

41 responses • 90% judged package and 76% judged vendor outstanding • 2% actively seeking to replace package, with 0% citing unsatisfactory performance as reason.

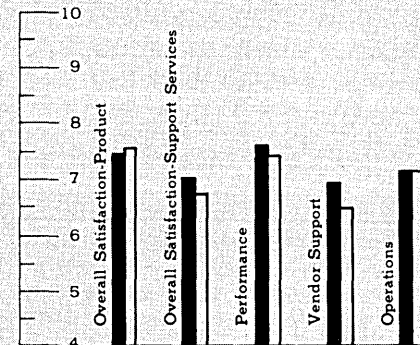

AT SAVINGS
UP TO 50%

IS YOUR 4300 SALESMAN CONFUSED?

END THIS CONFUSION WITH...



THE USX44 -- DESIGNED FOR USERS BY USERS --

OFFERING:

- Increased System Availability • Additional Virtual Storage
 - Separation of ON-LINE, BATCH and TEST WORKLOADS
(with the insurance of a Fail-Soft System)
- Making **STC Ultimacc** The BEST Solution!



STC Ultimacc Systems, Inc.
A subsidiary of
Storage Technology Corporation

Four North Street • Waldwick, New Jersey 07463 • (201) 445-5050

YES, I WANT TO END THIS CONFUSION
 Please rush me more information about USX 44 Complete Business Systems.
 Please have a product representative call me.

Name _____
Title _____
Address _____
City _____ State _____ Zip _____
Phone _____ Current System _____

PRESENTING LEAR SIEGLER'S AMERICAN DREAM MACHINES: THREE NEW HIGH TOUCH™ TERMINALS.

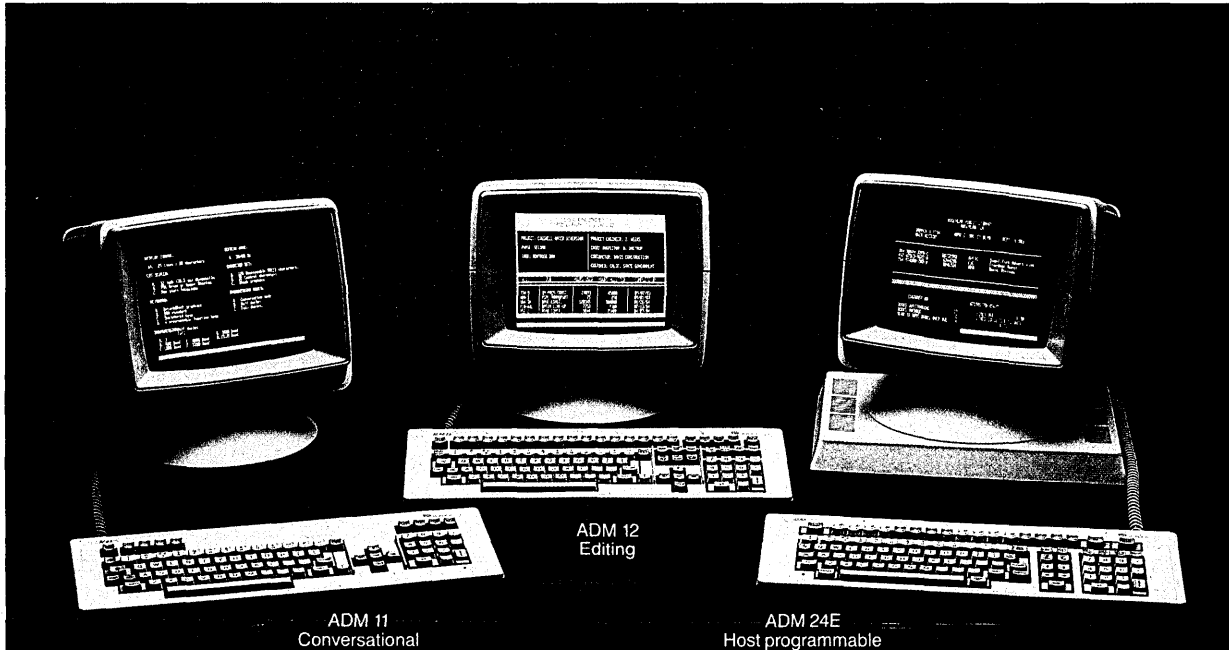

Have you noticed that the more high technology we put into the workplace, the more human touches the workers put in? There's a real need to soften the interface between people and high technology.

That's why we designed our new High Touch™ terminals to work together with biology, not just with technology.

Our new generation of High Touch terminals brings an elegant new touch to our American



6' coiled cable lets you put the keyboard anywhere.

Dream Machine (ADM™) tradition. The family features three new ergonomic terminals designed to meet the needs of OEMs and end users alike: The ADM 11, ADM 12 and ADM 24E.

There is more to ergonomics than simply tacking on a few fadish features as an afterthought. That's why we put our thinking in up front. And came up with a whole new way for terminals to relate to humans.

No aspect of terminal design escaped our deepest consideration. Or reconsideration. Dozens of little touches add up to the convenience and comfort of High Touch. For example, we put the power "on/off" switch and contrast control knob in front where they're easy to reach.

The monitor not only tilts and swivels, it stops positively in almost any position.

The clean, crisp display features a large character matrix on an easy-to-read green or amber non-glare screen—made even easier to read by the hooded bezel. Screens are available in 12" or 14" sizes.

Our uncluttered keyboard, with its logical separations between key groupings, improves your efficiency. The low-profile, DIN-standard keyboard is not only tapered, its angle of tilt is easily adjusted for maximum operator comfort.

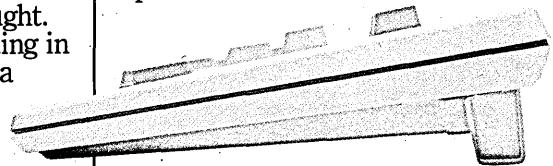

Low profile DIN-standard keyboard with adjustable tilt.

The Selectric® layout with its sculptured keys makes data entry easy and efficient. And we placed the *control* and *escape* keys close to the alphanumeric keys, where people just naturally expect to find them.

The ADM 11 is a High Touch conversational terminal that accepts data continuously at 19.2 kilobauds. It features separate cursor control keys logically arranged in a cross for ease of use. Four modes are provided for the printer interface: page print,

	ADM 11	ADM 12	ADM 24E
Programmable Function Keys	4 (Shiftable to 8)	16 (Shiftable to 32)	16 (Shiftable to 32)
Non-Volatile Function Keys	Optional	Standard	Standard
Function Key Legends on 25th Line	From Host	From Host	Standard Non-Volatile
No. of Pages of Display Memory	1	2	2 or 4
Display Memory Configurations (Plus 25th message/status line)	24 lines by 80 characters	(2) 24x80 or (1) 48x80 or (1) 24x158	User-Definable up to 96x80
Scrolling	Standard Scrolling	Smooth, Jump or Horizontal Scrolling	Smooth or Jump Scroll
Transmission Mode	Conversation Mode	Conversation or Block Mode	Conversation or Block Mode
Editing	Limited	Full Editing & Protected Fields	Full Editing & Protected Fields
Visual Attributes: Reduced Intensity, Blink Blank and Reverse Video. Underline also on ADM 12 and ADM 24E.	3 Embedded 1 Non-Embedded	5 Embedded or Non-Embedded, plus Full Screen Reverse Video	6 Embedded or Non-Embedded, plus Full Screen Reverse Video and Highlight
OEM Flexibility	Modifiable Set-Up Characteristics	Modifiable Set-Up Characteristics & Personality	Modifiable Set-Up Characteristics. Add to Program in ROM or Down-Line Load in RAM (56K ROM or RAM. Plus up to 22K Display Available) Room for add'l Logic Boards.

more computer-based systems than any other.

When you buy Lear Siegler, you're buying proven quality and reliability, backed by the broadest network of full service centers anywhere. That means you can get walk-in Express Depot™

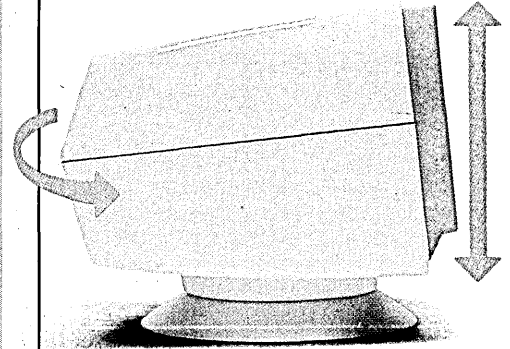

Monitor tilts and swivels to almost any position. Available with 12 or 14 inch screen.

service, on-site service and extended warranty service in 3,000 cities nationwide.

Lear Siegler High Touch terminals are made in America—designed, engineered, manufactured and shipped from Anaheim, California to provide you with the best local support.

And that's just one more reason they're called the American Dream Machines.

line print, transparent print, and display and print. There are four programmable function keys (shiftable to eight). And two levels of setup mode to reduce errors while still giving the operator maximum flexibility.

For a High Touch terminal with editing and more, choose the ADM 12. It features five non-embedded attributes. Embedded mode can also be selected for existing applications. And 16 programmable non-volatile function keys (shiftable to 32). The display memory can be configured as two 24 x 80 character pages, or one 48 x 80 page, or one 24 x 158 page. The terminal runs in either conversational or block mode.

Or choose our top-of-the-line ADM 24E which features a moveable 24-line window you can use to look at 48 (or 96) lines of memory. The ADM 24E also offers plenty of additional space for OEMs, with up to 56K ROM or RAM available for add-on programs. Plus up to 22k display RAM.

When it comes to terminal technology, we're the historic leader with the largest installed base. Our terminals are used in

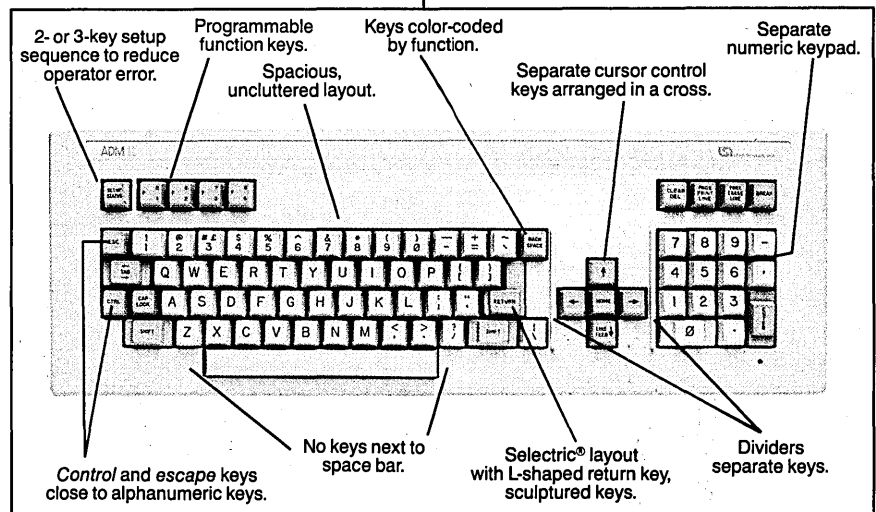

ADM 11 keyboard.

LEAR SIEGLER, INC.
DATA PRODUCTS DIVISION
 901 East Ball Road, Anaheim, CA 92805 • 714-774-1010

EVERYBODY MAKES TERMINALS. ONLY WE MAKE LEAR SIEGLERS.

Call Lear Siegler at 800/532-7373 for an authorized distributor near you: Advanced Technology • Continental Resources • The Datastore • Data Systems Marketing • David Jamason Carlyle, Inc. • Gentry Associates • Hall-Mark Electronics • M/A-COM Alanthus, Inc. • Marva Data Services • M.T.I. • National Computer Communications • Pioneer (Standard, Harvey, Gaithersburg) • 2M Corp. • Wyle Electronics • Kierulff Electronics • Inland Associates • Digital Source, Inc.

CIRCLE 74 ON READER CARD

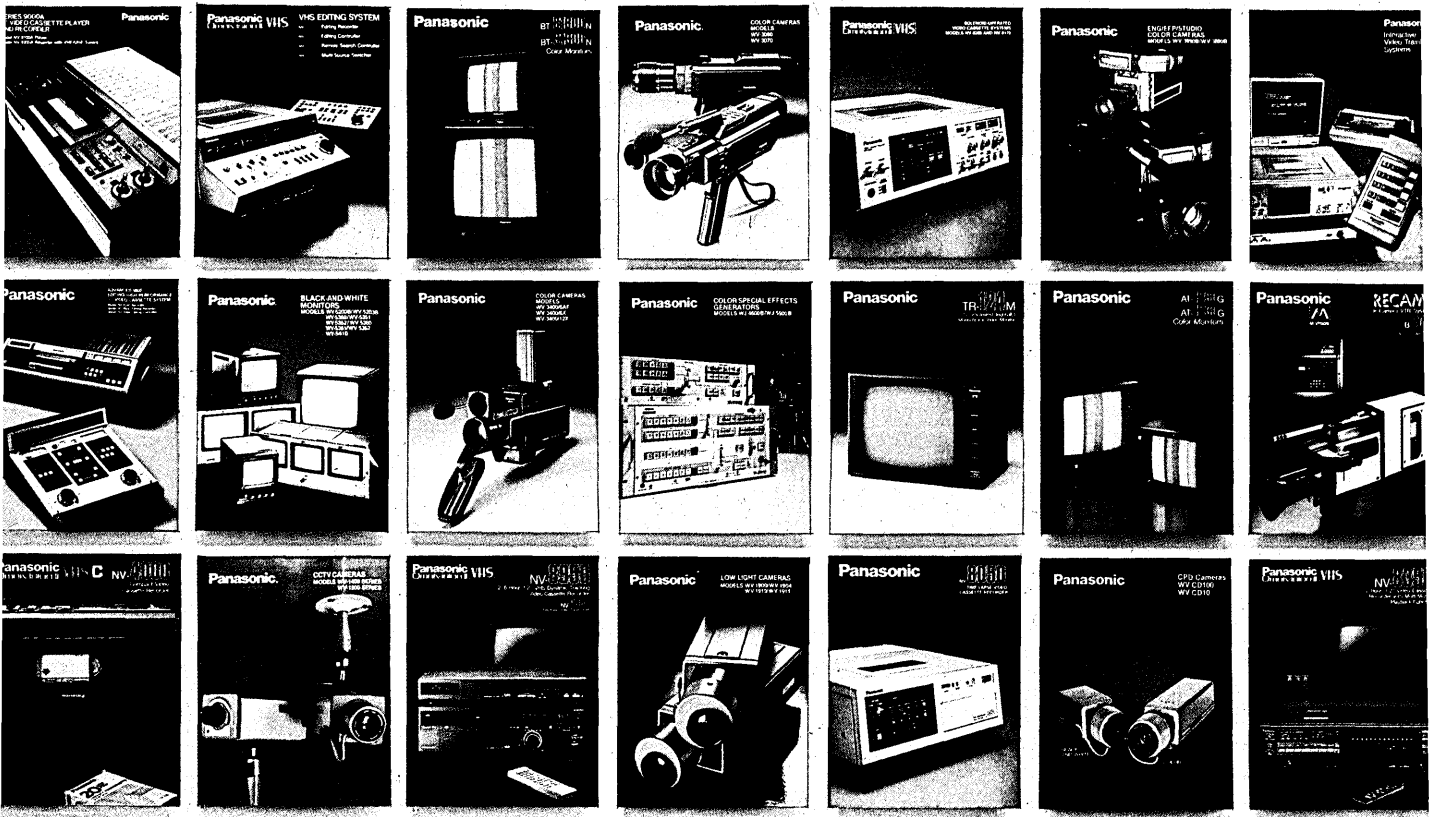

PANASONIC



The only name you need to know in audio and video.

No other company can fulfill your audio and video needs like Panasonic. Because no other company lets you choose from such a broad assortment of industrial video and audio products and accessories built for professional use.

Training

The Panasonic Interactive Video Training System lets you train personnel quickly and efficiently. And for any communications application, Panasonic

offers you the world's largest selection of 1/2-inch industrial video recorders, cameras, monitors, and 3/4-inch decks.

Surveillance

Panasonic keeps you covered with a complete line of closed-circuit TV products. From low light cameras that let you see in the dark, to our economical mini-security system, to our time-lapse recorder that records up to 240 hours on a single cassette.

Production

For broadcast quality production take a look at RECAM!™ The portable recorder/camera with picture quality so outstanding it's being used by TV networks and major broadcast production companies.

In audio, Panasonic offers a full line of commercial sound products as well as RAMSA professional sound reinforcement equipment. So whether you're watching, listening

or both, there's only one name you need to know in audio and video. Panasonic.

Let us know what you need. Call your nearest Panasonic regional office for more information on the products you're interested in:
 Northeast: (201) 348-7620;
 Midwest: (312) 981-4826;
 Southeast: (404) 925-6835;
 Southwest: (214) 258-6400;
 West: (714) 895-7200.

Panasonic
 AUDIO-VIDEO SYSTEMS DIVISION

Ratings Values

10-9: Superior
8-6: Very Good

5-3: Acceptable
2-1: Inadequate

Legend

■ Specific Product Rating
□ Group Average Rating

EPAT • SDI, Inc., 1700 South El Camino Real, P.O. Box 5801, San Mateo, CA 94402 • 415-572-1200

41 responses • 88% judged package and 66% judged vendor outstanding • 32% actively seeking to replace package, with 2% citing unsatisfactory performance as reason.

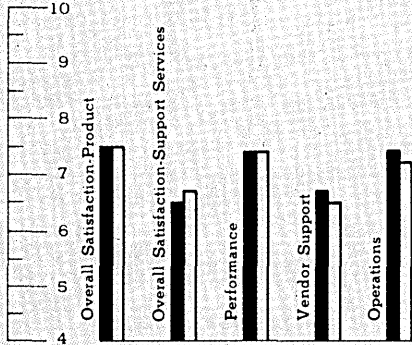

GRASP • SDI, Inc., 1700 South El Camino Real, P.O. Box 5801, San Mateo, CA 94402 • 415-572-1200

23 responses • 83% judged package and 57% judged vendor outstanding • 52% actively seeking to replace package, with 0% citing unsatisfactory performance as reason.

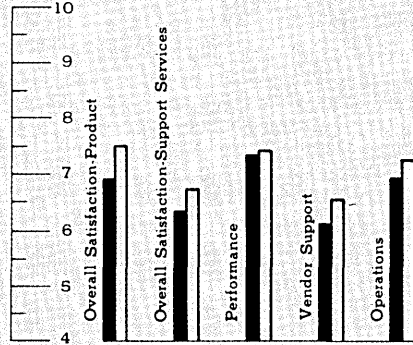

DMS/OS • Software Module Marketing, Crocker Bank Building, Penthouse, 1007 Seventh Street, Sacramento, CA 95814 • 916-441-7234

61 responses • 92% judged package and 89% judged vendor outstanding • 5% actively seeking to replace package, with 0% citing unsatisfactory performance as reason.

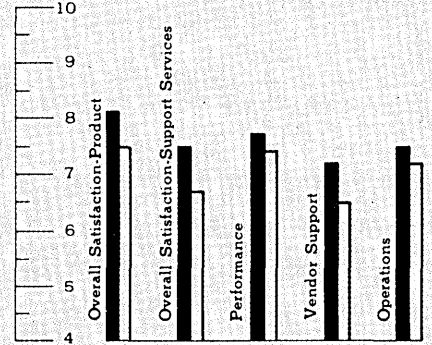

DOS/MVT/VSE • Software Pursuits, Inc., 444 Market Street, Suite 800, San Francisco, CA 94111 • 415-392-7171

65 responses • 95% judged package and 81% judged vendor outstanding • 14% actively seeking to replace package, with 2% citing unsatisfactory performance as reason.

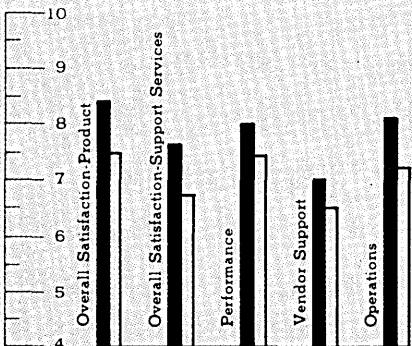

SYNCSORT • Synsort, Inc., 560 Sylvan Avenue, Englewood Cliffs, NJ 07632 • 201-568-9700

60 responses • 97% judged package and 88% judged vendor outstanding • 2% actively seeking to replace package, with 0% citing unsatisfactory performance as reason.

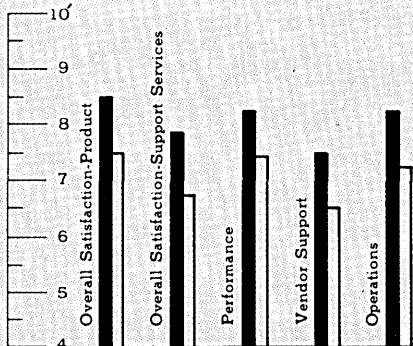

D/FAST • Tower Systems, 19782 MacArthur Blvd., Suite 365, Irvine, CA 92718 • 714-752-8263

64 responses • 78% judged package and 59% judged vendor outstanding • 17% actively seeking to replace package, with 3% citing unsatisfactory performance as reason.

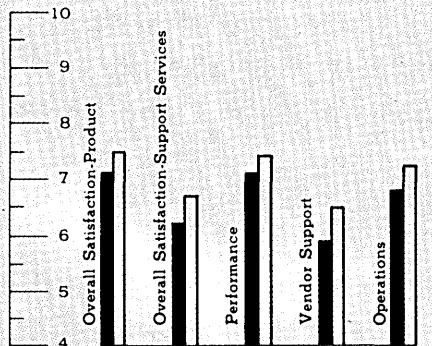

T/FAST • Tower Systems, 19782 MacArthur Blvd., Suite 365, Irvine, CA 92718 • 714-752-8263

66 responses • 79% judged package and 67% judged vendor outstanding • 11% actively seeking to replace package, with 2% citing unsatisfactory performance as reason.

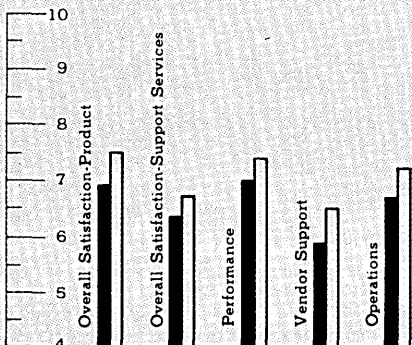

UCC ELEVEN • University Computing Co., UCC Tower, Exchange Park, Dallas, TX 75235 • 214-353-7150

45 responses • 87% judged package and 67% judged vendor outstanding • 4% actively seeking to replace package, with 0% citing unsatisfactory performance as reason.

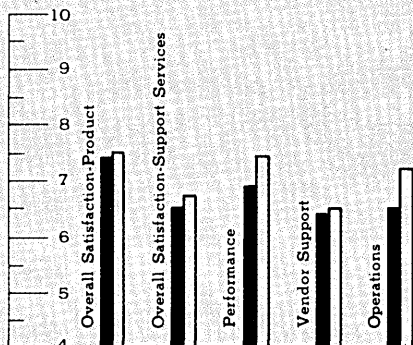

UCC ONE • University Computing Co., UCC Tower, Exchange Park, Dallas, TX 75235 • 214-353-7150

58 responses • 93% judged package and 79% judged vendor outstanding • 2% actively seeking to replace package, with 0% citing unsatisfactory performance as reason.

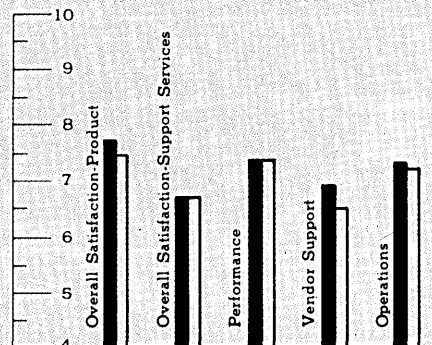

Ratings Values

10-9: Superior
8-6: Very Good

5-3: Acceptable
2-1: Inadequate

Legend

■ Specific Product Rating
□ Group Average Rating

UCC SEVEN • University Computing Co., UCC Tower, Exchange Park, Dallas, TX 75235 • 214-353-7150

58 responses • 88% judged package and 67% judged vendor outstanding • 3% actively seeking to replace package, with 3% citing unsatisfactory performance as reason.

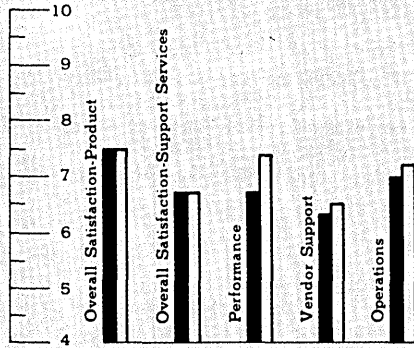

UCC TWO • University Computing Co., UCC Tower, Exchange Park, Dallas, TX 75235 • 214-353-7150

34 responses • 59% judged package and 56% judged vendor outstanding • 21% actively seeking to replace package, with 0% citing unsatisfactory performance as reason.

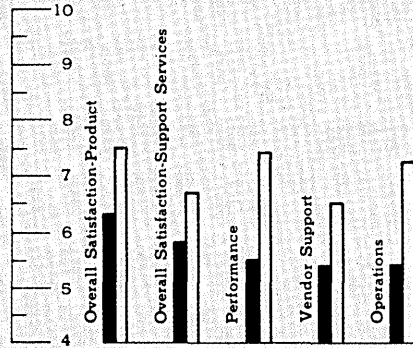

DISK UTILITIES • Westinghouse Electric Corp., 2040 Ardmore Boulevard, Pittsburgh, PA 15221 • 412-636-3100

72 responses • 99% judged package and 88% judged vendor outstanding • 3% actively seeking to replace package, with 0% citing unsatisfactory performance as reason.

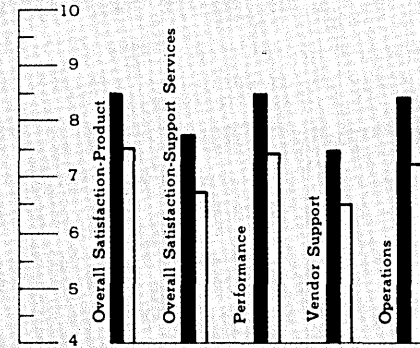

MONITORING & PERFORMANCE AIDS

Group Average • 10 packages

433 responses • 79% judged package and 71% judged vendor outstanding • 12% actively seeking to replace package, with 2% citing unsatisfactory performance as reason.

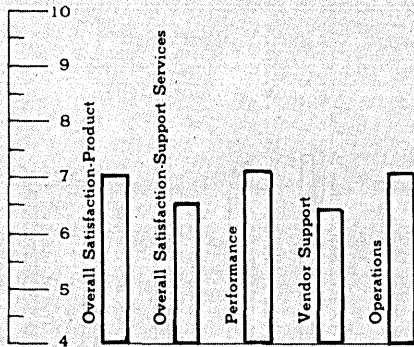

LOOK • Applied Data Research, Rt. 206 & Orchard Road, CN 8, Princeton, NJ 08540 • 201-874-9100

50 responses • 86% judged package and 72% judged vendor outstanding • 10% actively seeking to replace package, with 2% citing unsatisfactory performance as reason.

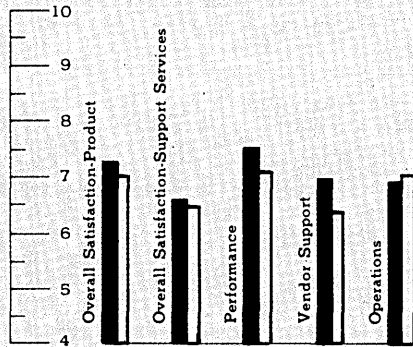

BEST/1 • BGS Systems, One University Office Park, 29 Sawyer Road, Waltham, MA 02254 • 617-891-000

54 responses • 87% judged package and 83% judged vendor outstanding • 11% actively seeking to replace package, with 2% citing unsatisfactory performance as reason.

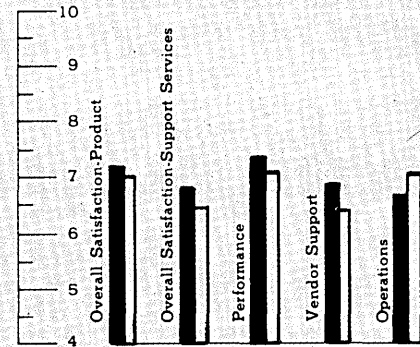

CAPTURE/MVS • BGS Systems, One University Office Park, 29 Sawyer Road, Waltham, MA 02254 • 617-891-0000

52 responses • 79% judged package and 83% judged vendor outstanding • 12% actively seeking to replace package, with 4% citing unsatisfactory performance as reason.

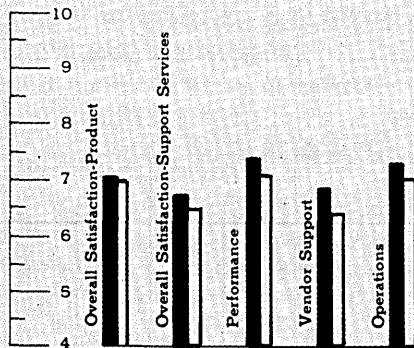

CMF/MONITOR • Boole & Babbage, Inc., 510 Oakmead Parkway, Sunnyvale, CA 94086 • 408-735-9550

53 responses • 73% judged package and 59% judged vendor outstanding • 21% actively seeking to replace package, with 6% citing unsatisfactory performance as reason.

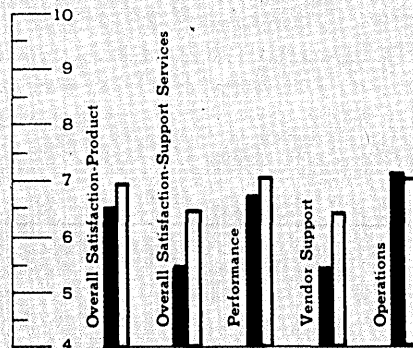

CONTROL/IMS & CONTROL/REAL-TIME • Boole & Babbage, Inc., 510 Oakmead Parkway, Sunnyvale, CA 94086 • 408-735-9550

49 responses • 80% judged package and 69% judged vendor outstanding • 12% actively seeking to replace package, with 4% citing unsatisfactory performance as reason.

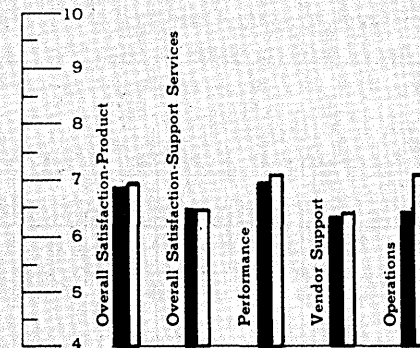

Getting your system in front of management is finally made simple.

Now your system can be accessed quickly and easily with Northern Telecoms Displayphone terminal. It's as simple to use as a telephone. And compact enough to fit on everyone's desk.

Perhaps the most difficult part of your job is getting your system in front of the people who would benefit from it most. Management often finds computer terminals too bulky or too complicated to operate. As a result they shut themselves off from information that can be vital to your company's productivity.

MIS professionals in a variety of industries have discovered the Displayphone* terminal, an ideal solution to the problem of user acceptance. Voice and data are integrated into one compact unit whose sophisticated capabilities are so easy to use, everyone will welcome it on their desks.

Menus of features and functions, visual prompts and terminal-resident soft keys guide even novice data users through correct operation easily. And soft keys can also be downloaded from your host computer for single key activation of program commands. As an advanced business telephone, the Displayphone unit brings the convenience of voice features such as directory dialing to data calls, and allows simultaneous voice and data communications.

In addition to its ease of use, the Displayphone terminal offers powerful data access capability.

It is an asynchronous terminal that can also be configured to operate in IBM 3270 and other sophisticated computer environments. This flexibility gives users high speed access to a full range of corporate and public data bases.

The Displayphone terminal is an exciting example of Northern Telecom's commitment to the OPEN World—our approach to information management that combines telecommunications and computer technology in innovative ways to increase productivity, save time ...and money.

To find out how productive the Displayphone terminal can be for your company, call 800/621-6476. (In Illinois: 800/572-6724; in Canada: 800/268-9079), or send in the coupon.

OPEN World.
the rational approach to information management. It's the best of all possible worlds.

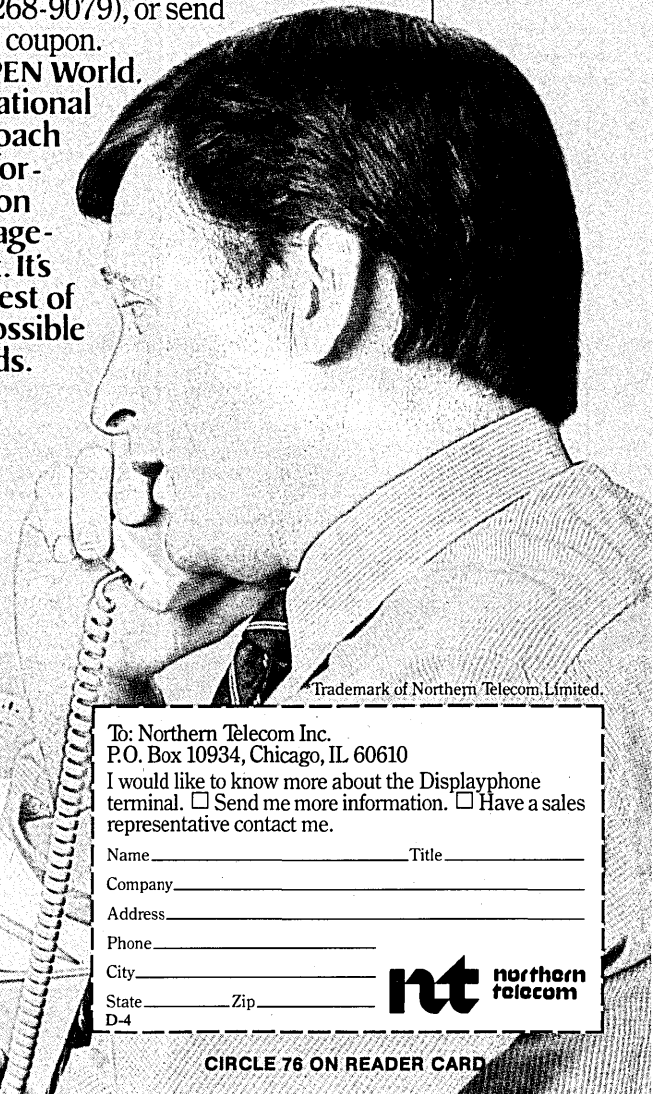
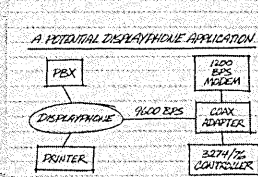

*Trademark of Northern Telecom Limited.

To: Northern Telecom Inc.
P.O. Box 10934, Chicago, IL 60610

I would like to know more about the Displayphone terminal. Send me more information. Have a sales representative contact me.

Name _____ Title _____

Company _____

Address _____

Phone _____

City _____

State _____ Zip _____

D-4



CIRCLE 76 ON READER CARD

Ratings Values

10-9: Superior
8-6: Very Good
5-3: Acceptable
2-1: Inadequate

Legend

■ Specific Product Rating
□ Group Average Rating

RESOLVE-RESOLVE/CICS • Boole & Babbage, Inc., 510 Oakmead Parkway, Sunnyvale, CA 94086 • 408-735-9550

39 responses • 74% judged package and 61% judged vendor outstanding • 10% actively seeking to replace package, with 3% citing unsatisfactory performance as reason.

TSA/PPE • Boole & Babbage, Inc., 510 Oakmead Parkway, Sunnyvale, CA 94086 • 408-735-9550

38 responses • 71% judged package and 63% judged vendor outstanding • 5% actively seeking to replace package, with 0% citing unsatisfactory performance as reason.

OMEGAMON • Candle Corporation, 10880 Wilshire Blvd., Suite 2404, Los Angeles, CA 90024 • 213-470-2277

32 responses • 97% judged package and 81% judged vendor outstanding • 0% actively seeking to replace package.

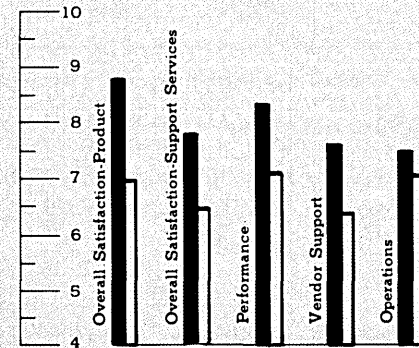
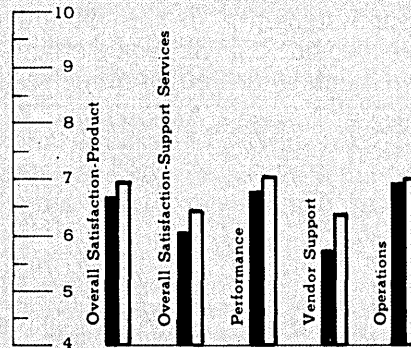
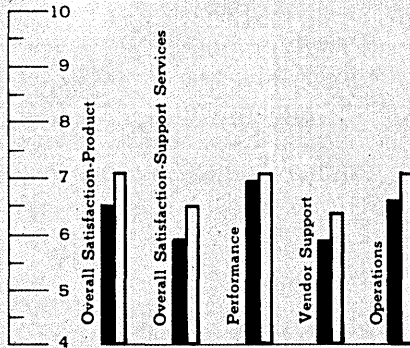

REPORT AVAILABLE

This systems software survey is based on a forthcoming report in Data Decisions' *Software*, a monthly information service covering systems and applications software. Additional information

on Data Decisions' subscription services and custom consulting capabilities is available from Data Decisions, 20 Brace Rd., Cherry Hill, NJ 08034, (609) 429-7100.

TSO/MON • Morino Associates, 8133 Leesburg Pike, Suite 602, Vienna, VA 22180 • 703-734-9494

40 responses • 85% judged package and 95% judged vendor outstanding • 8% actively seeking to replace package, with 0% citing unsatisfactory performance as reason.

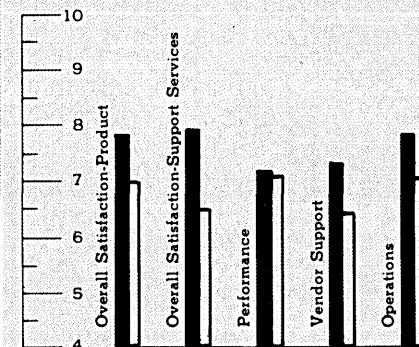

COMPUT-A-CHARGE • Value Computing, Inc., 498 North Kings Highway, Cherry Hill, NJ 08034 • 609-482-2500

26 responses • 54% judged package and 46% judged vendor outstanding • 31% actively seeking to replace package, with 15% citing unsatisfactory performance as reason.

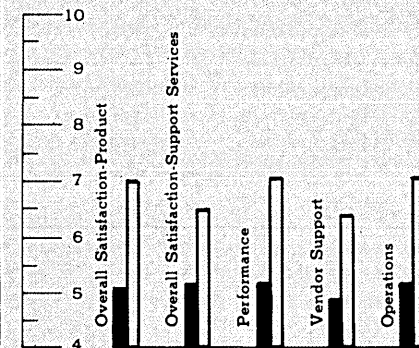

**UNIVERSITY OF PETROLEUM & MINERALS
DHAHRAN, SAUDI ARABIA
COMPUTER SCIENCE AND ENGINEERING DEPARTMENT**

The Department of Computer Science and Engineering will have faculty positions in Computer Science and Engineering open for the Academic Year 1984-85, starting 1 September 1984.

ACADEMIC QUALIFICATIONS AND EXPERIENCE:

Ph.D. in Computer Science or Computer Engineering or in a closely related discipline with emphasis in programming languages, Data Base-Organization and Structure, Micro-processors, Operating Systems, Data Processing, System Analysis, Digital Design, Computer Architecture, Software Engineering, Micro-Electronics and Robotics.

The Department offers an undergraduate program in Computer Science and Engineering and a Master program in Computer Sciences.

Computing facilities available include a Computer-Aided-Instruction Center based on an HP-3000 and a number of Micro-Computers, a Computer-Graphics Center with a VAX 11/780 and number of work stations in addition to an IBM 360/158, IBM 3033 and various minicomputers and microcomputers.

English is the language of instruction.

Minimum regular contract for two years, renewable. Competitive salaries and allowances. Air conditioned and furnished housing provided. Free air transportation to and from Dhahran each year. Attractive Educational Assistance Grants for school age dependent children. All earned income without Saudi taxes. Ten months duty each year with two months vacation with salary. There is also possibility of selection for the University's on-going Summer Program with good additional compensation.

Apply before 30 January 1984, with complete resume on academic, professional and personal data, list of references, publications and research details, and with copies of transcripts and degrees, including home and office addresses and telephone numbers:

University of Petroleum & Minerals
Houston Office (Dept. 105)
5718 Westheimer, Suite 1550
Houston, TX 77057



CIRCLE 77 ON READERCARD

The computer-age equivalent of the plain paper copier

Organizational data reaches people on paper. It reaches their personal computers on diskette...and diskette duplicators do for computers what office copiers do for people.

In speed, convenience, and cost, the FORMASTER® Series Two diskette duplicator ideally fills the data distribution gap between paper and telecommunications. It's the perfect solution for distributing price lists, financial models, database updates, or any other information that has to reach your computers quickly. ■ The Series Two contains the same proven FORMASTER technology used around the world by commercial software publishers, for whom accuracy, speed, reliability, and security are critical. At the press of a button, it creates a fully-verified diskette copy, up to ten times faster than a microcomputer. ■ And if you use more than one type of micro, Series Two plug-in options accommodate all makes of computers with 5¼" or 3½" drives.



FORMASTER CORPORATION

1983 Concourse Dr., San Jose, CA 95131. (408) 942-1771. Telex 466462.
FORMASTER U.K. Corporation: Milton House, 172-184 Bath Road, Slough, Berks. SL1-3XE,
England, Tel. (0753) 820981, Telex 925-859

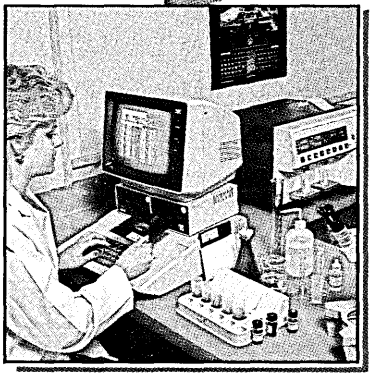

To take full advantage of your organization's computers, investigate the Series Two. It's affordable...and it's brought to you by the leader in software production technology.

Turing's post-World War II design efforts at a British laboratory led to the Automatic Computing Engine (ACE), which some claim was the first programmable digital computer.

ALAN TURING: THE ENIGMA

Many names come forth from computing's Paleolithic past: K. Zuse, Eckert and Mauchly, H. Aiken, John von Neumann. But none are so intriguing, or so linked with the eccentric, as that of Alan M. Turing. Turing was born in Paddington, England on June 23, 1912 and died on June 7, 1954. His name is known to students of computer science since it is attached to the Turing machine—a theory and, eventually, a device that he invented. The Turing machine proved to be the theoretical groundwork for the modern digital computer. It showed that certain propositions were undecidable, and that a closed system could contain surprises. It also showed a way for universal mechanical computation.

In 1928 David Hilbert questioned whether mathematics was complete, consistent, and decidable. He posited that there was no such thing as an unsolvable problem. His objective was the discovery of a definite process, applicable to any mathematical theorem, for deciding the truth of that theorem. He defined this process as something that could be done by automatic machine. Kurt Gödel later showed that arithmetic was necessarily incomplete, and proved that the truth of a theorem could not be equated to the provability of it in any finite logic. But the possibility of finding a mechanical process of provability remained. Turing dismissed this as impossible in his 1937 paper, "On Computable Numbers, with an Application to the Entscheidungsproblem." In it he described a machine that, when supplied with the necessary instructions via punched paper tape,

would imitate the behavior of any other machine. By giving a precise definition of "computable," Turing showed there was no mechanical method for solving certain problems.

It was logical that he would strive to see his theory of universal machine take actual form. It was quite innovative to speak of punched tape and universal computability in 1937.

The following excerpt deals with the three years (1945-48) Turing spent at Britain's National Physical Laboratory (NPL) working on the design and construction of a large automatic computing machine, the Automatic Computing Engine (ACE), which was arguably the first programmable digital computer. Turing's design for the ACE marked a turning point, as it was the first to emphasize construction of a large, fast, and effective all-purpose electronic memory. ACE was the first stored-program universal machine and was not dedicated to any given task.

Previous to his stay at the NPL, Turing worked at the Government Code and Cypher School in Bletchley Park, where his cryptanalytical work with the naval Enigma code helped diminish the effectiveness of German U-boats.

It is difficult to overestimate Turing and his contributions, both to mathematics and computer science. Awarded the Order of the British Empire in 1946, Turing was also to become a fellow of the Royal Society.

Turing cut an archetypically eccentric professorial figure. His unkempt appearance, his unrestrained behavior, and his legendary abilities at running and bicycling contribute to his reputation as a classically peculiar person. Yet such a conception detracts from the essentially tragic nature of his life. Turing reminds us that genius must bear with fools, and must often stoop to our petty dominion.

It was all over except the details—and Alan was never very good at bothering with the last details. He had other ideas in mind. He had several times discussed the question of his peacetime plans, and said he was expecting to return to his King's [College, Cambridge] fellowship. There were 18 months of his 1938 fellowship still to run. But beyond this he now had a longer period assured, since on May 27, 1944, King's had prolonged the tenure of his fellowship by three years. He could go back as if the war had never happened and continue from where he had left off in 1939. Yet the war had not simply been an interruption in the course of his intellectual career. His ideas had been able to grow with the scale of the war. For, though expecting to return to Cambridge, Alan from the start wanted to "build a brain."

His use of the word "brain" was entirely consistent with his bold appeal to "states of mind" 10 years before. To understand the Turing model of the brain, it was crucial to see that it regarded physics and chemistry as essentially irrelevant. In speaking of building a brain he did not mean that the components of his machine should resemble the components of a brain, or that their connections should imitate the manner in which the regions of the brain were connected. That the brain stored words, pictures, skills in some definite way, connected with input signals from the senses and output signals to the muscles, was almost all he needed.

The exigencies of the German cipher machines had barely scratched the surface of what could be done. The construction of special machines had led the cryptanalysts into problems with the acquisition and application of new technology. But a universal machine, if it could be realized in practice, would require no fresh engineering, only fresh instruction tables, encoded as "description numbers" and placed upon its tape. It was a vision beyond the comprehension of most

Excerpted from *Alan Turing: The Enigma*, by Andrew Hodges. Copyright 1983 by Andrew Hodges. Reprinted by permission of Simon & Schuster Inc. First published in Britain by Burnett Books in association with Hutchinson Publishing Group.

ILLUSTRATION BY CAROL WALD

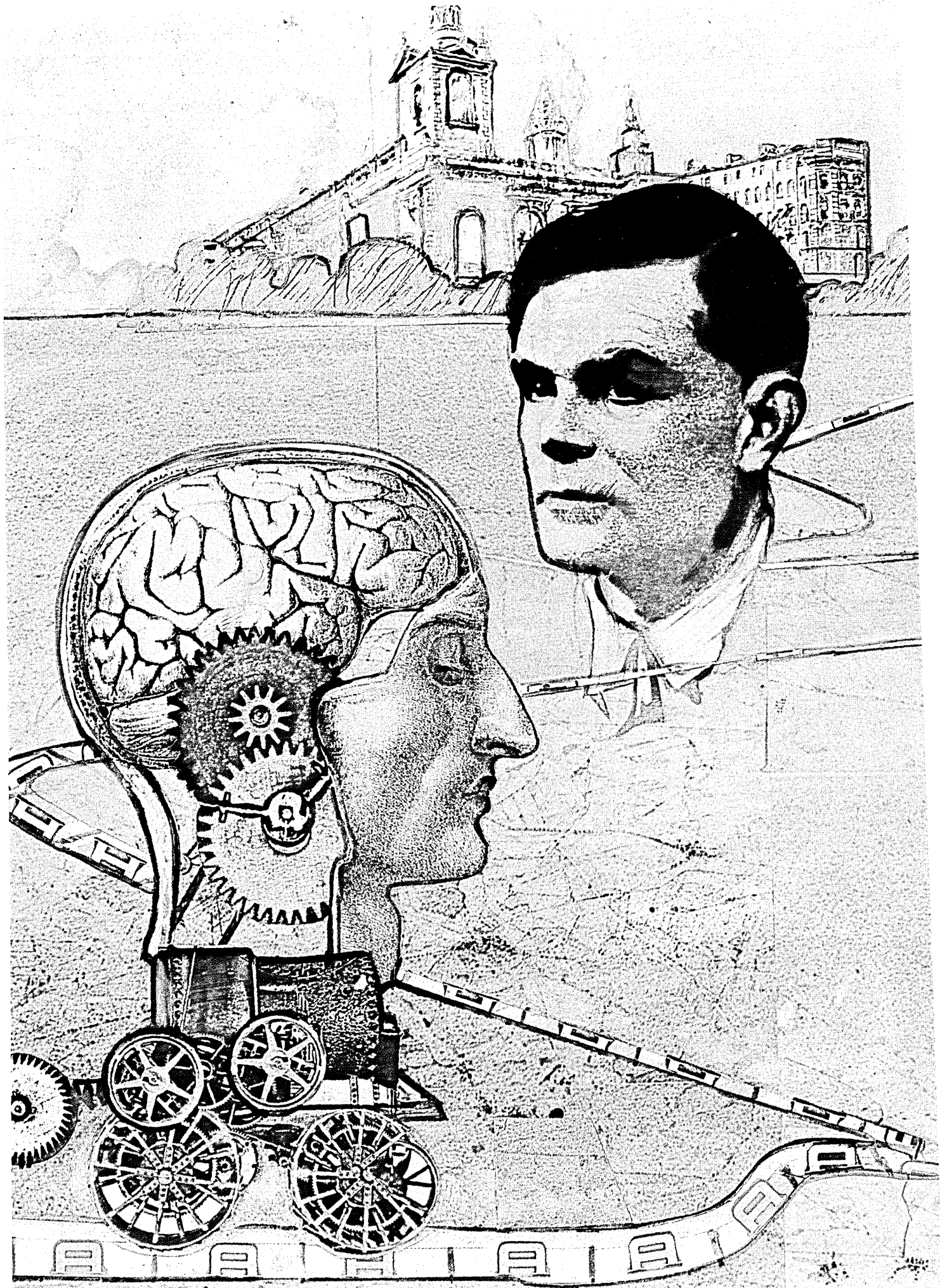

and word

people in 1945, but not beyond Alan Turing:

There will positively be no interval alterations to be made even if we wish suddenly to switch from calculating the energy levels of the neon atom to the enumeration of groups of order 720.

A METHOD IN HIS MADNESS

There was nothing in the paper design of the universal Turing machine that suggested it could be made a practical proposition. In particular, there was nothing about its speed of operation. If a universal machine were to be of any practical use, it would have to run through millions of steps in a reasonable time. This demand for speed could only be met by electric components. More precisely, electronic components could be regarded as operating discrete quantities, and so could a Turing machine. There had been a method in his madness all along. He had learned how to build a brain—not an electric brain, as he might have imagined before the war, but an electronic brain.

There was a further fundamental consideration besides discreteness, reliability, and speed: that of size. There would have to be room on the tape of a universal machine both for the description numbers of the machine it had to imitate and for its workings. The abstract machine of 1936 was equipped with a tape of indefinite length, meaning that although the amount of tape used would be infinite, it was assumed that more space could be made available as required. How much tape would be required for a machine that could actually be built? How could storage be arranged without inconceivable expense in terms of electronic valves?

Alan was drawn toward the digital machine, because the Turing machines of "Computable Numbers" were the abstract version of such machines. His predisposition would have been reinforced by long experience with digital problems in cryptanalysis.

The spring of 1945 saw the ENIAC team [Electronic Numerical Integrator and Calculator, designed by J.P. Eckert and J. Mauchly at the University of Pennsylvania] on the one hand, and Alan Turing on the other, arrive naturally at the idea of constructing a universal machine with a single tape. But they did so in rather different ways. The ENIAC, shown to be out of date in principle before it was finished, had been something of a sledgehammer in cracking the problem. When Alan Turing spoke of building a brain, he was working and thinking alone in his spare time, pottering around in a British back garden shed with a few pieces of equipment grudgingly conceded by the secret service. He was not being asked to provide the solution to numerical problems such as those von Neumann was engaged upon. He

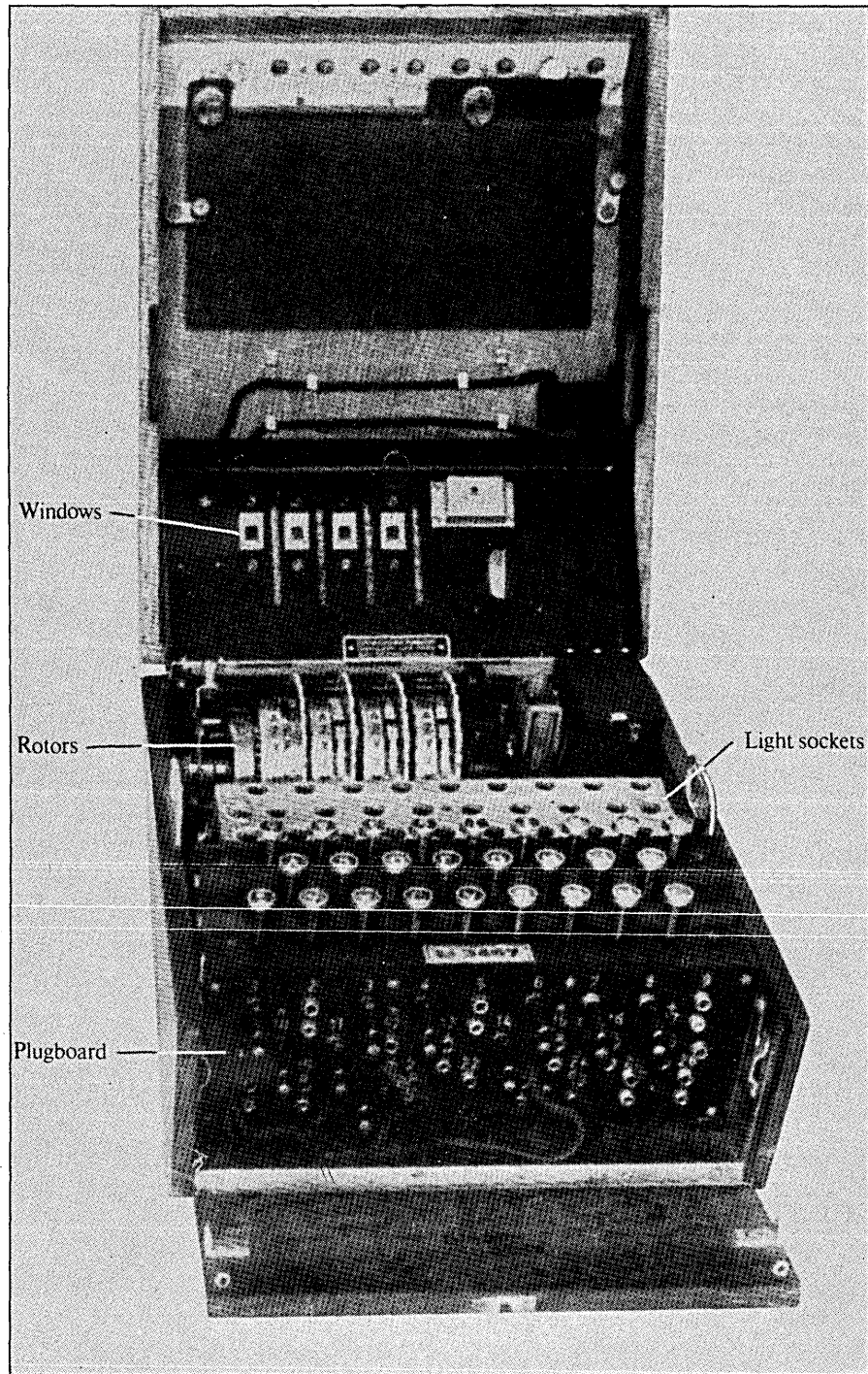

The naval Enigma machine, basis of German encryption efforts and a key to U-boat deployment. At Bletchley Park, Turing and others solved it.

had simply put together things that no one had put together before: his one-tape universal machine, the knowledge that large-scale electronic pulse technology could work, and the experience of turning cryptanalytic thought into definite methods and mechanical processes. Since 1939 he had been concerned with little but symbols, states, and instruction tables—and with the problem of embodying these as effectively as possible in concrete forms.

At some point Alan recognized in von Neumann's proposals [in the *Draft Report on the EDVAC*, the electronic discrete variable

calculator, the planned second electronic machine] the same essential content of building a brain. So, once again, British originality had been pipped at the post by an American publication. The Americans had won, and Alan was second. This time, however, American priority was nothing but an advantage to the Turing plans, for it provided the political and economic impetus that his ideas alone could never have enjoyed. Indeed, it was probably only the existence of the ENIAC that made possible the next stage of Alan Turing's life. In June he had a telephone call from John Womersley, superintendent of the mathemat-

WHEN AMERICA'S TOP CORPORATIONS WANT TO CONTROL THEIR INFORMATION RESOURCES, THEY CALL HOLLAND.

Not so long ago, most companies believed that any information problem could be solved by adding another computer.

And another.

And another.

Inevitably, the legacy of that approach has been astronomical DP costs. Fragmented, redundant database systems. And untimely, inaccurate reports.

When those problems began to surface at some of the leading Fortune 1000 corporations, key executives all had the same response.

They called Holland Systems Corporation.

Working with top people in each department, we helped develop a functional business model of the organization. We then created the framework for designing and implementing a shared, integrated data and information system. And we left behind dynamic guidelines for meeting short- and long-term corporate information needs.

While our top-down Strategic Systems Planning™ product may

complement BSP™ and similar methodologies, it goes much further. By combining appropriate software, education and method, SSP allows companies to prioritize and control data and information systems development. Often for the first time.

If you're interested in making information more manageable, call Tony Comazzi, Vice President, at 313/995-9595.

You'll be in good company.
Holland Systems Corporation
3131 South State Street S-303
Ann Arbor, Michigan 48104

BSP is a trademark of International Business Machines Incorporated.

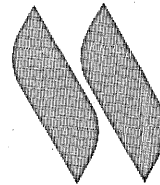

**HOLLAND
SYSTEMS
CORPORATION**

Putting Information to Work.

SAVE MONEY ON TALK FASTER.

THE CODEX 224
DIAL MODEM.

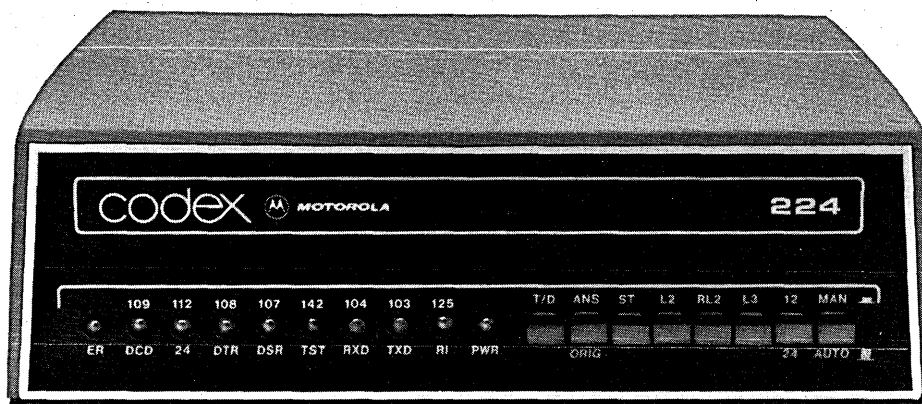

YOUR PHONE BILL.

If you're running 212 modems in a dial-up network, Codex has a new product that can significantly reduce your phone bills.

It's the Codex 224 modem.

At 1200 bits per second, the Codex 224 is fully compatible with Bell's 212 modem. But because the Codex 224 also runs at 2400 bits per second you can transfer more data faster and therein lies the economy.

You can run at 2400 bps full duplex asynchronous or synchronous over public telephone lines, even unattended. And because the Codex 224 incorporates advanced equalizers you're assured of high performance at higher speeds even over marginal lines. In addition, the Codex 224 automatically recognizes 1200 or 2400 bps transmissions and adjusts automatically.

And with faster file transfer and screen fills,

people in the network will be able to get more done in the same time.

What all this means is that you can get better productivity and significant savings in your 212 network simply by installing Codex 224 modems.

The Codex 224, which meets the CCITT international standard, can be leased directly from Codex or purchased outright.

In short, you don't have to make a massive investment to run a better, faster, more economical network.

All you have to do is call Codex.

Call 1-800-821-7700 Ext. 895. Or write:
Codex Corporation, Dept. 707-95, 20 Cabot Blvd.,
Mansfield, MA 02048.

Codex



MOTOROLA INC.
Information Systems Group

“He had learned how to build a brain—not an electric brain . . . but an electronic brain.”

ics division at the National Physical Laboratory.

The National Physical Laboratory had been set up in suburban Teddington in 1900, the British response to state-sponsored German scientific research. It was the most extensive government lab in the U. K., enjoying a high reputation within its traditional sphere, that of testing and calibrating equipment for British industry. Its current director, installed in 1938, was Sir Charles Galton Darwin, grandson of the theorist of evolution and himself an eminent Cambridge applied mathematician. Large, awesome, and remote, he had spent a year during the war as director of what became the British Central Scientific Mission in Washington, and had been the first scientific advisor to the British Army.

The mathematics division, however, was new. In about March 1944 a proposal had been mooted for an Independent Mathematical Station. This suggestion went to a large interdepartmental committee, a manifestation of cooperation and coordination unthinkable in peacetime. The government accepted the principle of continuing the funding found necessary in war. A rationalized institution was placed to take over the various ad hoc offices that had done the work of numerical computation for military purposes. Sir Charles Darwin persuaded the committee to establish it as a division of the NPL.

Darwin was par excellence as a scientific administrator who had risen to new heights in the circumstances of war. This peacetime extension of his powers made him responsible for building the machine that might—if Turing's ideas were right—have devastating effect. There was, however, an intermediary in the chain of command, and this was Womersley. On Sept. 27, 1944 Womersley had been selected as the first superintendent of the mathematics division.

The official research program for the new division in October 1944 included “investigation of the possible adaptation of automated telephone equipment to scientific computing” and “development of electronic counting device suitable for rapid computing.” Behind these words there were probably more intentions to imitate American developments. Douglas Hartree, with his differential analyser at Manchester University, already had an interest in computing machinery. In the high levels where he moved, some details of the secret ENIAC machine might have filtered through. Such knowledge was probably reflected in Womersley's report in December 1944. Though it placed emphasis on building a large differential analyser, it remarked on the speed of electronics and suggested that “a machine can be made to perform certain cycles of operations me-

chanically . . . the instructions to the machine could depend on the result of previous operations . . . the problem is already being tackled in the U.S.A.” It seemed that the direction in which to look was westward, and in February 1945 Womersley had been packed off on a two-month tour of the computing installations of the U.S., where on March 12 he was the first non-American to be allowed access to the ENIAC. Hartree also visited it at the end of June.

ACCEPTS NEW JOB OFFER

A guarded commitment to new computing machinery, followed by a privileged preview of the American developments, were therefore the background to an offer of a position to Alan Turing. Womersley was back in Britain by May 15, reporting that he was “revising his plans” in the light of his American trip. Alan went to the NPL to meet Womersley, and accepted the offered position. He would be appointed a temporary senior scientific officer, a post roughly equivalent to that of a senior university lecturer. It transpired that Womersley asked him whether he knew “the integral of $\cos X$,” which, as Don Bayley immediately said, was a ludicrously trivial question to ask any prospective senior scientific officer. “Ah,” said Alan, in a joke against his own capacity for carelessness, “but what if I had got it wrong?”

Money, commerce, and competition had played no obvious part in the develop-

ments in which Alan Turing was enmeshed. His retention of a primitive liberalism, his “championing of the underdog,” like his obsession with the absolutely basic, had the flavor of a utopian thinker.

There was a new spirit, and yet it was a spirit within a machine. A much enlarged state apparatus and the more centralized economy were the legacy of the great battle for intelligence. Unhindered by wasteful competition, the Government Code and Cypher School and the Post Office had proved capable of managing fantastic feats. Now the development of the electronic computer was being taken over by the National Physical Laboratory for the public good.

Alan Turing discussed with Don Bayley the problem that dominated the engineering of the universal machine, that of the storage mechanism, or tape. They had seen a captured German Army Magnetophon, the first successful tape recorder, but rejected the idea essentially because magnetic tape was too much like the tape of the theoretical universal Turing machine—it would require too much physical moving. Instead they favored another solution, the acoustic delay line. The idea was based on the fact that the time taken for a sound wave to travel a few feet of pipe was on the order of a thousandth of a second. The pipe could be regarded as storing the sound wave for that period. The principle had already been applied in radar, using information stored in the delay line to cancel out radar echoes that had not changed since the last

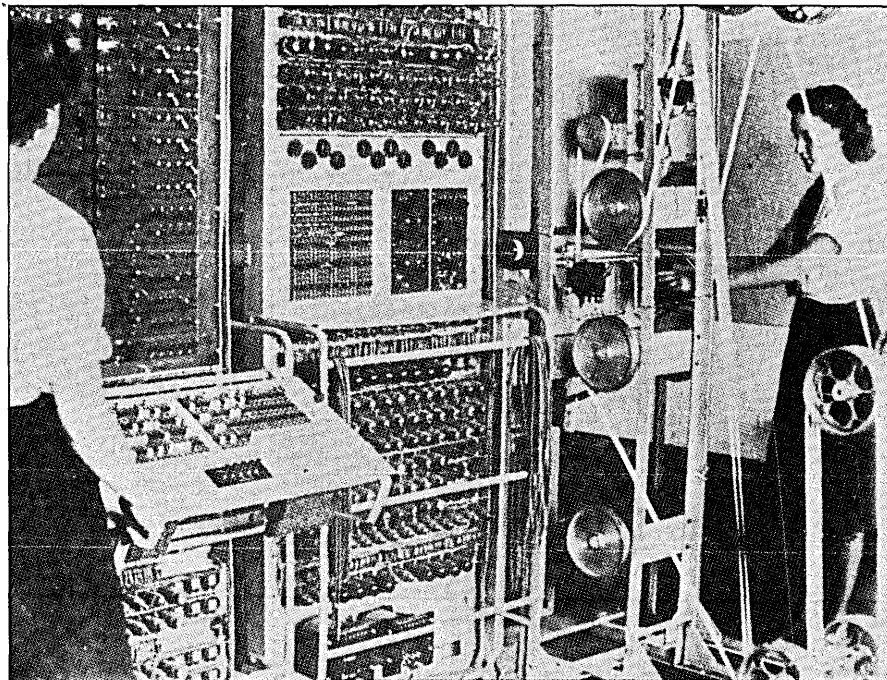

The Colossus cryptanalytic machine at Bletchley Park in 1944. It contained 1,500 electronic valves and used a rapid punched-tape input mechanism.

ALABAMA
 Bessemer
 Birmingham
 Florence
 Huntsville
 Mobile
 Montgomery
 Sheffield
 ALASKA
 Anchorage
 Juneau
 ARKANSAS
 Little Rock
 ARIZONA
 Mesa
 Phoenix
 Scottsdale
 Tempe
 Tucson
 CALIFORNIA
 Alhambra
 Anaheim
 Bakersfield
 Burlingame
 Canoga Park
 Colton
Compton
Concord/Walnut
Covina/Pomona
 Cupertino
 Escondido
 El Monte
 Fresno
 Fullerton
 Garden Grove
 Glendale
 Hayward
 Hollywood
 Huntington Beach
 Inglewood
 Long Beach
 Los Altos
 Los Angeles
 Marina Del Rey
 Modesto
 Mountain View
 Newport Beach
Norwalk
 Oakland
 Oxnard
 Palo Alto
 Pasadena
 Redwood City
 Riverside
 Sacramento
 Salinas
 San Bernardino
 San Carlos
 San Diego
 San Francisco
 San Jose
 San Mateo
 San Pedro
San Rafael
 Santa Ana
 Santa Barbara
 Santa Clara
Santa Cruz
 Santa Monica
Santa Rosa
Stockton
 Sunnyvale
 Torrance
 Woodland Hills
 Woodside
 Ventura
 COLORADO
 Aurora
 Boulder
 Colorado Springs
 Denver
 Lakewood
 CONNECTICUT

Bridgeport
 Danbury
 Greenwich
 Hartford
 Milford
 New Haven
 Stamford
Waterbury
 West Hartford
 DISTRICT OF
 COLUMBIA
 Washington
 DELAWARE
 Wilmington
 FLORIDA
 Clearwater
Daytona Beach
 Ft. Lauderdale
 Jacksonville
 Miami
 Orlando
Pensacola
 St. Petersburg
Sarasota
 Tallahassee
 Tampa
 W. Palm Beach
 GEORGIA
Athens
 Atlanta
Macon
 Savannah
 HAWAII
 Honolulu
 IDAHO
 Boise
 ILLINOIS
 Arlington Heights
 Champaign
 Chicago
 Cicero
 East St. Louis
Joliet
 Oak Park
 Peoria
 Rockford
 Skokie
 Springfield
 Urbana
 INDIANA
Bloomington
 Evansville
 Ft. Wayne
 Gary
 Indianapolis
Kokomo
 Mishawaka
 Osceola
 South Bend
Terre Haute
 IOWA
 Cedar Rapids
 Council Bluffs
Davenport
 Des Moines
Iowa City
 KANSAS
 Kansas City
 Topeka
 Wichita
 KENTUCKY
 Bowling Green
 Frankfort
 Lexington
 Louisville
 LOUISIANA
 Baton Rouge
Lafayette
 Monroe
 New Orleans
 Shreveport
 MAINE
 Augusta

Portland
 MARYLAND
 Annapolis
 Baltimore
 Bethesda
 Dundalk
 Rockville
 Silver Spring
 Towson
 MASSACHUSETTS
 Arlington
 Boston
 Brookline
 Cambridge
 Chicopee
 Holyoke
 Lexington
 Medford
 Newton
 Quincy
 Somerville
 Springfield
 Waltham

Nashua
 Portsmouth
 NEW JERSEY
 Atlantic City
 Bayonne
 Jersey City
 Marlton
 Morristown
 New Brunswick
 Newark
 Passaic
 Paterson
 Princeton
 Trenton
 Union City
 NEW MEXICO
 Albuquerque
 NEW YORK
 Albany
 Binghamton
 Buffalo
 Deer Park
 Hempstead

Norman
 Oklahoma City
 Stillwater
 Tulsa
 OREGON
Eugene
 Portland
 Salem
 PENNSYLVANIA
 Allentown
 Erie
 Harrisburg
 Johnstown
 King of Prussia
 Penn Hills
 Philadelphia
 Pittsburgh
 Scranton
 Upper Darby
 York
 RHODE ISLAND
 Providence
 Warwick

Montpelier
 VIRGINIA
 Alexandria
 Annandale
 Chesapeake
 Fairfax
 Falls Church
 Herndon
 Newport News
 Norfolk
 Portsmouth
 Richmond
Roanoke
 Springfield
 Vienna
 Virginia Beach
 WASHINGTON
 Auburn
 Bellevue
 Longview
 Seattle
 Spokane
 Tacoma
 Wenatchee
 WEST VIRGINIA
 Charleston
Huntington
 WISCONSIN
Eau Claire
Green Bay
 Madison
 Milwaukee
Racine
 WYOMING
 Cheyenne
 OUTSIDE THE U.S.
 Argentina
 Australia
 Austria
 Bahamas
 Bahrain
 Barbados
 Belgium
 Bermuda
 Brazil
 Canada
 Chile
 Colombia
 Denmark
 Dominican Republic
 Finland
 France
 French Antilles
 Germany
 Guam
 Hong Kong
 Hungary
 Ireland
 Israel
 Italy
 Japan
 Korea
 Kuwait
 Luxembourg
 Mexico
 Netherlands
 New Zealand
 Norway
 Philippines
 Portugal
 Puerto Rico
 Qatar
 Saudi Arabia
 Singapore
 South Africa
 Spain
 Sweden
 Switzerland
 Taiwan
 Thailand
 United Arab
 Emirates
 United Kingdom
 Virgin Islands

The biggest just got bigger.

GTE Telenet just boosted its data network accessibility by 20%.

Now, there are GTE Telenet service points in 40 additional locations (they're listed in bold-face type here). And more are on the way.

So now, more of you than ever can use the GTE Telenet network—without WATS lines to reach the nearest service point.

And you know what *that* can save you.

Want to know more? Call toll-free 1-800-835-3638.

Now serving 325 cities and 50 countries.

GTE Telenet 

Worcester
 MICHIGAN
 Ann Arbor
 Battle Creek
 Detroit
 Flint
 Grand Rapids
 Kalamazoo
 Lansing
 Saginaw
Southfield
 Warren
 MINNESOTA
 Duluth
 Minneapolis
 St. Paul
 MISSOURI
 Florissant
Jefferson City
 Kansas City
 St. Louis
Springfield
 MISSISSIPPI
 Jackson
 MONTANA
 Helena
 NEBRASKA
 Lincoln
 Omaha
 NEVADA
 Las Vegas
 Reno
 NEW HAMPSHIRE
 Concord
Manchester

New York
 Poughkeepsie
 Rochester
 Schenectady
 Syracuse
 Troy
 Utica/Rome
 White Plains
 NORTH CAROLINA
 Asheville
 Charlotte
 Davidson
 Durham
Fayetteville
 Greensboro
 High Point
 Raleigh
 Research Tri. Park
 Winston-Salem
 NORTH DAKOTA
 Mandan
 OHIO
 Akron
 Canton
 Cincinnati
 Cleveland
 Columbus
 Dayton
 Euclid
 Kent
 Parma
 Toledo
 Youngstown
 OKLAHOMA
 Bethany

SOUTH CAROLINA
 Charleston
 Columbia
 Greenville
 SOUTH DAKOTA
 Pierre
 TENNESSEE
Bristol
 Chattanooga
 Knoxville
 Memphis
 Nashville
 TEXAS
 Abilene
Amarillo
 Austin
 Corpus Christi
 Dallas
 El Paso
 Fort Worth
 Galveston
 Houston
 Lackland
Longview
Lubbock
Midland/Odessa
 Nederland
 San Angelo
 San Antonio
 Terminal
Waco
 UTAH
 Salt Lake City
 VERMONT
 Burlington

“[Turing’s] retention of a primitive liberalism had the flavor of a utopian thinker.”

scanning. It was Eckert of the ENIAC team who suggested the use of a delay line to store the pulses of an electronic computer. Electronics had to be devised to detect the existence of a degenerated pulse arriving at the end of the line, and to start off a clean pulse. This would have to be combined with the facility to accept pulses from the rest of the computer, and to feed them back. It was advantageous to use a medium other than air for the sound waves, and mercury was already being employed in radar applications.

RECYCLING SOUND WAVES

This was an attractively cheap, existing solution provisionally adopted in the *Draft Report on the EDVAC*. In September 1945 Don Bayley rigged up a cardboard tube eight inches across and 10 feet in length, and Alan designed a superregenerative amplifier (a particularly sensitive form of amplifier). They connected the amplifier to a microphone at one end and a loudspeaker at the other. The idea was to recycle a sound wave in air on the delay line principle, clapping at one end and hoping to set up a hundred artificial echoes thereafter. They did not get it to work before Alan took his NPL post, which began on Oct. 1, 1945. But it meant he arrived full of ideas.

In setting up the new mathematics division, Womersley had been able to recruit from the experts in the field of numerical computation. His division took over the Admiralty Computing Service as the nucleus of what was the most high-powered group in the Western world, the rival being the American National Bureau of Standards. Two other sections, statistics and punched cards, were more remote from the Turing interest, although the existence of punched card machinery on the premises was to decide the input mechanism for his machine. A fourth section consisted of the staff of the differential analyser. The fifth section consisted of Alan Turing alone. By the end of the year there was a staff of 27 in the division. In October the whole new division was housed in Cromer House, where Alan had a little room in the north wing.

Alan lived in a guest house near Hampton Hill and generally continued to live out of a suitcase. The transition from war to peace was marked by the fact that now, instead of being under the administration of military officers, he was under the direction of scientists. This was not as much of a change as he might have expected. Womersley, whom he grimly referred to as “my boss,” had turned out to be the epitome of what Alan most despised as “bogus.” Womersley had won his position on the dubious strength of collaboration with Hartree on a certain numerical method. Womersley’s



A skilled amateur runner, Turing competed in athletic club events. A newspaper story described him as the “electronic” athlete.

lengthy and expensive tour of the U.S. earlier in 1945 had been almost a complete waste of time, since he lacked the expertise to make useful notes on what he had been allowed to see. Flowers and Chandler had been obliged to make a trip of their own in September and October to see the ENIAC in connection with their work in military calculations.

Womersley’s gifts of management—a mastery of name dropping, a genial enthusiasm, and a pleasant office manner to important visitors—were not skills that Turing ranked highly; not just because he lacked them himself, but because he still could not understand why anyone should need weapons other than rational argument. Before long, Turing was openly rude to Womersley in the office, saying “What do you want?” and turning his back if Womersley dared to intrude on some discussion. Conversely, Womersley would show visitors around Cromer House, pointing at the Turing office from afar with exaggerated awe, and saying, “Ah, that’s Turing, we musn’t disturb him.” There was a bet arranged among the staff, which depended on someone coming out of Womersley’s office with “an equation, no matter how trivial”; it was abandoned and conceded “for lack of entries.” Womersley played the role of buffer between Turing and the various authorities involved in computers. He also coined an acronym for the Turing electronic computer, the Automatic Computing Engine, or the ACE. Turing was fond of

saying this was Womersley’s only contribution to the project. But Womersley displayed considerable political skill in getting the project approved. It was not for nothing that he had a copy of *How to Win Friends and Influence People* on his desk.

DESIGN OF UNIVERSAL MACHINE

Turing’s first task was to write a report setting out a detailed design of an electronic universal machine and an account of its operation. He amplified this in a later talk, which explained the origin of the ACE as he perceived it:

Some years ago I was researching on what might now be described as an investigation of the theoretical possibility and limitations of digital computing machines. I considered a type of machine which had a central mechanism and an infinite memory which was contained on an infinite tape. This type of machine appeared to be sufficiently general.

Machines such as the ACE may be regarded as practical versions of this same type of machine. There is at least a very close analogy.

Digital computing engines all have a central mechanism or control and some very extensive form of memory. The memory does not have to be indefinite, but it certainly needs to be very large. One needs some form of memory

programmers

READ THIS...

NOW, I KNOW I CAN MAKE BIG MONEY WRITING AND SELLING MY PROGRAMS. THIS BOOK TOLD ME WHAT TO WRITE — WHO TO SELL IT TO — THOUSANDS OF NAMES, ADDRESSES, IDEAS, GUIDELINES. "SOFTWARE WRITER'S MARKET" IS A FANTASTIC BOOK!



- * WHO TO SELL YOUR PROGRAMS TO
- * THOUSANDS OF COMPANY NAMES AND ADDRESSES, WITH DETAILED LISTINGS SHOWING:
 - (1) WHAT PROGRAMS PUBLISHERS ARE LOOKING FOR
 - (2) HOW THEY WANT YOU TO SUBMIT YOUR PROGRAM
 - (3) HOW MUCH THEY PAY — AND WHEN!
- * 100 CATEGORIES — FROM "ACCOUNTS RECEIVABLE" TO "GAMES" TO "VIDEO CONTROL" PROGRAMS
- * HOW TO WRITE CLEAR DOCUMENTATION
- * DEBUGGING TECHNIQUES

Order Your Copy Today!

Enclose check or money order for \$19.95 (No C.O.D.'s) to:
IPF Publications
146 D Country Club Lane
Pomona, NY 10970
(914) 354-5585

Name

Address

City..... State..... Zip.....

“He had created something quite original. He had invented the art of computer programming.”

with which any required entry can be reached at short notice. This difficulty presumably worried the Egyptians when their books were written on papyrus scrolls. It must have been slow work looking up references in them, and the present arrangement of written matter in books which can be opened at any point is greatly to be preferred. . . . We could even imagine a computing machine that was made to work with a memory based on books. It would be immensely preferable to the single long tape. Let us for the sake of argument suppose that the difficulties involved in using books as memory were overcome, that is to say that mechanical devices for finding the right book and opening it at the right page, etc., etc., had been developed, imitating the use of human hands and eyes. The information contained in the books would still be rather inaccessible because of the time occupied in mechanical motions. One cannot turn a page over very quickly without tearing it, and if one were to do much book transportation, and do it fast, the energy involved would be very great. Thus if we moved one book every millisecond and each were moved 10 meters and weighed 200 grams, and if the kinetic energy were wasted each time, we should consume 10 watts, about half the country's power consumption.

After this flight of fancy, he discussed serious proposals for storage and commented that “the provision of proper storage is the key to the problem of the digital computer.” His priorities were a large, fast memory and a hardware system that would be as simple as possible. Both features were to exploit the universality of the machine. His idea was that anything in the way of refinement or user convenience could be performed by thought and not by machinery, by instructions and not by hardware.

In his philosophy it was almost an extravagance to supply addition and multiplication facilities as hardware, since they could be replaced by instructions working on the primitive logical operations of OR, AND, and NOT. Since these logical operations were incorporated in his plan for the ACE, he could indeed have omitted adders and multipliers, and still have a universal machine. In reality, he did include hardware to perform arithmetical tasks, but he decomposed the arithmetical operations into small pieces so he could economize on hardware at the cost of more stored instructions. The whole conception was puzzling to his contemporaries, to whom a computer was a machine to do sums, and a multiplier the essence of its function. To Turing the multiplier was a rather tiring technicality; the heart lay in

the logical control which took the instructions from the memory.

For similar reasons, his report placed no great emphasis on binary arithmetic. He stated the advantage of the binary representation, namely that electronic switches could naturally represent “1” and “0” by “on” and “off.” But that was all, apart from a terse statement that the input and output of the machine would be in ordinary decimal notation, and that the conversion process would have “virtually no outward and visible form.” The point was that the universality of the machine made it possible to encode numbers in binary form, if that happened to suit the technology. On the universal ACE, no such conversion was required:

This situation is very typical of what happens with the ACE. There are many fussy little details which have to be taken care of, and which, according to normal engineering practice would require special circuits. We are able to deal with these points without modification of the machine itself, by pure paperwork, eventually resulting in feeding in appropriate instructions.

Logical as this was, the fact was that “fussy little details” were more of a headache for other people. Many would see the binary arithmetic of ACE as a weird and wonderful innovation. While Turing was correct in see-

ing this as a detail, it was a good example of his difficulties in communicating with the people who might fund, organize, and build his machine.

MEMORY AND CONTROL

With such details disposed of, he concentrated on two really important things: memory and control. Considering the storage problem, he listed every form of discrete store he had thought of, including film, plugboards, wheels, relays, paper tape, punched cards, magnetic tape, and cerebral cortex, each with an estimate of access time and of the number of digits stored, per pound sterling. The storage could be all on electronic valves, giving access within a microsecond, but this would be prohibitively expensive. In a prescient paragraph of the ACE report he suggested a more home-made approach:

It seems probable that a suitable storage system can be developed without involving any new types of tube, using an ordinary cathode ray tube with tinfoil over the screen as a signal plate. It will be necessary to refurbish up the charge pattern from time to time, as it will tend to become dissipated. Arrangements must also be made to make sure that refurbishing does not get neglected for too long. . . . None of this involves any fundamental difficulty, but no doubt it will take time to develop.

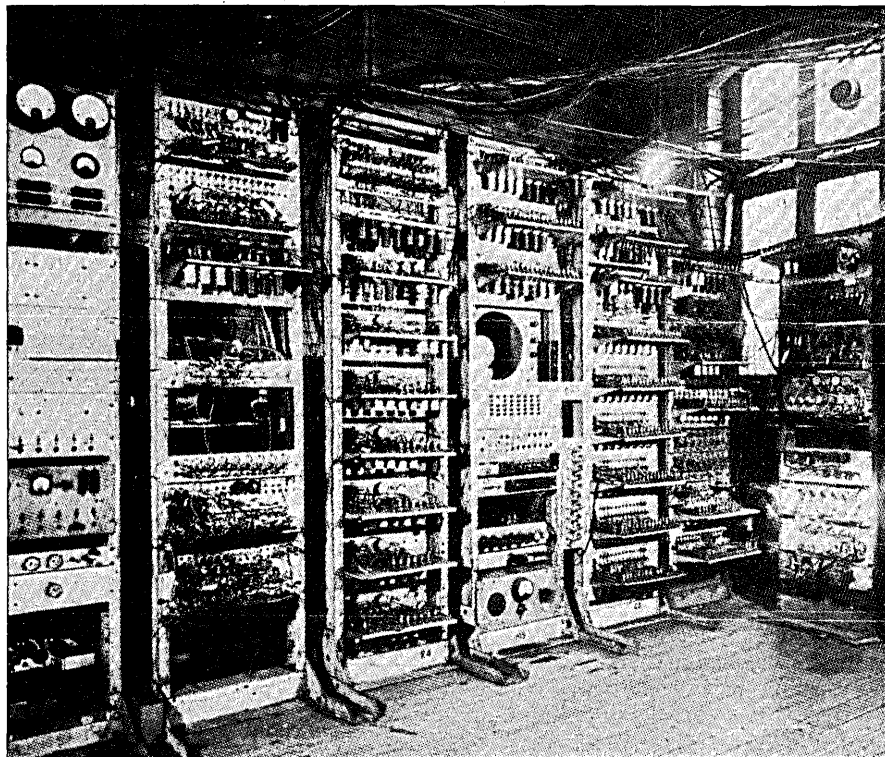

The prototype Manchester computer, ACE's rival, in 1949. It used crts for storage. Turing would eventually join the Manchester team.

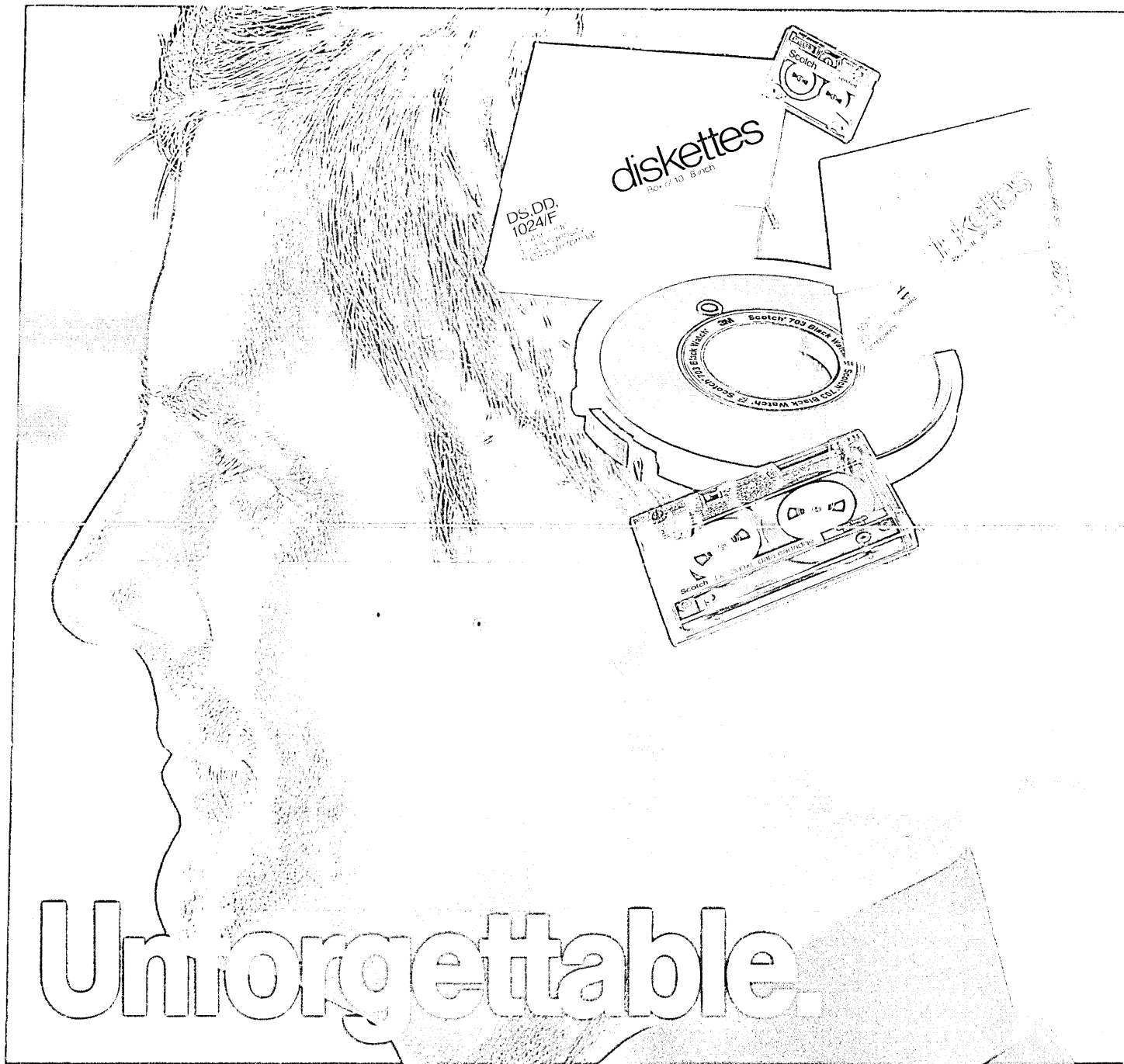

Unforgettable.

If it's worth remembering, it's worth 3M data recording products.

3M computer media products remember everything, every time. Their reputation for reliability is backed up by something very rare in the magnetic media industry: over thirty years of manufacturing experience. That experience, plus the fact that 3M controls the entire manufacturing process, assures that the same high quality is built into every computer media product we make. So you can have complete confidence in every 3M data cartridge, diskette, and roll of computer tape you buy.

Insist on the best for all your DP needs. Insist on information processing products from 3M. Inventor of the data cartridge and the world's largest manufacturer of flexible magnetic media for the home, office and computer room.

Look in the Yellow Pages under computer supplies and parts for the 3M distributor nearest you. In Canada, write 3M Canada, Inc., London, Ontario. If it's worth remembering, it's worth 3M data recording products.

3M hears you...

3M

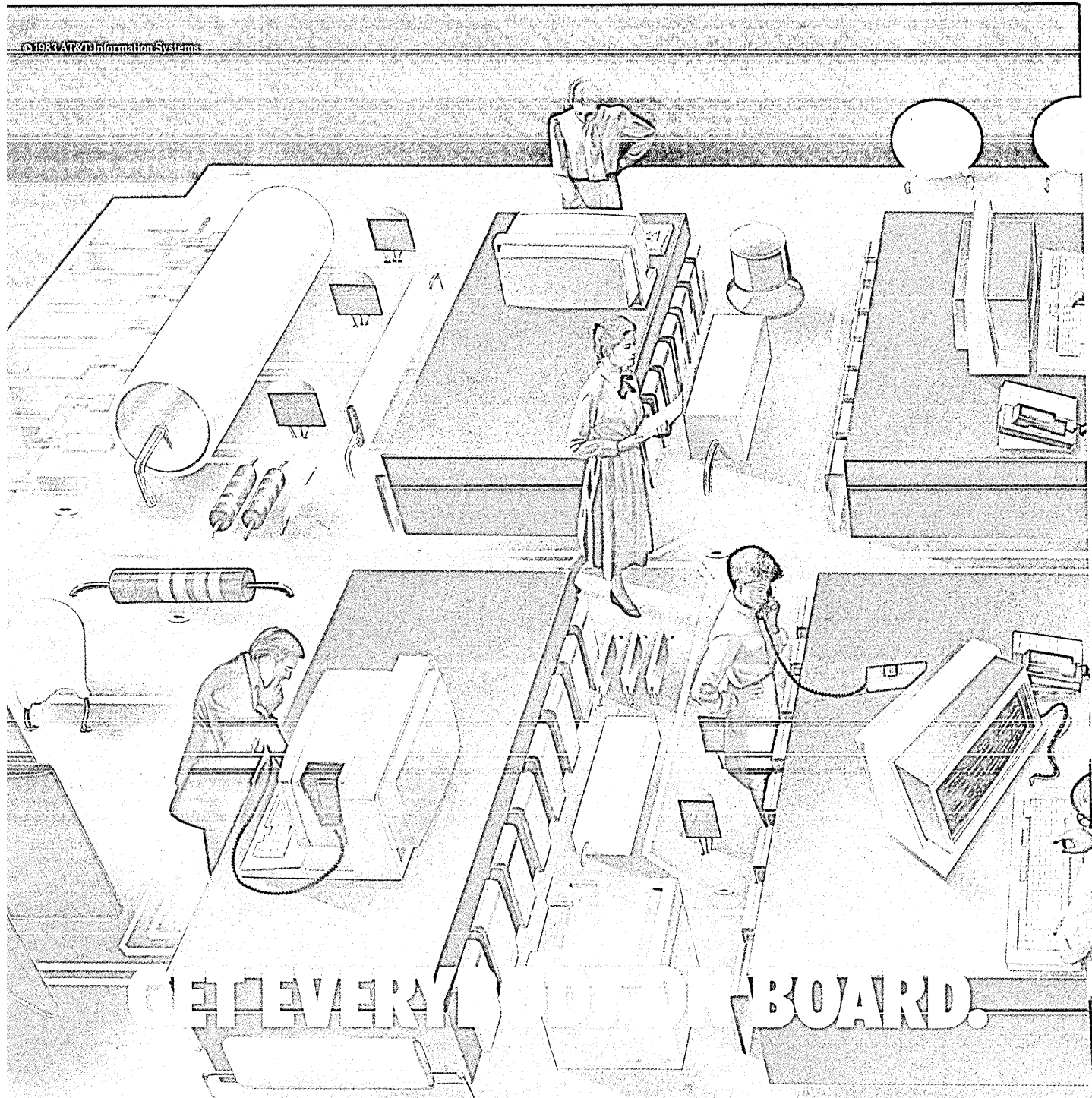

GET EVERYBODY ON BOARD.

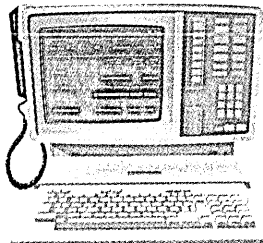

Now there's a way to let everyone in your company chip in.

AT&T Information Systems, whose unparalleled communications heritage has been bringing people together for 100 years, now brings your office together. With state-of-the-art office automation designed to get your company moving ahead.

Electronic Document Communications, now available on System 85 and DIMENSION® PBX, is an easy-to-learn software application that's hard to beat. Because it integrates your office by letting everyone prepare, send and store documents and messages with the speed and efficiency of a computer. So you can have better access to the right information in the right form at the right time.

Electronic Document Communications streamlines your office in three ways:

Preparing Information—Reduces the time, effort, cost and wasted paper between drafts by electronically creating, editing and formatting

documents and messages. "The Composer," a special software feature, enhances document appearance and content by checking spelling, grammar, punctuation and usage. EDC even measures whether documents are readable by technical and non-technical readers.

Moving Information—Speeds documents to many people in different locations simultaneously so they can act decisively. EDC allows you to determine the timing and cost of delivery, and even check to find out when documents were received. Using a password ensures the privacy of your messages.

Managing and Storing Information—Locates documents, and

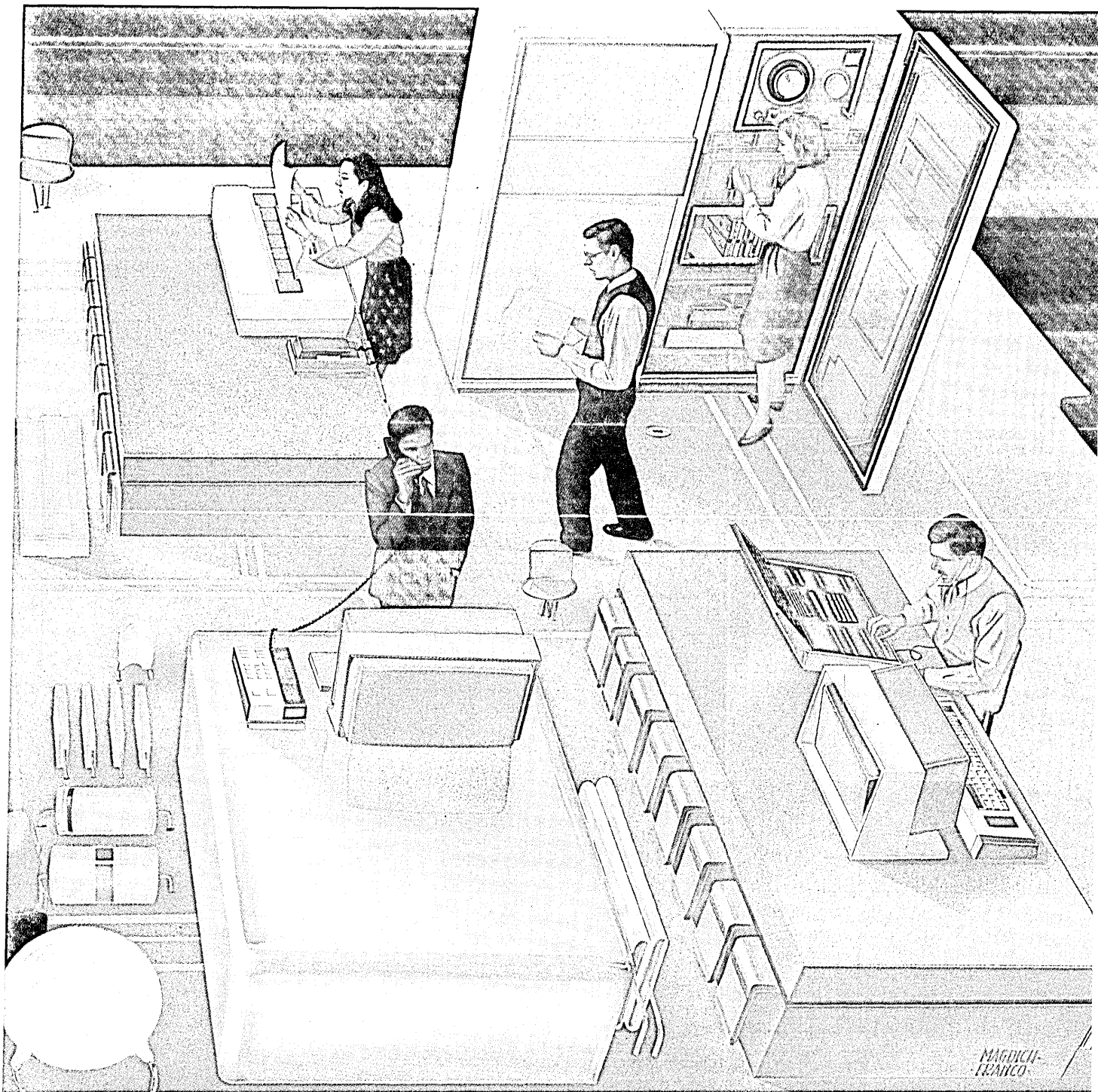

retrieves and evaluates contents quickly and easily with electronic files — while reducing the possibility of losing documents. An electronic “Mailbox” allows you to quickly determine which documents to read first by giving you an overview of “Mailbox” contents. EDC reduces storing and filing costs with an electronic “Archives” that allows for either short- or long-term storage, and the “Wastebasket” which enables you to permanently delete items after a determined period of time. There’s even an electronic “Calendar” that checks personal schedules and arranges mutually convenient meetings.

Not only will all these features help you further integrate your office,

Electronic Document Communications is itself just one part of AT&T’s line of completely integrated business systems. For state-of-the-art office automation, you can implement EDC in conjunction with other applications software like Message Center/Directory, a call coverage and message system. These office management applications are now available on System 85 and DIMENSION® 600 and 2000 systems with the Applications Processor.

The result is you’ll be able to improve staff productivity at every level and get everybody on board. And as new features are developed in the future, they’ll be compatible with your existing equipment.

EDC was developed by systems designers from Bell Labs who now work for AT&T Information Systems Laboratories. AT&T Western Electric produces EDC, and AT&T Information Systems will maintain it with comprehensive, conscientious service from the largest service organization in the industry. To find out more, call toll-free 1-800-247-1212, Ext. 879M.

AT&T’s Electronic Document Communications: It’s part of the integrated office of tomorrow that you can board today.



“Although the NPL had undertaken to construct an automatic computing engine, it did not have a single electronic engineer.”

Lacking such crt storage, he had to plump for the mercury storage lines, because they were already working. They held an obvious advantage, from the point of view of accessibility, of involving a delay. His plan was for a delay line to hold a sequence of 1,024 pulses, so it was like chopping up the tape of the Turing machine into segments each of 1,024 squares in length. It would take an average of 512 units of time to reach a given entry. This, however, was an improvement on the papyrus scroll.

The other important aspect of the machine was logical control, a piece of electronic hardware that would contain two pieces of information: where it was on the tape and what instructions it had read there. The ACE's control would work by a process like that of dialing a telephone. Most of the complexity of the electronic circuits arose from the demands of the tree system. There was also a complexity in the way 32 halfway houses, temporary storage locations consisting of special short delay lines, were provided for the shunting around of pulses. This was different from EDVAC, in which all the arithmetic was done by shunting numbers in and out of a central accumulator. In the ACE design the arithmetical operations were distributed around the 32 temporary storage-delay lines. The point of this complexity lay in increasing the speed of operation. Speed took a slightly higher priority than simplicity. Alan planned the pulse rate of the ACE to be a million a second, straining electronic technology.

ACE had no facility for conditional branching. This was a case where the hardware could be simplified at the cost of more stored instructions. If a simple operation like multiplying floating-point numbers would require a set of instructions, then a procedure of any useful scale would involve putting many such sets of instructions together. He envisaged this as a hierarchy, in which subsidiary tables would serve as a master table.

The concept of a hierarchy of tables brought in further applications of program modification. It would be useless to write a subsidiary table for taking the square root and then assign it to a definite place in the store. It would have to be provided with a dummy address to be replaced by a real one when used, requiring a cross-referencing operation. But this, he wrote, could be done by the ACE writing its own instructions. It is not surprising that he looked forward to the process of writing instruction tables as “very fascinating.” He had created something quite original. He had invented the art of computer programming.

Although he had shifted the emphasis from the building of a machine to the construction of programs, there was nothing nebulous about his engineering plans for the ACE.

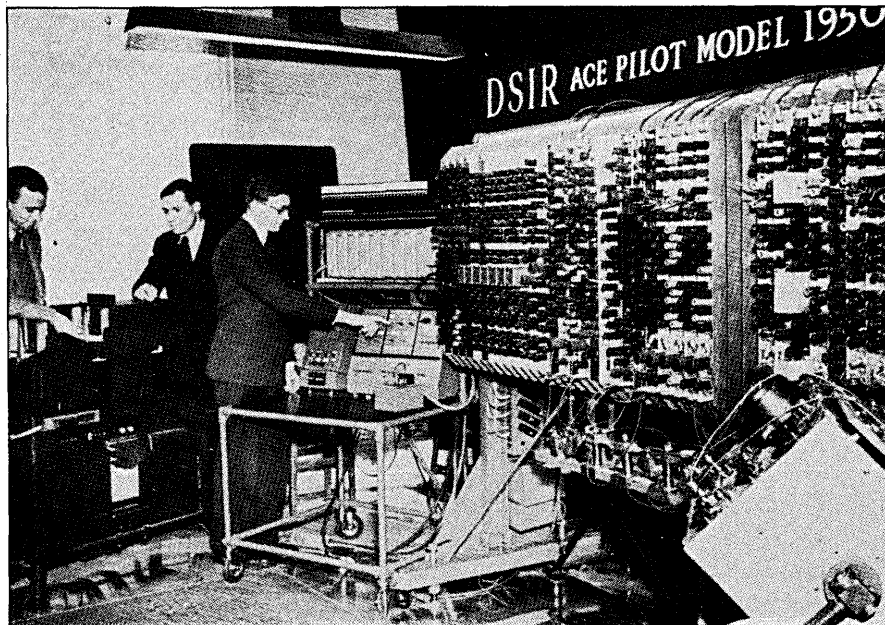

The Pilot ACE computer at the NPL in 1950. Four years before his death, Turing was becoming “an unperson, the Trotsky of the computer revolution.”

The delay lines, he wrote,

have been developed to a degree considerably beyond our requirements in many respects. Designs are available to us, and one such is well suited to mass production. An estimate of £20 per delay line would seem quite high enough.

PLAN FOR DELAY LINES

He did visit the Admiralty Signal Establishment to see T. Gold, who was working on delay lines. His plan was for 200 mercury delay lines, each with a capacity for 1,024 digits. But the figures, dimensions, costs, and the choice of mercury as the medium were not taken off the radar engineer's shelf. He worked out the physics for himself. On the basis of his calculation, mercury was only marginally to be preferred to a mixture of water and alcohol, which he observed would have the same strength as gin. He hankered after using gin, which would come cheaper than mercury. He did not, however, propose doing the development work himself. He wanted this to be done by engineers at the Post Office Research Station. As for the engineering of the logical control and arithmetical circuits (LC and CA), he wrote:

Work on valve element design might occupy four months or more. In view of the fact that some more work needs to be done on schematic circuits, such a delay will be tolerable. In view of the comparatively small number of valves involved, the actual production of LC and CA would not take

long; six months would be a generous estimate.

A great many of the schematic circuits were already planned out in the report.

He also considered the practical requirements of the project as a whole:

It is difficult to make suggestions about buildings owing to the great likelihood of the whole scheme expanding greatly in scope. There have been many possibilities that could helpfully have been incorporated, but which have been omitted owing to the necessity of drawing a line somewhere. In a few years' time, when the machine has proved its worth, we shall certainly want to expand and include these other facilities, or more probably to include better ideas which will have been suggested in the working of the first model. This suggests that whatever size of building is decided on, we should leave room for building on to it.

He proposed a total of 1,400 square feet for the machine and its accessory equipment, and estimated the total capital costs of a machine with 200 delay lines at £11,200. Changes would have to be made, but his plans allowed for that; the main thing was to get started.

His February 1947 talk would expand on how the machine would “prove its worth” by giving

a picture of the operation. Let us begin with some problem brought by a customer. It will first go to the problems preparation section where it is examined to see

More and more, personal computers in large organizations are dramatically improving productivity. But there's also a problem involved with this improvement. People are using many different, often incompatible microcomputers, yet they still need to share information, programs, and peripherals.

It's as if everyone had an automobile, but no highways leading to their destination. No traffic signs to follow. No rules of the road. The result? Mass confusion.

Until now, that is. Until Liaison from SofTech Microsystems.

Based on the p-System,[™] the Universal Operating System,[™] Liaison is a family of network software products that lets you establish a workable, efficient personal computer network. It allows personal computers and users to co-operate and work together so that your organization is altogether more effective.

Liaison includes systems software products, such as

an operating system, print servers and disk servers as well as development tools. And, a collection of network applications, including a database management package, electronic mail, and more.

Liaison lets you unite many different personal computers in an effective network. 8 and 16-bit machines from virtually all personal computer manufacturers (including IBM,[®] TI,[®] Corvus,[®] and Apple[®]) can all share programs, all work together, all co-operate.

So if you're tired of your different personal computers driving you to the brink of insanity, give us a call at SofTech Microsystems.

We'll show you how Liaison can get you back on the road to recovery.

SOFTech
MICROSYSTEMS

SofTech Microsystems, Inc.

16885 West Bernardo Drive • San Diego, CA 92127 • (619) 451-1230

Liaison, p-System, and Universal Operating System are trademarks of SofTech Microsystems, Inc. IBM is a registered trademark of International Business Machines. TI is a registered trademark of Texas Instruments, Inc. Corvus is a registered trademark of Corvus Systems, Inc. Apple is a registered trademark of Apple Computer, Inc.

Introducing Liaison.[™] Software that allows personal computers to co-operate.

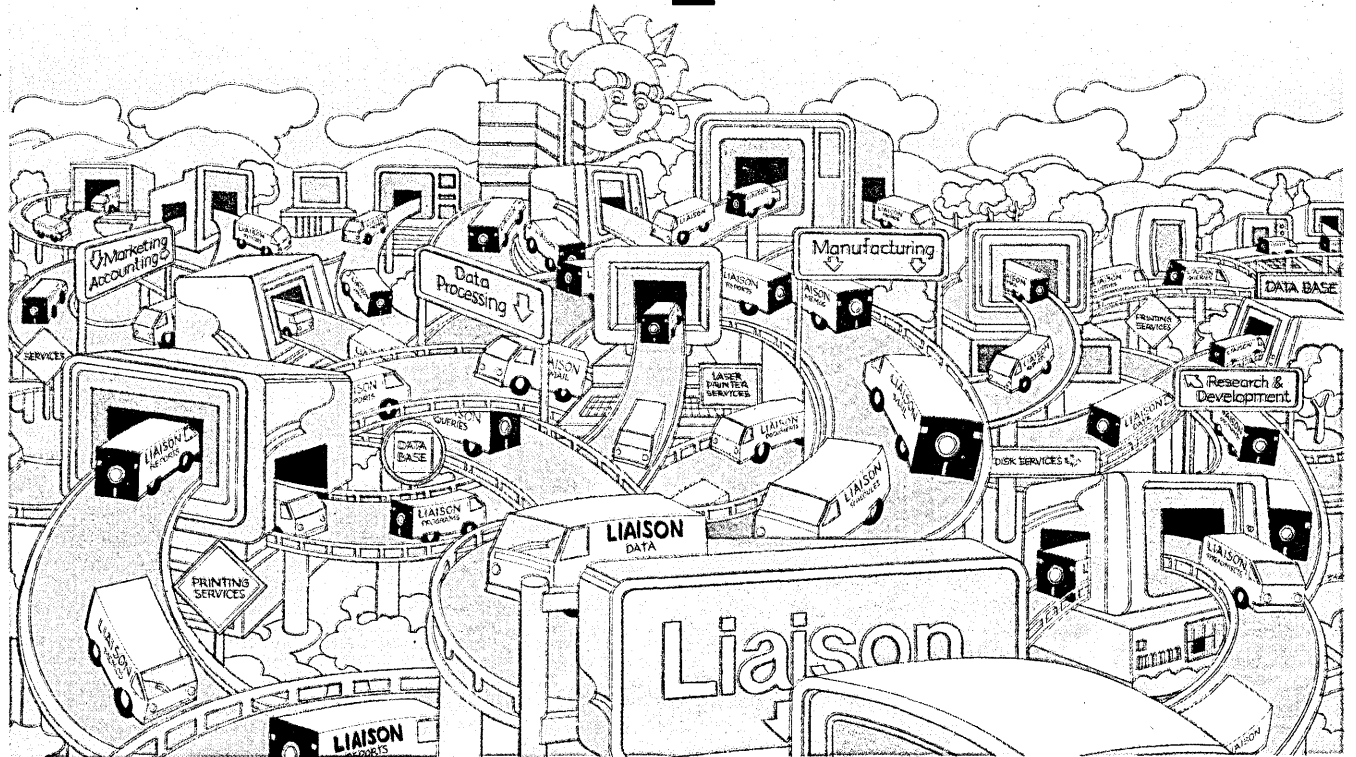

CIRCLE 84 ON READER CARD

One stop shopping for VAX

No other supplier offers such a winning combination of products for VAX computers. Reliable? You bet! MTBF figures for our VAX products range from 40,000 to 85,250 hours. Add to that competitive pricing. And we're second to none in technical support, with third party service available as required.

For disk, tape and communications controllers, the Emulex lineup looks like this:

Disk Products.

FOR THE VAX UNIBUS...

SC12/V—Emulates DEC's RK711 controller combined with multiple RK07 drives on the VAX-11 Unibus.

SC21/V—Emulates DEC RM03 (80 MByte) and RMO5 (300 MByte) storage subsystems. Includes Emulex VMS/VM software driver/diagnostic package.

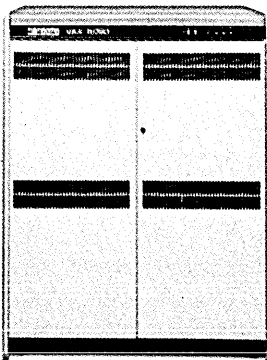

SC31—A low cost solution that allows you to install and operate large capacity disk drives on the Unibus of any VAX. Handles drives with high transfer rates of 1.8 MBytes per second in the 500 MByte range. Gives the same or greater storage capability than DEC Massbus installations at a fraction of the cost.

FOR THE VAX-11/750...

SC750—This software-transparent, single-board controller allows you to add up to four large disk storage units (80 to 675 MBytes) directly to the internal CMI bus. The SC758 lets you add up to eight drives of storage off a single controller.

FOR THE VAX-11/780...

V-Master/780—A mass storage adapter that houses one or two SC780 disk controllers, TC7000 tape controllers

or a combination thereof. Provides an interface and control through the Synchronous Bus Interface (SBI) of your VAX-11/780. Each SC780 disk controller supports up to four disk drives (80 to 675 MBytes). The SC788 is also available to fit in the V-Master/780 chassis and supports up to eight disk drives.

Tape Products.

FOR THE VAX UNIBUS...

TC11/V—Combines with any standard tape drive and the Emulex VMS/UT software driver/diagnostic package to emulate DEC's TM11/TU10 and provide reliable, economical tape storage on all VAX-11s.

TC12/V—Handles every industry-standard "Pertec" formatted half-inch tape transport, including conventional NRZ/PE start/stop and 1600/3200 bpi start/stop streaming tape drives. Provides software transparent emulation of DEC's TS11 subsystem on all VAX-11s.

DEC, VAX, Unibus, Massbus, RM03, RM05, RK711, RK07 and DMF-32 are trademarks of Digital Equipment Corporation.



Users? Emulex, of course!

FOR THE VAX-11/750...

TC7000—A single-board, software transparent controller that interfaces directly to the internal CMI to support 1-4 STC or 1-8 Pertec formatted type drives. Emulates DEC's TM03/TU77 with tape speeds up to 125 ips at 1600/6250 bpi. Supports both "old" and "new" GCR 6250 kinds of drives.

FOR THE VAX-11/780...

TC7000—The same board, with the flip of a switch, fits in the V-Master/780 chassis to provide transparent emulation of DEC's TM03/TU77 through the SBI. Supports 1-4 STC or 1-8 Pertec formatted type drives at tape speeds up to 125 ips; 1600/6250 bpi. Both "old" and "new" GCR 6250 technology is supported.

Communications Products.

FOR UP TO 16 LINES—CS21 SERIES...

CS21/F—Emulates the asynchronous portion of the DMF-32 for use on VAX-11s. Is software transparent with VMS Version 3.0 and above. Handles 16 lines per controller.

Statcon 21—Statistical concentration through the combination of the proven CS21 multiplexer with special microprogramming and the CM22/EX local statistical port concentrator. Handles up to 16 remote lines per statistical concentrator, up to 32 lines per controller.

FOR 16 TO 128 LINES AND MORE—CS11/CS32 SERIES...

CS11/F—Emulates the asynchronous portion of the DMF-32 for use on VAX-11s. Is software and diagnostic transparent, and can handle 16, 32 or 48 lines per controller.

Statcon 11—Combines the proven CS11 multiplexer with special

microprogramming and one or more CM22/EX local statistical port concentrators.

CS32/F—A single-board communications controller that's totally software transparent to DEC's new DMF-32. One CS32 can handle up to 128 lines per controller board.

Statcon 32—Combines the CS32 multiplexer with special microprogramming and the CM22/EX local statistical port concentrator. A single CS32 controller board handles an amazing 256 remote and local lines in this statistical concentration mode.

For more information on Emulex products for VAX, call toll-free: (800) 854-7112. In California: (714) 662-5600. Or write Emulex Corporation, 3545 Harbor Blvd., P.O. Box 6725, Costa Mesa, CA 92626.



The genuine alternative.



CIRCLE 85 ON READER CARD

GSA Contract #: GS00K8401S557

“His whole enterprise was motivated by a fascination with knowledge itself.”

whether it is in a suitable form and self-consistent, and a very rough computing procedure made out.

He perceived the demand for computer programmers:

The main bulk of the work done by these computers will consist of problems which could not have been tackled by hand computing because of the scale of the undertaking. In order to supply the machine with these problems we shall need a great number of mathematicians of ability. These mathematicians will be needed in order to do the preliminary research on the problems, putting them into a form for computation. . . .

Twenty years ahead of his time in his conception of the organization of a computer installation, he had drawn from his cryptanalytical experience at Bletchley. There they had employed 10,000 human operators and worked as a system.

The ACE report was also the first account of the uses to which a universal computer could be put. The ACE was to solve “these problems which can be solved by human clerical labor, working to fixed rules, and without understanding.”

The implication was that the ACE could have taken over all the routine mental work of the war. Here he made what was for him an unusually good political point. In a list of possible applications, “construction of range tables” came first. This was the job for which the ENIAC had been designed. There followed other examples of calculations of practical importance, which currently required months or years of work on desk machines. But the document also reflected his wider view of the nature of the computer; it was not so much a report as a plan. The naive, colloquial style was not calculated to appeal to the authorities, and its detailed considerations went far beyond their absorptive capacities. No one was going to work through the example programs of the circuit diagrams.

The ACE report was completed by the end of 1945. It went to Womersley, who wrote both a memorandum for Darwin and an introductory report for the executive committee meeting of Feb. 19, 1946. Womersley was quick to perceive the opportunities of the universal machine. Whatever his intellectual limitations, he wrote an able defense of what he claimed as “one of the best bargains the Department of Scientific and Industrial Research (DSIR) has ever made.” Discussion was postponed until the meeting of the executive committee on March 16. Alan did his best to explain the ACE as simply as possible. But, explaining excitedly to the committee how the delay line was to work, he rapidly

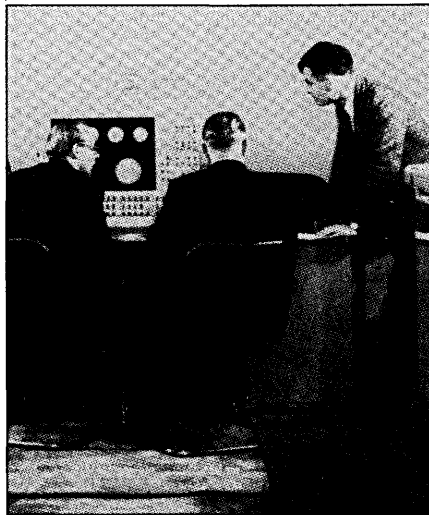

Turing with two engineers at the Mark I's console in Manchester, 1951.

became too technical and was cut off before he even touched on the question of devising tables of instruction. Darwin was therefore skeptical. Hartree came to the rescue with an argument that appealed less to science than to postwar patriotism:

It requires only 2,000 valves as against 18,000 in the ENIAC, and gives a memory capacity of 6,000 numbers compared with 20 numbers of the ENIAC. . . . If the ACE is not developed in this country the U.S. will sweep the field. . . . This country has shown much greater flexibility than the Americans in the use of mathematical hardware. The machine should have every priority over the existing proposal for the construction of a large differential analyser.

Darwin was still not convinced:

The director enquired whether the machine could be used for other purposes if it did not fulfill Dr. Turing's hopes. Dr. Turing replied that this would depend largely on what part of the machine failed to operate, but that in general he felt many purposes could be served by it.

He was probably gritting his teeth at Darwin's failure to grasp the principle of universality. Womersley infiltrated a new concept into the discussion, that of a pilot machine.

A pilot setup could possibly be built for approximately £10,000, and it was generally agreed that no close estimate of the overall cost of the full machine could be made at this stage.

Not much notice was taken of Alan's estimates of capital cost. Womersley had said it should be multiplied by a factor of four or

five. They were probably annoyed that he had trespassed into administrative provinces.

Darwin requested up to £10,000 to be allocated to the small machine. The DSIR agreed to support his application; also, if the small machine fulfilled expectations, they would recommend the expenditure of up to £100,000 on a full-scale machine. Treasury sanctioned the £10,000 but refused further commitment, according to standard procedure. By June 18 the NPL had committed itself by sending a letter to the Post Office asking for development on delay lines. The ACE was under way.

DESIGN CHANGES MADE

Alan continued to improve the design and to write instruction tables for the paper machine. When Jim Wilkinson joined in the ACE design in May, it had reached a Version V, which incorporated a hardware facility for conditional branching. It was replaced by a Version VI and a Version VII. Alan was devoting more attention to speed of operation than he had in the original report. In Version VII enough equipment was added to make it possible for an instruction to have the effect of a complete arithmetical operation.

In Version VII each operation would take 40 microseconds, but it would take another 40 to assemble the next instruction in the control circuits. Alan wished to eliminate this by duplicating part of the equipment so each instruction could be assembled while the last was being performed.

As experience was gained with writing instruction tables, the hardware needed modification. All the same, the assembling of components could not begin too soon for him. In this respect, development was far from speedy. There was an overwhelming problem with ACE. Although the NPL had undertaken to construct an automatic computing engine, it did not have a single electronic engineer. In December 1944 Womersley had told the executive committee that plans for new machines could “be put into effect only by cooperation between the division and certain industrial organizations.” But no progress had been made in making this possible. There was one solid possibility, that of having [the private firm] English Electric manufacture a machine to commercial standards. Its director had attended the March meetings. But it was not clear who was to do the immediate development work.

A further problem lay in the internal structure of the NPL. At Hanslope, Alan had worked with Don Bayley, putting their different kinds of skill together. But the National Physical Laboratory did not encourage such ad hoc collaboration. Alan was cast firmly in the role of theoretical designer and was not

Management may never know the power of this envelope.



Unless you tell them.

You don't have to tell management how easy it is to implement E-COM® service. That can be your secret. Tell them instead about the power of an E-COM service mailing. How letters can be sent right from the company computer. How the Postal Service prints, folds, inserts, seals and delivers these letters for you. How the distinctive blue envelopes of E-COM service lend visibility and impact to your mailing.

Since you're the one who gets E-COM service up and running, you have three options—all of them easy. First, you can write the system interface yourself.

It takes about a day, and Postal Service consultants are standing by to give you any help you need. Second, you can buy a dedicated interface from a third-party vendor. Third, you can access E-COM service through an independent communications carrier, without bringing the system in-house at all.

As part of the D.P. department, you're in a unique position to tell your management about the power of E-COM service. So find out more. Call your local Postmaster. You may never again get so much credit for so little work.

E-COM® 

“After 11 years there was still nothing but paper plans, a paper machine, and paper programs.”

expected to know about practical engineering. The bureaucratic outlook of the NPL also showed in the form filling and permission seeking necessary for the requisition of equipment. There was no immediate prospect of having engineers qualified to build the circuits, and there was every obstacle put in Turing's way if he tried to conduct practical experiments himself.

Alan had written in his report about the possibility of using crts as a different kind of storage system. It was probably at his prompting that on May 8, 1946, Womersley wrote an inquiry about the state of research at the radar establishment in the use of such tubes. On Aug. 13 Darwin wrote to Sir Edward Appleton at the DSIR:

As to what comes next, Womersley has got to use some tact in exploring how we stand with the Post Office, who have started to give some help, which would be very good but that they are not in a position to plunge very deep. It will also be necessary to square officially over priorities, and on this I should like to bring high power to bear if necessary, because we have got a splendid chance of jumping ahead of America.

Alan remained unaffected by American developments, and they by him. In growth, as in conception, they were independent. Hartree had made a visit to ENIAC in the summer of 1946, being allowed to use it himself, and took with him a copy of the ACE report and a third version of the ACE design. But its programming ideas made no impression on the Americans.

The official NPL press release on Nov. 6, 1946 set the origin of the ACE in Turing's "severely mathematical paper" of 1936, and explained how electronic switching provided the speed to make such a machine practical. It explained the superiority of the ACE over the ENIAC. But the cost had now risen from £100,000 to £125,000, and it was stated that "it will be two or three years before the completion of this machine can be hoped for, since its construction presents formidable problems."

On Oct. 22, when Hartree enquired about progress on the ACE, Darwin had to confess that "Post Office assistance had not been as great as was expected."

On Dec. 2, Maurice Wilkes wrote:

Dear Womersley,
I have been thinking over in more detail the

subject we were discussing last Wednesday. . . . I am quite convinced that the construction of a pilot model of some sort is an essential step in designing ACE. I do not see how else one can test out such things as control circuits. I am attaching a note I have written on the design of the pilot model.

EDVAC: CHALLENGE TO ACE

The attached note outlined the specification of a computer on the EDVAC model, entirely different from the ACE. Not only did it employ a central accumulator, it ran counter to the Turing philosophy of keeping the hardware simple. Wilkes wrote apparently in ignorance of the fact that the NPL already had Version VII of a detail design, for which six months' work had been put into writing programs. To contemplate Wilkes' proposal, as Womersley apparently did, was to undermine his own division's work. On Dec. 10 he passed the proposal to Turing, whose reaction was understandably brusque:

Mr. Womersley,
I have read Wilkes' proposal for a pilot machine, and agree with him as regards

1983

A little perspiration now

Your job: Improve a manufacturer's performance, productivity, and profits. Do it by providing management with the timely information needed to plan,

monitor, and control all aspects of the manufacturing process with precision.

Simple?

Not too.

Manufacturing is not simple.

Neither are the problems manufacturers face. Expect to solve those problems with less than the best manufacturing software and you may make a costly mistake.

the desirability of some such machine somewhere. I also agree with him as regards the suitability of the number of delay lines he suggests. The code which he suggests is however very contrary to the line of development here, and much more in the American tradition of solving one's difficulties by means of much equipment rather than by thought. . . . It might be argued that if one is to have so little memory then it is necessary to have a complex control to make up. . . . I favor a model with a control of negligible size which can later be expanded if desired.

But Womersley wrote back to Wilkes on Dec. 19:

Dear Wilkes,
Thanks for your suggestions regarding the pilot model for the ACE. They don't quite agree with Turing's ideas of what a minimal machine should be. In his opinion the control part of it is too elaborate though he agrees about the amount of memory.

The administrators wanted to keep exposure of Turing to the outside world to a minimum. There had already been enough embarrassment in the newspapers [from Tur-

ing's grand claims of electronic brains]. Womersley suggested to Darwin that Turing "should conserve his time by giving a course of lectures intended primarily for those who will be concerned with the technical development of the machine." According to an NPL memorandum, there was to be ample time after Turing's exposition for "Discussion—in particular, criticism of Dr. Turing's technical proposals." They did not trust him to know what he was talking about. Criticism was inevitable; by this time several of those who attended had ideas of their own, and no inclination to be fitted into the Turing plans. Wilkes wrote that he

found Turing very opinionated and considered that his ideas were widely at variance with what the mainstream of computer development was going to be. I may have gone to his second lecture, but I certainly went to no more.

On the other hand, lectures on elementary electronics did not go down well with those who could see for themselves how the ACE design was built around the delay line storage.

The plans had been delayed again when Alan gave a talk on Feb. 20, 1947 to the

London Mathematical Society. He elaborated in detail the imagined operation of the ACE and spoke as if its realization were almost a formality: before long the terminals would be humming with activity, and programmers would be busy converting the nation's problems into logical instructions.

His talk dwelt rather more on the dream behind the practicalities of an installation. His discussion opened with the picture of "masters" and "servants" who would attend the ACE. The masters would attend to its logical programming, and the servants to its physical operation. "As time goes on the calculator itself will take over the functions both of masters and of servants. The servants will be replaced by mechanical and electrical limbs and sense organs." But the novelty lay in suggesting that:

As soon as any technique becomes at all stereotyped it becomes possible to devise a system of instruction tables which will enable the electronic computer to do it for itself. It may happen however that the masters will refuse to do this. They may be unwilling to let their jobs be stolen from them in this way. In that case they would surround the whole of their work

1984

1985

1986

can save a lot of tears later.

You've got a tough job. And tough jobs demand more than quick fixes.

Put a little sweat into implementing AMAPS now. It will pay back

your efforts for years to come.

From AMAPS you get what you need now and what you'll want later.

Simple?
Very.

For more information, call Lyn Frownfelter at 1-800-328-2030.

There's a Comserv office near you.

comserv
CORPORATION

CIRCLE 87 ON READER CARD

“The 1958 ACE was a tardy anachronism. . . . This was not Alan Turing’s dream.”

with mystery and make excuses, couched in well-chosen gibberish, whenever any dangerous suggestions were made.

By speaking of mind in terms of puzzle-solving intelligence, Turing superficially epitomized the technocratic outlook of 1947 social management. He had put examples of the usefulness of the computer in his report, to get it paid for. His whole enterprise was still motivated by a fascination with knowledge itself, in this case an understanding of the magic of the human mind. His interest in ACE had little to do with the “mechanization, rationalization, modernization” that Orwell foresaw. Rather, it was much closer to an undiminished wonder at the “glory and beauty of Nature,” and an almost erotic longing to encompass it.

Despite all he had done in the war, and all the struggles with stupidity, he still did not think of intellectuals as forming a superior class. The intelligent machine, taking over the role of the masters, would be a development that would cut the intellectual expert down to size. The jealousy displayed by human experts only delighted him. In this he was an antitechnocrat, subversively diminishing the authority of the new priests and magicians of the world.

In the spring of 1947, while Darwin applied the higher realms of his thought to solving the problem of Alan Turing, incoherent initiatives were taken by more impatient people. One of these was Harry Huskey, who was eager to see a computer begun before his sabbatical year was out. He admired the general line of the ACE design but believed the best plan would be to construct a small delay line machine “on a plan which is a compromise between the NPL and the Moore School plans.” Relations between Alan and Huskey had been cool from the start, but they deteriorated when Alan found him writing a program headed Version H. This was an adaptation by Huskey of the Version V of the ACE, trimmed to include only the minimum of apparatus required for the solution of eight simultaneous equations. Though generally consistent with the ACE design philosophy, such a departure subverted Alan’s control. He had tolerated a pilot project on the understanding it would not detract from the full machine. If Huskey’s project failed, it would be a waste of time. If it succeeded, it would lead to a marked change of plan. Naturally, Turing boycotted the development. Somehow Harry Huskey scraped together enough equipment to make a start.

At the same time, Alan managed a few experiments of his own in the cellar of the mathematics division building. He had devised circuits to transmit and receive pulses along a delay line, and a system to probe the

circuit so as to examine the shape of the pulse on an oscilloscope. The NPL had nothing in the way of a machine to do this elementary engineering task, so he made one for himself. The whole thing involved mounting four or five valves on a breadboard. He had no delay line to work with. Coming back from lunch, he spotted a drainpipe lying in the long grass, and had someone help him carry it back to try it out as an air delay line. Don Bayley and Jumbo Lee came and saw this “dog’s breakfast” of an outfit in March or April 1947. Alan took Don for a walk and complained bitterly how he had been thwarted. Alastair Watson heard Alan complain that “they say I don’t understand magnetism.” Francis Price heard his comments on how the administration denied him the most standard pieces of equipment for experiment.

PROTOTYPE TO BE BUILT

It would not be possible now to farm out the ACE to other organizations. There would be no single national computer, as expected in 1946, but various installations of which the NPL would have only one. The new plan was for a prototype to be constructed at NPL, whereupon it would go to English Electric.

In the summer of 1947 some enormous cathode ray tubes were imported from Germany. These were intended for use as digital displays. The staff from the ACE section dutifully went and stared at these, but with some amazement for they were completely irrelevant to the computer plans.

It was a curious sequence of events, in which the NPL administration had done everything possible to avoid “building a brain.” They contemplated handing the construction to Wilkes, when he had only “a mechanic and a boy” and incompatible design principles. They brought Huskey from America for his experience on the “apparatus side,” and then failed to use it. Finally, they appointed as the head of an electronics section a man without motivation or competence for the job at hand. The one person they had not trusted was Alan Turing. The one policy they had not adopted was that of finding or training engineers to effect the proposals to which they had agreed in 1946.

After this happened, Alan withdrew. The programming work continued, and they went a long way with subroutines for floating-point arithmetic. But Turing had lost interest in this work, although he spent time on what he called abbreviated code instructions. These took up the ideas announced in his original report of having the computer expand its own programs. They made, in effect, a high-level language for the computer, long before such things were developed elsewhere. But he was thinking about making a

computer show intelligence. In this respect there was nothing to be gained by working at the NPL. He arranged to have a sabbatical year, as the scientific civil service allowed, to spend at King’s. By normal standards it was rather soon for sabbatical. But perhaps they were not sorry to have him out of the way.

The fact was that after 11 years there was still nothing but paper plans, a paper machine, and paper programs, abstruse and insubstantial.

Womersley managed to rewrite the history of the ACE project after Alan had left. It was Womersley’s story that Colebrook gave to the executive committee on Nov. 13, 1949:

Mr. Colebrook referred to the organizational history of the Automatic Computing Engine project. The work originated with Dr. Turing’s paper *On Computable Numbers . . .* and Mr. Womersley began thinking about the logical design in 1938 after reading Dr. Turing’s paper and after discussions with Professor Hartree. Mr. Womersley came to the Laboratory early in 1944, and the following year visited the U.S. to see the Harvard and ENIAC machines. . . . Dr. Turing very soon afterwards joined the staff of the Laboratory.

This was the only mention of Alan’s part in the project. The account continued:

In 1946, work on the Automatic Computing Engine was started and it was arranged for experimental work to be done by the Post Office and the theoretical work, including the programming of the machine, at the Laboratory. Because of slow progress at the Post Office, a section was started at NPL in 1947 to build the ACE machine. . . . The actual size of the ACE as originally contemplated was the outcome of long consideration by Mr. Womersley and Professor von Neumann during Mr. Womersley’s visit to the U.S.

Already by 1950, Alan Turing was an unperson, the Trotsky of the computer revolution.

Instead of following the policy adopted in 1946, the Pilot ACE [as the revised version came to be called] was used as a working computer, and was duplicated as a commercial version, DEUCE, by English Electric. It may now be seen in the Science Museum in London. It went there in 1958 when it was superseded at the NPL by a larger machine called ACE. At the opening day, the then superintendent of the appropriate NPL division declared: “Today, Turing’s dream has come true.” But the 1958 ACE was a tardy anachronism: it retained mercury delay lines in the age of magnetic core store and vacuum tubes in the era of the transistor. This was not Alan Turing’s dream. *

SCAN/370—The system that automatically simulates the execution of every cleanly compiled COBOL program. SCAN/370 gives you critical analysis information that reveals how each program will execute at run time—information not obtainable via cross referencers, flowcharters, or other analysis tools.

SCAN/370

SCAN/370 is a comprehensive COBOL enhancement system designed to speed the development and maintenance of COBOL programs and improve their operational reliability.

MAINTENANCE AND DEVELOPMENT PRODUCTIVITY: Isolates problem areas in COBOL programs—before testing. Simplifies resolution of compiler diagnostics. Removes the drudgery from new program development. Reduces the time required to analyze COBOL programs.

PROGRAM RELIABILITY: Detects and flags latent bugs in production programs—before they happen. Highlights maintenance booby-traps.

DYNAMIC PROGRAM DOCUMENTATION: Generates concise and accurate program level documentation. Recreates documentation automatically with every clean compilation.

QUALITY ASSURANCE: Graphically distinguishes well structured code versus poorly structured code. Detects and flags COBOL keywords that do not conform to user defined restrictions. EDP AUDITING: Documents the differences between two versions of the same COBOL program.

SYSTEM RESOURCE SAVINGS: Saves millions of lines of computer output every single month. Reduces the load on your teleprocessing network.

OPERATING ENVIRONMENT: IBM 360/370 and compatible systems.

GROUP OPERATIONS, INCORPORATED
1110 Vermont Ave., N.W. Washington, D.C. 20005 (202) 887-5420
Offices in: Boston, Chicago, Cleveland, Columbia, S.C.,
Dallas, Los Angeles and New York.

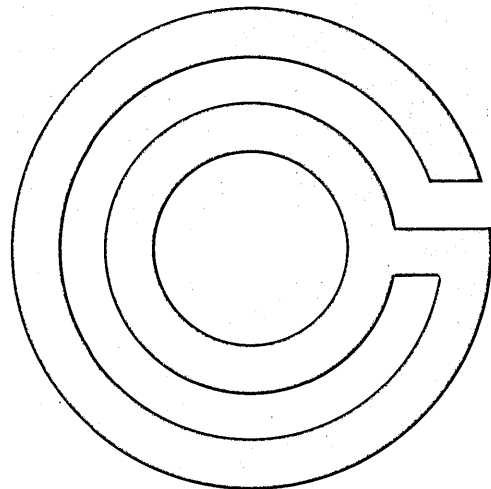

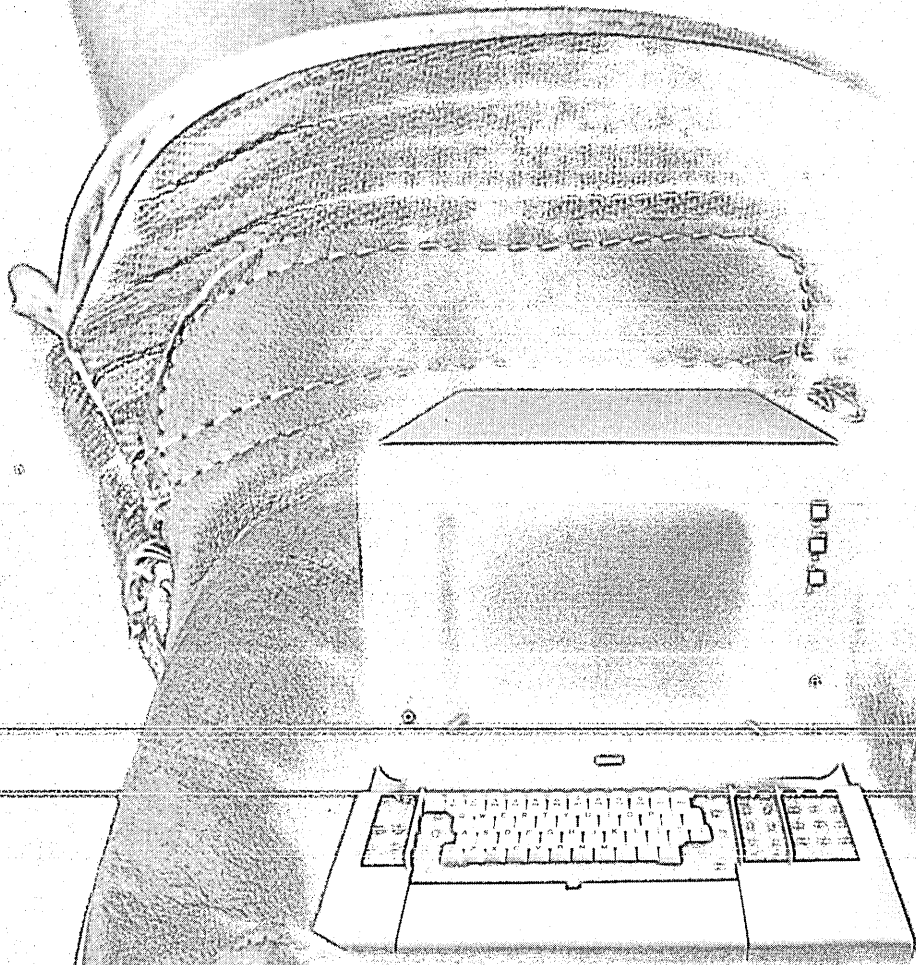

At last, manufacturing and business systems that work together. Only from MSA.

MSA introduces the Extended Closed Loop™ Manufacturing System—a new systems concept we've been working towards for more than 12 years.

Put simply, we've taken the classical Closed Loop model of integrated business functions and provided the integrated systems to make it work.

At MSA, we're committed to nothing less than the *total integration of business and manufacturing systems* to support the overall business plan.

In short, our goal is to provide the systems that can help make your company's business plan a manufacturing reality.

The Extended Closed Loop concept is vitally important for anyone using or choosing application software anytime in the next five years.

And it's even more important if you're looking at manufacturing systems *now*. Here's why.

Only MSA has all the components

As the world's largest independent application software supplier, MSA—and only MSA—currently offers the components needed to implement the Extended Closed Loop System.

The Bill of Materials chart below shows how all of MSA's software products and service components work together to create the Extended Closed Loop System.

It starts with MRP II

The MSA Manufacturing System consists of a complete line of integrated MRP II modules, including: Manufacturing Standards, Historical Forecasting,

Inventory Record Control, Master Production Scheduling, Material Requirements Planning, Capacity Requirements Planning, Shop Floor Control, Procurement Management and Cost Management.

These components, together with MSA's structured implementation methodology, are designed for *successful* Closed Loop MRP II.

So, if your immediate need is manufacturing software, you can choose the MSA Manufacturing System now, and easily add other Extended Closed Loop components as you need them.

Extending the Closed Loop: The Business Connection

At MSA, we offer the integrated business systems to make Extended Closed Loop manufacturing a practical reality.

For 12 years we've developed integrated systems with common architecture, including: Payroll and Labor Distribution, General Ledger, Accounts Payable, Budgeting and Planning, Fixed Assets Accounting, Accounts Receivable, Personnel Management and Currency Management.

And with more than 7400 systems installed worldwide, we offer something else that's unique: We call it 'inter-application expertise'. It's the understanding we've gained by integrating MSA applications to meet our customers' requirements.

Our people know the manufacturing industry (more than 1300 manufacturers use MSA systems around the world).

Our implementation techniques are thorough, practical, and field-proven

many times over. We'll show you how to reduce overall implementation costs significantly.

We offer the most extensive customer training program in the industry (this year alone, MSA will conduct more than 100,000 student-hours of customer training).

At MSA, we provide the total software support to keep your systems up-to-date.

Not if, but when

In order to survive, your company must not only reach its goals of efficiency and increased productivity; it *must* remain profitable. And continued profitability can only be achieved with improved decision support information—the kind provided by total systems integration.

Industry experts consistently name MSA as the leader in systems integration.

And providing total systems integration is what the MSA Extended Closed Loop Manufacturing System is all about.

Send for free literature

We've prepared a brochure that further explains the MSA Extended Closed Loop™ System.

For your free copy, call Robert Carpenter at (404) 239-2000. Or clip this coupon.

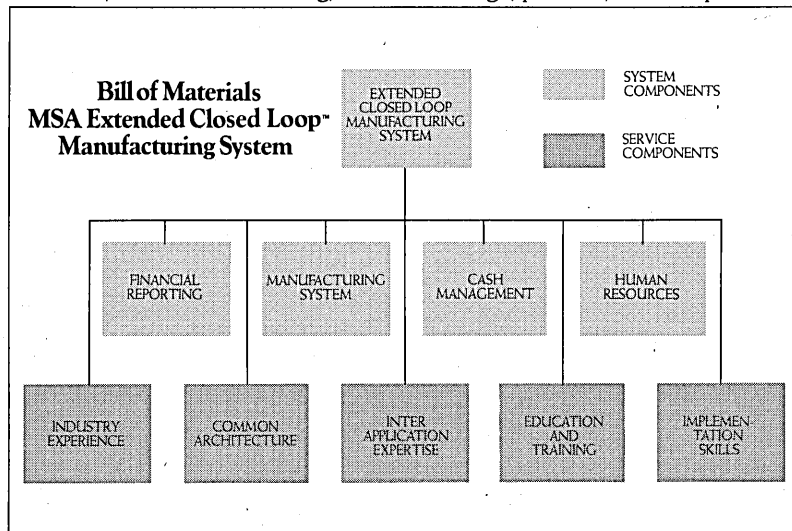

FREE personal computer...



...with your qualifying purchase of MSA mainframe software and Executive Peachpak II™, the hot new technology that links your personal computers to the mainframe—so executives can get their own information.

For details on how to get your free personal computer contact Robert Carpenter today at (404) 239-2000. Or write "Free Computer Offer," Management Science America, Inc., 3445 Peachtree Road, N.E., Atlanta, Georgia 30326.

This offer expires December 31, 1983, so act today.

MSA

The Software Company

For systems people, there is no clear path to the Land of Oz. Most dpers have to create their own Yellow Brick Roads.

DP CAREER PATHS

by Kate M. Kaiser

According to many dp people, the phrase "career paths of systems professionals" is an oxymoron: a figure of speech combining contradictory ideas, like jumbo shrimp, football scholarship, and business ethics. Why? Because people who work as senior systems analysts or as project leaders have few possibilities for hierarchical advancement, and any available paths are often blocked. Many firms have no formalized structure in the MIS department, partly because the field is still relatively new. Because evaluating technical expertise is difficult, the human resource function in most firms must turn the usual recruiting, screening, and developing roles over to the MIS director. Since many MIS directors come from such a technical orientation, their management style might be more "seat of the pants" than that of some of their counterparts in marketing or finance.

The career path model used by most firms is a variation of entry level programmer to analyst to project leader to manager. Sometimes, the adjectives junior and senior are used, along with combinations of the above three titles, linked by slashes. A typical organization design is shown in Fig. 3. A more progressive approach is displayed by firms that separate the technical and application functions in parallel tracks with equivalent stature. The bind for most individuals is that they attain the level of senior systems analyst in four to 10 years, often because of turnover and demand rather than ability. Individuals who want a continuing challenge see few formal routes that provide motivation. The MIS director is faced with a similar dilemma, since it is almost impossible to move from MIS to top management. As firms recognize the information resource's value, this may change, but it certainly hasn't happened yet. Conversations with dp personnel about career paths are flavored with the words dead end, stopped up, and isolated.

Long-term data concerning systems staff are scant except for government statistics collected by the Bureau of the Census and the Department of Labor (DOL). These data do not track individuals except by chance on

the DOL annual sample of job mobility, which started in 1981.

Beginning in 1979, the author collected data over a four-year period on the jobs of systems and user staff who were involved in major development projects in large private firms. Of the 108 participants in 1979, 65 people reported to a systems department and 43 to a user area. Users were included for three reasons: to compare employment differences, to collect user perceptions of systems career paths, and to see if users crossed over to systems. Twenty participants who were users when the survey was begun and who intended to remain users until 1988 were not included for further study. By 1983, two of the original 108 were deceased, four had retired, 15 had no known whereabouts, seven were contacted but did not respond, and one had left the work force to raise a family, making a total of 59 respondents. Between 1982 and 1983, professionals from 35 firms were contacted by telephone and given the choice of a personal interview by phone or a mail questionnaire with phone follow-up. Ten chose the questionnaire. The interview was held within 10 days of contact. Updates on the early interviews were obtained in 1983. The questions focused on updating the respondent's employment history over the past four years and on his or her professional aspirations for 1988.

The survey offers information on 36 firms (20 in manufacturing, nine in the financial area, three service firms, and four utilities). All of the firms are among the Fortune 500 or the top 50 within their fields. Many are located in the Midwest, where the recession has had an obvious impact. It was assumed that these large firms would offer more sophisticated career possibilities to MIS staff because of their potential resource level, compared to that of smaller firms. In 1979, the number of firms that respondents worked at was 27; in 1983, the number rose to 35 after eight people left their original employers. Only two participants had been with three firms during that four-year period. None of the companies are in the dp area.

Demographic data about the final 59 participants are contained in Fig. 2. In draw-

ing a composite of the nine women and 50 men, we see a mature dp professional who spent a significant amount of time with a firm after working for one or two other organizations. There are exceptions among the real-life respondents, however: two individuals who are very close to retirement spent their entire work lives with one firm. Four of the highest salary figures belong to users now in top management positions. These users were included because they were part of a development team in 1979, and two have MIS reporting to them now or will in their next positions. Two of the other respondents are in the top MIS in their divisions and have been there since 1979. The salary levels of the other 53 respondents suggest that they hold senior systems analyst or middle management data processing positions. Such high-level positions may be a result of their tenure in dp. Twenty of the respondents spent their entire work lives in data processing, with an average of 16.75 years. The grandfather of this group (by virtue of his seniority and his two grandchildren) started on tab equipment.

Included in the survey are some of the early systems professionals. The observations of such a vanguard group are valuable, because these trailblazers are now managing and working with younger systems professionals who have had the opportunity to get formal MIS training. Degrees in computer science did not become available until the early '70s, and MIS degree programs were devised even later.

STUDY GROUP IS STABLE

As for turnover, our study group is a surprisingly stable set. Fifteen have stayed with their original firms for an average of 19 years. Most have been with their firms 12 years. This evidence supports popular notions that turnover is related to age. One user who worked at five firms is due to retire in five years and has been with his present company for 15 years. The systems person who was with eight firms has been with his current employer 18 years. In general, these people have been at their present organizations for two thirds of their work lives, a fact that explains why 64% of

ILLUSTRATION BY BERNARD BONHOMME



them responded that they are organization loyal.

In 1983, 25% report to a user department and 75% report to a systems area. These percentages may not be precise, because some user departments have a resident systems analyst. Also, some true users intend to stay in systems only long enough to acquire technical skills and then return to their functional areas. Nine such "users" were included as a control group.

Eighty percent of the respondents are in supervisory roles and can be grouped as generic senior systems analysts/project leaders because of their functions. Three systems professionals are closer to programmer/analysts. One of these three who worked full-time in 1979 went part-time four years ago following maternity leave.

Formal training is varied. Because of the maturity of the sample there are only six who have bachelor's degrees in computer science. Since so few had the opportunity to pursue a degree in their field, why did they consider a dp career? Most couldn't have said, "I want to grow up to be a systems analyst," because the field didn't exist when they were first considering their career goals. Some sought formal training, some experienced on-the-job motivation, and some had "deliberate accidents."

Ed was in the Merchant Marine, his wife was pregnant, and he saw an ad for a computer course in the paper. Mickey was an artist and found himself drafted. The army did not value his artistic skills, so he took a dp training course. Mickey comments that his artwork is very precise, and he feels he uses his creativity in systems design. Others mentioned taking computer course electives, which inspired them to go into the field. Mark and Rob were steered by employment agencies. Jack credited an IBM sales rep as his lead.

On-the-job motivation means being in a situation that evoked the respondents' interest or curiosity. For instance, Bill was a user who got tired of hearing the systems staff use dp jargon and then say, "We can't do it." He thought they did not listen and was frustrated with explaining what he felt to be merely common sense. Dp relaxed its recruiting rules and he became systems staff. Several people mentioned they had been in a scientific environment, were handed a manual, and told in essence to "go make this work on a computer." One CPA was trained in edp auditing while working for a Big Eight accounting firm. A couple of Navy veterans received exposure through their assignments. Eighteen years ago a job in process control forced Gene to learn about computers. He didn't like it at first but was soon hooked.

The "deliberate accidents" are more

FIG. 1

PAST, PRESENT, AND FUTURE TITLES

1979 TITLE	NO. OF TITLE CHANGES 1979-1983	1983 TITLE	1988 ASPIRATION
Junior SA	4	EDP Auditor	Project Leader
P/A	1	Senior P/A	Senior SA Advisor
Mgr. Tech. Systems	3	MIS Director	VP Info. Systems
Manager Sys. Devel.	1	Director	VP Administrator
Manager Dp	0	No Change	Manager Dp
SA	2	Materials Manager	General Manager
Systems Consultant	1	Mgr. Sys. & Methods	VP MIS
Sys. & Methods Admin.	1	Systems Consultant	Not yet defined
Project Manager	0	No Change	VP Area Manager
Area Manager	0	No Change	Dept. Manager
Asst. VP Community Banking Coord.	1	VP Community Banking Coord.	More "consulting"
Systems Consultant	2	VP Manager Telecom	Corporate Telecom Manager
P/A III	2	Advisor Computer Systems	Same until retirement (after '88)
Mgr. Mgmt. Systems	1	Mgr. Prime Services	Director MIS
Accounting Analyst	0	No Change	Accounting Manager
P/A	2	Part-time P/A	Tech. Consultant
Senior SA	4	*Supervisor Tax Sys.	Partner
Systems Manager	0	No Change	Systems Science Manager
SA	1	MIS Specialist	Manager Operations
MIS Specialist	2	*DB Administrator	Director MIS
Project Manager	0	No Change	Director
P/A	4	Coord. Info. Center	Division Manager
Sr. Methods Analyst	4	*Senior SA	Coordinator
Project Leader	2	*Contract Programmer	Program & Sys. Design
P/A	1	Computer Performance Analyst	No goal
P/A	4	**Senior SA/Prog.	Senior SW Programmer
SA/Programmer	1	SA	Senior SA
Supervisor Plant Eng.	2	Sr. Supervisor Sys. Operations	Divisional Buyer Purchasing
Programmer	3	Supervisor IS (I)	Supervisor IS (II)
Methods & SA	0	No Change	Medical school
SA	0	No Change	Teaching
Sys. Dev. Specialist	1	Sys. Dev. Supervisor	Systems Manager
Project Manager	1	2nd VP & Sys. Officer	Sys. Dept. Manager
Staff Assistant	0	No Change	Computer Sys. Div. Manager
Project Manager	1	No Change	Break Unit Head Dp
Systems Officer	5	Senior Sys. Planner	Operations Manager
Consolidation Acct.	5	Project Leader	Consultant
Applications Analyst	8	**Assoc. Dir. Medical Products	Consultant
Software Analyst	4	Section Manager	Director MIS
Op. Consultant	3	VP Marketing	VP Production Planning & Strategic Planning
SA	1	Sr. Proj. Manager	Sr. Tech. Project Mgr.
Project Manager	3	Assoc. Dir. IS Policies & Planning	MIS Director
Project Manager	2	Senior SA	Super. Integrated IS (II)
Mgr. MIS	0	No Change	Director IRM
Sr. Sys. Consultant	2	*Asst. to VP Planning & Admin.	Planning

*—One firm change

**—Two firm changes

P/A—Programmer Analyst

SA—Systems Analyst

Roman Numerals I, II, or III—Levels I, II, or III

Note: This list excludes retirees, dropouts, and users who plan to remain users.

See COBOL.

Dick is a COBOL programmer. Dick is bored. Harried. Dick struggles with trace and debugging routines. Nonexistent documentation. Mainframe logjams. So Dick is four months behind schedule. And users are upset about turnaround times. They yell and make Dick upset. They make Dick's boss upset. Nobody is very happy.

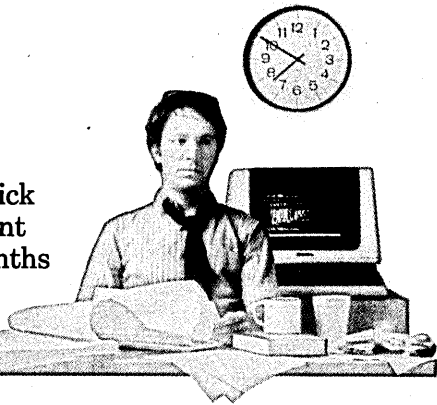

See COBOL Run.

Jane is a happy COBOL programmer. She uses ANIMATOR.™ It's a Visual Programming™ aid for Micro Focus LEVEL II COBOL.™ It runs on a micro. It makes child's play of mainframe test and maintenance chores.

With ANIMATOR Jane sees a picture of the program explaining itself. In live action. In real time. In COBOL source code. ANIMATOR tracks the program's exact execution path. Including subroutine branches.

Jane can have the program run fast. Or slow. Or stop. With one key. This makes it easy to spot problems. Insert fixes. Set breakpoints. Instantly.

Jane's programs sometimes win awards. Yet she always meets schedules. Jane's boss likes this about Jane. Because he doesn't like users to yell at him.



Run, COBOL, Run.

This DP manager got a bonus. Because he doubled productivity. Cleared backlogs. Cut costs. Boosted morale. Produced terrific applications. Quickly. Put control and prestige back into the central DP function. And nobody yells at him anymore. All thanks to ANIMATOR.

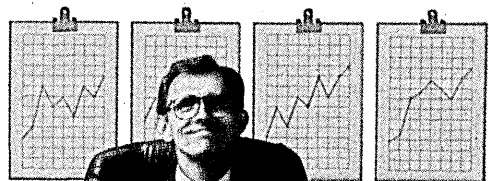

See ANIMATOR now.

Let Micro Focus put your DP shop on the fast track.

ANIMATOR runs with Micro Focus LEVEL II COBOL for compatibility with ANSI '74 High Level COBOL implementations. A mainframe-micro communications link is recommended for downloading mainframe programs.

For detailed information or a demo, contact:

MICRO FOCUS

2465 East Bayshore Road • Suite 400
Palo Alto, CA 94303
(415) 856-4161

© 1983 Micro Focus Inc.

amusing. In 1956, on a research lab tour, one college student was offered a job plotting trajectories from printouts. Dan went to an agency and said he wanted "something different," and he got it. Connie tagged along with a friend who was taking the civil service exam in programming. As an 18-year-old, Don carried tests back and forth to departments for a year. He was fortunate that his boss was the manager of software and sent him on for training to be an associate programmer.

A few of the users who were assigned as project liaisons found systems intriguing because of a dp project they worked on in 1979, and decided to learn more. One former accountant is completing his master's in computer science and is now a systems analyst.

JOB TITLE DATA VALUABLE

In regard to job descriptions, dp is similar to other areas in that the job title may not reflect the actual

functions of the position. For the purposes of this study, however, job title information is valuable, because a change in title often reflects a promotion. The title also indicates whether the individual is in a supervisory role. This sample includes few novices; therefore, by 1983, 80% are in management roles via promotions, according to the data (see Fig. 1). In five cases a change was made from systems to a user area, and in two cases the reverse was true. Lateral moves within a systems area to develop more technical skills involved three people. A change in title does not indicate a change in compensation.

Some titles appear to be in a systems area, but the person may actually report to a user area. One individual moved from one bank to another over the four-year period, but his title did not change. In one organization a new MIS director came in and relabeled all systems staff as programmer/analysts. This title change upset two systems people, because they felt it was a demotion even though their salaries remained the same. A year later one of these two was assigned a supervisory position and a new title within the same organization. Fourteen who are still with their 1979 firms have the same job titles. During the interviews, it was evident that three of those people were unhappy. One who had been with his firm for nine years originally said he would stay put until his boss moved. An update six months later revealed that he had been released and was doing contract work. The other two are leaving the business environment altogether. They both discussed cutbacks and boredom with maintenance activity. One of these two hadn't received a raise in two and a half years. Because of a maternity leave during 1980, Rhonda works part-time now in the same 1979 job title. Her

FIG. 2

PARTICIPANTS' DEMOGRAPHICS

	NUMBER OF RESPONDENTS	AVERAGE	RANGE
Age	58	42.2	27-62
Salary	45	44.3	25-100
Years working	58	18.4	6-43
Years in dp	58	12.9	0-35
Years with '83 firm	57	12.4	3-43
No. of firms	59	2.5	1-8

FIG. 3

POSSIBLE SYSTEMS PROFESSIONAL CAREER PATH

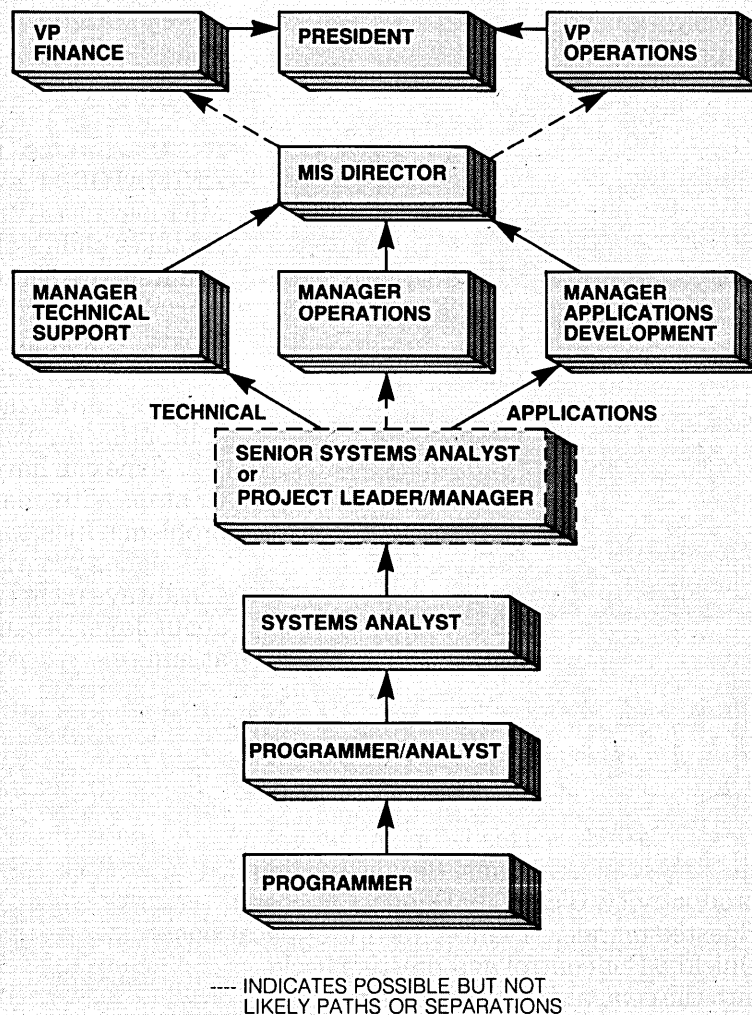

responsibilities moved up two levels, but her title remains the same because of cutbacks and her part-time status.

The average number of job changes is 1.7, with one woman having eight different titles. She considers her career unusual for the business and dp worlds and for women, and attributes these promotions to the unparalleled growth of MIS in her firm and her luck in timing. Her last move was out of the firm she had been with for six years, because she wanted to learn about a variety of industries

as a consultant and because of "an irreconcilable style difference with new management." Seven users and 16 systems people changed firms (three had done so twice), making the average yearly turnover rates 5.6% and 6.9%, respectively. Although some mentioned the recession, very few indicated that their canvassing extended beyond the Sunday paper. Several had had interviews since 1979, and serious considerations about changing jobs involved family and job challenge, but not money.

FLOPPIE COPPIER™

Series 4000 ADC's system breakthrough that copies both sides of double-sided diskettes at once!

Just as efficiently and smoothly as your office copier, ADC's new Series 4000 Floppie Copier™ automatically initializes and copies thousands of duplicate diskettes per hour—and doubles your throughput for double-sided diskettes!

Unlike other blackbox-type duplicators, Series 4000 gives you total single-master control of up to 16 slave stations—each simultaneously working on an entirely different diskette size and format. Since inventing the original Floppie Copier, ADC's developed over 390 different formats—and dozens of different protection schemes to prevent pirates from copying your Floppie Copier "copies."

ADC's own industry-standard-setting Robotic Disk Handler is built into each Series 4000 slave unit, automatically loading and unloading up to 100 diskettes with patented gentle fingers that eliminate the disk destruction of other systems. Floppie Copier assures you of perfect "copies" every time with true CRC control of both ID and data fields, instead of the indiscriminate duplication favored by some of our copy-cat imitators.

Compare and you'll come back to the original—especially now that the new Floppie Copier is even further ahead with simultaneous double-sided duplication—another ADC first!

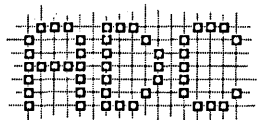
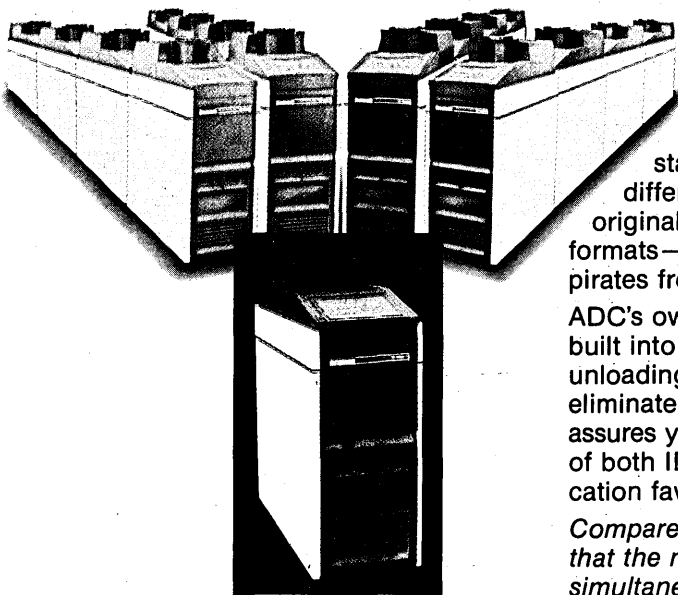

14272 Chambers Road, Tustin, CA 92680
(714) 731-9000

First and still foremost in media duplication and test technology

CIRCLE 90 ON READER CARD

The Northern Telecom system:
A benchmark in batch processing
that keeps getting better.



Northern Telecom batch processing systems have proven themselves, in more than a decade of use in a variety of applications, to be among the most reliable, practical, cost-effective systems ever developed. They deliver more throughput per dollar than any competitive system.

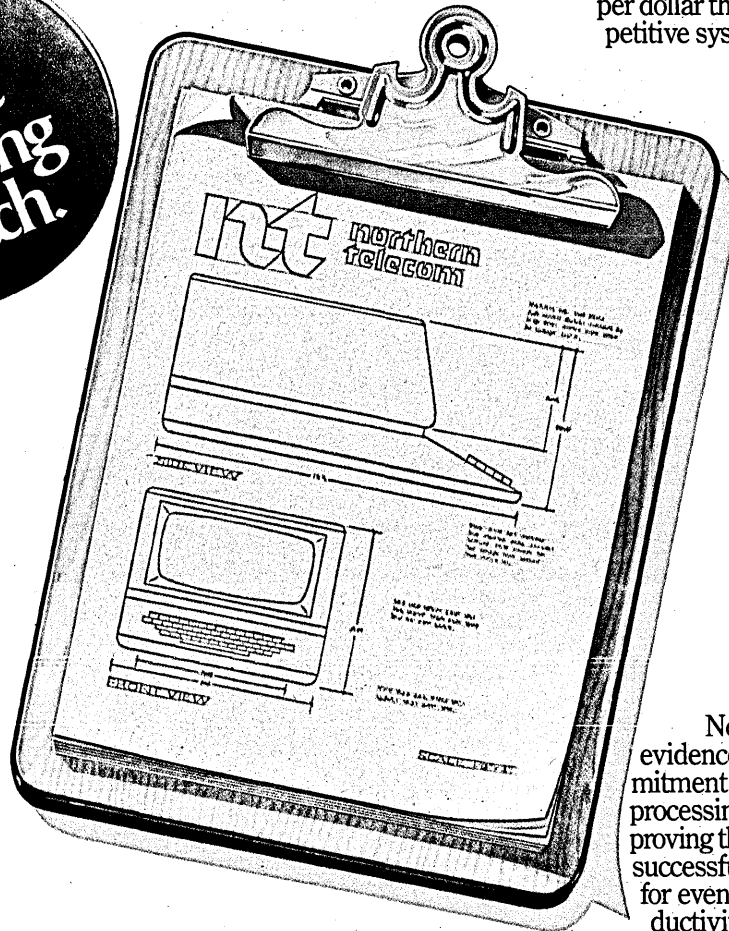

Now, as solid evidence of our commitment to batch processing, we're improving these already-successful systems for even more productivity. For

instance, we're introducing a new high-speed band printer with changeable type. Operating now with IBM's SNA, we've also added new, low-cost distributed data processing capabilities for more system versatility, and to provide for future growth toward the integrated office.

We're back



Time-proven performance with long-term savings.

Northern Telecom's aggressive pricing is more proof of our commitment to batch. Our discount structure offers long-term savings on multi-year leases. And at renewal time, you can save even more with discounts up to 30%.

Your processing may be remote, but Northern Telecom service is on the spot.

With service and maintenance professionals located at 157 cities nationwide, we're able to provide prompt response to your call for service. How fast? Two hours in major metropolitan areas; four hours in most other areas of the country. And our multi-year maintenance agreements guarantee continuing, low-cost operation of your Northern Telecom system.

If your system lease expires within the next six months, *now* is the time to find out more about batch processing from Northern Telecom.

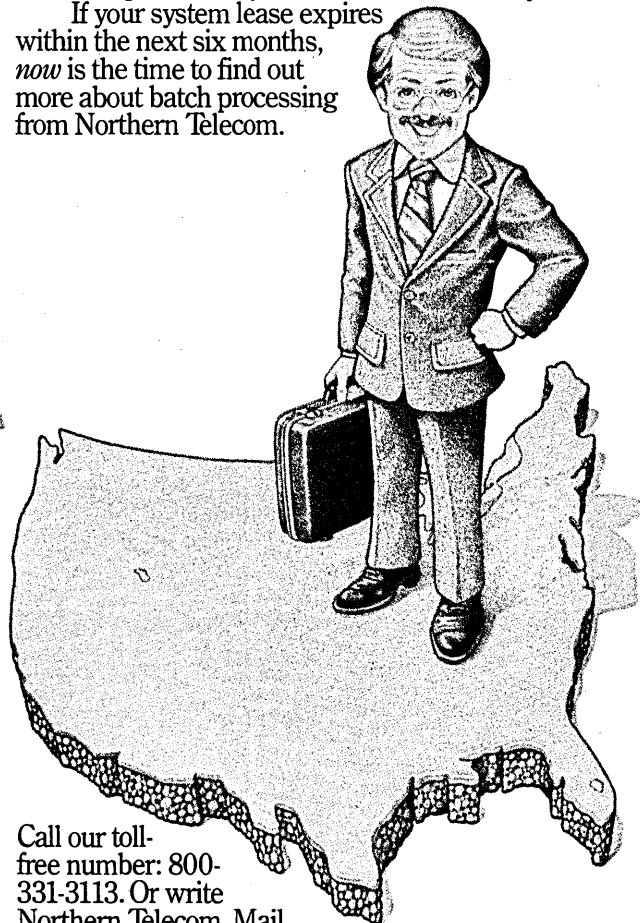

Call our toll-free number: 800-331-3113. Or write Northern Telecom, Mail Station T-240, P.O. Box 1222, Minneapolis, Minnesota 55440. We'll show you how we can tailor a batch system to your specific needs. And save you money, too.



ing batch!

Formal training, on-the-job motivation, and being in the right place at the right time all contribute to career advancement.

Turnover rates for the MIS departments were surveyed when available. Two managers indicated a rate of 10%. One, a bank dp manager, attributed this rate to an educational commitment to provide the dp staff with new skills and career guidance. In separate interviews, his staff confirmed the effectiveness of this program. One director in charge of MIS human resources said that in 1979 his MIS department's turnover was 40%. Because of the economy and the assistance of industrial psychologists, it came down to 8% in 1981 and has remained there. But he thinks this is too low. He believes 10% keeps the department energized; any lower and it stagnates.

Gary left a job because his duties involved external client consultation. He felt he did not belong anywhere. His was a case of turnover to seek identity within an organization and to prevent the feeling of being adrift. Besides changing firms, another type of turnover that dp managers should be aware of is the move to a user area and vice versa, or what we call crossover.

Hal has been in sales order entry, and now he calls it "electronic order entry." He is basically a user but says, "Half of my time

is spent on the sixth floor" (dp). Some firms encourage this crossbreeding. Pete and Brian, of different firms, both mentioned systems personnel who had acquired APICS (Association for Production and Inventory Control Systems) certification. Gil, who has a strong technical background, has been reporting to a user area since 1973, but he is a dp coordinator. It is not uncommon for Tom to be a user and have dp reporting to him—he is controller. More unusual is the case of Gary's boss, the vp of finance, who was formerly a systems person but is now a CPA. Curt mentioned clerical workers who used dp skills for upward mobility. Curt thinks it is easier to train a business-oriented person in dp than to teach business skills to a dp person. As a systems manager, Curt actively recruits accountants. Len, a plant engineering supervisor in 1979, now supervises network control in dp operations. He wants to go into purchasing. Brian feels like an expert because he is the token "systems person." A systems liaison to purchasing in 1979, he now manages the area.

Boredom sets in and people start looking. In 1979, when Curt was a systems analyst, he told his boss that he was bored, so

his boss gave him more work. That wasn't quite what he had in mind, and he clarified that point with the boss. At 33, Curt is now associate director of information policy and planning after being manager of operations (for which he had no experience or training) at his 1979 firm—a major mining and processing firm with 14 divisions. He is organization and department loyal "as long as MIS is not a dead end."

From our original 59-person sample, nine were in systems and have now switched to user departments and nine others have gone from user areas to systems. These people comprise one third of the study group, and they exude self-satisfaction because of their versatility. They are also nervous about losing their expertise in their former arenas.

CAREER GOALS FOR 1988

For such a short time span, these findings are interesting. In the ever-changing field of MIS, projecting from the past is dangerous. We asked the sample group to project what positions they would like to hold in 1988, regardless of their firms' career path structures. Dan is working on minis for EFT applications. He doesn't care

This April twice the maga

April 1, 1984

April 15, 1984

D A T A T A N

D A T A T A N

what his title will be in 1988 or if he'll be working on minis. But he does care very much that whatever he works on is state-of-the-art technology. Rob said his 1988 job isn't yet defined, because he hopes it's in an area that hasn't yet been developed.

The two individuals who have deliberate plans to leave the profession by 1988 are now doing maintenance, and referred to it as "criminal work" and babysitting. Their organization is in a depressed industry and their systems group lost 10 members who won't be replaced soon because of user layoffs. One wants to teach, and the other is going to medical school.

Nine former systems staffers who worked in a user area want to stay in it, and four more who have not worked there see it as their 1988 home. Some said that dp is a dead end. One 1979 user, who is now in systems, indicated that he is there only to acquire technical skills. He realized the value of these skills while working on a project three years ago and now supervises some of the systems staff with whom he worked on that project. Another 1979 accountant will stay in dp because of the challenge.

Only one 1983 user wants a 1988 dp

home. Few systems people chose the job title directly above their current positions. They either jumped several steps (sometimes out of dp) or made up a title that doesn't currently exist in their company. Apparently, the field has changed so rapidly that it's hard to imagine what lies ahead. The participants in our sample seem to relish this uncertainty rather than be anxious about it. For some, their 1983 job did not exist in 1978 so they look forward to being the first (fill in the blank) in 1988. Most are clearly upward, often through user areas, though two wish to move laterally to acquire more technical skills.

One consensus of the sample was that you make your own career path in or out of the organization. An unexpected response was that another person had pushed or motivated the participants in certain directions. Nine of the participants mentioned one or several people who "wouldn't let me fail," "really believed in me," "told me not to wear short-sleeved shirts," and "taught me how to deal with people." Older role models were perhaps not present in the systems analyst function, but in an advisory capacity mentors were appreciated. In one bank, three participants talked at length of the same per-

son named Howard, who had convinced all three that they were each unique and had enough talent to do anything.

THREE MAJOR FINDINGS

This survey produced three major findings, which I'd like to explore in detail.

First, little evidence was found of formal career paths. Existing informal career paths seem limited in comparison with other occupations or for a group that has such a strong need for career growth. It is possible that a formal career path may not be necessary. Dp personnel who are apparently successful (no measurements were attempted) find a path for themselves. Mark, Curt, Gary, Dana, and Hal had positions created for them. There was no indication whether these opportunities came about through their own initiative or that of a supervisor.

One might ask how career paths can be designed when it is so difficult to anticipate what the interaction of technology and organization structure will be in five years. It is not clear whether the "dead end" on paper is a motivator or a practical constraint. If dp management attempts more counseling and

l, it'll be zine it is today.

DATAMATION®

DATAMATION®

Every month, information processing professionals depend on *Datamation*. It's the best read, most respected publication in the computer industry worldwide.

And to help our readers cope with the increasing demands of their jobs, *Datamation* will be increasing its frequency beginning this April. Two issues every month. 24 issues a year. More vital information. More in-depth features. More timely topics. And twice the opportunity to stay ahead of the world's fastest moving business.

The field has changed so rapidly that it's hard to imagine what opportunities lie ahead.

expands its structures, would this be stifling to "the free spirit" (as one dp manager put it) of dp staff? Future MIS directors should assess career development programs as to their effectiveness for retaining key personnel.

The words variety, challenge, growth, and learning kept coming up in the participants' responses. Brian likes to see "barriers broken down." Connie says it is "exciting that the pressure is on and then off." Rhonda says her work is challenging because she is learning, then teaching that skill to someone, then learning and teaching again. Bill says you have to have the temperament to "answer problems while 10 people are leaning over your shoulder." When asked why they have not been lured away, several respondents said they could make the same money elsewhere, but the variety of responsibilities in their jobs keeps them there. Dana says, "Dp people like change. If they don't get it, they change jobs."

Secondly, it was a surprise to find this sample so organization loyal. The maturity of the field is one explanation. Turnover rates in previous years were compiled about people with less dp experience. This vanguard group has both professional and chronological maturity, which can be linked to security needs. Both Don and Mickey (in their early thirties) mentioned pension benefits. Future research should segment age groups and years of MIS experience to better analyze turnover data. A number of the participants expressed gratitude to their organizations for the opportunity to develop what they perceived as the best technical skills. Crossover may explain the unanticipated lack of turnover, but a recession

seems to be the opportune time to nurture this loyalty. While some staff members are leery of changing to a new environment, others, in whom organizational commitment is marginal, might become more loyal if development programs were instituted. When the economy turns, employee tenure and management support discourage someone from exploring outside the company.

Third, although this study started out as a survey of systems professionals, it soon became apparent that some participants who reported to a systems area in 1977 were actually users in disguise. In 1983 some systems staff had migrated out to user areas. To complicate matters further, they openly admitted their intentions to switch again! Thus the focus was changed to "systems-related professionals." One former user, now a systems analyst but soon to be a user again, stated, "We won't need systems people in the future." Another said, "The crossover is the way of the future." These two may have lacked objectivity, but even those who are exclusively users or dp people hinted that such chameleons are the ideal systems people and users. Is it possible that we might have systems-proficient users and functional systems analysts?

NEW JOB TITLES IN FUTURE

Past and future trends point toward the user area, indicating career paths that will be difficult for a human resources personnel department to manage. It is likely that a variety of titles will proliferate, if the participants' inability to give a 1988 job title is an accurate indicator.

Less clear, however, is whether the migration to user areas is a result of the lack of dp career paths. This is a tempting conclusion to make, but other conditions are worth investigating. For example, the high growth need of systems professionals may direct them to functional areas. Most of the participants stressed the importance of having a systems staff that understands the business environment. Users' computer literacy is inevitably growing with the infusion of micros into the office and home. Their heightened interest in the technical sphere and the desire of systems staff to complement their technical base suggests a blur of systems-related professionals. The systems staff and users in this sample urged young people to work in user areas and supplement technical training with business training to become the ideal systems persons.

A likely scenario for the future information resource department is a small technical staff with a core of trainers that users can call on, headed by a vice president of planning and information. Some firms are already promoting such an atmosphere with the use of information centers. One dp manager commented on losing two of his information center staff to user areas, because dp puts their best communicators in the center. Instead of worrying about a loss of power base, the MIS director might plant the best systems analysts in key user areas (an example of internal turnover). This infiltration strategy puts the MIS director in charge of the information resource and proves to the firm that information is a major asset. The crossover trend could lead to the day when all users are systems proficient, and the systems analyst of today is no longer necessary. That would solve the shortage problem without waiting for MIS and CS programs to produce trained technicians.

MIS management should assess the opportunities available for their staff, their users, and themselves. Some firms have encouraged this internal turnover from systems to the user area and vice versa. Perhaps it is too soon to evaluate whether these experiments are successful in filling the gap in skilled personnel. On the other hand, it may be too late to experiment once the staff is lost. In September 1978, DATAMATION carried an article by Jac Fitz-enz, entitled "Who Is the Dp Professional?" In 1988 we might walk into a user area and ask, "Who is the real dp professional?" *

Kate M. Kaiser is assistant professor, MIS, with the University of Wisconsin-Milwaukee. Prior to this position, she taught MIS at McGill University in Montreal. Dr. Kaiser began her dp career in 1967 as a keypunch operator on second generation equipment at Kent State University.

CARTOON BY LEO CULLUM

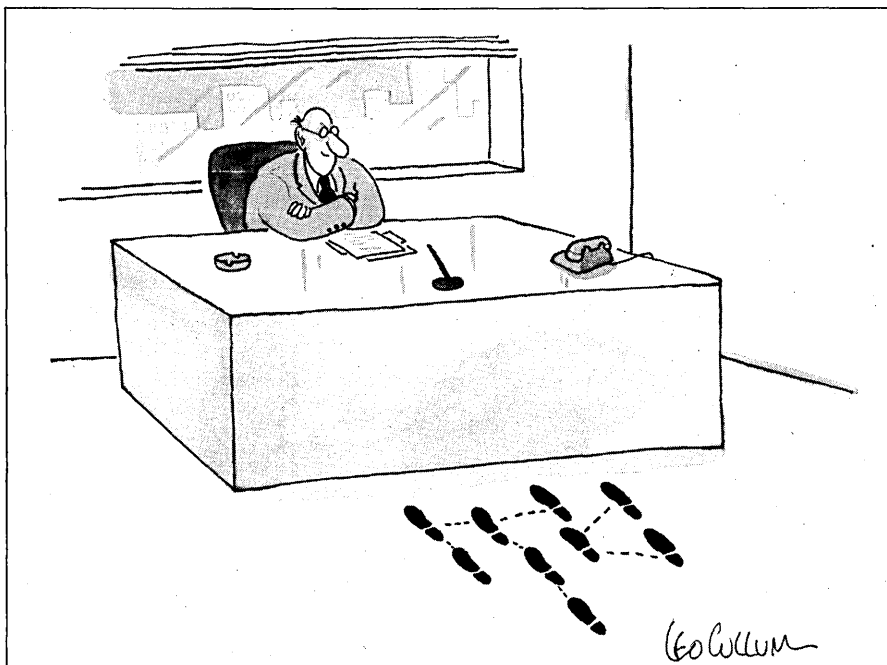

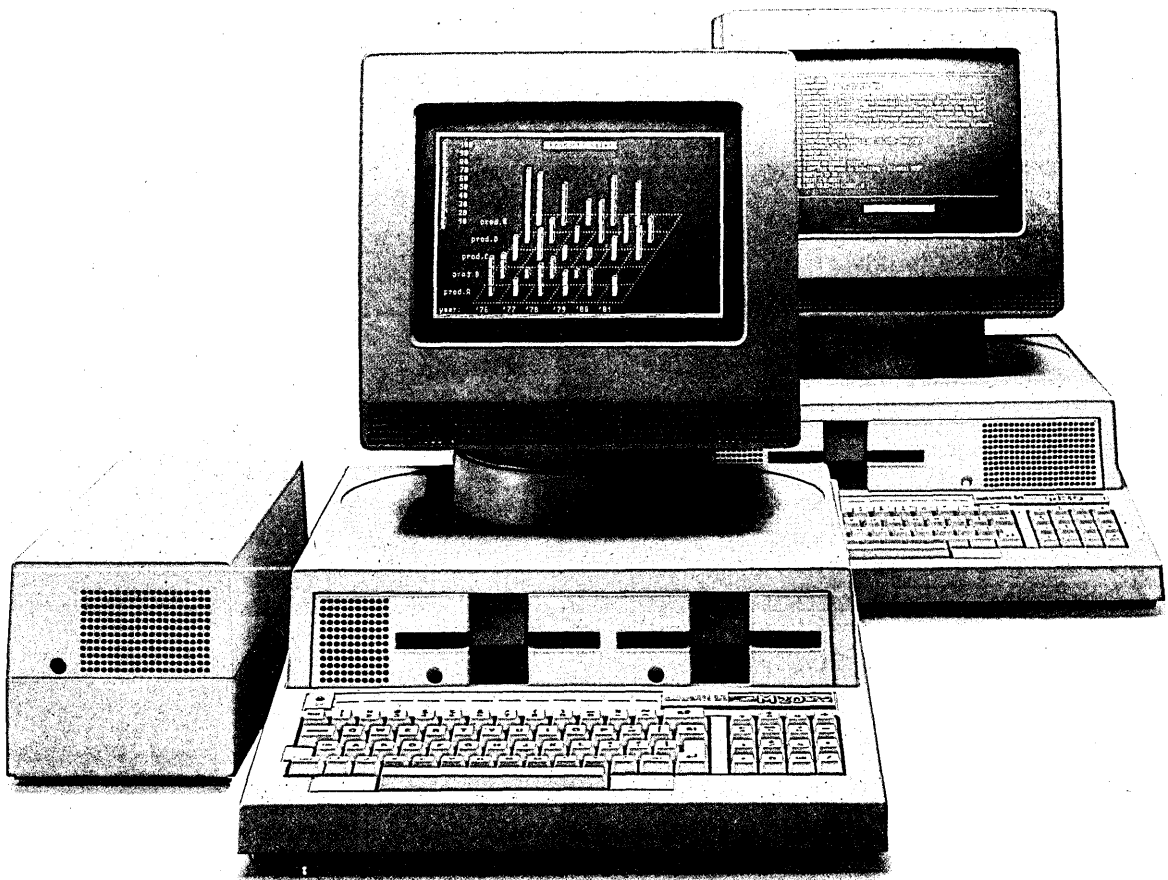

OLIVETTI M20 PERSONAL COMPUTER

**WE'VE MADE A FAMILY
OUT OF A PERSONAL**

Olivetti, who invested its office know-how in the M20 personal computer now introduces you to another member of the family: the M20D model with a memory thirty times larger than the basic version. And when there's a need for even greater power and coordination in office jobs, the Olivetti M20D can manage a group of M20s working in conjunction with one another, integrated into a local area network. So from today there is a family of Olivetti personal computers with different storage capacities and a wide choice of operating systems (MS-DOS, CP/M-86, PCOS, UCSD-P) to satisfy different needs. And with



their 16-bit technology and communication capabilities they will keep abreast of change. In fact they are designed for integration into remote text/data processing and office automation as it is today and as it will be in the future. Olivetti protects your investment in equipment and software. The M20 personal computer family makes your problem solving less problematic leaving you far more time for the creative side of your job. Olivetti's personal computers embody all of the company's leadership in ergonomics and design which have become a consolidated part of its success in the office throughout the world.

MS-DOS is a trademark of Microsoft Inc.
CP/M-86 is a trademark of Digital Research.
UCSD-P system is a trademark of the Regent of the University of California.

olivetti
brains & beauty

CIRCLE 92 ON READER CARD



“Cripes, Cratchett, if Cooley ever copies those contracts she could start her own company!”

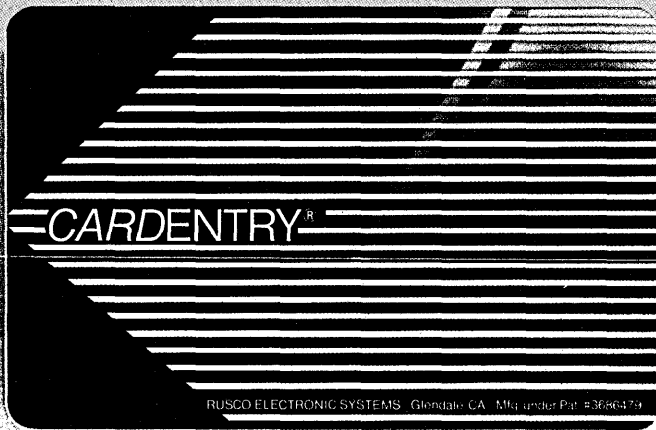

How to secure your company from the inside out.

Your toughest competition could come from your own people. And often the ones you'd least expect. But there's a way to stop them, with a system now used by thousands of companies all across the country. The Cardentry system from RES.

You begin by giving a Cardentry card to the employees you decide to authorize. Each card encoded with valuable access information that can't be tampered with or duplicated.

A card reader then transmits this code to the controller, which interprets all your instructions. If the person is supposed to enter, the door opens. If not, the door stays shut. Either way, his name, location and the time of day are recorded.

Even in a total power or communications failure, Cardentry won't fail you, thanks to



our thoughtful card readers. Powerful components that keep right on working (and thinking), recording all transactions until power is restored. That's the kind of security you can't get from any other company.

No other company offers our flexibility, either. When you want to expand your system, with Cardentry you can, easily and on-site. You can even keep copy machine costs under control by adding a copy monitor. Or get detailed management reports, in plain English, the moment you need them—just by adding a Cardentry host processor.

So if your company's got something worth protecting, don't take any chances. Keep a Cardentry system around to protect it. After all, if Cooley never copies those contracts, Culpepper might.

RES, Headquarters, 1840 Victory Blvd., Glendale, Ca. 91201.
 Offices in principal cities worldwide. Call toll free: 1 (800) 528-6050 x691; Arizona: 1 (800) 352-0458 x691; Phoenix: (602) 954-4600 x691; Alaska and Hawaii: 1 (800) 528-0470 x691.

RES | RUSCO ELECTRONIC SYSTEMS
 A FIGGIE INTERNATIONAL COMPANY
 CIRCLE 93 ON READER CARD

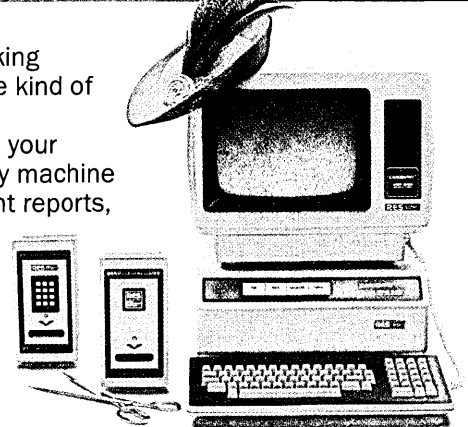

INTELLECT.™

NO SOONER SAID THAN DONE.

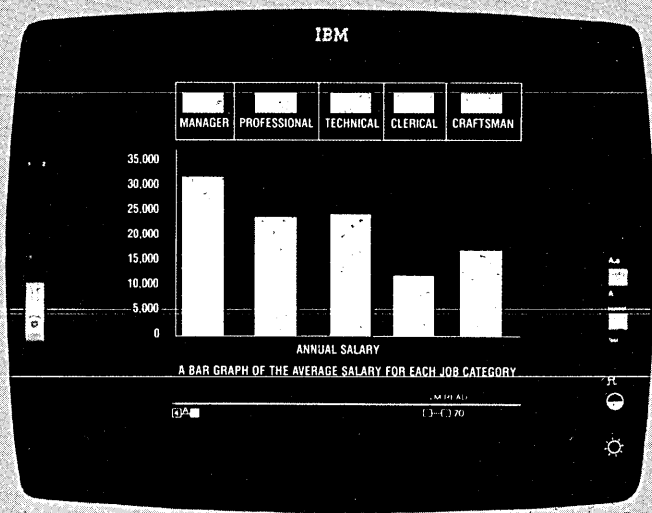
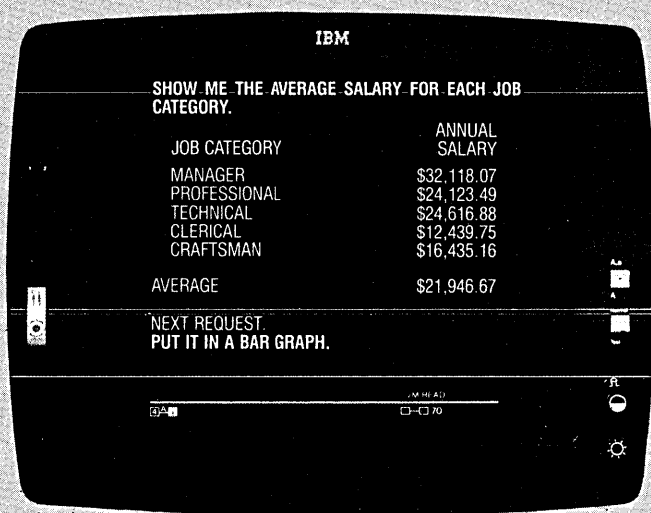

To use INTELLECT, the natural language query system, all you have to do is ask—in everyday conversational English—and you'll retrieve. Immediately, in either text or full-color graphics.

INTELLECT, the world's only successful *true* natural-language query system, is an ideal tool for your information center. INTELLECT's powerful information retrieval capabilities are so advanced that it understands questions and responds with answers as if you were talking to a knowledgeable colleague. Executives access data themselves—more easily than ever before—without learning any technical jargon or "computerese." It's so easy to use, it doesn't even have a training manual!

Whether you use INTELLECT as a retrieval system or as an effective data analysis tool, it transforms raw data in the data base into information and presents

it in finished color graphics in a matter of seconds. It's a live dynamic interface that fully integrates your existing database and graphic systems.

Already hard at work in hundreds of organizations, INTELLECT is ideal for marketing, finance, personnel, manufacturing, and banking applications.

INTELLECT is an important technological breakthrough. You can learn more about it by attending one of our nationwide seminars. Or put its amazing power at your fingertips in minutes with one of our demonstration tapes.

Call or write for more details. Look into INTELLECT, and be an eyewitness to the future of computing.



ARTIFICIAL INTELLIGENCE CORPORATION
100 Fifth Avenue, Waltham, MA 02254 617-890-8400

CIRCLE 94 ON READER CARD

The race is on in four technologies that will be crucial to information processing in the 1990s.

WINNERS AND LOSERS IN THE FIFTH GENERATION

by Frederic G. Withington

Several areas of advanced (or fifth generation) computer technology are currently subject to particularly intense international competition. They are:

- Large-scale integrated circuits,
- Disk drives (magnetic and optical),
- Supercomputers, and
- Knowledge-based or problem-solving systems.

With varying degrees of government assistance, competitors in the U.S., Japan, and Western Europe are jockeying for improved capabilities in these areas. This article summarizes forecasts of these technologies recently prepared for the federal government,¹ predicts the degree of success that competitors in each region will have, and discusses their interrelationships in the future structure of the information industry.

Large-scale integrated circuits. Semiconductor devices are likely to continue at their recent rate of improvement for at least another 15 years. One of the results is forecast in Fig. 1. The present multi-chip, 32-bit microprocessors will soon be available in one-chip versions, and 64-bit microprocessors should be available in multi-chip versions by 1986, with one-chip versions before the end of the decade. High-speed bit slice microprocessors will evolve at a corresponding rate.

Prices of microprocessors will decline at a more steady rate (Fig. 2) dictated by manufacturers' learning curves. The four-bit microprocessor (on which the pocket calculator is based) now costs less than \$2, and the

FIG. 1

MICROPROCESSOR BIT CAPABILITY VS. YEAR OF INTRODUCTION
FOR ONE- AND MULTI-CHIP ARCHITECTURES

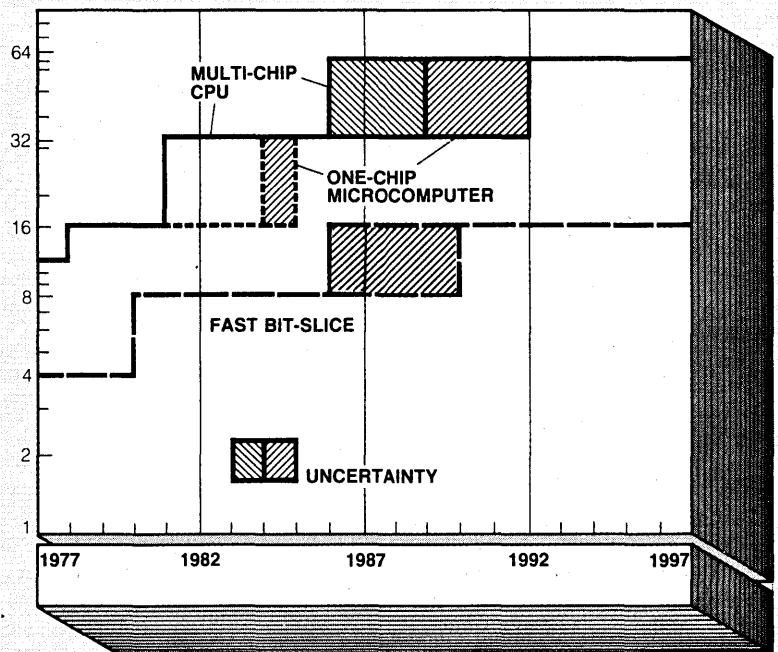

Source: Arthur D. Little Inc. estimates

16-bit microprocessor (still the heart of most personal computers) has recently dropped below \$10. Since they are not in widespread use, 32-bit microprocessor chip sets are still relatively expensive, but as volumes increase costs should drop steadily to below \$10 per unit sometime in the mid-1990s, at which time the 64-bit microprocessor should be in the \$20 to \$30 range.

The rate of price decline will slow as time goes on. This will occur not so much because the unit cost of manufacturing each chip will stop declining, but because of the increasing cost of capital needed to finance new production equipment. This may be the only industry in which it is necessary to throw away most of the factories every five years or so and start over with new ones that will

CHARTS BY PAUL GOODFRIEND

¹ The forecasts summarized in this article appear in their full form in the report "Future Information Processing Technology, 1983," published by the Institute for Computer Sciences and Technology of the National Bureau of Standards in August 1983, and in "Future Information Processing Technology," a report submitted by Arthur D. Little Inc. to the Defense Intelligence Agency in December 1982. Copies of the latter report may be obtained from the author.

Circuits with 20 times the speed of those in use today will be routinely available by 1997.

probably cost twice as much.

Similar trends apply to semiconductor memory (Fig. 3). The cost of memory chips should continue its steady decline on a logarithmic scale as the chips get bigger and denser: by the mid-1990s memory chips should cost at least one order of magnitude less than they do today. The cost decline for memory chips should continue longer than that for microprocessors, because redundant error-correcting logic in memory chips permits a higher level of manufacturing defects. The same problem of capital investment exists, however; larger-scale memory chips with narrower line widths generally require entirely new production equipment.

The lower costs forecast in Figs. 2 and 3 will derive primarily from larger-scale circuits (up to wafer-scale integration), narrower line widths that reduce the size of individual circuit elements, reductions in defect densities, and improvements in the manufacturing art. To a degree, the same improvements will also bring about higher speeds of operation. Fig. 4 shows the basic unit of semiconductor speed—stage delay per gate circuit—as a function of time for several technologies. Both slow and fast silicon circuits will improve by at least one order of magnitude between now and 1997, because of the smaller line widths and larger scale of integration noted above, and also because of improvements in cooling and packaging techniques. If this is not enough (and it is not enough to suit the number cruncher's demand for speed in supercomputers), new technologies are available. Circuits using gallium arsenide instead of silicon as a substrate are designed in much the same way (although different chemistry is used), but the charges move through the gallium arsenide substrate about five times faster than they do through silicon. Gallium arsenide devices are already used routinely in high-frequency communications applications and are available in prototype form for digital circuits; there is little doubt that they will enter widespread use.

Competing against them will be cryogenic superconductor technology, employing the Josephson junction. In research for many years, this technology continues to encounter engineering difficulties. With or without cryogenics, however, it appears likely that circuits with at least 20 times the speed of those in use today will be routinely available by 1997.

The three laws of thermodynamics were once paraphrased as follows:

First law: You can't win.

Second law: You can't even break even.

Third law: Furthermore, you can't quit the game.

It must seem to some of the competi-

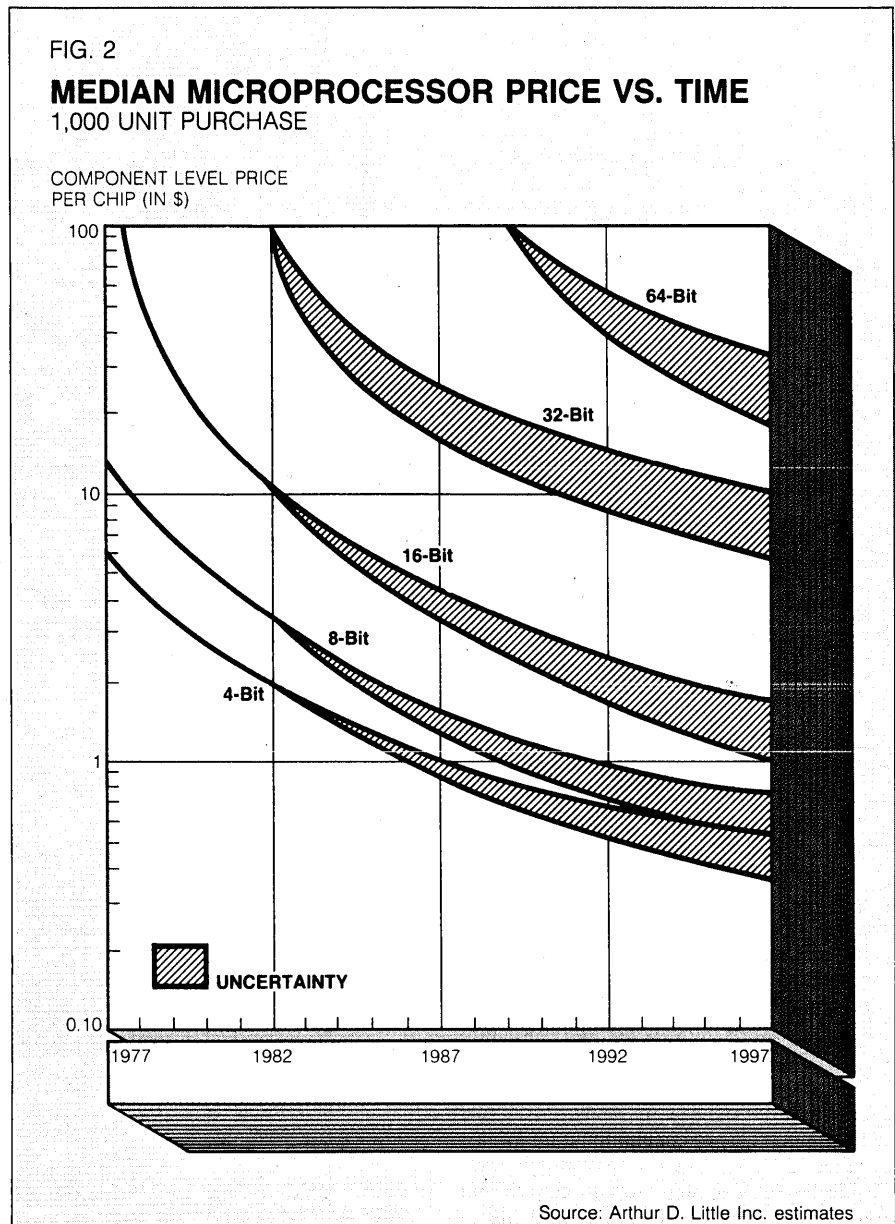

tors in the semiconductor industry that these laws apply with distressing accuracy to their business. They can't quit the game, because to lose the ability to produce custom-designed chips would be to lose the capability to establish product uniqueness in many kinds of system products.

CUSTOMERS BECOME RIVALS

Desire for in-house system capability even turns customers into competitors. Western Electric and NCR have recently become sellers of chips, rather than just buyers, and IBM sells indirectly through its part ownership of Intel. (There's no reason IBM can't offer chips directly from its own semiconductor plants in the future.)

National governments in many Western countries intensify the pressure. They believe that indigenous semiconductor capability is a strategic necessity, not just an economic asset; as a result, various forms of direct government support and cooperative research projects involving industrial and academic entities with government funding are found in the U.S., Europe, and Japan. To stay in the game, however, players must continually increase their manufacturing investment. The market will continue to grow, but not fast enough to return a profit on escalating investments for all of an increasing number of competitors.

This process can have only one result: a reduction in the number of entities attempt-

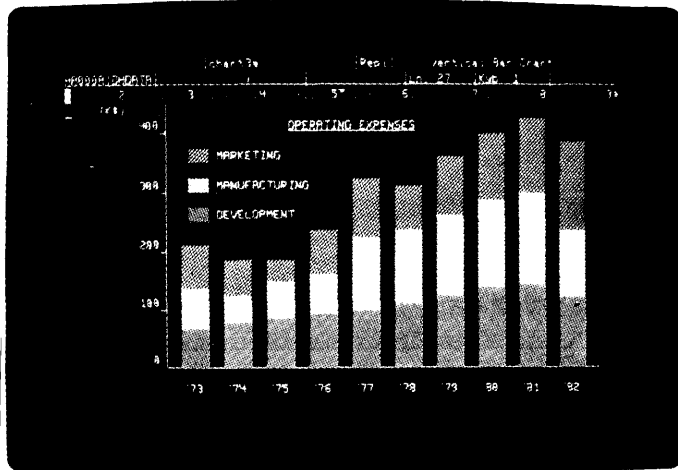

Year	WAGE	gross sales	gross wages	Rate
'73	7.50	1000.00	220.00	22.00
'74	8.00	1200.00	264.00	22.00
'75	8.50	1400.00	308.00	22.00
'76	9.00	1600.00	352.00	22.00
'77	9.50	1800.00	396.00	22.00
'78	10.00	2000.00	440.00	22.00
'79	10.50	2200.00	484.00	22.00
'80	11.00	2400.00	528.00	22.00
'81	11.50	2600.00	572.00	22.00
'82	12.00	2800.00	616.00	22.00

```

PROFESSIONAL OFFICE SYSTEM
PF1 Access databases
PF2 Query the data
PF3 Access documents
PF4 Access files and registers
PF5 Access programs
PF6 Access documents from other sources
PF7 Access the Mail log
PF8 Access the outgoing Mail
PF10 Add an additional reminder
PF11 Look at your memo number 2
PF9 Help PF12 Stop
  
```

```

          CCCCCC  IIIIII  CCCCCC  $$$$$$  ****  $$$$$$
          CCCCCC  IIIIII  CCCCCC  $$$$$$$$  **  $$$$$$$$
          CCCC  CC  IIII  CCCC  CC  $$$$  $$  **  $$$$  $$
          CCCC  CC  IIII  CCCC  CC  $$$$  **  ****  $$$$
          CCCC  CC  IIII  CCCC  CC  $$$$  **  ****  $$$$
          CCCCCC  IIIIII  CCCCCC  $$$$$$$$  ****  $$$$$$$$
          CCCCCC  IIIIII  CCCCCC  $$$$$$$$  **  $$$$$$$$
  
```

Don't choose a text processor until you've seen the data on ours.

The IBM Displaywriter.

One reason the IBM Displaywriter is the best-selling stand-alone text processor is that it's also a stand-out data processor.

You see, there's a variety of software available that will let you do data processing jobs, like sales projections and statistical analyses; as well as develop your own programs.

What's more, the Displaywriter can give you 3270 emulation.

And with our DISOSS and PROFS office systems software, the Displaywriter can also be connected to other IBM office systems and terminals.

So your company can have the full benefits of

electronic mail, filing and calendaring.

The Displaywriter is so versatile, it can even give you business graphics like pie charts and bar graphs. And it can integrate text and graphics while printing.

Of course, all of this is in addition to our text processor's most impressive benefit: the way it processes text. For example, it helps edit, revise, reformat, footnote, file, and check and correct spelling.

The IBM Displaywriter. It makes the process of choosing a text processor very simple.

To arrange for a demonstration of the IBM Displaywriter (the basic model is \$4,990), call your IBM representative, visit an IBM Product Center, or call the toll-free number below. **IBM**

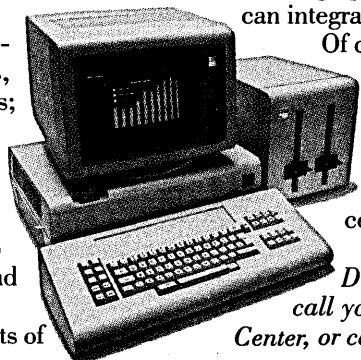

Call IBM toll free at 1 800 IBM-2468 Ext. 82. Or write to: IBM, Dept. BJ3, DRM, 400 Parson's Pond Drive, Franklin Lakes, NJ 07417.

CIRCLE 95 ON READER CARD

The optical disk may represent a growth opportunity for several European information technology centers.

ing to compete. New technology now makes it possible for system manufacturers (and nations) to withdraw from semiconductor manufacturing without loss of control over circuit design. Gate arrays (general purpose logic chips containing large numbers of separate circuit elements in rows, where the final two or three manufacturing processes provide the interconnections appropriate to a particular system design) can be sold as commodities to system manufacturers. Their engineers can design the precise logic needed, and then at modest cost perform the final manufacturing steps to customize the gate arrays. Individual companies or smaller nations could establish strategic stockpiles of memory and gate array chips, and still retain the capability of designing unique logic elements.

If this happens, the market in the middle 1990s may support only a half dozen or so giant manufacturers of commodity memory and gate array chips, with little significance attaching to their corporate or national location. The surviving giants will be those organizations able to attain the highest degree of automation consistent with high-production yields, and also able to attract enough investment capital to stay the course. A lot of money will be needed and payback will be slow, because revenues must be reinvested in successive generations of equipment rather than paid out as profits. This implies a role for governments, perhaps as guarantors of industrial investment bonds, as in the U.S., or as direct owners of semiconductor companies, as in France.

Disk storage. Fig. 5 shows 40 years of disk drive prices in terms of purchase price divided by capacity (cents per character stored). The historical points from 1955 to 1980 are derived from IBM's list purchase prices for its largest capacity magnetic disk drives, starting with the 305 RAMAC and ending with the 3380. These prices fall on a remarkably smooth curve, and have declined approximately 20-fold. The density of storage on a leading-edge disk drive now exceeds 10 million bits per square inch, and improvements are continuing through combinations of thin film heads, plated media, and a variety of engineering improvements ranging across a size scale from 3-inch floppy drives to 14-inch, large capacity Winchester.

If no major technological innovation occurs, the cost per character of disk drives will soon approach a peak. As Fig. 5 shows, however, we expect two major technological innovations: optical storage and vertical magnetic recording.

In vertical magnetic recording, the magnetized domains are stacked perpendicular to the surface of the substrate, rather than horizontally, as is the case in the current mode. Vertical recording at 100,000 bits per

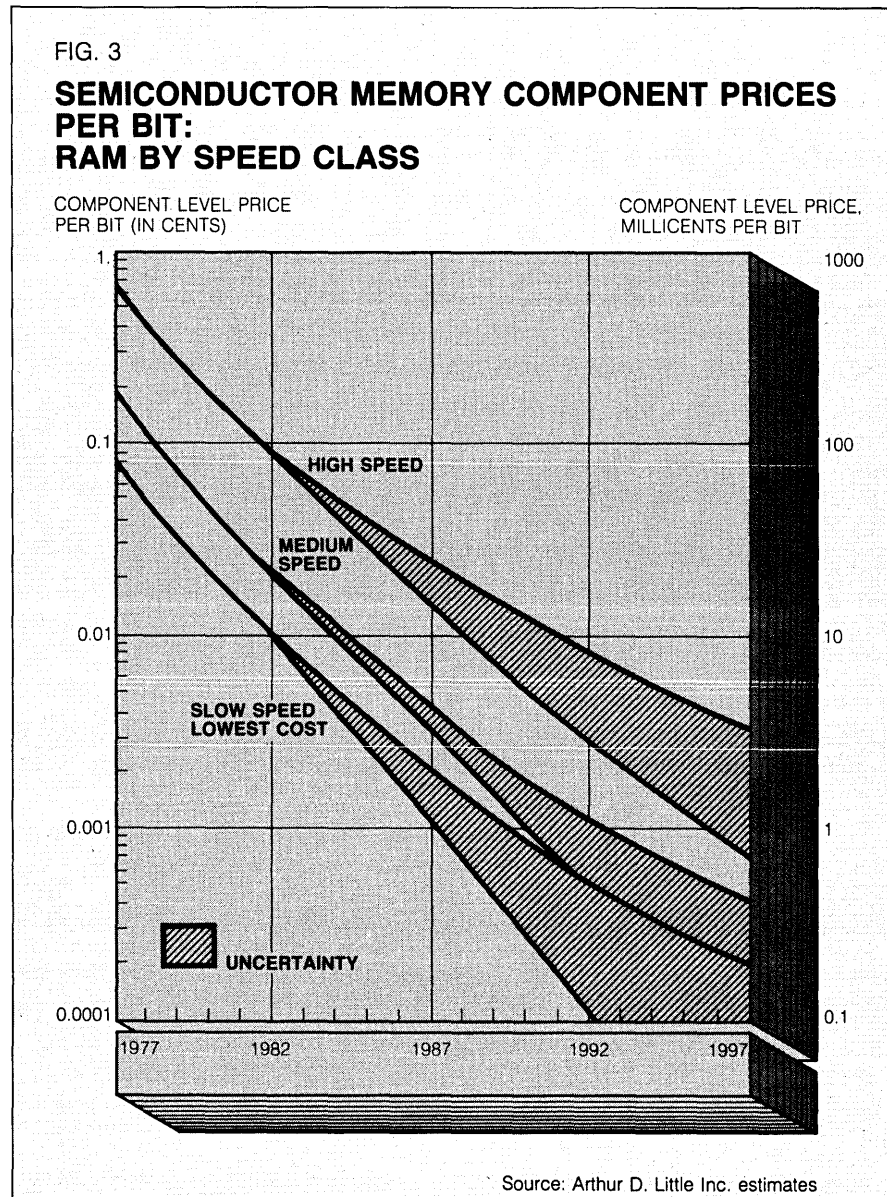

inch has already been demonstrated in the laboratory, and ultimate linear densities of over 400,000 bits per inch are considered possible. Corresponding area densities would be as high as 400 million bits per square inch in 1997, nearly a 40-fold improvement over today's level. It is not certain that such improvements are possible because electro-mechanical assemblies will require considerable refinement to work at these extremely high recording densities.

OPTICAL RECORDING PROMISE

Optical recording promises packing densities comparable to, or even greater than, those achievable with vertical magnetic recording; furthermore, they may appear first. Most ap-

proaches to optical recording, however, do not permit rewriting of data in the same place. It may be that one or more of the several rewritable systems under development will be successful. It may also be that this write-once characteristic of the optical disk does not matter; archival and office applications in which rewriting is not desired may be sufficient to provide ample market growth. It seems likely that optical and vertical magnetic recording will coexist in different applications and configurations.

The pace of technological innovation in disk drives has been great enough to permit a flow of new companies to grow to permanent profitability alongside the established disk drive vendors, some of whom have faded away into the technological sunset. The

A Plug for IBM

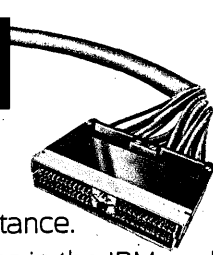

SSI printer system expertise gives you total IBM plug-and-go compatibility...

and saves you about **50%**

The SSI connection is all you need to do everything IBM printer systems can do (and a lot they can't) for a lot less money.

For instance, our QT1130-05 printer (illustrated) and its controller are plug-compatible with all IBM mainframes. Compared to the 3203-Model 5 the system provides 20% higher throughput. Speaking of controllers, our 32/5 can drive longline printers (up to

2500 feet) off the channel—better than 10 times IBM's distance.

We have other unique solutions in the IBM world, too, for System 34, System 38 and you name it. Such as driving four printers from one control box. Or generating remote output in parallel mode (our 9135 Converter) so that remote printers appear local to the processor. In serial communications, we offer full compatibility with 2780, 3780 and 3270 Type A&B protocols.

SSI quality is proven by seven years in the field. We lead in speed, too: our new Mercurion 1 non-impact printer goes 5280 lines a minute. As for service, we now offer the SSI team of specialists plus the full clout of TRW. So there's no reason to hesitate. Call us or mail the coupon for the full story.

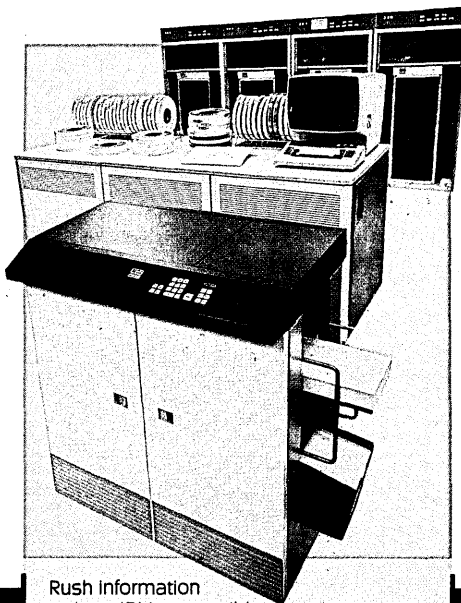

SSI Southern Systems, Inc.

2841 Cypress Creek Road
Ft. Lauderdale, FL 33309
(305) 979-1000 (800) 327-5602
TELEX 522135

Southern Systems Canada:
(416) 229-2589

Rush information on your IBM-compatible printer systems and peripherals to:

Name _____	Title _____
Company _____	
Address _____	
City, State, Zip _____	
Specific Interest _____	

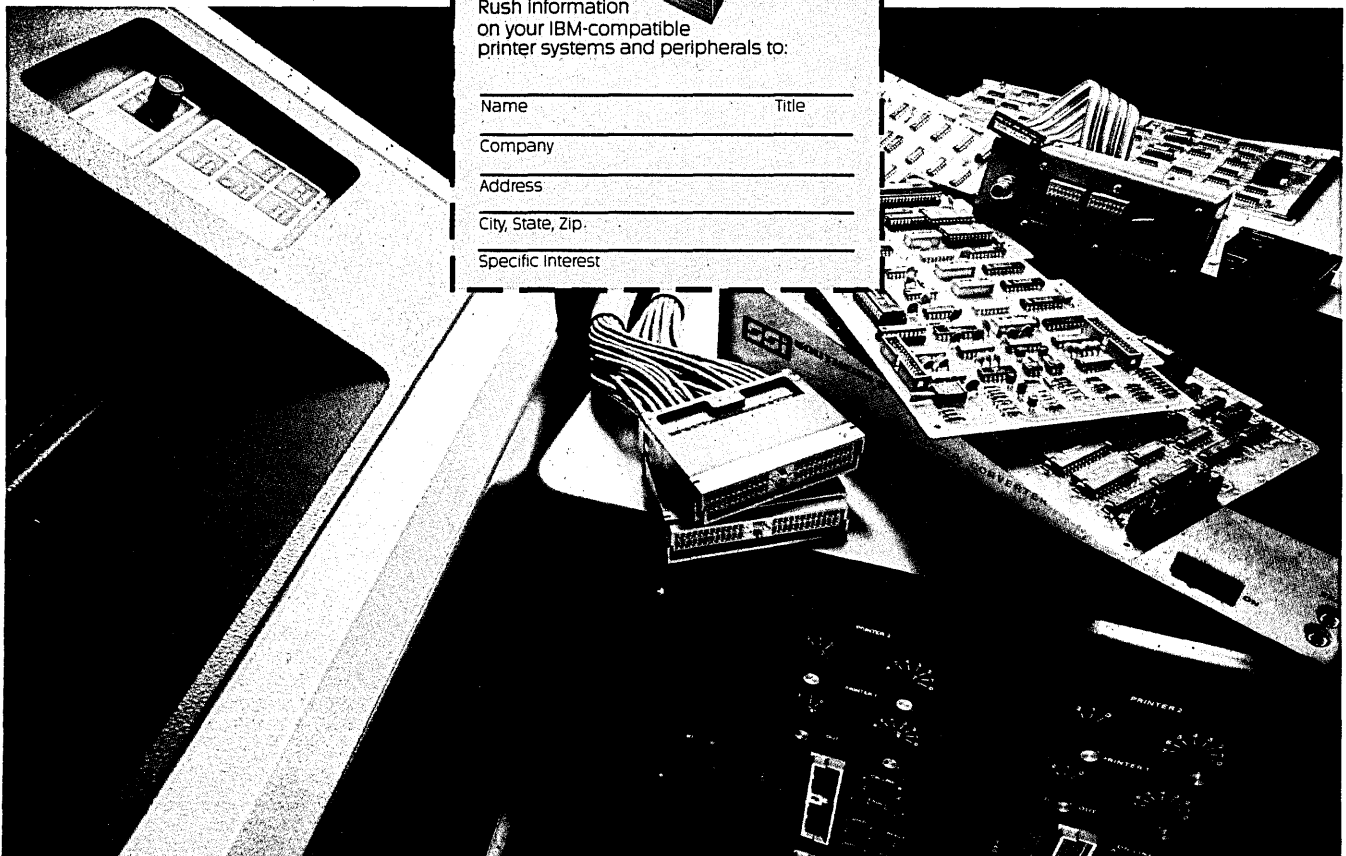

CIRCLE 96 ON READER CARD



CLEAR YOUR DESKS FOR THE PERSONAL TERMINAL BOOM.

Introducing a desktop revolution. The Personal Terminal from TeleVideo®—a compact new terminal for people who've forgotten what the finish on their desktops looks like. It isn't intimidating. It doesn't require programming knowledge. And it costs much less than a full-sized terminal. Clearly, the Personal Terminal will simplify the way your company works.

Want communications capabilities? Two RS-232 communication ports are standard equipment. An attached telephone option is available. And two optional, internal modems (300 or 300/1200 baud) put managers on-line with data services in seconds.

Want to expedite data retrieval? The Personal Terminal has 7 function keys (shiftable to 14) that reduce often-used commands to one key stroke. With a modem installed, those same keys can autodial up to 10 phone numbers. The built-in directory feature lets you autodial up to 18 more.

Send and receive electronic mail. Check inventory. Review sales and traffic figures instantly with the Personal Terminal. The 9-inch screen is easy to read. The professional keyboard is easy to use.

The Personal Terminal from TeleVideo. The desktop connection to a more intelligent, productive and cost-effective office environment. Isn't it time you got in on the information management boom?

Call us at 800-538-8725 for more information (in California call 408-745-7760) or contact your nearest TeleVideo office:

California/Santa Ana (714) 557-6095
California/Sunnyvale (408) 745-7760
Georgia/Atlanta (404) 399-6464
Illinois/Chicago Area (312) 351-9350
Massachusetts/Boston (617) 668-6891
New York/New Jersey (201) 267-8805
Texas/Dallas (214) 980-9978
France/Paris 33-1-687-3340
United Kingdom/
Woking, Surrey 44-9905-6464

GET IN ON THE BOOM.™

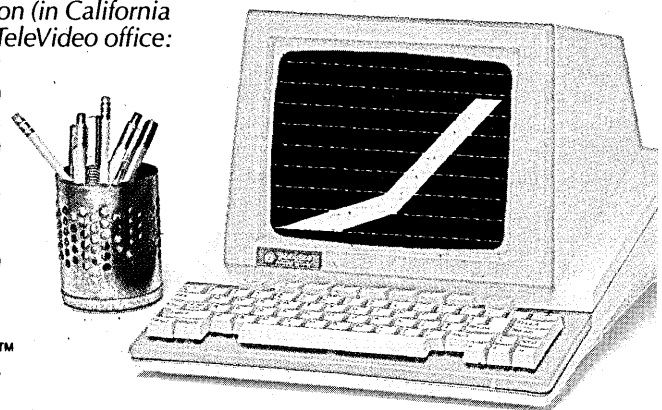

TeleVideo® Terminals

TeleVideo Systems, Inc.

CIRCLE 97 ON READER CARD

The Japanese feel they must close their software gap if they are to compete across the board with American systems manufacturers.

awesome numbers of five-inch and smaller fixed and floppy drives being built to work with personal computers and word processors are by and large being made by companies that became significant competitors only recently.

At the same time, however, for a company to remain successful in this business it must maintain the most sophisticated levels of manufacturing technology; it must use highly automated processes to produce extremely precise and reliable mechanisms at very low cost. As in the case of semiconductor manufacturing, high levels of capital investment are implicit, along with a high concentration of technical skills. High manufacturing volume is required if a vendor is to be profitable.

Once again, it may prove that the worldwide information industry can support only a limited number of disk drive manufacturers. At this point the pace of technological evolution makes it impossible to forecast who they will be or in which country they will be located. U.S.-based firms still retain the lead in both large and small magnetic disk drives, but Japanese manufacturers have improved their competitive position, and at several size levels Japanese disk drives are being imported to the U.S. in significant numbers. The optical disk market has yet to move out of its embryonic stage, so several European firms, perceiving that optical disk technology provides an opportunity to leapfrog the established American and Japanese vendors, have pioneered in optical disk manufacture. The optical disk may represent a growth opportunity for several information technology centers in Western Europe.

So far, national governments have generally confined their participation in the disk storage industry to the funding of research projects. Investments in new disk drive ventures have sometimes proved highly profitable, so private capital has been available, provided by established corporations in the U.S., Europe, and Japan, and by venture capital in the U.S. and to a lesser extent in Europe.

Wherever the manufacturers reside, it appears that in the disk storage area the pattern of international competition in the 1990s will be similar to that in the semiconductor area. There will be a relatively small number of highly refined manufacturers of disk drives, each capable of producing great volumes. System manufacturers in the various countries will then buy these industry-standard disk drives for incorporation into processing systems of widely varying designs.

Supercomputers. Supercomputers are high-powered processors with numerical processing throughput significantly greater than that of the largest general purpose computers.

FIG. 4

TRENDS IN DEVICE SPEED - STAGE DELAY PER GATE CIRCUIT

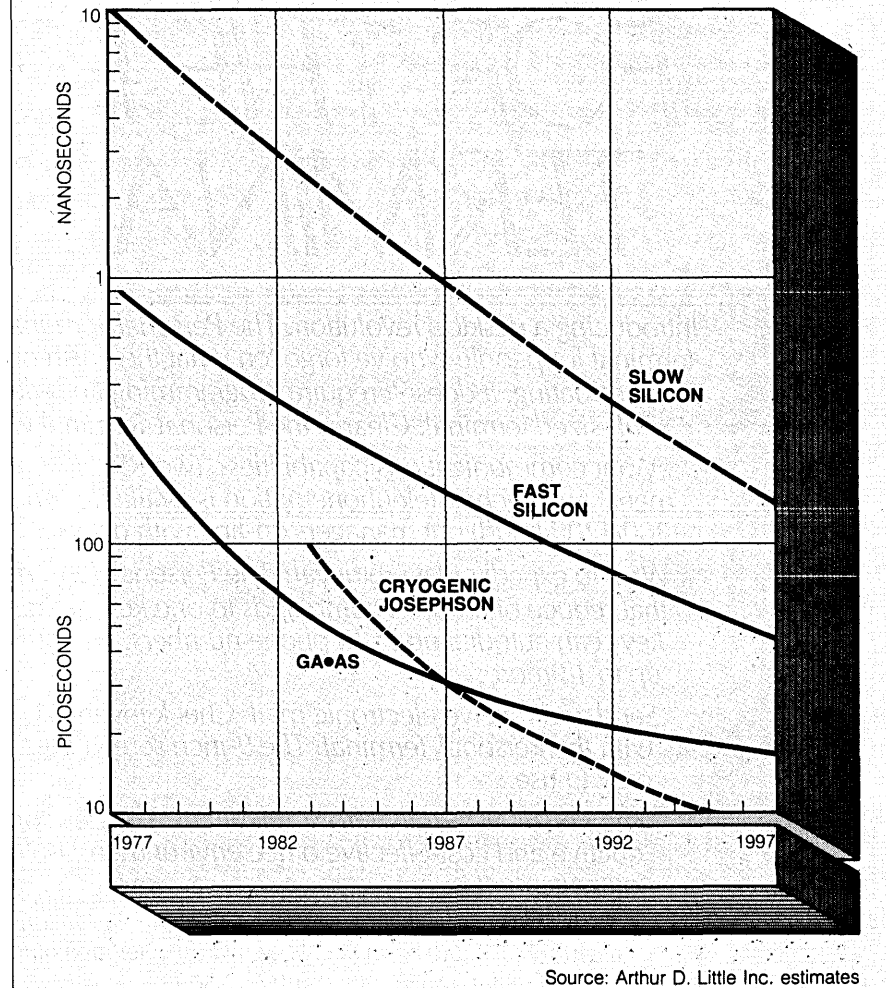

The definition of a supercomputer changes with time and the throughput capability of the largest general purpose systems. In 1983, supercomputers are systems that have a capacity approaching 100 million floating point operations per second (MFLOPS). This is maximum or burst mode capacity, not sustained speed.

It is important to define the term supercomputer with some care, because the popular publicity given to the Japanese fifth generation computer project tends to lump together all development projects for advanced computers, even though they differ widely. Japanese research plans make no such mistake: funding and research project structures are entirely different for supercomputers and fifth generation systems. The fifth generation project is at the basic research

stage, but supercomputer development is at the stage of final system designs.

JAPANESE SPEED RACE

Japanese companies have been one-upping one another in setting supercomputer speed objectives. In July 1982 Fujitsu announced a machine it claimed would be capable of 500 MFLOPS. Two months later Hitachi announced a machine rated at 630 MFLOPS. Most recently, in May 1983, NEC announced a machine intended to run as a single processor at a speed of 700 MFLOPS, and as a dual-processor system with a speed of 1300 MFLOPS. This would exceed the speed of the Cray 2 computer announced earlier this year, which is expected to reach 1000 MFLOPS. (It should be noted that this horsepower race is largely an

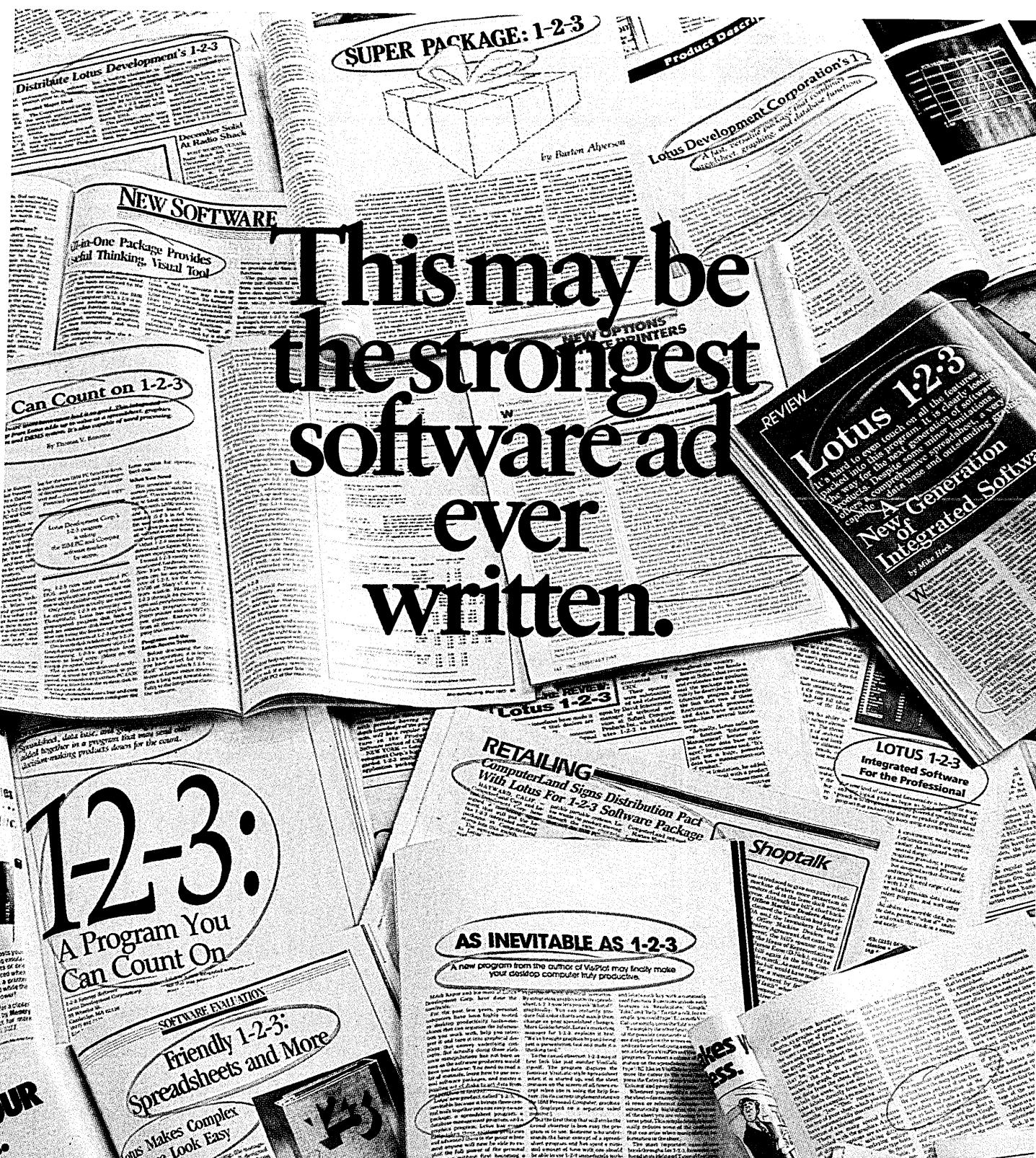

This may be the strongest software ad ever written.

1-2-3:
A Program You Can Count On

Friendly 1-2-3:
Spreadsheets and More

AS INEVITABLE AS 1-2-3

A new program from the author of VisiPlot may finally make your desktop computer truly productive.

Lotus 1-2-3
New Generation Integrated Software

LOTUS 1-2-3
Integrated Software For the Professional

Maybe, because we didn't write it. In fact, it was written by some of the most respected business and computer analysts in the country. And some of the most critical.

So when we tell you that 1-2-3™ from Lotus™ is the most powerful productivity software ever developed for PC's, you don't have to take our word for it.

You can take the word of our critics.

And after you read their comments about the attributes of 1-2-3, we think you'll understand what's causing all the excitement.

If you'd like to see what 1-2-3 can do for you and your business, just visit your nearest computer dealer. Or call us at 1-800-343-5414 (In Mass. call 617-492-7171).



The hardest working software in the world.

1-2-3 and Lotus are trademarks of Lotus Development Corporation. All rights reserved.

The modular nature of both supercomputers and general purpose systems may lead to new patterns of competition.

abstraction: none of these machines is ever likely to reach its full rate of speed on any practical problem, and these are manufacturer announcements of intent rather than demonstrated performance levels.)

The speed of supercomputers has always been constrained by the degree to which the problems to be solved can be broken into parallel elements for simultaneous computation, because linear processes are constrained by the speed of the best components available. While these will improve 20-fold, there are customers who would like much greater improvements in computing speed. Their only hope lies in using multiple computing elements in parallel, but many important problems insist on remaining linear. Thus, mathematical algorithm and software development are intertwined with component and architectural development in the design of future supercomputers.

HYBRID SYSTEMS RESULT

It appears that the result will be hybrid systems, in which portions of an overall computational problem are converted into parallel form for processing in a specialized processor (at speeds of as much as 100,000 MFLOPS by 1997), while the remaining portions of the job—including I/O, file reference, and scalar processing—remain separate and are delegated to functional processors optimized for each purpose. The functional processors are interconnected by data and control buses, and the complex operates under control of a supervisory processor.

Fig. 6 schematically depicts such a system, with the "specialized processor" corresponding to the parallel processor of the supercomputer. Fig. 6 is labeled "Future General Purpose Computer System" rather than "Future Supercomputer System," because in fact we expect this type of modular design to be universal. In a supercomputer application, the general purpose computer system of Fig. 6 would be equipped with a powerful specialized processor and relatively limited I/O and file storage processors. The application processors might be a mere set of generalized microprocessors for scalar and control functions. In a batch processing or database application, however, the balance of size and capacity in the functional processors would be very different. The rather surprising conclusion we draw from this forecast, then, is that the supercomputers of the future will look very much like general purpose computer systems, varying only in the mixture of different functional processor types employed.

As noted, Japanese manufacturers have recently made impressive strides in supercomputers. However, innovation in gen-

FIG. 5

DISK FILE STORAGE EVOLUTION

COST PER CHARACTER STORED
(CENTS PER CHARACTER)

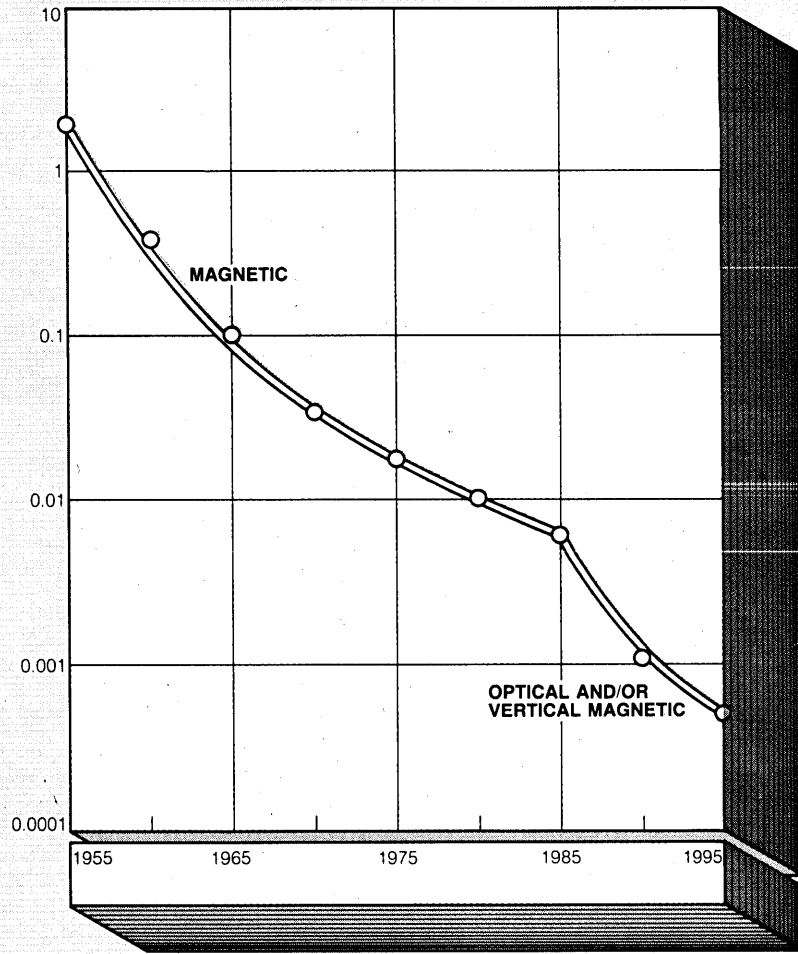

Source: Arthur D. Little Inc. estimates

eral purpose system architecture, in algorithms, and in software will be necessary to maintain a lead in the field, and Japanese technology has yet to demonstrate leadership in these areas. Japanese manufacturers in fact talk freely about their "software gap," which they feel they must close if they are to be competitive across the board with American systems manufacturers. At the moment, Japanese companies are gaining in the supercomputer race, but the American competitors are preparing their own countermeasures. These countermeasures—probably more innovative than recent Japanese products—may bring the leadership back to the U.S. in the late 1980s. In the meantime, there are British and French national supercomputer projects under way that call on the demonstrated soft-

ware competence in both countries. Japanese companies will be the supercomputer winners of the 1990s if they can close their software gap. Otherwise, there is a good chance that westerners will be able to push back the current Japanese surge.

Perhaps more important, the modular nature of both supercomputers and general purpose systems is likely to lead to new patterns of competition. If the bus interface protocol of a given manufacturer is known to others, or if it becomes a standard, others may become specialists in certain types of functional modules. For example, a British firm might make the file processor and a Japanese firm the parallel processor that an American supercomputer user would connect to the bus of his IBM general purpose system.

SURVIVAL OF THE FITTEST

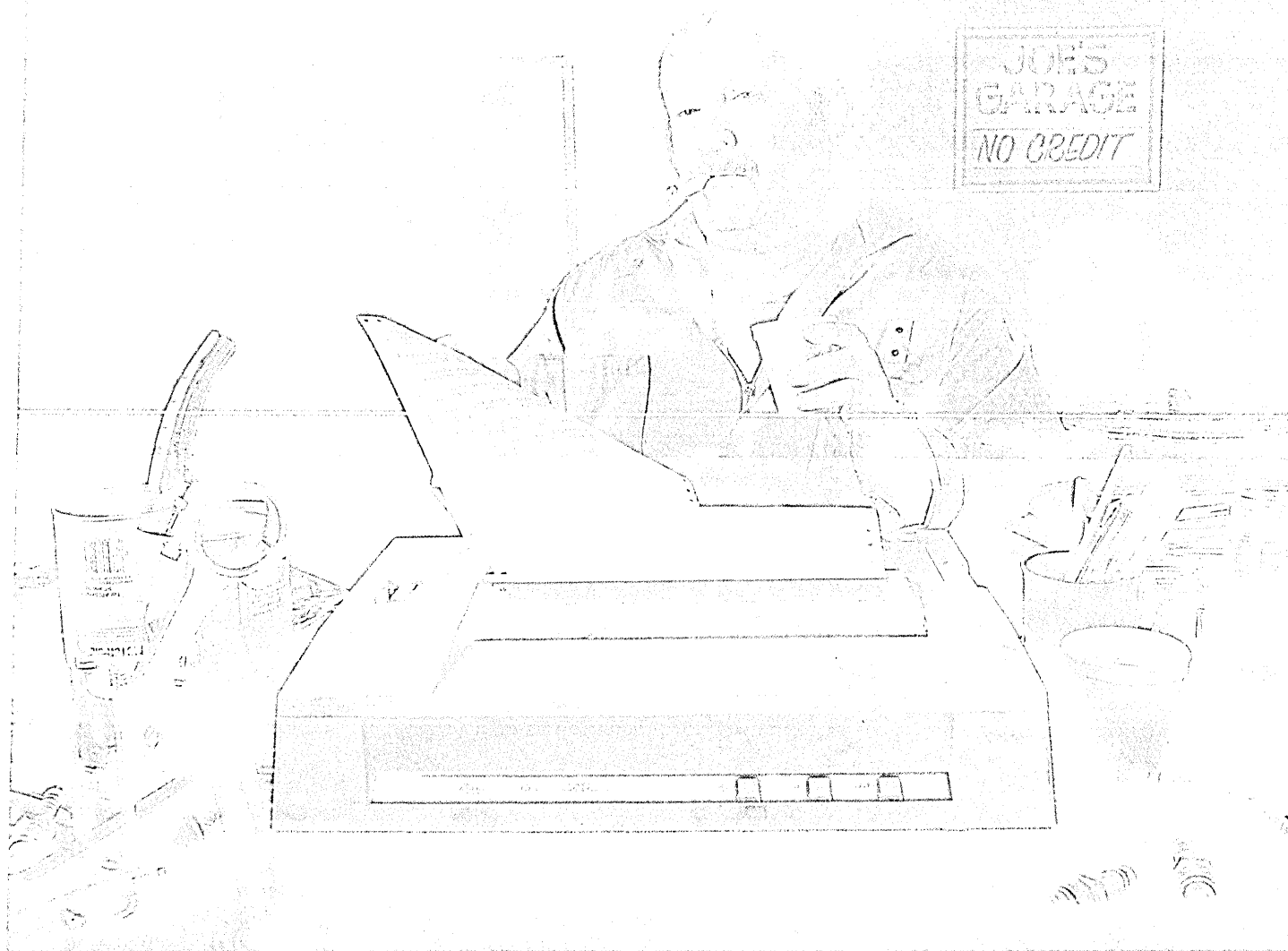

Ask major OEMS and they'll tell you that when it comes to reliable printers, the one they choose time and again is the C. Itoh 8510 Pro/Writer.

You see, many of today's printers achieve high speeds only by pushing their low-speed mechanisms to the limit of endurance. So what you seemingly gain in capabilities you lose in reliability.

C. Itoh's 8510 Pro/Writer, on the other hand, was designed from the very beginning to run at full speed (120 cps)—without breakdowns or noise. Its heavy duty stepper motor, base castings and synthetic ruby print head mechanism are built to take a lot of punishment, so you get superior print

quality throughout its 100 million-plus character life.

The 8510 also offers advanced paper handling features. You get bi-directional tractor and friction feed capability to handle paper widths from 4.5" to 10". Positive paper positioning for rapid bi-directional paper motion without short repetitive motions. Manual form alignment—even with power on. And a print line that can be easily

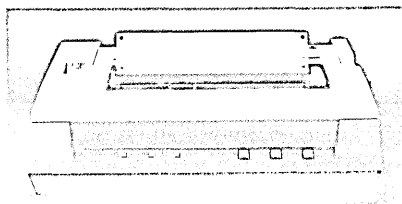

observed during printing.

Other features include built-in graphics with excellent resolution (144 x 160 dots per square inch). Five unique alphabets, eight character sizes. Mixed fonts during a single line pass bi-directionally. Variable form length, 6-channel electronic vertical formatting. The list goes on and on.

It's no wonder that so many major OEMS have selected the 8510 Pro/Writer design as their standard printer.

They know that in the real world, only the fittest survive.

For full details contact:
Itoh Electronics, Inc., Dept. 100
Foothaven Street
CA 90004 • Tel: 909/395-1000

CITOH ELECTRONICS

A world of Quality

CIRCLE 99 ON READER CARD

**WITH DATA GENERAL,
YOU WON'T BE
A PRISONER
OF YOUR IN-BOX.**

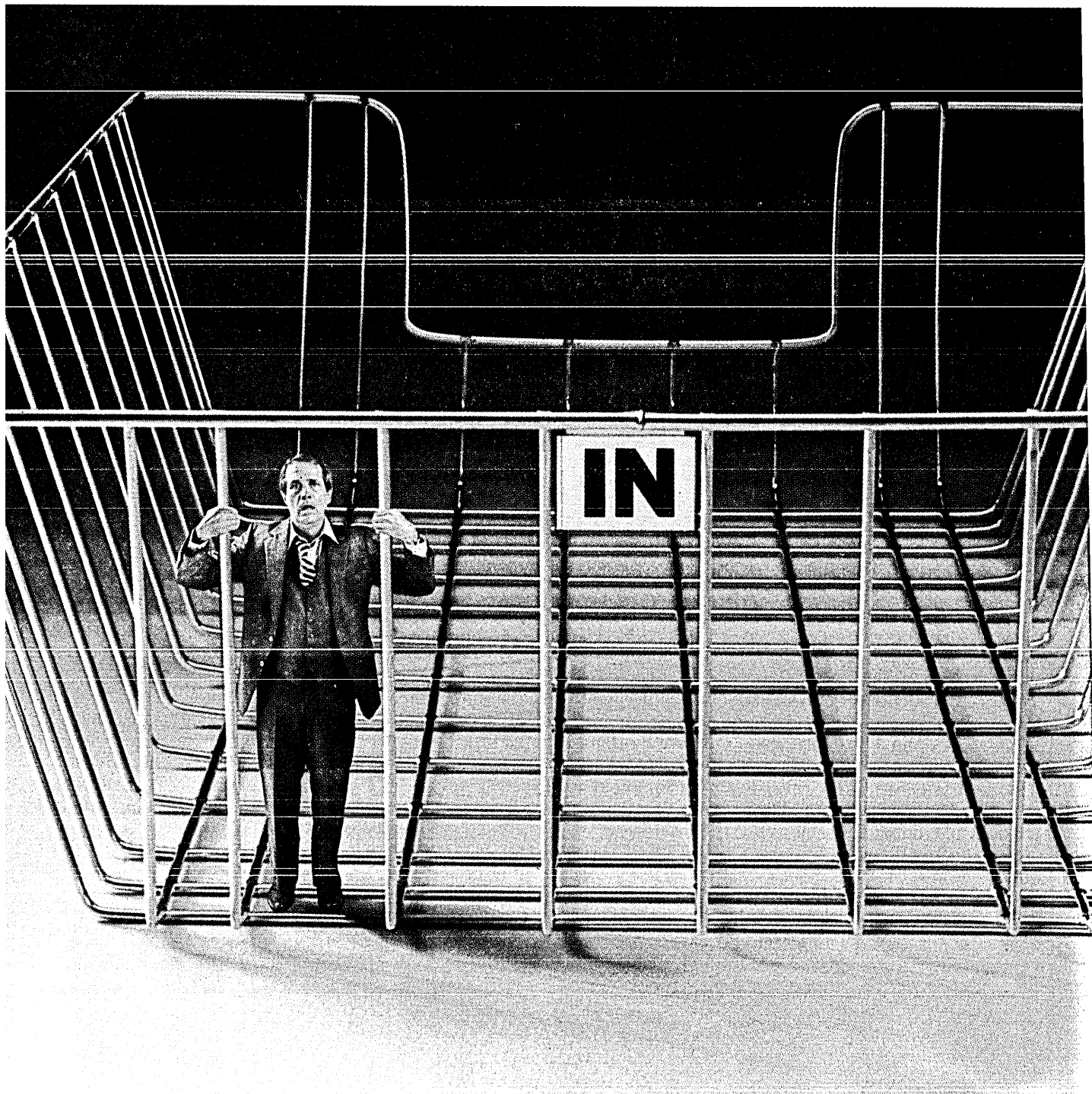

DATA GENERAL INTEGRATED OFFICE AUTOMATION.

Burying information under a ton of mail at the bottom of your in-box is not the best way to get it when it's critical to a decision.

ELECTRONIC MAIL

With Data General's CEO® Comprehensive Electronic Office, information is delivered electronically. Instantly. Unerringly.

It includes a "certified mail" feature that lets you confirm that it has been seen by the intended party. And an "urgent" signal that flags important messages.

But that's only the beginning.



TOTAL OFFICE AUTOMATION

The CEO system automates just about everything in your office. CEO electronic filing files the way you do. Its electronic calendar keeps tabs on trips, appointments, and meetings—even confirming them all.

Of course, CEO includes easy-to-use word processing. And all this is integrated with data processing for total decision support.

CEO even has an exclusive button that lets you handle typical interruptions, and returns automatically to where you left off.



DON'T DUMP YOUR EXISTING EQUIPMENT

Best of all, instead of having to dump your existing equipment to automate your office, you can build the CEO system around it.

Because it not only ties in with other Data General computers, but it also ties in with the most widely-used mainframe and word processor.

Instead of just a series of personal computers, each CEO workstation becomes part of a global network, with access to data from IBM mainframes.

Now that's protecting your investment.

AS LITTLE AS \$5,000 A WORKSTATION

And with the CEO system, the cost per workstation can be as low as \$5,000, depending on application.

CALL NOW

For more information on office automation that's a generation ahead, call: **1-800-554-4343, Operator 04A** or write Data General, M.S. CEO 04A, 4400 Computer Drive, Westboro, MA 01580.

 **Data General**
a Generation ahead

National governments will be among the winners in the fifth generation. This may mean private companies and users will be among the losers.

Small, specialized competitors would have multinational opportunities.

Given the widespread belief that a position in supercomputers is important to national security, most major national governments can be expected to fund supercomputer R&D. In the U.S., such funding has so far been limited to circuits and basic research in architectures, but there is agitation for more directed projects. It is not so clear, however, that the supercomputer market is large enough to provide satisfactory profits for many established and new competitors. It may prove necessary for governments to provide subsidies to otherwise nonviable supercomputer manufacturers. But government subsidies usually portend ponderous planning and slow innovation. If general purpose and supercomputer architectures are to converge into the modular system described above, slow innovators cannot compete for long.

Knowledge-based or problem-solving systems. Fig. 7 summarizes an official description of the proposed Japanese fifth generation computer.² A comparison of Fig. 7 with Fig. 6 shows how different the proposed fifth generation architecture is from even advanced versions of general purpose architecture. In fact, the fifth generation architecture really is not an architecture at all in the conventional sense. It is, rather, an expression of a set of functions that the developers hope to distribute within some as-yet-undefined set of modules. Fig. 7 refers to several different technologies. Very large-scale integrated architecture is the subject of the semiconductor forecast presented earlier. Except for the interface technologies, most of the rest are associated with the concepts of the so-called knowledge-based or problem-solving systems. In their various forms, these systems consist of three basic building blocks that together make up a new approach to the solution of complex problems. The three building blocks are:

1. The knowledge base. This is a body of expert or agreed knowledge about a particular subject. This knowledge typically is represented in one of several formal ways: by if-then logical rules; by frames or scripts (the expectation of the evolution of events expressed by natural language); and as mathematical formulas (or in some other structured way).

2. The context data. This is the information that is built up by the system about each particular situation in which a problem arises.

3. The inference engine. This is the computer program that provides the strate-

² "International Conference on Fifth-Generation Computer Systems," JIPDEC Report No. 49, Japan Information Processing Department Center, March 1982.

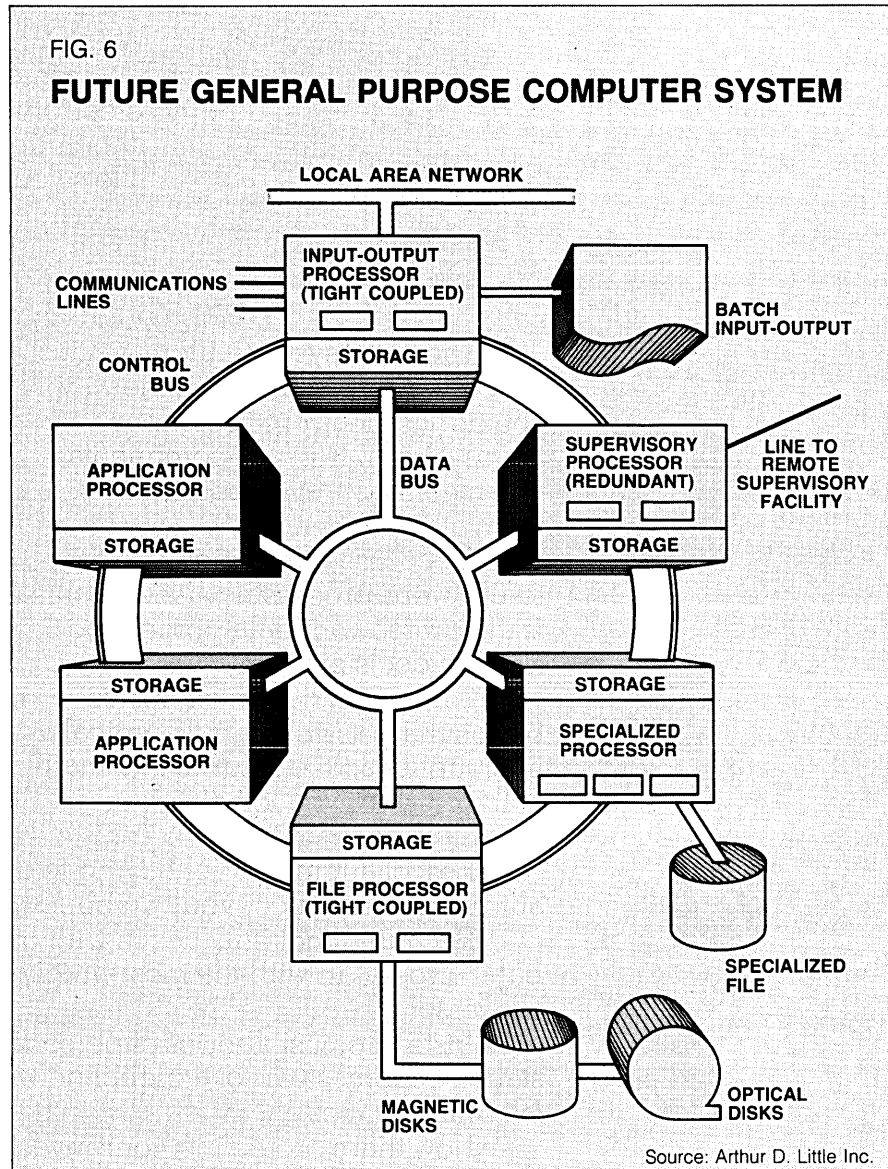

gies to draw inferences and produce solutions to the problems under analysis. Such computer programs are specifically tailored to accommodate particular "knowledge representation" formats and also include facilities for user-friendly dialogs. The inference engine usually operates in two ways. First, it draws inferences about a situation as it is being presented; questions are generated automatically and are asked of the user. Second, the inference engine presents to the user the logical reasoning behind the solution it generates and any underlying insights or general advice that may be of use.

These three building blocks are all software, so they can be developed to run in conventional computer systems. The characteristics of the processing (relational, parallel), storage (very large, slow), and control

(pointers, stacks) imply, however, that specially developed hardware may be desirable.

Before the usefulness of an inference engine can be established, a realistic knowledge base and context data must be developed for it. Hundreds or even thousands of definitions and relationships need to be established. Typically, two man-years of effort are required before even a demonstration model of a problem-solving system becomes operational. Proponents hope that a problem-solving system, once built, will be used by many people operating in a similar professional area. Pessimists think use of the systems will be limited to their authors.

The potentials of problem-solving systems are very interesting, but they will develop slowly and only for discrete subject areas. They will probably not even be a sepa-

THE NEWEST FEATURE ON THE 3000 FAMILY OF PRINTERS IS OUR NEW NAME.



GENICOM 3404

Our 3000 family of printers has an impressive list of features. But the most prominent new change on our printers is our new name.

Formerly the Data Communication Products Department of General Electric, we're now independently owned...and our new name is Genicom.

So the GE 3000 family is now the Genicom 3000 family. But while the name has changed, the product retains its established superiority.

The Genicom 3000 series of output printers still features speeds from 40 to over 400 cps. Single or dual mode printing. Type quality from EDP to NLQ. Multi-color printing. Graphics. Selectable type fonts, American craftsmanship and more.

Genicom 3000 printers will be as popular as ever with end users as well as OEM's, distributors, retailers and dealers...thanks to our list of outstanding features, plus the unique commonality advantages of several models all based on a single design.

And Genicom will also offer other products including our 2000 teleprinters and the soon to be introduced 4000 shuttle matrix printers. You'll find we have the same complete product line we had with GE.

Genicom. We have proven products, experienced personnel, established manufacturing facilities, a nationwide service network, plus a new commitment to excellence that stands behind our new name.

Genicom Corporation, One General Electric Drive, Dept. M311, Waynesboro, VA 22980. In Virginia, call 1-703-949-1170.

GENICOM

For the solution to your printing needs call
TOLL FREE 1-800-437-7468

CIRCLE 101 ON READER CARD

Winners will be the firms that mix software creativity with patience and realistic market perceptions.

rate product category but rather a set of discrete software products and specialized processors that will work with modular, general purpose systems. At a minimum, there will be market opportunities for specialized software and hardware firms; there are some already. At a maximum, problem-solving systems will cause a major evolutionary change in the nature of general purpose systems, but probably not a total revolution.

Winners will be the firms that mix software creativity with patience and realistic market perceptions. Massive research projects do not seem as necessary as long ones. So far in the industry's history, such firms have appeared mostly in the U.S. and the U.K. It would be ironic if the major success of the Japanese fifth generation project were the stimulation of a variety of small Western firms that end up with most of the market. So far this seems to be the way to bet, but it's very early. After all, the whole point of the fifth generation project is to change history.

FIFTH GEN INDUSTRY STRUCTURE

Much of the industry's future hardware seems likely to be built by specialized module vendors operating on a worldwide scale. Some of the hardware, such as display modules and printers, already is. Joining the list in the future will be "raw" integrated circuits for local customizing, disk drive modules, and specialized functional processors. System manufacturers will, of course, build at least some of their own processors, but none is likely to build all the types of processors their customers want.

Software is already provided largely by specialized vendors. In this era of personal computers, even system control programs, once the system manufacturers' exclusive domain, are coming from specialists. It is not certain how much of the software market will prove to be multinational, however, since variations in language, law, and custom affect most software. At least some system control programs and problem-solving systems in professional fields, such as CAD, will surely be sold worldwide.

System integrators must procure and assemble hardware and software modules that meet their customers' needs. These system integrators will have to serve small and large businesses, government agencies, schools of all types, professionals, and consumers. Some will be small and local, perhaps operating cooperatively; some will specialize worldwide in a generic type of system (for example, semiconductor CAD); some will even be in-house, integrating systems to meet the needs of the various users in a large organization. The structure of the system integrator industry and the role of the established computer manufacturers in it may be a very

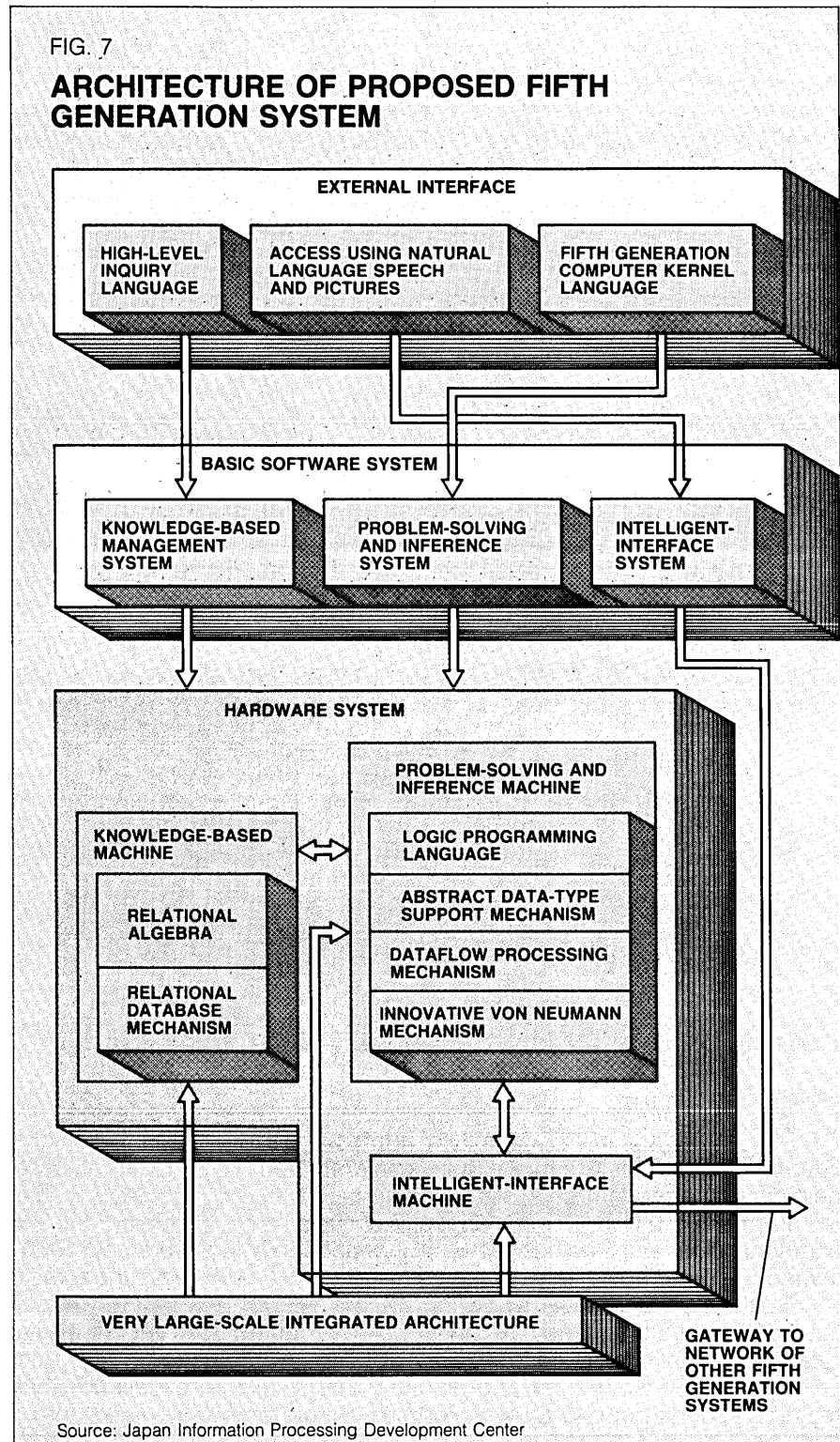

new one in the future.

Besides dealing with system integrators, customers will deal with communications service suppliers. The two will interact: the nature and cost of available communica-

tions will influence the customer's choice of systems, and the communications supplier will often be selling systems. In every country but the U.S. and Canada, the communications supplier is the national government,

which complicates the competitive picture.

National governments will play important roles in the structure of the fifth generation computer industry, whether laissez-faire capitalists like it or not. They will sponsor shared R&D projects in new technologies likely to strengthen local industries. Particularly favored will be long-range technologies such as knowledge-based systems where the profit potential is judged too remote to attract enough private investment.

Less favored will be technologies that are attracting what the planners feel is an adequate level of private funding, such as disk storage technology. It follows that many of the jobs in long-range and highly innovative research will be connected with national governments.

Governments will subsidize or own manufacturing companies making products deemed important to national security but inadequately profitable to attract sufficient private funds. Manufacturers of commodity memory and gate array chips are likely to be among these, and perhaps manufacturers of disk drives, though these are more likely to remain private. Some system manufacturers, such as supercomputer makers, will also be government controlled. However, the continued fast pace of change in system architectures makes the prospect of typical government-controlled companies seem dubious.

Finally, government communications service suppliers will play an increasingly pivotal role in the industry, through regulation in the U.S. and Canada, and directly everywhere else. The services they offer and the rates they charge will limit the systems their citizens can use. More positively, they will of necessity be offering a wider and wider variety of end-user systems themselves, either directly or through local system integrators.

So, national governments will be among the winners in the fifth generation. This may mean that private companies and users will be among the losers. National governments will try to serve the national interest, which is often taken to mean protecting national industry. Restrictive policies are often used to discourage imports and favor local manufacturers. No country will offer a large enough market, however, to fully support competitive manufacturers of every kind of hardware and software module. Any national government that seriously impedes imports will only succeed in denying modern systems to its citizens, with a long-term penalty to productivity that will outweigh the short-term benefits of protectionism. The information industry of the fifth generation will be by its nature the most multinational in history. Let's hope backward-looking national governments don't stunt its growth, but

instead prove sufficiently enlightened to find ways for us all to be winners in the end. *

Ted Withington is a vice president of Arthur D. Little Inc. A longtime DATAMATION advisor, he has written four books and over 30 articles and papers.

Reprints of all DATAMATION articles are available in quantities of 100 or more. Details may be obtained by telephoning Mary Ann Hariton, (212) 605-9729 or by writing to DATAMATION, 875 Third Ave., New York, NY 10022.

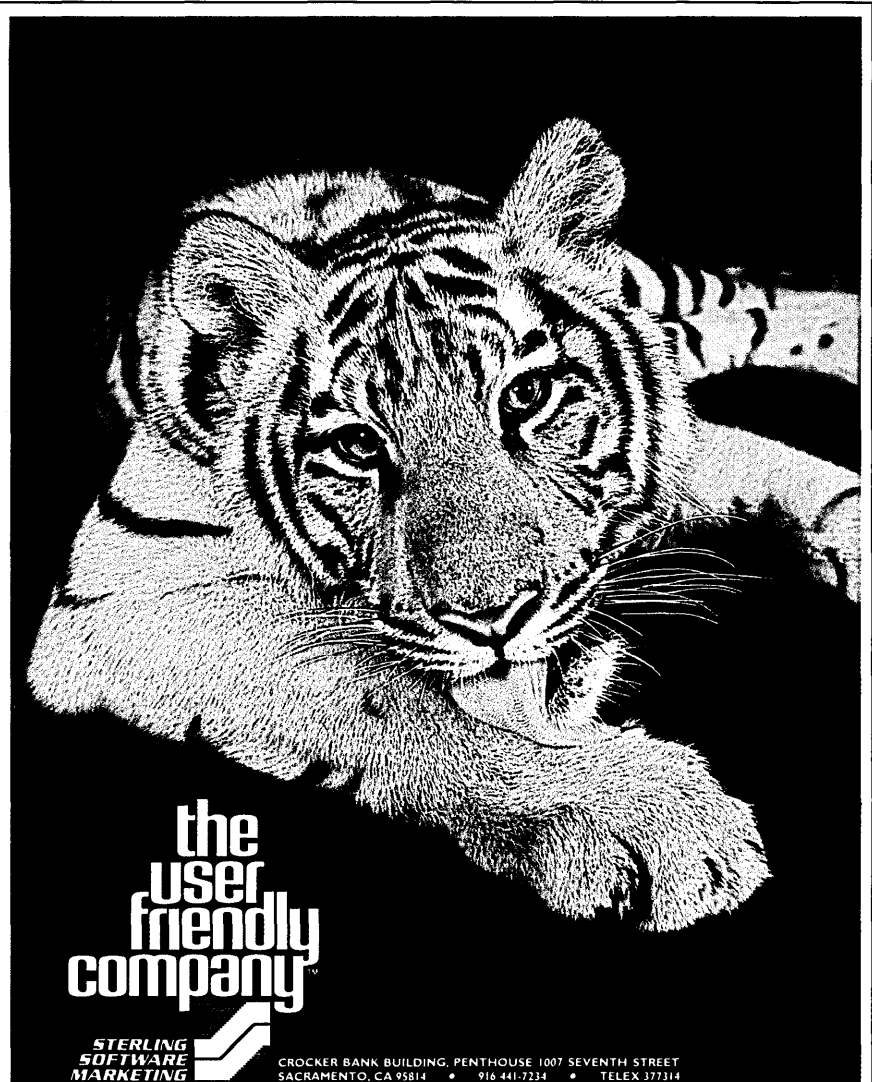

**the
user
friendly
company**

**STERLING
SOFTWARE
MARKETING**

CROCKER BANK BUILDING, PENTHOUSE 1007 SEVENTH STREET
SACRAMENTO, CA 95814 • 916 441-7234 • TELEX 377314

Over the past decade we have strived diligently to maintain your confidence in SMM as a reliable service-oriented software company. As our growth continues, we intend to ensure our capability to maintain your trust and your confidence in the products we present. So, we are proud to now be part of the Sterling Software group of companies.

Our new association, and our new name — **STERLING SOFTWARE MARKETING** — will continue to keep us on the leading edge in marketing high-performance software products. You can be assured that, although we may have a new name, our customer policy remains unchanged...

"Where Service and Software Come Together."®



SMM (UK) • 177A HIGH STREET • BECKENHAM, KENT BR3 1AH • 01-658-7233 • TELEX 922201 SMMUK G
SMM/GMBH • AM WEHRHAHN 17 • D-4000 DÜSSELDORF 1 • 0211/16 10 08 • TELEX 8587811 SMM D

CIRCLE 102 ON READERCARD





**THIS IS ONE FORM OF
REAL TIME SCHEDULING.**

OUR SOFTWARE IS ANOTHER.

Our ADC2, Automated Data Center, is innovative, non-traditional software that manages critical components of IBM's MVS computer operating system.

ADC2 is a real-time job scheduler, and monitor of job and system performance. It dynamically gathers job performance statistics and maintains this information as current and historical data for on-line access. ADC2's innovative approach takes unique advantage of IBM's MVS subsystem architecture.

And, of course, ADC2 is very user-friendly. It easily builds schedules and accesses all the information you need to insure increased throughput under the most demanding of circumstances.

ADC2 also allows scheduling to be decentralized: different departments and remote sites can develop their job schedules with simple commands.

ADC2 is so simple, so quick and so good, that while other job scheduling systems typically require 6 to 18 months of pre-planning and data entry before actually going to work, ADC2 can be productive the very same day it's installed.

For a demonstration of ADC2 or further information on the Cambridge A**2 family of high performance software systems, we invite you to call Shawn McLaren direct: 415/941-4558.

He'll be glad to tell you about a software system that allows you to schedule jobs in calmer waters.

The Cambridge Systems Group



24275 Elise, Los Altos Hills, CA 94022, U.S.A., (415) 941-4558 • Telex 357437
London Paris Munich

CIRCLE 103 ON READER CARD

The dp manager's mandate is to reconcile opposing factions and build an information architecture that will endure.

THE POLITICS OF SYSTEMS

by Samuel H. Solomon

Mr. Peters, vice president of information systems at XYZ Industries, had just finished telling a guest about the major systems in development for various departments in the firm. In particular, the marketing information system was a source of great pride because it was to be completed the next month both on time and within budget.

Just then, Peters received an interoffice memorandum from the marketing department announcing the formation of a Decision Support Systems group. Peters tried to disguise his surprise and confusion as he read the memo; then he escorted his visitor to the door and contemplated his next move. Surprise turned to anger as he thought about the "successful" system about to be installed in this user's department. This was the first time Peters had heard of the project. He wasn't even sure what the director of marketing meant by the term "decision support system."

This hypothetical case may seem extreme, but it's representative of the problems many dp managers face as they struggle with the issues surrounding information systems. Peters had made sound purchases, was managing his people well, and was delivering the kind of MIS support XYZ seemed to want. Still, he was blind-sided by the DSS memo. The fact is that his failure was not technical or even managerial, at least in any traditional sense. It was a matter of politics.

The seeds were planted the day Peters joined the firm. The assurances of Johnson, senior vice president for administration, that Peters would really control information systems, and would have access to the right people, seemed adequate. But Peters allowed himself to be hired at the wrong level, by the wrong person. He went about his job without a clear-cut commitment from top management to an information systems plan, and thus was never entirely sure who his customers were or how they should be served. He didn't realize just how often systems and project decisions seemed to the other department heads to be pie-in-the-sky. It was a loss for XYZ as well as for Peters.

The very combination of the two

words—politics and systems—may strike terror in the hearts of technically oriented computer professionals who just want to get the job done. Yet, politics is the means by which most important decisions are made. While corporations can't handle issues via a two-party system, corporate politics can nevertheless create an atmosphere for debate and consensus. Furthermore, harnessing political forces is the only sure way to succeed in establishing a systems organization. The dp manager's political manifesto is roughly this: system successes have relatively little to do with completing the documentation and handover phase of the project. Managing the organizational process to support information systems and technology is the single most important success factor.

Peter Keen nicely summed up the situation in the January 1981 *Communications of the ACM* when he wrote that "information systems development is an intensely political as well as technical process; organizational mechanisms are needed that provide MIS managers with authority and resources for negotiation. The traditional view of MIS as a staff function ignores the pluralism of organizational decision making and the link between information and power. Information systems increasingly alter relationships, patterns of communication, and perceived influence, authority, and control. A strategy for implementation must therefore recognize and deal with the politics of data and the likelihood, even legitimacy, of counterimplementation."

DP AT A CRITICAL STAGE

Data processing is now reaching a critical stage in its political development. MIS departments are saddled with outdated information systems and support organizations based on an architecture of the '60s and '70s. System "usurpers," both within and outside the firm, have arisen to meet the demands of a changing business environment. During the '70s, the threat originated from timesharing firms; in the '80s, we see microcomputer retailers marketing information systems directly to end users. In addition, software vendors,

consulting firms, and self-proclaimed systems experts are diluting MIS's authority. Users, supported by increased computer awareness and the power of desktop computing, are demanding, and in many cases assuming, direct control of their dp requirements.

These phenomena raise a number of questions. Does the enterprise benefit from a multitude of disjointed attempts to implement information systems? Does it make sense to have decision support systems (from time-sharing to micros) technologically and organizationally separate from MIS? What are the risks and consequences of continuing this arrangement? Finally, what are the political moves that can prevent information systems from becoming business disasters?

For answers it's necessary to trace the dichotomy that has developed between operational and user-oriented systems. For the sake of convenience, we will use the terms MIS and DSS. By MIS we mean the systems and support facilities that capture, analyze, and report the basic operating and marketing information of the firm. These information systems were created at a time when technology was incapable of directly supporting decision makers' analytical needs. The information requirements of MIS and end users were not all that different; the problem was access. MIS normally comprised static (i.e., batch) systems and the bureaucracies necessary to safeguard production and data integrity. This MIS culture arose to fulfill what was believed to be its ultimate corporate objective: complete accuracy of all information flowing through its systems, and support of the basic production cycle. Definitely admirable goals.

DSS, by contrast, has as its ultimate objective not the absolute correctness of data and maintenance of the production cycles, but rather the ability to get answers fast. It came about as technology changed and users became frustrated with MIS's seemingly poor support of their business needs. DSS provides the responsiveness necessary to answer business questions before they become stale. The professionals in this group are business-oriented and in many cases lack a firm-wide information perspective. They have never wondered whether there is life after prototyp-

ILLUSTRATION BY IVAN POWELL



Managing the organization process to support information systems and technology is the single most important factor.

ing. You can observe this limited data perspective by looking at your organization's decision support systems and noting the degree of data redundancy. How many different employee codes are used outside the personnel department?

DIVISION HAS DEEPEMED

Consulting organizations and priests of DSS have deepened the division between operational and user-oriented systems. Playing on the territorial fears of end users and the project logjam of MIS, they advocate the development of separate systems and organizations. The various DSS seminars and conventions abound with self-congratulatory fervor and success stories. Rarely are the organizational issues addressed, or the operational nature of the information explored. To the applause of the attending software vendors, the seminars dwell on the skin-deep successes of stand-alone financial models and ad hoc database reports without bothering to explain how it all fits into the firm's information systems architecture.

This schism between DSS and MIS will continue to deepen until all parties realize

that, for the sake of the corporation, they need to capitalize on the strengths of both organizations. MIS, burdened with an aging architecture, must evolve from a programming shop to an information utility. DSS will provide the philosophy for quick response, prototyping, and decentralized programming within the end user's area. We must somehow bring the MIS organization, with its pristine objective of accurate and consistent information, to the desks of decision makers who require access to accurate information. There are more than a few technological problems to be solved before this can happen, but corporate management and information professionals alike will have to recognize that this process is, above all, a political one. It requires far-seeing managers, open-minded computer professionals, and participating end users. It is no small job, but it can't be ignored. In an era of diminishing resources, efficient marketing, and the shift to a service economy, effective management of information systems may make the difference between success and failure for the firm itself.

Where to start? At the top, by recognizing a basic fact of corporate life: management must be the catalyst of change. Man-

agement across the firm—corporate, MIS, and end users—is in this together, and its participation in developing and implementing a strategy for information systems will determine its degree of success. Information Resource Management must command the same level of attention, involvement, and respect as other major business areas. This will require a new breed of information executive who commands the respect of his business peers, is adept at corporate politicking, and understands technology and its impact on the firm's business.

One dp manager took a big step toward this position with a seemingly innocuous, but politically astute, decision. He discovered that the number one question asked by senior management about systems and technology had nothing to do with the efficiency of the current version of the operating system. It was, "What micro should I buy for my kid?" This became a great opening for the dp department to discuss technology, compatibility, user software, support, and, most important, the benefits of information integration. The simple question enabled us to establish rapport with management.

RAPPORT WILL BE ESSENTIAL

That kind of rapport is going to be essential, because without help from information professionals, corporate management will be utterly unable to cope with the frantic pace of technological change. The breakneck speed at which hardware and software have evolved over the past 30 years has repeatedly disrupted the rules followed by MIS professionals for systems development and support.

Systems that were developed during the '50s and early '60s, for example, were statistical and scientific in orientation and staffed with operations research professionals. These were the people who were called upon to implement and support the accounting and management systems of the '60s and '70s. In many firms, these systems are still the mainstay of MIS.

Now the game is changing yet again, with the move from centralized to micro-based distributed computing. In the past, the name of the game with central site, distributed data processing, or timesharing was control—someone could always turn the machine off. This made system development policy relatively simple. With micros, that kind of control is becoming a thing of the past; DDP has come to stand for disorganized data processing. Unless information professionals learn to work closely with top management to plan for the future, there will soon be no controls at all. Together they must:

- Analyze business needs and determine the firm's information requirements independent of technology.



CARTOON BY SID HARRIS

There's a side to the Wang PC that IBM would like you to ignore.

Maybe what puts the Wang Professional Computer ahead of the IBM PC is what's behind it.

Because at the back of the Wang PC is a series of system interfaces that can tie you into total office automation now. Integral links that let you access not only other Wang equipment, but even most popular databases and mainframes, including IBM.

The Wang Professional Computer also offers a variety of telecommunications options that can access everything from the Dow Jones News/Retrieval® service to electronic mail. And by simply adding word processing software, the Wang PC turns into the easiest-to-use word processor on the market.

Face to face, the Wang PC is superior to the IBM PC in speed, compatibility and ease-of-use.

Back to back, there's no comparison.

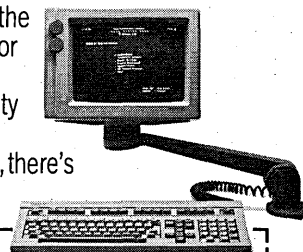
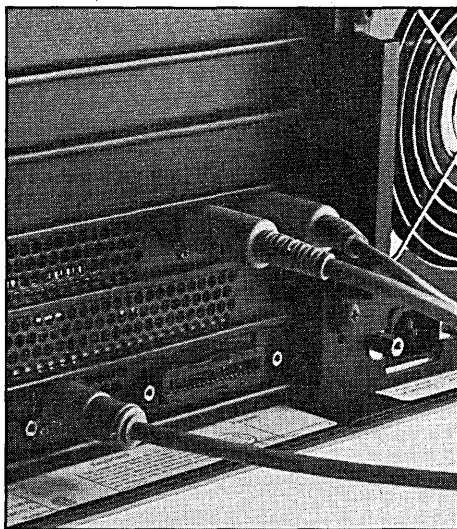

For a demonstration of the Wang Professional Computer, call 1-800-225-9264. Or send this coupon to: Wang Laboratories, Inc., Business Executive Center, One Industrial Avenue, Lowell, MA 01851.

Name _____		
Title _____		
Company _____		
Address _____		
City _____	State _____	Zip _____
() _____		
Telephone _____	DAB	



**The Office Automation
Computer People.**

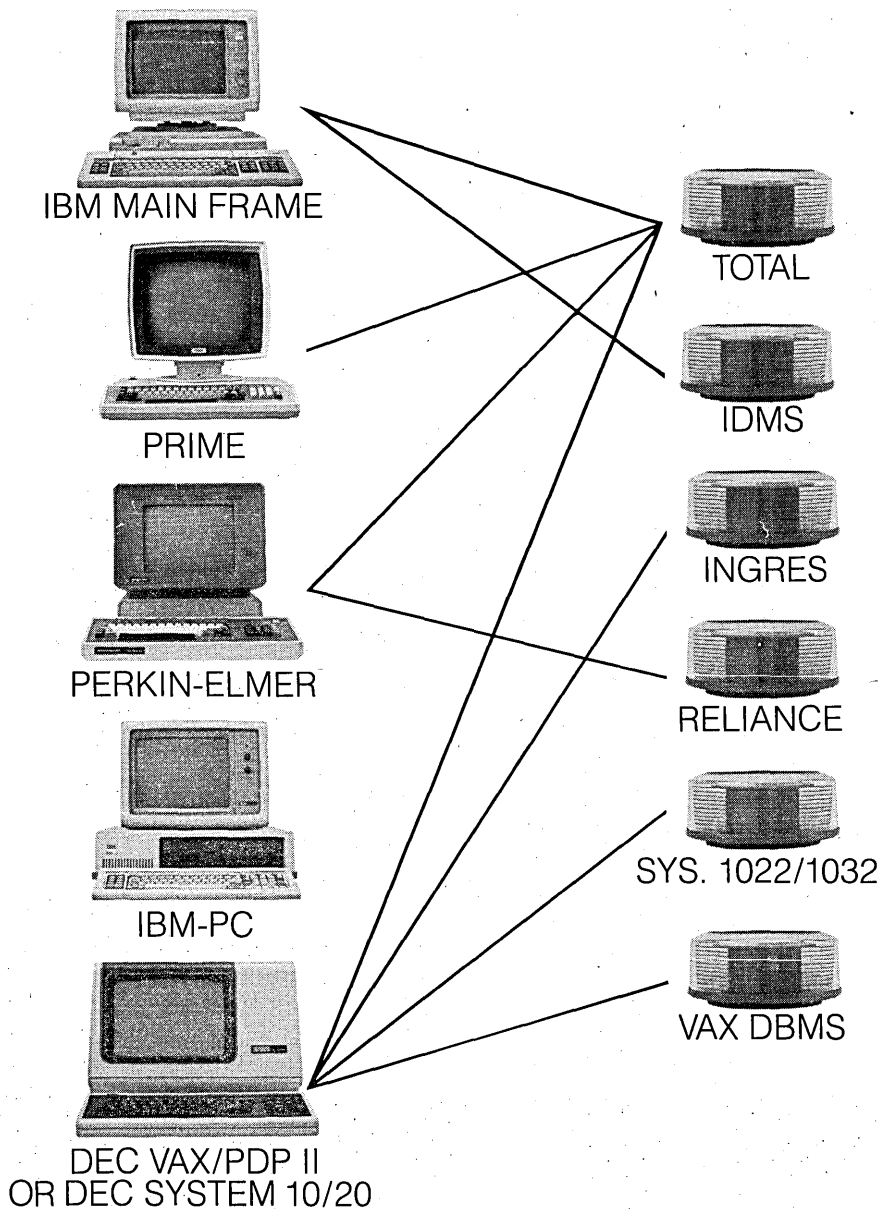

MIX VS.

No DBMS matches SEED for transportability. No DBMS offers you a wider range of hardware options now and for the future. Whether you opt for DEC, IBM, Prime, Perkin-Elmer or GOULD CSD.

And SEED lets you transport applications across machines—micro to main-frame or the reverse. SEED also provides the only compatible path from DEC 10/20 to IBM and VAX.

Because SEED is so transportable, it

enables you to standardize development efforts to increase programmer productivity. In short, SEED helps you get the most out of both your hardware and your human resources. And we back SEED with our own resources—a team of experienced professionals that gives you personalized, on-going support and service.

Seed Software, 2300 Walnut Street, Suite 734, Philadelphia, PA 19103.

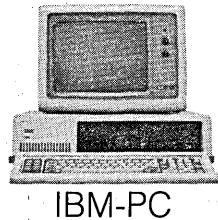
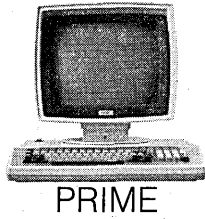
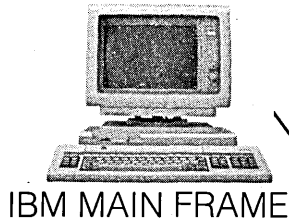

DEC VAX/PDP II
OR DEC SYSTEM 10/20



SEED DBMS

MATCH

Send for your **FREE SEED Information Kit** today. Get all the details on how SEED DBMS increases productivity for managers, programmers and end-users, and how SEED makes DBMS maintenance and operation

more economical. Send for the SEED DBMS Information Kit. It's yours **FREE**. D1283

Or call us at (215) 568-2424. And be sure to ask for information on our **FREE DBMS Seminars**.

Send me the FREE SEED Information Kit. Call me to discuss my specific requirements. Send me details on DBMS Seminars.

Name _____ Title _____ Company _____

Address _____ City _____ State _____ Zip _____ Telephone _____

OEM System Integrator End User

Computer _____ Oper. Sys. _____



UNITED INFORMATION SERVICES, INC.

SEED SOFTWARE, 2300 Walnut Street, Suite 734, Philadelphia, PA 19103

CIRCLE 104 ON READER CARD

Corporations must capitalize on the strengths of both MIS and DSS.

- Be adaptive in the application of technology to computing and the delivery of systems. There are no pat answers to technological questions—batch, timesharing, and micros may all be appropriate responses to a given situation.
- Keep in mind that, above all, systems exist to support human beings.

This last point is perhaps the most politically vital. It's worth restating: people, not systems, make successes. Now is the time for the renaissance computer professional—who knows how to market, understands the business environment, and has the technical know-how to get the job done. Since programming will eventually move to the user areas (except for "core," firm-wide systems), future MIS professionals and end users will necessarily be of a new breed. Users will need to be system savvy and MIS will evolve to a coaching and coordination role.

Skill in decentralizing a function will be very important. One firm is experimenting with a decentralized database management group to support a decentralized development organization. The concern was to avoid "queueing" at the database administrator's area by having the DBAs work for a specific development group. For this to succeed from

the firm's perspective, all the far-flung DBA groups are responsible to the firm's database manager. Furthermore, a robust data dictionary-driven database management system is required to coordinate the various groups.

LEARNING HISTORY LESSONS

There is no reason why MIS cannot learn the lessons of history and accept the best of traditional MIS and DSS to provide a responsive, business-oriented information utility while safeguarding the integrity of data and programs. To assume that by controlling programming resources one can control the computing environment of the firm is as foolish as wishing micros would just disappear. What is apparent is that the management of information, with technology providing the means, will give MIS organizations the ability to control the information and the computing requirements of a firm. We will see this organized as a centrally managed information group with decentralized application development by user departments, all staffed by a new type of systems/business professional. Most important, it is clear that new attitudes by management toward developing a firm-wide information strategy and architecture to support decision-

making will be essential.

The stakes are high now. Users armed with micros are in a better position to undermine MIS, to the considerable detriment of the firm. "On my Apple I can do this in five minutes" is the constant refrain heard from people trying to push MIS to do a three-month project in two days. On the other hand, dp can exacerbate the problem if projects are subject to the kind of scrutiny that's more appropriate for nuclear reactors. Finally, company management can always seem to be "just too busy." What it adds up to are roadblocks that must be removed to get the job done. The answer lies in having the political savvy to recognize obstacles early in the game and address them appropriately. *

Samuel H. Solomon is a vice president at a major New York investment bank. He is responsible for systems planning and database management and established the decision support organization. Previously, he was a principal at Corporate Management Systems and a manager of financial product development at ADP Network Services. He has an MBA in finance from New York University.

EASY TO LEARN. EASY TO USE.

FOCUS MAKES THE INFORMATION CENTER WORK.

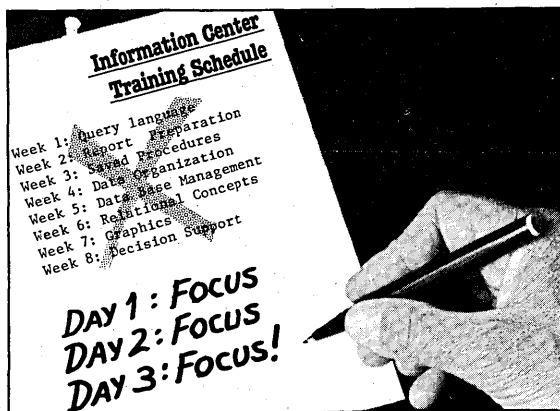

FOCUS

New York: (212) 736-4433
Washington, D.C.: (703) 276-9006 • St. Louis: (314) 434-7500
Chicago: (312) 789-0515 • Dallas: (214) 659-9890
Palo Alto: (415) 324-9014 • Los Angeles: (213) 615-0735

Implementing an Information Center? Don't spend endless weeks in product training—instead, INVEST three days and learn **FOCUS!**

FOCUS is the comprehensive 4th generation information management system that's powerful enough to build complete multi-screen DBMS applications, yet is easy enough for non-technical end users to generate their own ad hoc queries and reports. All after only three days training!

FOCUS' non-procedural English language and immediate online error correction makes learning a snap. And while you are requesting reports, graphics and other data analyses, the data handling and access is being done for you... whether it is **FOCUS'** shared relational database or your existing files (VSAM, QSAM, ISAM) and databases (IMS, IDMS, TOTAL, ADABAS).

Get full details now. Learn why **FOCUS** is the leading product in 4th generation technology and the leading choice for Information Centers on IBM or compatible mainframes. Call the **FOCUS** representative at the office nearest you or write to Don Wszolek, Information Builders, Inc., 1250 Broadway, New York, New York 10001.

FOCUS is also available on a service bureau basis through Tymshare Inc.

CIRCLE 105 ON READERCARD

Do these tough demands blow your graphics apart?

1. Power & speed!

Dual processor power.
Rapid area fill and draw.

2. Simplicity & compatibility.

ANSI X3.64, TEK 4010, 4014
and 4027-compatible.

3. Full featured graphics.

Host graphics support and
terminal primitives.

4. Dot addressability.

Vector drawing and point plotting.

5. Brilliant raster color.

64 color palette.

6. Affordability.

\$1995*

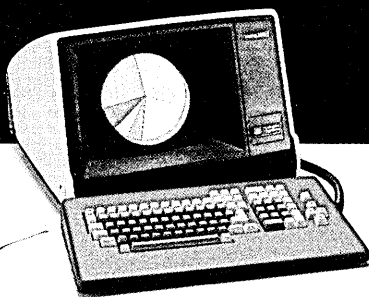

PRICE/PERFORMANCE BREAKTHROUGH! The new Intecolor 2427 advanced graphics terminal puts the pieces together.

Even managers explode, evaluating terminals to satisfy *all these demands*. And at a reasonable price.

Solution: Try the Intecolor 2427, for only \$1995.

Capitalizing on over 10 years of experience in the design and manufacture of color graphics terminals, Intelligent Systems has put it all together in the Intecolor 2427.

Check out the features. Compare the price. Then contact Marketing Communications at 404/449-5961. TWX 910 766 1581.

*Single-evaluation unit. U.S. domestic only. To evaluate the 2427 at this 100-piece price, your order must be received by 12/31/83. Single piece price is \$2695.



Intecolor®

AN INTELLIGENT SYSTEMS COMPANY
Intecolor Drive, 225 Intecolor Park, Norcross, Georgia 30092

1. Dual Processor Power: 16-bit Z8002 graphics processor for rapid area fill and polygon drawing. 8-bit 8085 independent alphanumeric terminal functions processor. Plus independent keyboard processor.
2. Convenience/Compatibility: Extended ANSI X3.64 control system with VT100 features. Integrated graphics and alphanumeric menu set-up. Compatible with TEK 4010, 4014, 4027 terminals and Plot 10. Interactive color graphics. Easy conversion to color.
3. Complete Graphics Capabilities: Supported by popular host graphics packages. Terminal resident TEK 4027-like graphics primitives. Full featured bit-map graphics.
4. Dot Addressability: Absolute addressing of points for point plotting with complex graphics. 560H x 288V. Full three-bit pixel array. 80 characters by 24 line alphanumeric display.
5. Raster Color: Brilliant 64-color palette with color mapping. Eight displayable colors. Self converging, 13" diagonal CRT.
PLUS: Enhanced Text Features: Five character sets (two are user-definable). Two vector character sets. **ANSI X3.64:** Industry standard control sequences. Easy to implement. **Two Full Pages of Screen RAM:** Simplifies graphics programming. **72 Function Keys (optional):** Speeds up programming. **Clean, Simple Design:** Assures reliability, cost efficiency. **VT100 Features:** Familiar DEC functions.

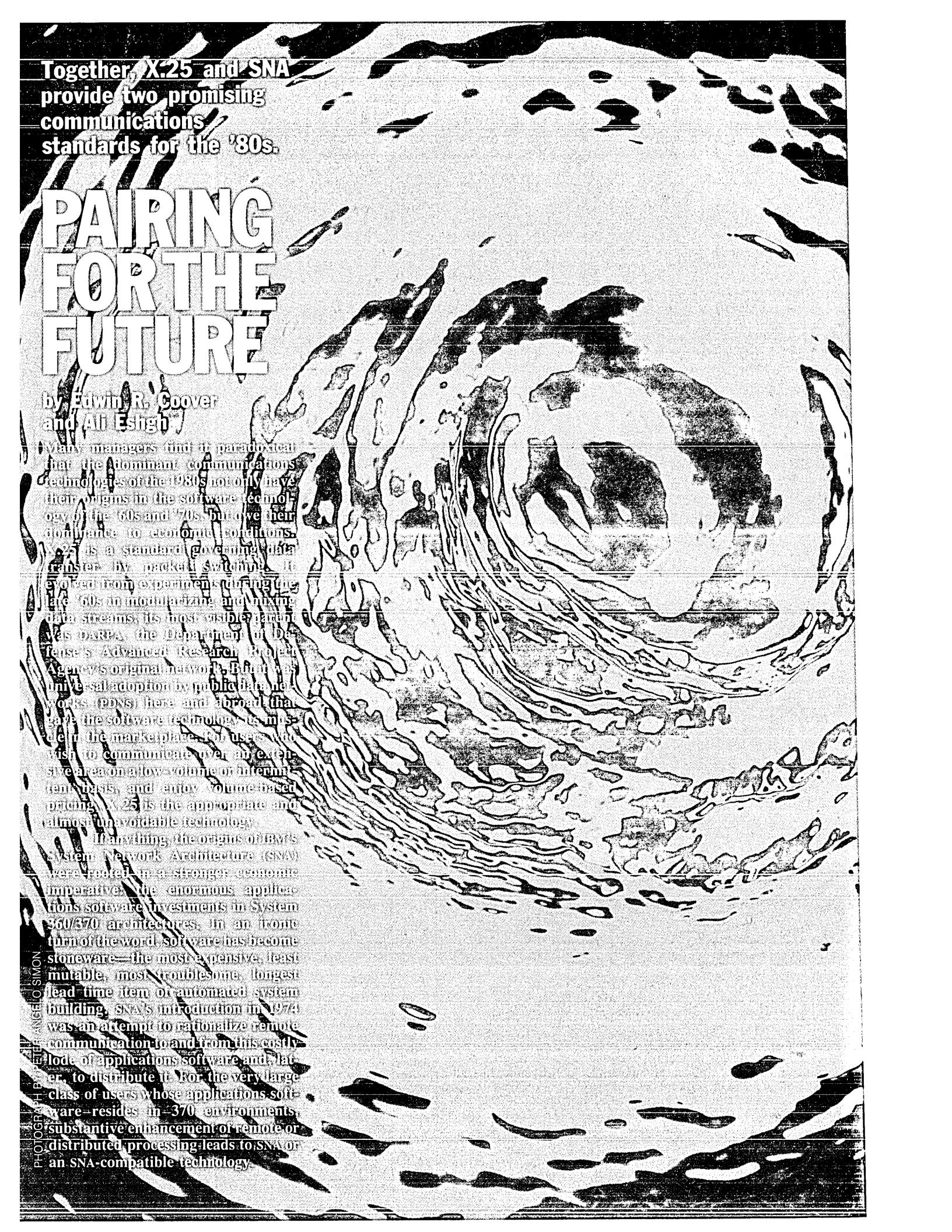

Together, X.25 and SNA
provide two promising
communications
standards for the '80s.

PAIRING FOR THE FUTURE

by Edwin R. Coover
and Ali Eshghi

Many managers find it paradoxical that the dominant communications technologies of the 1980s not only have their origins in the software technology of the 60s and '70s, but owe their dominance to economic conditions. X.25 is a standard governing data transfer by packet switching. It evolved from experiments during the late 60s in modularizing and mixing data streams. Its most visible parent was DARPA, the Department of Defense's Advanced Research Project Agency's original network, ARPANET, which was adopted by public data networks (PDNs) here and abroad that gave the software technology its impetus in the marketplace. For users who wish to communicate over an extensive area on a low-volume or intermittent basis, and enjoy volume-based pricing, X.25 is the appropriate and almost unavoidable technology.

If anything, the origins of IBM's System Network Architecture (SNA) were rooted in a stronger economic imperative: the enormous applications software investments in System 360/370 architectures. In an ironic turn of the word, software has become stoneware—the most expensive, least mutable, most troublesome, longest lead time item of automated system building. SNA's introduction in 1974 was an attempt to rationalize remote communication to and from this costly mode of applications software and, later, to distribute it. For the very large class of users whose applications software resides in 370 environments, substantive enhancement of remote or distributed processing leads to SNA or an SNA-compatible technology.

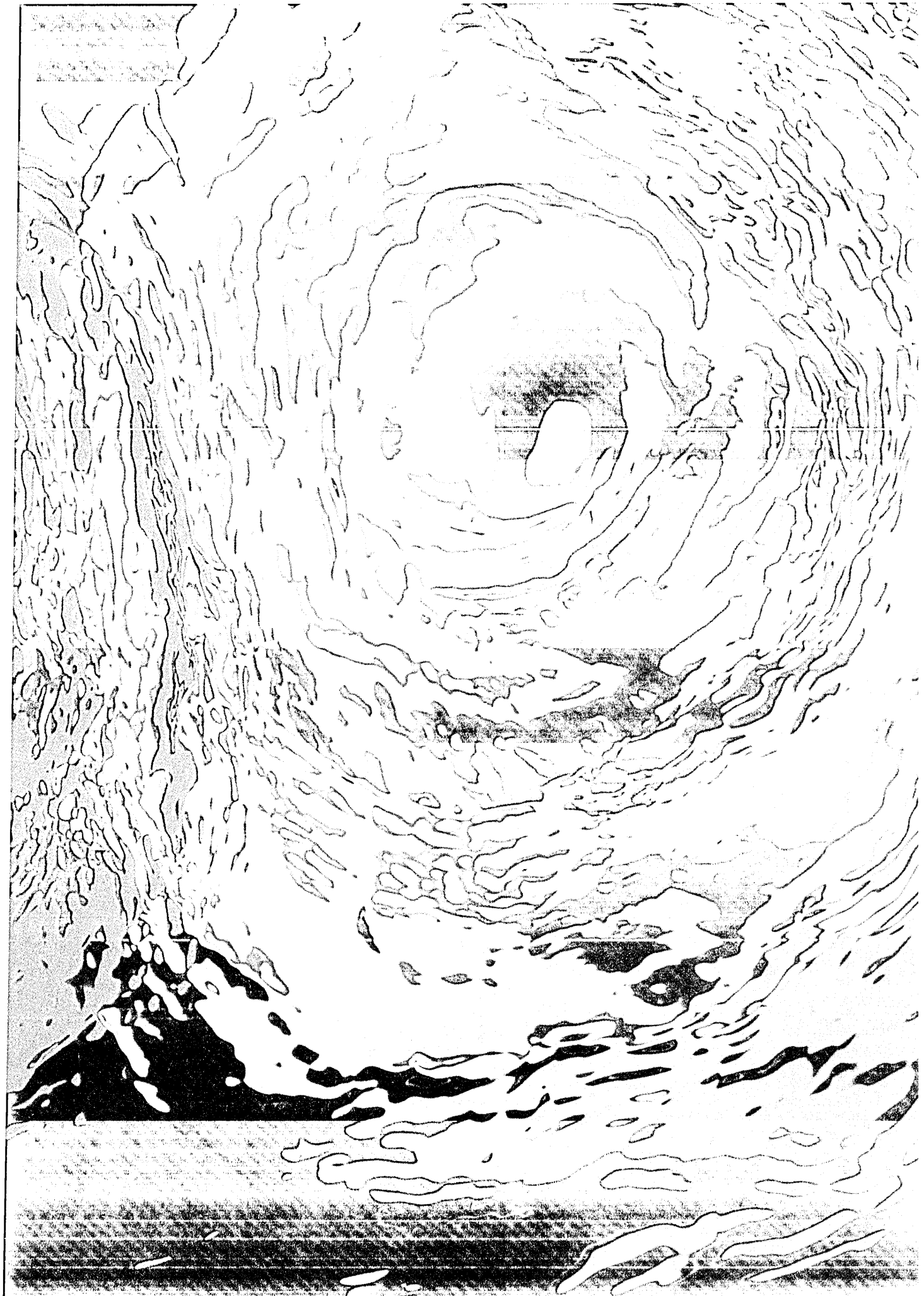

The actual convergence of these two technologies is quite recent. In August 1981, IBM joined other vendors to announce that it would formally support X.25-SNA links. IBM critics charge that the X.25 implementation is both begrudging and unnecessarily expensive. They say it is limited to the top-of-the-line or new controller models (3705-II, 3705-80, 3725) that the Network Interface Adapters—essentially packet assembler/disassemblers—are particularly expensive (\$9,100), and that full X.25/SNA capability was dribbled out over three releases during 1982.

Regardless, many managers will ask: "What's in it for me? What are the benefits of X.25 and SNA for firms that only imperfectly conform to the two classes of users mentioned above? Can they justify the expense and psychic wear and tear of conversion?" In answer to the first question, an inventory of the most salient benefits of X.25 and SNA would include:

- Improved interconnection between IBM and non-IBM equipment, enabling the extension of a large number of network services. Loosely related units can become more integrated. Network-dependent services such as electronic mail and applications redundancy can be introduced.
- Use of volume-priced communications links on PDNs, also called Value Added Networks (VANS), allows the extension of network services between locations where usage renders direct distance dialing or other kinds of leased lines prohibitively expensive.
- Substantial improvements in transmission efficiency when compared with predecessor protocols.
- Substantially improved choices regarding specialized processors and peripherals, with the concomitant advantages in features and price.

The second question, whether conversion to X.25 or SNA makes sense to a particular environment, predictably yields an answer unique to that environment. Nonetheless, posing the question may be salutary ("Do our communications between organizational units make sense?") and may also suggest a subtle shift in the unit of analysis ("Do we have a dp communications problem or a distribution of network services problem?"). Finally, it is not a firmly answerable question. Across the broad spectrum, interconnection is easier, communications costs are down, and the range of network-dependent services has lengthened. This convergence deserves serious—and continuing—attention.

One must begin with a clear conception of X.25 and SNA. Oftentimes juxtaposed, they present a classic case of apples and oranges. X.25 is a packet-switching interface

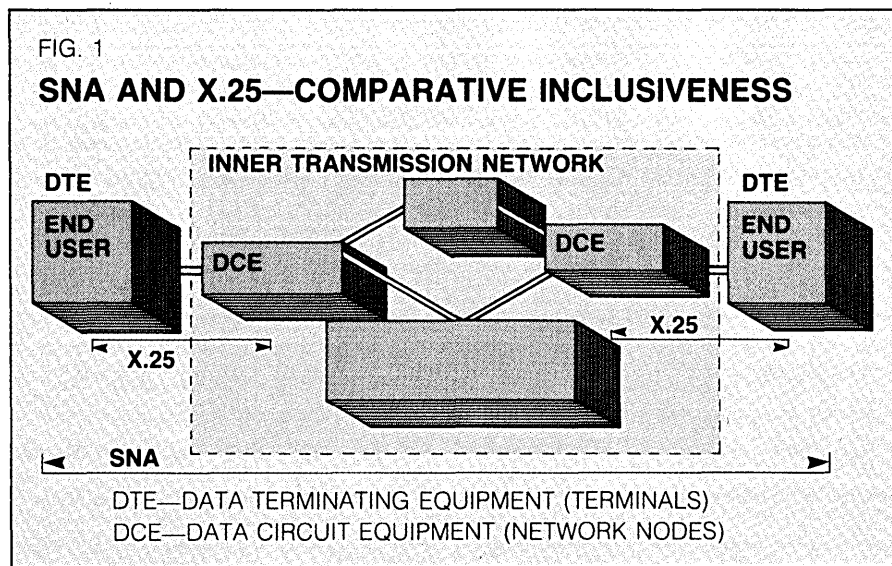

standard adopted by the Consultative Committee on International Telephone and Telegraph (CCITT). Packet switching is the routing of discrete information packets through a special network. X.25 provides the specification for connection between data terminating equipment (DTE) and data circuit equipment (DCE) in a transmission network. In other words, this usually means the connections between the user terminal location and the dedicated minicomputers or network nodes that channel user traffic through the network to the applications processor.

X.25 actually consists of, and subsumes, three protocols. A protocol is simply a specification for communications. The first governs the physical layer, the plugs and wires, and is called X.21. The widely used EIA RS-232C interface conforms to the analog version of X.21 called X.21 bis. The second protocol governs the frame layer and is the high level data link control or HDLC. CCITT's X.25 recommendations consider LAPB, which uses a subset of ISO HDLC, as the preferred link access procedure. HDLC checks for errors and specifies the signaling used in transmissions and the bit format of the data to be passed. The third protocol, called X.25, governs the packet level and specifies both the nature of the end-to-end connection and the overall packaging of the bits to be exchanged.

As shown in Fig. 1, X.25 plays a small part in using computers to perform useful work. Still, it is a major advance. First, packet switching à la X.25 represents a clear technological advance over its predecessors for most applications. Second, it is a standard protocol with no preferences for any particular vendor in any area notorious for vendor-specific implementations. X.25 still contains some undefined or vaguely defined areas that allow vendors to handle them differently. And since its early days, X.25 standards have undergone many changes, resulting in further incompatibility among different vendors.

By contrast, IBM's SNA is a comprehensive network architecture that consists of a number of protocols and provides total user-to-user services. Although both the de-

gree of network visibility and the extent of network services vary among vendor architectures, the characteristics listed in Fig. 2 provide an idea of what comprehensive means, in reference to commercially available network architectures. In addition, the distinction between the SNA architecture and the X.25 protocol is illustrated.

The historical origins, design philosophy, and subsequent development of SNA are important to understanding its success. Even the comparatively modest ADP communication demands of the '60s caused a crisis when combined with the breadth of the IBM product line. Prior to the announcement of SNA in 1974, IBM was supporting more than 200 communications products requiring 35 teleprocessing access methods and 15 different data link procedures. Not even this proliferation of products could keep up with customers' unanticipated desires to interface product D14 with product Z37. IBM's response to this chaos was complexity: the 1974 announcement of SNA, a network architecture to which all future products would conform and a target to which a finite number of bridges could be constructed for current products.

SHARP DIVISION OF LABOR

Two aspects best characterize the design philosophy of SNA—transparency for the user and a hierarchical orientation for the network. The goal of complete transparency for the user—meaning, user unawareness of where processing occurs—was achieved only at the cost of great complexity in implementation. Implicit, too, is a sharp division of labor. Hundreds, or sometimes thousands, of relatively low-skilled terminal operators labor in an environment controlled by a handful of highly trained communication specialists. Consistent with IBM philosophy, these specialists usually work from a central site. One can view a communications network architecture as a way of ordering relationships among unequal devices (for example, terminals, distributed minicomputers, large host processors). Given the continuum of choices

Are you playing with a full DEC?

Not unless it's loaded with SPSS/Pro™—
the Information Analysis System for
DEC Professional Series microcomputers.

Fact is, SPSS/Pro is perfectly suited for a variety of purposes, wherever there's information to be organized, summarized and displayed. It's the first micro-sized version of SPSS, the most widely used Information Analysis System in the world.

SPSS/Pro and SPSS are trademarks of SPSS Inc. for its proprietary computer software. DEC and DEC Professional are trademarks of Digital Equipment Corporation. SPSS/Pro runs on the DEC 310 with standard configuration and the floating point option.



POWERFUL.

- Sophisticated statistics files
- Large or small data
- Custom-formatted reports

VERSATILE.

- Ideal for commercial, educational or research applications
- Input & output data in many forms
- Solves problems with one package

EASY TO LEARN.

- Simple English language commands
- Training available
- Fully documented by McGraw-Hill

COMPREHENSIVE.

- Over 25 statistical procedures
- Flexible file & data transformations
- Totally integrated system

Want to deal yourself in?

To order SPSS/Pro, contact the SPSS Inc. Marketing Department. But hurry, so you won't get lost in the shuffle!

SPSS Inc.

444 N. Michigan Avenue
Chicago, Illinois 60611
312/329-2400

CIRCLE 106 ON READER CARD

© Copyright 1988 SPSS Inc.

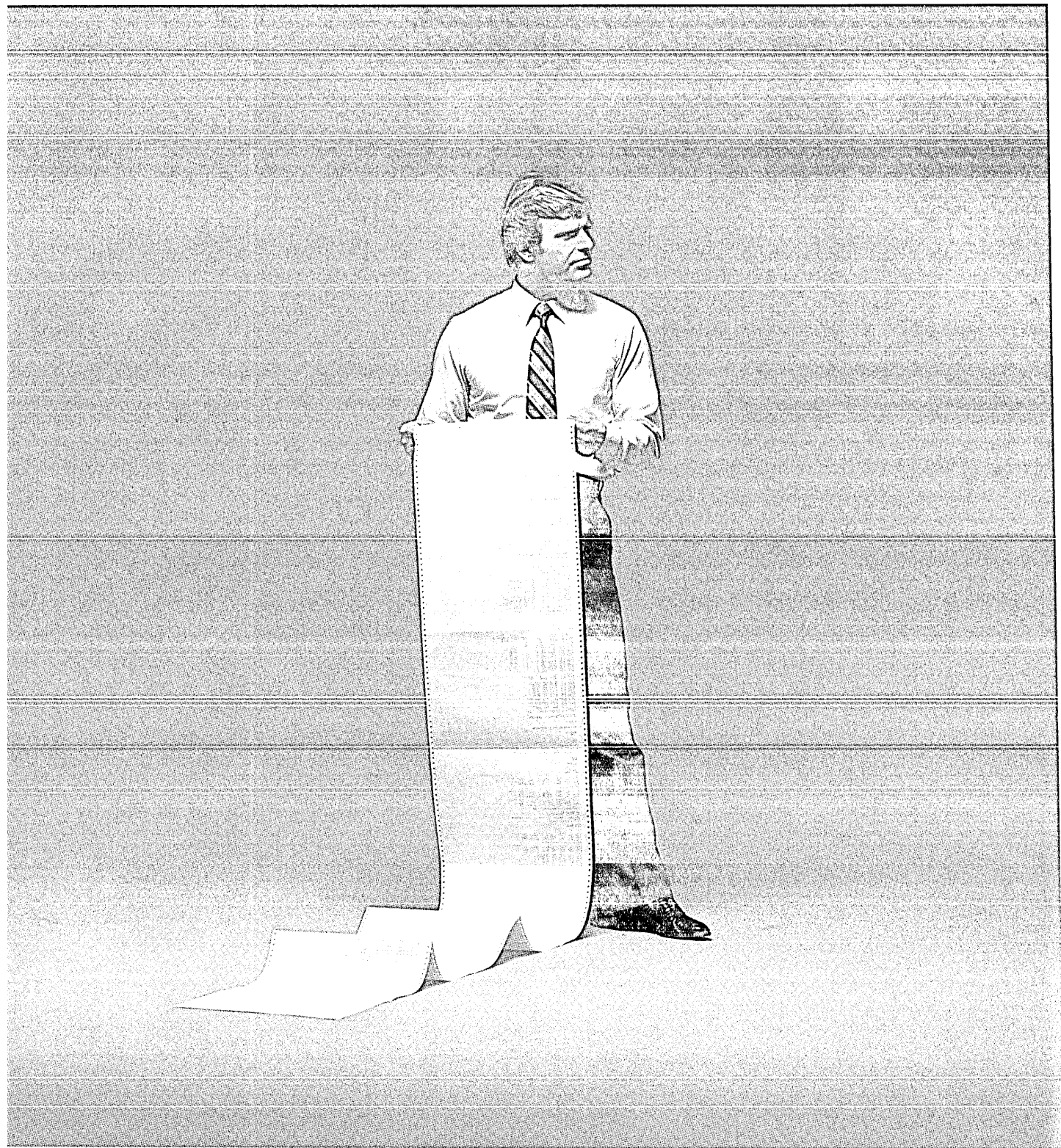

Figure \$50 a line for programming.

When people look at business computers, they sometimes overlook a crucial consideration: the price of writing and maintaining software.

But we didn't. When we designed the HP 3000 family, we created special productivity tools to reduce the high price of developing applications software. With dramatic results.

Many HP 3000 customers now use 1/5th the amount of code writing these programs, compared with using

high-level applications language. Since the average program costs you about \$50 a line to develop, you can see why EDP budgets go so much further on an HP 3000 computer.

You can use our development tools with the entire HP 3000 family. And, as all four systems are fully compatible, you can run the same, identical programs on your small branch office computer and on the big system in your regional headquarters. Without spend-

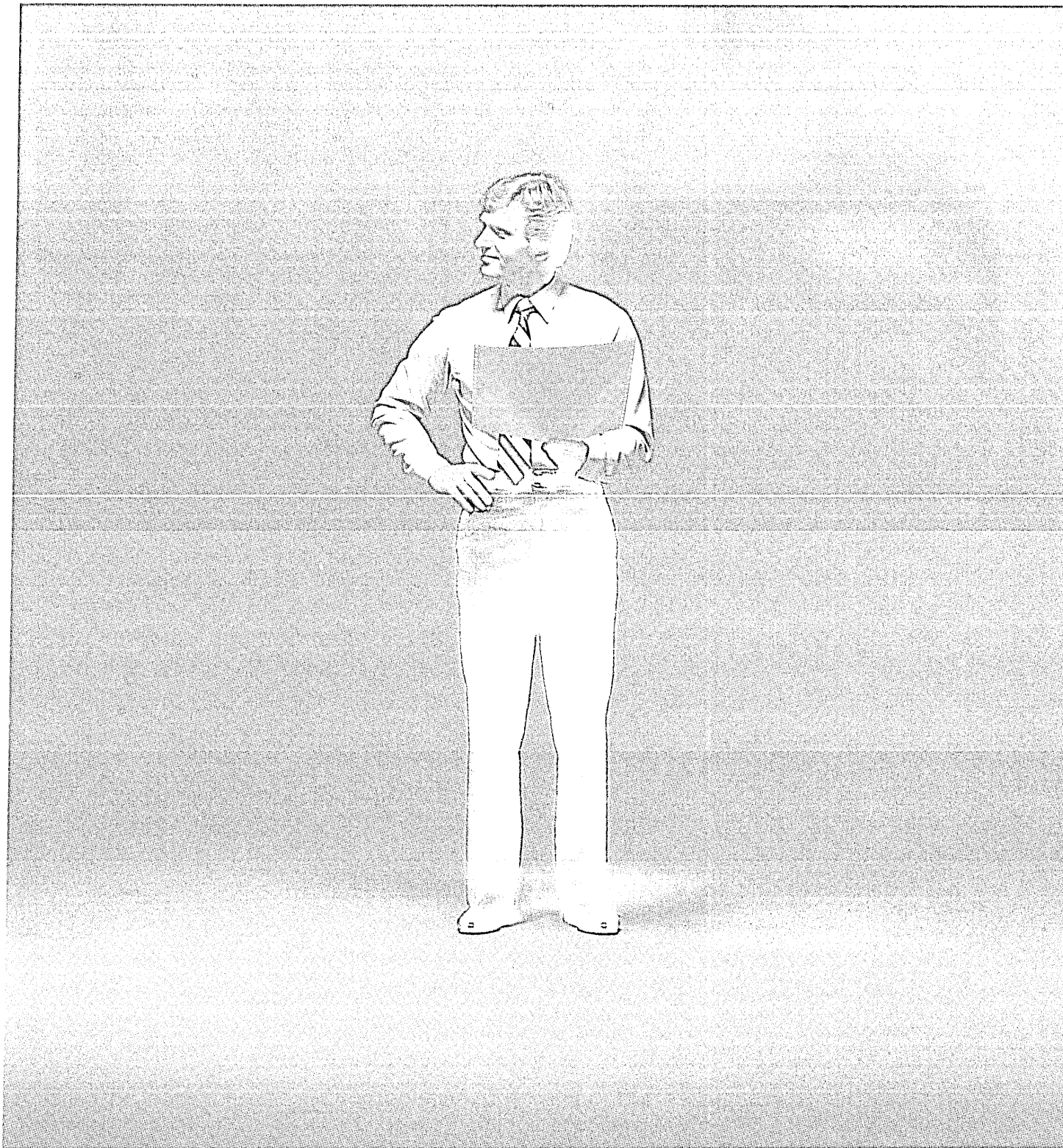

Now divide by five.

ing a penny to rewrite code or recompile.

Features like these have helped many of our customers recoup the entire price of the hardware by cutting the time and effort involved in developing and maintaining the software.

So if you're looking for ways to lower your computing costs, take a look at the HP 3000. Call your local sales office listed in the white pages and ask for a Business Computer Specialist. Or write for more infor-

mation to Tom Rappath, Hewlett-Packard, Dept. 04185, 19447 Pruneridge Avenue, Cupertino, CA 95014. In Europe, write Henk van Lammeren, Hewlett-Packard, Nederland B.V., Dept. 04185, P.O. Box 529, 1180 AM Amstelveen, The Netherlands.



**HEWLETT
PACKARD**

BD02312

CIRCLE 107 ON READER CARD

IBM's SNA preceded the ISO Reference Model as an intellectual conception by a good 10 years.

to fulfill this objective, IBM's early versions of SNA were very centralized, with all remote devices slave to a single communications controller. It is problematic to speculate whether IBM was attracted to the strict hierarchical organization for technical reasons or because they saw it as a natural complement to the organization structures they encountered in the commercial world.

Through market forces, SNA has evolved in directions that allow considerable configurational freedom. Through clever addressing, the later versions of SNA maintain many of the advantages of centralization (network control, problem diagnosis, record keeping), but permit a large topographic area to be partitioned among remote hosts that exercise substantial control over their domains. Although criticized as being in the same clumsy, overly complex, and costly tradition of OS/360, TSO, and IMS, SNA's capability and the availability of 370-era software renders it secure as the dominant network architecture of the 1980s.

A second way of comparing X.25 and SNA is by examining their functional layers. Both are modern, layered designs where functions are consciously separated in a manner akin to soil strata. These layers provide functional modularity while insulating the constituent protocols from the effects of changes in other layers. Presented for purposes of comparison in Fig. 3 is the seven-layer "Reference Model of Open Systems Interconnection" by the International Organization for Standardization (ISO). From the bottom up, the ISO's functional divisions are specified as follows:

- *Level One*—the physical link with the network.
- *Level Two*—signaling used for controlling transmissions, the bit format of the data to be passed, and error checks.
- *Level Three*—the end-to-end connection and packaging of the bits to be passed back and forth.
- *Level Four*—description of routing through the network.
- *Level Five*—the nature of the user sign-on, user identification, and terminal dialog.
- *Level Six*—mechanics of the data display.
- *Level Seven*—the interaction between user and application.

The ISO Reference Model is not a working communication technology but rather a recent and highly differentiated specification of the total set of user-to-user communications functions.

In Fig. 3, several aspects in the three-way comparison of X.25, ISO, and SNA levels are worth noting. First, IBM's SNA preceded the ISO model as an intellectual conception by a good ten years; very probably it influenced the ISO Reference Model. IBM's layers en-

FIG. 2

A COMPARISON OF SNA AND X.25

CHARACTERISTICS	SNA	X.25
Network transparency for the user	Yes	
Near-automatic handling of typical communications problems	Yes	
Centralized network control	Yes	
Automatic network reconfiguration	Yes	
Automatic error tabulation and recovery	Yes	
Automatic sharing of peripherals among network host processors	Yes	
Full support of the networking of distributed processors connected to one or more hosts	Yes	
Support by a variety of distributed systems	Yes	Yes
Support by a variety of data entry devices	Yes	Yes
Interfaces to public data networks (PDN)	Yes	Yes
Supports a wide variety of physical transmission media	Yes	Yes
Error detection and correction	Yes	Yes
Automatic data segmentation and reassembly	Yes	Yes
Code independency (foreign languages, image coding, etc.)	Yes	Yes
Support of multiple routes for data segments		Yes

FIG. 3

X.25 COMPARED WITH THE ISO'S REFERENCE MODEL AND SNA

CCITT X.25	ISO OPEN SYSTEM ARCHITECTURE	IBM SNA
	PROCESS CONTROL	NETWORK ADDRESSABLE UNIT SERVICES MANAGER
	PRESENTATION CONTROL	FUNCTION MANAGEMENT
	SESSION CONTROL	DATAFLOW CONTROL
	TRANSPORT END-TO-END CONTROL	TRANSMISSION CONTROL
PACKET CONTROL (X.25)	NETWORK CONTROL	PATH CONTROL
FRAME CONTROL (HDLC)	LINK CONTROL	DATA LINK CONTROL (SDLC)
PHYSICAL CONNECTION (X.21 BIS)	PHYSICAL CONTROL	PHYSICAL CONNECTION (CCITT V.24, V.25, OR X.21 BIS)

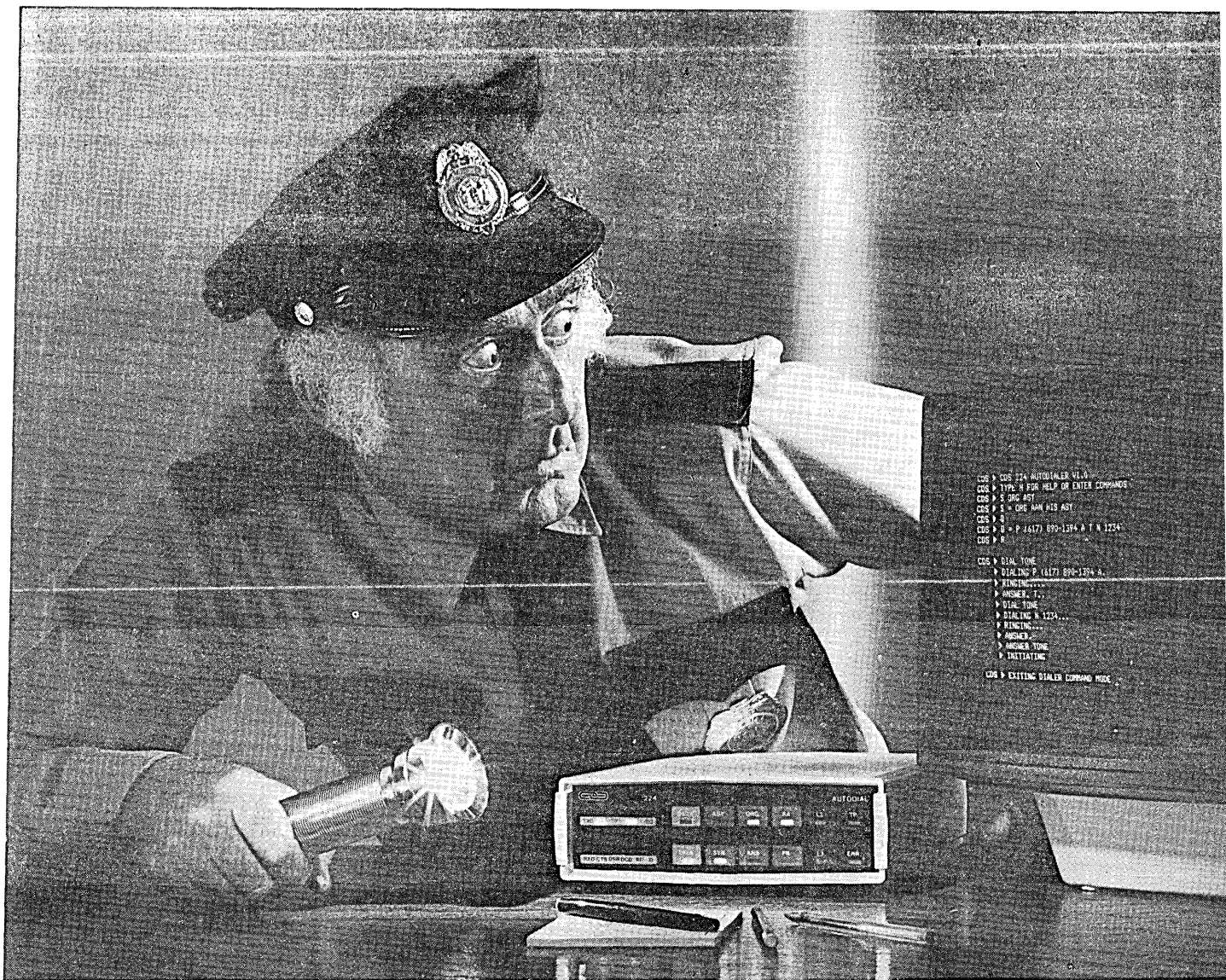

```

CDS > CDS 224 AUTODIALER V1.0
CDS > TYPE N FOR HELP OR ENTER COMMANDS
CDS > S 2400 BPS
CDS > A - ONE AMM HIS ASY
CDS > B
CDS > D - P (617) 890-1394 P T N 1234
CDS > R

CDS > DIAL TONE
  > DIALING P (617) 890-1394 A...
  > RINGING...
  > ANSWER P...
  > DIAL TONE
  > DIALING N 1234...
  > RINGING...
  > ANSWER...
  > ANSWER TONE
  > INITIATING
CDS > EXITING DIALER COMMAND MODE
  
```

Introducing the First 2400bps Full Duplex Dial Modem with Autodial ...at a price that's a steal!

Now you can have the high performance features of the CDS 224™ dial modem with the added convenience and cost savings of autodial. Operating at 2400bps full duplex, with 212-compatible fallback, the CDS 224 Autodial supports all of today's most popular protocols and transmits in both synchronous and asynchronous modes. Its autodial feature is compatible with either rotary or tone telephone systems and permits both keyboard and automatic software controlled dialing. User-friendly prompts appear on the screen to guide you through keyboard dialing, or your computer can place calls automatically. Our CDS 224 Autodial will do away with extra telephones,

eliminate your need to be on-hand for telecommunications, and let you take full advantage of off-peak rates by telecommunicating after hours. There's only one 2400bps full duplex autodial modem on the market today. And at \$1,195, it's a steal. For the name of your nearest CDS distributor call (617) 890-1394 or write Concord Data Systems, 303 Bear Hill Road, Waltham, Massachusetts 02154. Telex: 95-1793.

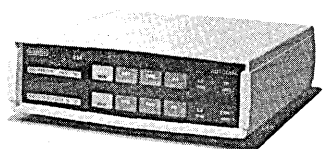

CONCORD DATA SYSTEMS
LINKING COMMUNICATIONS TECHNOLOGIES

See us at **COMMUNICATION NETWORKS CONFERENCE & EXPOSITION**
Washington, D.C. January 31—February 2, 1984

CIRCLE 108 ON READER CARD

The newer protocols protect all transmissions by powerful error detection and correction mechanisms.

compass all of the ISO's functions, but were modularized somewhat differently and thus particular functions were implemented differently on different layers. Readers should be aware that there is no general agreement on the number of layers within SNA. Some writers on the subject ignore the physical control level where many others include it as a layer. As one commentator, Bruce Hoard, wrote: "SNA has been completely specified, but not entirely published. ISO has been fully published, but not entirely specified." Not so with X.25. The CCITT's layering follows the ISO functional distinctions closely, with the exception that X.25's network control functions extend slightly beyond that of the ISO. But the major point is that X.25 is not a comprehensive architecture in the same sense as SNA, and that additional upper-level software is necessary to perform user-to-user functions.

Given the preceding discussion of the differences between X.25 and SNA, implementing these technologies involves paths that are largely, but not always, divergent.

How might an X.25-based system be implemented? Remember that it must be used in conjunction with upper-level software to do useful work. One way would be to employ the upper levels of a native mode vendor architecture, such as Prime's Primenet, DEC's Digital Network Architecture, or Univac's Distributed Communications Architecture. A non-SNA, but IBM-compatible, route might use X.25 for lower-level functions and such SNA-compatible products as CICS and IMS to perform the upper-level functions. There are some environments, particularly those with numerous but low-volume user sites, where the optimum combination would be to employ SNA nodes while the links used X.25. Still another hybrid architecture employing X.25 would be to use a family of products provided by a software house (i.e., communications monitor, DBMS, transaction processor) that provided these upper-layer functions. The point to remember is that X.25 is useful for a large class of problems involving network interconnection. It does not, however, provide the manager with an out-of-the-box solution for a network application. Network applications of a nontrivial nature involve careful selection of upper-level software as well as careful modeling of the projected processor/network loadings in concert.

By contrast, to declare and support a pure SNA network, one must assemble all of the following:

- a processor that is IBM 370-, 303X-, or 43X1-compatible;
- a communications processor that is IBM 370X/3725-compatible;
- terminals or other devices that employ IBM's Synchronous Data Link Control (SDLC)

protocol;

- and various IBM system, communications access, and communications controller software or their equivalents.

One can view these requirements as a commitment to a large family of products that must be present to declare and support an SNA network. To reap the important benefits of SNA networking, the SNA manager must commit to feed and support this large family. Thus, complete SNA compatibility means conformity within all layers of functionality.

The next major point is that many users have neither the means to achieve full SNA compatibility (a System 370 compatible mainframe) nor do they really require it. For applications involving local data entry or inventory control, the ability to interconnect with a remote SNA host and pass and receive files may be functionally sufficient. In these cases, reduced SNA compatibility is available by emulating a particular SDLC device. This usually takes the form of emulating either a terminal cluster controller (usually the IBM 3274 model 1C) for interactive traffic or an RJE (such as the IBM 3777 model 3) for batch operations. What is important is achieving the desired level of network services at the lowest cost. Nonetheless, one must be wary that SNA compatibility means different things to different groups, and vendor claims must be carefully scrutinized.

BENEFITS TO NET SYSTEMS

Overall, the details and differences between SNA and X.25 should not be allowed to obscure the great benefits these technologies can bring to networked systems. The most important of these benefits is greatly facilitated interconnection across dissimilar architectures, which allows system planners to interconnect many different systems with reasonable efficiency. Current protocol support by dp vendors reveals several interesting patterns. First, the many System 370-compatible processor manufacturers are, by the dint of the recent IBM X.25 announcement, exceptionally well-positioned for networking roles. Second, the minicomputer manufacturers, who have the most to gain by facilitated interconnection, are making the greatest effort, with many offering both X.25 and SDLC device support. Further, by the relative neutrality of the interfaces (X.25 uses an international standard; SNA devices are supplied by many vendors in addition to IBM), the system planner seldom has to worry that selection of one vendor precludes easy interconnection with others. Finally, from the perspective of "a network is what a network does," the chief benefit of interconnection is expanded services. Today these services can include: localizing specialized ADP support; sharing pe-

ripheral devices; providing electronic mail and filing; operating with localized, logically partitioned databases; and achieving applications redundancy.

Within the next several years, additional services such as the following can be expected:

- Integrating digital voice and data services via local area networks, either by PBXs (private branch exchanges) or media-based cable systems, such as Ethernet.
- Providing high-speed facsimile, freeze-frame or continuous video, high-resolution graphics, or other services requiring wide bandwidth interconnection.

ALLURE OF PUBLIC DATA NETS

The allure of the public data networks (PDNs) has been of almost equal impetus. Most dramatically, PDNs fill a service void between direct distance dialing and leased lines. Additionally, by providing usage-sensitive pricing, they attract users whose typical transmission requirements are highly variable. Together, these characteristics allow an organization to expand to many physical points despite low volumes per site and to participate extensively in networking functions while sharing the costs of network overhead. Finally, as most of the PDNs have provisions for protocol conversion, user organizations can either completely avoid or test the waters, prior to making hardware and software protocol commitments.

Although less visible than the previous benefits, both the SDLC and HDLC link level protocols embody substantial technical advances over their predecessors. As noted, a data link control protocol is a set of rules governing the interchange of data over a communication link among network elements (computers, terminals, concentrators, or any data terminal equipment). The last generation of link control protocols were character-oriented: that is, they used one or more defined character structures from a given code set to frame the data and supervise its interchange. The rapid growth of data communications in recent years, combined with the support of special features (such as graphics, information sensors, etc.), have prompted the emergence of a new generation of data link control procedures, known as bit-oriented data link control protocols. SNA's SDLC and X.25's HDLC were among the forerunners in this development.

The payoffs were substantial, and resulted in improvements in efficiency, reliability, and flexibility. A comparison of transmission mode, transmission code dependency, adaptability to various configurations and users, efficiency, and reliability will illustrate the advantages of SDLC and

SCIENCE/SCOPE

A high-speed integrated optic modulator for fiber optic applications promises to significantly affect the future of microwave transmissions. The device, developed by Hughes Aircraft Company research scientists, is a guided-wave Mach-Zehnder interferometer. Light entering the interferometer is split into two arms and then recombined. By applying an electric field to one arm, a relative phase shift is induced so that the light, upon recombining, interferes to produce an intensity variation proportional to the applied electric field. The field is applied by a microminiature traveling-wave electrode design with a 3 dB rf bandwidth of 17 GHz. Only 6 volts of drive are required. This modulator will let a fiber optic link transmit simultaneously all common microwave and radar bands.

An advanced infrared seeker now being developed would improve the operating range and accuracy of future air-to-ground missiles and guided bombs. Hughes is producing a scanning focal plane array (FPA) seeker to demonstrate advanced infrared imagery. The sensor is the size of a collar button and consists of tiny infrared detectors on one side and a corresponding number of signal-processing elements on the other. Because the sensor would be more sensitive than existing devices, it can stay locked on small targets more easily, distinguish between targets and background clutter more easily, and detect targets from farther away. The seeker also promises benefits in weight and cost. Hughes also will conduct a study to determine whether the seeker would be feasible for a variety of weapons planned by the U.S. Air Force and Army for between 1990 and 2000.

A new computer system promises to reduce scrap and rework, thereby helping one Hughes group slash costs by an estimated \$1.5 million annually. The Quality Information System (QIS), now under development, will compile and analyze data on how defects happen and how they are corrected. Information will be made available to manufacturing employees for immediate feedback and for use during production. Data will also be kept in a central historical file for future reference. QIS is expected to improve quality by spotting problems that stem from faulty design, poor supplier quality, and improper manufacturing methods.

An infrared sensor made of standard components turns night into day for tanks and other combat vehicles. The compact device, called Hughes Infrared Equipment (HIRE), was designed to be low in cost yet high performing. It can be adapted to periscopes to let gunners of such tanks as the M48 see through darkness, haze, or battlefield smoke. HIRE can be mounted in laser tank fire control systems, light armored vehicles, or used as a target acquisition/fire control sight for anti-aircraft, ship, and helicopter applications. The design uses U.S. Army common modules, the standard building blocks for thermal imaging systems.

Hughes Research Laboratories needs scientists for a spectrum of long-term sophisticated programs. Major areas of investigation include: masked ion beam lithography, liquid-crystal materials and applications, submicron microelectronics, ion propulsion, and new electronic materials. For immediate consideration, please send your resume to Professional Staffing, Hughes Research Laboratories, Dept. SE, 3011 Malibu Canyon Road, Malibu, CA 90265. Equal opportunity employer.

Creating a new world with electronics

HUGHES

HUGHES AIRCRAFT COMPANY

For additional information please write to:
P.O. Box 11205, Marina del Rey, CA 90295

The communications standards for the '80s have fully arrived.

HDLC over their predecessors.

First, we'll discuss transmission mode. From a control standpoint, the older character-oriented procedures are basically two-way alternate or half duplex in nature (it must be noted that this does not necessarily mean a character-oriented protocol has to be half duplex). In contrast, HDLC and SDLC are designed to transfer data in both half-duplex and two-way simultaneous or full-duplex mode.

The second feature concerns the transmission code's dependencies. Although bit-oriented protocols are also code independent, the user can choose the code set to be used for data transfer without concern for the data link control being used. By dedicating certain codes or bit patterns from the user's set for data link purposes, the older protocols will provide less flexibility for special applications.

Third, adaptability to various configurations and users is another important feature of the bit-oriented protocols. The compositions of the procedures are such that they are readily applicable to two-wire or four-wire physical circuits, in point-to-point or multipoint configurations, and on

switched or nonswitched circuits. In most cases, the older character-oriented procedures vary so much in format and function from one type of application or use to another that essentially they are no longer the same data link control procedures.

Fourth, the older protocols generally perform only a single data link function with each transmission unit that is sent (e.g., transfer data, solicit data, etc.). As a consequence, larger numbers of logical link turn-arounds are often required. This leads, in many cases, to an unsatisfactory ratio of data transfer exchange to control exchange capability. In SDLC and HDLC, the ratio of data transfer exchange to control exchange per unit of time is high, because both systems allow multiple functions conveyed in each transmission.

Finally, the newer protocols protect all transmissions by powerful error detection and correction mechanisms. In contrast, most of the older procedures use unprotected control codes and sequences to perform error control, thus greatly increasing the probability of uncorrected data errors.

The communications standards for the '80s have fully arrived. X.25, adopted

universally by the PDNs, is the premier vendor-neutral link and packet level interconnect for heterogeneous vendor networks. There are several activities directed toward defining upper levels. Among these is the National Bureau of Standards' current effort on behalf of the fourth and fifth level (transport and session) of the ISO model. It is expected that the recommendation regarding the transport layer will become official in the near future.

SNA, built on the huge applications software base of the System 370 and offering full capability, is preeminent in its context. Best of all, the convergence of the two has been blessed by IBM's announcement of X.25 support. For many managers, now is the time to interconnect—and to benefit. *

Dr. Edwin R. Coover is a member of the technical staff, information and communication systems, Metrek Division of the Mitre Corp., McLean, Va.

For the past two years, Ali Eshgh has been a senior network engineer with Network Solutions Inc., McLean, Va. He has been involved in communications consulting for six years.

Universally accepted.

The Software:

Report Writer/
Utility/Information
Management/Audit

The Audience:

Programmers, End-Users,
Systems Analysts,
DP Managers, Auditors...

The Market:

Worldwide IBM
360/370/30xx/43xx Sites

The Products:

DYL-280, DYL-270, DYL-260
DYL-AUDIT

The Results:

Over 1800 Installations
Experiencing A Savings
of 50% or More in
Programming Time

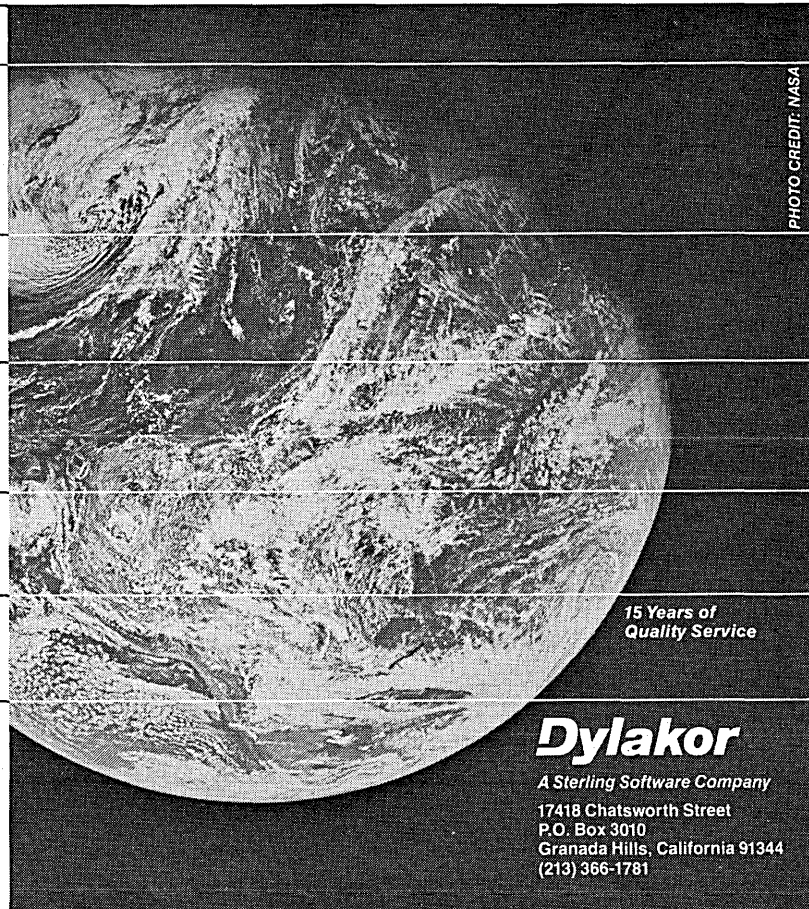

PHOTO CREDIT: NASA

15 Years of
Quality Service

Dylakor

A Sterling Software Company
17418 Chatsworth Street
P.O. Box 3010
Granada Hills, California 91344
(213) 366-1781

CIRCLE 109 ON READER CARD

Start with an LSI-11

Dataram's W23 starts with the LSI-11/23 (soon the LSI-11/73)

I/O mapping accommodates 18-bit peripherals (e.g. RX02) and 22-bit peripherals, while supporting 4.0 MB of memory

1.0 MB minimum... up to 4.0 MB!

27 dual-slot backplane

RM02-compatible 80 MB or 160 MB Fujitsu Winchester

W23's RM02-compatible controller can support external CDC 9762 SMD drive for removable media capability or backup, in addition to controlling the integral Winchester

\$16,940 system price*

Supports RSX-11M, RSX-11M-PLUS, RSTS, and UNIX

Cipher Microstreamer with controller available for less than \$5300

...and end up with a powerful minicomputer!

Dataram's W23 minicomputer system gives you more than an LSI-11. By packaging an LSI-11/23 (or LSI-11/73) in a compact 10½" chassis with 160 MB Winchester capacity, 27 dual slots, and a hefty 50 A power supply. And then going a step further with I/O mapping that allows up to 4.0 MB of memory while supporting both 18-bit and 22-bit controllers.

For more information, forward this coupon to us or, even better, call us today at (609) 799-0071.

Send information. Contact me immediately.

Name _____

Company _____

Address _____

City _____ State _____ Zip _____ Phone _____

Return to:
Dataram Corporation, Princeton Road, Cranbury, NJ 08512
DTM1283

*\$16,940 system price is single-quantity domestic price for W23 with LSI 11/23, 1.0 MB, 80 MB Winchester, and I/O mapping.

DEC, LSI-11, RSTS, and RSX are trademarks of Digital Equipment Corporation. UNIX is a trademark of Bell Laboratories.

DATARAM

Dataram Corporation □ Princeton Road □ Cranbury, New Jersey 08512 □ (609) 799-0071 □ TWX: 510-685-2542

CIRCLE 110 ON READER CARD

YOU WANT YOUR COMPANY TO GROW.

SHOULDN'T YOUR LOCAL COMMUNICATION NETWORK GROW WITH IT?

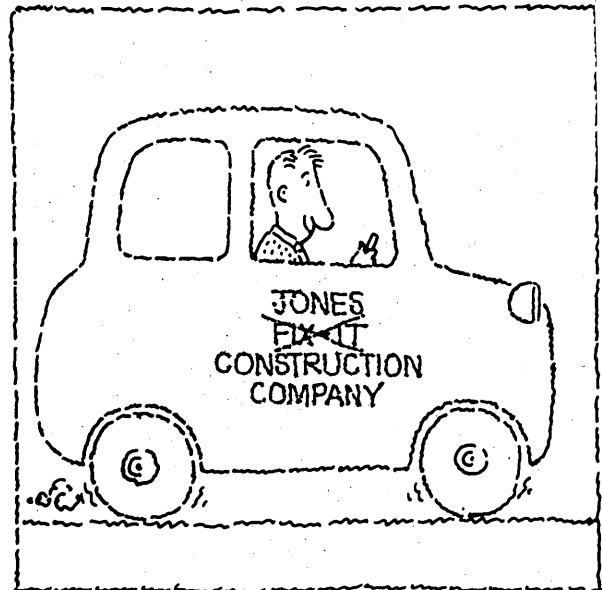
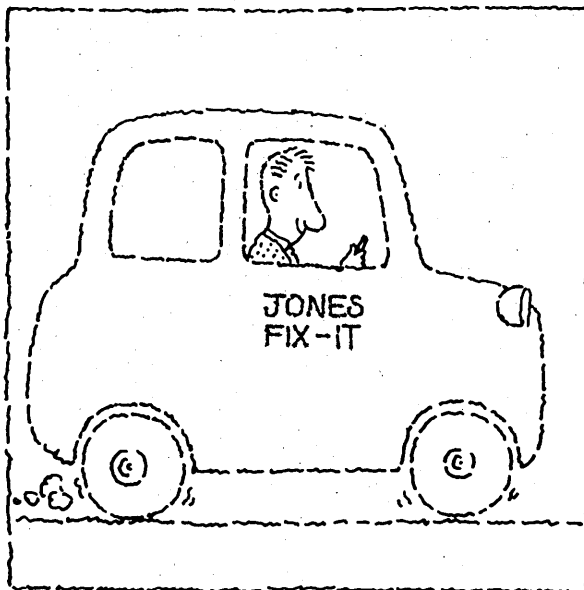

Most managers want their companies to grow. But a local communication network that can't grow with the company can become a millstone that holds the company back. That's why we designed the IDX-3000 Local Communication Network to have a future.

Start today

The IDX-3000 is a third-generation digital data switch with distributed architecture. You can start with a small system—a Network Exchange and enough multiplexers to support a few hundred lines. To grow, just add additional Network Exchange circuit boards

and multiplexers. At full capacity, the IDX-3000 provides non-blocking, full-duplex asynchronous communication for up to 3072 lines, all at data rates of up to 19.2 kilobaud. Only two twisted pairs of wires are needed to connect each group of 24 users through distributed multiplexers to the Network Exchange, which can be located up to 1.2 miles away.

And keep growing tomorrow

When your facilities become more distributed, the IDX-3000 internal DS-1 data format will interface directly with the Bell North American communications system or with microwave radios so you can extend

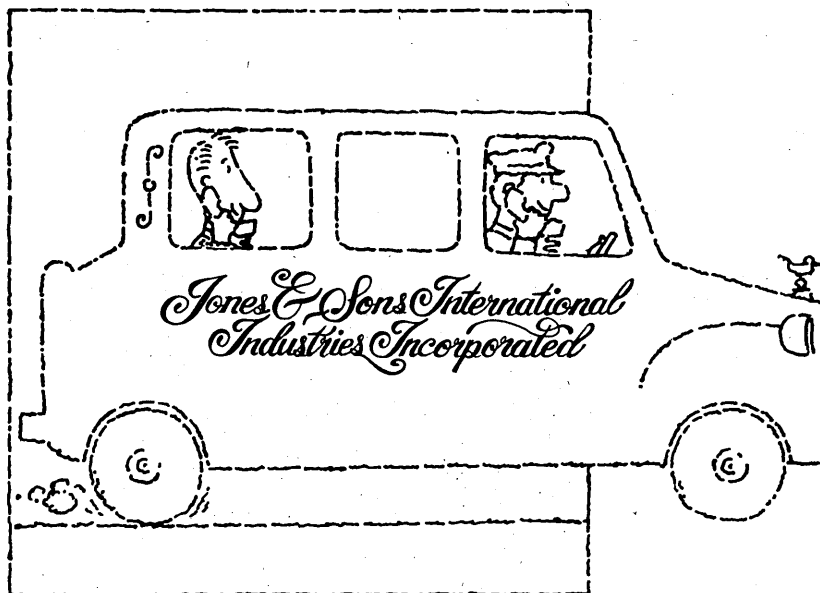
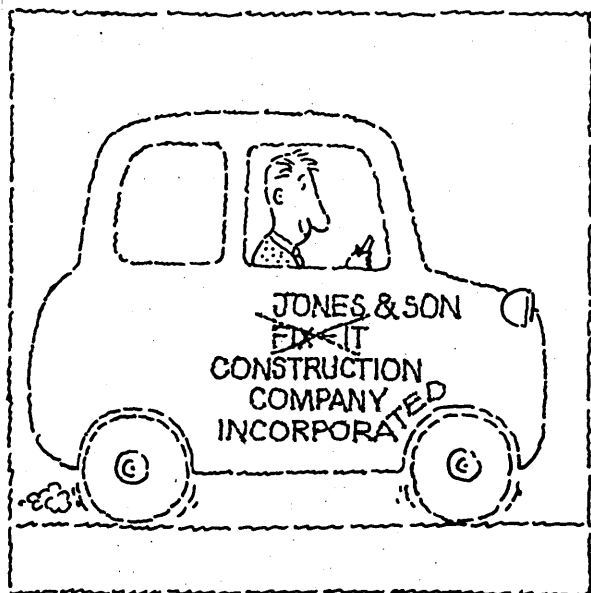

your network as far as you want. If you need more than 3072 lines, we are planning a tandem networking capability to give you the number of lines you need. A synchronous capability at data rates of up to 56 KBPS per line is also planned.

For the office of now

Simple installation, distributed architecture, and practical, fault-tolerant design keep costs down. Optional redundancy features protect you from costly down time. The IDX-3000 isn't one of those products of the future. It's here now—proven, in use, and backed by M/A-COM, one of the nation's largest

and most experienced communication equipment companies.

If you have or need more than 200 terminals, call or write and tell us about your communication needs. We'll give you the full story about the network that will grow with you.

THE NO-RISK NETWORK



M/A-COM LINKABIT, INC.

Attn: Ruth Stoffel
 3033 Science Park Road
 San Diego, CA 92121
 Toll Free (800) 626-6640
 (619) 457-2340

CIRCLE 111 ON READER CARD

Systems Architects and Systems Software Engineers:

WIS

The Mission Begins Now!

The days of proposals and broad scale project definitions are behind us now. GTE has been selected to take on the *principal architectural role* in the information systems project of the century...WIS.

Designed to bring unprecedented, state-of-the-art capabilities to WWMCCS, the Worldwide Military Command and Control System, WIS will involve high level professionals from the broadest range of technologies and disciplines ever assembled under the aegis of a single Information Processing System program.

That's why we need advanced level systems professionals like yourself. To take on a leadership role in the development of a system so advanced you'll be working beyond existing state-of-the-art technology. In a program that's projected to be totally software-driven—the first program of its size and scope to have its software designed before any hardware is selected. And you'll work with resources that represent the best available commercial technology.

Imagine the complexity and sophistication of an Information System that provides instantaneous and secure communication links on a worldwide basis between decision-makers and field commanders. The incredible challenge of integrating many millions of lines of software into a system dedicated to redundant communication links and distributed networks on a scale never before imagined.

Long before it's completed, WIS will dramatically impact state-of-the-art in Information Processing throughout the world, for decades to come. In both military and commercial applications. The Senior Level Systems Architects and Systems Software Engineers who join us today will take a frontline leadership role in the development of WIS...and their careers will never be the same.

Nor will the lives of themselves and their families. GTE is opening a new facility in the Bedford, Massachusetts area to house the WIS project. Centered in one of the country's richest historic areas, Bedford is only minutes from Concord and Lexington, and a half hour away from Boston. There are few places in the country that can match the cultural, recreational and educational resources you'll find available, four seasons of the year, here in the heart of New England.

GTE, as a world renowned leader in the development of C³ and C³I systems technology, has been charged with the mission of developing a system that will stand up to the toughest challenges ever conceived for an information system. A system that will lead the way for technology well into the next century.

If you would like to get in on the ground floor of the development effort for this major system breakthrough, don't put off contacting GTE today.

At GTE, the mission begins now.

If you're a Senior Level Systems Architect or Systems Software Engineer with significant experience in one of the following areas, you're ready to take a leadership role at our new facility which will be opening in the Bedford area after the first of the year.

Systems Architecture
Systems Communication
Standards
Systems Communication
Software
ADA PDL
Database Management
Systems
Operations Analysis
Systems Software
Security Systems
LAN Systems
Systems Test
Systems Integration

To investigate these opportunities at GTE, send your resume to Amy J. Tananbaum, GTE's Sylvania Systems Group, Strategic Systems Division, 1 Research Drive, Westborough, MA 01581. An equal opportunity employer m/f/h/v. U.S. Citizenship required.

The Forefront of C³ and C³I Technology

GTE Systems

CIRCLE 112 ON READER CARD

A conference room pilot test can help technical staff and users learn how to apply a package to a company's business needs.

THE SOFTWARE REHEARSAL

by John G. Seddon

For two months, managers at JBL Inc., a manufacturer of hi-fi speakers in Los Angeles, met once a day to play out the scenes they would encounter using the manufacturing package they had just bought. "In the conference room pilot," says Ellen Kane, JBL's director of MIS, "we had them play roles that simulated what was happening on the shop floor." Kane's background as a programmer made her wary of packages; she wanted to be sure the software worked. She also realized that her project team members needed to learn everything they could about the package. Only then could they decide how to apply it to the company's operations.

All software vendors advocate intensive testing of their packages. Some even supply elaborate test data and expected results. What Kane and other MIS directors are emphasizing is the importance of a pilot that includes user participation and live data. Like a prototype, the pilot gives users something to play with before the system design is cast in bronze. It ensures that the design is complete and understood by all involved. It also provides a simple, organized way to steer a package installation to success.

The conference room pilot has two phases. In the first, the project team tests the package and learns what it can do. In the second phase the team leads the users through role-playing exercises that help them to learn the new system.

The project team usually consists of a small group of people who can dedicate their time to the project. Each member represents one of the key departments involved in the application. Other user departments are brought in for the second phase of the pilot. JBL's project team, for example, had three full-time members: one represented inventory control, another came from master scheduling, and a third represented bills of materials and material requirements planning.

In the first phase, the team tests every transaction, every code, every option, to make sure the package works. "We ran all

the tests we could think of," says Joe Parisian, materials manager at New York Air Brake, a manufacturer of aerospace equipment and brakes for rolling stock. His firm used a conference room pilot to install an MRP package. "In phase one we really tried to mess up the system," explains Parisian. If the package stands up to this beating, the project team will be more confident when talking to the users in phase two. If the package crumbles, it's better to find out at an early stage rather than when the users are looking over the team's shoulders.

JBL organized its system test by following the company's application business cycle. For a manufacturing system this starts with setting up bills of materials, master

scheduling, ordering, building, taking customer orders, and, finally, shipping the product. By estimating how many transactions had to be tested at each step, JBL could schedule the system test.

The schedule was tight. MIS director Kane decided to hold daily meetings. The agenda for each meeting was the same: review yesterday's results, set the day's objectives, then code the data and transactions. Small talk was saved for later. The momentum and intensity of the test had to be maintained in order for the team to get through the application. Kane had one of the team members take minutes of each meeting. These minutes would be reviewed the next day against what actually happened in the test.

FIG. 1
A PACKAGE INSTALLATION USING THE CONFERENCE ROOM PILOT

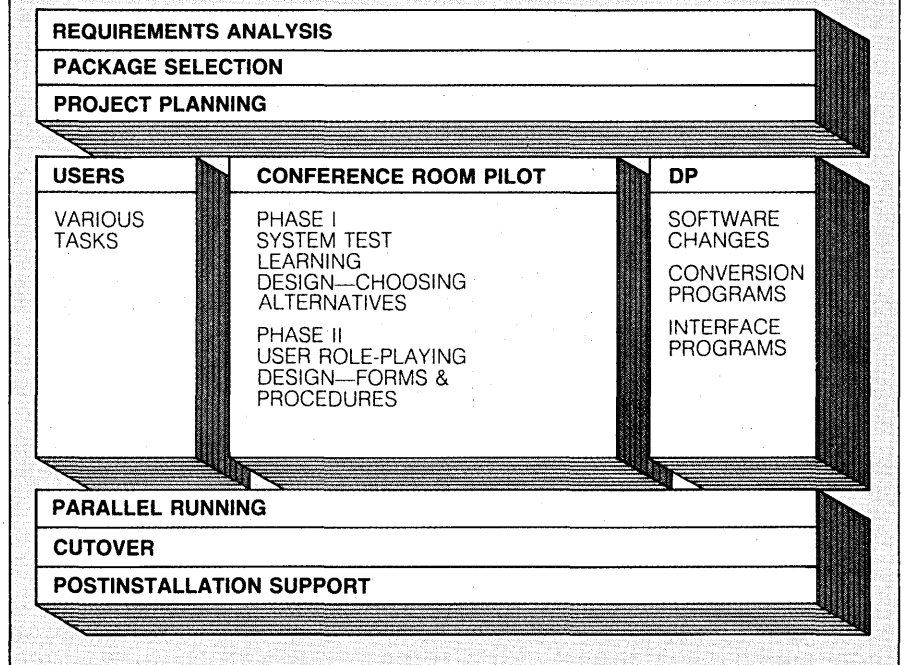

CHART BY CYNTHIA STODDARD

Once the project team understands the package, it can make informed decisions about appropriate alternatives.

SURPRISES CAN OCCUR

In such a test, unexpected things are bound to happen at first. A field may be miscoded, a required step missed. The day's objectives may be only partially achieved. The team must record what data are entered during each test so it can go back to discover what went wrong. This documentation is simple for batch systems; the team can keep the coding sheets. On-line systems, however, are more of a challenge. One approach is to take a hardcopy of each screen display. The hardcopy serves as a temporary form. Team members code the on-line transactions on the forms, then enter the transactions. Any warning or information messages that appear on the screen are noted on the form. This ensures that what happens during the testing session is fully documented and available for the following day's inquiry.

"During the system test we developed our own forms to keep track of the functions we were testing and what they accomplished," says Kane. "This becomes useful reference material throughout the project and

even when the system is in production."

The system test is also a learning tool. Vendor training and manuals provide a start, but the best way to learn the package is to use it. The team tries to accomplish everyday business tasks and solve shop floor problems. As the testing proceeds, the team sees more clearly how the package can be applied to the company's operation. If user department managers are on the project team they can start making policy decisions and designing procedures for their departments. "But you have to keep an open mind," says JBL's Kane. "You have to go through the system test to understand how the package fits together. You have to see why the package does things the way it does before jumping to the conclusion that something is unacceptable." Packages provide generalized solutions. The software buyer gets many alternative ways of doing things. Once the team understands the package, it is ready to make informed decisions about which alternatives are appropriate.

The project team also identifies other tasks to be done. Routing information may be

needed, lead times may have to be verified, or the bills of materials may need updating. The project team plays a part in designing the conversion and interface programs. But these tasks should be delegated to staff outside the project team; the team's objectives are to test the package and learn how it works.

In phase two, each member of the project team becomes responsible for one or more groups of users. These groups include managers, supervisors, and key clerical staff. Each group meets regularly in its appointed conference room, with a meeting agenda similar to that in phase one. The leader describes what the group is going to simulate in the day's work. The users code the transactions and enter them (or have them keyed). The next day the group reviews the results against the objectives.

Policy decisions are tested and confirmed in this phase. MSA's Blaine quotes an example: "Out of nine alternative lot-sizing techniques, only three may be appropriate to the company in the beginning. Three techniques will be presented to the users in phase two, and one method may eventually predominate."

The project team must make some design decisions before they bring in the users. It's foolhardy to let the users wander through the huge number of options available in a large package without a guide and some limit on the alternatives they have to choose from. Yet the team must know what the consequences of a particular choice are, and should explain these consequences to the users.

GROUP FOUND SOLUTIONS

"The users would ask the group leader how to do something," says JBL's Kane. "We would give them two or three alternatives but throw the decision back into their hands. The solutions became group decisions." New York Air Brake's Parisian offers a different perspective: "If a question came up—how do you do this?—I could say, do this, or this, and these are the results you will get. They thought I was smart. Little did they realize that nine times out of 10 we'd already tested it."

Each group designs and tests the new standards and procedures for its area. "We used the managers to write the procedures," says Kane. "We had them document the tasks they were doing in the pilot." This documentation describes the function, the transactions used, and explains who should perform the procedure at what stage in the business cycle. It should also describe how to check that the procedure has been performed correctly.

Phase two of the pilot also establishes lines of communication for the new system. If one group wants to talk to another they



"Here—in spite of snow, sleet, rain, hail, and acid rain—is another piece of junk mail."

CARTOON BY H.L. SCHWADRON

"Package installations can be both frustrating and rewarding."

send a message or walk down the hall to the other group. If the pilot reflects real-life situations, then this line of communication will be needed when the system goes live.

Another result of this phase is a set of job descriptions. People's responsibilities and ways of doing their work will change. Users, especially clerical staff, are still fearful of computerized systems, and this fear stems mostly from uncertainty. If management takes the offensive and openly presents the new job descriptions, there will be less resistance to the change.

These job descriptions should be backed up by a training plan. Kane wanted to train the user groups in phase two. Group members would then train their departments and become the local source of information. "We ended up including a lot more of the lower-level people in phase two," she adds. "We did all the training at one time. It was time-consuming. Some people picked it up, some people didn't."

The key to phase two is coordination. More people are involved and their time is valuable. Getting everyone to commit to a series of meetings is difficult. JBL held daily one-hour meetings. "First we brought in the

people who enter bills of materials," says Kane. "Then we started the master scheduling group, then the production control people." Kane points out that the trick is to keep the phases short. "You can get people together if they know it's going to be for only a month," she says.

In the first phase, the pace of the system test is dictated by the project team leader. The pace of phase two, by contrast, is determined by the users. The team must listen to what the users are saying, answer their questions, and resolve their problems. The users have to be comfortable that the package gives them the tools to do their work. And the more confidence they have in the new system, the less they will require a long, resource-consuming, parallel run.

"Package installations can be both frustrating and rewarding," says Parisian of New York Air Brake. "You always have the doubters, but I could stand up and tell them ways to do something and know it would work. Then the users try it out. It's rewarding to see them learn the new system. And some of the doubters become the strongest supporters of the package."

The benefits of the conference room

pilot carry beyond the installation project. As time passes, the users will ask for more sophisticated capabilities. Any good, generalized package will include advanced features that may not be appropriate when the system is installed.

When the time comes to enhance, the project team already knows the implication of a new code or transaction because they tested it. The users can apply the feature immediately.

Simulating shop floor situations, and fully involving the users, keeps the design of the new system on target to meet the real needs of the company. Setting daily objectives keeps the installation on schedule. Delivering the right system at the right time makes the package installation a success. *

John G. Seddon is manager of systems and programming for Vidal Sassoon in Los Angeles. He previously worked for Control Data, Canada, and IBM, United Kingdom. He has managed three package installations in the past 18 months and is currently working closely with users to install a fourth.

If it seems like you never have enough good programmers, Wiley has some very good news for you.

THE WILEY DATA PROCESSING TRAINING SERIES

To look at the ads in computer magazines these days, you'd think the answer to every business data processing problem was some new piece of equipment. But you know your job better than that. Hardware isn't going to get you out from under your programming backlog. *People* are.

Training people to get the job done—and training for less—is what the Wiley DP Training Series is all about. It's a comprehensive series of field-proven, fully self-instructional courses in applications programming, written and tested by nationally known DP trainers. No expensive "bells and whistles"—just sound, structured programming skills, taught in a practical, step-by-step format that *works*.

Use them for in-house training sessions (our *Leader's Guides* make it easy for you to conduct your own training seminar). Or give them to your employees for self-study. Either way, you can train new programmers or improve the productivity of your present staff—and do it at a fraction of the cost of canned DP training packages or seminars.

- **A practical job-skills orientation**—with hundreds of on-the-job examples and exercises, plus self-tests, sample input and output, and plenty of practice in real applications problem-solving.
- **Machine independent**—use with IBM, DEC, Burroughs, Honeywell, and other hardware—you can even train on microcomputers!
- **Complete training in COBOL programming in just 4 books** (15-20 hours of study for each) takes trainees from knowing no programming at all to advanced COBOL commands and techniques.
- **Low cost**—only \$49.95 per volume (less than the cost of leasing a conventional A/V program for one month!)

Future courses cover Ada, JCL, OS Assembler Language, System 370 Architecture, and other topics. For complete information, write to Pam Byers, Dept. 4-1352. Or order direct by phone, and examine any course FREE for 30 days.

CIRCLE 114 ON READER CARD

Write today for more information on any of these Wiley Data Processing Training courses.

Each self-contained volume can stand alone, or work as part of an integrated training program.

INTRODUCTION TO COMPUTER PROGRAMMING
By Judi Fernandez and Ruth Ashley
(1-87024-2)

COBOL SERIES
By Ruth Ashley and Judi Fernandez

INTRODUCTION TO STRUCTURED COBOL
(1-87025-0)

USING STRUCTURED COBOL
(1-87185-0)

TAPE AND DISK FILES
(1-87184-2)

ADVANCED STRUCTURED COBOL
(1-89764-7)

CALL TOLL FREE

1 800-526-5368

In New Jersey, call collect (201) 342-6707.
Order code #4-1352.

VISA, MasterCard, American Express accepted on phone orders.



JOHN WILEY & SONS, Inc.
605 Third Avenue
New York, N.Y. 10158

In Canada: 22 Worcester Road, Rexdale, Ontario M9W 1L1
Prices higher in Canada. 4-1352

PICK UP WHERE IBM® LEAVES OFF.

Portable or desktop, you're way ahead when you pick up a **corona PC™**. Because we give you everything you've ever wanted in an IBM¹-compatible PC and more. For a great deal less.

COMPATIBLE AND MORE.

Our systems run all software that conforms to IBM PC programming standards. And the most popular software does.

We deliver twice the memory, with room for eight times as much.

We deliver a fast-access 320K floppy drive, a communication port and an improved IBM PC keyboard with indicator lights.

Our systems include high-resolution monitors (12" desktop, 9" portable) for crisper, cleaner displays, and both have built-in high-resolution graphics (640 x 325).

You get a complete system, ready to go to work.

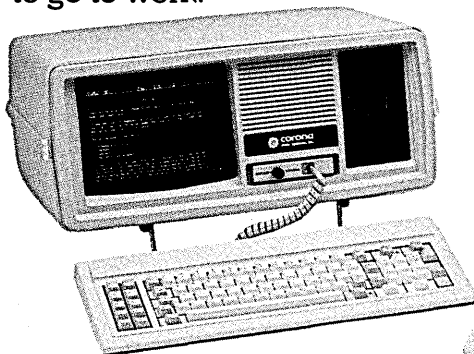

MORE VERSATILITY.

With all the necessary features built into the main unit, the four expansion slots can be used for your special needs. For example, color or our optional 10MB hard disk.

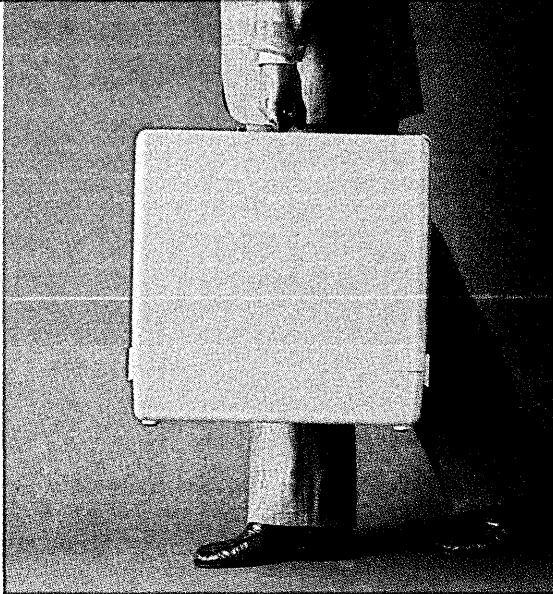

MORE SPEED.

Our RAM-disk software gives you temporary disk-type storage that works many times faster than disks.

PLUS SOFTWARE.

Our systems come with the operating system: MS-DOS.² A programming language:

GW BASIC.² A training course: PC Tutor.³ A professional word processor: MultiMate.⁴ Plus DOS utilities and demonstration programs. Or you can get the p-System⁵ from N.C.I. and write or run portable Pascal packages.

ALL FOR A GREAT DEAL LESS.

Even with all the extra features and performance, our systems still cost significantly less than the equivalent IBM PC.

Drop by your nearest **corona PC** dealer for a very convincing demonstration. Or contact us at 31324 Via Colinas, Westlake Village, CA 91361.

(213) 991-1144 or (800) 621-6746 toll-free. Telex 658212 WSLK, in Europe 76066 CDS NL.

© Corona Data Systems 1983. 1. TM International Business Machines. 2. TM Microsoft. 3. TM Comprehensive Software Support. 4. TM Softword Systems. 5. TM University of California.



corona™
data systems, inc.

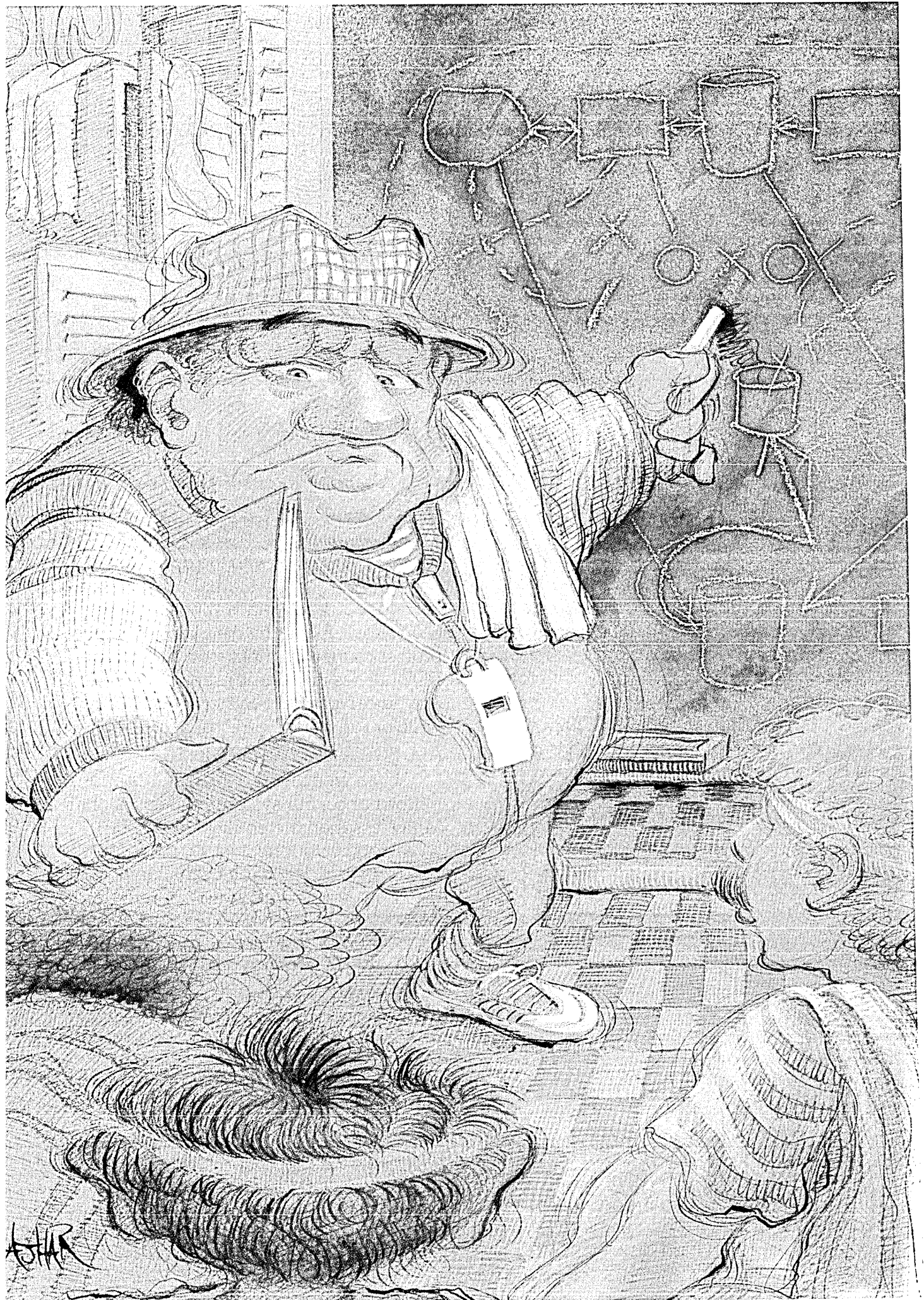

**For the uninitiated to succeed in computing,
they need training, the right equipment—
and good coaching.**

END-USER GAME PLAN

by Hugh Ryan

Systems departments can't keep up with user demands for their services. Recently, end-user computing environments have been touted as the way to cut through the dp services backlog. And, because of the microcomputer's rapidly increasing popularity, more and more end users find themselves in a computing environment. Many people are wondering if they should be moving in this direction; what will it mean for them in one year, or in five years? Of greater concern, these people need to know what factors will make their end-user computing environment productive and successful.

After working in numerous client organizations, I have observed that the following factors are necessary to create such an environment:

- relevant user training,
- coaches,
- evolutionary development of systems,
- appropriate data delivery systems, and
- effective use of fourth generation software tools.

Each of these factors should be part of short- and long-term end-user computing strategies.

Walk into any end-user computing environment and you will probably find that the users come from a variety of backgrounds, ranging from shop floor machinists to MBAs. They are likely to have equally varied levels of knowledge about computers and systems development. Training is needed to build a common foundation of knowledge among these users. They must be trained not only in the tools of the end-user environment but also in computer fundamentals and the rudiments of systems development.

Training must begin at the most basic level. For example, inexperienced users will most likely encounter difficulty translating their computing demands into suitable machine form, organizing the logic so the machine can follow the intention of the designer, and determining the time requirements of the job.

Training, like systems, must be designed and developed. The first step is establishing a curriculum that defines the courses

and their sequence, and includes an overview of each course's content. The curriculum must begin with such basics as turning the terminal on, signing on, and interpreting systems messages. Courses should build on each other, until topics like software products and system development are covered.

It is essential to realize that for end users, the computer is a tool, not a career. Interest in the machine lasts only as long as it assists them in their work. Therefore, users should never leave a course without learning some things that help them in their daily work.

In addition, because users have a limited amount of time for training, the curriculum should be organized into short modules of one half to two days per course unit.

Software vendors often provide material that can be used to train end users, but some customization is usually required. Examples related to the user's specific enterprise are helpful. Promotional and technical data from the vendor will need to be deleted or moved to a later curriculum sequence.

As users advance through product-oriented courses, they'll also need to know about systems development. Therefore, a methodology for systems development and training should be established. Methodologies are now being defined for the end-user computing environment which should facilitate teaching users how to develop a system.

COACHES CAN SOLVE PROBLEMS

Even when the training and methodology are set, unanticipated problems will still arise. For example, I know of a user who was unable to sign on by himself, because in class the terminals had already been on. In another case, a top management person was delayed over a weekend in his task because of confusion about how indexes worked. To prevent these problems from happening, people variously called coaches, consultants, or advisors are needed. By any name, they are key to the success of end-user environments.

One cannot simply designate any individual as a coach and expect success. Good coaches must have several innate qualities.



End users become nonusers when they perceive that their coaches know little more than they do.

The characteristic I have observed most frequently in successful coaches is a "can do" attitude. I know of a coach who, upon learning that a user needed some data that required numerous approvals prior to release to end users, slipped into a tape room, removed the tape under a coat, copied it, and then returned it. While I cannot recommend such an action, it is indicative of the coach's "can do" attitude. In this case, the user drew some significant and timely conclusions with the contraband data.

The successful coach likes to work on many different, short-term projects, and can estimate the effort required for proposed projects. Data processors who derive great satisfaction from long-term projects that require continued analysis of the same area will not be happy as end-user coaches. Good coaches can also make quick decisions on whether a project is suitable for the end-user environment or the systems department.

The coach should be knowledgeable about one or two of the tools employed by end users. End users quickly become nonusers when they perceive that their coaches know little more than they do. This is particularly important when introducing the user to an information center; she must believe the coach possesses a craftsman's knowledge of all the necessary details.

While coaches need an in-depth knowledge of one or two tools, they must also understand the capabilities and limits of fourth generation software tools. Indeed, fourth generation tools in the wrong environment can be counterproductive. The inexperienced user needs a coach to judge which tool is right.

Coaches must get along with end users. A coach should be assigned to an end user based on at least a superficial review of the personal characteristics of the two. Moreover, the assignment should be an ongoing arrangement rather than one based on whoever is available when the user calls. An end user will feel the arrangement is unproductive if she must continually explain the problem to new faces.

The coach must also learn the end user's business. The systems that end users write are closely related to their businesses. They are written in terminology the user knows and are performed as the user would expect. The coach and end user must communicate in the end user's language. I know of one coach who became so involved that he was eventually absorbed into his end user's department, where one of his ongoing tasks is further system development.

As the coach works with higher-level management, the ability to understand and solve business problems is crucial. In the top levels of management, coaches can become

valued advisors, serving almost as a machine interface to get management the information it needs.

End-user systems tend to evolve through many versions. Such development is difficult for most data processors to accept, because it means users won't know their requirements until they see the system. This seems contradictory but can, in fact, be resolved through iterative development of different system versions. The emphasis changes from "What do you want to do with the data?" to "What data do you want?" It is reasonable to expect an answer for the first question, but management cannot answer the second question without seeing the data.

Another feature of evolutionary development is the speed of delivery in any iteration of the system. The system user must see a cycle completed quickly enough to be assured the system is moving forward. While there are many definitions for "quick enough," a common guideline suggests no more than 100 person-days per iteration. This is an upper limit. Many iterations require only a few hours.

COMMITTED USER REQUIRED

A third feature of evolutionary development is a committed, involved user—meaning the user must often write logic for execution. Users will certainly be involved in the heavy initial use of the system and will direct each iteration of the evolving design. This commitment is particularly key to evolutionary development since early versions of the system may be rather rough and may suffer from such problems as program aborts, data exceptions, and logic flows. In this phase, users must see progress toward a desirable system or their efforts will cease.

I know of a system that was developed on an evolutionary basis with extensive user involvement in design coding and testing. The user went through all the problems of the early states—incomplete screens, lost data, and execution time problems. At a later phase, several extensive inquiries were added to the system. After additional criteria were added to one inquiry, run-time increased from one to two minutes to four to six minutes. Yet the user took great pride in the run-time increase because it reflected the additional problems his staff had experienced when doing the inquiries manually. The user was truly committed to the system.

In a successful multi-end-user system environment, expect a proliferation of end-user data stores, along with the problems of synchronization and coordination with the original data source. A typical architecture defined for an end-user environment consists of iteratively developed software, normally

using a fourth generation language. The system uses an end-user data store usually developed for the specifics of the end-user system; that is, one end-user data store serves only one or a few end-user systems.

The end-user data store is maintained by a data delivery system (DDS). The DDS component takes data external to the data store and puts it in a suitable format. Depending upon the tool, there may be a vendor-supplied product that loads the data into the data store. Most systems have more than one DDS. The data source is external—it may be a transaction system database or data supplied by a vendor. Given the wide range of possible sources, a DDS will probably be designed and implemented for each data source.

The DDS is one of the most complex components of an end-user environment. DDSs must handle all the typical problems of a transaction system—such as data validation, reformatting, and extraction—in a typically high-volume situation. In addition, it should address the question of synchronizing the end-user data store and the data source. This alone can be very difficult when adjustments are made to the data source. A well-designed DDS is important to a reliable end-user data store and, in the long term, to the viability of the end-user environment.

The DDS is one of the most underestimated parts of an end-user environment. In the initial enthusiasm about the new environment, selection of suitable hardware and support receives great emphasis; the DDS components may be no more than an extract and load to the end-user data store. To get things going, this quick and dirty effort is reasonable and often advisable. The problems arise when this initial version becomes the model for subsequent DDS efforts. In two to three years, the lack of validation and controls will result in an unreliable end-user data store, and everyone will wonder how it happened.

The DDS is a crucial, but often unacknowledged, portion of the typical end-user environment. It should be used not only to extract and load data but also to validate, cross-check, and apply controls in a high-volume environment. In addition, it must be coordinated and changed as the external data source changes.

ACHILLES' HEEL OF SYSTEM

These requirements imply that a viable data delivery system is similar to a classical transaction processing system and should be developed using the techniques and tools of that environment. This in turn implies that when an end user contemplates a new system, which requires a new data store, then a DDS's component will be developed by dp, using third generation tools. Developed at third generation speeds,

Tear out this coupon before someone rips off your CICS system.

GUARDIAN™

I need more information. Please send literature.

Name _____ Title _____

Company _____ Phone _____

Address _____

City _____ State _____ Zip _____



Fort Lee Executive Park
Two Executive Drive, Fort Lee, NJ 07024
(201) 592-0009, Toll Free (800) 526-0272

DMGTD3

Unauthorized data access and computer crime are problems you can't afford to ignore. And locks, guards and batch protection can't secure your CICS system at its most vulnerable point, your terminals.

That's why so many companies have turned to GUARDIAN™, the security software so effective, it's become an industry standard.

GUARDIAN is comprehensive security. You can protect any number of users, terminals, programs, files and data bases in any combination you choose. And GUARDIAN's new techniques make it easy to define protection down to the field level.

GUARDIAN is easy to implement. Resources needing immediate protection are secure within hours of installation. It's also easier than ever to update GUARDIAN for new rules or personnel. Both temporary and permanent changes can now be made on-line. Most importantly, GUARDIAN provides reports in simple English, so it can be administered by non-technical personnel.

To find out more about the CICS security system with a proven track record, just follow the dotted line or call toll-free 800-526-0272. Don't wait.

CIRCLE 116 ON READER CARD

The DDS is a crucial but often unacknowledged portion of the typical end-user environment.

this component is often the Achilles' heel of the end-user environment because of the long lead time for delivery and the embedding of ongoing third generation components with their inherent inflexibility. Conversely, when done incorrectly, this can lead to serious data integrity problems because of bad or obsolete data.

The presence of fourth generation software tools such as Focus or VisiCalc does not always indicate end-user computing. Many sites have fourth generation tools spinning on disks where they are rarely, if ever, accessed.

End-user computing, however, can be greatly facilitated by fourth generation software tools if they are understood and properly used. Such tools are fundamentally different from previous software tools, with new and varied capabilities. Three distinctive features of the fourth generation software tools are:

- a facility to describe data outside the processes that use the data;
- an assumption on the underlying data design permitting the generation of procedural logic based on nonprocedural descriptions;
- an assumption on the underlying technical architecture providing a place to "put" generated logic.

The need for description of data is not obvious to the end user. For instance, users don't see why it is important to the computer that a field, such as order number, is 10 characters long, or why it is equally significant that order amount is found in a record prior to order cost. For these reasons, most fourth generation tools provide some means to describe data externally. The facility can be used by a dp person to define initial detail descriptions of data that the user can then access in a variety of ways.

A more subtle point of an assumed underlying data design is that fourth generation software is built upon the principle that data structure implies program structure. As a result, one can find report writers that extract from flat files, hierarchical files, or network structures, but it's rare to find efficient hierarchical report writers that can cope with network data structures and flat file report writers that can deal with hierarchical files. Similarly, many on-line generators can cope with a single record per screen but have problems with multiple records. Or, numerous spreadsheet handlers assume that the application requirements can be mapped into a matrix data structure. The point is that program generators are built explicitly or implicitly around an assumed data structure, and it is essential to understand these structures.

The software also makes a set of assumptions about technical architecture. Is it batch or on-line? If on-line, is it conversa-

tional? If conversational, will it protect records across exchanges? If batch, can it be invoked by the user program? The user and/or coach must be aware of the assumptions.

Yet the need for awareness seems to contradict the concept of fourth generation software. Why is it necessary to be aware of assumptions when the software is supposed to free users from computer concerns? In the beginning, one can stay within the assumptions because of the simplicity of initial efforts. But with experience, the end user becomes confident and desires to do more. Eventually, unless the assumptions of the tool are understood, they will be violated, making the tool counterproductive. When this occurs, one must wait for the mythical "next release" of the tool, or stop doing whatever created the problem.

FOURTH GEN TOOLS USEFUL

Fourth generation tools are prevalent in end-user environments. They provide large productivity gains when requirements conform to the design assumptions of the product. They also provide productivity disasters when the data and architecture assumptions are ignored or misunderstood by end users and their coaches.

Does the basic nature of systems development change in an end-user computing environment? Practitioners in the field consistently say yes. Over the last year, I worked on a project that evaluated the suitability of classic methodologies for an end-user environment. The model we used identifies six major phases in an end-user environment systems development:

- define functional requirements—establishes what the system is expected to do;
- define data design—develops a data design to support the system, based on functional requirements;
- design technical architecture—describes the system's major processes and how they interrelate;
- system design—delineates the system based on data design and technical architecture;
- implementation—transforms the system design into a machine-executable format;
- testing—ensures the system performs the expected functions.

In our model, data design precedes and largely dictates system design. Such a methodology is referred to as a data-structured development methodology.

We found that the evolutionary development approach and fourth generation tools used by most end users implied some fundamental changes to the development process as described in the data-structured methodology. First, functional requirements are not defined in end-user computing; rather, the

question is what data are needed. This question is not the typical functional requirements view. Second, in data-structure methodology, the database design is driven by how the user will use the system. In end-user environments, these functional requirements are not available before the system is designed, but instead evolve with the system. As a result, we could not do data design as typically defined in a data-structured methodology. Finally, technical architecture and system design are driven from the data design, which, of course, is not available.

Fourth generation languages impose a data design on the user as well as a technical architecture. These two observations proved key in defining a development methodology for end users. The first point means that rather than do a data design, one should understand the language's underlying data design assumptions and fit requirements into this data design. And, rather than design a technical architecture for a fourth generation language, the objective should be to fit the design to the technical architecture provided by the language.

ACCESS TO EXPERT IN LANGUAGE

The successful user of a fourth generation language should have access to an expert in the language—ideally the coach mentioned earlier. The coach's knowledge and experience are central to the effort's success.

A methodology for end-user computing was established in the project; it is iterative in nature with great emphasis on user involvement in fitting requirements to the fourth generation tools' assumptions.

We have had enough dp experience to know there are no general solutions to all the problems. End-user computing is one more way to get information to the people who need it. As such, it offers an exciting opportunity, but we must be aware of the problems. Certainly, end-user computing provides real benefits. If it is to succeed, a few key moves must be made initially, which will lead to long-term success in this new and fascinating field. *

Hugh Ryan is a partner with Arthur Andersen & Co. He joined the firm in 1971 with a master's in mechanical engineering. Over the last six years he has concentrated on structured methods for software engineering.

REPRINTS AVAILABLE

Reprints of all DATAMATION articles are available in quantities of 100 or more. Details may be obtained by telephoning Mary Ann Hariton, (212) 605-9729.

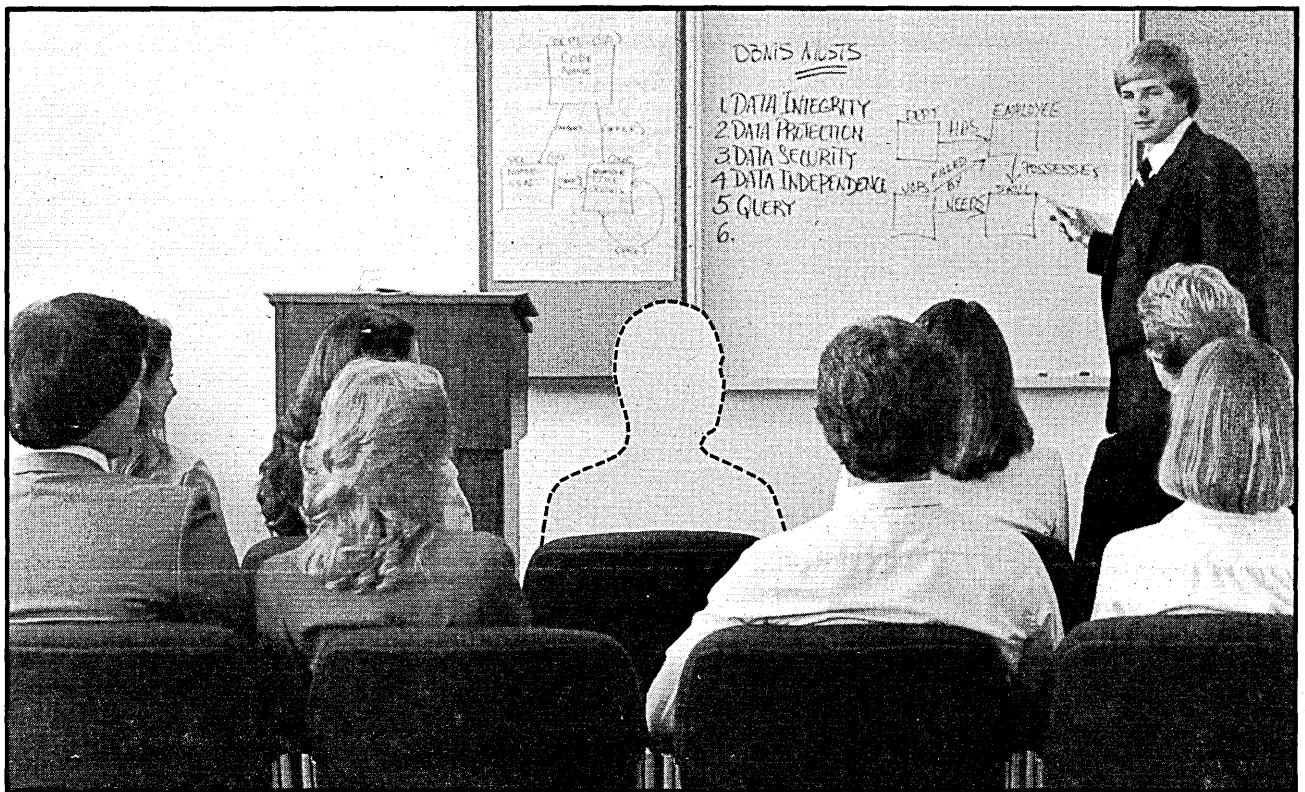

Reserve your place today. We'll give you a front-row seat to success.

ISE-USA Professional Training Seminars on Microcomputer Application Development

The microcomputer is here to stay. As a smart Information Management Professional you know that micros are rapidly becoming a key to business success.

Learn how to use them wisely, and you'll be able to take full advantage of the growing micro revolution. Build top quality application systems on micros, while maintaining data integrity and security, and you could save a small fortune. Or make one.

That's why ISE-USA has developed this special training program—to help you understand the fundamentals of data base management systems *and* to show you how to solve the kinds of problems you could formerly solve only on a mainframe.

It's the kind of in-depth, practical, concentrated learning program you need to update your thinking, and discover the true potential of today's micros.

Three-day Seminar and Workshop on Microcomputer Application Development
Basic principles and inner workings of data base management: a must for anyone who wants to stay abreast of today's rapidly evolving information processing technologies.

Learn such valuable techniques as...

- State-of-the-art data base management
- How to design logical data structures for your application problems and create effective, efficient application software solutions
- How to assure data integrity and utilize recovery procedures
- Taking full advantage of tools for ad hoc query processing and interactive data manipulation
- Guaranteeing data security, handling multiple simultaneous users, performance tuning, design modification, and more

Taught By: Leading authorities on microcomputer data base management for applications systems development.

Sponsored By: International Software Enterprises, Inc. (ISE-USA), a member of the worldwide network of ISE companies.

In Cooperation With: Micro Data Base Systems, Inc. (MDBS), one of the world's leading microcomputer software firms; creators of superior data base management software for mini and microcomputers and the first company to develop an authentic, full-featured data base management system for a wide range of microcomputers.



Guarantee

ISE-USA assures all attendees that only proven and available state-of-the-art microcomputer software development tools will be used in this seminar. Chief among these is MDBS III, an extended network, post relational DBMS which is preferred worldwide for serious micro application development. Many of its features are not yet available on mainframe DBMSs.

MDBS III is a trademark of Micro Data Base Systems, Inc.

Enroll me today! Enclosed is a check or money order for \$500*.

Sounds great, but I need more information.

*Illinois residents, please add 6% sales tax.

Name _____

Title _____

Company _____

Phone () _____

Address _____

City _____ State _____ Zip _____

MAIL TO: ISE-USA, 85 West Algonquin Rd.,
Arlington Heights, IL 60005

OR CALL: (800) 323-3629, In Illinois call
(312) 981-9200

New for VAX

DBMS Bliss

Now there's software that users can use, programmers can program, and managers can manage.

Don't despair. If you've been frustrated waiting for ideal data management software, your worries are over.

The answer is System 1032™ DBMS for your VAX. And you can sample it at no risk or obligation. Here's the story.

Responsive Assistant

System 1032 provides a common-sense relational approach to data management, without the burden of relational calculus or SQL. Users easily grasp both simple and complex data relationships, and assistance is right at their fingertips. Special function keys make it easy to complete commands, quickly learn new ones, and see explanations of options and parameters, even in mid-command. So there's no need to struggle with a manual in the lap or consult an already-hassled wizard.

Best of all, System 1032 is fast and pretty. It answers complex queries almost instantly and produces presentation-quality reports with single commands.

Designer's Delight

Don't think it's a toy, though. Sophisticated applications designers can

program in any VAX language, including System 1032's built-in block-structured language, and still access all of System 1032's powerful data management tools. A complete range of data types, format definitions, shared data structures, and other advanced features ensure that System 1032 easily satisfies the most demanding needs.

If you're a manager, you'll especially appreciate System 1032. Your users and programmers all use the same unified command language and data base concepts, so communication between them is easier than ever. And System 1032's careful human engineering drastically cuts your training costs and increases productivity.

Plus we exploit the best of the VAX architecture with shareable native code, asynchronous I/O, and propri-

etary inverted files—efficiently! So, unlike other software, System 1032 won't force you to buy more memory, disk space, or CPUs.

Risk Free

Software House has an impeccable decade-long reputation for reliable software and responsive technical support. System 1032 is the offspring of System 1022,® the most widely used DBMS for DEC mainframes. Its step-oriented commands and relational design have proved themselves in years of use at hundreds of sites. And System 1032 has undergone extensive field-testing to ensure that it works right the first time for you. Although new, System 1032 is already the most mature DBMS available for your VAX.

Convince yourself. Try System 1032 on your own VAX with your own data. A 60-day trial period costs just \$85. Verify our claims, browse through our manual, and test our hot-line support service. Compare and benchmark System 1032 against other software, relational or not, at whatever price. Then sit back in bliss and watch your end users and programmers accomplish more, faster than you thought was possible.

So don't delay. Call us today, or send in the bliss coupon.

© Copyright 1983, Software House.
System 1022 and System 1032 are trademarks of
Software House. VAX is a trademark of
Digital Equipment Corporation.

System 1032™

- Please call me.
 Send me the latest on System 1032.

My VAX environment is:

- 11/782 11/730
 11/780 On order
 11/750 Under consideration
 My company is an OEM

Name _____

Title _____

Company _____

Address _____

City _____

State/Prov _____ Zip/PC _____

Tel _____

DM1283

Send to:
Betsy Ziegler
Software House
1105 Massachusetts Avenue
Cambridge, Massachusetts 02138
Tel: (617) 661-9440

Software House

"dBASE II[®] gave us something that money can't buy."

*Richard Sommers
Lead Programmer/Analyst
at a major health
maintenance organization.*

"dBASE II gave us time.
"And in the research
battle against breast cancer,
time is an invaluable
weapon.

"Our research people
are not computer people.
They're doctors and nurses.
So I had to write a customized
'layman's' application for them *very fast*."

**"My program development speed
even impressed me!"**

"Using dBASE II, the relational
database management system (DBMS)
from Ashton-Tate, I was able to quickly
develop a very large and sophisticated
program for research data storage and
analysis. The real beauty of the new
program is its speed and ease of use.
A simple two-word command starts the
program, so data can be entered much
faster. And when our researchers need
to query the database, they ask their
questions in English using medical
terminology familiar to them, without
having to deal with computerese.

"In the past few months, I've
recommended dBASE II to at least four
of my programming colleagues in other
hospitals."

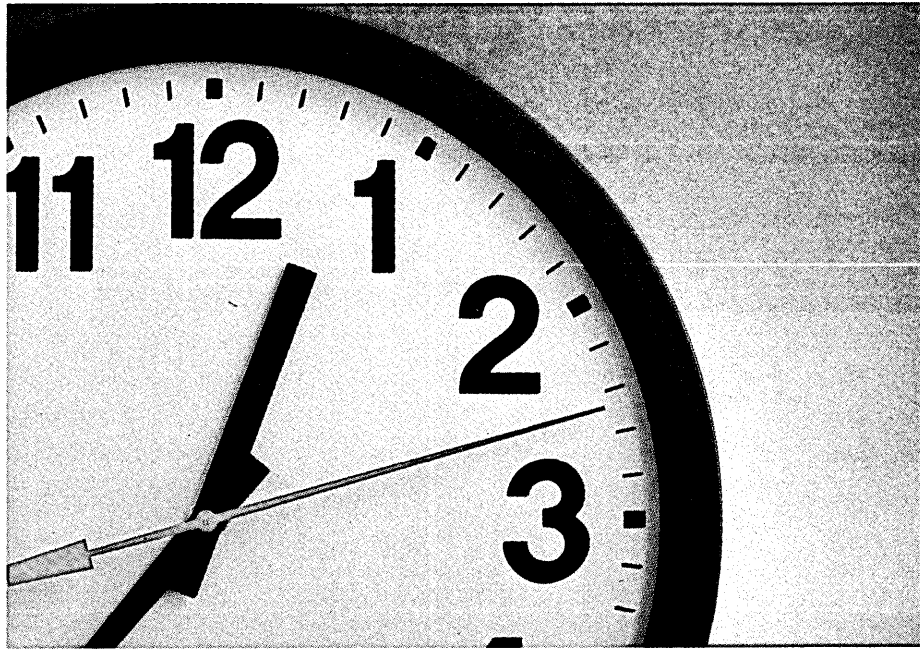

Put time on your side with dBASE II.

When you're customizing an
applications program and fighting the
clock at the same time, you won't find
a faster, more flexible solution than
dBASE II* from Ashton-Tate. We'll be
glad to rush you all the details. Ashton-
Tate, 10150 West Jefferson Boulevard,
Culver City, CA 90230. (800) 437-4329,
Ext. 217. In Colorado, (303) 799-4900.
In the U.K., call (0908) 568866.

ASHTON · TATE

*Suggested retail price, \$700.
dBASE II is a registered trademark of Ashton-Tate.
©Ashton-Tate 1983

●● If I invest in a multifunction workstation, how can I be sure it'll communicate with what I already have? ●●

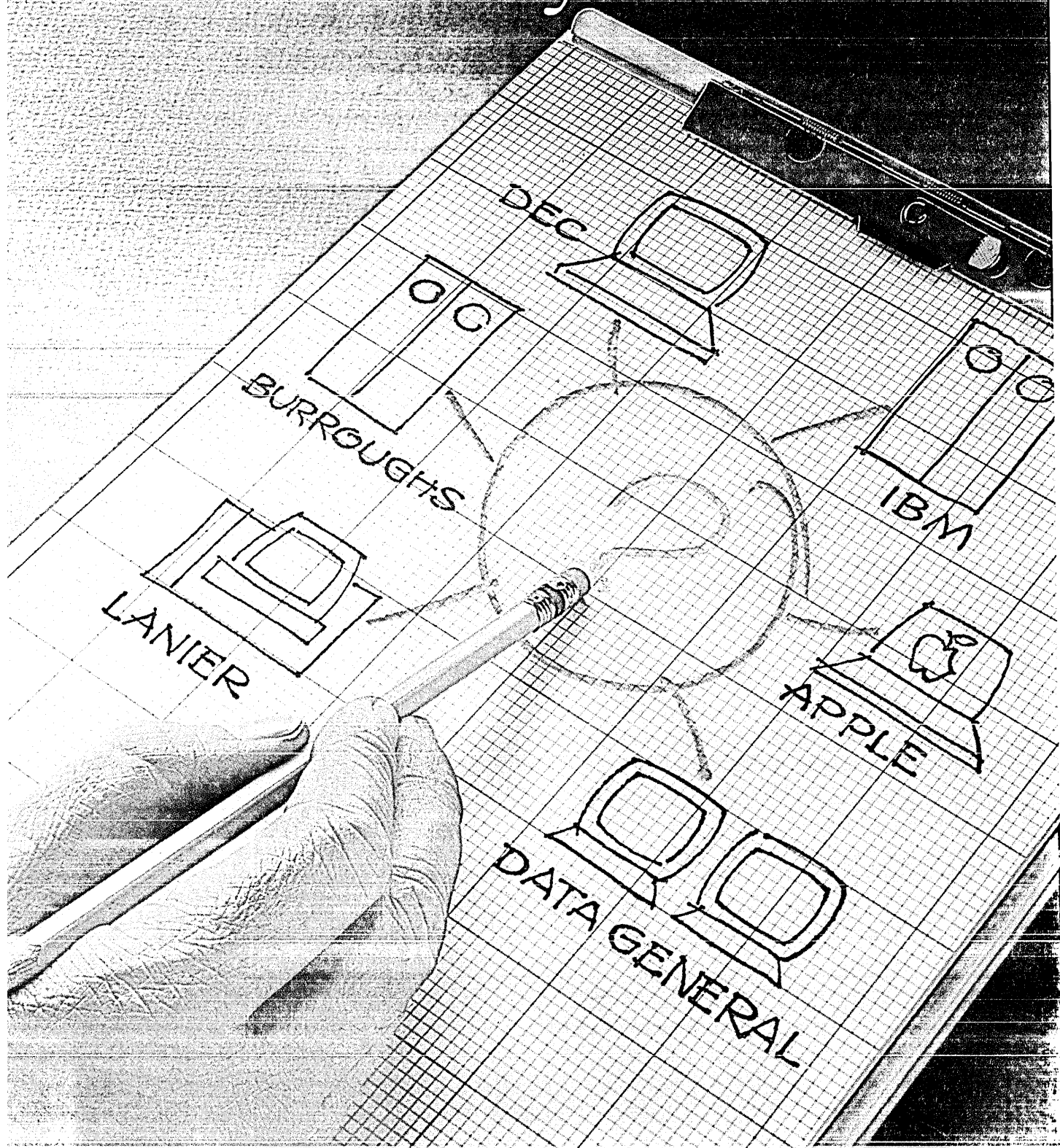

Northern Telecom's information processing products have the communications capability you need.

Besides being compatible with each other, Northern Telecom's 503 desktop computer and 565 and 585 information processing systems communicate effectively with a multitude of mainframes, including IBM, Burroughs and CDC. They also talk to other minis such as DEC, Hewlett-Packard and Data General. Not to mention word processors such as Lanier, and even micros such as TRS-80 and Apple.

This means you'll have more flexibility—and more control over your information system. Even if more and more personal computers are becoming a part of it. Our 500 family supports the CP/M* operating system software, so employees can have the personal computing capabilities they want, while your company keeps the organizational unity it needs.

At the same time it's running CP/M, the family can also be running its own unusually powerful operating system which is compatible across the whole 500 line. It permits a unique approach to multitasking—with a few simple keystrokes, up to 16 tasks can be performed simultaneously on the same terminal. Data processing, personal computing, spread sheets, word processing, information management, electronic mail, whatever task needs to be done can be done at the same time. An incredible timesaver.

All in all, the 500 series is quite a family. Versatile, reliable and a perfect example of Northern Telecom's OPEN World* commitment to compatibility. Northern Telecom is a world leader in digital technology and we're using this expertise to make sure our products fit comfortably into a multivendor world.

For more information, call 800-621-6476 (in Illinois 800-572-6724), or write to Northern Telecom Inc., P.O. Box 10934, Chicago, IL 60610.

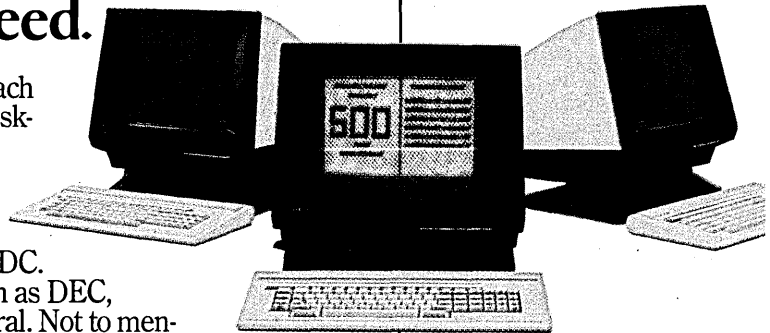

The 500 Family.



©Trademark of Digital Research Inc.

*Trademark of Northern Telecom Limited

CIRCLE 191 ON READER CARD

WHEN YOUR TERMINAL NEEDS A MODEM...



LYNCH ANNOUNCES THE 24-HOUR

When was the last time you ordered a modem, only to find there would be a two, three, even six-week delay in delivery? Introducing Lynch's new 24-hour Modem Express that puts virtually any modem on its way to you within 24 hours.* For more information on Lynch's 1200 to 9600 bps modems and 2 to 16 port statistical multiplexers call the Modem Express Hot-Line. We're out to serve you better!

*All orders subject to items in inventory. Large orders may cause delay.

Lynch
COMMUNICATION SYSTEMS INC.

**CALL MODEM
EXPRESS HOTLINE
1-800-421-0068**

204 Edison Way, Reno, Nevada 89520
Telex: 95-4429, 800-421-0068.
In Nevada (702) 785-8700
IN CANADA CONTACT:
LYNCH-TRANSOM INC.
239 Belanger Street,
St. Jerome, Quebec J7M1K7, (514) 486-6225

CIRCLE 133 ON READER CARD

PEOPLE

HELPING OTHERS COMPUTE

These are not the kind of surroundings one expects when visiting a Washington-based computer organization. Then again, this is not the typical computer association.

This is the Public Interest Computer Association (PICA). It is the creation of Marc Rotenberg, Harvard '82. It isn't exactly what he had planned.

"I came at it backwards," Rotenberg admits. "My real interest was chess. I played around a lot with computers and chess, and I wondered what it would take to make a good chess program. Eventually I did a backgammon program which was pretty good. The chess program never got off the ground."

Well, we all get checkmated now and then. Undaunted, Rotenberg entered Harvard with every intention of being a social studies major. That's the major with which he graduated. But after he took Introduction to Computer Programming in his sophomore year, his major became minor.

The next year he became a teaching fellow in computer science. His senior year he was a co-head teaching fellow with a graduate student in computer science. The two hired 25 other teaching fellows. Rotenberg also lectured on game algorithms.

Next stop, Washington.

"When I left school I wanted to work with Mort Halperin [at the Center for Security Studies]," Rotenberg says. "They're closely associated with the ACLU, and I'm very interested in their issues. I told them I wanted to do substantive work and I

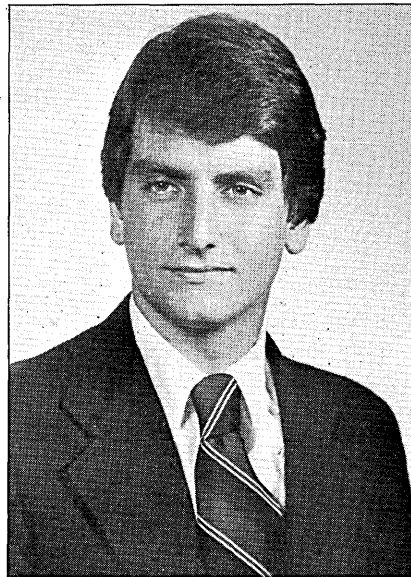

MARC ROTENBERG: "It's very exciting to be doing what no one else is doing."

was also very interested in computers.

"They said, 'Well, we've got a computer. Maybe you can take it out of the box and help us plug it in or something.' It turned out that every public interest group in Washington was looking at computers. So Mort asked me to talk to a friend of his. Then he asked me to talk to someone else. Pretty soon I was talking to 20 or 30 people and thought this was a prime chance to do something."

Thus PICA was born last March. To find it, take the first door on your left in the basement of a large Capitol Hill town house belonging to Stewart Mott, philanthropist extraordinaire. To call the interior decorating "early pipe" would be overly generous. The part of Rotenberg's desk not occupied by a Kaypro computer is cluttered with magazines. The shelves are stacked neatly

with trade publications. The telephone rings approximately every 60 seconds. Somebody wants to know how to delete in Perfect Writer or whether there is an addition to their dBase II program that will allow them to do graphics.

"The real problem is, that everybody is used to working with a consultant," Rotenberg says. "I'm hoping to move people to a user group style. Having a single consultant is not practical and too expensive when you have a small budget and small staff. As hardware costs fall more dramatically, you're not going to pay someone 70 bucks an hour to talk about a \$2,500 system. With PICA I'm just trying to get people with similar problems together."

They're coming, they're coming. So far about 40 organizations, including the ACLU, Americans for Democratic Action, and the Center for Science in the Public Interest, have said "I do," at \$50 a hit. Rotenberg says there are several hundred individual members (\$8 for students, \$15 for the working class). For their money, members receive classes three nights a week for the first three weeks of each month, workshops, seminars featuring a prominent speaker, and the bimonthly newsletter, *Nexus*, which "attempts to bridge the gap between people and technology," according to the PICA brochure. *Nexus* topics include "Information Management for Non-Profits," and "Looking at 1984." The gap is apparently being bridged, since *Nexus* went from 12 pages in its first issue to 20 in the second.

What members may also get for their money are some raised eyebrows, funny looks, and not-so-polite questions. Such as: just who defines "public interest"?

"That's probably going to come back to haunt us," Rotenberg admits. "Our emphasis is on building bridges, not walls. We're not trying to say 'these people are on the inside and all you others are on the out-

PEOPLE

side.' We don't have any restrictions on our membership.

"Certainly I think the membership is pretty much defined by being nonprofit-making groups with small staffs and limited budgets. I think 'public interest' means the type of organization and what its goals are. But it's not simply political. People have jumped on that and said, 'It's a bunch of leftists or something.'"

Maybe it is. Maybe it isn't. Whatever their ideology, these groups have a number of questions about how best to use their computers. Until PICA, no one was listening. Now Rotenberg wants to be the groups' answer man.

This is no stroll in the park. Rotenberg pays himself \$25 a week, which he augments by writing articles and consulting. His family takes care of the rest. (Rotenberg's brother, Jonathan, founded the Boston Computer Society, a large, nonprofit computer organization, when he was 13. Jonathan is now one of the industry's leading show promoters).

This is also no 9-to-5 day. Rotenberg answers calls, meets with members or prospective members, writes reports, and teaches class during the day. Then, after dinner, he comes back for a second day, which starts at 9 p.m. and ends at 2 a.m. During that times he writes, edits, and works on programs.

"It's very exciting to be doing what no one else is doing," Rotenberg says. "I really enjoy my job. But there are sacrifices. I don't plan on living off my family for the rest of my life. And doing something new always carries a certain amount of concern that you're going to fail or you're going to make a mistake. Then people will say, 'What was that?'"

"We don't have any five-year plans. If this doesn't fly, it won't be for lack of interest. But I'm looking in the next year to establish financial stability and an organizational structure that's going to endure. It would be an appropriate goal for the organization if I could walk out of here and the organization could survive."

All his members would agree. So would all his prospective members. And therein lies the rub. Are there enough "public interest" organizations in the great computer wilderness to make PICA a self-sustaining organism? Unquestionably. Are there enough with computer troubles willing to pay their money for PICA's time? No one, least of all Rotenberg, knows the answer to that.

"The most exciting thing about what we're doing is that it's balanced," Rotenberg contends. "We're not out to smash the machines. Our members aren't out to smash the machines. They're buying them. The machines have very useful, very

helpful applications and we'd like to promote that. Technology isn't necessarily bad. We can control it and we can learn how to use it. But it requires learning about computers and keeping in mind what our goals are. If PICA's done anything so far, it's that we've kept that out front.

"We're not fighting any battles now. I don't think we will be. If we get political, we're going to run into a lot of trouble that could jeopardize our position."

That position is simply to be the Help button on the public interest user's keyboard. Forget the consultants. Get together with your own kind and share your problems with your Kaypro or Televideo systems. All Rotenberg seemingly wants to do is save these folks some money. If he makes some along the way, that's okay. If he doesn't, that's okay, too. For now.

"This isn't that dramatic," Rotenberg says. "The most dramatic thing is that someone hadn't done it before. People talk to me and say, 'This is a great idea. You're really helping to meet a need.' That's great payment for me. I'm willing to take a year or two from my life to get a certain amount of that."

And when that gets old?

"I've always wanted to go to law school," he says. Spoken like a true social studies major.

—Willie Schatz

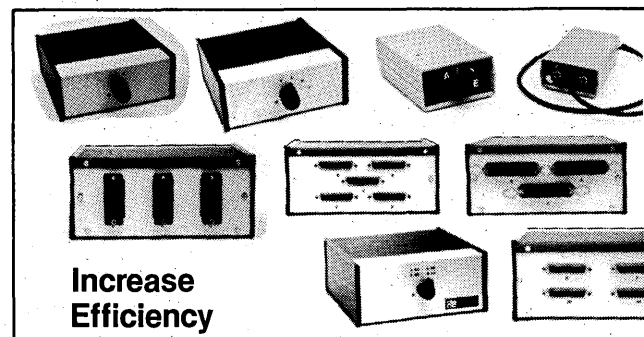

Increase Efficiency

\$Switch-it\$

Switch Boxes add to the versatility of your computer installation - avoid adding redundant hardware and changing cables between terminals, modems, CRT's. Make CPU's and peripherals do extra duty. More than a dozen different kinds of ABC and ABCDE Switch and Transfer Boxes IN STOCK, including dual coax for Wang users. Economical, too - for instance:

Ultra-Compact Locking Toggle ABC	
Single BNC Coax	\$55.00
RS-232 ABC	\$99.50

Call or write for information and new catalog.



Data Set Cable Company, Inc.
 East: 722 Danbury Road—P.O. Box 622
 Ridgefield, Connecticut 06877
 (203) 438-9684 TWX-710-467-0668
 West: 3001 Contract Avenue
 Las Vegas, Nevada 89101; (702) 382-6777

ALL YOUR DATA COMMUNICATIONS & TELECOMMUNICATIONS NEEDS



- Racal-Vadic Modems
- Test Equipment
- Short Haul Modems
- Switches
- Protocol Converters
- Multiplexors
- EIA Cables and Connectors

Modem Mart features Racal-Vadic's 212PA Modem

JUST A PHONE CALL AWAY

IN OHIO
(800) 362-6883

OUTSIDE OHIO
(800) 321-2510



MODEM MART
 905 Bassett Road
 Cleveland, OH 44145

Coming your way in February, 1984!

MANUFACTURING TECHNOLOGY:

A REPORT TO MANAGEMENT

A special supplement appearing in February in
3 of the business world's most influential magazines—
DATAMATION • DUN'S BUSINESS MONTH • SOFTWARE NEWS

Manufacturing Technology:
the return route to leadership in
productivity for U.S. industry.

Manufacturing Technology: the
most compelling topic today among
manufacturing top management...
among industry's data processing
and software/systems professionals.

Ad Closing December 1
All 3 magazines will publish this land-
mark supplement in their February
issues. At special rates *far less* than
the combined advertising rates of
these outstanding publications. For
full details call Charles Keil, Technical
Publishing Company, 875 Third Ave.,
New York, NY 10022. (1-212-605-9460).

500,000 Readers

This special section will be read by
a prime audience of over 1/2 million
management and technical decision-
makers. The buying influences most
essential to manufacturers of:

- Computer/peripheral hardware
and systems
- Manufacturing Resource
Planning (MRP II) software and
services
- CAD/CAM systems
- Robotics equipment
- Data Collection and factory auto-
mation systems and equipment

What's in it...

**MANUFACTURING TECHNOLOGY: A Report
to Management** describes the productivity
improvements possible through Computer
Aided Design; Computer Aided Manufac-
turing; Computer Graphics; Robotics; and
Manufacturing Resource Planning. There's
also a complete classified directory of vendors
of the latest equipment and software in
all categories.

... and what's in it for you

For perhaps the first time, both technical and
top management purchasing influences
are brought together in one total, dynamic
audience. Editorial experts from all 3
magazines offer a coordinated perspective
on the potentials, rewards and effects of
emerging technologies. A rare event, a rare
advertising opportunity.

Technical Publishing

EB a company of
The Dun & Bradstreet Corporation

3 magazines

CIRCLE 120 ON READER CARD

Software News

Vol. 3 No. 7

SERVING SOFTWARE DECISION MAKERS

1 mission





XEROX

Introducing a quantum leap in developing complex applications.

Developing large-scale software systems involving complex tasks, such as computer-aided design, expert systems and VLSI circuit designs, is no longer the time-consuming job it used to be.

Now you can do it in months, instead of years.

Because the new Xerox 1108, a compact, low-cost workstation, speeds things up by handling the drudgery of programming for you. Quickly and accurately.

It offers integrated, interactive facilities for program development, editing, debugging, executing, filing and documenting.

It simplifies things even further with its large, high-resolution display, keyboard, mouse and facilities for the Ethernet local network.

And you can use the same Xerox 1108 for economical widespread delivery of your completed systems.

The culmination of 10 years of development in Lisp-based processors by the Xerox Palo Alto Research Center, the Xerox 1108 software is based on the Interlisp-D artificial intelligence programming technology.

For complete details, write to Marketing Manager, Xerox Special Information Systems, 250 North Halstead Street, Pasadena, California 91109, or call (213) 351-2351, extension 2128.

**The Xerox 1108.
Team Xerox.**

HARDWARE

OFF-LINE

Current wisdom holds that the only dp manufacturers that will survive the next few years are those who can swallow their pride and admit that customers have merchandise from other vendors in their shops. (IBM is the obvious exception.) Two vendors that deserve credit for moving to a standard architecture are Wang and Hewlett-Packard. Wang's Systems Networking products were designed specifically to make it easy for hardware from other vendors to hook up to the Lowell, Mass., vendor's products. The HP 150 is unique in the Palo Alto manufacturer's personal computer product line because it uses a standard 8088 chip and the MS/DOS operating system. Those, not the touted touch screen, will be responsible for the machine's success.

The wait for the SX-2000 digital PBX from Mitel grows longer. Latest word is that the product won't be out until April, although a 0.8 release with full telephone features and most of the other promised functions will be available next month. Field upgrades are possible since the 0.8 and 1.0 versions use identical hardware. Enhancements currently slated for October 1984 include local area networking, terminal strategies and interfaces, and imaging; the problem is that many of the Ottawa vendor's competitors, such as AT&T, Rolm, and Intecom, already have some of those features. Mitel faces similar problems with its SX-200 and SX-100 analog PBXs. The company's Project Arrow is expected to convert these PBXs into digital switches by 1985 by adding a new cabinet alongside the existing one; that may seem like a kludge compared to existing digital switches made by others.

Until a single standard communications protocol becomes a

reality, the market for protocol converters is sure to grow at a healthy clip. Latest entry into the fray is Micom's Micro7400, which debuted two weeks ago at COMDEX. Like units made by Datastream communications and Tri-Data, the 7400 provides an IBM gateway for a dozen async terminals or PCs; it fully supports both BSC and SNA and lets terminals switch among a pair of IBM hosts or minis. Unlike other devices, the unit treats terminal/printer combinations as separate logical devices using a single multiplexed line, so that printer output is sent directly to the printer and screens are sent directly to the crt. The unit comes with do-it-yourself troubleshooting and channel configuration capabilities. It also has a unique keyboard mapping scheme: users can choose to map 3278 functions to identical key locations on the async device, regardless of the key labels, or they can map 3278 functions to identical key labels regardless of key location. Prices range from \$2,250 to \$4,750.

You can't fault Curtis Powell for his reason for spinning Genicom out of General Electric. As GE's Data Communications Products Business Department, the company had to send part of its profits to GE headquarters for corporate use. As Powell, now Genicom's ceo, said, "In the past, that which I earned I sent to Fairfield; now, that which I earn I keep." The Waynesboro, Va., firm acquired all of GE's printer businesses. Genicom is readying a second quarter intro of the 4000 matrix line printer, a prototype of which was shown at NCC. It uses three identical printheads, each of which prints a third of a line. The result is a hybrid capable of 900 lpm with user-replaceable printheads and higher reliability, the firm says.

SPEECH PROCESSING

The Speech Command plug-in board for this vendor's Professional Computer accepts voice commands and allows the computer to deliver vocal feedback. The package is intended primarily for applications

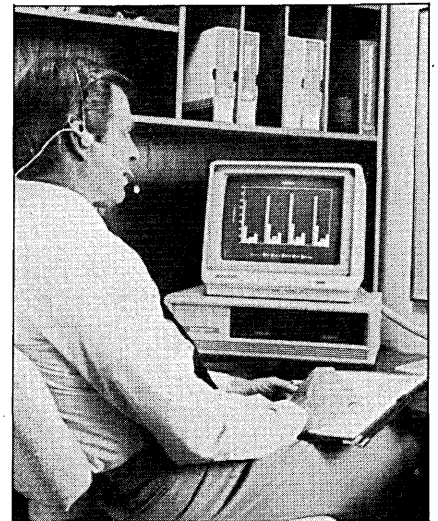

that require the user's hands to be away from the keyboard, although keyboard and voice input can be mixed.

The system essentially translates voice commands into their equivalent strings of ASCII characters for transmission to the cpu. The voice commands need not relate to the actual command: the vocal command "log me in" may be used to send the entire log-on/password character transmissions, but the user can define "Hudson River" to mean the same thing.

The user must have a sufficient understanding of any application before he can convert it to a voice-entry system. He then enters the character string at the keyboard and speaks the corresponding voice command into the system. (A small headset with microphone is provided.) The system usually needs three successive entries of the same command, in different contexts, before it is fully trained. A rating system indicates how accurate the training for any given command is.

HARDWARE

The product can support nine vocabularies of about 50 commands each; each command can substitute for up to 40 keystrokes. The system costs \$2,600.

A Speech Command Software Development Kit is available to facilitate the conversion of applications to the speech system. It consists of a software development guide, a run-time diskette, and nine programs: speech record, playback, and recognition programs in BASIC, C, and Pascal. The development system costs \$8,000. TEXAS INSTRUMENTS INC., Austin, Texas.

FOR DATA CIRCLE 301 ON READER CARD.

OPTICAL DISK

The 7600 optical storage subsystem is designed to provide large users with high-capacity, random access, removable storage media. Each drive can store 4GB of data on the surface of an optical platter, and transfers that data to the host at 3 Mbps. Platters can be removed and stored for up to 10 years, the vendor says.

The 7600 subsystem consists of the 7640 optical storage unit, the 7440 optical media unit, an 8880 controller (the same used for 8380 disk drives), and Optical Storage Access Method (OPSAM) software that allows the host cpu to write data to an optical media unit and retrieve that data as necessary. The system is fully compatible with all IBM mainframes running under the MVS/SP 1.3 operating system.

The unit's error-detection and correction capability ensures that recording errors will occur at the rate of one per 10 trillion bits, or one bit per 312 platters. The media is not erasable and is enclosed in a protective cartridge. The 14-inch platter is automatically loaded onto the spindle from the cartridge prior to use and automatically replaced in the cartridge after use.

A dual path capability allows up to

eight 7640s to be switched between two 8880 controllers. A single 7640 costs \$130,000. Each optical media unit, which consists of a single platter and cartridge, costs \$225, with volume discounts as much as 35% off. The OPSAM software carries an installation charge of \$1,000 and a monthly fee of \$400. Volume shipments will begin in the second quarter of 1984. STORAGE TECHNOLOGY CORP., Louisville, Colo.

FOR DATA CIRCLE 302 ON READER CARD

CBX

The CBX II, as its name implies, is a direct follow-up to this vendor's seven-year-old Computerized Branch Exchange (CBX); any CBX can be retrofitted to produce full CBX II capability. The new product can accept data, async or bisync, at up to 64Kbps, as well as analog and digital voice connections. All voice and data connections are brought to the CBX II system over twisted pair wiring and terminate on the same line cards as those that are used in the prior system. Six racks of 32 cards each are enclosed in a single cabinet; three such cabinets constitute a CBX-II switching node.

Each node contains either the 8000 16-bit processor or the 9000 32-bit processor, and uses the MetaBus 1 or MetaBus 4 system backplane. Between nodes, voice/data communications can be carried via analog tie-lines, digital interties (which multiplex several calls onto one digital T1 link), or inter-node links (INLs) and inter-node networks (INNs). A fiber optic INL can carry up to 294 Mbps between nodes 20,000 feet apart. An INN is composed of several INLs, which can service from 4,000 to over 10,000 lines and provide nonblocking 64Kbps data to each. Total system bandwidth is 4.4 Gbps.

Three features have been added to the MetaBus 4 that were not available on

previous CBXs. A broadcast mode allows one device to transmit to a number of listeners simultaneously. A shared-access mode provides common broadcast bandwidth to a number of cards and allows the cards to arbitrate among themselves for access. This mode can be used to implement a packet switching service directly embedded in the CBX II. And a supermultiplexing mode allows groups of time slots to be allocated to provide high-speed switching services. In this mode, bidirectional high-speed data streams of 32 Mbps are possible. At press time, no price structure had been set for the CBX II. ROLM CORP., Santa Clara, Calif.

FOR DATA CIRCLE 303 ON READER CARD

PC EMULATOR

The PCE personal computer emulator gives VT100 terminal users the capability of performing local processing. The vendor says that the unit can upgrade any VT100 or compatible terminal into an IBM Personal Com-

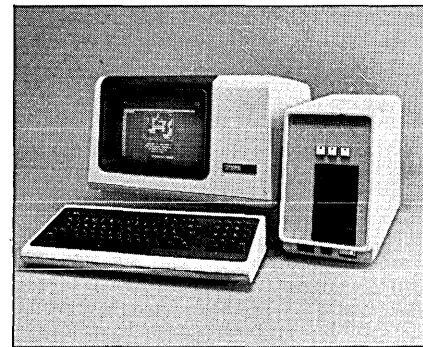

puter emulation, without disrupting any existing data processing network.

The unit does not permit direct communications between the P.C. emulation; the crt can act as either a P.C. or a terminal at any time, but not as both simultaneously. While the unit is emulating the P.C. it permits concurrent transparency to the host, so that a user can switch anytime between a mainframe application and a P.C. application without disrupting either. A split screen capability allows users to see information from the mainframe and the P.C. simultaneously. (A file transfer package is promised so that the P.C. will eventually be able to communicate directly with the host.)

The 11½ × 7½ × 16½-inch unit is designed to be placed alongside the terminal. It includes the 8088 microprocessor and can run any IBM-compatible operating system. It has 128KB of RAM (expandable to 512K) and comes with two 5¼-inch floppy disk drives. A 10MB Winchester disk drive and a battery backup capability are available as options. The PCE costs \$2,800. SOLARIS COMPUTER CORP., Santa Clara, Calif.

FOR DATA CIRCLE 305 ON READER CARD

MINIS

The 16-bit DPS 6/45 and DPS 6/75 minicomputers and the 32-bit DPS 6/95 supermini-computer all run the GCOS 6 operating sys-

HARDWARE SPOTLIGHT

GRAPHICS PROCESSOR

This graphics workstation combines dedicated graphics hardware with high-level graphics software, the Unix operating system, and the Ethernet communications network. The systems can be integrated into engineering environments regardless of preexisting hardware, and can be used as single workstations or as networked terminals using any Ethernet-compatible computer as the host.

At the heart of the system is a custom-designed VLSI chip called the Geometry Engine, which handles all the calculations needed to transform, clip, and map to screen coordinates any two- or three-dimensional image. The Geometry Engine directly processes graphical data, without going through the system's cpu; the idea is to perform the computation-intensive graphics calculations in specialized hardware rather than in software running on general purpose

hardware. The chip is estimated to perform 6MFLOPS, and up to 12 of these engines can be pipelined in one system. They calculate 3-D images on floating point axes.

The system is controlled by an MC68010 cpu, which manages display lists containing the basic visual units needed for an application. The cpu interprets graphics commands and handles engineering calculations or other tasks required for a specific application. It also controls the raster subsystem, which generates lines, areas, characters, color and texture.

The system comes with a comprehensive graphics library, which provides a high-level interface for applications developers. It contains 150 commands accessible to the user programs written in C, FORTRAN, or Pascal. Each system, without disk storage, costs \$37,500. SILICON GRAPHICS INC., Mountain View, Calif.

FOR DATA CIRCLE 300 ON READER CARD

NOW THERE'S HELP FOR MIS DIRECTORS FACING PERSONAL PROBLEMS.



Presenting the Stratus Office Solution (SOS). It Will Integrate Your Collection of Information-hungry IBM PCs into a Fault Tolerant Office System.

Somehow the personal computer revolution has become your personal problem, hasn't it? They're lined up with their IBM PCs demanding access... access to the corporate data files... access to shared data and hardware...

You need a solution right now and it has to be comprehensive and easy to understand. And if they're going to depend on it, it should be fault tolerant. What you need is the Stratus Office Solution (SOS).

SOS is Comprehensive Software, Easily Comprehended.

Stratus is the company that first made its mark with its hardware-based fault tolerant super-mini. Now it's offering a turn-key software package that is made to order for companies with an IBM host and from 20 to several thousand independent IBM PCs and/or 3270 and/or conventional terminals.

Here's a quick look at what you get with SOS (without having to write a single program):

- Controlled access to mainframe data

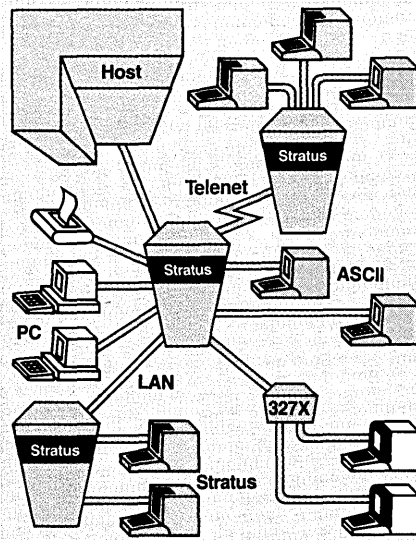

- Data exchange between IBM PCs
- Conversion to 1-2-3 or VisiCalc formats
- Electronic mail at IBM PC, 3270, or ASCII terminals
- Word processing on IBM PCs using WordStar, or MultiMate

- Text conversion from WordStar and MultiMate
- Stratus word processing
- Shared access to Stratus printers and disks
- Calendar management at IBM PC, 3270, or ASCII terminals

SOS lets your collection of isolated PCs become part of an integrated office system. And unlike any other office system in the world, it is based on fault tolerant Stratus/32 hardware that provides continuous availability and transparent networking. Not only can you count on it to work well, you can count on it to always work.

Call Stratus today at 1-617-653-1466. Turn those "personal" problems into personal success stories... and instant company assets.

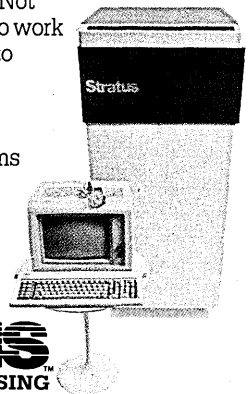

Stratus
CONTINUOUS PROCESSING™

Now that the world relies on computers it needs a computer it can rely on.

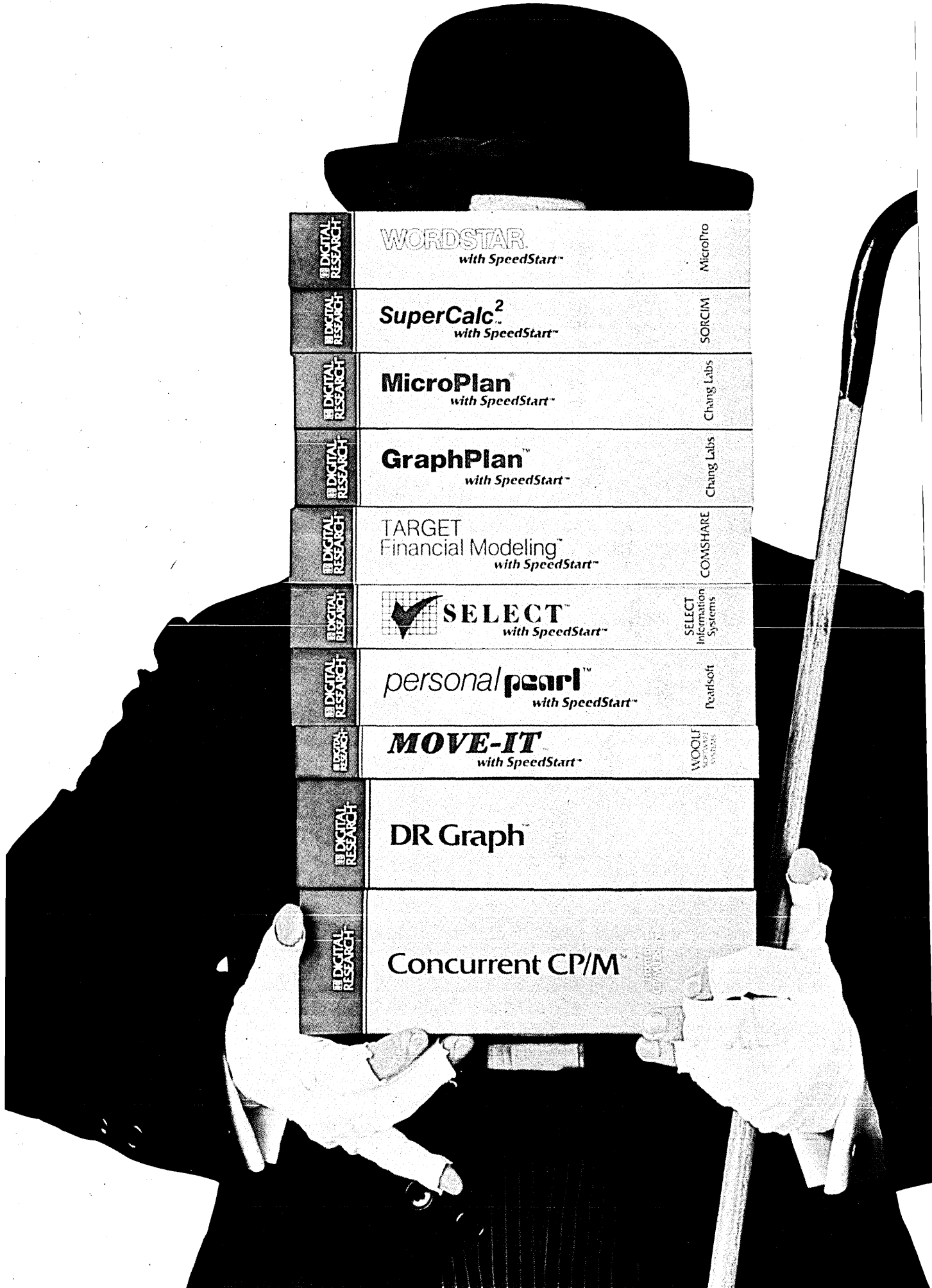

DIGITAL RESEARCH

WORDSTAR
with SpeedStart™

MicroPro

DIGITAL RESEARCH

SuperCalc²
with SpeedStart™

SORCIM

DIGITAL RESEARCH

MicroPlan
with SpeedStart™

Chang Labs

DIGITAL RESEARCH

GraphPlan
with SpeedStart™

Chang Labs

DIGITAL RESEARCH

TARGET
Financial Modeling™
with SpeedStart™

COMSHARE

DIGITAL RESEARCH

 **SELECT**
with SpeedStart™

SELECT
Information
Systems

DIGITAL RESEARCH

personal pearl™
with SpeedStart™

Pearlsoft

DIGITAL RESEARCH

MOVE-IT
with SpeedStart™

WOOLF
SOFTWARE
SYSTEMS

DIGITAL RESEARCH

DR Graph

DIGITAL RESEARCH

Concurrent CP/M

Introducing software for the IBM® PC with a \$350 bonus!

Now's the time to invest in the business software you've wanted for your IBM PC. Because for a limited time, if you buy any two of the famous business programs in the CP/M Applications Library™, we'll give you the highly-acclaimed Concurrent CP/M™ operating system for your IBM PC—absolutely free. That's a bonus worth \$350*.

Introducing SpeedStart™—the exclusive load-&-go software system.

The CP/M Applications Library offers more than just the best name-brand IBM PC software in the business. Each of our applications delivers the unmatched convenience of our exclusive SpeedStart single disk system.

SpeedStart is a special version of the powerful CP/M-86® operating system that's built into each of our software disks.

When you're ready to work, just load the disk, turn on your IBM PC and go!

SpeedStart eliminates the time-consuming task of loading a separate operating disk and then "installing" the software.

In fact, the SpeedStart system gets you to work faster and easier than any other software available today.

Best of all, it's yours at no extra cost.

What's more, SpeedStart

can be by-passed to run software under the IBM PC operating system of the future—the remarkable, multi-tasking Concurrent CP/M.

The operating system of the future can be yours—free!

There's a good reason why Concurrent CP/M is receiving rave reviews by industry experts. It enables your IBM PC to run up to four separate jobs at the same time.

You can load all of your applications at once, and instantly switch from one program to the next with the touch of a key!

For example, by using WordStar® and SuperCalc®2 simultaneously, you can print documents while working on your budget. You can even exchange data from one application to another. The time-saving possibilities are endless.

Best of all, this \$350 operating system is yours for the asking when you buy any two IBM PC business software packages from the CP/M Applications Library at your computer store.

But hurry, this special offer ends January 1, 1984! For the name of the nearest participating dealer call toll free:

800-227-1617, ext. 404
(in California, 800-772-3545, ext. 404).

**DIGITAL
RESEARCH™**

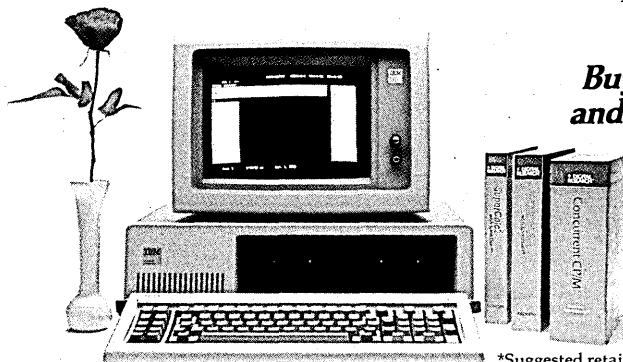

**Buy any two applications
and get Concurrent CP/M
FREE!**

*Suggested retail price

IBM is a registered trademark of International Business Machines Corporation.
WordStar is a registered trademark of MicroPro International Corporation.
SuperCalc2 is a registered trademark of Sorcim Corporation.

The Digital Research logo and products are either trademarks or registered trademarks of Digital Research Inc. All rights reserved. ©1983 Digital Research Inc.

CIRCLE 123 ON READER CARD

HARDWARE

tem. The models have been designed to operate primarily in interactive COBOL environments. Each is equipped with a commercial instruction processor (CIP) to optimize COBOL performance. A scientific instruction processor (SIP) may be added for high-performance processing with FORTRAN or Pascal programs.

The DPS 6/45 integrates on a single board the vendor's Micro 6 microprocessor; up to 2MB of RAM; the CIP; a memory management unit; and a remote support facility (RSF). The basic system also contains a multiple device controller (MDC-III) with a panel-mounted 5¼-inch diskette drive, and a multiline communications controller (MLC-16) with four communications ports. A typical system ranges in price from \$40,000 to \$100,000.

The DPS 6/75 delivers twice the performance of the 6/45 and includes a cpu, cache, CIP, RSF, MDC-III, 1MB of RAM, an MLC-16, and a user-specified mass storage subsystem. The unit can be expanded with an SIP, an additional megabyte of core, and up to 96 communications lines. System prices range from \$60,000 to \$200,000.

The DPS 6/95's central subsystem includes the cpu, cache, CIP, and SIP, all linked through 32-bit data paths. The cpu includes both 32-bit and 16-bit data registers and the capability of addressing directly 16MB of core (two megabytes is standard). A 32-bit disk controller on the 6/95 provides simultaneous support of up to three disks in seek mode while reading/writing on a fourth. Up to four of the controllers may be configured on a 6/95 system. The system is tagged at \$100,000 to \$400,000. HONEYWELL INFORMATION SYSTEMS, Waltham, Mass.

FOR DATA CIRCLE 304 ON READER CARD

ATMS

The TABS 905 express cash dispenser is a three-step consumer-operated machine designed to provide simplified cash delivery and account balance inquiry. A customer inserts his access card, enters his secret number, and then selects the desired cash withdrawal amount from a set of six choices. (Alternatively, the ATM can present five withdrawal amounts and use the sixth selection for balance inquiry.) Currency is then delivered into an open tray, and a receipt is provided.

The TABS 906 incorporates cash withdrawal, currency issuance, check validation, and electronic funds transfer services. The unit can be interfaced with the vendor's Securomatic depository to accept commercial and retail deposits.

Both machines use a standard single currency dispensing unit with a 2,400 new note capacity and a diverted currency module. A second module can be added for extra capacity or for two-denomination dispensing.

The terminals can be mounted on a

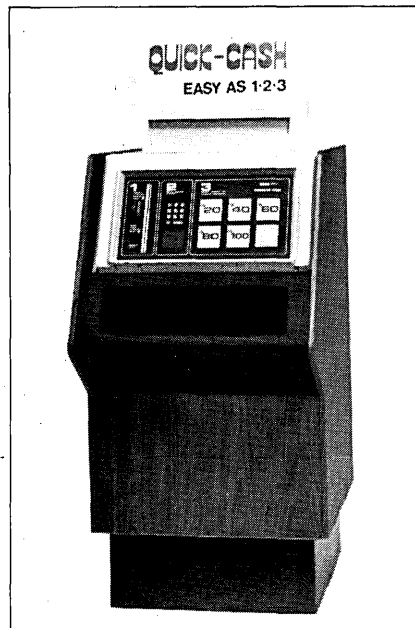

TABS Turntable, which permits 180-degree rotation of the terminal for servicing. The units can be installed in 48-inch wide spaces, and are designed for use in convenience stores, grocery stores, offices, factories, and other locations besides banks. Both units cost between \$13,000 and \$15,000 each. DIEBOLD INC., Canton, Ohio.

FOR DATA CIRCLE 306 ON READER CARD

OEM MICRO

The Unistar 300 is a 68010-based micro-computer system for oems that supports virtual memory and the Unix System V operating system. It can be used as a single workstation for CAD/CAM or other computation-intensive applications, or in multi-user office automation systems. It can also function as a network server.

The product offers up to 2MB of main memory with parity checking and no-wait states. Its 5¼-inch Winchester mass storage subsystem can accommodate from one to four drives with one or more DMA-based controllers, resulting in a disk capacity of 40 to 160MB. A pair of 5¼-inch floppy disk drives can also be used with the system. Streaming tape backup provides image or selective file restoration on 45MB quarter-inch tape cartridges.

The unit's Multibus motherboard has 12 slots that allow the user to integrate graphics display controllers, a floating point processor, and other options. I/O processors are optional for multiprotocol serial communications and Ethernet networks.

The Unistar 300 was designed with a dual-ported, two-bus architecture. The heavy bus load created by the host processors' continuous access to memory is handled by a separate synchronous I/O bus, which achieves processor-to-memory transfer rates of 4 to 5 MBps. The product supports Ada, BASIC Plus, COBOL, FORTRAN 77, Pascal, and assembly languages. It costs

\$20,000 in a basic configuration. CALLAN DATA SYSTEMS, Westlake Village, Calif.

FOR DATA CIRCLE 307 ON READER CARD

ONE-HANDED WP

This product seems to be the novelty item of the month. The Microwriter is a handheld word processor with six keys and a one-line display. The user depresses one or several of the five alphabet keys (the sixth is a command key) in combination to generate each letter; the key combinations are based on the shapes of the letters of the alphabet, so that the user "shapes" the letters with the Microwriter instead of with a pen.

The five alphabet keys are laid out in a rough, inverted U shape designed for right-handed use. Thus, the letter I would be formed by hitting the two left-most keys simultaneously to simulate a vertical line. The same two keys, along with a fourth key (which is parallel to the second), would form a lowercase r. The two left-most keys and the right-most key would form the capital letter L. The command key is used for punctuation and editing.

The system allows users to generate text 50% faster than handwriting, the vendor says. The unit weighs about two pounds and is slightly larger than a paperback book. It uses rechargeable batteries that can give 30 hours of use between charges. The Microwriter can store about five pages of text in its 8KB memory.

Commands for text editing include review, delete, insert, and format instructions. In addition, an RS232 port is built in for communications to a host PC or to a printer. The unit costs \$500. MICROWRITER INC., New York, N.Y.

FOR DATA CIRCLE 309 ON READER CARD

LAN TOOL

The Nutcracker local area network development and management system provides a window into the high-speed stream of pack-



ets moving through Ethernet local area networks, the vendor says. The desktop system is designed to help communications engineers test and debug Ethernets and to establish operating limits of a given configuration. This can be accomplished through

EMULATION PLUS + AMBER

FROM AMPEX

The figures are in. Ampex Emulation Plus terminals with ergonomically superior Amber now outsell our white and green phosphor VDT's 4 to 1. But the choice is still yours. With all three colors available as standard on all three Ampex ASCII redlining terminals, you've got flexibility.

Built-in flexibility to emulate up to 20 popular models*, with eight resident character sets in your choice of detached selectric-type or programmer

Including models from Televideo, Lear Siegler, ADPS, Hazeltine, DEC, and SOROC.

keyboards. Price flexibility, starting with our new low-cost D125, on up to our D150 and D175. Flexibility to customize both hardware and firmware. And most importantly, maintenance flexibility through a nationwide network of TRW service centers. That's total flexibility.

Find out why Ampex Emulation Plus terminals with Amber are challenging the market with loads of features and flexibility at a price you won't believe. Call your nearest Ampex distributor, or give us a call direct at 213-416-1575.

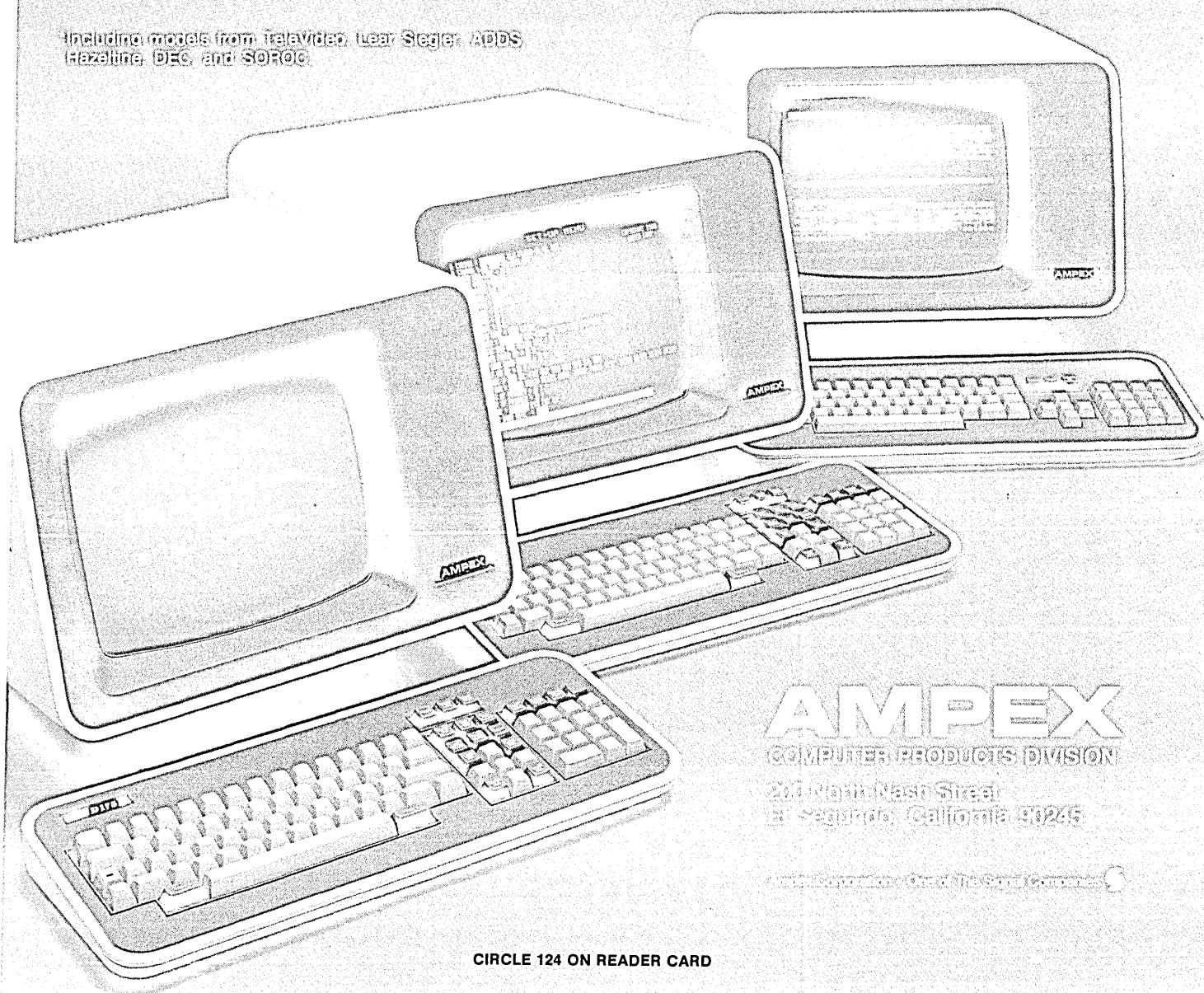

AMPEX
COMPUTER PRODUCTS DIVISION

201 Ninth West Street
El Segundo, California 90225

© 1980 Ampex Corporation. All rights reserved.

CIRCLE 124 ON READER CARD

AFFORDABLE 4K SLIDE MAKING



High tech
just caught up
with in-house
slide making!

Now all it takes is the revolutionary
Matrix QCR D4/2 and the computer of
your choice for artist quality 35mm,
4x5s, or 8x10s at 4096 x 4096 pixels.

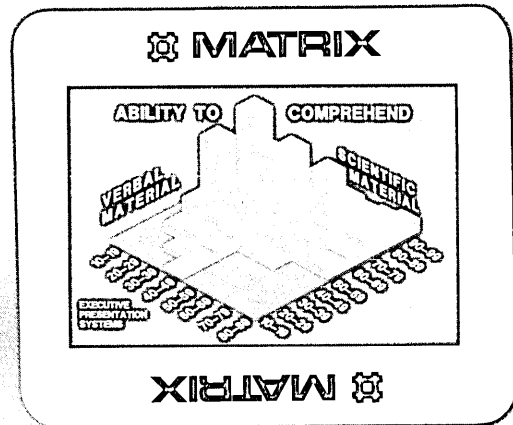

Unretouched 150% enlargement of
35mm slide from Matrix QCR D4/2.

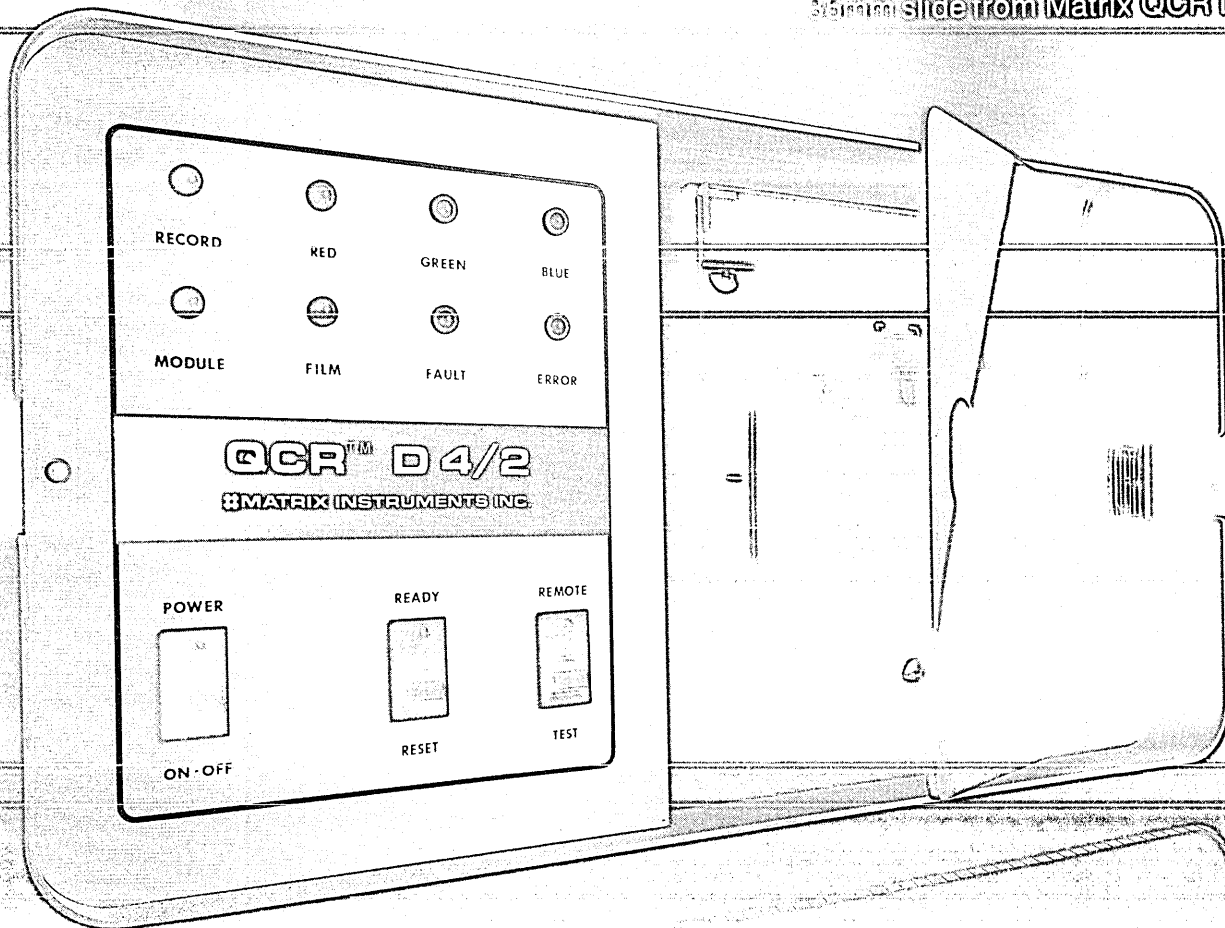

#MATRIX INSTRUMENTS INC.

230 Pegasus Avenue, Northvale, N.J. 07647, Telephone: (201) 767-1750 or Telex: 135131

In Europe, please contact
Honeywell Europe S.A., Avenue Henri Matisse 14, 1140 Brussels, Belgium, Tel: (02) 243 1487 or Telex: 24535

CIRCLE 125 ON READER CARD

WE PUT OUR THIN-FILM
HEADS TOGETHER AND
CAME UP WITH A BETTER
STORAGE SYSTEM.

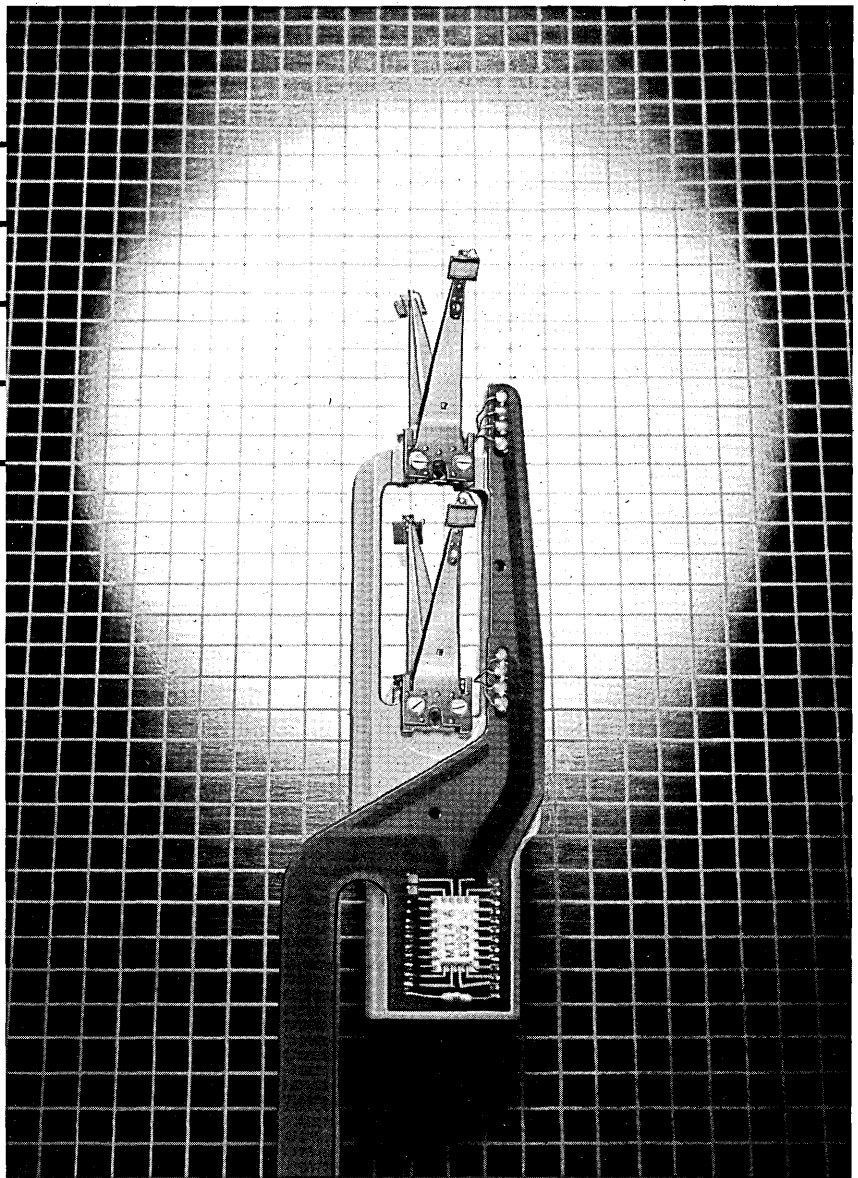

**PCM COMMITMENT YOU CAN
COUNT ON FOR GENERATIONS**

Actual size

We took innovative technologies and built the most advanced DASD systems now on the market—the Control Data 33800 and 33750. Like our thin-film heads—shown above in a head/arm assembly. Like four separate and independent, sealed Head/Disk Assemblies (HDAs): sealed for protection from computer room air; independent for improved maintainability. Dual access and dynamic path selection mean greater

throughput and better string availability. Like all our DASD systems, the 33800 and 33750 are fully compatible with IBM architecture. And they offer additional benefits like XA compatibility and floor space savings of up to 20%. The 33750 is even field upgradable to a 33800.

With the 33800 and the 33750, our PCM commitment pays off again. For more information, call 612/553-4311.

GD CONTROL DATA

CIRCLE 126 ON READER CARD

HARDWARE

programmable monitoring circuitry that sees every packet on the 10Mbps network cable and computes statistical information about various classes of packets.

For instance, the 8086-based machine could be set up to analyze packets flowing between two particular nodes while also observing the network behavior of a third node that is suspected of being faulty. The system can generate packets fast enough to flood the network and force packet collisions to determine the consequences of such collisions when the network is fully operational. The unit's U.S. price is \$49,500 in single quantities. EXCELAN, San Jose, Calif.

FOR DATA CIRCLE 308 ON READER CARD

PC CAMERA

The model 610 electronic digitizing camera enables office workers to enter complex or detailed images—photographs, documents, printed text, or three-dimensional objects—into desktop computers without the use of the keyboard. It is built around a solid state detector and a proprietary electromechanical scanner.

To enter an image into the system, the scanner first captures the image through a standard 35mm camera lens. Then, inside the camera, a linear array of 1,728 solid state photosensors is physically scanned across the image. This image information is organized into a matrix of 4.9 million pixels; a digital converter changes the information into computer-readable form on a pixel by pixel basis. The data stream is then sent to the host PC for processing.

Once in the host, the electronic image can be displayed, printed out, or stored for later retrieval. It can be manipulated into different shapes and sizes, and can be transmitted to other computers via communications links.

A companion product is the model 110 image processing interface, which includes software designed for the IBM Personal Computer. The model 90 integrated imaging system is an oem version that includes the 610 camera, the 110 interface and software, power supply, camera stand, illumination, camera lens, cables, and service manual. The 610 camera costs \$7,850,

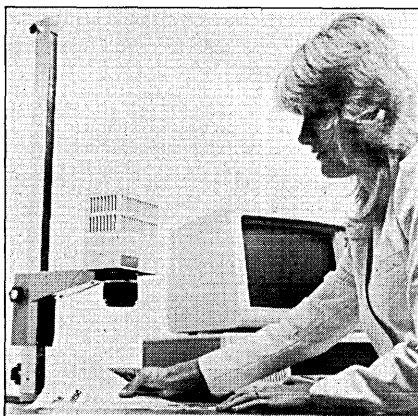

and the 110 interface costs \$800. A full model 90 system costs \$9,945. DATACOPY CORP., Palo Alto, Calif.

FOR DATA CIRCLE 310 ON READER CARD

MODEM

The CDS 224 modem provides 2,400 bps transmission in a full duplex mode with an automatic dialing capability. The unit operates on both pulse and touch-tone dialing telephone systems. It allows users to initiate telecommunications either manually by dialing telephone numbers through an asyn-

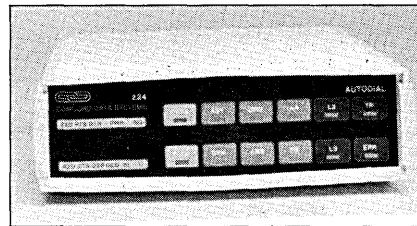

chronous terminal's keyboard or automatically through software-initiated commands. Terminal screen prompts guide the user through manual operation, and a help command gives new users a list of available options and commands. Modem software is designed to ensure smooth communications in noninteractive modes and provides users and computer equipment with various levels of call monitoring feedback for real-time viewing and record keeping.

The modem permits telecommunications to be initiated and executed at any time, without the need for the user to be present during transmission. It supports all currently available protocols and transmits at 2,400 bps in both synchronous and asynchronous modes. It has an automatic 1,200 bps, 212-compatible fallback mode to permit use with other existing equipment. Front-panel switches allow users to select between async and bisync modes and to reconfigure the modem without restrapping it. The CDS 224 costs \$1,200. CONCORD DATA SYSTEMS INC., Waltham, Mass.

FOR DATA CIRCLE 311 ON READER CARD

PORTABLE TERMINAL

This terminal is about half the size of a conventional crt terminal, but it includes most of the features found in the vendor's other terminals. The unit is aimed at managers and executives who need access to a corporate computer but who do not need the local intelligence provided by a personal computer.

The \$500 terminal uses a set of function keys that facilitate user access to corporate data. An optional handset and connection to a PBX allows the terminal to function as a telephone and connect to the host via the PBX rather than through a direct connection. A modem is slated to be added to the crt this winter, so that the terminal can be used to access remote databases as well as local hosts through the PBX or direct link.

Other future enhancements to the terminal include EPROMs that will imitate a Lexis machine or terminals geared to banks or travel agents. An option slot allows for the addition of graphics and Ethernet board or other accessories. The unit conforms to ANSI standard 3.64. TELEVIDEO SYSTEMS INC., Sunnyvale, Calif.

FOR DATA CIRCLE 312 ON READER CARD

3-INCH DISK DRIVE

The MFD-80 floppy disk drive is fully plug-and-format-compatible with standard 5¼-inch disk drives. The unit can store up to 600KB of data on a single diskette. Up to four of the drives may be mounted vertically in the footprint required for a single full-size 5¼-inch drive.

The drive employs a DC servo-controlled, indirect spindle drive, with spindle speed monitored at the disk rather than at the motor to assure accurate rotational velocity. The read/write carriage is cam-controlled; a "barrel" cam is employed to eliminate most common causes of error in head positioning.

The disk handling mechanism is similar to those employed in the Hitachi 3-

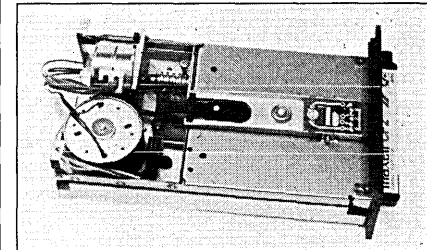

inch and Tabor 3¼-inch drives, except that the downward movement of the disk is not spring-loaded. Thus, the user must push the diskette in and down before it locks into place; the mechanism was designed that way to reduce the number of moving parts in the drive.

The disk can handle 250KB per side at 40 tracks per side, or 300KB at 48 tracks per side. The drive is not double-sided, but both sides of the diskette can be used to store data. Average track to track access time is 10ms, settle time is 15ms, and average seek times are 245ms in the 40-track format and 272ms in the 48-track format. The drive costs \$125 in oem quantities. JANOME SEWING MACHINE CO., Tokyo, Japan.

FOR DATA CIRCLE 313 ON READER CARD

DATA COLLECTION

The model 121 portable data system has up to 128KB of RAM and 64KB of ROM program storage and is designed for applications in inventory and distribution tracking. The product is an extension of the vendor's 101XL system and is compatible with its Route-commander route accounting system and 20/20 bar code reader.

The system uses the PL/N programming language, which was developed to meet specific requirements in the data col-

Introducing... The Ultimate CICS Productivity Breakthrough In Applications Development.

GENER/OL™ by Pansophic

The Product That Does It Better Than UFO, MANTIS and DMS/CSP.

Pansophic has the applications development system so unique... it will change the meaning of the word "productivity" in your data center. The product is GENER/OL™, and it's the leader of a whole new era in CICS information management.

GENER/OL™ is designed especially to turn your CICS environment into a productivity center with a host of sophisticated easy-to-learn features. Complete with English-like interactive programming capabilities, help facilities, statistical analysis functions, inter-active query, decision-support features, an editor/compiler, and easily-generated seven-color graphics, GENER/OL™ puts it all together in one neat, easy-to-use, fast-to-respond package. And when you're developing applications, GENER/OL™ doesn't waste time... it allows your programmers to develop, test, and run their programs interactively for productivity that can't be matched.

GENER/OL™ is the breakthrough in CICS applications development that's made the IBM and plug-compatible mainframe market stand up and take notice. And it's brought to you by Pansophic, the Company with the broadest product line of information development software in the industry. GENER/OL™ comes complete with all the expert training, conscientious service, world-wide support, active user groups, and extensive documentation that's made Pansophic famous.

Make no mistake about it. When it comes to CICS applications development, GENER/OL™ does it better than UFO®, MANTIS®, and DMS/CSP®. But don't take our word for it. Contact us today, or send in the coupon below for complete information and a personal demonstration... and be prepared for the performance of a lifetime!

Yes, Pansophic—I would like to know more about GENER/OL™.

Please: Send more information.
 Have a Sales Representative contact me for a demonstration.

Name _____ Title _____
Company _____ Telephone _____
Address _____ State _____ Zip _____
City _____
CPU(s) Installed _____
Operating System _____

MAIL TO: Pansophic Systems, Inc., 709 Enterprise Drive, Dept. GS11
Oak Brook, Illinois 60521 · 1-800/323-7335, In Illinois 312/986-6000.

12/83

PANSOPHIC®

matchmaker,

IBM Displaywriter & HEWLETT PACKARD Series 40 computer system & DATAPOINT 1560 data terminal processor & HONEYWELL Series 60 computer system & WANG System 35 word processor & PHILIPS Series 3003 word processor & NCR Comten 3670 computer system & PHILIPS Series 3003 character reader & COMPUCORP 700 data terminal & HONEYWELL Series 62 computer system & HONEYWELL microSystem 6/10™ microcomputer & EXTEL B315 data terminal & AM JACOBSON AJ650 data terminal & DATAPOINT 6600 data terminal & ANDERSON JACOBSON AJ833 data terminal & HONEYWELL HEWLETT PACKARD HP 3000 mainline & PHILIPS INFORMATION SYSTEMS Model 2001E word processor & WANG System 30 word processor & PHILIPS 2002 Twin word processor & IBM JACOBSON AJ650 data terminal & TRS 80® personal computer & LANIER No Problem™ word processor & WANG 2200 computer system & APPLE IIe personal computer & AM PHILIPS Model 2005 word processor & COMPUSCAN AlphaWord III® optical character reader & NBI OASys 4000S word processor & EXXON 210 intelligent computer system & EXXON 120 intelligent typewriter & APPLE II personal computer & IBM Displaywriter & HEWLETT PACKARD Series 40 computer system & DATAPOINT 1560 data terminal processor & HONEYWELL Series 60 computer system & WANG System 35 word processor & PHILIPS Series 3003 word processor & NCR Comten 3670 computer system & PHILIPS Series 3003 character reader & COMPUCORP 700 data terminal & HONEYWELL Series 62 computer system & HONEYWELL microSystem 6/10™ microcomputer & EXTEL B315 data terminal & AM JACOBSON AJ650 data terminal & DATAPOINT 6600 data terminal & ANDERSON JACOBSON AJ833 data terminal & HONEYWELL

matchmaker.

nal & AM JACQUARD J100 minicomputer & RAYTHEON
PUCORP 745 data terminal & CPT 8000 word processor
processor & COMPUSCAN AlphaWord Series 80® optical
VT 1200 word processor & HEWLETT PACKARD Series 64
J500 minicomputer & EXTEL B318 data terminal &
minicomputer & ANDERSON JACOBSON AJ830 data termina
& EXXON 140 intelligent typewriter & UNIVAC® 1100
al Computer & PHILIPS Series 3000 word processor
sor & NCR Comten 3690 computer system & HONEYWE
RD J425 word processor & COMPUCORP 655 data termina
AM JACQUARD J600 multi-station computer & HEWLETT
iter & NCR Comten 3650 & NBI OASys 3000S word pr
DERSON JACOBSON AJ650 data terminal & WANG VS 80 com
560 data terminal & AM JACQUARD J100 minicomputer
sor & COMPUCORP 745 data terminal & CPT 8000 wor
04 word processor & COMPUSCAN AlphaWord Series 80®
& RAYTHEON VT 1200 word processor & HEWLETT PACKAR
RD J500 minicomputer & EXTEL B318 data terminal &
minicomputer & ANDERSON JACOBSON AJ830 data termina

A word processor and a computer aren't a match made in heaven.

Of course, neither are a telex machine and CRT. Or any of the machines listed here.

Rather, they're all matches made by us: ITT World Communications.

You see, until we came along, it wasn't very easy for businesses to send information from a word processor to a computer. Or from a telex to a CRT. Or vice versa.

Now all that (and more) is possible—by sending information through us.

Our network simply eliminates all the usual problems of unlike equipment.

So a company never has to be in the costly position of owning unneeded terminals, just to "talk" to other terminals.

Which means, you'll not only get the communications your company needs, but you could save money as well.

Advanced communications *and* economy?

It sounds like a perfect match to us.

For more information contact your local ITT sales representative or write Marketing Dept. A/PR, ITT World Communications, 100 Plaza Drive, Secaucus, NJ 07096.

ITT

HARDWARE

lection applications. The PL/N development system can be installed to allow users to write or alter custom programs. Programs can be stored in RAM or in replaceable EPROMS.

The product comes in high-impact resistant packaging, with static discharge plating, user-sized keys, and an optional custom keyboard overlay. It contains a liquid crystal display with two lines of 16 characters and backlighting to facilitate reading in low light conditions. The product

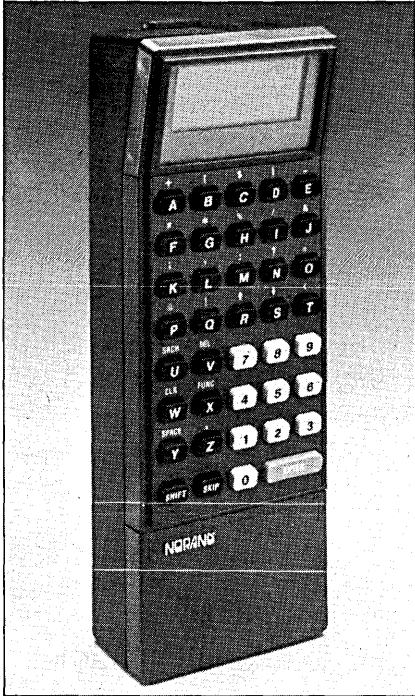

uses nickel-cadmium batteries that allow for an average of 16 hours of continuous use. The 121 costs \$2,415 in a basic configuration. NORAND DATA SYSTEMS, Cedar Rapids, Iowa.

FOR DATA CIRCLE 314 ON READER CARD

TERMINALS

The PTS-1000/4000 terminal family includes three interactive displays, three control units, and five printers. The R1078-X 12-inch monochrome terminal provides IBM 3178 and 3278-2 compatibility and can be connected in star, multidrop, or coaxial multiplexing configurations. The 8085-based unit has 48KB of RAM, 24KB of ROM, and an automatic dim after 15 minutes to reduce wear. The R4078-X 15-inch monochrome terminal emulates the entire 3278 terminal family and includes the same microprocessor and storage capabilities as the R1078-X. The third terminal is the R4079-X, which uses a 13-inch color screen and emulates the 3279-2A and 3279-3A color terminals. It, too, has an 8085 with 64KB RAM and 24KB ROM, as well as the automatic dimming capability.

The R1076 control unit supports eight display or printer terminals using the IBM 3276 communications protocol. It can

operate in multidrop and coaxial multiplexing configurations, and emulates the BSC and SNA protocols. The unit provides a maximum line speed of 9.6Kbps and is governed by an 8088 with a 64KB EPROM. The R1074 unit supports up to 32 terminals using the 3274 communications protocols. The R4074 also supports 32 terminals and provides local format storage, extended memory, increased communication speeds, and local channel attachment.

A typical small cluster remote system with four displays, one controller, and one printer costs \$13,170. A typical large cluster system with 18 displays, two printers, and the R1074 controller costs \$42,820. RAYTHEON DATA SYSTEMS, Norwood, Mass.

FOR DATA CIRCLE 318 ON READER CARD

NETWORK ANALYSIS

The Network Analysis and Management System (NAMS) provides alarm notification, centralized diagnostic control, and critical path control of all elements in a data communications network. It provides automatic processing and notification of alarm conditions from any point in the network, including unmanned locations.

From one to 16 color consoles can be used as network management centers. At each, the user can obtain reports and analyses, such as an activity summary log, trouble tickets, trouble history summaries, and an inventory management facility.

Two basic components constitute NAMS. A central management controller provides complete central site control that allows for the evolution and growth of the system. The second component, the network analysis switch, provides access to all points in the network for alarm notification, diagnostic access, and electronic reconfiguration.

The central management controller includes the operator's crt, which uses color-keyed menus, English commands, and a full travel ASCII keyboard. The controller also includes a database of all information relating to every element of the network, including serial numbers, locations, descriptions, and contact phone numbers. The data is stored on a 40MB hard disk. An additional 10MB of removable disk storage is available for historical data. The controller also includes a system logging printer that provides a permanent record of all alarms and operation activity. Finally, the control-



ler can operate external diagnostic devices, such as analog and digital test equipment, protocol monitoring and analysis devices, and switching systems. A basic NAMS configuration, with both the controller and the network analysis switch, begins at \$68,000. DIGILOG NETWORK CONTROL DIVISION, Montgomeryville, Pa.

FOR DATA CIRCLE 315 ON READER CARD

P.C. STORAGE

The PC-8000 storage subsystem attaches up to one gigabyte of on-line mass storage to an IBM or compatible personal computer.

The subsystem consists of a controller and one or two disk drives, with from 25 to 500 megabytes of capacity each. The disk drives are supplied by Control Data, Fujitsu, and others; this vendor attaches the controller, power supplies, software drivers, cabling, and documentation.

A system with 25MB fixed disk drive and a 25MB removable disk drive, along with the controller, software, and accessories, costs \$8,900. A system built around the Fujitsu Eagle, with a single 474MB drive, costs \$14,900. Other configurations are also available. Maintenance service is provided by Radian Corp. NATIONAL MEMORY SYSTEMS CORP., Livermore, Calif.

FOR DATA CIRCLE 321 ON READER CARD

PC NETWORK

The Net/One Personal Connection is a network interface unit that allows personal computers to connect to the vendor's Net/One local area network. When connected, they can communicate with each other or with IBM hosts via SNA. The network interface unit is currently available only for the IBM and Texas Instruments micros.

The unit's on-board intelligence handles all communications tasks, freeing the PC's cpu for other applications; in a sense, it thus becomes a dual-tasking system. Computers configured for the network interface unit can run any application programs under MS/DOS without modification, and such programs can be shared across the network. Five software commands are added to MS/DOS as part of the Personal Connection to facilitate sharing.

The Personal Connection allows PCs to be connected to information processing devices from multiple vendors over the Net/One network. It has a disk server and a print server that allow PC users to operate diskless, printerless workstations and share those resources. The disk server manages the shared access to all files and applications programs stored on one or more Winchester drives at the server station. It provides multilevel password protection. Each PC connection costs \$850, including software. The Net/One Personal Connection will be available next month. UNGERMANN-BASS INC., Santa Clara, Calif.

FOR DATA CIRCLE 317 ON READER CARD

—Michael Tyler

LEADER OF THE PACK



The Quality Leader:

BASF disk packs and cartridges reflect BASF technology and quality, because unlike many suppliers, we make them ourselves.

BASF drive tests each pack at the factory to ensure optimum performance.

BASF commitment to magnetic media is now in its 50th year.



The Performance Leader:

BASF mirror-polishes its uncoated disks for optimum headflight characteristics.

BASF magnetically orients all oxide particles in the disk coating for greater packing density.

BASF coats, polishes, and burnishes each disk by its own process, for long-lasting, trouble-free operation.



The Value Leader:

BASF has the configuration you need... for Burroughs, CDC, Data General, DEC, Honeywell, IBM, NCR, Wang... ready for immediate delivery at new low prices.



The Premium Leader:

BASF has a new premium program with exciting gifts to add extra value to your order.

For ordering or compatibility details, send the coupon today, or call toll-free 800-343-4600.



*For Burroughs: Front-load single disk cartridges, 80 MB Tridents.

For CDC: 80 and 300 MB storage modules, Phoenix single disk cartridges.

For Data General: 50, 100, 200, and 300 MB disk packs, top-load single disk cartridges.

For DEC: 100 and 200 MB 12-high packs, front-load single disk cartridges, 80 and 300 MB storage modules.

For Honeywell: Phoenix single disk cartridges, 80 and 300 MB storage modules, 100 MB packs.

For IBM: 100 and 200 MB 12-high packs, top and front-load single disk cartridges.

For Wang: Phoenix single disk cartridges, 80 and 300 MB storage modules, top-load single disk cartridges.



BASF

BASF Systems Corporation
Attn.: Marketing Services, Computer Division
Crosby Drive, Bedford, MA 01730

Please send me information on BASF Disk Packs, your new low prices, and premium program.

Name/Title _____

Company _____

Address _____

City _____ State _____ Zip _____

Telephone _____

DM

CIRCLE 129 ON READER CARD

For document and text management

Theirs:

STAIRS

Ours:

INQUIRE®

With large volumes of textual material now available in computer-readable form, the indexing, storage, and retrieval of full text has become both an opportunity and a problem for managers of: corporate records, regulatory affairs, corporate libraries, research, and litigation support. IBM has recognized that text management is a critical part of overall information resource management.

They've got the right idea, but the wrong tools.

What about applications which mix text and numbers? How efficient is it to add documents? Can indexing approaches be matched to the application? How flexible is the output formatting?

INQUIRE provides an interactive approach to text management in a single, integrated information resource management system. The INQUIRE thesaurus manager provides vocabulary control and interactive thesaurus-aided retrieval. Users have complete control over output formatting. INQUIRE offers contextual (proximity) searching of text, as well as numeric computation and qualification. And INQUIRE is efficient—no reorganization is needed when documents are added.

One client says it all. "We converted our entire corporate records system from STAIRS to INQUIRE in three weeks, saving \$2400/month in software costs alone."

We've been helping companies meet complex document and text management challenges

since 1968. If you run MVS, VSI, or VM/CMS, INQUIRE can make text a valuable part of your information resources. Call us toll free today to find out how.

Infodata

Infodata Systems Inc.
5205 Leesburg Pike
Falls Church, Virginia 22041

800-336-4939

In Virginia, call 703-578-3430
Telex: 899-125

Offices in:
Dallas, Houston, Los Angeles, New York, Rochester NY,
Washington DC, Chicago, Tampa, San Francisco.

© 1983 Infodata Systems Inc.

*INQUIRE is a registered trademark of Infodata Systems Inc.

SOFTWARE AND SERVICES

UPDATES

Running counter to the general "move it to a micro" trend in recent months has been the curious phenomenon of mainframe spreadsheets. The quintessential microcomputer application has been offered for VAX and 370-compatible environments in several products chronicled in these pages; now, IBM has re-released Oxycalc, its own spreadsheet for MVS/TSO and VM/CMS environments. The product was developed by Occidental Petroleum for IBM.

But lest the growth of micro applications for mainframes slow sales of the Rye, N.Y., giant's personal computer line, IBM simultaneously announced upgrades of its P.C. XT designed to simplify the use of the unit as a 3270-type terminal. IBM was no doubt reacting to products from several independent vendors that have caught on among users anxious to integrate the micros into corporate environments.

As PCs proliferate in corporate networks, and as the demand for computing power in an organization grows at an annual 50% clip, the need for capacity planning has suddenly become pressing. BGS Systems Inc., the Waltham, Mass., vendor that has been providing software to cope with these pressures, will be expanding its product line laterally in the next few months. The Best/1 and Capture products currently offer MVS and VM system users the ability to measure and analyze current system usage and to evaluate the impact of projected workload growth, hardware and software modifications, and changes in operating system parameters. Company sources say that a version of each product for SNA data communications networks is in the works, as is a new product called Crystal. That product would allow system development managers to estimate

the effects of new applications on system performance before the software is written or purchased.

Many microcomputer literacy or training packages can be deadly dull or unhelpful to executives who need to learn but who don't want to be taught at the level of clerical workers. One package worth a look is called Knoware, from Knoware Inc. The software teaches IBM or Apple users everything from the basics of system operation to complex integration of database and spreadsheet programs, using a board-game format. Learners start at "Mail Clerk" and advance to "Ceo" by learning the computer skills and applying them in actual problems. The format is amusing, engrossing, and instructive, but it is not for the impatient. The Massachusetts startup is backed by several industry heavyweights, including former IBM and American Bell vp Archie McGill.

DEC's disastrous earnings projections of late are due in part to the Maynard, Mass., vendor's inability to sell personal computers. That inability stems largely from DEC's insistence that the user choose the PC best for him -- unlike IBM's one size fits all strategy. A more important cause is the utter lack of software available for the business-oriented Pro 300 model line, which compares favorably with the IBM P.C. from a hardware standpoint. Another blow to the line's chances for survival came when DEC and VisiCorp killed the development of versions of VisiCalc, VisiFile, and VisiTrend/Plot for the Pro 325 and 350. DEC is rightfully proud that Pro 300 series software is often compatible with PDP-11 and VAX computers, but let's face it: how many people will buy a personal computer for business use if it doesn't run VisiCalc?

EQUIPMENT MANAGEMENT

The Telecommunications Equipment Management System (TEMS) automates the record-keeping activities in large telecom systems, including functions previously provided by the Bell operating companies. The product's work order preparation program presents the user with a "picture" of the phone, which includes organizational data and equipment information. The system then guides the user through a move or change request, alerting him to potential errors. (Such an error might be attempting to disconnect a line that is attached to other instruments.) TEMS translates equipment information into USOC codes and maintains pricing information on installations and on-going charges. All telephone systems are supported, as are modems, personal computers, and other datacom equipment.

A work order tracking module generates a series of reports indicating pending orders, orders on hold, and orders that should have been completed. An inventory control module is automatically updated as orders are completed. Relationships between lines, instruments, and features are all updated.

The package contains two mechanisms for vendor bill reconciliation. For Centrex users, a feature permits matching of the TEMS inventory against the information on the station and equipment billing tape from the operating company. The other mechanism is through equipment summaries that can be used to reconcile bills for PBXs and other equipment manually.

An equipment cost allocation module is also provided. The entire package costs \$55,000. COMMERCIAL SOFTWARE INC., New York, N.Y.

FOR DATA CIRCLE 326 ON READER CARD

VIDEOTEX

The VideoLog videotex service is essentially a collection of on-line product catalogs for use in the electronics industry. The service can be accessed by dumb ASCII terminals, personal computers, and NAPLPS terminals; a color graphics card is required.

SOFTWARE & SERVICES

Over the course of the coming year, the service will be expanded to include an on-line directory of all manufacturers of electronic components, equipment, and services. Industry news and advertiser-supported product information will be provided.

The service is aimed primarily at design engineers and purchasing agents. While all manufacturers and distributors will be listed with names and addresses, advertisers will be able to purchase screens on which they can put electronic versions of their product catalogs. Some test advertisers currently are showing catalogs with 50-plus pages.

When the advertiser includes product information, an electronic reader service card is attached. The user can indicate he would like more information, and his name and address are sent to the vendor. The vendor can then respond immediately over an electronic mail system to the user's specific questions, and request more clarification from the user if needed.

The service is primarily advertiser-supported, although users must pay a fee. Currently, on-line charges to users are 17 cents an hour. Advertisers pay \$100 to \$200 per screen, plus an additional \$15 to \$30 per screen if the vendor designs the screen. VIDEOTEX INFORMATION CORP., Wilton, Conn.

FOR DATA CIRCLE 327 ON READER CARD

BLIND INTERFACE

PC Speak is designed to give visually handicapped users access to most software currently available for the IBM Personal Computer. Combined with a speech synthesizer, the product replaces a crt for the blind user.

The product can work with programming languages such as BASIC and Pas-

cal, word processors, spreadsheets, and integrated packages such as 1-2-3. The package can say what is sent to the display or it can be used to review the display much the same way a sighted person scans the screen. The user can select words or lines with the cursor control keys, and the product will spell or pronounce them.

Users can also supply different pronunciations for punctuation marks and special symbols that are used differently in different environments. For example, a decimal point can be pronounced "period" in a word processing package and "point" in a spreadsheet package.

PC Speak works in a minimal configuration of 64KB RAM with one disk drive, a parallel or serial adapter, PC/DOS version 1.1 or 2.0, and a speech synthesizer. It can interface with a modem and terminal emulation software to provide a timesharing terminal for the visually handicapped user. PC Speak costs \$400. SOLUTIONS BY EXAMPLE, Boston, Mass.

FOR DATA CIRCLE 328 ON READER CARD

RESPONSE TIME MONITORING

Responsetime/1 provides objective measurements and assistance in improving response time for the IBM Series/1 minicomputer running under the EDX operating system. It identifies underused terminals and provides a security audit of program usage.

The product consists of two main programs, a data capture program and a report generation program. The data capture program runs on each cpu to be monitored. It occupies about 2KB and uses less than 1% of a 4955 processor's cpu cycles, the vendor says. The length of each operator-program interaction is retained in a file. No program modifications or system patches are required.

The report writer program provides detailed reports that pinpoint response time by terminal, program, and time of day. The reports show the average response time, the median, and the distribution. (The inclusion of the median is intended to indicate whether one or two exceptionally slow responses distort the average.) The distribution can be reported graphically to dramatize problem areas and possible improvements.

The product is compatible with all Series/1 cpus and terminals, all releases of EDX, and all programming languages supported by EDX. It works with multiple terminal managers. Single site licenses cost \$965; for multiple sites, the product costs \$1,400, and for a corporate license, \$2,000. FIRESIGN COMPUTER CO., San Francisco, Calif.

FOR DATA CIRCLE 329 ON READER CARD

PC DBMS

The R:base series 4000 database management system for microcomputers can interface with mainframe databases and the Multiplan personal computer spreadsheet package. The product can manage 40 files with 100 billion records, using relation and attribute lists.

It provides relational data validation; customized screen forms for data entry, editing, and reports; automatic identification and explanation of improperly entered syntax; and English-like prompts and commands.

The package allows the creation of tables of information based on the contents of two or more files. It provides standalone query, database definition, and report writer capabilities. Its relational access functions include join, intersect, project, subtract, and union, and an updated change command modifies selected values throughout all relations in the database.

In addition to Multiplan, the package provides a direct interface to dBASE II and is compatible with 1-2-3, VisiCalc, WordStar, and other packages. It is also compatible with the vendor's mainframe database package, RIM. Using R:base, it is possible to set up a direct information exchange channel between the mainframe database and the personal computer.

The package costs \$500, and requires 256KB of RAM. It runs under MS/DOS, CTOS, BTOS, and Unix. A \$150 extended report writer is also available for generating complex reports from the database files. MICRORIM INC., Bellevue, Wash.

FOR DATA CIRCLE 330 ON READER CARD

INVENTORY MANAGEMENT

The DECTap inventory management system is designed for use by wholesale distributors of hard goods. It provides timely summaries of financial status, inventories, orders, and sales trends, so that distributors can carry only inventories that are needed.

SOFTWARE SPOTLIGHT

STOCK BROKER

The Desk Top Broker on-line service allows users to enter transactions, maintain portfolios, and see current stock prices through their personal computers at any time. In addition to receiving last sale prices and having the ability to buy and sell stocks, investors may check data on any individual stock, such as trend, change from previous close, and P/E ratio. An electronic mail facility notifies users of the execution of their orders, and allows users to enter requests such as transferring securities between cash and margin accounts.

Included in the system is a Stock Watch feature that tracks various aspects of up to 18 selected stocks and beeps if a price changes during market hours. It also informs the user if the stock has gone above or below preset buy/sell limits. The product can maintain three separate portfolios and keeps tax records reflecting trade transactions. All information in the program can be

transferred to spreadsheet programs (not provided by the vendor) to produce charts, graphs, and analyses. A double password security measure is designed to make the system secure from most misuse.

Investors can attach the same conditions to orders that they would give a broker. They may specify good-till-cancelled, day orders, market or limit orders, stop loss, and delivery instructions for stock certificates. Margin purchases and short sales are also allowed.

The system can be accessed through most microcomputers via modems. Customers pay a one-time fee of \$300 and on-line connection fees of 10 cents per minute on nights and weekends and 40 cents per minute during business hours. Customers must also pay the standard transaction charges posted by the vendor's brokerage services. C.D. ANDERSON AND CO., San Francisco, Calif.

FOR DATA CIRCLE 325 ON READER CARD

THE LATEST THING IN DESIGNWARE.

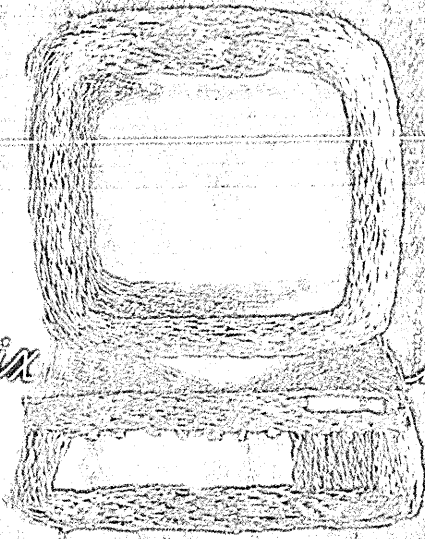

UNIX-BASED NETWORK NODES FROM CORVUS ARE EASY TO TAILOR TO YOUR APPLICATION.

With these two low-cost processing units, now you can comfortably slip into OEM markets you couldn't fit into before.

Just for size, try on our new Uniplex™ 68000-based desktop unit.

Corvus, Corvus Systems, Corvus Concept, Corvus Concept Plus, Corvus Uniplex and Corvus Unibus are all trademarks of Corvus Systems, Inc. UNIX is a trademark of AT&T Intellectual Property.

It's the only small applications-processor that's network-ready. So it expands or shrinks to fit any multi-user, multi-tasking systems you design. Even those with pocket-sized budgets.

Or if you're looking for a ready-made network workstation, try our new Concept Plus™. It comes complete with all the high-performance features of the Corvus Concept™ personal workstation, plus the industry standard UNIX operating system.

Tying together networks containing these two processing nodes is a common thread: OMNINET™ the

local area network that's rapidly becoming a standard.

Applying all these products together is Corvus, a leading designer of high-quality mass storage devices, networks and microcomputers.

To find out how easily you can tailor these network nodes into your next OEM product, write Corvus Systems, 2029 O'Toole Avenue, San Jose, California 95131, or call John Houghton at (408) 926-7700.

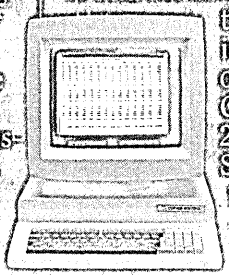

Apollo recognizes the fact that there are two sides to every professional.

*There's a part of
a professional
that involves
their profession.*

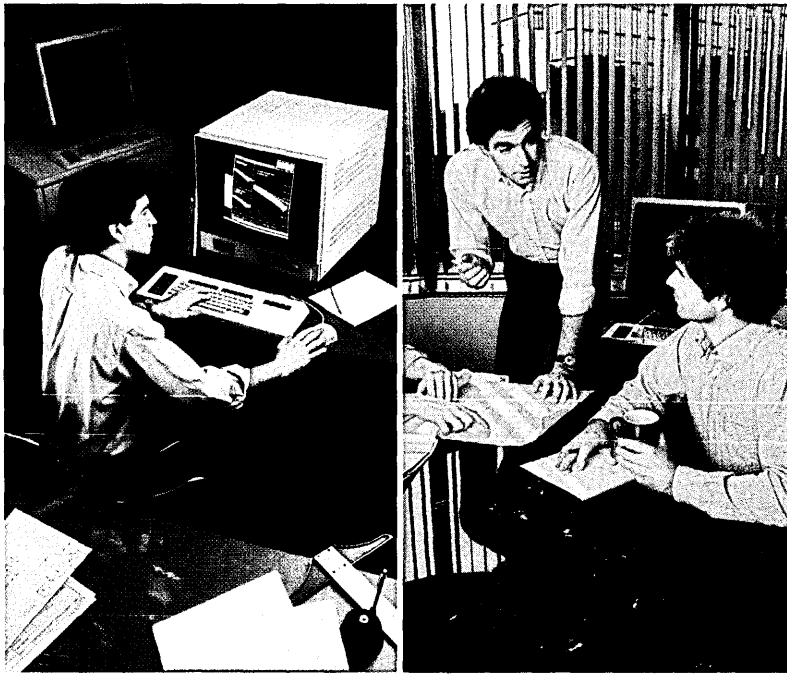

*Then there's the part
that goes to meetings,
makes presentations,
does budget, prepares
documents.*

According to recent reports, people who work with computers spend some 30% of their day working in their chosen profession. And 70% of their day just getting things done.

So we're announcing some ways for making better use of both sides of their day.

For starters, we've set some new standards in high performance workstations. By introducing a new set of Apollo computational nodes so fast you don't have to wait for them to figure out anything. Even when you're working on Solids Modeling, Image Analysis, Finite Element Analysis, and VLSI Design.

The Apollo DN 660 and DN 460.

Inside you'll find up to 4 MB of main memory. With full 32-bit architecture and an integrated hardware floating point unit. And enough power to handle up to 24 concurrent processes, each with up to 256 MB of virtual address space. Plus high resolution bit map graphics that among other things, can do area



The power of a high-end 32-bit supermini at your desk for a fraction of the price.

fills at up to 320 million bits per second.

In other words, they've got all the power of a high performance supermini like the VAX* 11/780. Except that they sit at a desk. And go for a fourth of the price.

But even more important, each DN 660 and 460 workstation node you add to the Apollo DOMAIN network adds power instead of taking it away. Because each is a 32-bit workstation with network wide virtual memory that lets all Apollo nodes share data, software, programs, and peripherals transparently across the network.

But we've also introduced software that helps professionals work with the other side of their work: DOMAIN Professional Support Services. With Document, Mail, Calc, Calendar and File. All based on the more complex needs of the professional. And fully integrated with your application programs. So you can do all your work on the same system.

All of which should come as a very welcome development to every professional. Because we at Apollo are not simply making computers. We're making workstations that work for professionals.

For more information call or write Marketing Services Director, Dept.M1, Apollo Computer, 15 Elizabeth Drive, Chelmsford, Massachusetts 01824 (617) 256-6600, ext. 6608.

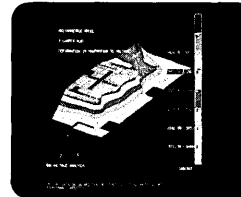

The DN 660 and DN 460 can do state-of-the-art Finite Element Analysis at state-of-the-art speed.

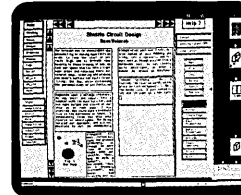

They work on documents the way professionals work.

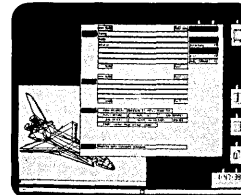

They do Electronic Mail, Filing and Calendar Management.

apollo

*VAX is a trademark of Digital Equipment Corporation.

SOFTWARE & SERVICES

The package also tracks back orders and broken case lots for large users.

The DEctap system consists of eight programs and can be tailored by users to produce reports that fit specific business needs. The package can measure inventory turnaround by product line, and recalculate prices as desired. Sales personnel can put holds on inventory sold and the system will automatically put through a restocking order. Users can also order credit checks and histories, see which customers are buying more and which are buying less, and rank cumulative sales.

The system comes with payroll, accounts receivable, accounts payable, general ledger, and fixed assets modules. All of the programs share the same database information, with automatic updating among modules. DEctap sells for \$56,000 as a turn-key system, including the PDP-11/23 main processor with 512KB main memory, two disk drives, a VT102 terminal, a dot matrix printer, and documentation. DIGITAL EQUIPMENT CORP., Maynard, Mass.

FOR DATA CIRCLE 331 ON READER CARD

T&E MANAGEMENT

The Expense Account Manager is designed specifically to organize and track travel and entertainment expenses for the company executive or for the individual professional. It is available for the Apple IIe and II Plus personal computers with 48KB of RAM, a single diskette drive, and a printer.

Specific features of the product include entry and corrections of expenses, reminders of expenses that are often overlooked, prompting for specific information required by the IRS, and budget projections. For individuals who must charge out their expenses by client or project, an option to provide subtotals is included.

A table of frequently traveled trips is maintained to allow consistent reporting of automobile mileage. The system automatically reconciles travel advances and tracks reimbursements. An interface to VisiCalc is provided to allow ad hoc reporting of the expense data. The system can also print out pocket recording sheets that can be used to record expenses as they are incurred.

The system is designed to allow users to change the definitions of the expense items, budget lines, and subtotals without computer programming. The product costs \$150. ADAPTIVE SOFTWARE, Highland Park, Ill.

FOR DATA CIRCLE 334 ON READER CARD

MANAGEMENT TRAINING

This pair of personal computer-based learning programs draws on research performed by the Higher Education Management Institute for the Alexander Proudfoot management consultants in Chicago, who own this vendor. The Management Diagnostics and Management Training courses are designed

for either individual or group use by managers at all corporate levels. The courses apply generic management training to real-life company problems by combining paper-based and audiovisual techniques with the personal computer.

The product comes with an assessment capability wherein each individual's performance is compared before and after training to broad-based national norms. The self-paced program allows a manager to select courseware relevant to his needs, to stop whenever convenient, and to study as often as is needed. The programs address areas such as management skills, organizational effectiveness, interaction styles, definition of goals and objectives, leadership, motivation, time management, successful meetings, and employee performance.

Each program comes on a standard 5¼-inch diskette. Versions are currently available for the IBM P.C. (and XT) and the Apple IIe. Each of the nine courses costs \$350 to \$450. THOUGHTWARE INC., Coconut Grove, Fla.

FOR DATA CIRCLE 335 ON READER CARD

SYSTEMS DEVELOPMENT

SDM/Structured is a graphics and database-oriented methodology for building information systems that incorporates structured analysis, design, and programming disciplines. The methodology is presented in a top-down, modular structured format that draws upon structured analysis documentation methods.

All aspects of the systems development life cycle have been included in the product, from the service request initiating work through the postimplementation review. SDM/Structured uses dataflow diagrams, a data dictionary, and process descriptions to build models of systems. Structure charts and module descriptions are incorporated to document the internal structure of the system software. Techniques for transforming and transaction analysis are also included.

The methodology produces or reviews a global business model in connection with establishing the scope of a project. Emphasis is placed on tying system objectives back to business objectives. The product provides a detailed approach for production of a relational stored data model from current file definitions, and interfaces with fourth generation languages for application development.

SDM/Structured comes with a 387-page quality assurance manual that provides guidelines and documentation for setting up a quality assurance program. A two-volume set of project administration guidelines is also included. A single-site perpetual license for the product costs \$39,500. AGS MANAGEMENT SYSTEMS INC., Philadelphia, Pa.

FOR DATA CIRCLE 332 ON READER CARD

VAX DBMS

The Ultra database management system for VAX superminicomputers is functionally almost identical to the vendor's TIS product for IBM mainframes, although it is an original undertaking and not a conversion of TIS. The product provides most of the features found in TIS, although some, such as tp monitor support, were omitted because they are inappropriate in the VAX environment.

The product is based on a new DBMS intended for use in a multiple machine VAX environment. It uses multitasking techniques and native mode addressing to provide support for numerous concurrent applications. A task level recovery feature recovers transaction-oriented data on a task basis. The DBMS also provides "shadowing" of each data set for backup support.

The product includes an intelligent query and reporter designed to meet ad hoc requests and complex reporting requirements. The module can compute mathematical problems and perform on-line sorting as well. Users can model "what if" analyses through the query facility, which also supports full Boolean extraction, subtotaling, and page skipping.

As with TIS, Ultra's user interface is the Logical User View, which provides a relational view of data without requiring users to have any knowledge of underlying data structures. The programmer or user sees the data as single flat records. The LUV provides data structure independence, so that applications software is protected from change in the database structure. Prices range from \$50,000 to \$75,000. CINCOM SYSTEMS INC., Cincinnati, Ohio.

FOR DATA CIRCLE 333 ON READER CARD

FINANCIAL MANAGEMENT

Oz integrates data analysis, graphics, and reports to provide microcomputer users with three-dimensional views of data for financial management. The package has a built-in variance analysis system that is designed to facilitate the identification and explanation of budget variances.

The product uses a mixture of commands and visual prompts to allow users to project revenues and expenses, compare actuals to forecasts, provide three-dimensional views of data, and graph information on the screen. Full-color graphics are supported if the hardware includes a color graphics card and monitor.

Oz allows users to set up on-screen organizational charts for entire companies, which can be broken down to show specific parts of the company. The format allows data, reports, graphs, and variances to be broken down organizationally, facilitating performance evaluation of each department. The same data can also be consolidated to give a global picture. The software measures actual performance by keeping track of line items month by month, so that users can determine year-to-date revenues

Due to popular demand, we've created a new display that fits both tight spaces and tight budgets.

Our new ITT Courier 1700.

The 1700 is compatible with the 3278 model 2. Yet its footprint is only 13 x 12 inches (24% smaller than IBM's 3178). And its keyboard is only 16 inches wide (17.9% smaller than the 3178).

Still, the 1700 is big on

ergonomics and the kind of performance features you expect from ITT.

Its screen tilts and swivels, and its keyboard adjusts for optimum operator comfort.

It has Reveal to aid program development. Capture to aid troubleshooting. And Variable Field Underline to increase productivity.

Things you don't get with the IBM 3178.

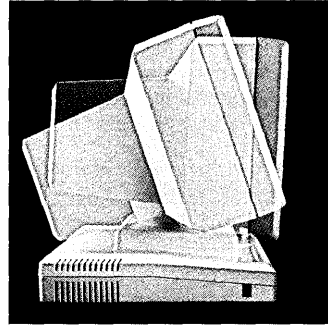

ITT 1700 tilts, swivels and has a smaller price than IBM 3178.

Even with all this, the ITT 1700 is priced lower than IBM's 3178.

The ITT Courier 1700. The economy-sized 3270 display that really is economical.

Contact the ITT Courier Sales Support Department, 1-800-528-1400 Ext. 7796.

1515 W. 14th Street, Tempe, Arizona 85281

ITT
COURIER

WE HAVE 3270 COMPATIBILITY IN THE NEW ECONOMY SIZE.

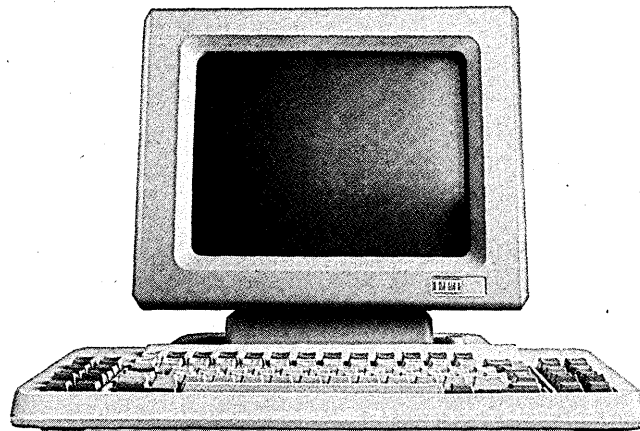

ITT Courier 1700.

CIRCLE 133 ON READER CARD

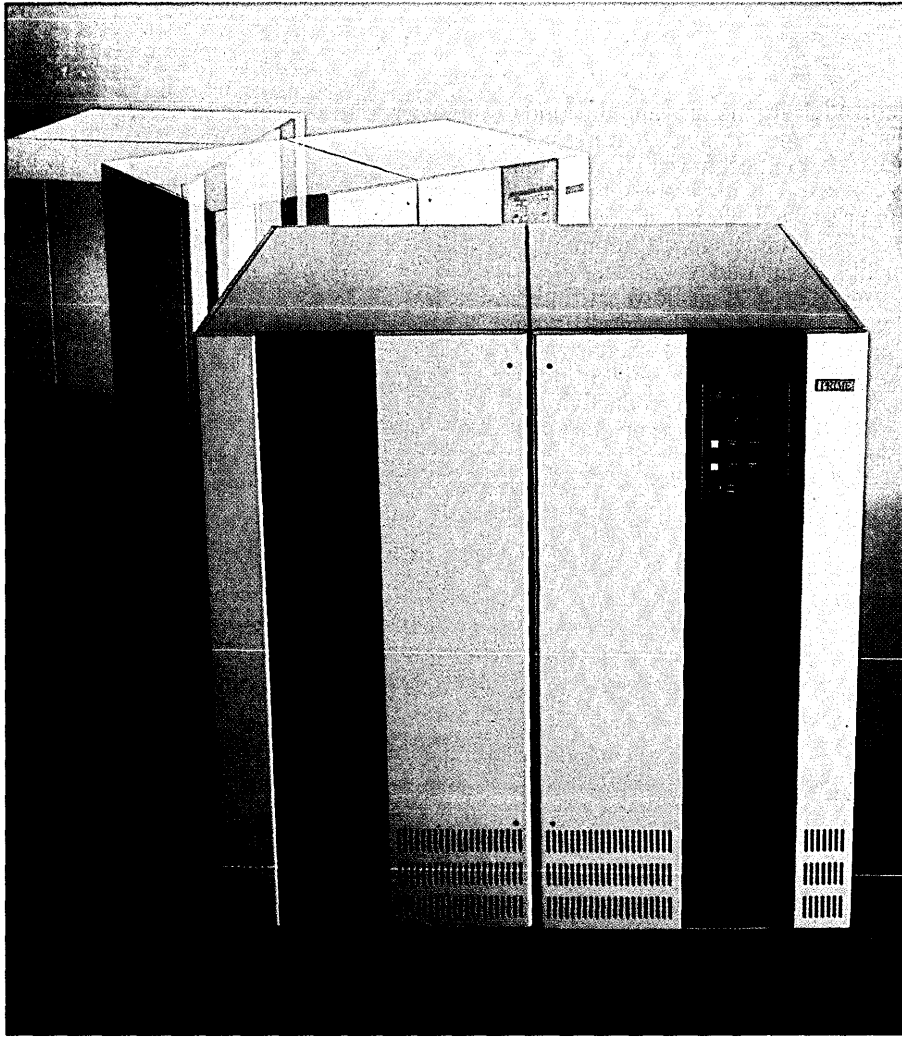

**THE
PRIME 9950
IS POWER
AND
PERFORMANCE.**

THE NEWEST EXAMPLE OF PRIME'S COMMITMENT TO TECHNOLOGICAL LEADERSHIP.

When we introduced the world's first virtual memory, 32-bit supermini we set the pace for leadership that still drives our business today.

For proof we offer the Prime 9950—the most powerful, most technologically advanced computer we've ever designed.

It uses high speed Emitter Coupled Logic—a rarity in minicomputers. Advanced pipeline architecture and unique branch cache memory allow five instructions to be processed in parallel and 255 user processes to be handled at once. 2MB memory boards allow you to economically configure systems up to 16MB. These technical advances provide the power, throughput and price/performance of the Prime 9950.

Like all Prime 50 Series systems, the Prime 9950 runs with PRIMOS, the operating system that makes it possible to easily and economically move software among all Prime systems, or upgrade your system without costly reprogramming or recompiling.

Add the Reliability, Availability and Serviceability built into the Prime 9950 with its new diagnostic processor, and the result is a distinctive combination of a highly affordable, high performance computer, backed by the service and support you expect from a Fortune 500 company.

The Prime 9950. It's our latest and greatest technological achievement. And there's nothing else like it. Anywhere.

For more on the Prime 9950, or on the entire Prime family of compatible computers, call **1-800-343-2540** (Mass., 1-800-322-2450), or write Prime Computer, Prime Park, MS 15-60, Natick, MA 01760. In Canada call 416-678-7331. In Europe write, One Lampton Road, Hounslow Center, Hounslow, Middlesex, TW3 1JB, England. In the Far East, write Unit 1005, Tannery Block, 35 Tannery Road, Singapore 1334.

PRIME
Computer
Offices worldwide.

SOFTWARE & SERVICES

and expenses, monthly and yearly variances from forecasts, and projections of the current full-year forecast. Oz also keeps track of future budgets.

The reporting capabilities allow users to view any data in bar, pie, or line charts on the screen. Once displayed on the screen, any graphic can be printed on hardcopy with a single keystroke. The full Oz package costs \$500 and runs on the IBM Personal Computer. Versions for other micros are promised. FOX & GELLER INC., Elmwood Park, N.J.

FOR DATA CIRCLE 336 ON READER CARD

MAINFRAME SPREADSHEET

Unicalc/DB is an electronic spreadsheet package for IBM mainframes that retains the same syntax and commands as the VisiCalc package for microcomputers. The product offers multi-spreadsheet addressing that can handle complex consolidations of several spreadsheets.

The unit has a capability for accessing several popular database management systems that run on the same computers. File structures that are accessible include DL/I, IMS, VSAM, IDMS, Adabas, Total/TIS, and Datacom/DB. The user can determine where on the spreadsheet data will be written from the DBMS file.

Data can be entered into a spreadsheet using a standard 3270 terminal or compatible device. Users can invoke mathematical functions, such as net present value, and define such functions that can be used in spreadsheets other than the one in which it was defined. The spreadsheet will support a 45-billion cell matrix if sufficient DASD hardware is available.

A series of utilities are included that allow the MIS department to allocate the system resources so that users or departments do not hog the system. A librarian program is also provided to archive or restore user spreadsheets.

The product runs on all IBM mainframes under the VM, DOS/VSE, or MVS operating systems. It requires the CICS, TSO, CMS, or IDMS/DC tp monitor. A single cpu license costs \$19,500. UNICALC CORP., Wayne, Pa.

FOR DATA CIRCLE 337 ON READER CARD

HIGHWAY CONSTRUCTION

The ManageMate software package is specifically designed for use in the highway and heavy construction industry. The set of modules is written in BASIC and contains some 15 segments.

Several of the applications modules are similar to general purpose programs, such as general ledger, payroll, fixed assets, accounts receivable, accounts payable, inventory, and a spreadsheet. These do have some specialized functions for the vertical applications, such as the capabilities for multiple states, unions, companies, and projects in the payroll module.

The other modules are designed specifically for the industry. A job costing module tracks direct and indirect costs, original budgets and revisions, commitments and revenues, and progress reports. An equipment management module tracks all historical costing, utilization, and maintenance scheduling of a company's equipment fleet; it treats ownership and operation of equipment as a separate cost center. An estimating/bidding module develops the estimated cost of construction, allocates estimates, and applies profit percentages to develop a bid price. It also determines project cash flow, investment and return on investment, resource demand distribution, anticipated price escalation, and other variables. It works closely with a CPM/PERT module for project management.

Other modules include purchase order/contract status, process control, product costing, and word processing. The ManageMate modules run under the Pick operating system on Honeywell Level 6 and DEC LSI-11 computer systems with at least 128KB of RAM and 30MB of disk storage. Prices vary for each module, but average about \$4,500. A complete package costs \$40,000. BARBER-GREENE INFORMATION SYSTEMS, Downers Grove, Ill.

FOR DATA CIRCLE 338 ON READER CARD

TELECOM MANAGEMENT

MONIES (Management of Network Income, Expense, and Service) was developed over the past three years in conjunction with the Wells Fargo Bank. The system provides telecommunications management for voice and data communications, computer facilities and automated office systems. It runs on IBM mainframes under CICS.

The package uses menu-driven screens, on-line file maintenance, on-line reporting, system modularity and independence, a security system, and backup/restore facilities. The package includes modules for order entry, inventory, billing, a directory, network analysis, and availability management.

The product automates the job of placing and tracking orders for equipment and services by using a central catalog to maintain control over what is ordered, internal price, vendor price, and other information. The inventory module allows the user to know which telephone, data, and computer equipment is in the inventory on a real-time basis. Databases can be queried by fields or keys, and updates are posted directly from the order entry module.

The billing module collects information from station message detail records, Centrex tapes, other charges and credit records, and other carrier billings. The directory module lists locations and information about personnel within the company, and can be used by other systems for current personnel information. The network analysis module reads the call history data and

provides summaries of network usage by switch and trunk group. The availability management segment automates the handling and reporting of diagnosis, dispatching, and problem solving functions on voice and data networks. The package can be purchased in modules that begin at \$35,000, or as a complete system for \$250,000. STONEHOUSE AND CO., Dallas, Texas.

FOR DATA CIRCLE 339 ON READER CARD

NETWORK DBMS

The Ingres/Net package gives users of the Ingres relational database management system distributed access to remote databases on any DEC VAX computer on a network connected by DECnet. The package is set up so that users run applications locally and the DBMS remotely; the idea is to reduce the number and size of messages traveling across the network.

Currently, the network interface is available only for the VAX computers; Ingres installations based on MC68000 microcomputers will also be able to access the network software in the future, the vendor says. Another future enhancement is the capability of running VMS or Unix on a VAX with transparent access to remote Ingres databases.

Using Ingres/Net, the user need specify only the node and database name that is sought; the network itself is transparent. The package provides automatic DBMS process creation and deletion, message management, and error handling. It is compatible with both DECnet and Ingres security features, but offers no additional security measures.

Up to a dozen users can run Ingres simultaneously on a typical VAX, the vendor says. The package transmits a minimum of data back to the user in retrieval mode and practically none in updating. In retrieving data, the user specifies exactly which data are desired, and only those data are then sent across the network. In updating, the user sends an update to the database, and only a status line is returned. These two features reduce the traffic across the network.

The network addition to Ingress costs \$5,000 for the first node and \$2,500 for each additional cpu. RELATIONAL TECHNOLOGY INC., Berkeley, Calif.

FOR DATA CIRCLE 340 ON READER CARD

UNIX COURSES

The Unix Overview series consists of six 90-minute courses designed to help Unix users prepare for large-system capabilities. The introductory course offers a description of Unix and its major components. The following courses explore the Unix file system, file security capability, communications accounting, text processing, administration, and distributed data processing. Four major Unix applications and five primary states of the application development

You Don't Need Five Reports

ONE

JARS REPORT WILL DO!

Clear, Concise Reporting on All Your Computer Resources
 JARS consolidates all resource statistics from DOS, OS, CICS, TSO, VM, IMS, ICCF and any data you define — into a single database giving you the one report you need for effective cost distribution in your IBM 360, 370, 303X, 43XX and All PCM environments.

JARS is the comprehensive accounting, billing, cost distribution and performance system which lets you account accurately and bill equitably for all resources used.

See for Yourself — Proof Positive!

For additional information on this innovative package,
 contact Johnson Systems at **1-800-368-1010**



8300 Greensboro Drive, McLean, VA. 22102 **1-800-368-1010** or (703) 821-1700
 NATIONAL OFFICES: Chicago (312) 655-3490 San Francisco (415) 562-4818 Dallas (214) 247-3252
CIRCLE 135 ON READER CARD

SOFTWARE & SERVICES

cycle are also presented.

The series is designed to be used either in a self-instructional manner or in small groups. It comes complete with videotapes, an administrator's guide, and a student guide for reference and review. The Unix Overview can be rented for \$50 to \$125 per course per month, depending on volume. Courses can be purchased for \$1,750 each.

A second series of courses on the Unix operating system is designed to immerse users in some of the more technical matters. The Unix Fundamentals set of 15 courses offers training for the C language, the Unix shell, and advanced commands. The entire series requires 24 to 30 hours for completion, by which point the student will have seen graphic representations, actual screen examples, and 30 of the most common Unix commands. Users are assigned tasks involving use of the 30 commands on actual Unix programs.

The Unix Fundamentals courses also cover system communications, path names, files, I/O, file access permissions, file name generation, and communicating with other users. Prices are the same as for the Unix Overview courses. DELTA INC., Naperville, Ill.

FOR DATA CIRCLE 341 ON READER CARD

GEOSCIENTIFIC MODULE

This workstation is specifically designed for the analysis and interpretation of seismic and geological data. The product is essentially the vendor's Vision One/20 hardware system with specialized software to provide real-time interactive capabilities not possible on general purpose machines running similar software.

The GeoSeis package consists of an extra module to the operating system and an upgrade to the Continuous Zoom hardware option. The package's software can perform true three-dimensional volume analysis from "shot line" and "time slice" data, creation of three-dimensional relief images from orthogonal views of seismic images (surface analysis), display of graphical data from vector lists, data compression, and image scaling (modification of the aspect ratio). It can also provide real-time display of vertical or horizontal lines in a seismic image as any combination of "squiggles" and/or "vars," a split-screen display that allows interactive visual comparison and correlation of image data, and movie loop presentations of up to 64 images.

The hardware option allows for interactive zoom and pan. The hardware/software package costs \$7,500. COMTAL CORP., Altadena, Calif.

FOR DATA CIRCLE 342 ON READER CARD

COLOR CAD

The Pathfinder color graphics CAD system supports schematic creation, nets-list capture, parts-list capture, nets-list validation,

computer-aided placement, auto-routing of traces, interactive on-screen routing, continuity and space checking, engineering report generation, drill/assembly/support-drawing generation, numerical control tape generation, and final-film generation. The product is designed to run on the IBM Personal Computer XT.

Software capacities are 98 signal layers, 1,000 EICS, 2,000 parts, 8.6 × E8 grid points, 24 × 36-inch 1:1 board size, 30,000 pins, 5,000 nets, 99 aperture commands, 1,000 part types, 15 trade widths, and 15 external pad types. A standard configuration consists of the P.C. XT modified with 1.6MB of RAM, two half-height 360KB diskette drives, one 25MB hard disk, an 83-key detached-keyboard, a 14-inch 700 × 500 noninterlaced color display, a 12-inch monochrome system monitor, an optical mouse, dual MC68000 coprocessors, an 8087 floating point processor, and a dedicated 1,024 × 1,024 × 4 ert controller with half a megabyte of display RAM. The \$30,000 system also contains a 160 cps 15-inch dot matrix printer/plotter as well as a modem.

The system, despite its modifications, still runs all general purpose software for the P.C., as well as the specialized CAD software provided by this vendor. The menu-driven system is available with a 14-day training program. SUMMIT CAD CORP., Houston, Texas.

FOR DATA CIRCLE 343 ON READER CARD

PERFORMANCE ANALYSIS

The VMAP Analysis performance service is designed to help VM installations identify or confirm performance problems, and to recommend solutions to these problems. If VM installations are considering an equipment upgrade, the service can determine whether such an upgrade is in fact necessary.

The service provides a one-time analysis of a single computer system running VM/370 or VM/SP with guest operating systems, CMS, or both. The service also provides a mechanism for follow-up to answer questions that might be raised by the initial analysis. The service provides an annotated copy of the performance analysis, highlighting indications of possible bottlenecks, performance problems, and overload situations. An executive summary and detailed explanation of findings is provided, as is a commentary on installation-specified problems.

The service can be done periodically to obtain performance evaluations over specified time intervals in order to see any long-term trends in system performance. In single analysis situations, the periods in which system performance is to be studied can also be selected based upon known variations in workload, such as those due to seasonal demands. As a high-load time period approaches, plans can be laid to monitor system performance. The results of the

analysis can then be used as a basis for the development of alternative strategies to reduce contention and improve throughput during future critical periods of operation. The fee for a single analysis is \$875. THE ADESSE CORP., Ridgefield, Conn.

FOR DATA CIRCLE 344 ON READER CARD

OPERATING SYSTEM

The SMM300 MUMPS-based operating system for the DEC Professional series of microcomputers supports one to three users, although the addition of a real-time interface board can support an additional two simultaneous users.

The product, a specialized version of the vendor's standard MUMPS product, has been available in Europe since last spring. It was developed to run on the Pro 325 and 350 computers, and provides a compatible environment for standard MUMPS financial management, medical practice, and other application programs. Software for word processing, spreadsheets, and graphics is also available.

The SSM300 package is being used as the basis for the vendor's medical and dental practice system. A single license for the operating system, supporting three users, is \$1,400. ADVANCED COMPUTER TECHNIQUES CORP., New York, N.Y.

FOR DATA CIRCLE 345 ON READER CARD

CROSS COMPILER

This C cross-compiler is designed for the NS16000 series of microprocessors. The compiler provides facilities for writing machine-dependent software, including device drivers and interrupt handlers, so that users who wish to implement the 16032 chip with C can avoid most assembly programming.

The product is composed of a native code generator for the host development machine and a code generator for the NS16032. The compiler package also includes a cross-assembler that can produce complete assembly listings, including addresses, object code, and assembler source code. A cross-linker is provided for construction of RAM/ROM combination systems.

The cross-compiler is based on the family of C compilers from Whitesmiths Ltd., which supports the C language as defined by Kernighan and Ritchie. Floating point support is also provided in conjunction with the NS16081 floating point unit. The compiler package has been used to port the vendor's C Executive, a ROM-based real-time monitor, to the National Semiconductor DB16000 development board.

The C compiler is currently available for VAX/VMS, RSX-11M, Unix, and Idris host computer systems. The cross-development package is available for \$2,500, including documentation, media, and shipping. JMI SOFTWARE CONSULTANTS INC., Roslyn, Pa.

FOR DATA CIRCLE 346 ON READER CARD

—Michael Tyler

If Productivity Matters, So Does Service.

When your company counts on computers, you can count on TRW Customer Service to keep them up and running.

Downtime is lost time. If your systems or peripherals are not functioning, chances are that it shows in your business productivity.

Find out why more than 80,000 companies trust TRW to keep their hardware up and running with service when they need it. No hassles, no excuses. Just quality work at competitive prices from an organization dedicated to service, and only to service.

TRW Customer Service is the nation's largest independent repair, maintenance and service organization, with more than 3,000 highly trained, problem-solving professionals at over 200 U.S. locations — including Puerto Rico and Hawaii.

Computer Service. It shows on the Bottom Line.

Write for complete information and service locations.

TRW Customer Service
15 Law Drive
Fairfield, NJ 07006
(201) 575-7110



**Nationwide
Service From
A Company
Called TRW**

NOMAD2

The Gifted Software

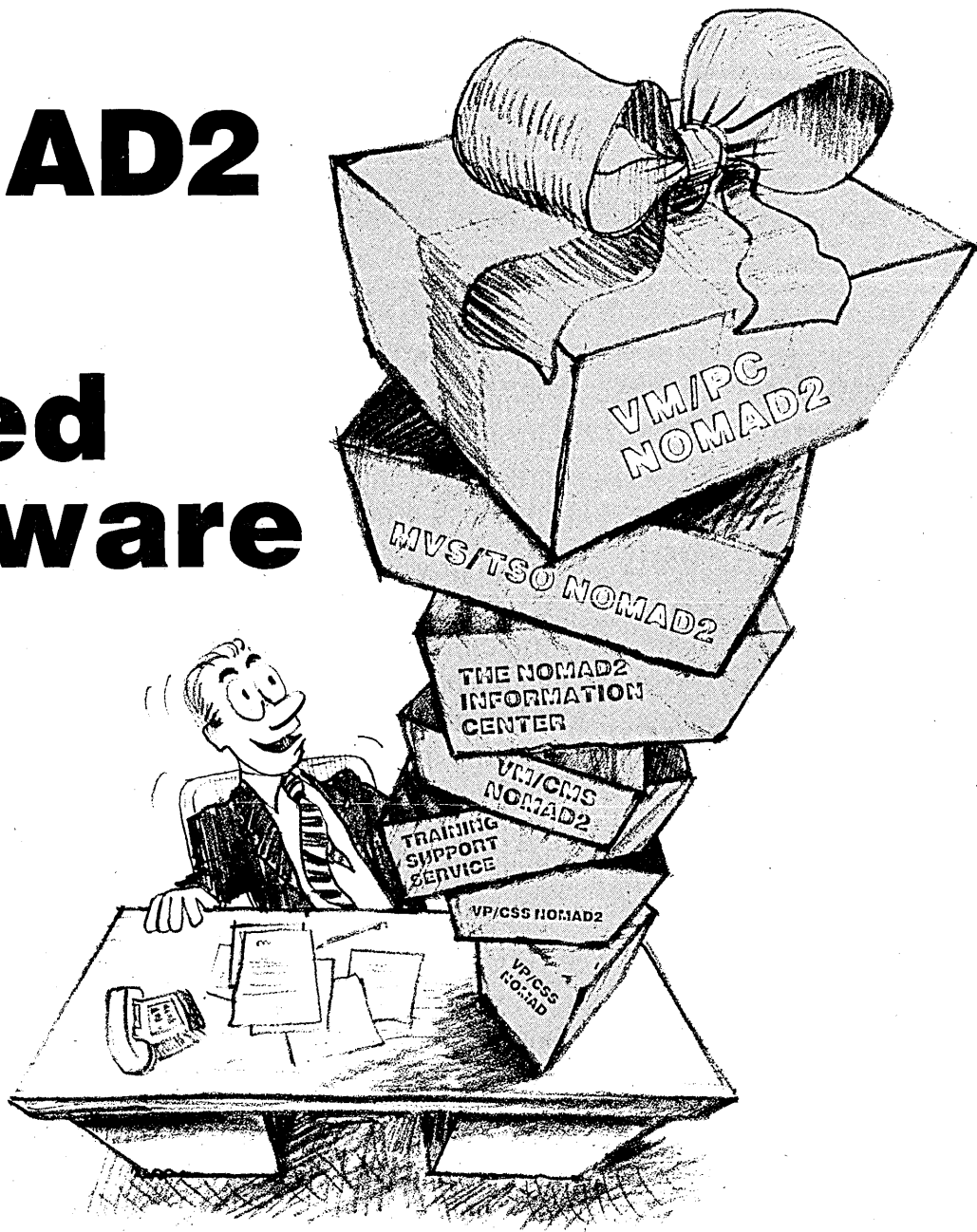

For more information
write to:
Roger Cox
D&B Computing Services
187 Danbury Road
Wilton, CT 06897
or call Roger Cox
at (203) 762-2511.

I would like to know more about:

- VM/PC NOMAD2
- MVS/TSO NOMAD2
- The NOMAD2 Information Center
- VM/CMS NOMAD2
- VP/CSS NOMAD2

Name _____

Title _____

Company _____

Address _____

Phone _____

NOMAD2*



Experience the Difference

* NOMAD is a registered trademark of D&B Computing Services, Inc.
©Copyright D&B Computing Services, Inc. 1983. Printed in U.S.A. 11/83

D&B Computing Services

DB a company of
The Dun & Bradstreet Corporation

SOURCE DATA

BOOKS

NEEDED: PROFESSIONAL MANAGEMENT IN DATA PROCESSING

by John J. Callahan

Even though the information industry is approximately 30 years old, very little has been written about professional management in dp. What must systems people do to learn and practice professional management theory and skills?

The author of this book has many fine thoughts on the ideal dp manager. But he fails to state the case effectively for more professional management selection, development, evaluation, and promotion of dp practitioners, especially those moving into positions of authority. Callahan might have conveyed his message better if he had adapted the research findings and recommendations within the field of general management and human resource development (HRD) to the particular needs of dp personnel. For example, material from the American Management Association's courses on management development could be incorporated into an information technologist's training. In addition, perhaps some of the current management literature of the MBA curriculum would be useful for future managers who come from a computer studies background.

We know little about this author—perhaps practitioners recognize the name and reputation of John Callahan? The publisher certainly gives us no clue to his background within the pages or on the cover of this book. Nonetheless, Callahan makes some interesting points in his introduction. He suggests that people did not take the “futurists” too seriously, so many were apparently caught off guard by the development and popularity of on-line systems, small computers, and word processors. Callahan frequently refers to the dp shop where the prevailing mentality seems to be managing machines, not people. He is severe in his critique of the industry and re-

minds us that in data processing, promotions go to the best technological performers, not to those most qualified to supervise and manage. As a result, he sets out to review “the current conditions, problems, and status of data processing management in the U.S. today and to suggest steps for some corrective action.”

Callahan tries to do this in 18 short chapters plus a conclusion and bibliography. In Part I, he looks at the management problems in data processing from his perspective, and builds his case for more professional management. But this approach is seemingly based on his experience and observations, and not on concrete data. He makes generalizations and assertions, and beats his good points to death by repetition. My problem as a reviewer is that I basically agree with his position, but he gives me no evidence as to why I should agree with him.

For example, in the first chapter, he uses an obsolete paradigm of management based on the disappearing industrial work culture (i.e., management is simply organizing, planning, directing, leadership, and control). It is as if he had never heard of

Alex Mackenzie's classic model of the management process and the emerging mainframe industrial work culture. Even his comments on planning fail to acknowledge the MIS manager's need to know about strategic planning concepts and tools. After inadequately discussing the dimensions of professional management, Callahan proceeds to examine who gets promoted to management in dp operations. He vehemently maintains that an inherent conflict exists in the dual roles of systems analyst and programmer, which requires a person to exercise two different sets of skills. “Data processing managers who are pushing these dual-role jobs have shunted aside the serious questions of employee tendencies to be either systems-oriented, or to be programming tasks-oriented.” Having introduced the issue, Callahan then questions the validity of Management by Objectives (MBO) and discusses shortfalls in appraisals and inadequate technology focus. His prime source of support throughout the book is a 1973 volume by Harvard professor Harry Levinson, *The Great Jackass Fallacy*, from which he liberally quotes.

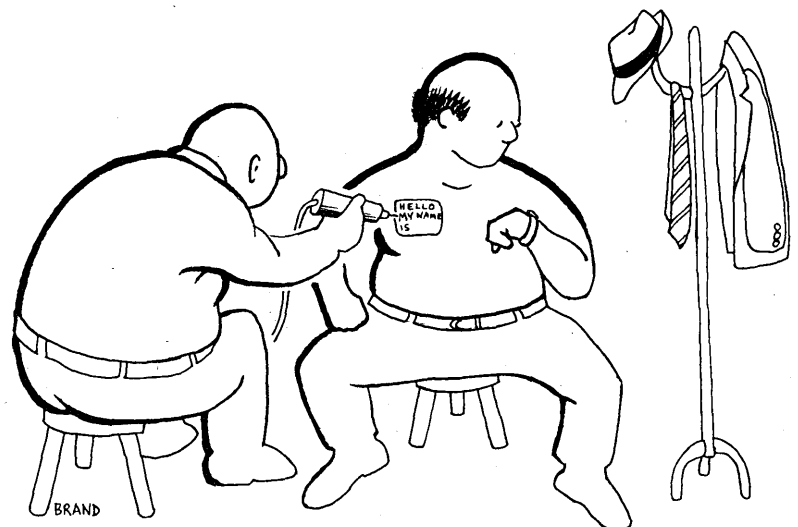

SOURCE DATA

The next several chapters raise some excellent points in support of the need for professional management, but these are again undercut by outdated or incomplete theories. For instance, the third chapter analyzes motivation but ignores most of the behavior science research on the subject. Instead, demotivational factors are cited without any supporting evidence (e.g., an analyst can spend up to 75% of his time programming and be turned off about work while proving to management that he is a great programmer; or high turnover in the industry is caused by lack of motivation in data processing jobs).

In chapter 4, the author identifies 18 symptoms of managerial problems. He then describes the management styles evident in dp "shops"—the authoritarian, the militarist, the perfectionist, the politician, the technocrat—but fails to describe the kind of leadership he would prefer. In chapter 5, Callahan provides a superficial overview of control techniques used by management, and is weakest in his analysis of project management. By now, readers will see how slight and unconvincing the content is by its negativism. Since we know nothing of the author's dp experience, we can only conclude that it was not good. We wonder if his experience is typical. Having worked exclusively as a management consultant to the industry and not inside a dp department, this reviewer can only ask readers to affirm or deny Callahan's general position: "As currently existent in data processing, the leadership philosophy with rare exceptions is to beat the hell out of employees who make mistakes and reward those who don't; this is the great nemesis again of the carrot and stick, or 'the great jackass fallacy'!" Unfortunately, when he does examine effective leadership, Callahan fails to back up an archaic and questionable "trait theory" of leadership. To be an effective leader, all one has to do is learn to practice the traits he outlines as essential.

Callahan assumes that most analysts/programmers and managers are male, and blithely ignores the positive developments in equal employment opportunities. Worse still is the publisher's failure to correct his constant references to his, he, him, or chap when referring to dp professionals and managers. Callahan simply ignores the movement of women into this field and into the ranks of management in general.

In Part II, the author attempts to be more positive by sharing his visions of constructive changes in leadership, performance evaluation, handling of problem employees, burnout, and other miscellaneous topics called "potpourri." He offers helpful tips for improving performance assessment, but does so in a rather prescriptive way by using many "shoulds" while railing against current dp practice. Callahan completely ignores the importance of corporate culture, the impact of automation on

the office and work relations, the concept of organizational power and how to use it, and ways to improve organizational relations. He fails to mention advances in human resource development within establishments (for example, the HRD program in edp at Manufacturers Hanover Trust), and provides no exemplary individual or corporate behavior models.

The author began with good intentions, but his approach fails. He has completely undermined his case with this weak work, and succeeds only in alienating the reader. Prentice-Hall Inc., Englewood Cliffs, N.J. (1983, 206 pp., \$25).

—Philip R. Harris

PROGRAMMER PRODUCTIVITY—MYTHS, METHODS, AND MURPHOLOGY—A GUIDE FOR MANAGERS, ANALYSTS, AND PROGRAMMERS by Lowell Jay Arthur

Programmer Productivity provides a fast-paced description of the many ways to improve software development and maintenance productivity. It is useful for readers who know little about software productivity issues, but it is not thorough enough for those who are already familiar with the subject and want to learn more. While the book is relevant to many kinds of software development and maintenance, it is specifically geared to dp shops that develop and maintain COBOL applications for users within their company or organization.

The first chapter describes the evolution of software engineering. It documents the common dp shop practice of using a high percentage of resources to maintain older applications, rather than explore ways to improve productivity by developing new applications.

In the first half of the book, software productivity improvement tools and concepts are organized under the categories of methodology, technology, people, management and organization, and metrics. Under methodology, Arthur recommends a phased software development process, argues for generic (reusable) designs and common code modules, and summarizes concepts of software modularity and path analysis. For the technology category, Arthur urges the use of office automation tools (word processing, electronic mail), requirements definition tools, design tools, and various coding and testing tools, and advocates providing end-user tools in an information center (as an alternative to dp shop application development).

The author reviews computerization in general, and then explains how to make methodology and technology changes acceptable to programmers. On the topic of management and organization, his main in-

terests are structuring management tasks carefully, evaluating use of management by objectives and use of quality circles, and choosing one of several project management styles.

Software, once developed, should be measured for conformance to productivity-related guidelines. Arthur outlines numerous metrics for measuring software characteristics, and in a matching appendix, he lists a COBOL program for deriving and printing these metrics from COBOL programs.

The second half of *Programmer Productivity* deals with a series of specific issues: reliability, maintenance, quality assurance, auditing, and buying software. Material from the first half of the book is often repeated here, and the discussion of auditing is mostly tangential to the subject of programmer productivity. Arthur's advice, however, on how to buy software packages, as an alternative to developing them, is crisp and sensible.

One of the key points in *Programmer Productivity* is the author's recognition and insistence that productivity improvement is intensely valuable, even if only partially realized, and is an attainable target for anyone in a software development shop. Gains in productivity can be pursued by managers, designers, coders, or testers. The entire shop will benefit if the productivity tools or concepts pursued are appropriate to the organization and are actually put into use.

Arthur insists on using generic designs and common code modules, particularly in software development, where originality has little payoff, but fast and economical development is the key. Supporting this point are several examples and suggestions in the areas of master file updating and report generation, including a generic COBOL file update program provided in an appendix.

One of the book's strengths is Arthur's pungent wit. He writes in a breezy style and uses apt quotations (attributed and not) to start chapters, sections, and major points. Two favorites of mine were: "Any system can and will take longer than expected," and "The only lesson history has taught us is that man has not yet learned from history."

The book, however, is somewhat marred by its limited focus on in-house COBOL application development. While many forms of programmer productivity improvement are generic to all software development enterprises, the book does not address significant problems in many software development activities. For example, some unexplored problems are projects with very complex requirement definitions (military applications, software for sale); projects that need extensive prototyping or complex integration staging; microcomputer software development and scientific

Once, and for all.

Cullinet's General Ledger and Financial Software System.

Enter an item in one component of Cullinet's Financial System, general ledger for example, and it's entered in all of Cullinet's Financial System components.

Enter it once and you can access financial data through any of eight components.

Entered once, it's available for all.

This is only possible because all of Cullinet's Financial components share a common database. This integration is so thorough that data can be called up from separate components joined and viewed together at the same time. This integration also extends to the full line of Cullinet applications software (our manufacturing system, for instance).

Personal computer applications are also integrated in this unique enter-it-once-enter-it-for-all system. A person can access financials directly from the database, manipulate them on a personal

computer and then store the results in Cullinet's Database Management System.

Features such as these suggest the Cullinet's Financial System may be the most effective way

to eliminate data redundancy, facilitate monthly closings and, most important, make accurate financial information accessible to the people who most need it. When they most need it.

Once, and for all.

For more information and a schedule of seminars on Cullinet's Financial System call (617) 329-7700.

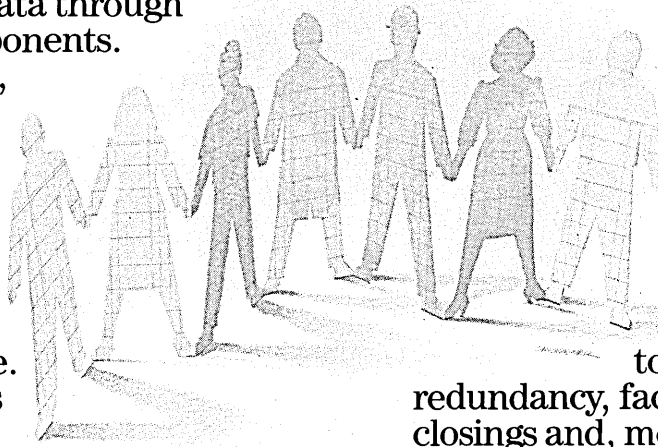

Cullinet

**TISTM WINS
INDUSTRY'S
HIGHEST
TECHNOLOGY
AWARD.**

TIS



Heralding it as an entirely new generation of interactive database software, the prestigious Associated Information Managers (AIM) has named Cincom's TIS winner of its Outstanding Technology Award for 1983.

Comprised of more than 1,000 information managers from all sectors of business and industry, AIM recognizes outstanding achievements in the information systems industry each year at its annual meeting in Washington, D.C. The award Selection Committee comprised five of the nation's most prominent information industry professionals.

In bestowing its highest award to TIS, AIM cited TIS as "a major advancement in integrated database technology, using a unique combination of the In-Line Directory which provides controlled security and integration of all components... and the Logical User View, which provides applications and users a relational view of the data."

The AIM award represents yet another milestone for this powerful, next generation

database software. And it's indicative of TIS' wide acceptance by senior data processing managers and MIS directors, who seek leading edge information technology that represents a long term solution.

Fully operational, with thousands of applications now running in both the Development Center and the Information Center environments, TIS gives corporations one powerful system that meets virtually all corporate, departmental, and individual information system needs.

At Cincom, we believe TIS represents a generation of proven in-house, interactive database technology that's years ahead of any other software product. And we're pleased that AIM concurs.

But don't consider TIS just because it wins awards. Choose it because of the dramatic productivity gains TIS is achieving for major corporations worldwide. And because you want the most advanced new information system development technology for your organization.

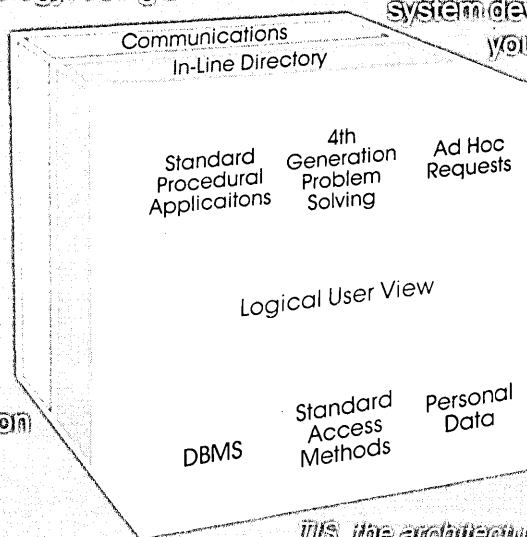

For more on TIS, contact our Marketing Services Department, 2300 Montana Ave., Cincinnati, OH 45211, or call us direct.

800-543-3010

(In Ohio: 513-661-6000)
(In Canada: 416-279-4210)

TIS, the architecture of the next generation of integrated database technology.

Cincom Systems

TIS is a trademark of Cincom Systems, Inc.
CIRCLE 189 ON READER CARD

SOURCE DATA

application development (where COBOL is lightly used); and large projects with multiple management levels and formidable interdependencies.

The book is also restricted by its lack of depth and precision in several areas. For example, Glenford Myers' classifications of module coupling and module strength are listed but not explained thoroughly enough for a novice to understand (illustrations would have been helpful here). Similarly, project organization alternatives are described so generally that not one could be used in its present form for a real software development project.

Arthur usually avoids attempting to classify, rank, or prioritize the many productivity tools and concepts he describes. Given a programming shop at some level of sophistication, what new tools and concepts will offer the biggest bang? If a programming shop today lacks word processing, quality circles, module architecture concepts, an information center, and a source code librarian, which of these should it most urgently try to add? The path to sophistication is often similar in various programming groups. Books on programmer productivity would serve readers well by documenting levels of sophistication and making recommendations for new tools and concepts.

Programmer Productivity is a useful primer on current views of software development and maintenance productivity. I recommend the book as an eye opener for anyone who has relatively little knowledge of software productivity tools and concepts and wants to learn and might be in a position to influence his or her software development organization. I do not recommend the book for those who have a more sophisticated understanding and want a deeper, more thorough treatment of the subject. John Wiley & Sons, New York (1983, 224 pp., \$22.95).

—George H. Bosworth

REPORTS & REFERENCES

SOURCE SPOT

Hewlett-Packard is offering a reference service that contains information on the entire HP computer product line. The five-volume "HP Reference Service" is designed primarily for consultants, but the company claims it will be beneficial for libraries, research organizations, and individuals considering the purchase of an HP computer product. Four of the volumes cover HP's scientific, business, and personal computers as well as peripherals, software packages, and support. Included are data sheets, product brochures, technical specifications, and ordering instructions. The fifth volume looks at HP's organization, its corporate objectives, and its history. Other features of the reference service include three updates a year, telephone access to HP's factory for

answers to product questions, and a subscription to the consultants' edition of *Computer Advances*, a bimonthly newsletter on new products. The HP Reference Service is available for \$225 and can be ordered through any HP sales office or by phone with an open HP account, American Express card, Visa card, or MasterCard. Alaska, Hawaii, or California residents should call (408) 738-4133; all other U.S. residents may call toll-free (800) 538-8787.

TO MARKET, TO MARKET

If you're trying to sell the micro software you've designed you may want to pick up a copy of the *1984 Programmer's Market*, published by Writer's Digest Books. In it you'll find information on hundreds of markets for your program. The directory shows you where and how to submit material and lists over 500 software publishers, arcade game publishers, and magazines with information on people to contact and where. It also includes submission requirements, royalty/payment terms, available contract work, and tips from buyers on selling software. Another section shows you how to prepare a query letter or a proposal package, and gives you pointers on how to copyright your program. The index is divided into three sections for easy reference: type of computer, types of software published, and alphabetical listings. The directory will be updated and published annually to keep you informed of new publishing opportunities. It costs \$16.95 plus \$1.50 postage and can be ordered from Writer's Digest Books, 9933 Alliance Road, Cincinnati, OH 45242. For credit card orders, call toll-free (800) 543-4644.

CHOCOLATE CHIPS

The Computer Museum is offering all kinds of goodies this Christmas. In addition to the one-of-a-kind drawings by Harold Cohen (see DATAMATION, Oct. '81) there are computer chip tie tacs, sweatshirts sporting images of computing luminaries Ada Lovelace and Pascal, gold-plated chip carrier earrings, and a 5-ounce chocolate personal computer. The museum claims its consumable PC is "compatible with all existing hardware, is user friendly and delicious." For a copy of the catalog, contact The Computer Museum, One Iron Way, Marlboro, MA 01752, or order by phone at (617) 467-7658 or 7331.

STRATEGIC REFERENCE

The fourth annual edition of "Corporate Strategies for the U.S. Computer Industry" has been published by Newton-Evans Research Company. The report contains research and analysis on 100 of the country's largest computer, computer services, and data communications businesses, and includes a six-year financial history of each company reviewed. The 750-page report is available at a cost of \$850. For more infor-

mation, contact Karen Dargis, Newton-Evans Research Co., 13382 Grinstead Court, Sykesville, MD 21784, (301) 442-1575.

COMMUNICATIONS REF

A comprehensive data communications information service, *The Data Communications Source Book*, has been announced by its publisher, Information Systems Strategy Corporation. This service will include a loose-leaf reference book covering the entire spectrum of data communications, as well as quarterly updates. It is intended as a "personal resource for the busy manager or professional, and as a cost-effective addition to a technical library's collection." Topics covered by the source book include local area networks, network architectures, facsimile, PABX systems, communications protocols, network control and management, and network services. Charter subscriptions cost \$195 for the first year. For more information, contact Information Systems Strategy Corporation, 21515 Hawthorne Blvd., Suite 432, Torrance, CA 90503, (213) 543-5565.

PERIODICALS

LAW IN ORDER

Law Office Guide in Computers has introduced a monthly newsletter on computer topics aimed specifically at lawyers and legal administrators. The newsletter will feature articles and reviews on hardware, software, systems, word processing, telecommunications, new product announcements, books, magazines, and consultants. It will also contain user interviews, a reader exchange, purchasing information, and dates of conferences, conventions, seminars, and trade shows. The annual subscription is \$120 and can be ordered from Law Office Guide in Computers, P.O. Box 701, Larkspur, CA 94939, (415) 927-1747.

SHOW ME

If you can't decide which micro shows you should be exhibiting in, Dekotek may have some answers. In a monthly newsletter called *The Exhibit Reporter*, Dekotek will provide companies with all the information they need to decide which shows will offer them maximum exposure at the most reasonable cost. The newsletter will include a three-year calendar of microcomputer events, and will have in-depth profiles of each event, including dates, locations, numbers of exhibitors, booth costs, registration deadlines, and sponsors. A one-year subscription costs \$190. To subscribe, contact Dekotek Inc., 2248 Broadway, New York, NY 10024, or call (212) 799-6602.

SEMINARS

HOUSTON SHOW

The Fourth International Conference on Information Systems will be held at the Hous-

Call for a free dragon poster.

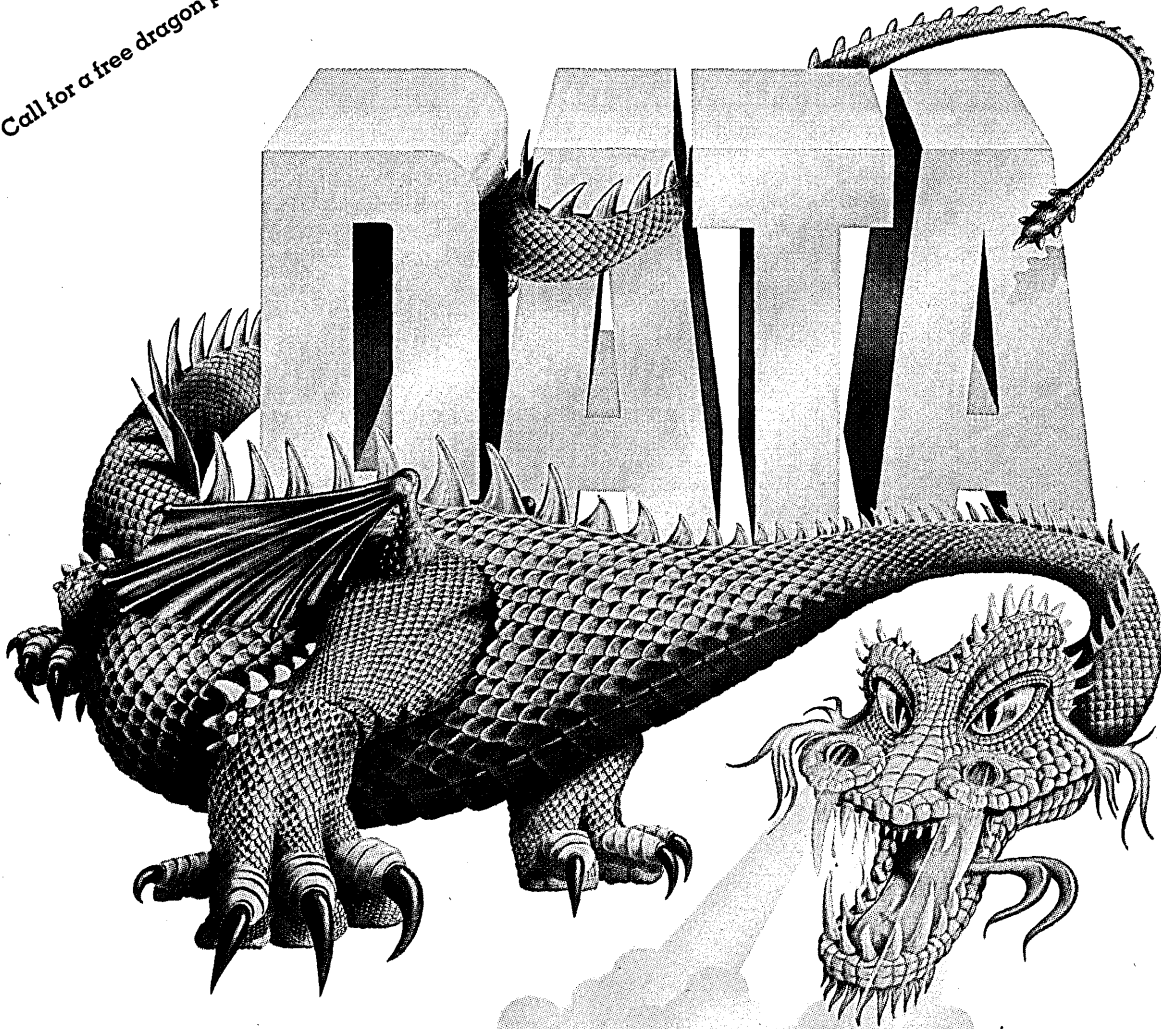

Some data security methods work better than others.

TOP SECRET

the state-of-the-art resource protection package for MVS works best of all.

TOP SECRET is data security at its best. Offering quick installation, phased implementation and comprehensive resource protection, TOP SECRET outdistances all other data security methods for total resource protection.

TOP SECRET immediately secures your most critical resources without impacting normal processing. Implement security with no delay and with absolutely no modifications to your operating system.

TOP SECRET is the only total resource protection package that offers comprehensive CICS security, including file and program control and protection down to the field level.

By using the Standard MVS Security Interface, TOP SECRET becomes an integral part of your operating system. Complete compatibility with all IBM and vendor products that use Standard Security is automatic and guaranteed, now and in the future.

TOP SECRET security comes with the same top-notch technical support that guarantees the quality and reliability of all CGA software products.

Protect your valuable data resources today. Join the MVS sites across the country that have considered every data security method and made the sure TOP SECRET choice.

Call for additional product information and your free trial.

800-237-2057

cgga
Software Products Group

P.O. Box CGA-1
Holmdel, NJ 07733

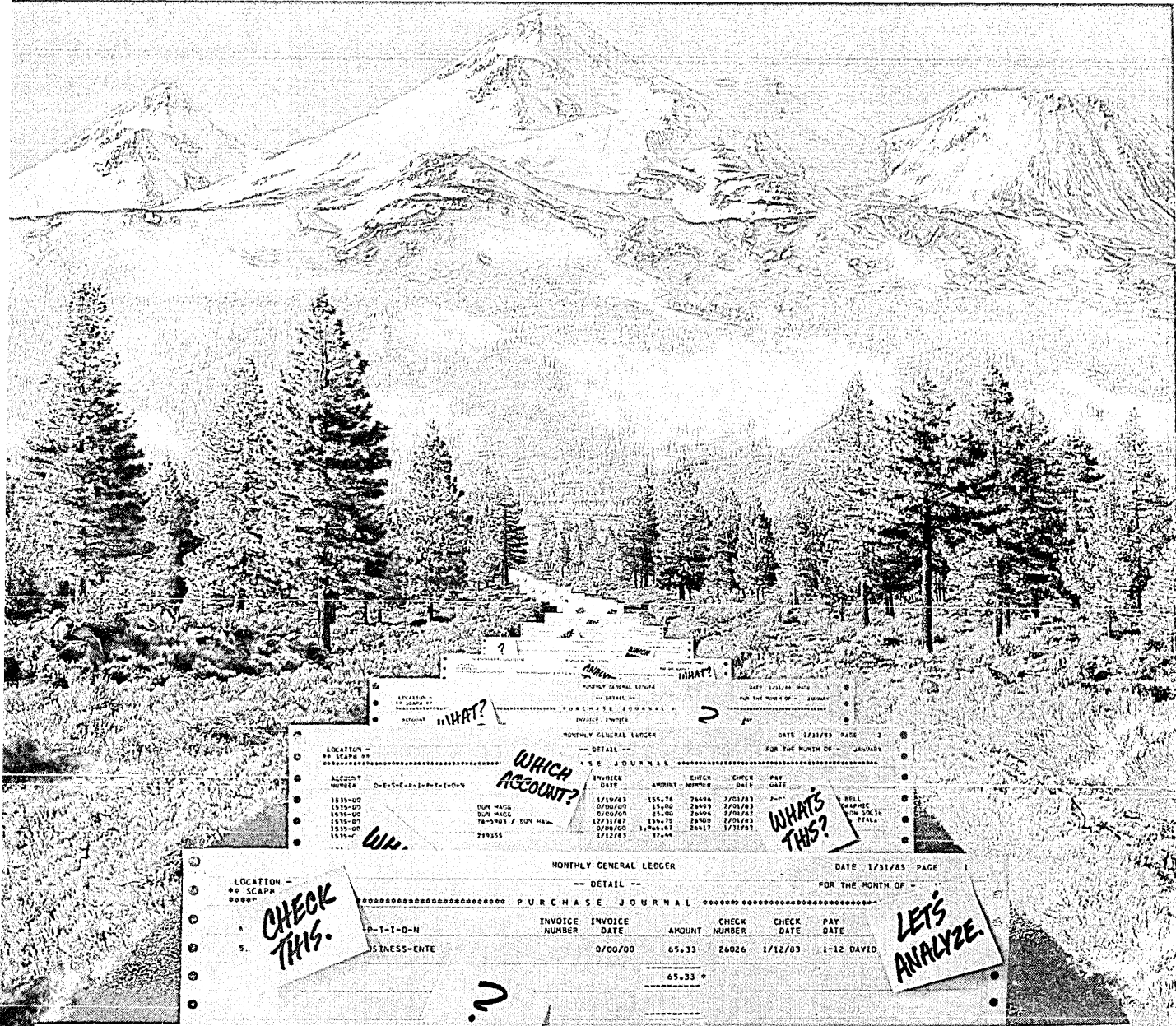

THESE POINTS OF INTEREST ARE BROUGHT TO YOU BY POST-IT NOTES.

When you're facing miles of data, it helps to have a few signs to point the way. Post-it® Notes are handy for calling attention to questions or problem areas, for indexing print-outs, even for temporarily labeling computer tapes. Their unique adhesive sticks when you want it to, comes unstuck when you want it to.

Post-it Notes are available from your local office supply dealer. Ask for a free sample, or phone toll-free 1-800-621-5282. Commercial Tape Division/3M.

"Post-it" is a trademark of 3M.

3M hears you...



In simple terms, CalComp plotters are faster, more versatile and are setting new standards for the industry.

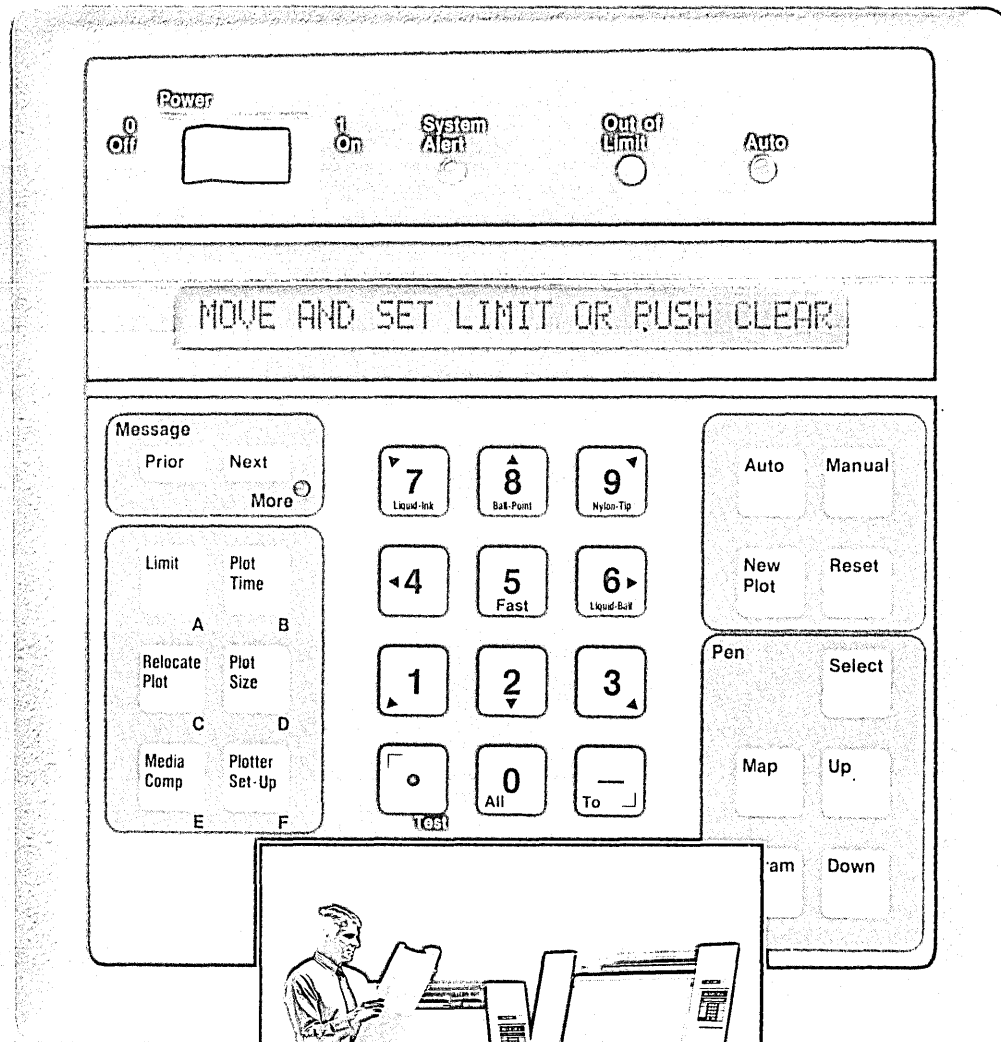

CalComp makes it simple to operate the Model 945 and 965 plotters.

The control panel uses simple instructions that anyone can quickly learn. The instructions appear on a 32-character display that prompts the operator and gives complete control over all plotting parameters.

As for speed, the CalComp Model 945 and 965 plotters deliver accelerations of up to 4g, and diagonal plot speeds of up to 42-inches per second. Plus, they are typically 75% faster

in multiline widths and multicolor plots. That's because the competition uses a single-pen mechanism that has to stop to change line widths or colors, while we use a four-pen mechanism that changes pens on the fly.

Models 945 and 965 also offer the versatility to change pen types, scale,

rotate or mirror data, and display plot size and plot time.

So get the simple facts on the CalComp Model 945 (D-sized) and 965 (E-sized) plotters. Call or write: CalComp, 2411 West La Palma Ave., P.O. Box 3250, Anaheim, CA 92803. In continental U.S., except California, call (800) 556-1234, ext. 156. In California call (800) 441-2345, ext. 156.

CALCOMP

A Sanders Graphics Company



SANDERS

SOURCE DATA

tonian Hotel & Club, Houston, Texas, Dec. 15 to 17. The conference is sponsored by the Society for Information Management and The Institute of Management Sciences, in cooperation with the Association for Computing Machinery. The sessions will cover such topics as natural language query, software development, end-user computing, decision support design, management of the information system organization, system implementation and integration, evolution of the information system organization, federal systems and policies, and the user environment: contacts and impacts. For more information, contact Maryam Alavi or Richard W. Scamell, Department of Systems and Strategy, College of Business Administration, University of Houston, Houston, TX 77004, (713) 749-3727.

OFFICE GET-TOGETHER

"Integrating the Digital Office" is a four-day seminar offered by The International Communications Association (ICA). Targeted to managers responsible for office automation planning and research, the seminar will include a comprehensive review of state-of-the-art office technology, an examination of the regulatory environment, and the trends in communications technology. It will be held Jan. 15 to 18, 1984 at the Marriott Hotel, Fort Lauderdale, Fla. For more information, contact Reginald R. Bernard, Interim Seminar Committee, ICA, One State Farm Plaza, Bloomington, IL 61701, (309) 766-2666.

TIME IS ON YOUR SIDE

The Associated Management Institute Inc., is offering a seminar on "Effective Time Management." The Institute claims that in just one day you can increase your earning power for the rest of your life. It also promises to show you how to have the equivalent of two hours of sleep in ten minutes and how to use your peak times to your advan-

tage. Attendance at the seminar costs \$195; it is also available in a six-tape audio cassette learning program for \$95, plus \$4.50 for shipping. The program includes such topics as strategies for getting things done faster; how to accomplish more by doing less; how to get the important things done; and working smarter, not harder by using systems. The seminars will be held in various locations throughout the country in December and January. For scheduling and registration information, contact The Associated Management Institute Inc., 1160 Homestead Road, Santa Clara, CA 95050, (408) 971-8170.

OEMS ONLY

A series of one-day regional conferences, directed to oems, systems houses, and volume end users, will be held throughout Europe during February and March. The conferences will feature operating equipment displays as well as technical seminars. The first of the conferences is scheduled for Feb. 21 in Stockholm, Sweden, and moves to Paris on Feb. 23, Munich on Feb. 28, Frankfurt on March 1, and London March 7. Price per conference: \$1,850. For more information, contact B.J. Johnson & Associates Inc., 3151 Airway Ave., #C-2, Costa Mesa, CA 92626, (714) 957-0171.

EMBEDDED SYSTEMS

Integrated Computer Systems is offering a four-day course entitled "Designing Dedicated/Embedded Computer Systems." The course promises that participants will learn how to design reliable and fault-tolerant systems; make hardware/software/firmware tradeoffs; implement real-time and interrupt-driven controls; evaluate bus structures, protocols, and networking; use host/target software development tools; apply test and integration techniques; and develop packaging for environment stress threats. The courses cost \$895 and will be

held in Boston, Dec. 6 to 9; Palo Alto, Dec. 13 to 16; Washington, D.C., Jan. 24 to 27; Boston, Feb. 7 to 10; Los Angeles, Feb. 14 to 17; and back in Washington, D.C., March 27 to 30. For more information, contact Carolyn Yost, Integrated Computer Systems, 3304 Pico Blvd., P.O. Box 5339, Santa Monica, CA 90405, (213) 417-8888.

SECURITY SEMINAR

The Institute for Software Engineering is offering a two-day course on security management called the Security Management Forum. The course will include a practical methodology for security planning and control and will cover areas of vulnerability and potential risks associated with computer abuse. Speakers will detail specific measures for implementing physical security, software access controls, fraud detection, and prevention procedures. The institute recommends the course for security analysts, data processing managers and auditors, and corporate staff responsible for the security and integrity of information resources. It will be held Jan. 5 and 6 in Oakbrook, Ill., and costs \$695. If you're interested in attending, contact the Registrar, Institute for Software Engineering, 510 Oakmead Parkway, Sunnyvale, CA 94086, (408) 749-0133.

VENDOR LITERATURE

PLOT ON

Hewlett-Packard has published a 12-page application note on the meaning and measurement of drafting-plotter accuracy. The note is entitled "Plotter Accuracy—What It Means and How to Achieve It" (publication 5993-4163). It covers the definition and explanation of accuracy, and interprets the specifications and guidelines for accuracy. HEWLETT-PACKARD, Palo Alto, Calif.

FOR DATA CIRCLE 350 ON READER CARD

CAD/MICROGRAPHICS

3M is offering a new brochure that explains the role of micrographics in computer aided design. The eight-page brochure contains a brief overview of computer aided engineering and focuses on how the integration of micrographics and CAD simplifies the process of distributed engineering drawings. 3M, St. Paul, Minn.

FOR DATA CIRCLE 351 ON READER CARD

LOGIC GUIDE

Data I/O is offering a 32-page booklet on programmable logic explaining the subject and detailing its advantages over fixed-function LSI/MSI logic and custom logic. The booklet details an actual design problem, showing how design equations are generated and translated into fuse tables and how a PAL or IFL device is programmed and functionally tested. DATA I/O, Redmond, Wash.

FOR DATA CIRCLE 352 ON READER CARD

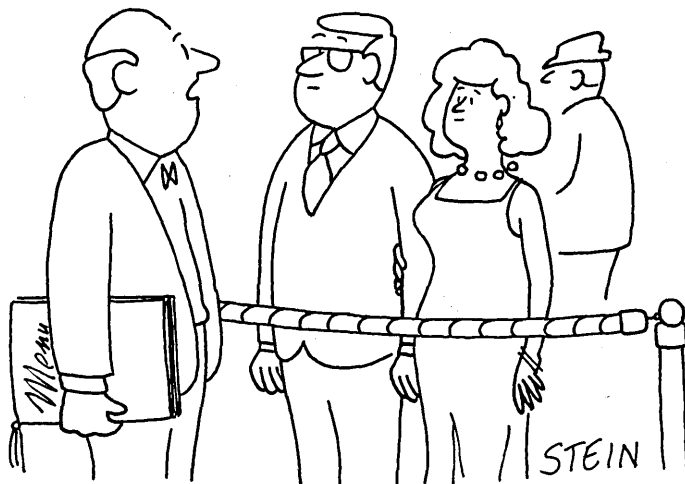

"Beeper or nonbeeper section?"

CARTOON BY ELI STEIN

TURNING YOUR PHONE SYSTEM INTO A LOCAL AREA NETWORK IS EASY AS 1, 2, 3

1

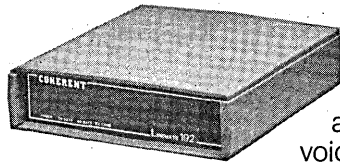

The Linemate™ 192 by Coherent. This is where it all starts. Simply install the Linemate module between your telephone and data terminal and your existing telephone line, and—voilà!—you've created a simultaneous voice and high-speed data network. One that handles full duplex, synchronous and asynchronous data at rates up to 19.2K bps, is completely transparent to normal telephone operation and will not degrade the quality of your voice channel. And Coherent's state-of-the-art filter technology prevents data from being corrupted or smeared.

2



Your Ordinary Two-Wire Cable Pair. The kind that—mirabile dictu!—you already have installed. So, there's no need for a special "data only" coaxial cable or an expensive PBX upgrade. The Linemate lets you add a terminal anywhere there's a telephone jack available. All it takes is a few, quick plug-in connections for you to have simultaneous voice and data on this single two-wire cable.

3

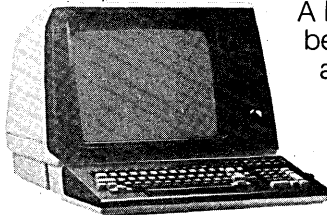

A Data Terminal. With Linemate, communication between this data or word processing terminal and your computer center or data base is easier than ever. Because all the wiring is already installed. And although your data will probably never have to travel this far, the Linemate 192 has a range of several miles. And it's available in stand-alone units or convenient card modules for rack mounting.

Linemate. It's the simplest way to turn your phone system into a Local Area Network without additional wiring. Strictly "plug-in" and go operation. And it's not expensive. To learn more about the Linemate, or any of Coherent's other voice and data products, call or write today for more information. Coherent Communications Systems Corp., 60 Commerce Drive, Hauppauge, NY 11788, (516) 231-1550, TELEX: 961439 (COHERENT CEIS)

COHERENT
COMMUNICATIONS SYSTEMS CORP.

CIRCLE 143 ON READER CARD

ADVERTISING OFFICES

Advertising Sales Manager:
William J. McGuire
 New York, NY 10022
 875 Third Ave.
 (212) 605-9715

Marketing Services Manager:
Kathleen A. Murray
 New York, NY 10022
 875 Third Ave.
 (212) 605-9723

Eastern District Managers:
Francie Bolger, John M. Gleason
 New York, NY 10022
 875 Third Ave.
 (212) 605-9400

New England District Managers:
Jack Orth, John M. Gleason
 Newton, MA 02159
 181 Wells Ave.
 (617) 964-3730

Mid-Atlantic District Manager:
Patricia Joseph
 Plymouth Meeting, PA 19462
 Plymouth Plaza, Suite 201
 (215) 825-4410

Southern District Manager:
Warren A. Tibbetts
 West Palm Beach, FL 33406
 7621 West Lake Dr., Lake Clark Shores
 (305) 964-6296

Midwest District Manager:
Joseph P. Gleason
 Chicago, IL 60601
 3 Illinois Center Building, 303 East Wacker Dr.
 (312) 938-2926

Western District Managers:
William M. Wilshire
 Irvine, CA 92715
 2061 Business Center Dr., Suite 111
 (714) 476-2511

Los Angeles, CA 90035
 1801 S. La. Cienega Blvd.
 (213) 559-5111

James E. Filiatrault, Janet Engelbrecht
 Mountain View, CA 94043
 2680 Bayshore Frontage Rd., Suite 401
 (415) 965-8222

U. K., Scandinavia, Benelux
Robert Saidel, Martin Sutcliffe
 Technical Publishing Co.
 130 Jermyn Street, London SW1 4UJ, England
 Tel: 01-839-3916, Telex: 914911

France, Spain
Vivian James
 Technical Publishing Co.
 47 rue Boissiere
 75116 Paris, France
 Tel: 010-33-1-704-8922,
 Telex: 610889 DONMAR F.

Germany, Austria, E. Europe
Robert S. Gibson
 Regional Manager, Technical Publishing
 6000 Frankfurt 60
 Scheidswaldrs 41, West Germany
 Tel: (611) 439625, Telex: 4170039TP

Italy
Luigi Rancati
 Milano San Felice Torre 7
 20090 Segrate, Milano, Italy
 Tel: 2-7531445
 Telex: 311010 PPMil Per Rancati 7531445

Switzerland
Andre Lehmann
 ALAS AG CH-6344
 Meierskappel/LU
 Tel: (042) 64-2350, Telex: 864958

Japan
Shigeru Kobayashi
 Japan Advertising Communications, Inc.
 New Ginza Building, 3-13 Ginza 7-chome
 Chuo-ku, Tokyo 104, Japan
 Tel: (03) 571-8784, Telex: J22745

Israel
 Daphna Str. 24, Tel-Aviv
 Tel: 268020, Telex 341667

John K. Abely, President
Robert L. Dickson, Exec. Vice President
John R. Emery, Senior Vice President
Walter M. Harrington, Vice-President/Finance
 and Administration

Technical Publishing

A company of
 The Dun & Bradstreet Corporation

The world's two leading project management systems

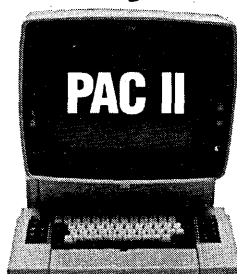
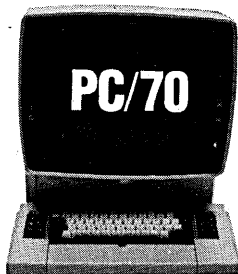

are brought to you by one company.

PC/70 and PAC II are the acknowledged leaders in automated project management systems. More than 2000 major companies and government agencies throughout the world use them to plan, budget, monitor, analyze, cost and manage a wide variety of projects.

Choose the system that best suits your requirements. Although they differ architecturally, both PC/70 and PAC II simulate, schedule, allocate resources, evaluate networks, develop float (or slack), provide target scheduling and fully support the project manager. Both standard and custom reports are available, along with color graphics options.

PAC II and PC/70 are part of a complete portfolio of project management tools

available only through AGS Management Systems, including methodologies, automated estimating, information systems planning, training and consulting services.

For more detailed information about PAC II or PC/70, or any of our other products or services, just call or write.

AGS Management Systems INC.

The world's leader in project management systems
 320 Walnut Street
 Philadelphia, PA 19106 **215/265-1550**

Formerly Atlantic Management Systems, Inc./ International Systems, Inc.

Fact:

Fighting heart disease and stroke is a life or death matter.

Your gift can make a difference.



American Heart Association

WE'RE FIGHTING FOR YOUR LIFE

CIRCLE 144 ON READER CARD

Plan now to attend

"The Computer Security Event of the Year"

the 11th Annual Computer Security Conference
November 12-14, 1984, Hyatt Regency O'Hare, Chicago

For the computer security practitioner, there's no better way to keep abreast of this critically important, fast-changing area.

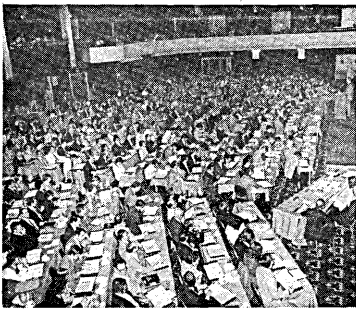

GENERAL SESSION PRESENTATIONS

Featuring expert and effective speakers who will share their expertise and experiences, describing the latest developments in their fields.



WORKSHOPS

The wide variety of offerings allows everyone to find special value in this conference. Each person will choose from these intensive, highly focused workshops led by experienced practitioners from across the U.S. and Canada.

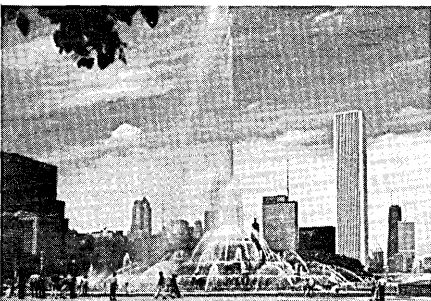

SPECIAL INTEREST SESSIONS

Conferees will meet in unstructured peer groups to exchange ideas, problems, and solutions.

OPTIONAL ONE-DAY SEMINARS

These seminars, presented before and after the regular Conference, offer you excellent opportunities to further increase your knowledge and understanding in specific areas of computer security.



NATIONAL COMPUTER SECURITY EXHIBITION

The only national trade show for the computer security industry, this exhibition gives participants the opportunity to learn about new products and services. Conferees can take advantage of an optional service—scheduled appointments with the exhibitors.



ECONOMY

In an effort to help you fight inflation, CSI has negotiated exceptionally low hotel rates for conferees. In addition, for the last two years CSI has been able to offer airfare discounts of 35 to 40% through the official Conference airline.

SPOUSES' PROGRAM

To make the conference enjoyable for your entire family, CSI sponsors this program of sightseeing, education, and fun.

COMPUTER SECURITY INSTITUTE

The Conference is sponsored by Computer Security Institute, the first full-service membership organization dedicated to helping computer security practitioners safeguard their organization's data processing assets. Members of Computer Security Institute receive the 500+ page *Computer Security Manual*, the bimonthly *Computer Security* newsletter, hotline telephone referrals, and special reduced rates for other CSI publications and for CSI-sponsored conferences and seminars. CSI publishes the semiannual *Computer Security Journal* and the *Computer Security Handbook*. Annual membership in Computer Security Institute is only \$85 (for U.S., Canada, Mexico addresses; all others \$115). For more information, send in the coupon or call (617) 845-5050.

Computer Security Institute
Dept. E83
43 Boston Post Road
Northborough, MA 01532
(617) 845-5050

FOR MORE INFORMATION...

- Please send me full details of the 11th Annual Computer Security Conference.
- Please send me information on how I can exhibit my company's products/services at the 1984 National Computer Security Exhibition.
- Please send me information about subscribing to *Computer Security Journal*, the first journal devoted solely to computer security.
- Please send me information about joining Computer Security Institute.

NAME _____
TITLE _____
ORGANIZATION _____
ADDRESS _____
MAIL STOP/FLOOR _____
CITY _____ STATE _____ ZIP _____
TELEPHONE () _____

VAX/VMS SOFTWARE

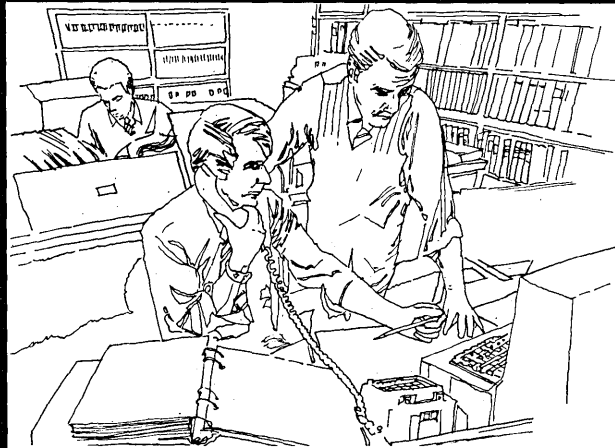

RESOURCE MANAGEMENT and CHARGEBACK SYSTEM

DP Managers use ARSAP for:

- User and Project Accounting
- Monitoring Usage and Trends
- Controlling Performance
- Billing for Services

Also Available for RSTS and RSX Systems



P.O. Box 188
Riverdale, MD 20737 (301) 864-3700
VAX, RSX, and RSTS are trademarks of the Digital Equipment Corp.

CIRCLE 146 ON READERCARD

TALISMAN T.M.

It's almost magic!

CP/M™ Terminal Translation
& Multiple Keyboard Redefinition Program

- ★ Run any CP/M 2.2 software on any other CP/M 2.2 microcomputer with proper disk format.
- ★ Used with a communications package will convert your microcomputer into any other interactive micro, mini or mainframe terminal.
- ★ Redefines any key(s) to reproduce any phrase or command sequence.
- ★ Reprograms "on the fly" while you're running another program.
- ★ Creates, saves, edits and retrieves up to 255 keyboard overlays.
- ★ Much, much more.



DISCO-TECH®
P.O. Box 1659
Santa Rosa, CA 95402
Tel. 707/523-1600

Dealer inquiries invited.

CIRCLE 147 ON READERCARD

ADVERTISERS' INDEX

ADC.....	183
**Advanced Matrix Technology.....	247-14,247-15
AGS Management.....	292
*Allinson-Ross.....	246-5
Ampex.....	257,304
*ANT Nachrichtentechnik.....	246-25
Apollo.....	270,271
Arc Associates.....	248
Artificial Intelligence.....	192
Ashton Tate.....	95,247A
AST Research.....	141
AT&T Info Systems.....	164,165
BASF.....	265
*BASF AG.....	246-13
BBN Communications.....	84,85
Beehive.....	135
*Beehive International.....	246-10
*Bell Manufacturing.....	246-7,246-27
Braegen.....	137
CalComp.....	289
**Callan Data.....	247-16
Cambridge Systems.....	210,211
Candle.....	2
CGA.....	287
**CIE Terminals.....	247-2
Cincom.....	284,285
Codex.....	156,157
Coherent Communications.....	291
COMPAQ Computer.....	6,7
Complex Systems.....	57,87
Computer Associates.....	109
Computer Automation.....	83
Computer Corp. of America.....	81
Comserv.....	172,173
Comsite.....	312
Concord Data.....	227
Control Data.....	259
Corona Data.....	239
Corvus.....	269
Cullinet.....	283
CXC.....	111
*Cynthia Peripheral.....	246-34,246-35
Data General.....	204,205
Datapoint.....	107
Dataproducts.....	19
Dataram.....	231
Data Set Cable.....	248
D & B Computing Services.....	280
DCA.....	303
DEC.....	44,45
Decision Data.....	9
Digital Pathways.....	59
Digital Research.....	254,255
**Dilog.....	247-5
Direct, Inc.....	126,127
Disco Tech.....	292
Dylakor.....	230
Dysan.....	43
Elgar.....	115
EMC.....	82
Emulex.....	168,169
Envision.....	60,61
EPS.....	237
*Ericsson/Bollmora.....	246-2
*Falco Data.....	*56
Formaster.....	151
GE/GENICOM.....	207
GEJAC.....	294,312
General Automation.....	27
Group Operations.....	175
GTE Strategic Systems.....	234
GTE Telenet.....	159
Hal Communications.....	314
Hewlett-Packard.....	224,225
Holland Systems.....	155
**Home Federal.....	247-20
Honeywell Info Systems.....	10,11,102,103
Hughes.....	229
IBM.....	16,17,132,133,195,247-9
ICL.....	112,113
Infodata.....	266
Information Builders.....	218
Inmac.....	26
Innovation Data.....	299
Intecolor.....	219,247-23
**Intel DBO.....	247-18,247-19

International Market Center	74
IPF	161
ISE-USA	245
ISSCO	76,77
C. Itoh	15,203
ITT Courier	78,79,273
ITT Worldcom	262,263
Johnson Systems	277
Kennedy	Cover 2
Krueger	86
Lear Siegler	144,145
Lee Data	75
Liebert	54,55
Lotus	201
Lynch	247D
M/A-COM-Linkabit	222,223
Masstor Systems	72
Mathematica	49,246-17-246-20
Matrix	258
Matsushita - Panasonic Div.	146
McCormack & Dodge	101
Memorex	123
Micom	1,28
*Micro Five	246-14
Micro Focus	181
MSA (Management Science America).....	58,176,177
NCR	62,98
**Newbury Data	246-13
Northern Telecom	33-40,149,184,185,241B,241C
*Northern Telecom	246-8,246-9
Olivetti	189,246-28
On-Line Software	64,243
**Onyx	247-10
**Oregon Software	247-7
Pansophic	261
Paradyne	25
Persyst	119
Phaze	Cover 3
*Phillips T&M	246-21
Pixel	70
Precision Visuals	53
Prime Computer	274,275
Printronix	22
Racal/Vadic	305
Recognition Concepts	129
Roim	89-94
Rusco	190,191
SAS	5
Saudi Research	150
*Savant	246-31
*Siemens	246-22,246-23
Softech Microsystems	167
Software House	246
Software International	12
*Software News	246-30
Softworks Inc.	26
Southern Systems	197
Sperry	120,121
SPSS	223
STC Systems	143
Sterling Software	209
Stratus Computer	253
SWIG	313
Tandberg Data	125
**Tekelec	246-24
Teletype	Cover 4
Televideo Systems	198,199
Teltone	52
Texas Instruments	138,139
Three M	163,288
Time, Inc.	308
Timeplex	68
Tower Systems	130
TRW	279
UCC	306,307
Ungermann-Bass	20,21
United Info Services	216,217
US Postal Service	171
Ven-Tel	56
VM Software	8
Wandel & Golterman	51
Wang	215
Western Electric	63,65,67,69,71,73
J. Wiley	238
*Wollongong Group	*49,246-33
Xerox X&SIS	250
Zilog	96,97
*International edition	**OEM Edition

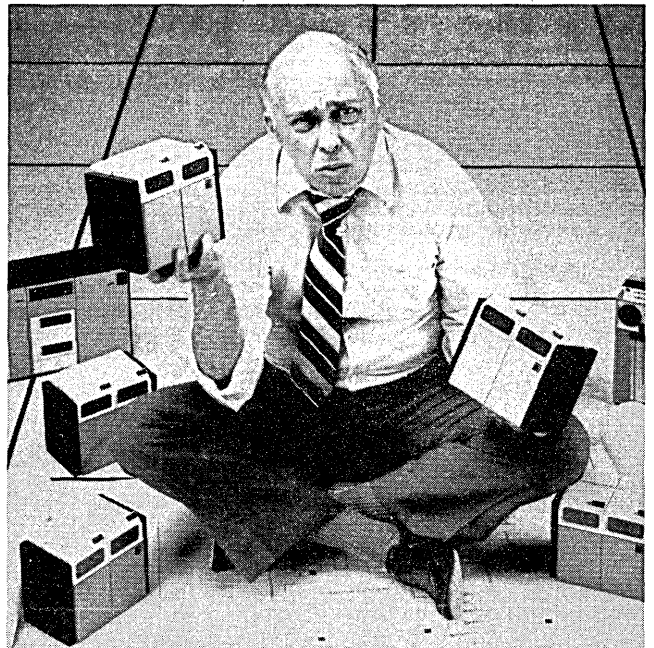

Are you managing your hardware or is your hardware managing you?

**Use ABR[™]
Archive and Superscratch**

Automatic archiving of data sets. ABR, performing the ARCHIVE function, will backup, scratch, and uncatlog any data set that has not been referenced for a user-determined time period. Users can also request archiving of their data sets by control statements or remote queue. ABR will record these data sets in the ARCHIVE control file. Inactive data sets can be archived, freeing the disk space for more productive use.

**FDR[™]
Automatic Backup & Recovery**

*...The Fastest
DASD Management System*

**Available for IBM OS/VS & MVS
90 Day Free Trial**



970 Clifton Ave., Clifton, NJ 07013 • 201-777-1940

CIRCLE 148 ON READERCARD

The Marketplace

... SOFTWARE SERVICES

ADVERTISERS' INDEX

SOFTWARE SERVICES

Amcor Computer Corp.300
Applied Information Systems300

Business Model Systems Inc.301

DASD301
Dataware, Inc.300
Dataware, Inc.300
Dataware, Inc.300
Duquesne Systems Inc.301

Manufacturing EDP Consulting, Inc.301
Mitchell & Gauthier Associates, Inc.300

S-Cubed Business Systems300

PERSONAL COMPUTING

Micro Management Systems302

JOB MARKETPLACE

Wallach Associates, Inc302

BUY, SELL, LEASE

Thomas Business Systems, Inc.302

ACSL

The Advanced Continuous Simulation Language is a powerful but easy to use program designed for modelling the behavior of dynamic systems. Applications range from control system analysis to chemical plant models to urban dynamics.

- Interactive or Batch Graphics
- Unlimited Problem Size
- FORTRAN Compatibility
- Stiff Integration

ACSL reduces program development time by factors of two to ten: ACSL is available for CDC 6000/7000, IBM 360/370, UNIVAC 1100, SEL 32, PDP 10/20, VAX II, PRIME 50 and HARRIS computers. Access through BCS, CYBERNET and other national networks.

MITCHELL AND
 GAUTHIER ASSOCIATES, INC.
 P.O. Box 685, Concord, Ma. 01742
 (617) 369-5115

CIRCLE 500 ON READER CARD

DEC

AMBASE® a complete application development tool and DBMS. Increasing the productivity of programming staffs worldwide from 100%-900%.

RSTS

• DATA BASE MANAGEMENT SYSTEM

VAX

• REPORT GENERATOR

• QUERY LANGUAGE

• SCREEN FORMAT GENERATOR

DBMS

• AUTOMATIC CODE GENERATOR

• USER FRIENDLY REPORT WRITER

SOFTWARE

DEC GOLD STAR RATED ICP MILLION DOLLAR AWARDED

amcor computer corp. ®

an APC Automation Group Company
 1900 Plantside Dr., Louisville, KY 40299 • (502) 491-9820
 "Regional Offices Nationwide"



CIRCLE 501 ON READER CARD

The Effective Solution for DETAILED JOB COSTING

J.A.M.I.S.

(Job Cost & Management Information System)
 Integrates:

- Job Cost
- Payroll
- Accounts Receivable
- Accounts Payable/
Purchase Orders
- General Ledger
- Inventory/Order Entry
- Fixed Assets



S-Cubed Business Systems
 Box 1620, La Jolla, CA 92038
 PH. (619) 755-7237; 453-0060

CIRCLE 502 ON READER CARD

PDP-11 & VAX Software

EasyEntry
 Quick form design
 and data entry system

AIS-PL/I
 ANSI Subset G
 PL/I Compiler

BURCOM-11
 PDP-11/Burroughs
 Communications System

1-800-334-5510

applied information systems

500 Eastowne, #207
 Chapel Hill, NC 27514
 (919) 942-7801

CIRCLE 503 ON READER CARD

COBOL to COBOL

One of the many successful Translators offered by Dataware is our COBOL Converter, a table-driven conversion system designed to convert COBOL programs from one vendor or operating system to another.

This convertor plus our other conversion tools meet the needs of a changing computer industry.

Our conversion approach provides the major solution to management's conversion problems and facilitates the recovery of the initial capital investment in systems development.

For more information, call or write today.

The Conversion Software People
Dataware, Inc.

2565 Elmwood Avenue
 Buffalo, New York 14217
 (716) 876-8722 • TELEX: 91519



CIRCLE 504 ON READER CARD

AUTOCODER/SPS to COBOL

Dataware's software translator automatically converts a high percentage of SPS/1400 Autocoder source code to ANS COBOL (DOS or OS).

The Translator converts from:

- IBM 1401
 - IBM 1401 SPS
 - IBM 1440
 - IBM 1410
 - IBM 7010
- can be mixed in a single source program.

For more information, call or write today.

The Conversion Software People
Dataware, Inc.

2565 Elmwood Avenue
 Buffalo, New York 14217
 (716) 876-8722 • TELEX: 91519



CIRCLE 505 ON READER CARD

Dataware Software Translators

RPG to COBOL

Converts RPG and RPG II programs to the industry standard ANS COBOL (DOS or OS). The translator achieves an extremely high percentage of automatic conversion (approaching 100%) of the source code.

RPG to PL/1

Converts RPG and RPG II programs to an optimized PL/1 (DOS or OS). The translator achieves an extremely high percentage of automatic conversion (approaching 100%) of the source code.

For more information, call or write today.

The Conversion Software People
Dataware, Inc.

2565 Elmwood Avenue
 Buffalo, New York 14217
 (716) 876-8722 • TELEX: 91519



CIRCLE 506 ON READER CARD

DO BUSINESS WITH A FRIEND...

BUSINESS MODELER is the friendly financial modeling system.

BUSINESS MODELER combines the capabilities of simple spreadsheet packages and complex modeling systems in a unique software system which allows users at all levels of sophistication to perform "what if" analysis, explore changing business factors, or manage day-to-day operations. Now, for the cost of a secretary for a half year, you can get the sound information you need to run your business better.

BUSINESS MODELER runs on most minicomputers and mainframes. BMS sells and supports the system throughout the world. Call to see the system run on your computer today.

800-426-7462



BUSINESS MODEL SYSTEMS INC.
2625 Butterfield Road
Oak Brook, IL 60521
312-789-9160

CIRCLE 507 ON READER CARD

IBM S/34/36/38 COBOL

- General Ledger
- Accounts Receivable
- Accounts Payable
- Payroll/Personnel
- Inventory Management
- Manufacturing Systems

"The finest accounting software available with features usually found only in large main frame packages..." W. Kowal, Controller, Fedders Corporation



P.O. BOX 54, BUFFALO, N.Y. 14213
716 - 885 - 1772

• MFG/EDP IS AN IBM APPROVED MARKETING ASSISTANCE PROGRAM COMPANY •

CIRCLE 508 ON READER CARD

PERFORMANCE MANAGERS AND ANALYSTS...

You've tried solving your performance problems with hardware monitors, sampling software monitors, unsatisfactory billing systems, SMF and RMF inadequacies, simulators... Now, try the premier product in the industry! QCM. QCM is the only complete system that precisely monitors ALL hardware and software processes, accurately bills ALL operations and IMPROVES performance... ALL on a full-time basis. Let us show you how QCM has meant control, efficiency, confidence and dollars to our customers.



DUQUESNE SYSTEMS INC

TWO ALLEGHENY CTR.
PITTSBURGH, PA 15212
PHONE 412-323-2600
TELEX 902 803

CIRCLE 509 ON READER CARD

Conversions. On Time. Within Budget. Call 800-558-5148*

DASD's proven software lets you keep the conversion process under complete control.

- COBOL to COBOL
Circle No. 510
- NEAT/3 to COBOL
Circle No. 511
- RPG/RPG II to COBOL
Circle No. 512
- FORTRAN to FORTRAN
Circle No. 513
- DOS ALC to OS ALC
Circle No. 514
- COBOL ISAM to COBOL VSAM
Circle No. 516
- DIBOL to COBOL
Circle No. 517
- Universal File Translator
Circle No. 518
- File Compare Utility
Circle No. 519
- CCP to CICS
Circle No. 520
- Plus FREE "Conversion With No Surprises" brochure.
Circle No. 515



DASD

PEOPLE/PRODUCTS/RESULTS
DASD Corporation • Corporate Services Center
9045 North Deerwood Drive • Milwaukee, WI 53223 • 414-355-3405

Member of the Cap Gemini Sogeti group

*In Wisconsin, call 414-355-3405, collect.

PERSONAL COMPUTING

It's simple. . . .
CALL & SAVE MONEY
1-800-841-0860

Commodore 64
DRIVES • PRINTERS
MONITORS • SOFTWARE
CALL FOR BEST PRICES

TRS-80 FRANKLIN
EAGLE EPSON
Albert **IBM SMITH**

MICRO MANAGEMENT SYSTEMS
 TELEMARKET DEPT. # 17
 2803 THOMASVILLE RD. EAST
 CAIRO, GEORGIA 31728
 GA. & INFO 912-377-7120.

CIRCLE 521 ON READERCARD

JOB MARKETPLACE

**LET US PLACE YOU
 IN A
 BETTER JOB NOW**

Put our 20 years experience placing technical professionals to work for you. Client companies pay all fees; you get our expert advice and counsel FREE. Nationwide opportunities in Communications, Defense, Intelligence, Computer, Energy and Aerospace Systems. If you earn over \$25,000, we have a better, more rewarding job for you . . . right now. Send your resume in confidence to: Dept. DM-B

WALLACH
 associates, inc.

Washington Science Center
 6101 Executive Boulevard, Box 6016
 Rockville, Maryland 20852

Technical and Executive Search
 Wallach . . . Your Career Connection

CIRCLE 524 ON READERCARD

BUY, SELL, LEASE

The U.S. market - a call away!

DE/DG

SYSTEMS / PARTS / PERIPHERALS
NEW / USED / SURPLUS at DISCOUNT PRICES

Since 1977! Buy, Sell, Trade and Broker.

PHIL BRYAN JENNIFER
 DG 11-VAX 8-LSI TELEX 568-670
CALL TODAY - (305) 392-2005

thomas business systems, inc.

© 4301 Oak Circle - Unit 11 Boca Raton, Florida 33431

CIRCLE 525 ON READERCARD

"Instruct a wise man and he will be wiser still."

Proverbs 9:9

Wise choices of the elements for computer integrated operations in manufacturing systems can attain major improvements in productivity. But where can you get the information to make those choices?

The InfoResearch Institute has prepared a pair of reports to guide you through the needs analysis, evaluation, selection and implementation processes — alternatives and strategic solutions that address your problems. Both are derived from extensive analysis of user and supplier experiences.

Order your reports today — call 612/835-0448.
 Or write us to receive a free descriptive brochure.

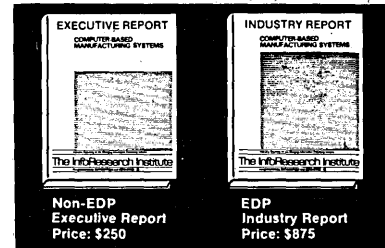

The InfoResearch Institute
 c/o Info-Dyne, Inc. • 7417 Bush Lake Rd.
 Minneapolis, MN 55435

The InfoResearch Institute

co-sponsored by DATAMATION and INFO-DYNE

CIRCLE 522 ON READERCARD

"But knowledge is easy to him who has understanding."

Proverbs 14:6

Understanding the elements and issues associated with Financial Planning and Modeling Software and effectively installing and using computer-based systems significantly improves your ability to compete in a rapidly changing business environment.

The InfoResearch Institute has prepared a pair of strategic reports that deal with the benefits, alternatives and problems associated with financial analysis modeling and business planning. And all information is based on extensive studies of user and supplier experiences.

Order your reports today — call 612/835-0448.
 Or write us to receive a free descriptive brochure.

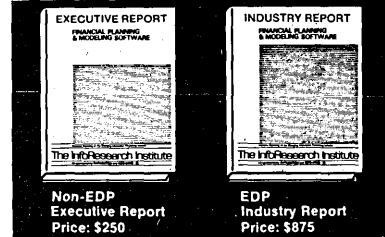

The InfoResearch Institute
 c/o Info-Dyne, Inc. • 7417 Bush Lake Rd.
 Minneapolis, MN 55435

The InfoResearch Institute

co-sponsored by DATAMATION and INFO-DYNE

CIRCLE 523 ON READERCARD

"A little space."

— WILLIAM BLAKE
Songs of Innocence

"At little cost."

— KATHY MONAGHAN

Call me or Shirley Stirling for more details about the DATAMATION Marketplace at **(800) 223-0743.**

AT 1,544,000 BPS, OUR NEW T-1 MEGALINK WILL BLOW YOU AWAY.

You'll be amazed at what our new time-division multiplexor can do.

It supports combined data and digitalized toll-quality voice communications over a transmission link at a maximum of 1.544 or 2.04 mbps.

It provides a cost-effective backbone for local area networks and regional concentration links for higher speed networks. With trunk speeds from 50 to 2,048,000 bps. And channel speeds from 50 to 256,000 bps.

And since its design is based on Integrated Network Architecture, it is low-cost, expandable and compatible with all DCA components.

The new DCA T-1 Megalink. Flexible, efficient, advanced. And fast. For more information, call us toll-free: 1-800-241-5793. Or write: DCA, 303 Research Drive, Norcross, Georgia 30092.

And hang on to your hat.

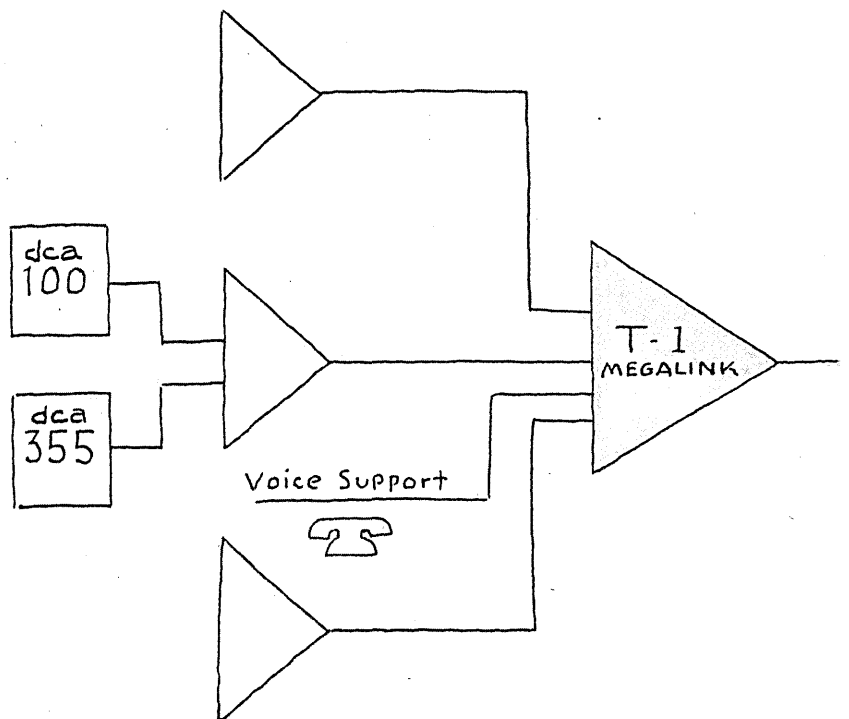

dca[®]

Digital Communications Associates, Inc.
DCA Products Are Available Worldwide.
CIRCLE 149 ON READER CARD

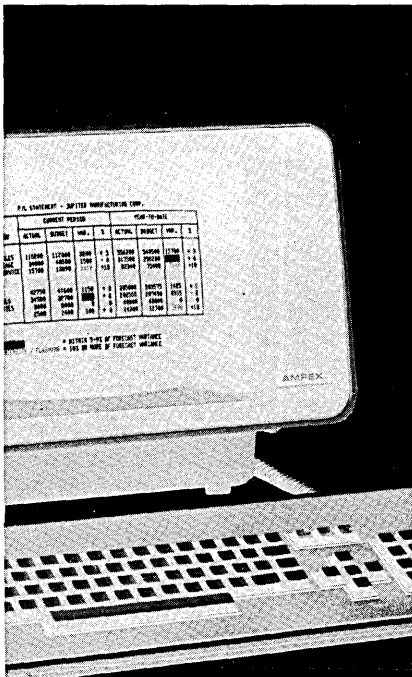

Twenty Terminals In One.

Ampex Emulation Plus terminals do more than emulate twenty popular models of DEC, ADDS, Hazeltine, Lear Siegler, Soroc and Televideo. They give you more features, including menu-driven setup, non-volatile programmable function keys, four-function printer port, and amber as standard along with green and white at no extra cost.

Call 213-416-1575
Ampex Corporation,
Computer Products
Division, 200 North
Nash St., El Segundo,
California 90245.

AMPEX
COMPUTER PRODUCTS DIVISION

Ampex Corporation • One of The Signal Companies

CIRCLE 150 ON READER CARD

Employment Scene

ON THE JOB

SPRECHEN SIE DP?

The shortage of qualified people for high-technology jobs is nothing new to this country. Compounding the problem is salary competition within the field, forcing universities out of the bidding for potential teachers. And if there aren't enough teachers . . . well, it's a vicious cycle.

During 1981-1982, starting salary for an assistant professor with a master's degree or PhD in engineering was \$21,000. The going rate in the private sector for a similarly degreed person was \$25,000. To resolve such inequities, groups like the American Electronics Association (AEA) are rounding up funds from their member companies and individual firms to provide stipends and loans for graduate students who choose careers in academia. Some companies are even lending out personnel to major universities and opening their labs to faculty and grad students.

Another tactic for filling the trained personnel gap is becoming more and more popular: recruitment of dp professionals from overseas. In Great Britain, for example, there is a formidable supply of dp professionals because of the country's economic conditions and training traditions. Many of these people are under 30 years old and many have approximately 10 years of dp experience. The scarcity of job openings at home is not the only reason these people are drawn to the U.S. Salary also plays an important role. For instance, a bachelor's degree and eight years of mechanical engineering experience is worth about \$19,000 in the U.K., while it can command twice that in the States.

It's not always necessary to search overseas for these professionals; they often are right here in our own backyards as exchange students. Current immigration laws allow these students to apply for permanent or temporary work visas immediately upon graduation.

The boom in hiring foreign nationals has also spurred the growth of a specialized legal professional—the immigration lawyer. These lawyers know how to cut through the red tape and expedite the processing of a work visa. What it comes down to is knowing exactly how to format these applications for the best possible chance of issuance. Knowing which immigration office processes applications faster also helps.

Foreign workers are permitted to work in the U.S. under two types of temporary visas. The H-1 visa allows persons of distinguished merit and ability to perform services of an exceptional nature. The H-2 visa is for skilled and unskilled labor in short supply. H-1 is a lot easier to obtain.

Firms like that of Richard Fraade, Beverly Hills, Calif., claim they can deliver a foreign worker in as little as three days, legally. Fraade is a specialist in immigration and naturalization law. For a fee of between \$1,000 and \$1,500, his firm will prepare the forms and information for a temporary work visa. A permanent visa can cost between \$3,000 and \$5,000. Whether the Immigration and Naturalization Service actually issues the visa is another story. But companies seem to think their money is well spent if they hire a professional to do the legwork.

With all this scrambling to fill jobs, trade associations like the Institute for Electrical & Electronics Engineers maintain the shortage has been propagated by the employers. The feeling here is that employers discourage U.S. engineers from taking jobs by lowering pay scales and then claiming shortages so they can hire foreign workers for less money. On the other hand, employer groups like the AEA feel that salaries are artificially high because of the short supply of help. So far, both allegations remain unproven.

—Lauren D'Attilo

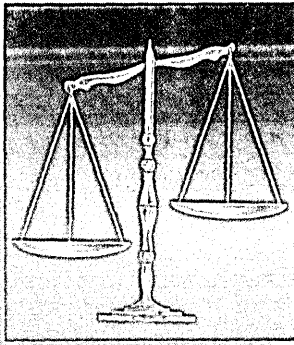

All 2400 bps Full-Duplex Modems Are Not Created Equal.



With Our Quad Modem, You Don't End Up Just Talking to Yourself.

A Modem For All Reasons

Competitive 2400 bps full-duplex modems can only talk to similar modems — or fall back to a 212A mode. With Racal-Vadic's new Quad VA4400, you can talk to *any* low or medium speed modem because we designed four different full-duplex modems to fit in one small package:

1. 2400 bps full-duplex
2. 1200 bps full-duplex (Racal-Vadic VA3400 mode)
3. 1200 bps full-duplex (Bell 212A mode)
4. 0 to 300 bps full-duplex (Bell 103 mode)

First Quadruple Modem

Two Racal-Vadic innovations have made the quadruple modem possible. First: Automatic Adaptive Equalization which allows the modem's receiver to change filtering under varying telephone line conditions. Second: A built-in general-purpose

16-bit microprocessor to perform the analog signal-processing functions for all four modems.

Multiline Automatic Dialing

The VA4400 can be used with our Multiline Automatic Calling System (MACS), which enables a single RS-366 or RS-232C computer port to control dialing for up to 28 of these versatile modems. A *great* savings in hardware.

Remote Or Computer-Site Packaging

For computer sites, eight quad modems can be housed in our VA1681 rack-mount chassis. For remote terminal use, a single VA4400

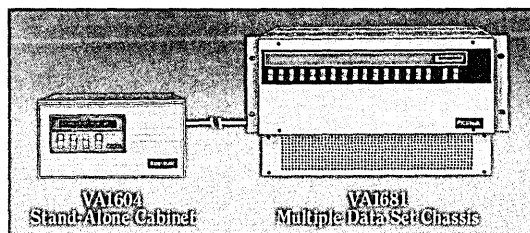

is available in a compact, desk-top cabinet.

All 2400 bps full-duplex modems are certainly *not* created equal. Let the VA4400 prove it to you. We're not just talking to ourselves. Write or phone today for full details.

Phone 800-543-3000,
Operator 507.

Racal-Vadic

Member IDCMA

RACAL

1525 McCarthy Boulevard, Milpitas, CA 95035
Tel: (408) 946-2227 • TWX: 910-339-9297

CIRCLE 151 ON READER CARD

*The automation of the Data Center.
How far will it go?*

One thing's for certain. It hasn't gone far enough ... yet!

Like the cobbler's children, most DP Departments are going barefoot when it comes to management systems and data. They deny themselves the benefit of their own product: automation

Now, the DP Manager is confronted with the same

problems he has helped other managers solve: How to manage growth and increase productivity?

There is one company with the software — and the expertise — to help the DP Manager solve that problem. UCC.

Our Data Center Management software can help you deal with virtually every management problem en-

countered within a large data center. It's an approach to automated management that is so complete it benefits your entire Company — as well as your data processing organization.

After all, Data Processing is automated ... isn't it about time the Data Center was too?

Call 800-527-5012
(in Texas 214-353-7312.)





THE MOST COMPLETE
SOFTWARE COMPANY
IN THE WORLD.

CIRCLE 152 ON READER CARD

University Computing Company • Dallas • Toronto • London • Paris • Düsseldorf

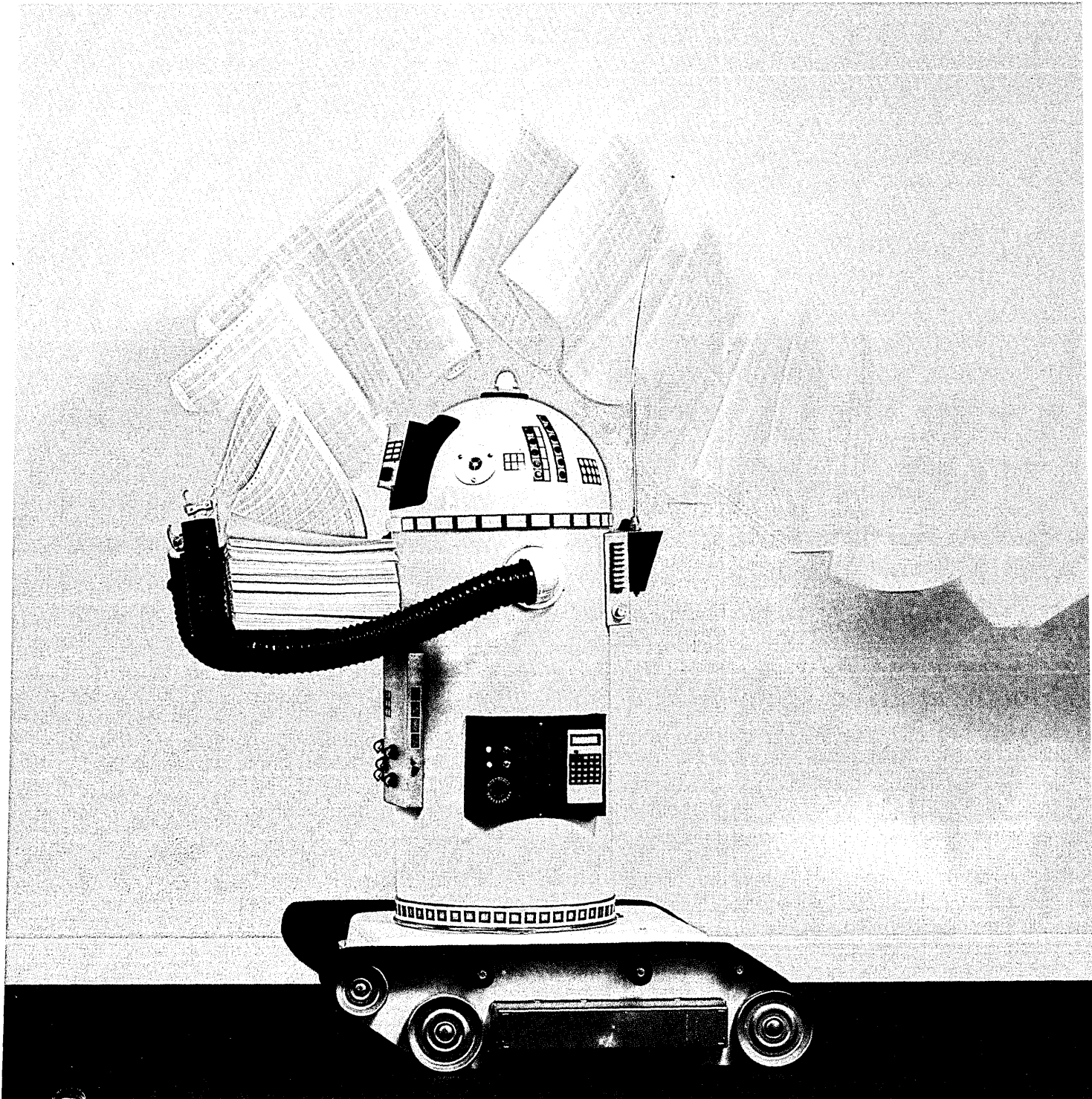

TIME



Comes the revolution.

The people most likely to be in the forefront are the ones most receptive to change. And change is precisely what attracts 30 million men and women to TIME.

Even though you may reach plenty of decision makers through traditional business media, you'll reach a powerful concentration of *forward thinkers* when you advertise in TIME.

TIME Magazine is all about change and the people who make it happen—in business and in technology.

Seventy-six per cent of TIME's

subscribers are professionals or managers, the heart and brains of your market—the people on whom the buying decision rests.

They're smart, knowledgeable, and wide open to new ideas—for instance, they own a dramatically high proportion of all home computers sold. They are not only ready to hear what your business equipment can do for them, they are also

qualified to act upon the knowledge.

To learn how effective TIME has been for other business equipment advertisers, call John J. Crowley, Jr., at (212) 841-2518. He'll show you why *today's market is TIME's market.*

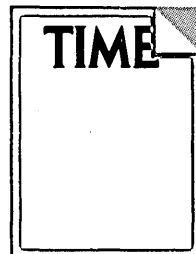

Get more out of it.

READERS' FORUM

WHEN LIGHTNING STRIKES

Early in my dp career, my role within the corporate structure was put into perspective. I was working at a plant, writing COBOL programs for personnel and accounting applications, and riding to and from work with three production engineers. One day, a series of severe thunderstorms hit the plant. When I got in the car to go home after work, I was foolish enough to say, "Man! That was some storm! Lightning hit our building and the printer was down for two hours!" All at once, the engineers' six hairy eyeballs turned toward me and one of my fellow riders said, "It hit our unit, and took an extruder down for two hours. We lost \$2 million worth of product."

The lesson was clear to me. Losing a computer peripheral was an inconvenience, but did not carry the same price tag as losing a critical production unit. Even today, when more corporations realize the value of information, we dpers should understand that the company doesn't derive revenue from our activities; our work supports the people who produce and sell the company's goods and services. Therefore, whenever business needs demand it, we should be ready to give extra attention and effort to support them. This principle is so obvious that you'd think it was universally accepted. You'd be surprised.

Several years after that thunderstorm, I find myself working at the corporate headquarters—a place teeming with three-piece suits, Ivy League mumbo jumbo, and people who think the company's business is issuing forecasts and running computers. My job is to coordinate the activities necessary to put terminal users in business. I get them their terminals, modems, and phone lines; make sure somebody installs their equipment; and let the folks in 3705-land know the user is out there ready to send data.

Obviously, we have to deal with a lot of activities, vendors, and company people from other departments. Under these conditions, what do you think our biggest roadblock is? The phone companies? The equipment vendors? Neither. The biggest hurdle that we have to overcome is our own MVS support group that defines the terminal configurations.

We all realize that MVS is no simple matter; you can't just plug it in and run it. But I'm learning that it's more complicated than I had ever imagined. If we want to set somebody up on the

network, we have to gear up for the once a month "gen" that takes place on the first working day of the month. To make sure everything is okay, we have to submit changes by the 20th of the month. If someone comes in with a request on the 21st, too bad; they wait until next month. If someone in my outfit makes a transposition error, again, too bad; they have to wait another month. If your luck is bad enough, you might have to wait 45 or even 60 days to use your terminal.

Now, if you work at a plant, and a vital pump or compressor breaks down, people get cracking. If a new part is needed, you get on the phone, you work overtime, you follow up, you sweat, and you get the job done. In this can-do environment, no one wants to hear that you can't use a computer device because it hasn't been "defined to the network."

Of course, an inoperative terminal doesn't shut down a plant like a pump or a compressor can. But suppose you're a production supervisor, and you get short notice that you have to take on more work, train more people, and, by the way, get a second terminal to transmit production data. You do your part, and then some computer jock at headquarters tells you that you can't use your terminal because it's not time to do software definitions yet. Is that going to make any sense to you? Is it going to make any sense to your boss?

There are times when the needs of the business transcend billing cycles, operating procedures, and any other corporate tribal rituals. Service organizations sometimes have to suspend rules and provide the service that is expected, immediately.

Most areas of business recognize a cardinal principle: an organization's reputation and success are established by a helpful attitude and a willingness to do favors for customers and clients. This principle is recognized by hot dog stands and multinational corporations; it is recognized by sales, production, and maintenance organizations. Only dp ignores the principle, remains inflexible, and creates ill will between itself and its customers.

Computer systems in our company are rated by their "clerks in eyeshades" (CIE) index. This is a measure of how many CIE equivalents were laid off upon system implementation. In our area, there are many former CIEs, so it seems that our computer systems have been successful. But when you peek behind the silicon curtain, you see the hundreds of other people needed to keep the MVS area going. If they are all as unresponsive as the groups I interface with, I'd say it's time to get more skeptical, and start to de-mythologize the whole IBM-SNA-MVS scene.

—Jerry Becan
Wilmington, Delaware

MERGE AHEAD

Information has become a corporation's greatest resource and access to that information is essential. Data processing professionals will continue to use interactive terminals for corporate information processing needs. But, as database access becomes crucial to all corporate management, non-dp professionals hesitate to rely solely on the dp department for retrieving their data.

Microcomputers have earned a place in the corporate office by offering local and host-related dp capabilities to all professionals. As personal computers gain popularity, the need to access corporate data will increase in complexity and scope.

Both personal computer and terminal systems suppliers have reacted to user demand by offering communication capabilities, typically, 3270 for the personal computer, and personal computer attachments, which use existing mainframe communication links, for terminal systems.

These two alternatives lead us to question whether one data processing vehicle will eventually dominate the other.

As information processing needs increase, personal computer functions must merge with the job-specific orientation and communication capabilities of terminal systems. Through this combination, the best of micro technology will coexist with the best of terminal system technology, thereby creating a new generation of intelligent workstations.

Tomorrow's workstation will emulate a 3270 terminal, an ASCII display, a personal computer, a small business computer, and a word processor. The future terminal system will be a family of workstations, each with compatible communications and processing capabilities, but each performing a specific function.

For example, some future workstations will feature multiple screen sizes, up to 132 columns, to provide greater application flexibility for data entry, inquiry, and program development. Many will be better suited for word processing because they will have high-resolution portrait crts combined with standalone quality word processing software, while others will be specifically suited to financial planning, analysis, and graphics applications through job-specific hardware and software combinations. Users will be able to choose which feature best corresponds to their particular job.

The greatest attribute of future workstations will be their standardization. Universal terminals will serve every application and configuration need, perform each function efficiently, be incorporated into existing structures, and remain a cost-effective solution to purchasing multiple systems.

Included in this standardization will be the ability to operate in various communication environments, such as BSC, SNA/SDLC, and Async. Clustered local and remote control units with single and dual ports that support multidevice complements will access a variety of cpus and timesharing devices.

In terms of local processing capabilities, the universal workstation will feature a high-performance microprocessor, both floppy diskette and hard disk capabilities, and host-file transfer functions. It will support all popular software packages including business graphics applications, and will include compatible peripherals such as printers and disk drives.

Most of the high-quality ingredients for this system are already here—personal computers, multifunction terminal systems, word processors, and business graphics. What is still needed is the merger of these capabilities into a family of compatible communications and processing workstations.

In light of this evolution, it is no longer a question of whether 3270 emulation or a personal computer attachment will be more popular. Instead, the question becomes how will micro and terminal system technologies merge to form the base of a much greater evolution that will produce a standardized workstation family covering every aspect of office automation.

—Edwin G. McMullen
Minneapolis, Minnesota

WORKING TOWARD A BETTER WORLD

Not long ago, at the age of 25, I got my first big-time job when a major airline hired me as a systems analyst. I was very good at the technical aspects of what I did, for I had been trained well: BA in mathematics, graduate courses in computer science, several years of full-time work experience, and lots of technical training. Yet something happened on this new job for which I wasn't prepared.

The computer users within my new company were frequently older than I, less formally educated, and earned considerably more money. Some of them had been performing the same job for 20 years. I thought most of these people and their jobs were boring.

I soon discovered that these people didn't care much for me, either, or for my job. They referred to me as "my programmer" and on a good day that was of equal status with "my secretary."

But I didn't mind. If my efforts weren't appreciated I could always get a job elsewhere. Most of my companions in the computer profession had experienced similar animosities.

Do you see what is going on? I didn't. I just thought the world was full of unappreciative old fogies who couldn't adapt to change.

All my training and experience hadn't taught me the simple fact that computers are changing people's lives. These electronic machines are eliminating some jobs and creating new ones. Work is one of those things that gives meaning to people's lives. When you change a person's job you change who that person thinks he is. Taking away his job is worse. . . .

Once I realized this, I tried seeing things from the other side: "Who needs some 25-year-old kid in a cheap suit and a wild tie changing my life? Who does he think he is, taking away one of the things I do really well? But wait, I'm part of management. My duties are to the shareholders and my manager. What this kid is doing is best for the company. My boss proved that to me last year. The reasonable thing for me to do is learn to deal with it."

These people, who were older than I, wiser than I, more mature than I, and had feelings and pride just as I had, were trying to deal with me. They were doing the best they could, often without much support or understanding from their management.

When this first became apparent to me, my reaction was to blame them. After all, they were being paid so well, they should figure out how to deal with their feelings and fears. But a good part of the responsibility was mine. I was bringing the change. Their lives weren't all that bad before they met me; I seemed to bring nothing but problems.

We computer professionals will gain additional respect when we understand both the technical and human aspects of what we are doing and where our responsibilities lie. Empathy with our clients should come easily. After all, we are working to eliminate our own jobs as well.

Computer users might realize that we are all working for a better world, even though at times it may not look like it. If the things once meaningful are gone, let's find new things that are even more meaningful. It's hard work, but it's there.

Management will find that most of their uncooperative employees are not against automation per se; they just want compassionate leadership. We need to be shown that computers don't just mean the end of something comfortable and good, but also the beginning of something exciting and better.

More than anything, we should all have fun in the process.

—Brooke Allen
New York, N.Y.

**WHY
SETTLE
FOR A
SOFTWARE ONLY
SHOW...
WHEN
THERE'S
COMDEX?**

NOW... THERE'S COMDEX/WINTER, TOO.

ANNOUNCING the most important new computer event for 1984 — COMDEX/Winter! The third U.S. COMDEX — the show that brings computer industry manufacturers and resellers together again.

Everyone knows you can't run software without hardware and related products. That's why COMDEX/Winter makes sense. The new computer show that helps you keep ahead of new product announcements, new companies, and new technologies — software and hardware. It's the right place for you to build, expand, upgrade, and support your ISO network, just as you always have at COMDEX but...

IT'S A SOFTWARE ONLY SHOW

That's right. COMDEX/Winter offers the option of separate software and hardware sections in the same exhibition facility! You'll get double the benefit that "software only" and other product-specific expositions could possibly offer...plus...

IT'S A HARDWARE SHOW, TOO

COMDEX/Winter provides the added pull of hardware and related products exhibited **with software** in one place at one time! There's no need to invest your trade show dollars in anything less, because COMDEX/Winter is...

BUILT ON THE PROVEN COMDEX SUCCESS FORMULA

COMDEX is recognized as the trade show for the computer reseller network. And, like other COMDEX shows, COMDEX/Winter is a high pay-back investment. It delivers the highly-qualified ISOs that you want — and need — to do business with! And, it couldn't come at a better time. The computer industry is growing and evolving so fast that **nothing less than a third COMDEX can help you stay in the lead!**

Don't settle for software only when COMDEX/Winter will bring it all to you — software, hardware, and all the related products. Come do business and profit at COMDEX/Winter '84. And, do it in April in Los Angeles — the home of the 1984 Olympics! Get all the facts. Call us today, toll-free at (800) 325-3330/in Massachusetts (617) 449-6600.

 **COMDEX/Winter '84**
DON'T SETTLE FOR ANYTHING LESS.

April 5-7, 1984
Los Angeles Convention Center
Los Angeles, California

Produced by,



world's leading producer of computer conferences and expositions including COMDEX/Winter, COMDEX/Spring, COMDEX/Fall, COMDEX/Europe, COMDEX in JAPAN, INTERFACE, FEDERAL DP EXPO, and the nationwide COMPUTER SHOWCASE EXPOS.

Operate Your
PDP-11
at Peak Efficiency

With SRF,

The PDP-11 Performance Monitor

- Improve System Response
- Reduce System Bottlenecks
- Eliminate Waste of Resources
- Optimize Hardware and Software

SRF for Peak Performance



P.O. BOX 188
RIVERDALE, MD 20737
(301) 864-3700

PDP-11 is a trademark of Digital Equipment Corporation

CIRCLE 155 ON READER CARD

THE SINGLE SOURCE SOLUTION

TO ALL YOUR FACILITIES PLANNING AND CONSTRUCTION NEEDS

Design and Construction Services Include:

- Site Planning
- Hardware Configuration
- Environmental Control
- Electrical Systems
- Architectural Systems
- Access Flooring
- Fire Suppression
- Security Systems
- EMI/RFI Shielding
- As-Built Drawings

THE METHOD MAKES IT WORK!

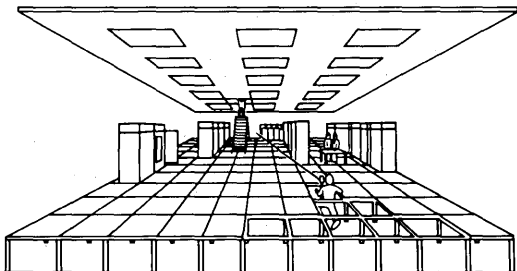

Fast-Track Performance & On-Time Completion



In Maryland call (301) 937-1730

CIRCLE 156 ON READER CARD

READERS' FORUM

THE TROUBLE WITH INFO CENTERS

The latest breakthrough from IBM is the Information Center concept. Never in the history of computer evolution have so many waited so expensively for so little. After years of promises and repeated requests for higher budgets to purchase still another generation of equipment, dp has yet to deliver a truly user-friendly management information system (MIS).

Application backlogs now average two and a half years and go as high as five years in some companies. Maintenance of outdated systems absorbs up to 70% of most programmers' time. According to Walter E. Lankau, vp at MDS, Waltham, Mass., \$30 billion of dp funds goes to support \$450 billion worth of managerial/professional activities, while \$50 billion of dp money supports \$150 billion worth of clerical activities. Further hindering the dp function are programming languages, uncompromising database management systems, unfriendly hardware and software, chronic shortages of technical expertise, and low-productivity staffs.

To add to the confusion, the Information Center will be introduced into this environment. It is defined by IBM as "a new function that can exist within—or alongside—the traditional dp department. It interfaces with end users, guiding them in the application of easy-to-use interactive tools, program packages, and techniques to enable them to solve their own problems. It should provide the following benefits:

- greater responsiveness to end-user requests
- improved image to end users and to upper management
- potential reduction in maintenance
- improved productivity
- faster application development
- greater awareness of the potential uses of data processing."

I contend that the Information Center, as currently defined, is a self-serving, poorly thought-out reaction by mainframe adherents to technological developments that are passing them by. Given the conditions identified above, users, out of impatience and frustration because they are being shortchanged in areas that are important to them, such as responsiveness to users' needs, and development of more analysis systems and decision support systems, are now voting with their budgets to opt out of dp.

Martin A. Goetz, senior vice president of Applied Data Research Inc., argues that this concept, in reality, is nothing more than a compromise measure and is based on several misleading fallacies:

1. "Users cannot gain control of 'their' data and access or update current operational data but can access and update data that are almost current.
2. "A data dictionary need not be the central point of control.
3. "A group of specially trained data processing personnel will quickly teach and assist end users to easily satisfy their own immediate data needs by using many different IBM software programs.
4. "Efficiency and cost effectiveness are of secondary importance."

Why would dp embrace this flawed concept? I believe it does so reluctantly, and it shows in the results of a study conducted by FTP, a Port Jefferson Station, N.Y., market research firm. The survey showed that only 48% of business systems analysts, 33% of programmers/systems analysts, and 27% of dp operations have a positive attitude toward the concept. But then this reluctance is outweighed by the need to preserve the old order.

SWIG[©]

SOFTWARE WRITERS INTERNATIONAL GUILD

THE LARGEST PAID MEMBERSHIP PROGRAMMERS GUILD -
OVER 5,000 MEMBERS WORLDWIDE!!

SCHEDULED SWIG ACTIVITIES & MEMBERSHIP BENEFITS

- (1) \$10,000 PROGRAMMING CONTEST (Members only)
- (2) NATIONAL COMPUTER WEEK (March 23-April 1, 1984)
- (3) ANNUAL CONFERENCE AND SOFTWARE AWARDS CEREMONY (During National Computer Week)
- (4) CONSULTANT REGISTRY (With computer store referral system for customized software)
- (5) JOB PLACEMENT SERVICE (Free to individual members, fixed maximum fee to companies)
- (6) FREE SEMINARS & MEETINGS LOCALLY
- (7) SOFTWARE LIBRARY LENDING & EXCHANGE SERVICE (Professional quality assemblers, utilities, games, etc.)
- (8) SOFTWARE LOCATION SERVICE (For companies & individuals-if it exists, **SWIG** will find it. If not, see #9)
- (9) SOFTWARE DEVELOPMENT SERVICE (From novice to scientist, **SWIG** members can work on any project-from applications to games to R&D)
- (10) LEGAL SERVICE
- (11) AGENT (**SWIG** can represent you in sales to software publishers)
- (12) 24 HOUR - 7 DAY BULLETIN BOARD SYSTEM (BBS) ACCESSIBLE BY COMPUTER FREE
- (13) AND MORE!!!!

MEMBERSHIP APPLICATION FOR SOFTWARE WRITERS INTERNATIONAL GUILD

NAME _____

ADDRESS _____

CITY _____ STATE _____ ZIP _____

PHONE # () _____

• CLASSIFICATION:

- NOVICE BEGINNER TO ADVANCED
 ADVANCED WITH ON THE JOB EXPERIENCE RESEARCH/SCIENTIST

• WHAT EQUIPMENT DO YOU HAVE EXPERIENCE WITH &/OR ACCESS TO &/OR PLAN TO BUY?

- MAINFRAME MINI MICRO DESIGN/R&D

BRAND NAME(S): IBM XEROX APPLE TI

COMMODORE RADIO SHACK ATARI OSBORNE

TIMEX/SINCLAIR NORTH STAR HEWLETT PACKARD

OTHER _____

• AREAS OF INTEREST:

- DATA PROCESSING BUSINESS APPLICATIONS GRAPHICS
 LEGAL VOICE MEDICAL APPLIANCE (HOME) CONTROL
 ROBOTICS GAMES MUSIC R&D OTHER _____

• MEMBERSHIP ACTIVITIES AND SERVICES OF INTEREST:

READ THE LIST ON THE LEFT AND CIRCLE THE NUMBERS BELOW THAT APPLY.

1 2 3 4 5 6 7 8 9 10 11 12

- I HAVE ENCLOSED \$20 ANNUAL MEMBERSHIP FEE CK MO
(MAKE CHECK PAYABLE TO: **SWIG**)

RETURN TO: **SWIG**
P.O. BOX 87
STONY POINT, NEW YORK 10980
(914) 354-5585

SWIG © SOFTWARE WRITERS INTERNATIONAL GUILD

EXTEND YOUR PRINTER CABLE



PS3910

Line Printer Controller

The HAL PS3910 Line Printer Controller System allows you to "extend" the cable of your mainframe printer. The PS3910 connects between the printer and mainframe using a standard dial-up telephone line. Data compaction and error correction are used to handle printer speeds up to 600 LPM. Full interactive data exchange is provided on the two-way communications link so that the computer and printer operate just as if they were sitting side-by-side. When you need a remote high speed printer, use the PS3910 and save the cost of an additional mainframe computer. Some of the features of the PS3910 are:

- Manual, automatic-answer dial-up, or dedicated line service
- Data is compacted and error-corrected
- Printer speeds up to 600 LPM
- Full two-way communications between printer and mainframe
- Printer status relayed to mainframe
- Interface to [®] Centronics-compatible printer port
- Optional [®] Dataproducts or [®] HP Universal-Differential Interface
- Use one PS3910 at mainframe and one PS3910 at printer
- No change required to existing printer support software
- Local and remote printer testing included
- Switch selection of local or remote printer
- Control multiple printers from one mainframe
- One or more printers may be driven by multiple mainframes
- Economical and efficient

Find out more about the remarkable HAL PS3910 system. Contact us today.



HAL Communications Corp.
P.O. Box 365
Urbana, Illinois 61801
(217) 367-7373
TWX: 9102450784 HALCOMM

[®] Centronics - TM of Centronics Data Computer Corp.
[®] Dataproducts - TM of Dataproducts
[®] HP and Universal-Differential Bus - TM of Hewlett-Packard

CIRCLE 158 ON READER CARD

READERS' FORUM

The usefulness, power, and influence once held by dp is disappearing. To a function that operated virtually as a monopoly in companies, sustained by a misunderstood and intentionally complicated technological environment, the user revolt now under way has ominous portent. This revolt is fueled by low-cost, high-power hardware and software that are readily available and usable.

So, facing this loss of prestige and power, and spurred by large temporal and financial commitment, dp has frantically searched for some way to stall the revolt until it can regain control. The Information Center seems to be the best game in town. The concept is promoted, on the surface, to let end users retrieve and manipulate information on personal computers.

What end users now seek is eminently clear. Study after study, such as that done at MIT in 1982 and supported by the Center for Information Research, has pinpointed users' concerns. Management wants and is demanding more computer assistance for the complex decision making required by today's businesses. It is clear that dp does not meet those needs and neither will the Information Center, as currently defined.

The time has come for dp to find out what end users do and how they do it, to meet with them on their terms and listen carefully to their concerns. Dp must make a concerted effort to be understanding and knowledgeable about the business and to speak the same language as the user. Dp must strive for acceptance, as an equal partner, in the executive suite and give up the reclusiveness of the high priests of technology.

How can this be done? By finally admitting that in the transition from a smokestack to a service-oriented economy, industrial-type transaction systems are on the wane and intellectual-type production systems are on the rise. This means recognizing that information is as critical a resource to management as labor, material, and capital resources ever were. Management, too, must recognize this.

What's needed is the formation of a management systems task force (not a steering committee), comprised of key users and MIS personnel, responsible for developing an integrated information architecture.

The chief goals will be leveraging of information resources and preparation of an information strategic plan that supports the company's plans and direction. This task force will deliver a usable MIS that allows direct access to integrated data, in English, on-line, with rapid-fire communication and "what if" capability at a decent cost, and in a decent amount of time.

This means that dp, in partnership with management, must reorganize the dp function to reflect its changing environment. Such a reorganization must take the form of a management resource entity, with the following under its aegis: dp, MIS, database management, decision support/executive information systems, office automation, telecommunications, and graphics.

If the above-mentioned is not done and the current version of an Information Center is implemented, I predict costs will rise dramatically while productivity and use continue to decline. Uncontrolled use of data will contaminate the decision-making process, and users' needs will still not be met. Out of necessity, users will continue to develop their own decision support systems while supermarket software proliferates, security becomes a nightmare, and timesharing flourishes to the detriment of in-house installations.

Dp has the chance to rise to new power and influence, or, like the dinosaur, pass into evolutionary history. The transition is inevitable, the direction is clear; can they meet the challenge?

—E. Ward Stearns
Montvale, New Jersey

If you'd like to share your opinions, gripes, or experiences with other readers, send them to the Forum Editor, DATAMATION, 875 Third Ave., New York, NY 10022. We welcome essays, poems, humorous pieces, or short stories.

Now, Personal Computing Power on any 3270 Compatible Terminal.

From PHAZE.

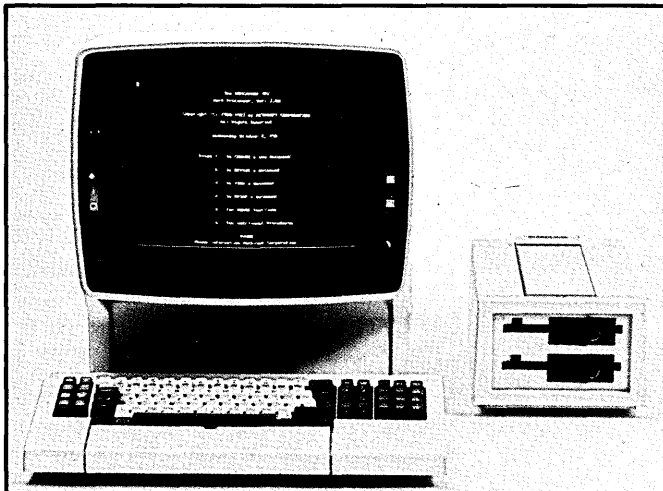

IBM 3278-2 with PHAZE P9002

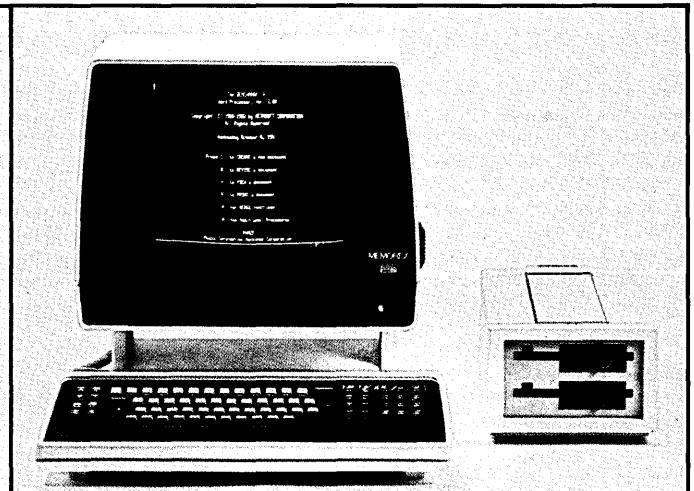

MEMOREX 2078 with PHAZE P9002

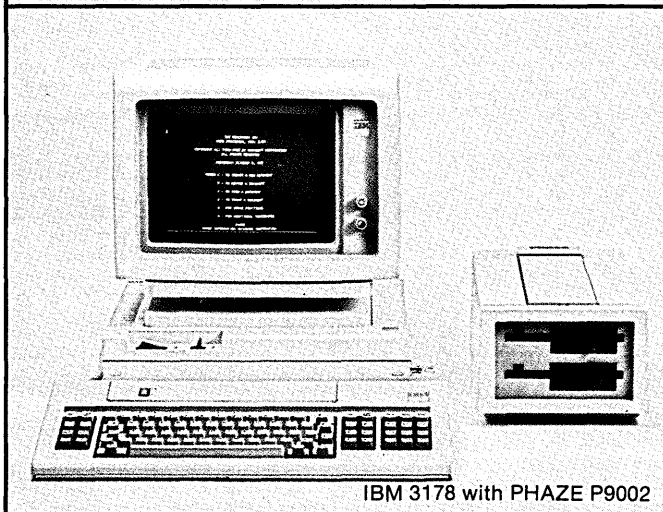

IBM 3178 with PHAZE P9002

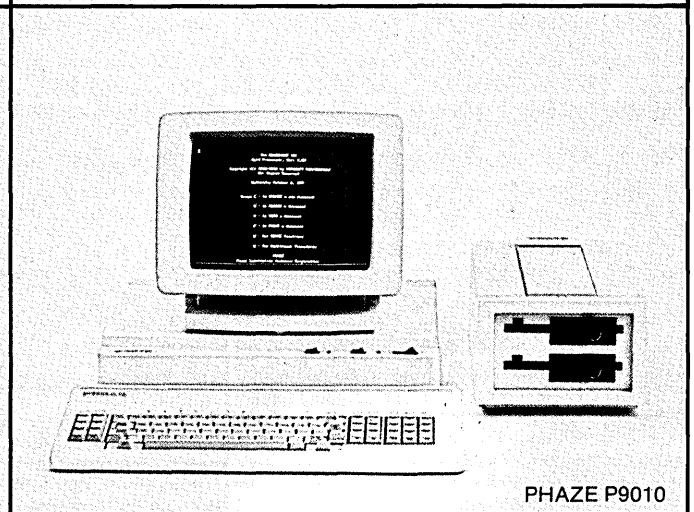

PHAZE P9010

Something Better.

Our P9002 Information Processing Facility is a PC-compatible computer upgrade that can attach directly to any 3270 controller-based system. And, unlike some of our competitors, our computer attaches not only to our own P3278 terminal, but to the entire range of 3278 plug compatible terminals — IBM 3178 and 3278, Telex and Memorex. That provides you with something more for your money. Something better.

Industry Standard Software.

Not only does the P9002 upgrade your 3278 terminal to a personal computer, but it also uses industry standard software, like MS-DOS and CP/M-86.

That means that you get the benefit of software available for the IBM Personal Computer.

Upgrade It Yourself.

The P9002 features a computer and diskette module with two 320Kb disk drives. It connects directly to the terminal and the controller via standard coax cable and the entire installation can be done in less than 60 seconds.

PHAZE
INFORMATION MACHINES CORPORATION

We Make The Addition Easy.

PHAZE Information Machines Corporation
7650 East Redfield Road
Scottsdale, Arizona 85260

CIRCLE 2 ON READER CARD

Without tools. And since the P9002 utilizes an IBM 3278 or equivalent for its keyboard and display, the operating configuration remains unchanged, so there is no operator retraining.

More For You.

No one else offers the versatility and compatibility that you can get from PHAZE. Because we offer 3278 compatible terminals as well as computer upgrades, we cover the breadth of the 3278 spectrum. We understand user needs, and we make it easy for you to upgrade your current system with our P3270, P9002 and P9010 products. That's because at PHAZE, we're expansive...not expensive. For more information, call S.T. Lifeson at 1-800-423-2994.



NO OTHER FEATURE PRESENTATION RUNS AS LONG AS OURS.

Introducing the 5420, an editing terminal that's chock-full of features that are sure to make it a hit. That's because Teletype Corporation built it to be everything you'd ever want in an ANSI 3.64 based asynchronous terminal.

To begin with, there are four ways to access and manipulate the display and memory. Scroll mode lets you scan all 72 lines of available memory with the display.

Horizontal split screen separates the display into fixed and scrolling regions. Windowing

divides the display into as many as four viewports and workspaces that let you process groups of data simultaneously. Page mode makes the terminal perform as if it were three.

Another example of the amazing value the 5420 represents, is that it lets you change from an 80 to 132 column mode to put more data—including accounting spreadsheets—on display.

In addition to eight system defined function keys that can be down-line loaded from a host, you get eight non-volatile user defined function keys that can be entered locally. All 16 function keys are easily associated with screen labels. When the function of these keys is changed, the screen labels can change right along with them. And a variety of local terminal features can be accessed through the screen labeled keys.

As if that's not enough, there's an English menu for fast set up when optioning. The 5420 is also buffered so you can send a character, line or page of data at a time. Plus, you get character, word and line insert/delete. A bi-directional, buffered EIA printer port is standard.

We didn't skimp on ergonomics, either. That's evident in the detachable, low-profile keyboard you can operate on your lap. And in the crisp, clear images you get with the tiltable, high resolution, non-glare screen.

Self-diagnostics help pinpoint problems. And you can count on our established nationwide service organization for fast service.

Looks like we've run out of room for features. Get the rest of the presentation from your Teletype supplier.

TELETYPE®: VALUE SETS US APART.



Teletype Corporation, 5555 Touhy Ave., Dept. 3223-A, Skokie, IL 60077. Tel. 1 800 323-1229. Extension 204. "Teletype" is a registered trademark and service mark of Teletype Corporation.



TELETYPE CORPORATION
Official Supplier of the
1984 Olympic Games