

June

3.00

USA

## THE TOP 50 U.S. COMPANIES IN THE DP INDUSTRY



Also: Display Terminal Survey, Interactive Graphics,  
The Univac II, and Merging Text and Data Processing . . .

# Kennedy Digital Tape Transports

## and the

# QUALITY EXPLOSION.

heavily featured in the product suite of state-of-the-art quality tape transport peripherals from Kennedy.

Years of experience has resulted in products exclusive—and standard features such as:

- A position arm anti-collapsing sensing system. An exclusive Kennedy feature, the linear, non-contact (MagiPot) position sensor requires no lamp source and assures performance for the life of the machine.
- Interchangeable electronics on all Series 9000 transports, reduce stocking costs and downtime.
- Front-accessible off-line test panel, marginal skew check, threshold scanning which automatically compensates for drop-ins or drop-outs, Read-After-Write shortened skew gate, simplified tape path and quick release hubs.

○ All models are available with either 7 or 9 track, 800 or 1600 PE or 1600 NRZ tape.

○ 7 and 9 track NRZ and PE format control units for single customer electronics. Also, a variety of popular microprocessor magtape controllers are available. Series 9000's performance is as impressive as its features, with data transfer rates to 72KHz, and tape speeds from 100 to 45 ips.

Kennedy Digital Tape Transports have quite simply changed the industry by introducing the missing ingredient, quality of performance.

**KENNEDY CO.**

540 W. WOODBURY RD., ALTADENA, CALIF. 91704  
(619) 798-0858

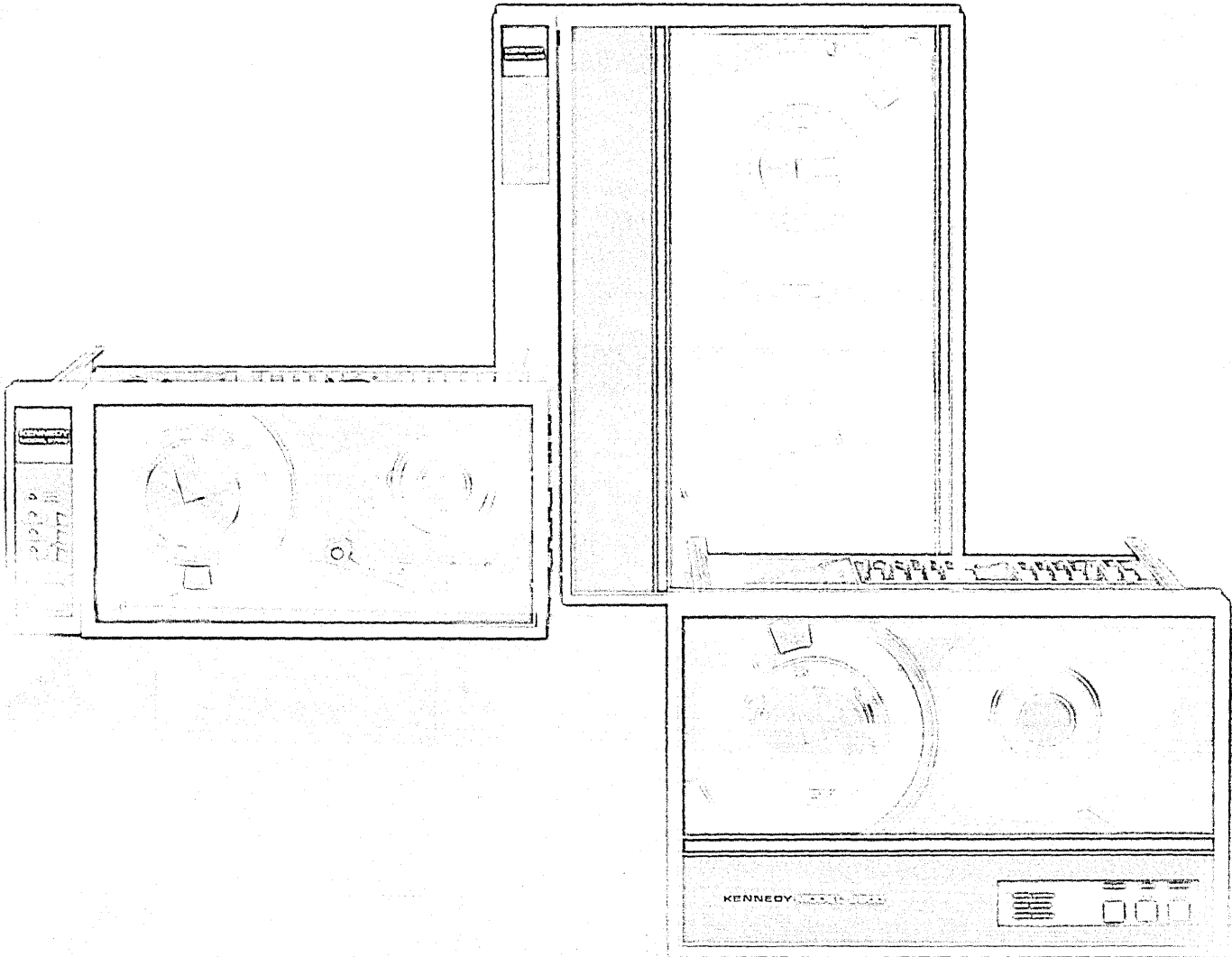

KENNEDY QUALITY-COUNTS ON YOU



# Now appearing on your favorite networks XL Distributed Processing Systems

*Your Denver regional office needs up-to-the-minute reports from Los Angeles and Seattle... the central parts depot in Atlanta must maintain current inventory based on information received from six supply centers... Warehouses in Rochester and Belling need to access the database in Atlanta, but don't need local processing... Branch offices in Calgary, Phoenix and Toronto must process orders and transmit to regional managers... headquarters in Minneapolis needs to communicate with all regional and branch offices...*

Presenting XL Distributed Processing Systems from Pertec Computer Corporation. A family of microprocessor-based computer systems — and an approach to distributed processing — that cuts through the buzzword maze to provide state-of-the-art hardware and software solutions.

### *High-power processing*

The top-of-the-line XL40 handles up to 16 local and remote terminals. With up to 614K bytes of memory and disk storage expandable to 70 megabytes for local databases, it can also interactively access your headquarters mainframe via 3270 inquiry mode (or non-XL40 mainframe sites). Put one in Denver, another in Atlanta.

### *Remote Access*

XL Remote On-Line Site Systems (ROLS) consist of remote printer/terminal configurations that access the power and data base of the XL40 interactively over telephone lines. ROLS can also take advantage of the XL40's 3270 mode to access the mainframe database, greatly

enhancing the amount of data available to any one user. Order them for your supply centers and warehouses.

### *Introducing XL20*

And introducing PCC's newest XL family member XL20, a diskette system for applications requiring total intelligence, databases, communication and processing power. The XL20 offers your branch offices up to 128K bytes of memory and 4.8 megabytes of diskette storage. And a plus: An optional offline/offline feature enables your XL20 terminals to operate interactively with an XL40 and to access the mainframe database via the XL40's 3270 mode whenever necessary.

Designed with compatible hardware architecture and operating systems, XL distributed processing networks install and upgrade simply. And they're supported throughout the United States by more than 400 service professionals in the PCC Service Division.

Call or write today for a detailed brochure on XL Distributed Processing — now appearing on your favorite networks.

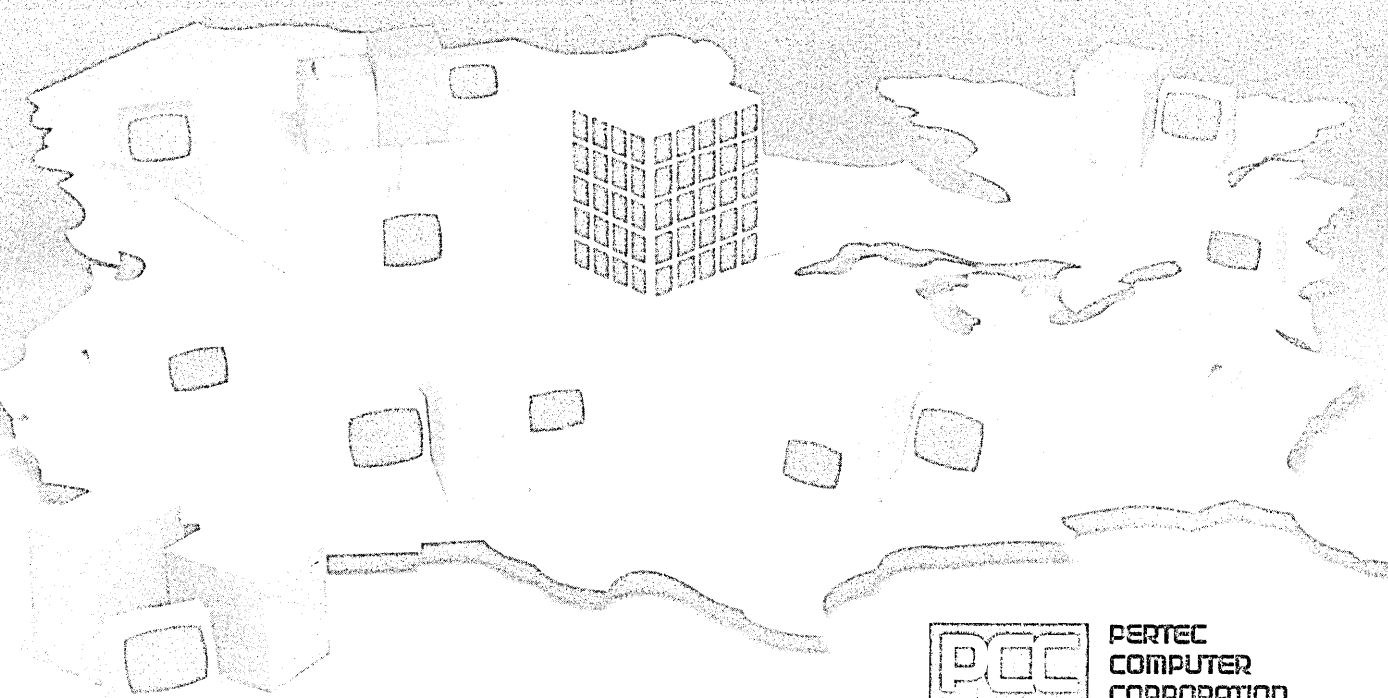

PERTEC  
COMPUTER  
CORPORATION

CMC DIVISION  
12910 Culver Boulevard, P. O. Box 92300  
Los Angeles, California 90009  
(213) 822-9914 TWX (910) 343-6451

# WITH ITEL'S NON-IMPACT PRINTER, YOUR \$61,526.00 SAVINGS\* COULD LOOK LIKE THIS.

Forms Overlay optical image system prints high quality document and report formats, designs or other constant data. Format and data merge under program control.

Random choice of type style, font size and column spacing within a single line.

The 7800 printer reproduces photos electro-photographically.

Prints on single part continuous forms in an infinite range of paper sizes from 6.5" X 3.5" to 15.8" X 14"

20 standard character sets.

<b>ITEL CORPORATION</b>	<b>COMPUTER PRODUCTS DIVISION</b> ONE EMBARCADERO CENTER SAN FRANCISCO, CALIFORNIA 94111	
PAY	ANY CUSTOMER	DATE 4/3/78
TO THE ORDER OF		\$ 61,526.00
SIXTY-ONE THOUSAND FIVE HUNDRED TWENTY-SIX AND 00/100		DOLLARS
NON-NEGOTIABLE ADVERTISING		<i>Aug Coyle</i> PRESIDENT, COMPUTER PRODUCTS DIVISION
"000000" : 0000 0000 : 00000000 "0000"		

Not only does Itel's new 7800 Non-Impact Printer do everything the IBM 3800 does, but does it for less.

And money isn't all you save — the Itel 7800 printer takes up about one-third less floor space than its IBM counterpart. Plus, our uncomplicated paper path means easier, faster loading. So, with Itel's 7800, you save time, save space and save money.

Of course, all 3 models of our 7800 are 100% functionally com-

patible with IBM operating systems and the IBM 3800. And, except for two-channel switching, all optional IBM features are standard on all Itel 7800 models.

Equipped with Forms Overlay and 20 standard character sets, our 7800 can be used for many varied applications, from inventory control to payroll checks.

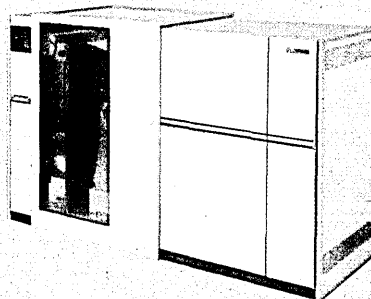

Itel has always specialized in providing sensible alternatives to IBM. Now our 7800, the only 3800 functionally compatible non-impact printer available, provides you with the kind of unparalleled savings that are making Itel the only alternative.

**ITEL CORPORATION**  
Data Products Group  
One Embarcadero Center  
San Francisco, California 94111  
Telephone: (415) 955-0000

\* Savings during the first year, in terms of purchase price and average monthly use of 1.5 million ft. of paper.



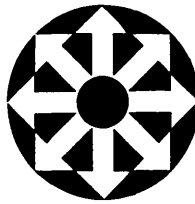

# DATAMATION®

VOLUME 24 NUMBER 6

This issue 147,090 copies

JUNE 1978

## FEATURES

- 85 THE TOP 50 U.S. COMPANIES IN THE DATA PROCESSING INDUSTRY  
**Oscar H. Rothenbuecher.** It was a year of fast growth and big changes.
- 117 PROCESSING SATELLITE DATA  
**Eric Teicholz.** It's coming to be part of the everyday dp world.
- 134 THE EXPANDING REALM OF COMPUTER CARTOGRAPHY  
**Geoffrey H. Dutton and William G. Nisen.** Information processing is more than data processing after all.
- 153 FACING FINANCIAL REALITIES IN ON-LINE BANKING  
**Robert Chapman.** And putting 30 sites on-line per week.
- 145 THE LAST OF THE FIRST  
**Aubrey Dahl.** After two decades of dedicated service, it's the scrap heap for the last Univac II.
- 165 INTEGRATING TEXT AND DATA PROCESSING ON A SMALL SYSTEM  
**Thomas Plum.** This may be the least expensive way to get big-system benefits.
- 176 MONITORING DATA INTEGRITY  
**Robert Fried.** A carrot works better than a stick.
- 183 ALPHANUMERIC DISPLAY TERMINAL SURVEY  
**David H. Axner and Fonnle H. Reagan.** It's a buyer's market, with at least 170 products from 76 vendors to choose from.

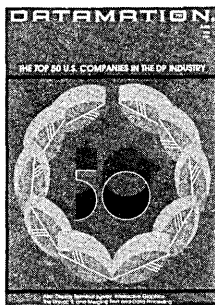

## NEWS IN PERSPECTIVE

- 221 STATE GOVERNMENT  
California Teale center five years later.
- 223 COMPANIES  
Dramatic turnaround at Memorex.
- 225 NETWORKS  
Bell's ACS network.
- 226 FINANCIAL  
Breaking it out at IBM.
- 227 MAINFRAMERS  
The world of IBM.  
The largest IBM companies in the world.
- 228 REGIONS  
Computers for sale in Florida.
- 231 FEDERAL GOVERNMENT  
Frank Carr of the GSA.
- 239 SOFTWARE TAXES  
Unimpressed in California.
- 242 PCMs  
The Magnuson 80 is a lot like the others.
- 245 COMMUNICATIONS  
Bell's big venture into fiber optics.  
USPS to undercut mailgram rates.
- 248 MEETINGS  
DDP presumes local control.
- 250 BENCHMARKS  
Still no announcements; "George" goes; MCI lives; Out of paper; ocr marketing deal; Time-sharing ratings.

## DEPARTMENTS

- 8 LOOKING BACK
- 17 LOOK AHEAD
- 25 LETTERS
- 39 PEOPLE
- 46 CALENDAR
- 53 SOURCE DATA
- 82 EDITOR'S READOUT

### About the cover

Traditional laurel wreath reflects the winner status of the dp industry's Top 50, an annual feature of the June issue. Design is by Barbara Benson.

# The New Slimline Series From Okidata

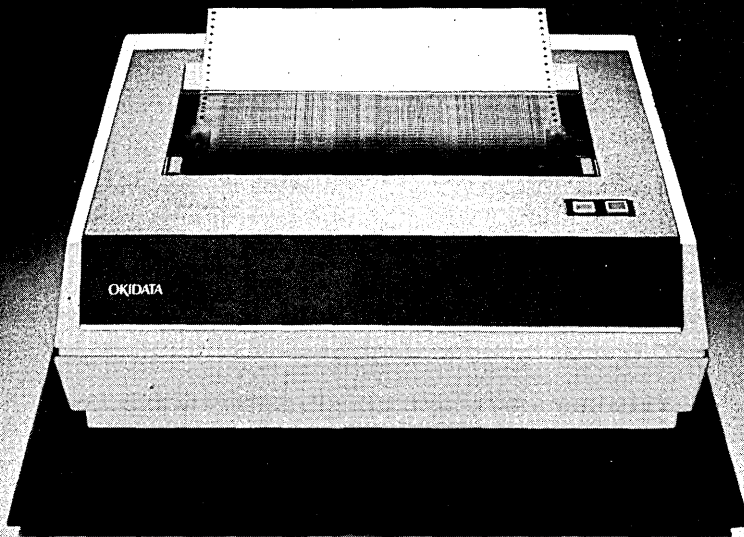

## Line Printers That Sell Minisystems

The Okidata Slimline Series, a new family of microprocessor-controlled, 132 column line printers. A wide range of speeds, options and plug-compatible interfaces, all supported with common spares.

Common spares but uncommon price, performance and reliability. OEM prices that create new minisystem opportunities, print quality that helps sell the businessman and Okidata reliability and maintainability—unmatched in the industry. A 500,000,000 character head warranty and stored program machine history that replaces customer installation records.

The Slimline, available in 300, 250, 160 and 125 LPM models. Twelve program-selectable fonts, 5 x 7, 7 x 7 and 9 x 7 characters, and graphics capability. The Slimline, backed by a worldwide sales and service organization.

# OKIDATA

Okidata Corporation  
111 Gaither Drive  
Mount Laurel, New Jersey 08054  
Telephone: 609-235-2600

CIRCLE 164 ON READER CARD

## DATAMATION®

### EDITORIAL STAFF

<b>Editor</b>	John L. Kirkley
<b>Senior Editor</b>	W. David Gardner
<b>Articles Editor</b>	Richard A. McLaughlin
<b>International Editor</b>	Angeline Pantages
<b>European Editor</b>	Ralph Emmett
<b>Products Editor</b>	Bill Musgrave
<b>Copy Editor</b>	John Waterhouse
<b>Articles Assistant</b>	Sarah Rolph
<b>News Editor</b>	Tom McCusker
<b>Surveys Editor</b>	Nancy Knottek
<b>Bureau Managers</b>	
<b>San Francisco</b>	Edward K. Yasaki
<b>Los Angeles</b>	Edith D. Myers
<b>Greenwich</b>	Angeline Pantages
<b>New York</b>	Laton McCartney
<b>Washington, D.C.</b>	Linda J. Flato
<b>Boston</b>	Vin McLellan
<b>Correspondents</b>	
<b>Minneapolis</b>	James K. Johnson
<b>Southwest</b>	Robert F. Alexander
<b>Australia</b>	Ken McGregor
<b>Editorial Advisor</b>	Robert L. Patrick
<b>Technical Advisor</b>	Lowell Amdahl
<b>Contributing Editors</b>	Paul Armer, Ralph G. Berglund, Howard Bromberg, Philip H. Dorn, John M. Eger, William Helgason, Portia Isaacson, Louis B. Marienthal, Carl Reynolds, F. G. Withington

### EDITORIAL OFFICES

**Headquarters:** 1801 S. La Cienega Blvd., Los Angeles, CA 90035. Phone (213) 559-5111. **Eastern:** 35 Mason St., Greenwich, CT 06830, (203) 661-5400. 420 Lexington Ave., New York, N.Y. 10017, (212) 682-7760. 134 Mt. Auburn St., Cambridge, Mass. 02138, (617) 354-2125. 6605 Burlington Pl., Springfield, VA 22152, (703) 569-3383. **Southwestern:** 11500 Stemmons North, Suite 152, Dallas, TX 75299, (214) 247-5221. **Western:** 2680 Bayshore Frontage Rd., Suite 401, Mountain View, CA 94043, (415) 965-8222. **Foreign:** 15 A St. Ann's Terrace, St. John's Wood, London, NW8, England; (01) 722-5088; 24 Stafford Road, Artarmon, Sydney, NSW 2064, Australia, 41-5748.

### GRAPHIC DESIGN AND PRODUCTION

<b>Art &amp; Production Director</b>	Cleve Marie Boutell
<b>Advertising Production Manager</b>	Marilee Pitman
<b>Production Assistant</b>	Alberta R. Martin
<b>CIRCULATION</b>	
35 Mason Street, Greenwich, CT 06830	
<b>Circulation Manager</b>	Suzanne A. Ryan
<b>Marketing Research Manager</b>	Deborah Dwellley
<b>Publisher</b>	James M. Morris
<b>Assistant Publisher</b>	F. Douglas De Carlo



Circulation audited by Business Publications Audit



Member American Business Press, Inc.



**DATAMATION** is published monthly on or about the first day of every month by Technical Publishing Company, A Dun and Bradstreet Company, 1301 South Grove Ave., Barrington, Illinois 60010; James B. Tafel, Chairman; John K. Abely, President. Executive and Advertising offices, 35 Mason Street, Greenwich, CT 06830, (203) 661-5400. Editorial offices, 1801 S. La Cienega Blvd., Los Angeles, CA 90035. Published at Chicago, Ill. **DATAMATION** is circulated without charge by name and title to certain qualified individuals in the United States and Canada who are employed by companies involved with automatic information handling equipment. Available to others by subscription at the rate of \$26. Reduced rate for qualified students, \$14. Foreign subscriptions \$50, or £27.50; for airmail, additional charge \$40, or £24.50. Japan and Australia \$65, or £36.50 (air shipped). Sole agent for all subscriptions outside the U.S.A. and Canada is J.B. Tratsart, Ltd. 154 A Greenford Road, Harrow, Middlesex HA13QT, England. No subscription agency is authorized by us to solicit or take orders for subscriptions. Controlled circulations paid at Columbus OH. © Copyright by Technical Publishing Company, A Division of Dun-Donnelley Publishing Corporation, A Dun & Bradstreet Company, 1978—all rights reserved. © "Datamation" registered trademark of Technical Publishing Company. Microfilm copies of **DATAMATION** may be obtained from University Microfilms, A Xerox Company, 300 No. Zeeb Road, Ann Arbor, Michigan 48106. Printed by Beslow Associates, Inc. Circulation Office: 34 East Putnam Avenue, Greenwich, CT 06830. **POSTMASTER:** Form 3579 to be sent to Technical Publishing Company, P.O. Box 2000, Greenwich, CT 06830.

Publication No.: 148800. Single copy: \$3.00 In U.S.A.

**DATAMATION**



# ADR's ROSCOE® Chosen by Allianz— Europe's Largest Insurance Company

Two years ago, Allianz Insurance Company was keeping over 100 programmers busy entering and maintaining programs using conventional batch procedures. Allianz realized it would be more efficient if their programmers could have direct online computer access. Therefore, they organized a team of their DP experts to test ADR's ROSCOE along with the *other* leading time-sharing terminal system.

"Because our CPU was already being utilized 80 to 100 percent by teleprocessing and batch jobs and because we could not expand our hardware, our most important criteria for the choice of a terminal system were performance and CPU load," explained Chief System Programmer, Alexander Metz.

"After a careful comparison, we found ROSCOE best. ROSCOE is a system with a simple language, good data set organization, data security — and a small CPU load.

"During our SVS test evaluation period, for example, we found that

**ROSCOE's overhead was under 1 percent per terminal.**

ROSCOE's overhead was under 1 percent per terminal while the other system we evaluated required up to 4.5 percent per terminal.

"At our headquarters in Munich, 110 users now have access to ROSCOE through 45 terminals — for systems and application programming, job preparation, information retrieval, project planning, monitoring, and documentation.

"One of the big advantages of ROSCOE is that our programmers can now see results of their efforts immediately. They enjoy their work

so much more that more work gets accomplished. After we installed ROSCOE, the number of jobs that our programmers completed rose from 400 to 800 per day.

"I don't believe there is any other system like ROSCOE that can serve 45 terminals with such good response time. Fast response has been very important to us because, if a terminal system user has to wait — even 15 seconds — we find that his mind wanders off, he loses

**ROSCOE's response time is very fast. It's beautiful.**

his train of thought and he doesn't work as well. With ROSCOE, response time is very fast.

"The overall result has been that our productivity has increased, our programming effort is more efficient, and our work is of a higher quality — all because of ROSCOE. It's beautiful."

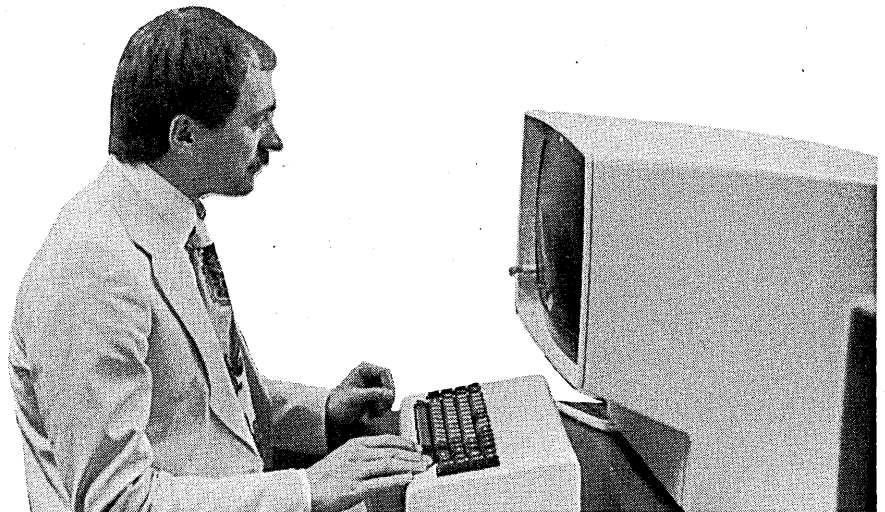

To find out what ROSCOE can do for you — clip this.

Send ROSCOE product information and case histories.     Please call me. I would like a ROSCOE presentation.

Name/Title

Company

Address

City/State/Zip

Telephone

Computer Configuration



**APPLIED DATA RESEARCH** THE ON-LINE SOFTWARE BUILDERS®

Route 206 Center, Princeton, N.J. 08540, Phone: 609-924-9100

Each ADR product is not just a program but a complete package with full documentation and on-site support. ADR is a software company with 50 branch offices and representatives in over 30 countries—each staffed with ADR experts.

ADR software products: In use at over 8000 installations worldwide. U.S. offices in Atlanta (404) 252-9130, Chicago (312) 694-2244, Cleveland (216) 231-1111, Los Angeles (213) 826-5527, New York (212) 988-4050, Princeton (609) 924-9100, San Francisco (415) 391-0690, Washington, D.C. (703) 281-2700, Australia, Austria, Belgium, Brazil, Canada, Chile, Denmark, England, Finland, France, Germany, Holland, Hong Kong, Israel, Italy, Japan, Korea, Mexico, Norway, Philippines, Puerto Rico, Republic of South Africa, Singapore, Sweden, Switzerland, Taiwan, Thailand, Venezuela.

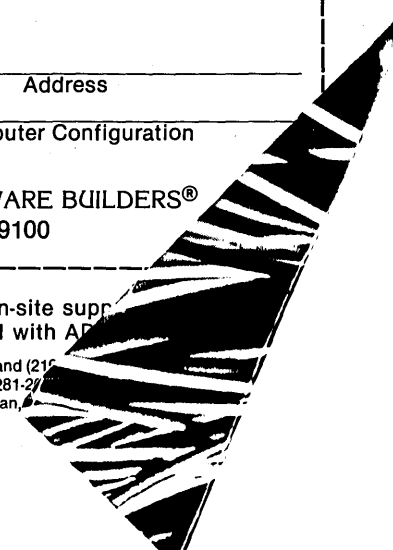

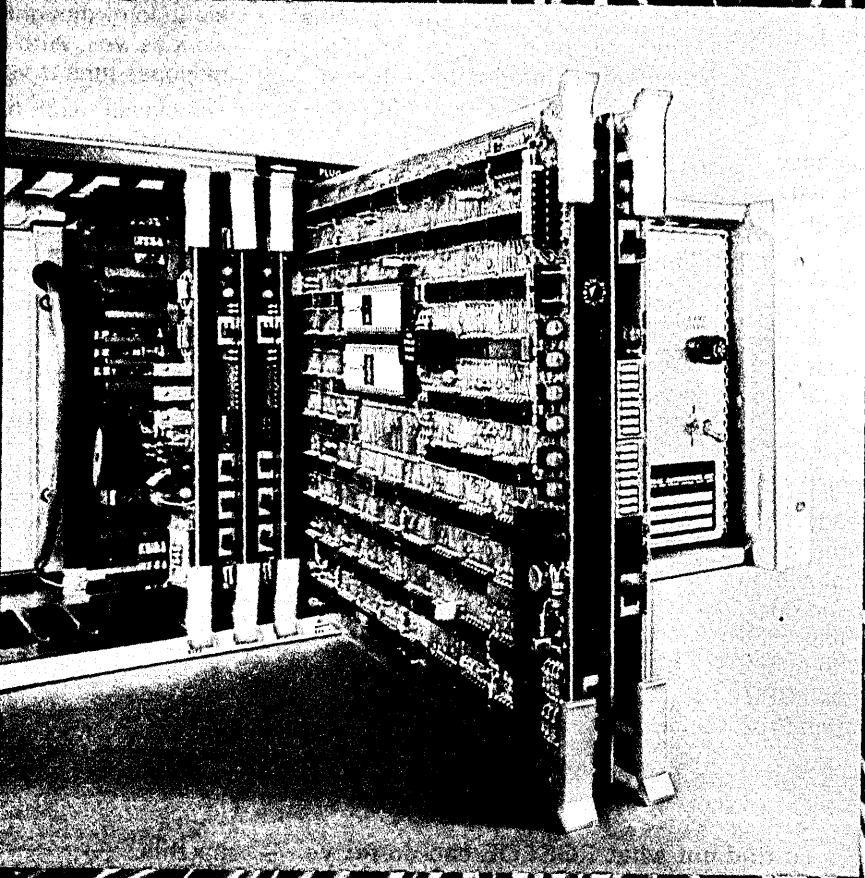





## Count on GA to help carry the load in the most ambitious computer networks.

General Automation: selected by the world's largest corporations, in multi-industries, as a working "partner" in advanced network development.

**Financial.** Developed with the world's largest bank: a GA network of 60 mini-computers regionally modularized. Handles data on ten-million accounts. Teller response: one second. Up to 345,000 transactions per hour. Through 10,000 terminals in 1200 branches.

**Factory testing.** The world's largest automotive firm controls quality in their carburetor division with a 129-minicomputer GA network. Conducts 460,000 QC procedures per day: 18-20 tests on 23,000 carburetors daily sharply reduce reject rates.

**International banking.** GA individually configured over half the 369 member-bank connections into the world's largest interbank network, SWIFT. Nearly 200 sophisticated GA terminal systems: transacting billions of dollars of SWIFT fund-transfers a day.

**Broadcasting.** For the world's largest television corporation: a complex GA 9-minicomputer network. Controls all TV program/commercial feeds to over 200 affiliated stations. With fail-safe backup systems built in by GA, downtime is nonexistent.

Competing against the world's best-known sources, General Automation was selected by these innovative corporations—*after* exhaustive analysis demonstrated GA's superiority in networking technology.

There's not a minicomputer company today that can touch GA's proven performance in ambitious distributive processing networks. In major industries worldwide. In many highly diverse applications: not only financial, factory testing, international banking, broadcasting, but into telecommunications, energy management, publishing, manufacturing, process control.

**GENERAL  AUTOMATION**

For any type of operation, any volume, any speed—count on GA to help carry your load. And you'll be in good company.

Please send information on GA's capability in distributive processing networks.

Contact us for immediate consultation.

Tel: ( ) \_\_\_\_\_ Ext \_\_\_\_\_

Name \_\_\_\_\_

Title \_\_\_\_\_

Clip coupon to business letterhead and return to  
General Automation, 1055 South East Street,  
Anaheim, CA 92803.

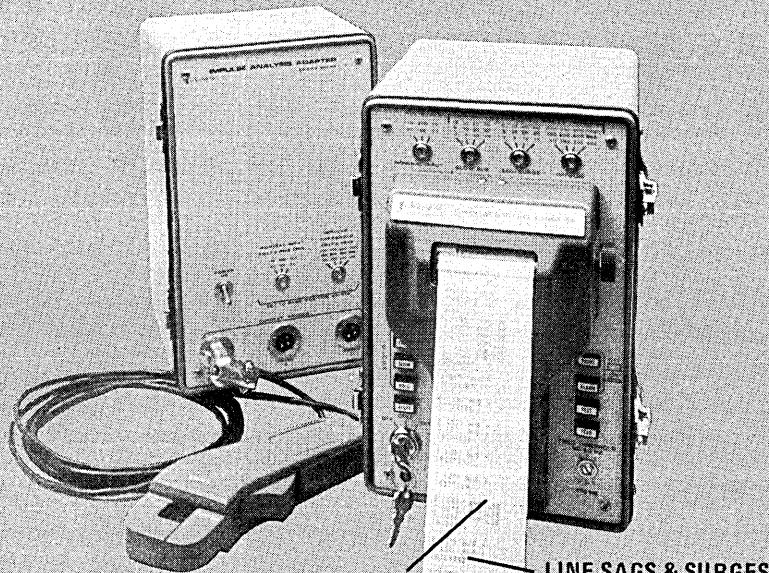

SLOW-AVERAGE  
LINE CHANGES

DC OUTPUT AVG,  
SAG/SURGE, TRANSIENTS

LINE SAGS & SURGES

LINE TRANSIENTS  
NUMBER AND  
AMPLITUDE

IMPULSE AREA  
(VOLT-SECONDS)

## and now... The Final Diagnostic Data!

Two years ago, we brought you the first microprocessor-based line-disturbance analyzer (Series 606) — a breakthrough design that monitored and recorded sags, surges, slow-average drifts, and impulses on AC power lines. It changed the entire computer-maintenance picture, from guessing to *knowing*. You made it the world leader in line-quality assurance. Thousands are in daily service.

Last year, we brought you a new design (Series 616), extending your diagnostic capability to monitoring both AC power input and DC power outputs, so that you could analyze the effectiveness of system power-supply regulators and filters. Once more, it swept the industry.

AND NOW we've created the ultimate diagnostic tool: a family of Impulse Analysis Adaptors that work with

Series 606 Disturbance Analyzers to give you *accurate, quantitative* measurements of *severity* of the most disturbing (and elusive) of all line disturbances: *transient impulses*. Now you can measure, classify, and print records of such disturbances, expressed in terms of *volt-seconds* (energy content) of the transient impulse.

For complete technical data on these brand-new Series 6000 Adaptors, and the Series 600 Power Line Disturbance Analyzers themselves, plus valuable application notes, use the inquiry number, or call or write: Dranetz Engineering Labs., Inc. 2385 South Clinton Avenue South Plainfield, N.J. 07080 (201) 755-7080

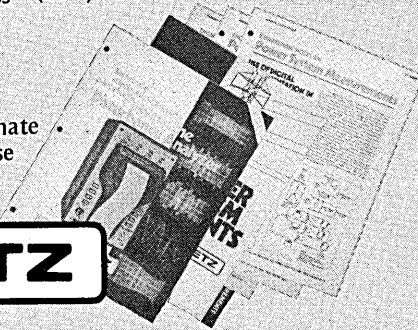

# DRANETZ

## Looking Back in DATAMATION.

### May/June 1958

**Technology:** "It is difficult to imagine a field of endeavor in the electronics industry which is receiving more attention than analog-digital converters," began our lead article, "Analog-Digital Converters: An Evaluation." After defining the criteria for classifying converters, and detailing the state of the art, our article got down to the nitty-gritty: "What to do with them." One possible application: the process industry. "It is somewhat surprising that the area to which analog-digital converters lend themselves has been least exploited."

**International:** The question of Japan Inc. arose twenty years ago, with the noting of the formation of "a central organization for development of the electronic industry in Japan, a group of companies to be known as the Electronic Industry Development Association, will be inaugurated shortly with a government subsidy." At the same time the only computer service in Japan was a 180-word free memory relay computer in Tokyo.

### June 1968

**Terminals:** A survey of "Low-Cost Remote CRT Terminals" limited itself to "low-cost units selling for less than \$20,000." Authors D. J. Theis and L. C. Hobbs identified 30 terminals meeting this criterion; our alphanumeric display terminal survey (see p. 183) in this issue includes 170 entries.

**Unbundling:** "Five revolutionaries advocated the overthrow of the computer industry before almost 600 witnesses at the SJCC last month," reported editor Robert B. Forest. The five sacrilegious souls "suggested such blasphemous thoughts as forcing IBM (and other manufacturers) to price software separately."

**Sexism revisited:** Continuing its inspired series of ads, an OCR vendor asked, "What has sixteen legs, eight waggly tongues, and costs you at least \$40,000 a year?" The obvious answer: eight skirt-wearing keypunch operators. \*



# With SYSTEM 2000,<sup>®</sup> you get more than just a DBMS.

## You also get

- Multiple DB/DC languages with integrated data dictionary
- Greater productivity in applications development
- Lower software maintenance costs
- Proven reliability & availability for complex applications
- Greatly improved use of your data resources
- A solid foundation for future systems

These are just a few of the special benefits of SYSTEM 2000—the most advanced data base management system on the market.



PROFESSIONAL  
THE DATA BASE MANAGEMENT COMPANY

12675 Research Blvd., Austin, Texas 78759, (512) 258-5171

SYSTEM 2000 offers something else really unique—MRI Systems Corporation. A company which has been developing data base management systems for almost ten years. A company staffed with 200 highly skilled people. A company which believes in customer services, and stands behind its products.

Visit MRI in Austin, Texas. You'll see that with SYSTEM 2000, you get more than just a great DBMS—you get an entire company.

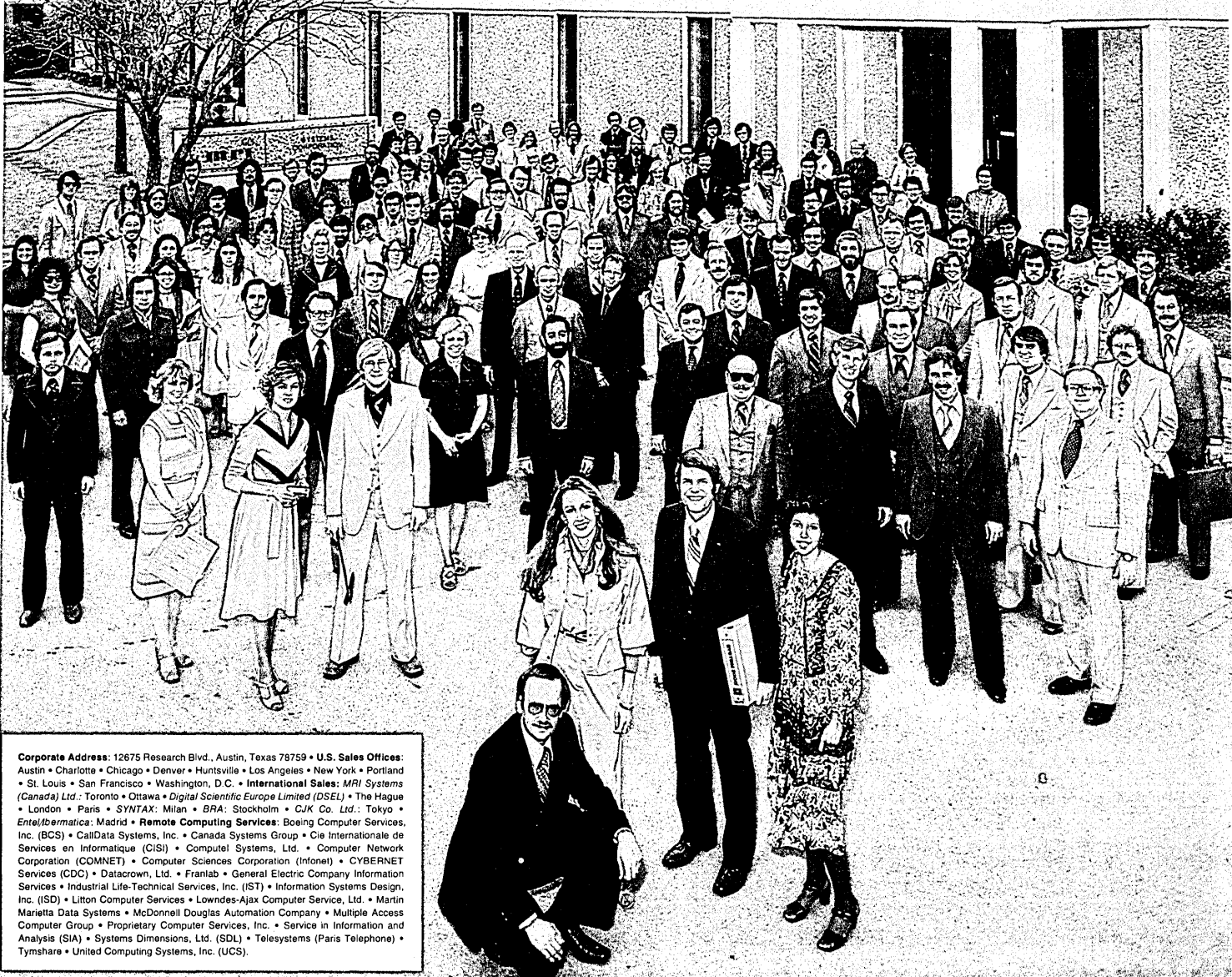

Corporate Address: 12675 Research Blvd., Austin, Texas 78759 • U.S. Sales Offices: Austin • Charlotte • Chicago • Denver • Huntsville • Los Angeles • New York • Portland • St. Louis • San Francisco • Washington, D.C. • International Sales: MRI Systems (Canada) Ltd.: Toronto • Ottawa • Digital Scientific Europe Limited (DSEL) • The Hague • London • Paris • SYNTAX: Milan • BRA: Stockholm • CJK Co. Ltd.: Tokyo • Entel/Ibermatica: Madrid • Remote Computing Services: Boeing Computer Services, Inc. (BCS) • CallData Systems, Inc. • Canada Systems Group • Cie Internationale de Services en Informatique (CISI) • Computel Systems, Ltd. • Computer Network Corporation (COMNET) • Computer Sciences Corporation (Infolnet) • CYBERNET Services (CDC) • Datacrown, Ltd. • Franlab • General Electric Company Information Services • Industrial Life-Technical Services, Inc. (IST) • Information Systems Design, Inc. (ISD) • Litton Computer Services • Lowndes-Ajax Computer Service, Ltd. • Martin Marietta Data Systems • McDonnell Douglas Automation Company • Multiple Access Computer Group • Proprietary Computer Services, Inc. • Service in Information and Analysis (SIA) • Systems Dimensions, Ltd. (SDL) • Telesystems (Paris Telephone) • Tymshare • United Computing Systems, Inc. (UCS).

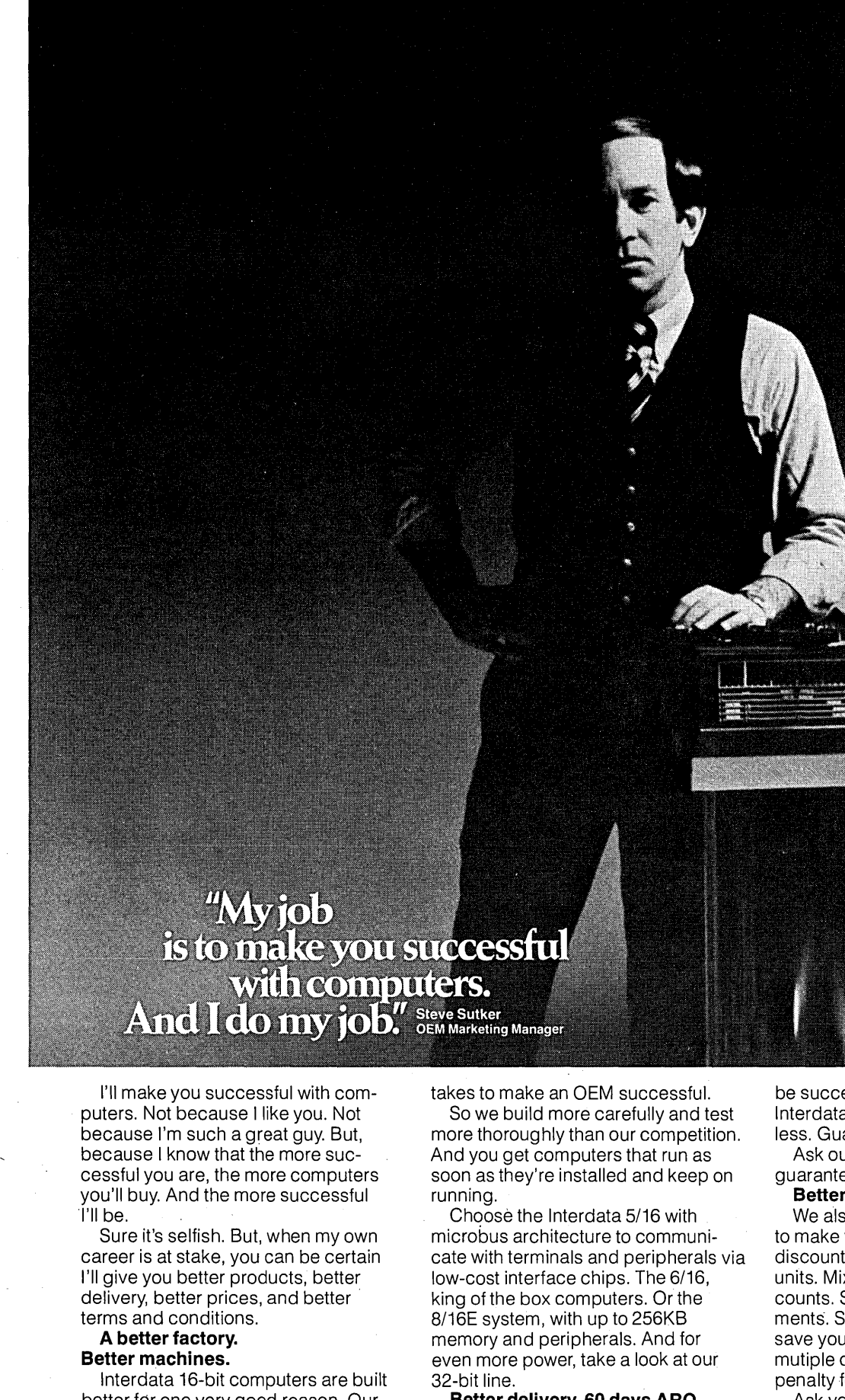

**"My job  
is to make you successful  
with computers.  
And I do my job."**

Steve Sutker  
OEM Marketing Manager

I'll make you successful with computers. Not because I like you. Not because I'm such a great guy. But, because I know that the more successful you are, the more computers you'll buy. And the more successful I'll be.

Sure it's selfish. But, when my own career is at stake, you can be certain I'll give you better products, better delivery, better prices, and better terms and conditions.

**A better factory.  
Better machines.**

Interdata 16-bit computers are built better for one very good reason. Our people have been on your side of the desk. They know the kind of quality it

takes to make an OEM successful.

So we build more carefully and test more thoroughly than our competition. And you get computers that run as soon as they're installed and keep on running.

Choose the Interdata 5/16 with microbus architecture to communicate with terminals and peripherals via low-cost interface chips. The 6/16, king of the box computers. Or the 8/16E system, with up to 256KB memory and peripherals. And for even more power, take a look at our 32-bit line.

**Better delivery. 60 days ARO.**

To be successful in this business, first you have to have a computer to

be successful with. We deliver 16-bit Interdata computers in 60 days or less. Guaranteed.

Ask our competition if they can guarantee 60-day delivery.

**Better terms and conditions.**

We also write terms and conditions to make you successful. Like a 38% discount on orders of 100 or more units. Mix and match quantity discounts. Standard multi-year agreements. Spare parts discounts that save you money after the sale. And multiple ordering locations with no penalty for using them.

Ask your sales representative for a copy of our new super OEM agreement.



**A special OEM hotline.**

Agreements are fine. But the true test of a computer manufacturer is service. And that's where we really shine. We back up our local support people with a 24-hour OEM hotline. If you have a problem, one call gets us. Days. Nights. Weekends. Holidays. We're there whenever you need us.

**Find out how successful you can be. For free.**

So go ahead. Call us toll-free, (800) 631-2154. Or write Perkin-Elmer Data Systems Sales and Service, 106 Apple Street, Tinton Falls, N.J. 07724.

And, with a little luck and a lot of hard work, I'll be successful in my business and you'll be successful in yours.

Here is my card. Send me more information on:

- 5/16 computers  6/16 computers  8/16E systems  
 32-bit computers  terminals  mass storage devices.

**PERKIN-ELMER**  
Data Systems



# Bye, Bye D

**\$1795\***

## **A Perkin-Elmer CRT and a 100 cps thermal page printer.**

**If you buy a DECwriter after reading this ad, you deserve it.**

Our popular Pussycat Printer and Model 1100 Interactive CRT Terminal. Together, they do a lot more than a DECwriter III and cost less.

In fact, at \$1795, it's like buying a top-quality printer and getting a terrific little CRT free.

And what a CRT! The Model 1100 displays 80 characters per line in an easy-to-read 9 x 12 matrix and communicates at up to 9600 baud. Compare that to DECwriter III's puny 1200 baud.

Then when your results are ready, touch the PRINT key and the Pussycat printer lays down a whole screenful of characters in only 20 seconds. But, best of all, the CRT is ready for use again in 2 seconds or less. So the operator can go right back to work.

The Pussycat Printer is silent, too. And because you print only what you want, there are no mounds of unsightly printout around the machine.

Clean. Quiet. Inexpensive. The Pussycat Printer and the Model 1100 CRT from Perkin Elmer. Compared to a DECwriter III, they do more and cost less.



\* US domestic price, quantity 75.  
Model 1100 and Pussycat Printer: \$2795, quantity 1.  
Owl-1200 and Pussycat Printer: \$3695, quantity 1.  
DECwriter® is a registered trademark of Digital Equipment Company.



# Owlwriter!®

**\$2395\***

**A Perkin-Elmer editing CRT with  
line drawing and a 100 cps thermal page printer.**

You can also plug the Pussycat Printer into our Owl-1200 Terminal and have a powerful editing terminal with forms drawing capabilities and hard copy, too.

Draw forms or bar charts on the Owl, then print them on the Pussycat. The Pussycat even prints inverse video fields for highlighting charts.

The Owl and The Pussycat. Another great CRT thermal printer combo from Perkin-Elmer.

**Call (800) 631-2154, toll free, to order your Pussycat and CRT.**

For more information, write Perkin-Elmer Data Systems, Terminals Division, Route 10 and Emery Avenue, Randolph, New Jersey 07734, or telephone toll-free (800) 631-2154.

**PERKIN-ELMER**

**Data Systems**

Helping people succeed with computers.

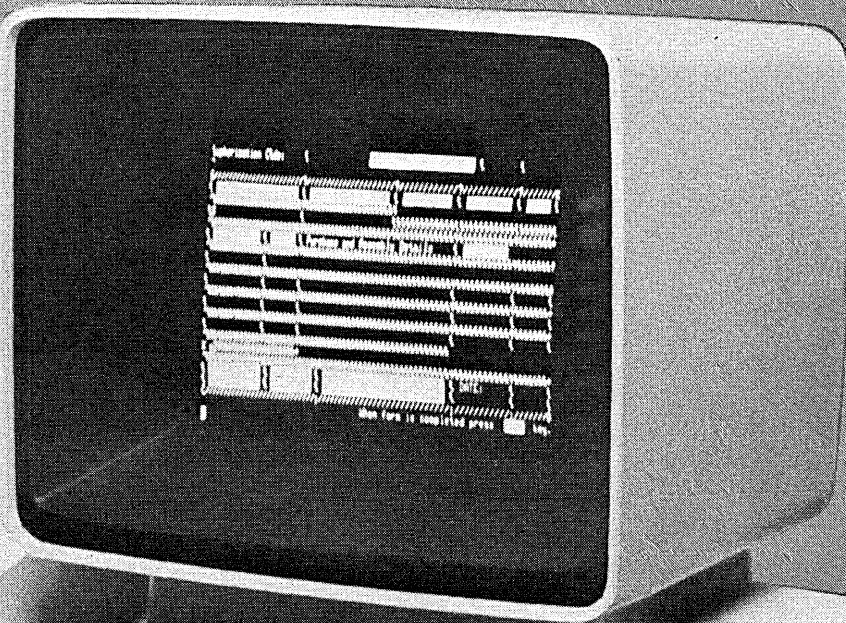

See us at NCC, Booth 2430, South Hall.



# The price you pay for success in transaction processing just went down.

## **Introducing the new Interdata Business Systems.**

At Perkin-Elmer, we are absolutely determined to make you successful in transaction processing. And we're totally convinced our new business systems can help.

For starters, these new systems from our Interdata Division have IBM-like architecture and COBOL. So your programmers and operators can go to work right away. With minimal training. And you go on-line sooner.

Then, to keep you on-line longer, we use only proven off-the-shelf hardware and software. Which means no long waits for delivery, fewer start-up problems and less trouble in the long run.

And, because we realize a business system is only as good as its software, we designed an incredibly good transaction processing software monitor. You can have as many as 32 users on the system at once. Background/foreground processing, file management and extensive utilities are also available. So you can access and rearrange data the way you do on your mainframe.

But, here's the best part, the best way to increase your chances for success, and the best reason to buy an Interdata business system.

## **We won't stop until you're successful.**

That's right. We'll do everything humanly possible to make sure you succeed.

We'll be with you when you configure your system. While it's being built. When it's delivered and installed. When it's up and running. And, for years thereafter.

When you buy an Interdata business system from us, we test it at our plant. And at yours.

So you get exactly what you order.

Then, we train your people to run their new system. And, for the first full year, we're there whenever you need us. Days. Nights. Weekends. Whatever it takes to make your project a success.

Think about that when you're evaluating transaction processing systems. Then, call Perkin-Elmer. And pay less for success.

For more information, write Interdata Division, 2 Crescent Place, Oceanport, New Jersey 07757 or telephone toll-free (800) 631-2154.

Here is my business card. Send me your free brochure "How to succeed in transaction processing."

**PERKIN-ELMER**  
Data Systems



# We can help you out with the ins-and-outs of in-house timesharing.

With an in-house timesharing system, you can give the other departments in your company what they're insisting on: faster response, broader capabilities, better service.

And with an in-house timesharing system you can satisfy management's insistence on holding down dp costs. Because an in-house timesharing system can actually pay for itself, by cutting current costs.

Especially if the system you install is the one built for timesharing installations: the BTI 4000 System.

It's made by us: Basic Timesharing Inc. We have a decade of experience in manufacturing timeshared systems. Experience enabling us to build a computer right for in-house timesharing.

The BTI 4000 is a true multi-user, interactive system. It can support up to 32 users concurrently, performing any mix of independent or related tasks.

It provides you with a powerful, yet easy-to-use programming language: BASIC-X, a greatly extended version of the familiar BASIC. Its added language and file handling features, plus editing and debugging aids, are a real aid in developing efficient programs, easily.

With a BTI 4000 you can put real computer power in your people's hands, keep full control in yours.

And because of the BTI 4000's unique hierarchal control features, you can actually segment off sections of the system, and dedicate them to specific departmental needs.

The BTI 4000 gives you the flexibility you need in systems configuration, too. User capacity can be expanded from 8 to 32 ports, in 8-port increments. Disk storage is available from 10 to 400 Mbytes, in 10 and/or 49 Mbyte increments. Plus add-ons like industry-compatible magnetic tape and

300 to 900 lpm printers.

And a BTI 4000 gives you the total system availability you want, because all software housekeeping can be done with users still on-line. The BTI 4000 can also do off-hours job-stream processing for you. And it does all this without a full-time operator.

An 8-port system with 10 Mbytes of disk storage and magnetic tape cartridge drive costs only \$35,950. Used during typical office hours, the operating costs for a BTI 4000, including maintenance, are about \$1 per terminal hour—even if you use it more.

And we support your system with an all-hours, every-day-of-the-year, on-line diagnostic service, so you can count on more use.

The BTI 4000. It's the in-house timesharing system that'll really help you out.

Get the complete details today.



## The BTI 4000.

Basic Timesharing Inc., 870 W. Maude Ave., Sunnyvale, CA 94086. Sales Offices: East: Cherry Hill, NJ (609) 662-1122; Midwest: Minneapolis, MN (612) 854-1122, Chicago, IL (312) 298-1177; South: Dallas, TX (214) 630-2431; West: Sunnyvale, CA (408) 733-1122, Anaheim, CA (714) 533-7161

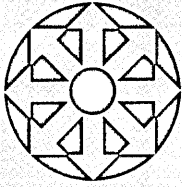

# LOOK AHEAD

## IBM'S NEXT PROCESSOR: A 3030?

IBM reportedly has leaked information in Norway on the next processor in the 303X line -- the 3030. This follows closely the recent pre-selling in Japan of its yet to come E Series. And of course the 3033 was leaked so much in Europe last year that IBM lawyers persuaded the company to announce it a few weeks ahead of schedule. The 3030, though more specifically a 370/148 replacement, will be competitive down to the 125 level, sources say. Possibly this model will be launched before yearend, perhaps even before E Series. E models are supposed to be 370/125 and 135 replacements that come with a stripped down, microcoded version of IBM's top-of-the-line MVS operating system to keep costs down.

Announcements rumored for 1979: New 3031 and 3032 cpu's with faster logic chips and microcoded high level language capabilities, and an enhanced 3033 and new file processors for the 303X line.

## FEDS UNDER FIRE FOR POOR ADP MANAGEMENT

Congressional computer czar Jack Brooks (D-Tex) and his cohorts on the House Government Operations Committee are armed for another round of hearings on the management and use of adp resources in the federal government. The congressional probers will be zeroing in on the federal government agencies' poor adp management practices in the second round of oversight hearings tentatively targeted for three to five days in June or July. A previous round was held in the summer of 1976.

In late April the committee sent out a detailed questionnaire to agency dp people who complained over having to mount such a big data collection effort to comply with the committee's request for information. To which committee staffers reply that the agencies won't have much digging to do since they won't have the information anyway.

To get better management at the agency level, the committee is expected to recommend legislation (probably in the form of an amendment to the Brooks Act) setting up a high level adp management team in each agency.

## CASH STARVED DATA 100 NOW SHOULD FLOURISH

Earlier this spring at a secret meeting in Washington, IBM's chairman Frank Cary gave Sen. Edward Kennedy a list of dp companies which were flourishing. Cary's point: to illustrate the viability of competition in the computer industry to the senator, who is chairman of the Senate Antitrust & Monopoly subcommittee. Now, one of the firms Cary named -- Data 100 -- has agreed to an acquisition by McDonnell Douglas Corp. Data 100's reasons for accepting the takeover, company insiders say, resulted from a lack of funding to finance growth. The Minneapolis-based terminal manufacturer's r&d effort was reportedly being "starved" because of insufficient capital and every time the firm went to the banks for additional money it would be hit with higher interest rates.

Now with McDonnell Douglas backing, Data 100 can further develop what products it does have on the drawing board: for example, a modern batch terminal, which will include a disc and is being put together in the U.K.

## AMDAHL VS. IBM IN DENMARK

Although Amdahl Corp. has been making inroads on IBM's monopoly in Denmark, it lost a crucial order at Denmark's biggest service bureau,

# LOOK AHEAD

Kommunadata, in an example of the length IBM is prepared to go to stop competition. Danish sources say the giant has broken sequential delivery on its European orders to push a 3033 computer into Kommunadata's Copenhagen installation five months before it was due. This follows an April 27 ultimatum from the bureau's president, Mogens Romer, that if IBM didn't bring the delivery date forward from February 1979, the order would go to Amdahl who said it could deliver a V 6 by August 1978.

Kommunadata, which has \$50 million to spend this year, already had ordered a 3033 from IBM for delivery this September, but couldn't wait until next spring for the second 3033 because, as Romer says, "we needed the capacity for our yearly runs." Romer says he gave IBM a one-week deadline after he returned from an April visit to Amdahl in Sunnyvale and IBM in Poughkeepsie. "We didn't see how they could deliver but they came up with the machine 15 minutes before the deadline expired."

I/S Datacentralen, Denmark's other big bureau, turned down IBM's 303Xs and gave Amdahl its first Danish order in January this year. Datacentralen continued to break into IBM's dominance by ordering a second Amdahl 30 days after the first was installed in April. Then a Danish savings bank consortium got in on the act with an order, and one source in Denmark says at least three more contracts are in the pipes before yearend. Apart from CDC machines at some Danish universities and one big department store, IBM is thought to account for 90% of the Danish market.

An IBM spokesman in the U.K. said the company hadn't broken its sequential delivery policy. He said the extra machine came about as a result of production increases at its Havant plant in the U.K.

## IS NCSS HAVING SECOND THOUGHTS ABOUT TWO PI?

National CSS, which has been touting the wonders of the IBM compatible 370/138 class machine it's acquiring from Two Pi as a means of entering the hardware market, is now reported close to signing with an alternate manufacturer. The candidate: National Semiconductor, which last month introduced its own 370/138 class chip. Also in the running: Magnuson Systems Corp. of Santa Clara, Calif., (p.242). NCSS claims it hasn't had any problems with Two Pi to date, but service industry observers speculate NCSS may be questioning the small oem vendor's production capabilities.

## BURROUGHS SOON TO HAVE NETWORK ARCHITECTURE

Burroughs Corp. this fall will announce its Advanced Networking Architecture aimed at customers who want to distribute their networks. The offering will allow customers to use its features at "their own pace and at reasonable prices." J. Roy Henry, Burroughs executive vice president of marketing, told a meeting of CUBE (Cooperating Users of Burroughs Equipment) the network will provide a high degree of flexibility in structuring fully distributed networks and that it is not a "me too" approach to networking. Put another way, "our network will not provoke a revolution in your operations," Henry told the users meeting.

## MULTIPLE 370s MAY BE ABLE TO SHARE DATA BASES

A traditional problem for many users with multiple 370s is the inability of the machines to share data bases. But now we hear that help may finally be on the way in the form of a backend data base management system being developed by the Cullinane Corp. of

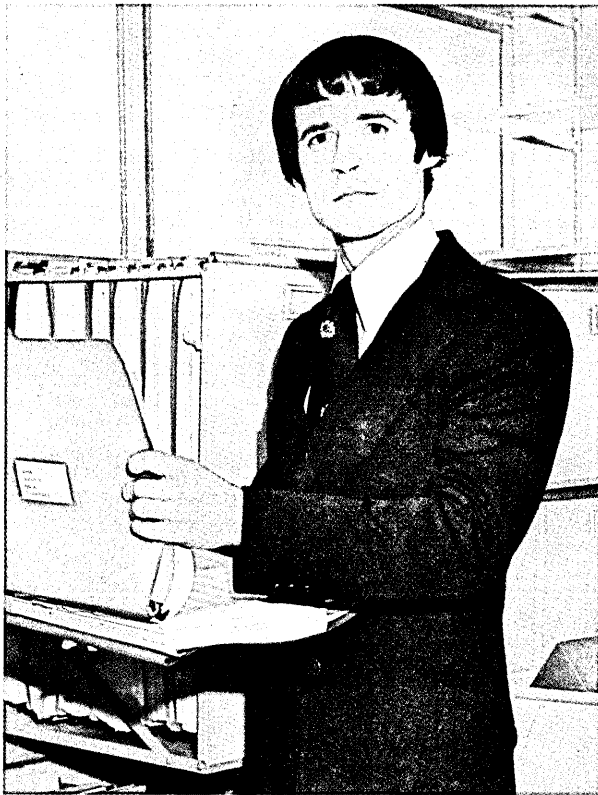

"When we first looked at MARK IV, we weren't even interested in acquiring software — we were just doing an evaluation of data base management systems. MARK IV sounded so good that we had to take a closer look. Because of the capability and productivity improvements it offered, we decided to go with it immediately.

"We've had such tremendous success with the system that we have made it the standard programming language — the only Cobol work we do now is maintenance of existing systems.

"We're extremely happy with the way MARK IV works with our data base. We installed IMS with DL/1, and that afternoon we were processing off the data base with MARK IV.

"An important part of our success has been in getting MARK IV out to our users. For example, the Director of Budget uses the MARK IV On-Line Query Language for evaluations and projections. Our Registrar people do the same with the MARK IV batch facility. When the user can get his own report out quickly, it creates immense satisfaction and reduced costs for all of us.

"As far as the productivity of my own programmers, I've found that what takes a week-plus in Cobol takes only a day with MARK IV. We're going to use MARK IV to do all the batch work.

"When people ask me what I think of MARK IV. I tell them they can't afford **not** to look at it. I am a firm believer in the results and benefits of MARK IV. It's one of the best pieces of software I've ever used."

**Get the facts about MARK IV.** MARK IV is the most versatile and widely used software product in the world for application implementation, data management and information processing.

Six powerful models (prices start at \$12,000) are in daily use on IBM 360/370, Univac 70/90, Siemens 4004, Amdahl 470 and Intel Advanced System computers at over 1,300 installations in 44 countries. Programs in MARK IV require only about one-tenth the statements of Cobol, and users report 60 to 90% cost and time reductions on most MARK IV applications.

# "MARK IV<sup>®</sup> is the best piece of software I've ever used!"

— Al Baker, Manager, Data Base Coordination and Administration Department, University of Georgia, Athens, Georgia

**informatics inc**  **Software Products**

World's Leading Independent Supplier of Software Products

Member SIA  Software Industry Association

Informatics Inc., Software Products, Dept. D 378  
21050 Vanowen St., Canoga Park, Calif. 91304

Name \_\_\_\_\_

Title \_\_\_\_\_

Dept. \_\_\_\_\_

Computer \_\_\_\_\_

Firm \_\_\_\_\_

Address \_\_\_\_\_

City \_\_\_\_\_

State/Province \_\_\_\_\_ Zip \_\_\_\_\_

Phone \_\_\_\_\_

Views expressed are those of Mr. Baker and not necessarily those of the University.



# How would you like a super-smart system with its own microcomputer and data storage? Meet George's friend, the Model-Twenty.

The newest member of George's family is pretty remarkable. In effect, the Model-Twenty is a small computer for dedicated applications or markets. It has impressive characteristics and it can do what a minicomputer can do. Even more importantly, it does it at a lower price.

Technically, the Model-Twenty system consists of an intelligent video display terminal with a floppy disk for storage, and its own microprocessor and operating system. It has a BASIC compiler that is 20 times faster than the typical BASIC interpreter. The microprocessor has a 16K RAM memory, and you can add memory expansion modules to expand it to a maximum of 64K.

Input is stored on dual density high capacity floppy disk units with twice as many data bits as usual (630,784 bytes). Several optional printers can be added, and a larger 1920 character VDT can be added if the standard 960 character terminal isn't large enough. The Model-Twenty is exceptionally flexible; it can have a little memory or a lot, comes as a desk or tabletop unit, and can have one VDT or many. And it has a mind of its own. Its system executive is a multi-tasking real-time program called MR EXEC, and it provides operator communications, basic file management, task scheduling, and data input/output.

What can the Model-Twenty do? Not everything, but a lot. One company is using several hundred units in



pharmacies, checking prescriptions, printing prescription labels, watching for drug allergies, and doing many other jobs. Another is planning to use several hundred units in an inventory control system covering many geographical locations. And the system has been configured as a reservation system for a chain of motels.

The key to your profitable use of the Model-Twenty is (1) the need for a dedicated application with an on-line data base, and (2) the desire for a low-priced unit. If that sounds like a situation you're considering, find out how the Model-Twenty can help. We'll work with you or we'll do the whole turn-key operation, whichever

you prefer. We're selling the Model-Twenty in minimum quantities of 100 units, and if you'd like more information call the National Accounts Manager, C.S.D. International Corporation, 513/494-5225.

We're ready to go to work for you.

## CSD International Corporation

Mason Road and Route #48,  
Lebanon, OH 45036

# Telenet is the data communications network you can call your own.

If an important part of your business depends on sending data from one place to another, you should know about Telenet.

Our business is supplying end-to-end communications for *your* computers and terminals . . . through public and private network systems.

Our common carrier network is already in place and ready for you to use without any capital investment in hardware or software. With Telenet you can cover the entire country (and a growing number of overseas locations, too). The network is only a local phone call away in over 150 North American cities. And if you have a large number of terminals in any one city, our new Private Packet Exchange Service makes using Telenet as economical as your own private concentrator and substantially more reliable.

## **Telenet is compatible with your present data equipment**

No need to set up separate networks to deal with each computer application. Telenet's public network is compatible with virtually all computers and terminals used for time sharing, data base inquiry, message processing and other interactive applications. Private systems, based on Telenet's own state-of-the-art microprocessors, can be tailored to handle higher speed applications as well, with no change to your present software or hardware.

## **A network that keeps up with tomorrow**

Networks have a way of becoming obsolete. Your needs change. Technology changes. Telenet's intelligent network systems are designed to grow right along with you.

Telenet was the first common carrier in the world to use advanced packet switching technology. With more than a decade of networking experience, we've advanced to our third generation network technology, designed to make both our public and private systems even more reliable and cost effective.

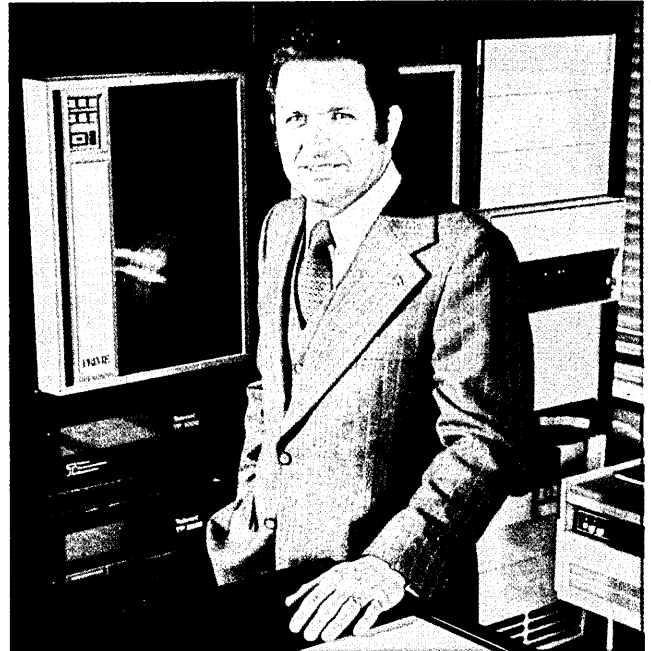

*Telenet's Vice President of Operations, Richard Furnival.*

We've led the way in creating standard protocols, such as X.25, which are now in use by packet networks throughout the world. Our continuing emphasis on development guarantees that your Telenet-based data communications network is as up to date tomorrow as it is today.

## **Telenet is the solution you've been looking for**

If your business relies on high-performance communications between computers and terminals in a number of remote locations, you should know more about Telenet.

Send for a free descriptive booklet today. It will convince you that Telenet really has the data communications network you can call your own.

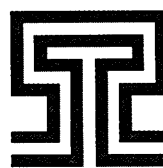

# **Telenet**

1050 17th St. N.W.  
Washington, D.C. 20036  
202/637-7900

### REGIONAL SALES OFFICES

Arlington, Virginia (703) 243-7510 • Waltham, Massachusetts (617) 890-0202 • Cherry Hill, New Jersey (609) 424-9550 • Chicago, Illinois (312) 782-6119 • Houston, Texas (713) 871-1243 • Los Angeles, California (213) 477-2048 • Menlo Park, California (415) 854-5845 • Newport Beach, California (714) 979-6064 • New York, New York (212) 594-6644

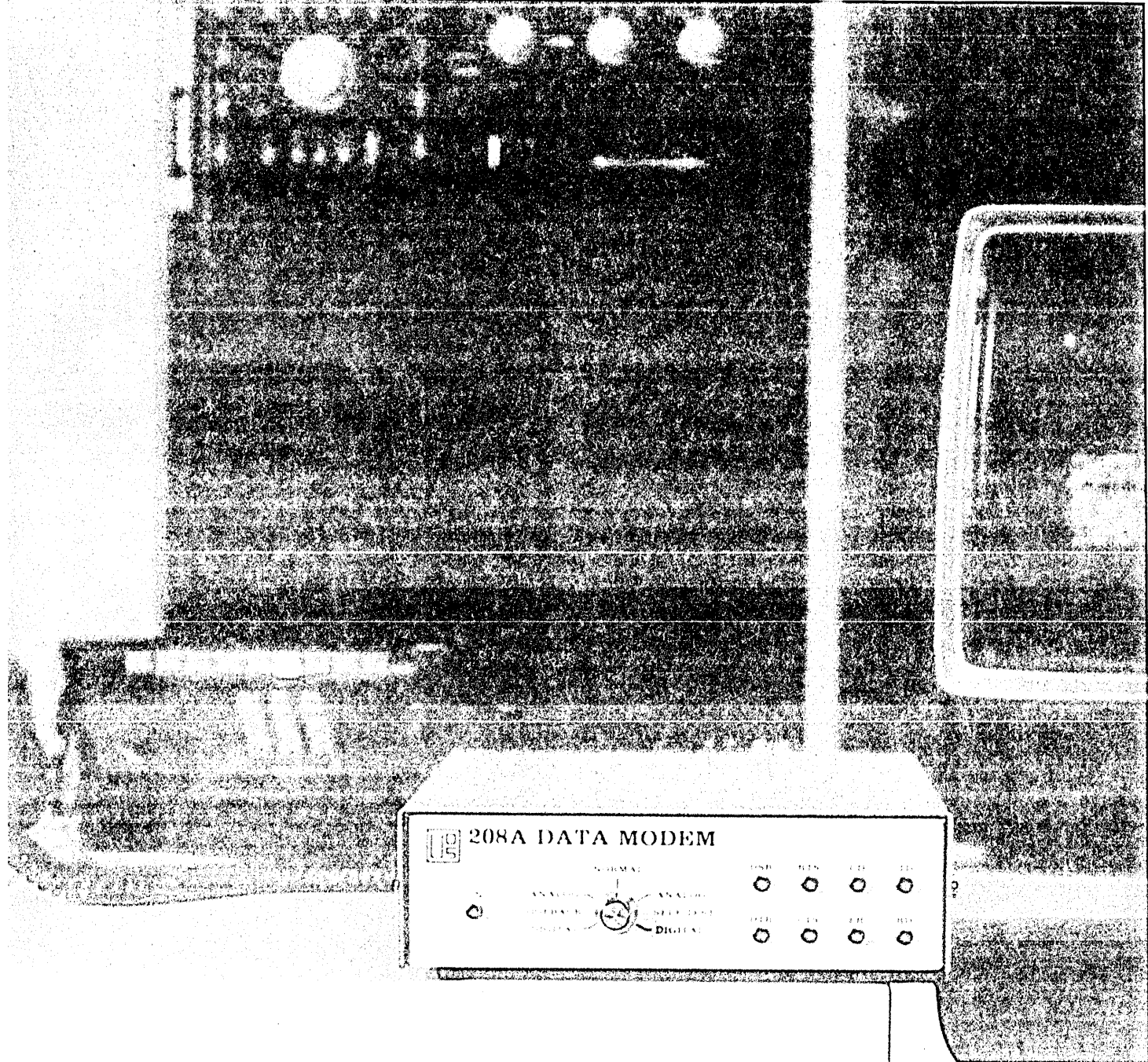

# UDS announces a 4800 bps Bell-compatible microprocessor modem.

UDS has leapfrogged current LSI technology with nanosecond microprocessor performance! All components are industry standards — no custom or single-source parts are used.

- **Bell compatibility.** Available in 208A (four-wire) and 208B (two-wire) configurations, one-third Bell's size.
- **Reliability.** A drastic reduction in total number of components results in a longer MTBF.
- **Multi-channel opportunity.** A 7" x 19" rack-mountable enclosure accommodates up to eight single-channel cards.

- **Cost/effectiveness.** Microprocessor power and innovative design make the UDS 208 your best buy for data communications at 4800 bps.

For further details, contact us at Universal Data Systems, 4900 Bradford Dr., Huntsville, AL 35805. Phone 205/837-8100; TWX 810-726-2100.

 **universal data systems** ICEMA  
Confidence in Communications



UDS has the ideal instrument for verifying data integrity in your communications system. It's the new COMTEST microprocessor-based network analyzer. It weighs only 24 pounds, it fits under an airplane seat, and it can give you complete confidence in your data communications network.

The COMTEST analyzer normally stores both EBCDIC and ASCII disciplines in its integral PROM modules. SDLC is available as an option. A keyboard input allows easy modification of these standard disciplines to accommodate your specific system checkout needs. In addition to half- or full-duplex network monitoring it can serve as an emulator for your CPU or for various terminal devices. It also has loop testing capability for verifying modem and line performance. Built-in self-test capability is also included.

COMTEST is designed for the ultimate in user convenience. Twelve basic commands permit you to verify the performance of your entire datacomm system. The data dialog is displayed, either in hex pairs or clear English test, on a 16-line, 512-character CRT. For complete confidence in your datacomm system, arrange a COMTEST demonstration. Contact Universal Data Systems.

**COMTEST  
MEANS  
CONFIDENCE**  
in your datacomm system



**UDS** universal  
data  
systems IBM  
4900 Bradford Drive, Huntsville,  
Alabama 35805 • 205/837-8100

# Does increased forms handling flexibility make Centronics' teleprinters the best?

**NO.** Even though Centronics' teleprinters now offer front feed in addition to top or bottom tractor feed, pin feed platen and pinch roll, they have much more than outstanding forms handling flexibility.

Centronics teleprinters can accept data up to 9600 bps under software or hardware control and have up to 7K of buffering for increased host efficiency, faster system response and lower line costs. There's "smart" bi-directional printing at 10 cpi for 132 columns or 12 cpi for 158 columns. Bilingual printing selected from 64 character sets. The finest dot matrix APL character set available today. Microprocessor control. Simplified modular design for superior reliability and ease of maintenance. And KSR and RO models in desk top or stand-mounted units. All at the price of most popular 30 cps printing terminals.

And as with all Centronics matrix printers, line printers and non-impact microprinters, the 761 teleprinters are backed by the largest worldwide service organization of any printer company. For complete information write or call Centronics Data Computer Corp., Hudson, NH 03051, Tel. (603) 883-0111.



**CENTRONICS® PRINTERS**  
**Simply Better**

# letters

## IBM on India

I am deeply concerned about the use of such words as "dumping ground" and "near-colonial exploitation" (even though attributed to unnamed "Indians") in your April article about IBM in India. Such characterizations are in conflict with the facts.

Rather than withholding advanced technology from India, IBM submitted numerous proposals to the Indian government in an effort to provide India with our latest computer systems. We consistently offered to import current systems to respond to customer requirements and government-sponsored tenders; however, the government allowed the import of such systems in only a very limited number of cases. In addition, in 1968, IBM proposed to the Indian government that our manufacturing capability in India be used for System/360 equipment; and subsequently we made a similar proposal regarding System/370. The Indian government never responded to these proposals.

The main issue in India was the Foreign Exchange Regulation Act (FERA). IBM submitted a detailed proposal in response to FERA and, for a time, we thought we had reached an accommodation with the Indian government. The government, however, ultimately insisted that IBM give up 60% ownership of its business in India.

Without the full ability to manage IBM India as an integral part of a high-technology company that must share resources and know-how across national borders, we could not conduct an effective business. Consequently, IBM was forced to change its operations there and, subject to Indian government approval, will limit its future presence to a liaison office.

RALPH A. PFEIFFER, JR.  
*Chairman  
IBM World Trade  
Americas/Far East Corp.  
North Tarrytown, New York.*

The author, Mr. McLellan, replies: Nothing in Mr. Pfeiffer's letter adds anything to the article's explanation of IBM's position, and he does not, unfortunately, choose to respond or comment on the statements and accusations I attributed to Indian businessmen and government officials.

## Third world computing

We certainly appreciate seeing the results of some on-the-spot reporting in the April News in Perspective piece "Why IBM Must Withdraw from India

in June" (p. 181). While we don't wish to defend IBM's business practices in India, we suspect that the current pressure being placed on IBM in emerging countries may result in considerably less than the desired results.

Success in information processing is directly dependent upon the access to the dp technology infrastructure which has evolved in the industrialized countries and is largely missing in the emerging ones. Frequently it is incorrectly assumed that the computer manufacturer is the source of this broad support base; manufacturers certainly contribute to this misconception through simplistic and unenlightened international marketing techniques. Unless this support is separately provided for, computers in emerging countries are destined for inefficient and ineffective use, regardless of IBM's business practices.

Our experience during the past four years we have been involved in migrating dp systems to the Third World has shown that implementors of dp systems in the emerging countries would be well-advised to retain the services of technical assistance contractors to compensate for the lack of a dp technology infrastructure. We are concerned that this critical void is being overshadowed by the current attack by emerging countries on the business practices of IBM.

W.D. HOWARD  
*President  
OMCI  
Westlake Village, California*

## Comparing significances

I assume that the next question Mr. Blaylock (author of "Comparing Language Performance," April, p. 119) will attempt to answer is "How many angels can dance. . . ?"

Hardware costs have astronomically decreased since the early days of computing and every indication is that this trend will continue. On the other hand, people costs have increased dramatically, with an unmatched productivity increase. Thus the significant questions when comparing programming languages deal with speed and ease of program and system implementation and maintenance, not the number of cpu seconds saved over the life of a program.

ALAN. J. NOIA  
*Allegheny Power Service Corp.  
New York, New York*

Mr. Blaylock replies: I agree that Mr. Noia's questions are significant; as I said in the conclusion of my article, "Detailed analysis of results should be expanded to include compile times, memory requirements, number of lines of source code, and time required for coding and debugging." The work done in my experiment with reference to execution time is also significant, however,

in that it allows comparison between characteristics of a language itself and the use of a compiler.

## Disbeliever

I was greatly disappointed in the article "Comparing Programming Language Performance." It turned out to be an indication that compilers written for the Univac 1108 suffer from a serious lack of quality control. It is beyond reason that a given COBOL compiler can take three times as long as a second COBOL compiler to execute "Functions by Fractions" and also be twice as fast as the second compiler in executing the "Simple Grammar Analyzer."

CHRIS CODDINGTON  
*Rowland Heights, California*

The author replies: I wasn't shocked at the disparity between compilers—but then nothing about compilers would shock me anymore! Univac 1108 compilers may suffer from lack of quality control, but only in that no compiler is free from bugs; in the research on which my experiment was based, the "Tower of Hanoi," performed on an IBM 360, turned up results, particularly with the ALGOL compiler, that were just as dispersed.



## Pro and con the tremulous trio

Captain Cobol (April, p. 148) is very good. That format would even work for fiction.

GENE USDIN  
*Southwestern Computing Service, Inc.  
Tulsa, Oklahoma*

"The Case of the Insidious Doctor Grouch" was in poor taste and certainly not of the quality I have learned to expect from DATAMATION.

In your April 1977 issue, you posted a modest reward for the return of Laton McCartney. If he disappears again this year, I suggest you keep the money. Seriously, we hope you will give serious thought to the type of image you want to have in this industry and not publish such trivia in the future.

W. L. IRONS  
*Director, Planning & Support  
The Williams Companies  
Tulsa, Oklahoma*

Super satire! Of course I refer to the newest happening in the computer business—our own comic book in the April



# letters

issue.

It's neat to meet our old friends in their slightly changed guises; Herb G. never looked more villainous, Adm. Grace never looked more nautical, Frank C. certainly looked proper in his white shirt, Jimmy C. looked as friendly as ever, Bert L. displayed his quiet direction of things, and Z.Z. seemed interested in what was going on around him. Let's have more. There must be other computerized dragons our tremulous trio can tilt at!

LARRY G. LESLIE  
Corporate Time-Sharing  
Administrator  
The Upjohn Company  
Kalamazoo, Michigan

I enjoy DATAMATION both for its technical content and for its awareness of the relationships between people and computers.

My usual joy was jarred by the juvenile adventures of Captain Cobol. I was chuckling as I scanned it until I saw Anita Bryant grouped together with Communists and Darth Vader. In my judgment she is a heroine of extraordinary stature. I am disappointed that

your cartoonist had the poor judgment to misuse her name in that manner.

JOHN K. MICKELSEN  
General Electric Company  
Heavy Military Electronics Dept.  
Syracuse, New York

Please have "The Insidious Dr. Grouch" contact me immediately!

SARA A. COOPERRIDER  
Director of Data Processing  
The Unification (Rev. Moon's) Church  
New York, New York

McCartney, Harrison, "Big Mac": GENIUS! Your publication now has "redeeming social content." If this is a "one-shot" I'll abend—let's see more adventures with Captain Cobol, Micro-Maiden (what peripherals!!) and Tech Weeny.

KERRIGAN CUSHING GRAY  
Professional Staff  
Informatics, Inc.  
Portland, Oregon

### More on paperwork

I read with interest Mr. Knox's letter captioned "9,453,600 Papers to Shuffle" in your September 1977 issue.

I also read the responses in the November and December issues, and I noted that both responses bypassed setting the facts straight regarding the

rated speed specifications of the IBM 3800.

The IBM 3800 processes paper at a rate of 31.8 inches per second, not at a rate of 31 feet per second. This in turn leads to calculated rates of 160 feet per minute and 9,600 feet per hour, as opposed to Mr. Knox's stated rates of 1,860 feet per second and 111,600 feet per hour respectively.

However, I noted that the balance of Mr. Knox's calculations are quite accurate since he used a rate of 13,130 forms per hour, which reduced to a paper processing rate of 31 inches per second for the IBM 3800 (the exact rate would be 13,552 forms per hour).

Notwithstanding Mr. Knox's calculation, I would like to substitute his conclusion with my own: "Paperwork expands according to user requirements, not according to the means available for its production."

F.H. HAWKINS  
Computer Development Specialist  
British Columbia Hydro and  
Power Authority  
Vancouver, British Columbia

### Readers of fine print

In the illustration on page 214 of the March issue the child doing his homework has made a mistake—the Battle of Hastings took place in 1066, not 1060 as the drawing shows.

Congratulations to the artist if his purpose was to catch the reader's eye.

DOROTHY BOTNICK  
Public Relations Writer  
University Computing Company  
Dallas, Texas

While complimenting you on the accuracy of your arithmetic I have to tell you that the Battle of Hastings actually occurred in 1066!

M.D. WRIN  
Director  
Standardgraph Sales Co. Ltd.  
Chislehurst, England

### Correction

In the March issue Vydec, Inc. is listed on p. 114 in the Communicating Word Processors, Vendor Index as having the address 130 Algonquin Parkway, Whippany, NJ 07981. The correct address, which became effective May 1976, is: 9 Vreeland Road, Florham Park, NJ 07932.

CAROLE MASONBERG  
Advertising Dept.  
Vydec, Inc.  
Florham Park, New Jersey

### Old computers never die . . .

Your mention of old Burroughs B5500s in the March issue (p. 232) prompts me to write about the UCSC home for old B5500s. We have two of them. The first

(Continued on page 31)

## Digital cassettes.

Quantities in stock for 24 hour shipment . . .

call toll free: 800 225-8715.

Kybe manufactures "Accutrack" cassettes for virtually any data or power typing system.

ANSI, Sycor, Datapoint, Burroughs, DEC, others.

Kybe cassettes . . . the choice of OEM's for years. They're all precision built; all certified error-free; and all backed by a supplier you can count on.

Call now for details, prices and fast delivery.



Dealer inquiries invited.

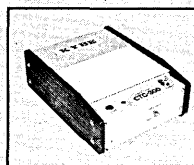

Kybe's CTC-300 cassette tape cleaner — part of a complete family of products for maintaining cassettes, magnetic heads and transports.

# DP Dialogue

Notes and observations from IBM that may prove of interest to data processing professionals

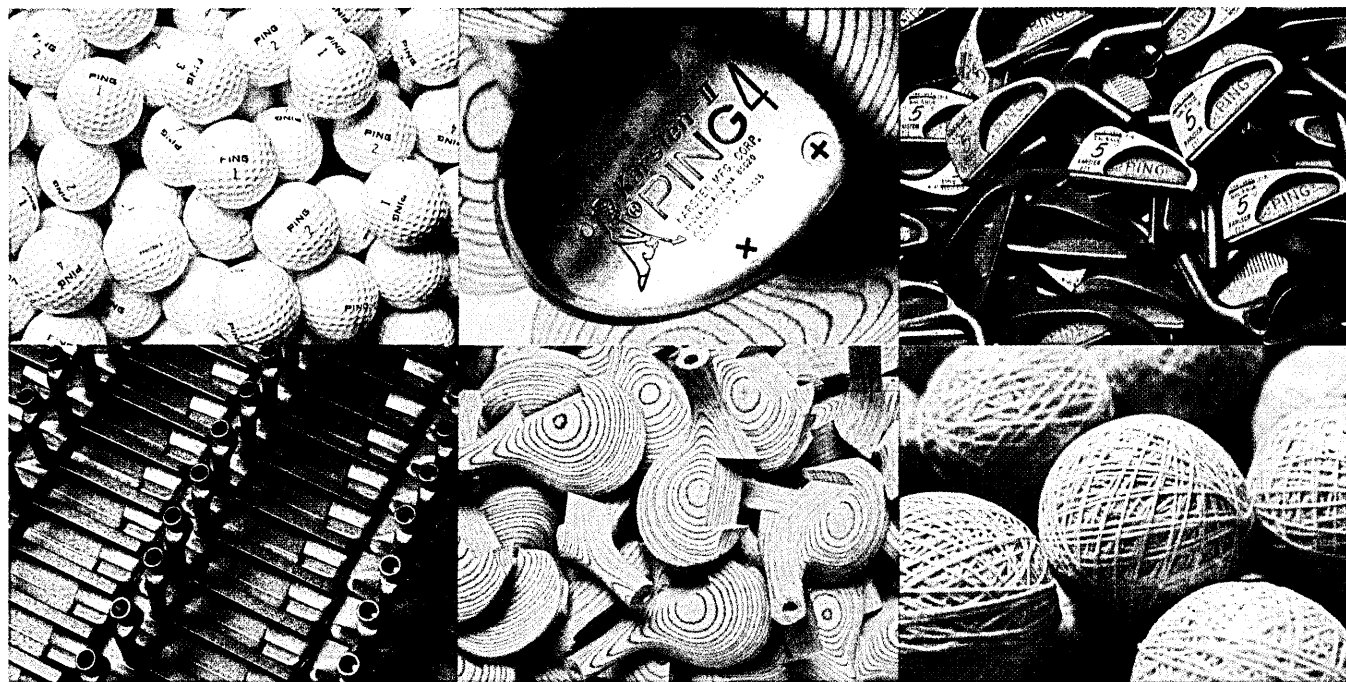

## DMS Tees Up Online System Fast for Karsten

Karsten Manufacturing makes professional quality golf clubs, highly custom-configured to the physique and style of each golfer. Such individualized service has made online order entry the company's most complicated computer application. A clerk enters extensive and detailed orders by touching a light pen to the screen of an IBM 3277 Display Station, using one or more of 20 different display formats.

Yet the order entry system was written and installed in the company's System/370 in six weeks. William Gingerich, data processing manager for the Phoenix-based manufacturer of golf balls and clubs, attributes this to the use of Display Management System (DMS).

An IBM program product, DMS converts information from a fill-in-the-blanks form directly into executable programs. It generates and displays user-defined screen formats, processes terminal transactions, and accesses an

existing data base or one newly defined under DMS. Screen formats can be revised and new ones added quickly and easily, without reprogramming.

"DMS gets a screen up in a few days," says application programmer Catherine Boyd, "I specify a format by making entries on a preprinted form. As soon as this is keyed into DMS, the screen is available at the 3277. It's equally simple to program the flow from one screen to the next within a transaction—from order entry to credit check, for example."

"We make heavy use of the 'browse' functions in DMS," adds Gingerich. "Order clerks identify a customer account by entering a partial name, a zip code, or the name of the pro shop through which the clubs were ordered."

"Applications involving data-base inquiry are particularly easy to write with DMS," he continues. "In less than a day we wrote a program that makes inquiries against our payroll file."

The company was launched by Karsten Solheim, an engineer, after he developed the "Ping" putter, a golf club famous for its accuracy. Not much more than a decade old today, Karsten Manufacturing acquired its first System/370, a Model 125, in October 1974 and its present Model 138 in May 1977.

"Inventory management is a challenge in this business," notes Louis Solheim, Karsten's son and vice president of the company. "There are many variables in a wood club: swing weight, face orientation, shaft style, model and type, for example. Since it takes two months to process a wood through manufacturing, we need close control to have the required heads available."

"The inventory control system," adds Gingerich, "was written by one person in three or four weeks. DMS makes implementing an online system, using multiple screen displays, at least as easy as writing a simple batch application."

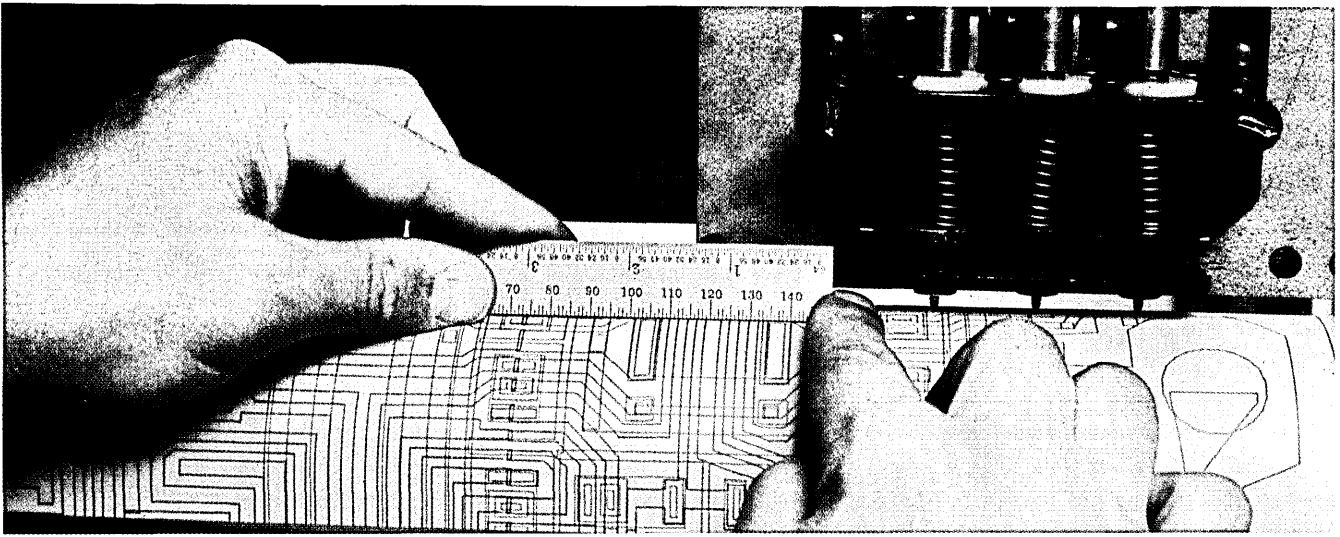

*When computer-aided design of the integrated circuit chip is complete, a computer-driven plotter draws a three-color layout of the circuit in large scale.*

## Computer Designs and Fabricates Computer Circuits

Today's high-speed, high-capacity computer systems depend on advanced electronic devices using Large Scale Integration technology. This micro-miniaturized circuitry puts thousands of memory or logic circuits into a space a quarter-inch square or less, making possible speeds of billionths of a second.

At IBM's General Technology Division facility in Burlington, Vermont, the computer itself is instrumental in the design and production of these advanced semiconductor devices. Engineers there are using a System/370 Model 168 and IBM 2250 Graphic Display Terminals to design and produce the high-precision photo-masks that are critical to the fabrication of integrated circuit "chips." Intricate patterns are successively overlaid using a lithographic process to build a

finished chip containing thousands of individual memory cells.

To create a tentative design for a mask, an engineer draws lines with a light pen directly on the face of a graphic display terminal connected to the Model 168. The system automatically resolves the sketch into a precise pattern of straight lines and geometric shapes.

"It's easy to move elements around on the screen, trying alternative layouts until we find the optimum use of the space available on a chip," says Paul Serednick, manager of computer-aided graphics. "We can rapidly try so many alternatives that we are finding much more efficient layouts than we ever could manually on a drafting board.

"Since the finished device usually consists of one memory cell pattern re-

peated many times," Serednick adds, "the engineer can develop it once in detail. The system then replicates it the required thousands of times, automatically rotating it, generating mirror images and adding interconnections.

"Perhaps most significant, though, is that the computer generates a tape that guides automatic production of the mask itself in the final size. Previously, we had to draft the design by hand, and then use it as a guide in the preparation — also manual — of an oversized mask.

"Any change forced us to start over again from the beginning and repeat the manual process. Now we can go back at any time and make a change or improvement in the mask design. We can accommodate an engineering change in minutes instead of weeks."

---

## Preserving the Heritage of the Palmetto State

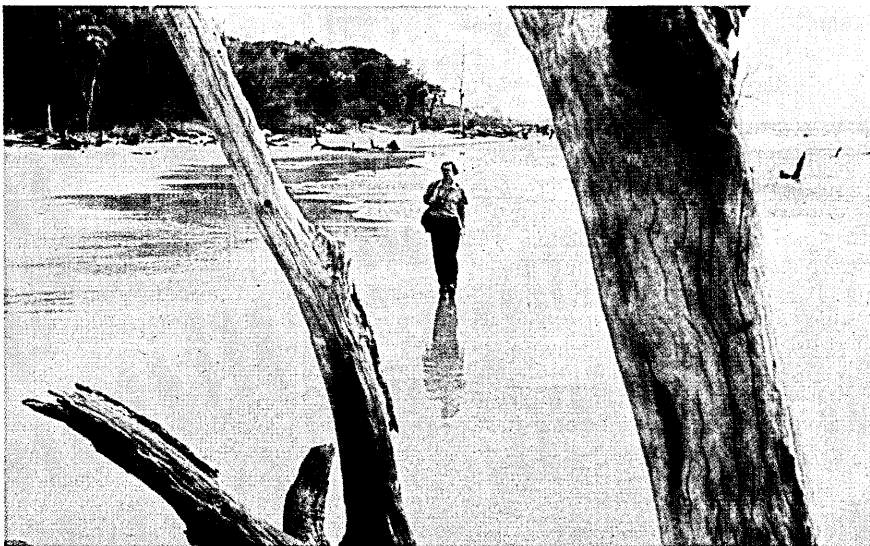

In a program to preserve its irreplaceable natural resources, the state of South Carolina has collected data on more than 400 sites, ranging from the breeding grounds of the rare loggerhead sea turtle to stands of timber more than 400 years old.

"In South Carolina, we are very proud of the beauty and heritage of our state," says Dr. Wayne Beam of the Wildlife and Marine Resources Department, "and we want to preserve it for future generations. Now we can make recommendations on land use permitting development compatible with conservation of natural resources.

"The value of the program is in rapid

*Marine Biologist Chick Gaddy  
on Caper's Island, east of Charleston,  
South Carolina.*

# DL/1 Runs 'A Dozen Systems in One' for Portland

"Our OCP service has built Portland into one of the largest shipping ports on the Pacific Coast."

Gabriel Vallicelli, director of finance and administration for the Port of Portland, Oregon, explains that Import Cargo Distribution/OCP (Overland Common Point) refers to the common point of entry of freight en route to widely separated inland destinations.

"For shippers using the service, we act as their inventory managers and physical distributors in the U.S. We break down their container loads, warehouse their goods and ship to their destinations over much of the U.S.A.

"Many of our biggest shippers could use other Western ports at the same freight rates, but our OCP service saves them money by relieving them of those chores here."

The port agency has placed control of inventory and physical distribution for OCP operations on its computer, using Data Language/1-Entry (DL/1-Entry), a data base management system for smaller IBM System/370 installations.

"The huge variety of products we handle presents us with difficult system design and implementation problems. One shipper identifies merchandise by serial number; another follows a 'first-in first-out' policy and specifies goods by volume or weight. The structure of each inventory record and bill of lading is different, and some of them change frequently. It's like running a dozen different inventory control systems in one."

The system was designed so that personnel can query the data base in the System/370 Model 125 from a terminal

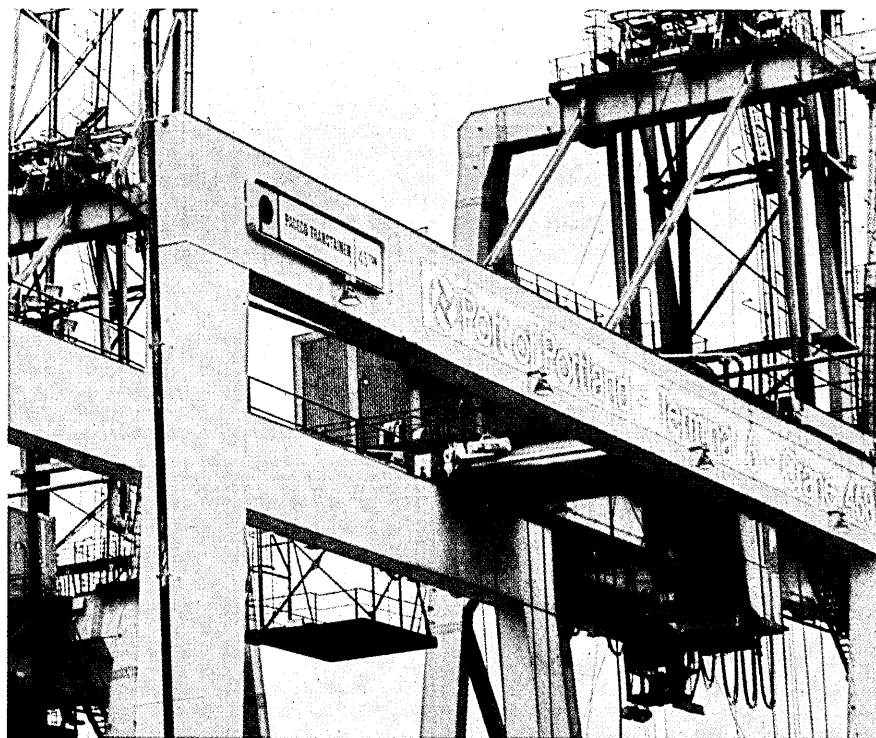

*These huge cranes are specially designed to unload containerized freight. Pacific Ocean vessels sail 90 miles up the Columbia River to Portland, Oregon, to use the ultramodern facilities operated by the city's shipping authority: the Port of Portland.*

to answer a customer's questions about a shipment. It can identify the truck carrying it and tell him where that truck is. The system is currently being expanded to identify the location of items in the warehouse.

DL/1-Entry allows for handling variable-length records and such wrinkles as breaking up a shipment and

"drop-shipping" or delivering directly to customer's customers.

Without reprogramming, by using simple data-base entries, handling of any customer's inventory can be changed to add or remove data segments from his record structure.

"Since OCP is a marketing tool, special service to the customer is vital," Vallicelli notes. "We've attracted business that used to reach the East by the Panama Canal. In fact, we have so much OCP business that we have built a \$14 million warehouse just to handle it."

"Yet, even without counting all the additional containers it has attracted to Portland, OCP is earning money for us now as a separate profit center."

pinpointing of needed information," Beam continues. "We generate hundreds of thousands of characters of new data each month in our field survey work. There is no way to handle a state-wide assessment like this and have it do anything but sit in the files unless it is automated."

Areas surveyed contain rare or endangered species of plants or wildlife, unique and outstanding natural features, historical sites and buildings. Complete information for each location is entered into an IBM System/370 at the University of South Carolina. The goal is to provide the data that planners need to assess the impact of future development.

Accumulated details on animals of special ecological significance include all their feeding and habitat requirements, their geographical distribution, the environmental limits they tolerate and their breeding and nursery areas.

The program is called Heritage Trust and was developed in collaboration with The Nature Conservancy, a privately funded organization based in Arlington, Virginia, which is working with other states on similar programs.

Beam adds: "By doing keyword searches we can quickly compile a list of all locations where the gopher tortoise has been sighted, or other such extracts. And using the computer we can do analytical work—correlating such factors as size and fecundity, to help improve commercial fish harvests."

"We recognize that we are a growing and developing state and must make the most effective use of our land from an economic as well as an ecological standpoint. The computer will give us the capability to compare sites, assess their relative importance and decide which areas contain unique values that should be preserved."

*DP Dialogue is designed to provide you with useful information about data processing applications, concepts and techniques. For more information about IBM products or services, contact your local IBM branch office, or write Editor, DP Dialogue, IBM Data Processing Division, White Plains, N. Y. 10604.*

Data Processing Division



# Announcing Control Data's Multifunction Terminal, new for stand-alone and distributed processing

There are dozens of terminal manufacturers. And hundreds of models offered. But only a handful of companies offer a powerful user-programmable intelligent terminal that can operate both as a stand-alone processor and as a remote station for your IBM 360/370.

We call it a Multifunction Terminal because it can do so many things. Forms generation and entry. Accounts receivable or payable. Data entry. Inventory control. Inquiries. In a stand-alone mode or as a remote station.

We designed it to be easy to use. Our interactive forms language "coaches" non-technical personnel. And your more technically-inclined employees will appreciate the features of our advanced and business-oriented BASIC.

Extensive diagnostic programs are built into the terminal. Most are entirely automatic—a ROM-resident diagnostic executes on power-up and system-reset to check processor, memory and path to the flexible disk. Other built-in diagnostics provide more comprehensive memory and communications tests.

The final diagnostic works with an online test residing in the host processor.

## Benefit from Control Data's experience

More than 15 years in remote computing. More than 13 years of experience in human-engineering and manufacturing terminals. And we design and make not only the display station, but also the floppy disk drives and matrix printer.

More than 4,800 Control Data Customer Engineers in our worldwide maintenance organization support our products.

Control Data's Education Company offers training courses for all levels of your personnel. And our Professional Services Division offers consultation and programming for your applications.

Even financing for your terminal purchase is available through Control Data's financial subsidiary, Commercial Credit Company.

So look to Control Data to help you implement your distributed processing strategy. For more information on our Multifunction Terminal, call 612/482-4379.



Larry Eaton  
General Sales Manager  
Miniperipherals/Terminals Division

**GD** CONTROL DATA  
CORPORATION

**More than a computer company**

# Technical Overview of Control Data's Multifunction Terminal

Basic hardware comprises a keyboard display, one or two flexible disk drives and a matrix printer. Software includes an operating monitor, peripheral drivers, system job functions, system utilities, file manager, a forms language and BASIC.

**Keyboard display.** 2000 characters on 25 lines with 80 characters per line. Each character is generated from random-access refresh memory as a modified 7 x 9 dot matrix. Detachable keyboard.

**Flexible Disk Subsystem.** Consists of one or two drives that use standard single-side, double-density disks. Capacity is 0.5 Mbyte formatted storage per disk, 1.0 Mbyte total.

**Matrix Printer.** The optional printer accepts single or multipart paper, prints bidirectionally up to 132 characters per line at 70 lpm. Compressed print option.

**Controller.** A microprocessor-based controller in the display unit includes: ROM; up to 64 Kbytes of RAM; communications controller; peripheral controllers and keyboard display controller.

**Forms Language.** An extensive, operator-programmable forms language. Operator "coaching" appears on the CRT screen.

**BASIC Language.** Business-oriented, with features like: 14 digits precision; sequential, indexed and index-linked file I/O; character strings of up to 255 bytes; variable identifiers of up to 6 characters.

**Communications.** The terminal communicates with a host processor using Binary Synchronous (BSC) communication protocol. The system provides for auto answer and auto disconnect to allow the system to be polled while unattended. Speeds of 1200, 2000, 2400, 4800, 7200 and 9600 bits per second are supported. Protocol-compatible with the IBM 2770, 3770 or 3780. EIA RS-232-C Interface.



More than a computer company

June, 1978

## letters

(Continued from page 26)

was a gift from Burroughs, and the second was donated by First National Bank of San Jose. Both are under in-house maintenance and are operated self-service to give cheap computing to those who don't have the funds to use contract-maintained and operator-serviced equipment. We in fact intended to use the second machine only for parts to keep the first one going; but the first got to be busy enough at times to make a second machine useful. Aside from the low-budget users, we find mainly two kinds of work being done on the machine: large or long-running FORTRAN jobs, and large interactive ALGOL jobs. Because of the multiprogramming capability a user can drop in a two-hour FORTRAN job, see it through compilation, and then come back later for the execution results. Any other user meanwhile needing quick turnaround can simply push down the priority of the long job and get the response he needs. This is logical enough; but we can't allow two-hour jobs to run very often on our 256K 360/40 because it is unable to multiprogram, so a two-hour job means two-hour turnaround for everybody. In practice, the sponsor of a two-hour job would get at most one run per day on the 360; while on the B5500 he might get 3 or 4. (Also, he gets as many runs as necessary to get through compilation; while the 360 operators can't let a job start if it is estimated to take two hours.)

Because of virtual memory the B5500 can run larger jobs than the 360/40 can. FORTRAN users say that the B5500 compiles about as fast as the 360 under WATFIV, and executes about as fast as the 360 under the IBM FORTRAN compiler. For some users the B5500 is substantially faster than the 360 because the 48-bit word of the former allows them to dispense with double precision that would be required on the 32-bit 360.

Although it's a wonderful batch machine, the B5500 is a crummy time-sharing machine; this is not surprising in that time-sharing wasn't invented yet when the machine was designed. Our time-sharing use of the B5500 is very peculiar; typically only one or two users at a time running very large jobs. We use a couple of PDP-11 systems for the more ordinary kind of time-sharing jobs; but the B5500 can handle much larger jobs than the PDP-11 can.

Reliability has been generally satisfactory, although there are periods of flaky operation that come and go without the cause of trouble ever being located. One of the machines did choose to catch on fire the very day I left on a three-week vacation. Obviously this

would be intolerable if the B5500 were our only computer; but the kinds of people who use it can work around even a three-week outage. Now that we have the second machine there is somewhat less likelihood of a total outage for a long period. The innate perversity of inanimate objects is such, however, as to cause simultaneous outages more often than mere probability would predict.

Software maintenance these days is pretty much the responsibility of the machine owners. I don't believe Burroughs is working on it anymore, except perhaps for what can be done on-site. This situation is much like that with the Bell Labs UNIX system; in both cases, every site has its own collection of software patches that fix bugs or add features, and these get circulated through the grapevine to all sites. We have some software patches that apparently originated at Monash Univ., Australia, and reached us after traveling through Univ. of South Africa,

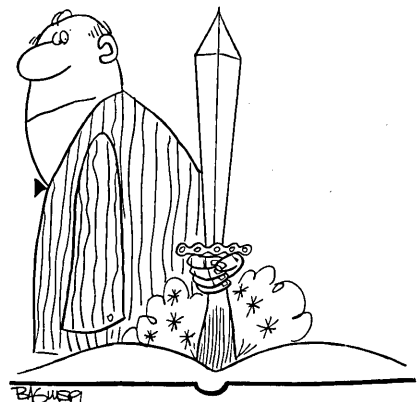

Natal Univ. in South Africa, Heriot-Watt in Edinburgh, Brock in Canada, and perhaps Drexel in Pennsylvania. There don't seem to be that many software bugs that bother our users. I guess by the time a software system gets as old as this one is the bugs are either worked out or are so deeply imbedded as to be beyond hope.

Most users seem to feel that the B5500 is so much fun it's a pity that it is so obsolete. We don't have any specific future plans for the machines, except to keep them going as long as there are still users for them. Even if we could afford to buy a new big machine we would need a way to accommodate the low-budget users. We use the B5500s in much the same way that BYU uses its STRETCH (I hear you're going to run a story on that machine someday), and we may well be someday the home of the last B5500 in working order. Based on the usage (highly variable) and the cost of maintenance and supplies (practically fixed) we figure that our users are getting computing for \$10-\$15 per cpu hour.

JIM HAYNES  
Felton, California



# Announcing a fabulous Full language ANSI 77.

To have a non-stop FORTRAN, you must have a non-stop system. And only Tandem has it. A unique multiple processor on-line system which ensures protection of the data base, and that no transaction is lost or duplicated, even if a processor, I/O channel, disc controller or disc should fail. The system keeps running, and so do your FORTRAN programs, even if one of those failures occurs.

## Multiple Processor FORTRAN. Fast.

Tandem FORTRAN runs on the Tandem NonStop™ System, the only multi-processor system designed from scratch for NonStop, transaction-oriented, data base applications. And because Tandem FORTRAN runs under our Guardian Multiple Processor Operating System, no custom software is required. Our FORTRAN utilizes all of our Guardian Operating System features including NonStop operation, re-entrant code, inter-processor communications, virtual memory, and ENSCRIBE data base record management facilities for keyed, relative and sequential access, multi-key data paths, and concurrent record access. Our benchmarks show our FORTRAN to be exceptionally fast, and fully capable of running in a multi-language environment without penalty.

Tandem NonStop FORTRAN conforms to full language specifications of ANSI FORTRAN, X3.9-1977. There's no necessity to deal with subset language specifications. Extended features include RECORD Structures for data base compatibility as well as complete facilities for Interprocess Communications. Firmware support of both extended and standard Floating Point is provided in addition to a host of Extensions which capitalize on Tandem Computers' unique NonStop operation. Six data types are supported, including LOGICAL and CHARACTER. Operators can be arithmetic, character, relational or logical. And Specification Statements include IMPLICIT, PARAMETER, INTRINSIC and SAVE as well as all the usual facilities in each of these categories. Noteworthy among our Control Statements is Block IF. It's FORTRAN as never before.

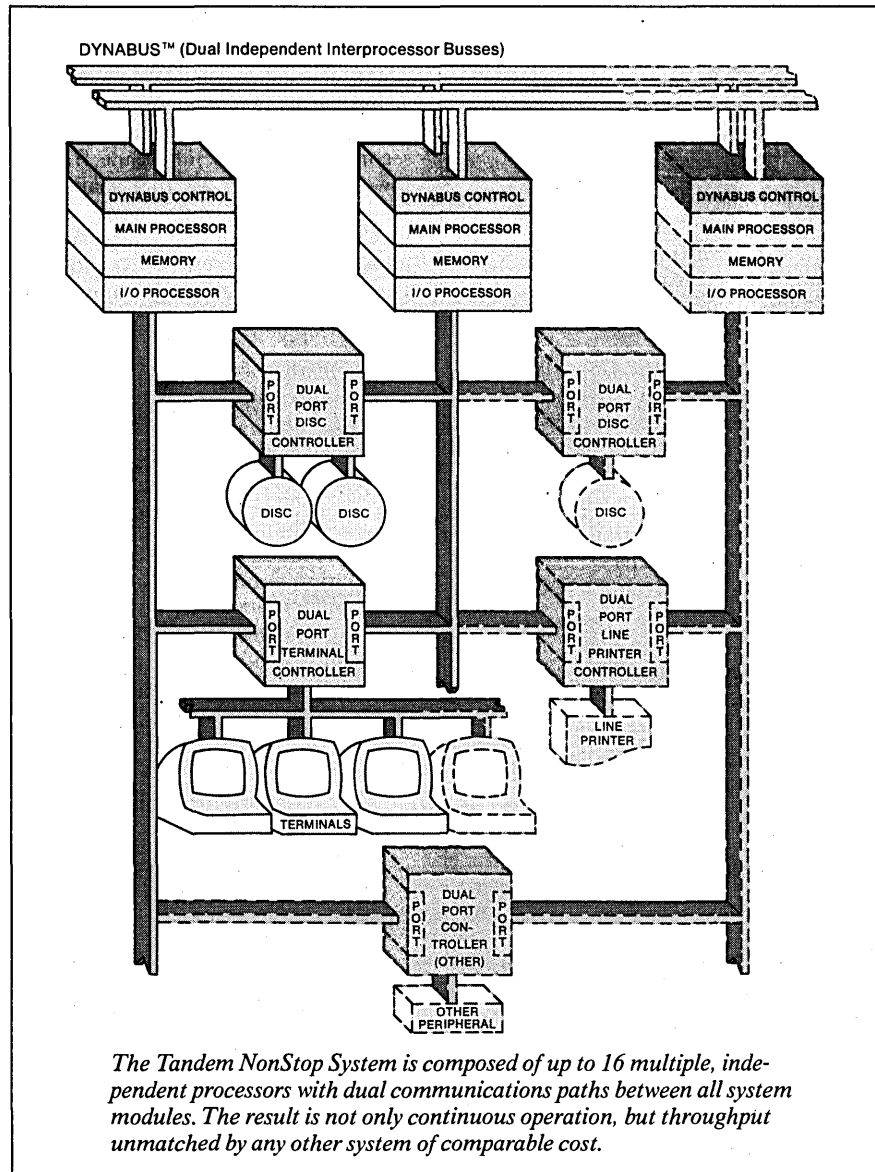

**With STARTBACKUP and CHECKPOINT.** These functions allow our FORTRAN to utilize the NonStop capabilities of our Guardian Operating System. STARTBACKUP is called once at the beginning of a program to establish the NonStop mode. Thereafter, CHECKPOINT is used to pass critical information to the backup process. Checkpoints will automatically occur upon any OPEN or CLOSE after the backup has been created. With STARTBACKUP and CHECKPOINT, Tandem's Nonstop FORTRAN is freed from the downtime, restart and revalidation which

plague the user of any other FORTRAN.

**Structures for Record Definition.** The constructs RECORD and END RECORD are used to define record structures in Tandem FORTRAN. And Data Definition Language may also be used to transcribe a schema into FORTRAN RECORD structures.

**Data Base Record Management.** Extensions have been made to the Tandem FORTRAN READ and WRITE statements to permit the full use of our ENSCRIBE Data Base Record Management facilities. This



# first in FORTRAN. And it's Non-Stop!

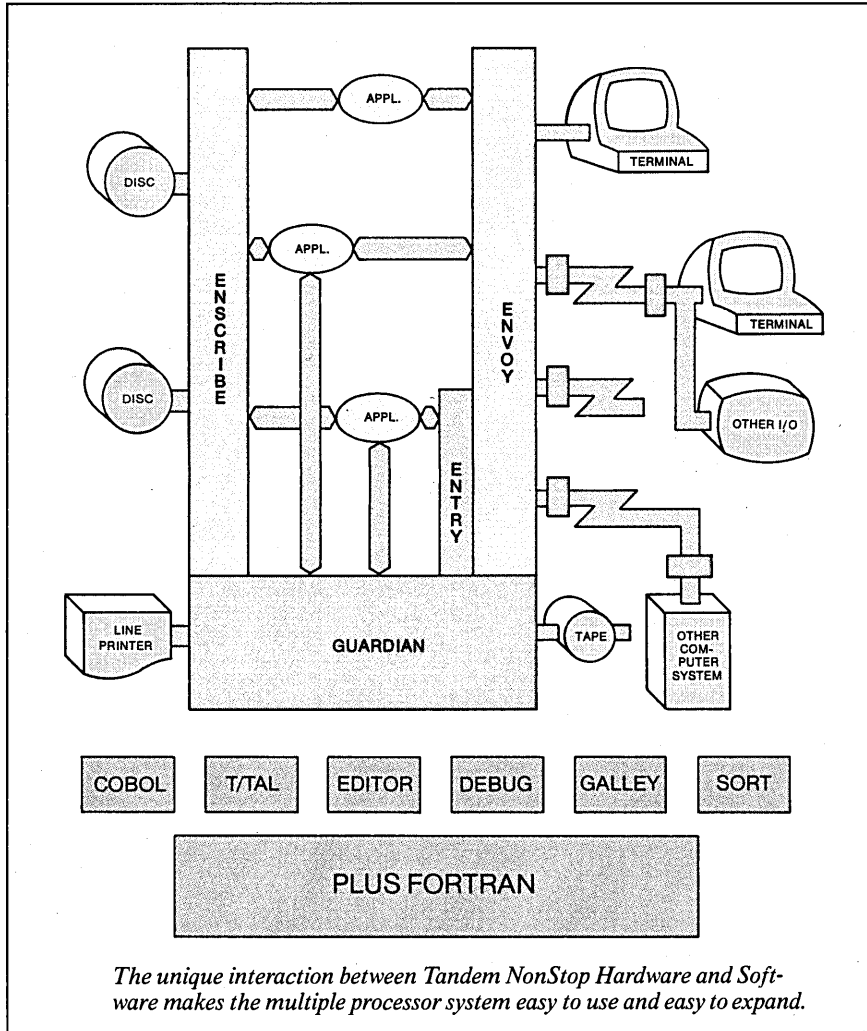

makes it possible to access key-sequenced, relative and entry-sequenced files by primary or up to 255 alternate keys. Provisions have been made to allow exact, approximate or generic positioning into an ENSCRIBE file structure using FORTRAN. Concurrent data base access with other programs and languages is supported with LOCK mechanisms at either the record or file level.

**Interprocess Communications.** Tandem FORTRAN processes can communicate with one another or with processes written in other languages through standard FORTRAN READ and WRITE statements. Communication to other processes is implemented using the interprocess communication facilities of the Guardian Operating System.

**Four BILLION bytes per file.** With no limit to the total data base size. And Tandem offers optional mirror copy by disc volume. With our alternatives in file structure and 255 keys per file, it's tremendous flexibility and amazing storage for a mini-based system. And of course, it's non-stop.

**The name of the game is control.** Feature by feature, and with special emphasis on its NonStop capabilities, the Tandem NonStop System with full language FORTRAN 77 is just what control systems people have been wanting for years. For those system development jobs where continuous control is the critical function and a NonStop computer would offer obvious advantages, this is FORTRAN at its finest. And control with unprecedented protection.

**There's only one NonStop System on the market today.** It's expandable without penalty. Without reprogramming. Without one cent of loss on the original investment.

For further information, contact Tandem Computers, Inc., 19333 Vallco Parkway, Cupertino, California 95014; Frankfurt, West Germany; Uxbridge, England; Toronto, Canada. **TOLL FREE 800-538-9360 or (406) 996-6000 in California.**

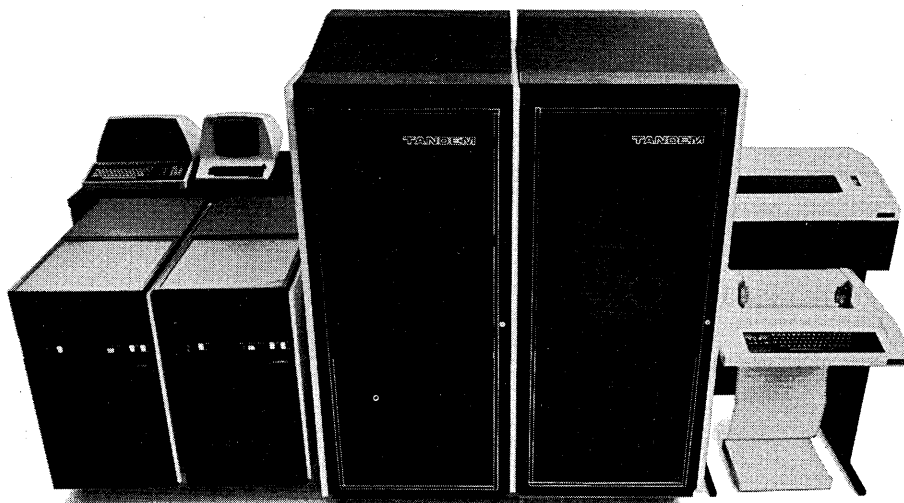

## TANDEM

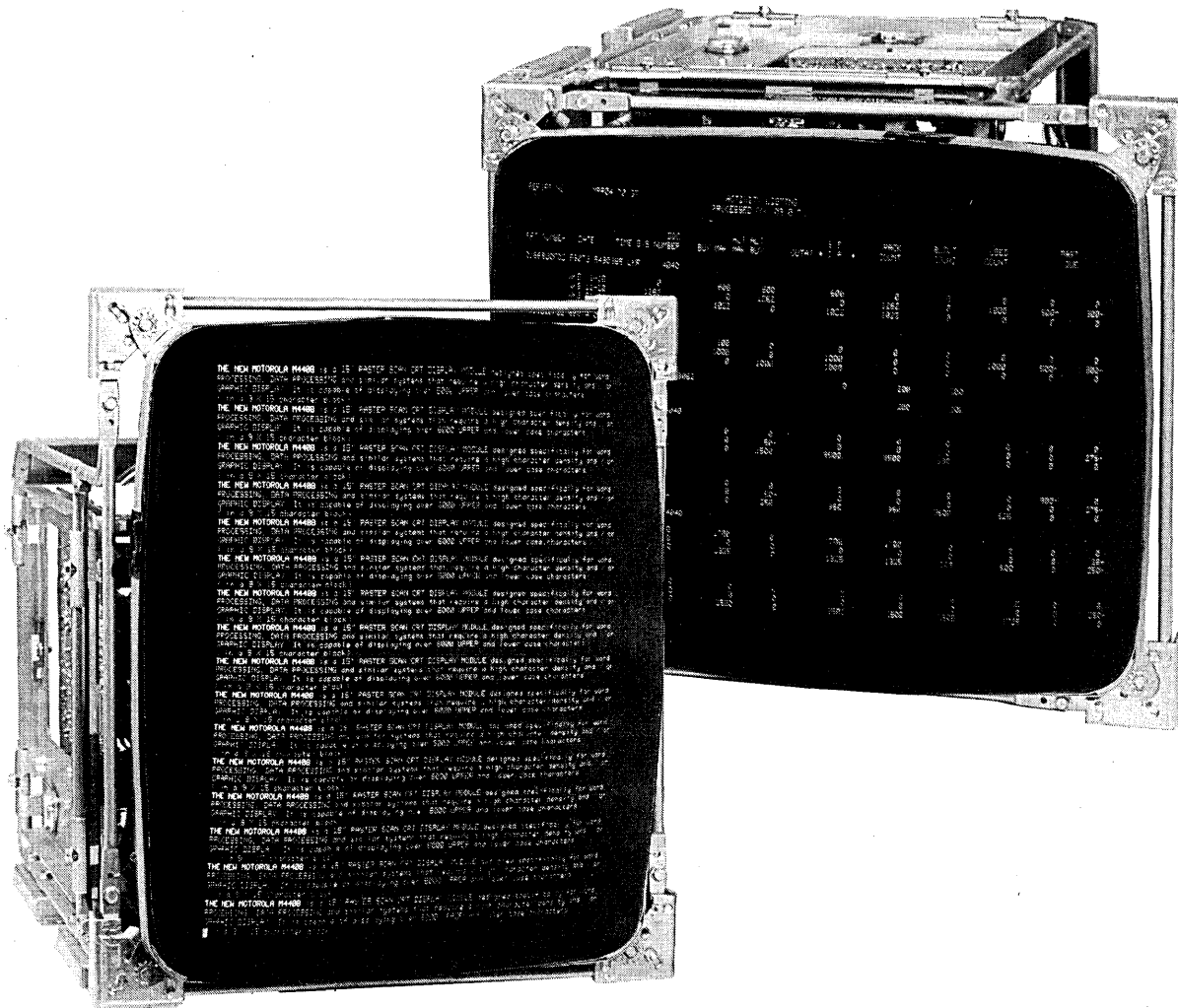

# Display Technology just took a giant step forward.

With the M4408 by Motorola. Like some of our others, it's a 15" raster scan CRT display module, but that's where the similarities end. The M4408 was specifically developed for systems that demand displays of up to 6,300 upper and lower case, clearly readable characters.

With its unique horizontal or vertical mounting capability, the M4408 can display a full typewritten page (96 characters x 66 lines) or a wide page printer format (132 characters x 48 lines ... or 43 if you prefer). And those are only two examples. The M4408 is the optimum display for any high performance, high density character application.

The cost? Not much more than conventional 15" 80 x 24 type displays — considerably less when you consider cost per character. And the M4408 doesn't require high speed, expensive logic either.

When you compare features, we think you'll agree that the Motorola M4408 is the price performance winner.



**MOTOROLA INC.**  
**Data Products**

455 East North Ave., Carol Stream, IL 60187  
(312) 690-1400 TWX: 910-252-4404



"After a thorough evaluation, we chose IDMS because it offered the greatest flexibility, performance and ease of use on our MP168. Just check these features."

### IBM 370/168MP

- tremendous flexibility and ease of use
- warm restart and automatic recovery
- full-featured integrated data dictionary
- high level language query
- program independence
- minimum resource consumption
- upward-downward compatibility
- high performance
- full-featured report generator
- integrated telecommunications support with any TP monitor
- data independence
- guaranteed recovery
- integrated on-line and batch processing
- thorough on-site education
- complete, comprehensible documentation
- outstanding vendor support
- rapid installation
- secondary indexing and sequential processing
- database administration utilities
- multi-threading



"We really wondered what we could get on a small shop budget. Then we saw that IDMS beat everyone for performance and price. We got all this for our 370-115."

### IBM 370/115

- tremendous flexibility and ease of use
- warm restart and automatic recovery
- full-featured integrated data dictionary
- high level language query
- program independence
- minimum resource consumption
- upward-downward compatibility
- high performance
- full-featured report generator
- integrated telecommunications support with any TP monitor
- data independence
- guaranteed recovery
- integrated on-line and batch processing
- thorough on-site education
- complete, comprehensible documentation
- outstanding vendor support
- rapid installation
- secondary indexing and sequential processing
- database administration utilities
- multi-threading

# That's right. Both get the same great system with IDMS.

Most people think that IDMS is best for large system users. That's true, IDMS is the best DBMS for large systems.

But some people think you must have a big system to run IDMS — that small systems won't get the full benefit of IDMS's many features. These people couldn't be more mistaken — because IDMS is the one DBMS that easily provides full-featured performance for all size computers.

Not only that, when small and medium-size users are ready to upgrade their hardware, IDMS actually makes this transition easier, maintaining the same flexibility, ease of use, and performance.

Flexibility, performance and price, the three most important reasons why IDMS is perfect for the small computer, perfect for the large, perfect for every computer in between.

Proof? Let us go over with you the list of features above as well

as your own checklist of requirements — for whatever size computer. We're convinced that once you've seen what IDMS can do, you'll make it your DBMS. For further information, send this coupon or phone (617) 237-6600.

<input type="checkbox"/> Have a representative call.	Name _____ Title _____
<input type="checkbox"/> Send me complete technical information on IDMS.	Organization _____
<input type="checkbox"/> Send a schedule of free IDMS seminars being held in my area.	Address _____
	City _____ State _____ Zip _____
	Phone _____
	Computer Model _____

IDMS. The DBMS for all IBM computers.



# Cullinane Corporation

Wellesley Office Park, 20 William St., Wellesley, Mass. 02181 (617) 237-6600

CIRCLE 29 ON READER CARD



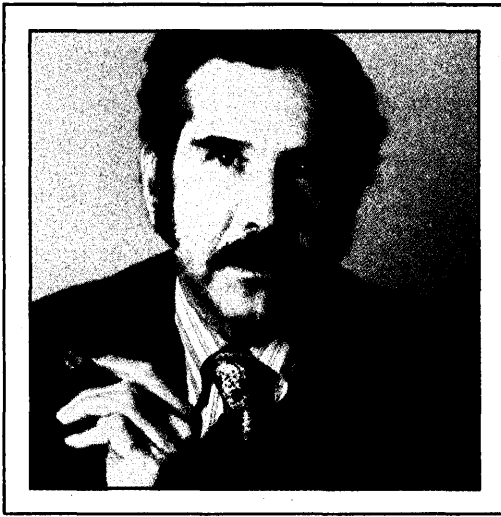

“National Semiconductor is crossing the Rubicon.

We are entering the computer market with a range of sophisticated system-level products.

I think they are some of the most important breakthroughs ever in systems technology.

For us, this step is not only natural and logical, but inevitable.

We consider that we are finally giving birth after ten long years.”

Charles E. Sporck  
President

“I assure you, National Semiconductor did not caper into the computer market on a whim. For the past decade, we’ve been a leader in creating the technology that makes computers work.

In 1973, we became a visible systems supplier—with the sale of electronic point of sale systems. We’re now the second largest supplier in the world. With more than 13,000 terminals and over 1000 computers in more than 1,400 store sites. And a full-time field service force of more than 250 people.

Three years ago, we introduced IBM 370-compatible add-on memory. Today, National ships more large scale 370 add-ons than anyone except IBM.

National has built add-in memories for some of the most popular minicomputer models as well.

We are now shipping our industry standard Series/80 microcomputers at the rate of 12,000 systems a year.

Two years ago, we unveiled our first IBM-compatible computer. To date, over 100 systems have been installed in ten

countries. We are now shipping more IBM-compatible computers than all other competitors combined.

I think this demonstrates that National Semiconductor has quietly, deliberately become a prime mover in computer hardware and systems. Annual computer revenues already put us in the top 15 of all U.S. general purpose computer manufacturers—and we're climbing. Certainly, we haven't come this far without being acutely aware of the market's needs.

### *A clear, levelheaded look.*

If we had not penetrated the systems market of our own accord, technology would have eventually forced the business on us. Our semiconductor components are rapidly becoming total "systems on a chip."

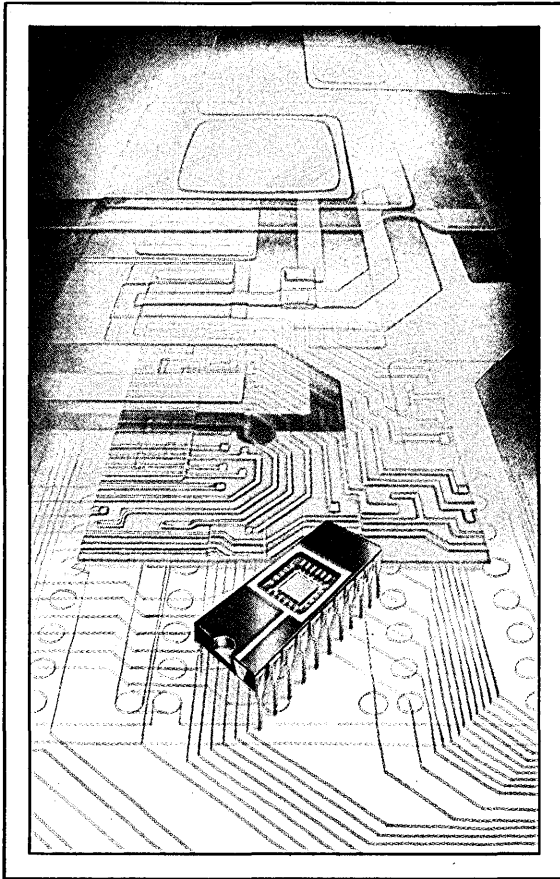

But before jumping into the market altogether, we gave ourselves the luxury of a clear, levelheaded look at the terrain.

Because we have no equity in particular methodology or design, we remain free to appraise the market and develop a product that uniquely solves a problem.

And, by applying current semiconductor technology and production expertise, we deliver better performance at a lower price than other suppliers.

### *Just another computer?*

National Semiconductor is deeply committed to applying its systems technology to real user problems. We are not interested in simply creating another different computer.

By making software-compatible hardware, we protect a customer's investment in standardized software.

At the same time, we consider it our responsibility to supply our customers with the latest in systems technology. So we'll be sparking unique product advances of our own. Particularly where a void exists in the marketplace.

### *For keeps.*

National Semiconductor is in the computer systems business for keeps—as a broadbase supplier able to handle everything from manufacture through distribution, delivery, service and support. That's why we have an active, full-fledged service force of over 250 people set up to respond to customer needs.

We're willing to pinpoint our experience in research and development to further advance systems technology. In fact, over the next several months we'll be taking the wraps off some of the most significant new products in our history. Breakthrough products like the System/400, perhaps our most important advance in systems technology to date.

The System/400 is the first minicomputer designed to perform all the functions of large IBM computers. It means users will be able to run existing industry-standard software on a system at a fraction of the cost of a large computer.

If you'd like to know more about the future of National Semiconductor, Computer Products, or about System/400 specifically, write me personally: Charlie Sporck, President, National Semiconductor Corporation, Drawer 1, 2900 Semiconductor Drive, Santa Clara, California 95051."

**Computer Products Group**  
≈ National Semiconductor Corporation

# Most graphics terminals are too dumb for words.

Even expensive models get tongue-tied when it comes to alpha-numerics. But now there's a bright new graphics terminal that has a lot to say for itself.

## Alpha-graphics: the perfect combination.

It's the Hewlett-Packard 2648A alpha-graphics terminal. For just \$5500\*, it will dazzle you with a

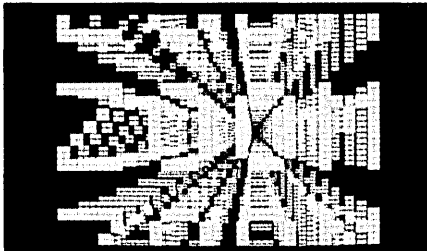

virtuoso display. You'll see zoom and pan, area shading, pattern definition, rubber band line, scientific plotting and graphics text composition. Having independent memories for graphics and alphanumeric, you can do auto-plots with or without words and figures on the screen.

And when you need a smart alphanumeric terminal for on or off-line work, stay right where you are.

Yes, give me the good words (and pictures) on the HP 2648A terminal.

I'd like a demonstration.  Send me information.

Name \_\_\_\_\_ Title \_\_\_\_\_  
 Company \_\_\_\_\_  
 Address \_\_\_\_\_  
 City/State/Zip \_\_\_\_\_  
 Phone \_\_\_\_\_

Mail to: Ed Hayes, Marketing Manager,  
 Hewlett-Packard Data Terminals Division,  
 19400 Homestead Road, Dept. 414, Cupertino CA 95014.

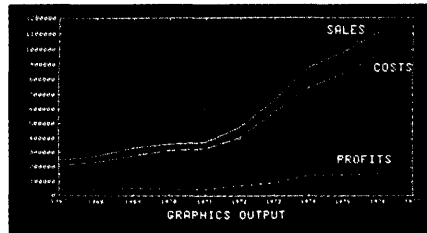

## How smart is smart?

Ever seen a graphics terminal scroll 200 lines of interactive dialogue? And store up to 220K bytes of data (words and pictures) on twin cartridges? And cut out repetitive routines by storing up to 80 characters on each of eight "soft keys"?

The HP 2648A can also edit with the best of them. Communicate with a computer at rates up to 9600

baud. And accept a plug-in forms drawing mode to generate just about any form your company uses.

## Strong as well as intelligent.

Like all our terminals, the HP 2648A has a clean, tough, modular design. Open it up like a suitcase, and you'll see the neat row of plug-in PC boards.

That makes it easy to add options or take care of maintenance. Not that downtime is a problem. Our terminals have such a good track record that we've lowered our maintenance price three times in the past two years. When you do need service, more than 1000 Systems and Customer Engineers worldwide are ready to take care of you.

So why settle for any dumb graphics terminal when ours can figure in your picture?

See for yourself by calling the Hewlett-Packard office listed in the White Pages. Or send us the coupon and give our 2648A alpha-graphics terminal a screen test.

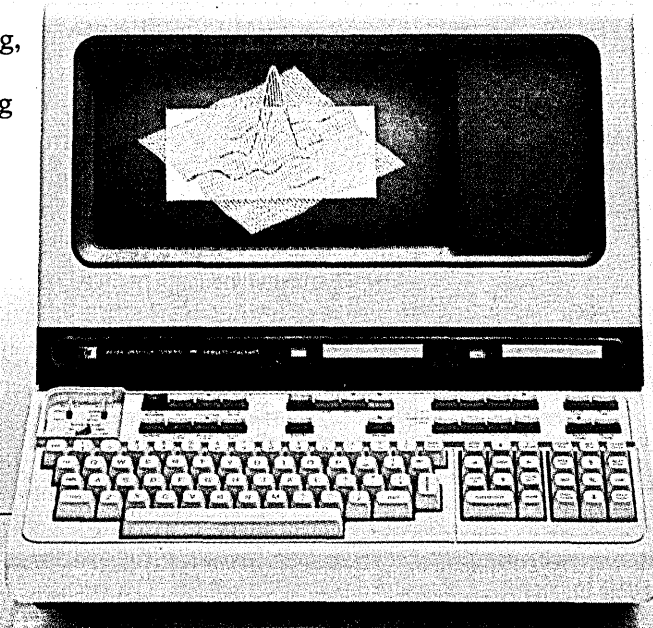

\*U.S. domestic price

HEWLETT  PACKARD

42801HPT5

CIRCLE 58 ON READER CARD



---

---

# people

---

---

## A Not So Interim Job

When Louis B. (Bernie) Horwitz became president of Datum Inc. in October 1976, he considered it an interim job for from 60 to 90 days.

He still has the job and appears to be liking it. "When I took over, the company was close to financial collapse. My first order of business was to get our financial house in order. That has long since been accomplished," said Horwitz.

Horwitz said the whole board of directors, of which he has been a member since 1974, talked him into staying. He replaced as chairman and president of Datum a long-time acquaintance, Wallace Rianda.

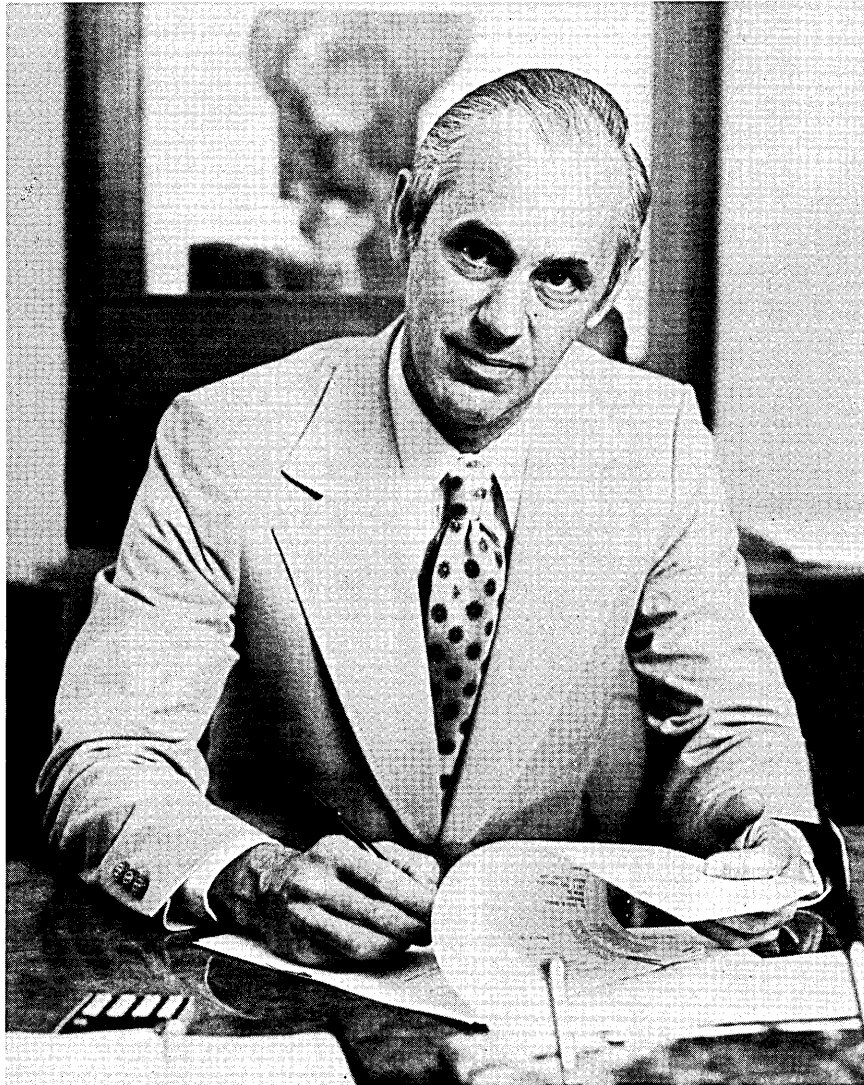

LOUIS B. HORWITZ  
"... proud of what's happened."

Horwitz first met Rianda back in 1957 when Rianda interviewed him for a job with Beckman Instruments in Northern California. Horwitz got the job. Rianda, shortly afterward, was transferred by Beckman to Southern California and then left Beckman to join Astrodata which he left in 1968 to form Datum with some other people from Astrodata.

Horwitz stayed with Beckman for 10 years, leaving to join Max Palevsky's Scientific Data Systems in 1967. When Xerox Corp. acquired SDS he became executive vice president of the operation which Xerox called Xerox Data Systems. But then Xerox decided to "wipe out XDS" in a corporate reorganization it later rescinded and Horwitz decided he wanted out. He left Xerox in 1971. Xerox later recreated XDS as a separate entity but Horwitz was long gone and XDS wasn't much longer lived.

Horwitz said he advised management he'd like to see XDS concentrate on "what it knows best . . . real time scientific processing. I told them to stay out of business data processing . . . but with a monolithic thing called

Xerox . . ."

After leaving Xerox, Horwitz got into consulting "almost by accident." He said he had a number of approaches made to him by executive search firms but "they were for other voluminous, large corporations, Xerox sized," and they were for parts of the country where he didn't want to live like New York City where "I wouldn't go to become a king."

Horwitz is a Texan who looks but doesn't sound like one. He attended the University of Texas at Austin and did graduate work at Stanford. It was at Stanford he became enamored of Northern California. It had a lot to do with his application for a job at Beckman (he had been working in Colorado for Continental Oil Corp.). "If it had been a Southern California job, I don't think I'd have been interested." But it was in Southern California where he has spent some of his most productive years and he doesn't mind that.

Horwitz is proud of what's happened with Datum since he took over. The Anaheim, Calif. mini-peripherals firm has turned around from a loss in fiscal 1976 of \$2,495,000 to earnings in fiscal 1977 of \$765,000—the best for the company in more than five years.

Horwitz cut the firm's product lines from six to three. "We didn't have the resources to support more than three and we certainly didn't have the resources to go into bet-your-company new ventures."

He said prior management's reliance on sales volume as "a cure-all" was immediately dropped in favor of a policy of "managing cash, not revenues." He said he reduced Datum's debt by selling off inventory and paying off vendors so "we could work on our schedule, not theirs."

He recalls going into Wells Fargo Bank's "troubled loan department" when he first took over the reins at Datum. He was asking for an additional million dollars and pledging as partial collateral a \$440,000 income tax refund the firm expected. He got the loan and credits for this, in part, because of "my sales ability." He said "I felt at the time that the \$440,000 was assured to the bank but learned later that I was very lucky because they (the bank) took into account the possibility of bankruptcy proceedings which would have the tax refund distributed among debtors."

Although Horwitz has cut back on Datum's product line, he's still interested in new products and the firm's newest is a line of peripheral systems for the IBM Series 1. To date, Datum is the only source of magnetic tape, disc, and printer systems for Series 1.

What he dropped included a mini-computer called Enhancer (April 1975,

*(Continued on page 42)*

**Documation's  
new breakthrough  
gives you all  
the advantages of  
impact printing  
at laser graphic**

Call John Sterling (800) 327-6424 or (305) 724-1111 or your local Documation representative: **Atlanta, GA** 955-0309  
**Boston, MA** 890-2650  **Chicago, IL** 782-0551  **Dallas, TX** 661-9902/750-6160  **Detroit, MI** 353-8181  **East Meadow, NY** 794-1186  
**Greenwich, CT** 869-4123  **Hartford, CT** 278-2010  **Houston, TX** 780-1432  **Irvine, CA** 752-8782  **Long Beach, CA** 595-6775  
**Miami, FL** 592-9655  **New York, NY** 695-4195  **Newark, NJ** 686-5223  **Oak Brook, IL** 920-0551  **Philadelphia, PA** 337-2850  
**San Francisco, CA** 574-4060  **Washington, DC** 356-2050  **International Offices: London** — Staines 61124  **Paris** 686 8007  
**Germany** 0611-762 055  **Spain** 416 87 60.

# Introducing IMPACT 3000

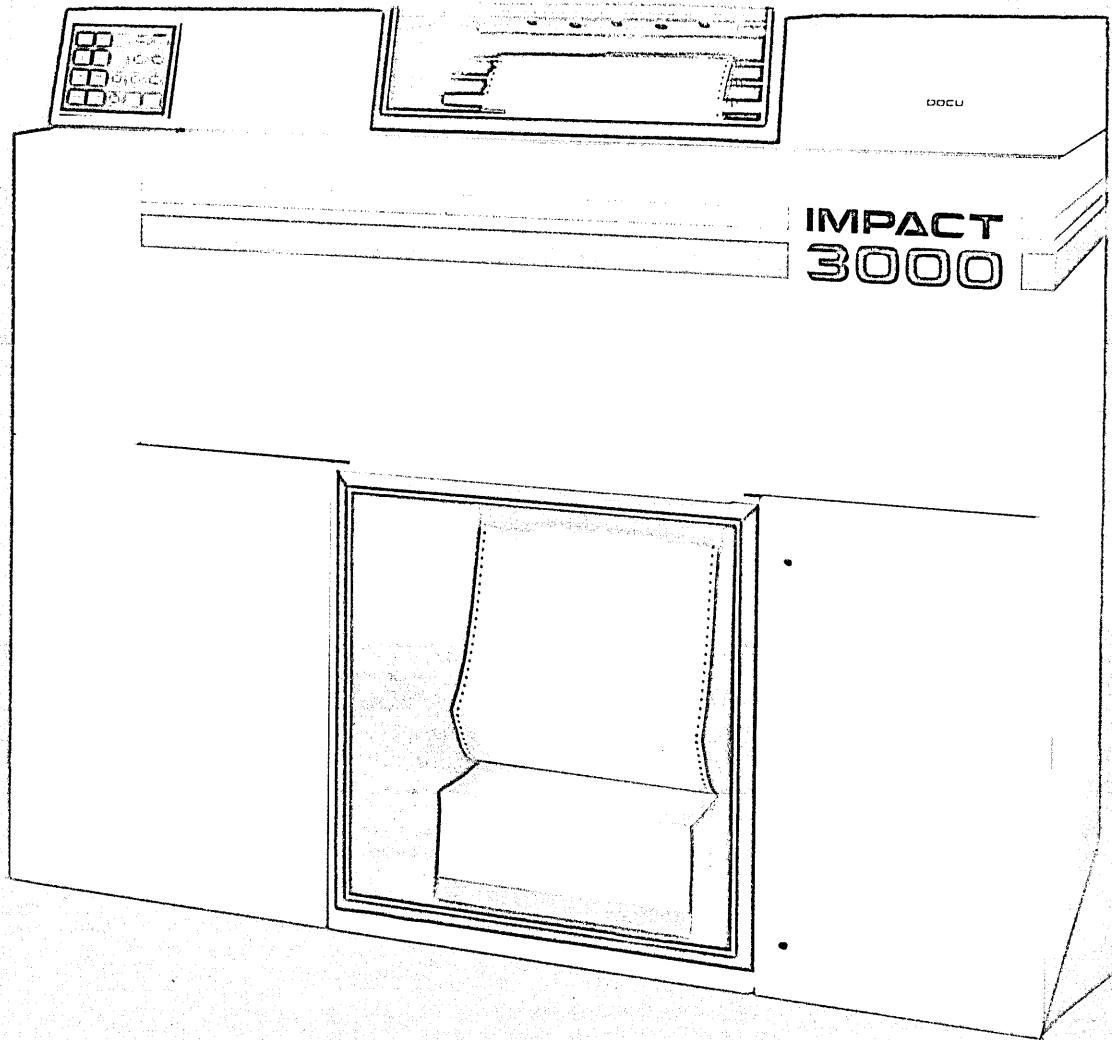

## **World's fastest Impact Line Printer**

Documation's technology breakthroughs increase throughput to 3000 lines per minute. With 6 copy capability impact printing now yields throughput rates up to 18,000 lines per minute per printer.

## **More throughput per dollar invested**

Cost of ownership of three IMPACT 3000 line printers is less than a single IBM 3800, providing you significantly lower cost redundant reliability. What's more, IMPACT 3000 productivity increases as the number of copies increases. Laser graphic productivity decreases.

## **Forms flexibility**

IMPACT 3000 provides printing on any forms 3 to 18¾ inches wide and 3 to 24 inches deep. More than twice the form depth of laser graphic capability.

## **No additional programming required**

Any 360/370 channel (or PCM mainframe channel) will support multiple IMPACT 3000 line printers. And, IMPACT 3000 requires no additional system or application programming.

Just four of the many reasons why you should investigate Documation's IMPACT 3000 as a viable alternative to laser graphic printing.

For more information on IMPACT 3000 write Documation Incorporated, P.O. Box 1240A, Melbourne, FL 32901 or call your local Documation representative for a detailed comparative analysis.

**DOCUMATION  
INCORPORATED**

(Continued from page 39)

p. 17), which still is being incorporated into other Datum products but which is being "quietly let die" as a separate product.

The company's three main product lines today are minicomputer peripherals, accounting for 63% of its business; timing products, accounting for 20%; and instrumentation products, 17%.

## "Telenet Has Proven Itself"

Barry Wessler is a pragmatist—a pragmatist who's sold on a concept that he claims has paid off. And that concept is packet switched data communications, a field that the Telenet Communications Corp. v.p. first plunged into 11 years ago at the Defense Dept.'s Advanced Research Projects Agency. Packet communications has come a long way since then and so has the 34-year-old Wessler who candidly concedes that Telenet's early-on "concept sell" of the fledgling technology was "an uphill battle."

That battle, says Wessler, was for customers—customers for Telenet's packet switched services which started up in the mid-'70s. Brought onboard in 1973 as the company's applications engineering manager, Wessler was soon moved into the sales director's slot. It was in this position that the MIT grad came to realize "the difficulty of getting into business when you're expecting your customers to do some work to meet you."

The customer work Wessler refers to is part of the "interface problem"—a problem that Wessler has been wrestling with ever since he joined Telenet five years ago. In the beginning, really Telenet's beginning, Wessler was convinced that "the difficulty of interfacing the network to people's computer systems" was the company's "main problem" in its packet push.

"We (Telenet) had a technical solution to that (interface issue) by having a nice interface that people could build toward, but it still bothered me that people had to develop a lot of software in order to communicate with the (Telenet packet switched) network. And that was because there was, and in fact still is, a little bit of a chicken and egg situation. In other words, people don't know they need to communicate with the network until they actually start doing it. But if they can't communicate with the network unless they have a reasonable interface development activity, then you really have a tough job convincing them

to use the network."

Today, Wessler explains, this interface hangup has become "much less of a problem," mainly he claims because Telenet has proven itself in the marketplace and a standard interface (X.25) has been developed. Still, he applauds those early "risk takers" who, by signing up for the Telenet service, pioneered the use of public packet switching.

These risk takers, he points out, "believed in the (packet switching) concept and they believed it would work." And so did the boyish-looking Wessler who says he started believing in the new communications technology back in 1967 when he was monitoring the ARPANET contract between Bolt, Beranek & Newman and ARPA. "So," he quips, "I've had plenty of time to nurture that belief."

He's also had plenty of time to learn Telenet's business from the ground up. After heading up the company's sales efforts, Wessler, who holds a PhD in



BARRY WESSLER  
A believer since 1967.

computer science, became director of systems engineering for Telenet in 1975. As part of this job, he created a systems engineering group dedicated to brainstorming such things as customer system design and the development of analytical interface design tools. Admittedly "into interfaces," Wessler, who views himself as a "technical manager," once again tackled the thorny interface question and came up with a program last year to handle interface-to-the-host problems.

As director of network interfaces for Telenet (a job which he still holds in addition to his new v.p. duties), Wessler got embroiled in the standardization drive for X.25, a high level communications protocol for linking computers and terminals to packet nets. Wessler's

work with X.25, which was accepted as a standard by the CCITT (Consultative Committee on International Telephone and Telegraph) in the fall of 1976, plunged him into the international data communications market—a market which Telenet officially entered as an international carrier last year.

Wessler views the various overseas administrations' moves into packet communications as a key indicator of the technology's viability. Packet switching, he predicts, "will be the primary mode of data communications worldwide. The question of whether it's called packet switching is not so much the issue," he maintains. "But if you look at the underlying techniques involved in packet switching, they are currently pervasive and will become even more so."

One thing that could hamper this worldwide data communications drive is the controversy currently raging over transborder data flows. Wessler sees the privacy concerns intertwined in this controversy as "very real issues," but he is quick to add that pinning these privacy problems "on technology is the bogus aspect. Restricting data flow," he argues ardently, "is not the proper way to handle the problem. The proper way is through (countries developing) positive national information policies."

## In New Posts

J. S. WEBB was elected vice chairman of the board and a member of the chief executive office of TRW Inc. . . . ROBERT A. STARK, Coldwell Banker Commercial Brokerage Co. director of data processing, was named a vice president by the national real estate firm . . . N. H. HAWKINS was appointed to the newly created position of vice president-marketing for GTE Comp-Acct Inc., producer of terminals for food service operations . . . North Atlantic Industries, Inc. established two new vice presidential positions and named JOEL KRAMER and ARTHUR FREILICH to fill them . . . Index Systems Inc. appointed ROBERT C. LUDWIG, GERALD LOEV and JUDE T. GARTLAND as vice presidents . . . WILLIAM R. LENNARTZ is the new president of Computer Power Systems Corp., Long Beach, Calif. . . . Datatrol, Hudson, Mass., named PETER A. R. WRIGHT as director, international operations . . . SAMUEL NEWMAN, a vice president of Irving Trust Co., was elected to the board of directors of the Society for Worldwide Interbank Financial Telecommunications (SWIFT) . . . WILLIAM G. MOORE, JR., formerly vice-president, domestic operations, Inforex, was named president and chief operating officer of Infoton, Burlington, Mass. video display terminal producer . \*



# EMM 370/158 and 370/168 add-on memory outperforms them all.

## Reconfiguration panel

Any failed segment or entire memory unit, including IBM, can be taken off-line

## Utilizes only 3 I/O cards

Easily replaced

## Box

Compact—the smallest available  
Totally matched to IBM dimensions

## 4K static RAM cards

Minimizes MTTR (Mean Time to Repair)  
IBM chip compatible  
Offers quick replacement

## Quick connects

Less installation time and less modifications in CPU  
Makes upgrading very simple

## RASI option

Backup power supply  
Bump store backup  
Standby memory  
Keeps unit operative in the event of trouble at the original capacity

## Common hardware

Less parts offer improved reliability  
Less CPU parts minimizes IBM maintenance requirements  
Easily repaired

## ECL 1000 logic

Best and fastest available

## Storage cards

Operationally independent to I/O  
All logic on these cards

## Floor plans

Most options available

Good enough isn't good enough at EMM. We set out to offer our customers the most 370/158 and 370/168 add-on memory for their money. Our 370/158 and 370/168 add-on memory outperforms all competitive units because we build more technology and features into them. One look ought to convince you.

Offering the most exceptional add-on memory

value up and down the line is what has made EMM the leading independent add-on memory supplier in the world. So, if you've looked high and low to buy the best available 370/158 and 370/168 add-on memories, talk to us, EMM. The people who give you everything you thought you needed and then some.

## The difference in add-on memory



COMPUTER PRODUCTS

A Division Of Electronic Memories & Magnetics  
2311 W. El Segundo Blvd., Hawthorne, CA 90250.  
(213) 777-4070

EMM Sales Offices: Eastern (201) 777-4404; Central (312) 297-3110; Western (213) 777-4070. Canada: Toronto (416) 626-1160. Europe: Bad Homburg, West Germany 06172/6094.

# Tektronix 4020 Series

**How can the first name in graphics come up with the last word in alphanumeric?**

**By turning both to your advantage.**

**From Alphanumerics to Graphics . . . now your terminals can keep pace with your needs.** Our new 4020 Series terminals let you plan for the day when alphanumeric isn't enough. Without trading in terminals or buying more capability than you need right now.

**Our 4025, for example, is a smart, refresh device that starts with alphanumeric and grows.** First into forms ruling. Then into graphics. All without one capability compromising the other. As a complement, the 4024 offers data entry and forms capabilities. So you can prepare for the future with maximum economy and Tektronix quality.

**Begin with the basics: alphanumeric at its best.** Both configurations include expandable memory. Complete editing. Fields. Scrolling. Familiar, user-definable keyboard. Easy-on-the-eyes screen.

**Plug in the forms ruling option and either terminal can recreate just about any source document.** With one keystroke entry. Easy information call-up. Ideally proportioned 34-line deep screen.

**And when you're ready to add data analysis and report generation, just add our low-cost graphics option to the 4025.** Almost anyone can sit down and create bar charts, pie charts and histograms, and command 8½"x11" facsimiles off our optional copier. Our PLOT 10 Easy Graphing host software is designed for the nonprogrammer. For minimal core consumption.

**Best of all, the 4020 Series comes with Tektronix reliability and support.** All the more reason why they're a great long-term growth investment. Ask your local Tektronix Sales Engineer for a demonstration. Or write:

**Tektronix, Inc.**  
Information Display Group  
P.O. Box 500  
Beaverton, OR 97077  
(503) 682-3411  
**Tektronix Datatek NV**  
P.O. Box 159,  
Badhoevedorp  
The Netherlands

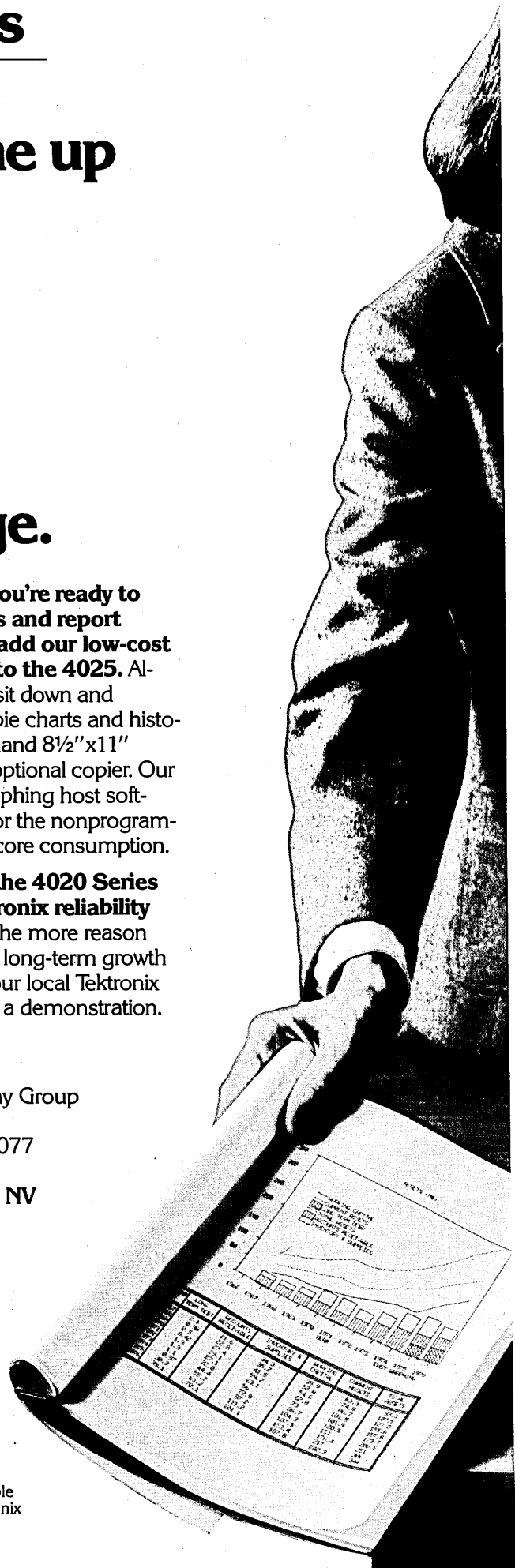

OEM information available  
Copyright © 1977, Tektronix  
All rights reserved

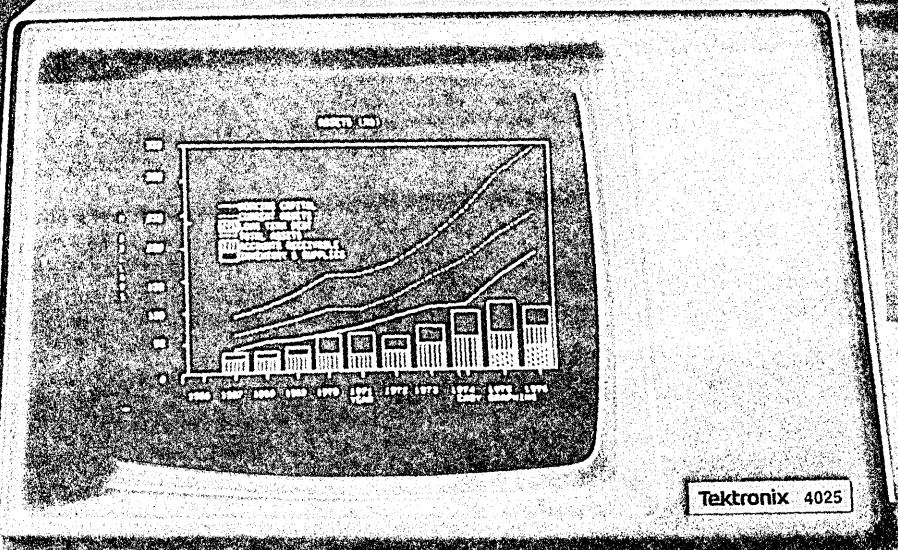
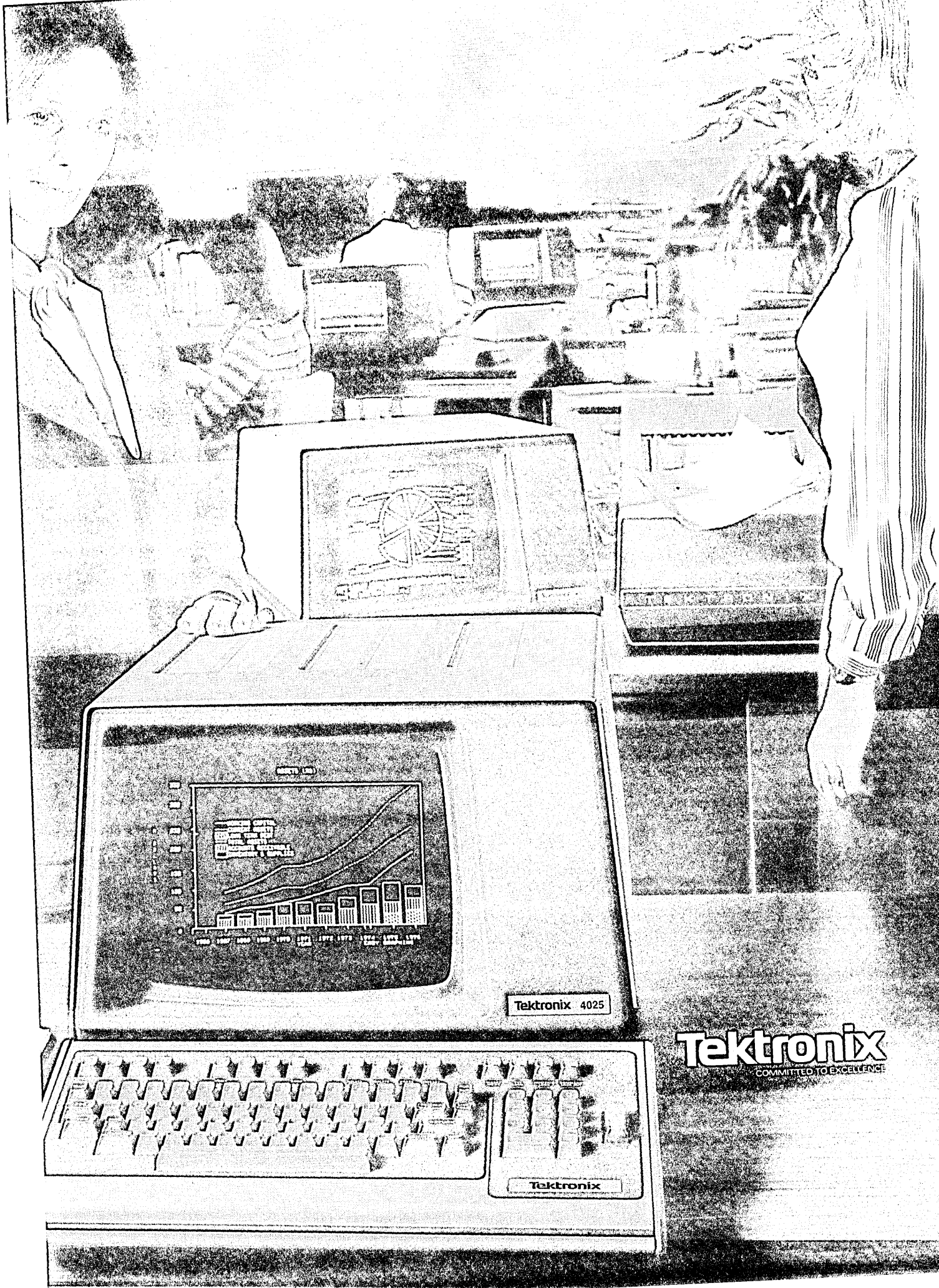

Tektronix 4025

Tektronix

**Tektronix**  
COMMITTED TO EXCELLENCE

# calendar

## JULY

Amateur Computing 78, **July 22-23**, Arlington, Va. Exhibitors at this weekend microcomputer festival will be both retail computer stores and systems manufacturers. Also featured at the show will be displays of amateur systems. Tutorial sessions and panel discussions will be presented on such topics as personal computing; speech, music and graphics; and standards for hardware, software, and "interfacing to the real world." AMRAD, Amateur Radio Research & Development Corp., P.O. Box 682, McLean, VA 22101.

Computer Graphics Week at Harvard: An International Conference on Computer Mapping for Users and Potential Users, **July 23-28**, Cambridge, Mass. Workshops and presentations are offered separately to allow for flexible registration; you may sign up for as many or as few as you wish. Roundtable sessions will follow each program, affording a chance to confer with and receive attention from speakers and conference faculty.

Four morning sessions will be case study presentations, each a detailed description and analysis of applications of computer mapping in education, government (uses such as regional planning, social services, and transportation), or the commercial sector.

Some featured speakers at the conference will be Isaac Asimov, Manuel Plotkin, chief of the Bureau of the Census, and Robert Blechtel, president of Dun & Bradstreet International.

A two-afternoon review of available computer mapping software is offered, featuring description and requirements of each program, and information about hardware, language(s), availability, costs, sample runs, and references. Also available will be sessions on cartographic data bases, including how to find them, and a workshop for educational institutions and government agencies on how to market and distribute software and data base packages, which will feature a panel discussion at which experts will share their experiences with legal issues, licensing and contracts, and special problems of international distribution.

Two highly technical "mini-course" programs are offered, one on thematic map design, which will run for three afternoons, and a limited attendance workshop on The Harvard Laboratory's software and data bases, which will be a series of tutorials and hands-on demonstrations of implementation, operation, and applications.

Attendees will be awarded certificates, and accommodations are available. Fee for the entire conference is \$150 for individuals from educational or government organizations and \$275 for those from commercial organizations. Individual session registration is \$35. Contact Ms. Janice Kostka, Harvard Laboratory for Computer Graphics and Spatial Analysis, 48 Quincy Street, Cambridge, MA 02138 (617) 495-2525.

Summer Computer Simulation Conference, **July 24-26**, Newport Beach, Calif. "Simulation Today" is the theme of the conference. Topics to be covered in presentations will include digital and hybrid simulation systems, emerging simulation languages, and such areas of application as energy conservation and use, biological systems, physical sciences, aerospace, biomedical systems, environmental studies, managerial and social sciences, and chemistry. The Society for Computer Simulation, P.O. Box 2228, La Jolla, CA 92038 (714) 459-3888.

Workshop on the Use of Computers in Teaching Statistics, **July 25-26**, Durham, N.H. Emphasis will be on using commonly available packages for classroom activities. Participants are invited to join in discussion and presentation. Contact Dr. Jerry A. Warren, McConnell 304, University of New Hampshire, Durham, NH 03824 (603) 862-1685.

OCR Users Association meeting, **July 30-August 2**, Hershey, Penn. The theme is "OCR—A Matured Technology and Its Impact on Future Applications." The chairman is Robert Green of Moore Business Forms, Inc. Industry speakers will cover banking, credit cards, remittance processing, health care, graphic arts, government, and retailing. OCR Users Association, 10 Banta Place, Hackensack, NJ 07601 (201) 343-4935.

## AUGUST

Third Jerusalem Conference on Information Technology, **August 6-9**. The theme of the conference is "Computers, Communications, and Technology Transfer." Technical developments supporting technology transfer, fault tolerant computing, satellite systems, networking, hardware and software technologies for developing countries, and the future of peripheral devices will be addressed. Professional tours to various Israeli universities and industrial computer installations will be offered. Contact JCIT3 Secretariat, Dept. of Computer Science, 4226 Ridge Lea Road, Amherst, NY 14226.

Compstat, the third Symposium on Computational Statistics, **August 21-25**, Leiden, the Netherlands. Papers presented will discuss numerical and algorithmic aspects of statistical methods and their applications, and new computer science techniques related to statistical analysis. Special attention will be given to multivariate analysis, regression methods, exploratory techniques, survey analysis, and software packages. COMPSTAT '78, c/o Centraal Reken Instituut, University of Leiden, Wassenaarseweg 80, Leiden, the Netherlands.

SIGGRAPH '78 Conference and Exposition on Computer Graphics and Interactive Techniques, **August 21-25**, Atlanta. The three main topics on which papers will be presented are: innovative applications of computer graphics as an aid to problem solving, design, analysis, or data base management; research and development in algorithms, software, and interactive techniques; and new concepts in display hardware and related devices. Contact S. H. Chasen, chairman, Lockheed-Georgia Co., Marietta, GA 30063 (404) 424-9411.

## SEPTEMBER

Second International Symposium on Data Processing in Social Security, **September 4-7**, Munich, Federal Republic of Germany. Contact V. Velimsky, International Social Security Administration, Data Processing Consultative Service, Boulevard de l'Empereur 7, B-1000 Brussels, Belgium.

SEARCC 78—South East Asia Regional Computer Conference, **September 4-8**, Manila, Philippines. Contact the Philippine Computer Society, MCC P.O. Box 950, Makati, Metro Manila, Philippines.

Fourth International IBSI Seminar, **September 6-8**, Zurich. International Business Forms Industries, 1730 N. Lynn Street, Arlington, VA 22209 (703) 841-9191.



# Twins.

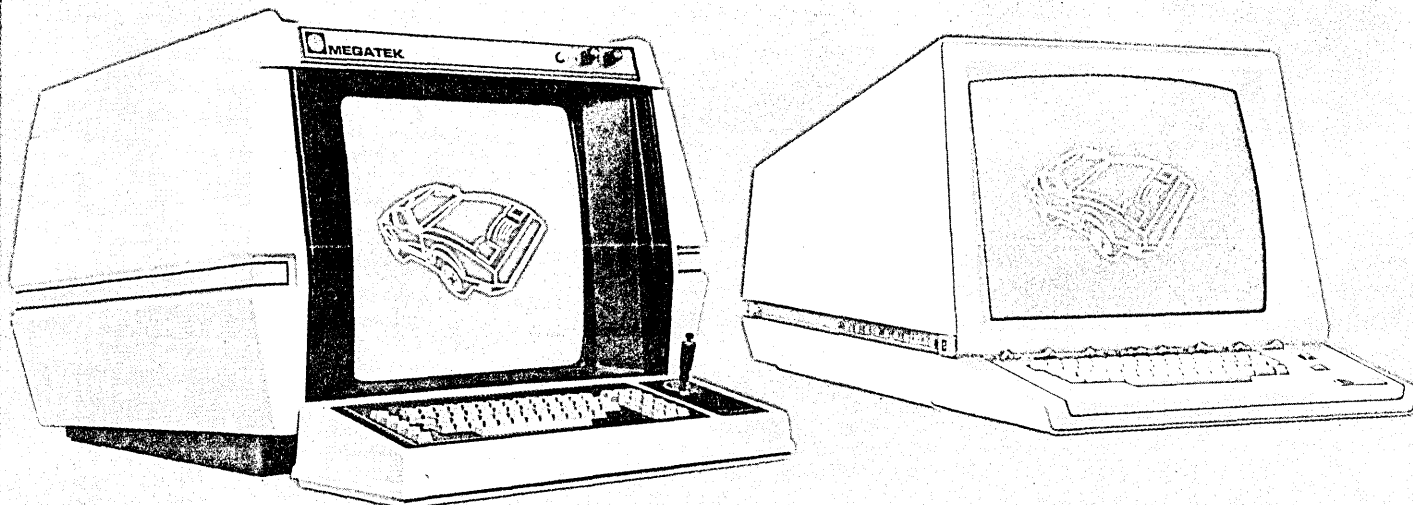

## Your computer can't tell them apart.

Good product, the 4014™. So good, in fact, that we designed our MEGRAPHIC 5014 Refresh Graphics System to do everything the 4014™ does, and more.

The secret? A high performance graphic processor coupled with a high resolution electromagnetic CRT. A built-in minicomputer. And EMUTEK™, our proprietary \*TEKTRONIX® emulator that makes your computer think it's talking to a 4014™.

But, right away, you'll see that one system delivers more graphics for the money.

Zoom, scale, clip, rotate, and "rubber band" images to your heart's content. The 5014 is a refresh graphics system and that means there is no need to erase the whole screen to make changes. The 5014 does it in real time. Plus a full FORTRAN OS.

And, unlike storage tubes, the 5014 has variable brightness levels. So you can see clearly even under the strongest office lighting.

But, best of all, the MEGRAPHIC 5014 costs substantially less than comparable systems. For the OEM, that means better margins. And, for the sophisticated end

user, it simply means more interactive graphics for the money.

So before you buy any graphics system, call MEGATEK at (714) 455-5590.

Don't wait. And don't pay more for less. If your 4014™ just isn't enough system, call Peter Shaw today and ask for a demonstration of the MEGRAPHIC 5014 System.

Thirty days later, you could have twins.

\*\*\*TEKTRONIX® and 4014™ are registered trademarks of Tektronix, Inc., use of which in no way constitutes endorsement.

*The refreshing alternative.*

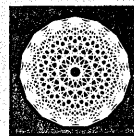

**MEGATEK**  
CORPORATION

3931 Sorrento Valley Blvd.  
San Diego, California 92121  
Telephone: (714) 455-5590  
TWX: 910-335-2056

14, rue de l'Ancien Port  
1201 Geneva, Switzerland  
Telephone: (022) 32.97.20  
Telex: 23343

**TRANSMISSION:**  
 Page; Field; Modified  
 Field; Prompted  
 Transmission; Device  
 Status; Function Keys.

**INTERFACE:**  
 EIA RS-232; Current  
 loop; 17 data rates  
 (switch selectable)  
 including 19, 200  
 chars/sec; Half duplex  
 support; Line  
 turnaround characters;  
 Reverse channel.

**EDITING  
 FUNCTIONS:**  
 Insert/Delete line and  
 character; Columnar  
 tabbing; Cursor  
 Addressability; Cursor  
 Sense; Numeric Only  
 fields; Security fields;  
 Erase Variable/  
 Protected fields.

**OPTIONS:**  
 Buffered Printer  
 Interface (RS-232 and  
 parallel), separately  
 addressable from the  
 CPU; Standard Polling;  
 Paging.

**VIDEO:**  
 Normal; Reverse;  
 Blink; Low/high  
 intensity; Underline.

**KEYBOARD:**  
 Removable, solid  
 state with international  
 character layouts.

"OFFHAND, WHAT MORE  
 COULD YOU WANT?"

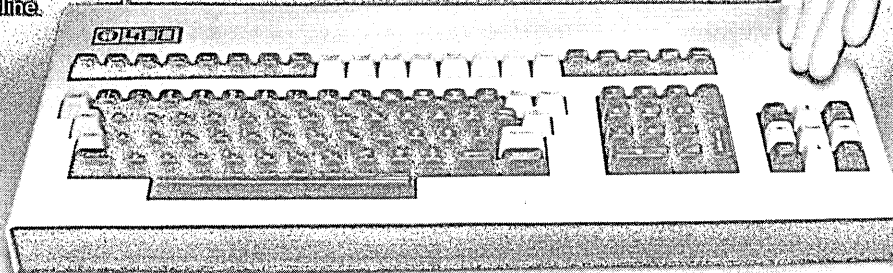

When it comes to flexibility, the Infoton 400 Data Display terminal can hand you all you need.

Designed around the Z-80 microprocessor, it offers complete control of all Blocking and Editing functions through software settable modes. One thing that's especially easy to handle about the I-400 is its cost; at \$1,095 in quantities of 100 or more, it's the most versatile terminal for the price you can get your hands on.

More information on the I-400 is quickly within your grasp. Call Infoton toll-free at (800) 225-3337 or 225-3338. Ask for Barbara Worth. Or write Barbara Worth at Infoton, Second Avenue, Burlington, MA 01803.

Prepared by Chickering/Howell, Los Angeles.

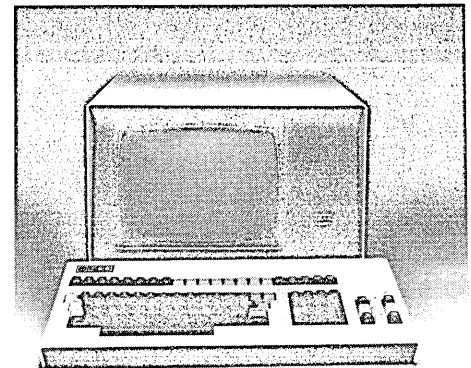

**Infoton 400**

# calendar

**Comcon Fall '78, September 5-8, Washington, D.C., Comcon Fall '78, P.O. Box 639, Silver Spring, MD 20901.**

**Computech '78, September 11-15, U.S. Trade Center, Taipei, Taiwan. U.S. Dept. of Commerce, Industry and Trade Administration, Washington, DC 20230.**

**Wescon 78, September 12-14, Los Angeles. Wescon, 999 N. Sepulveda Blvd., El Segundo, CA 90245 (213) 772-2965.**

**10th Annual SMIS Conference, Sept. 17-21, Washington, D.C., Mr. C.O. Smith, U.S. General Accounting Office, 441 G Street, N.W., Washington, DC 20548 (202) 275-6572.**

**An APL Users Meeting, Sept. 18-20, Toronto, Canada. Ms. R. Wild, I.P. Sharp Associates Limited, 145 King St. West, Toronto, Ontario M5H 1J8 Canada.**

**Convention Informatique 78, Sept. 18-22, Paris. Convention Informatique, Secretariat, 6, Place de Valois, 75001 Paris (France).**

## CALLS FOR PAPERS

Papers are now being reviewed for the **ACM annual conference**, to be held December 4-6 in Washington, D.C. Proposals for special sessions and panels are also being accepted. Deadline is July 1. Five copies should be submitted to Gerald L. Engle, Dept. of Math & Computing Sciences, Old Dominion University, Norfolk, VA 23508 (804) 489-6524. A program stressing current applications and policy matters related to computers in the federal government will be featured at the conference. Papers for this special program should be sent (in five copies, by July 1) to: Dennis M. Conti, Systems & Software Div., National Bureau of Standards, Washington, DC 20234 (301) 921-3485.

The Society of Exploration Geophysicists and the U.S. Navy will be sponsoring a symposium on "**Acoustic Imaging, Technology and On-Board Data Recording and Processing Equipment**," August 17 and 18. The deadline for receipt of 100-word abstracts is July 1. Contact Mr. J. Alan Ballard, Naval Ocean Research and Development Activity, Bldg. 1105, NSTL, Bay Saint Louis, MS 39522 (601) 688-4620.

July 31 is the deadline for submission of summaries of papers for presentation at the twelfth annual Asilomar Conference on **Circuits, Systems and Computers**. Contributions are solicited on the subjects of circuit theory and design, communication and control systems, computer systems, and computer aided design. Special sessions are also planned on image processing, digital and analog filtering, topological applications, energy and socioeconomic systems, and microprocessor-based systems. Send summary in triplicate to Donald E. Kirk, Electrical Engineering Dept., Naval Postgraduate School, Monterey, CA 93940.

A traditional feature of COMPCON is the "**Short Notes**" session, a series of five minute presentations of new work or applications, with discussions encouraged following each presentation. If you are interested in speaking at the COMPCON Fall '78 Short Notes, submit a 250-word summary by August 1 to Shirley Ward Watkins, National Bureau of Standards, Technology B212, Washington, DC 20234. \*

June, 1978

# If you own one of these

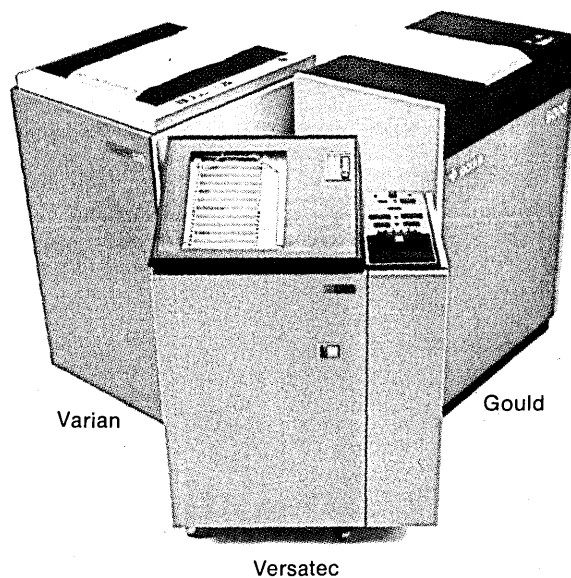

## get sensitive.

You pay plenty for electrostatic paper. You should know about our new paper that makes brighter images and costs less. Try a roll free. Come with the Sensitive Paper People.

 **GRAPHIC CONTROLS**  
COATED PRODUCTS DIVISION

### sensitivity coupon

Send one free roll or fanfold to fit:

Gould,  Varian,  Versatec

Annual Usage: \_\_\_\_\_ rolls Paper Number: \_\_\_\_\_

Name \_\_\_\_\_ Phone \_\_\_\_\_

Firm \_\_\_\_\_

Address \_\_\_\_\_

City \_\_\_\_\_ State \_\_\_\_\_ Zip \_\_\_\_\_

Mail to Coated Products Division, Graphic Controls Corporation,  
P.O. Box 1309, Buffalo, NY 14240

D-E-6

Or call toll free 800-828-7978.

(In New York State, call 716-847-7500.)

CIRCLE 152 ON READER CARD

# We the leader.

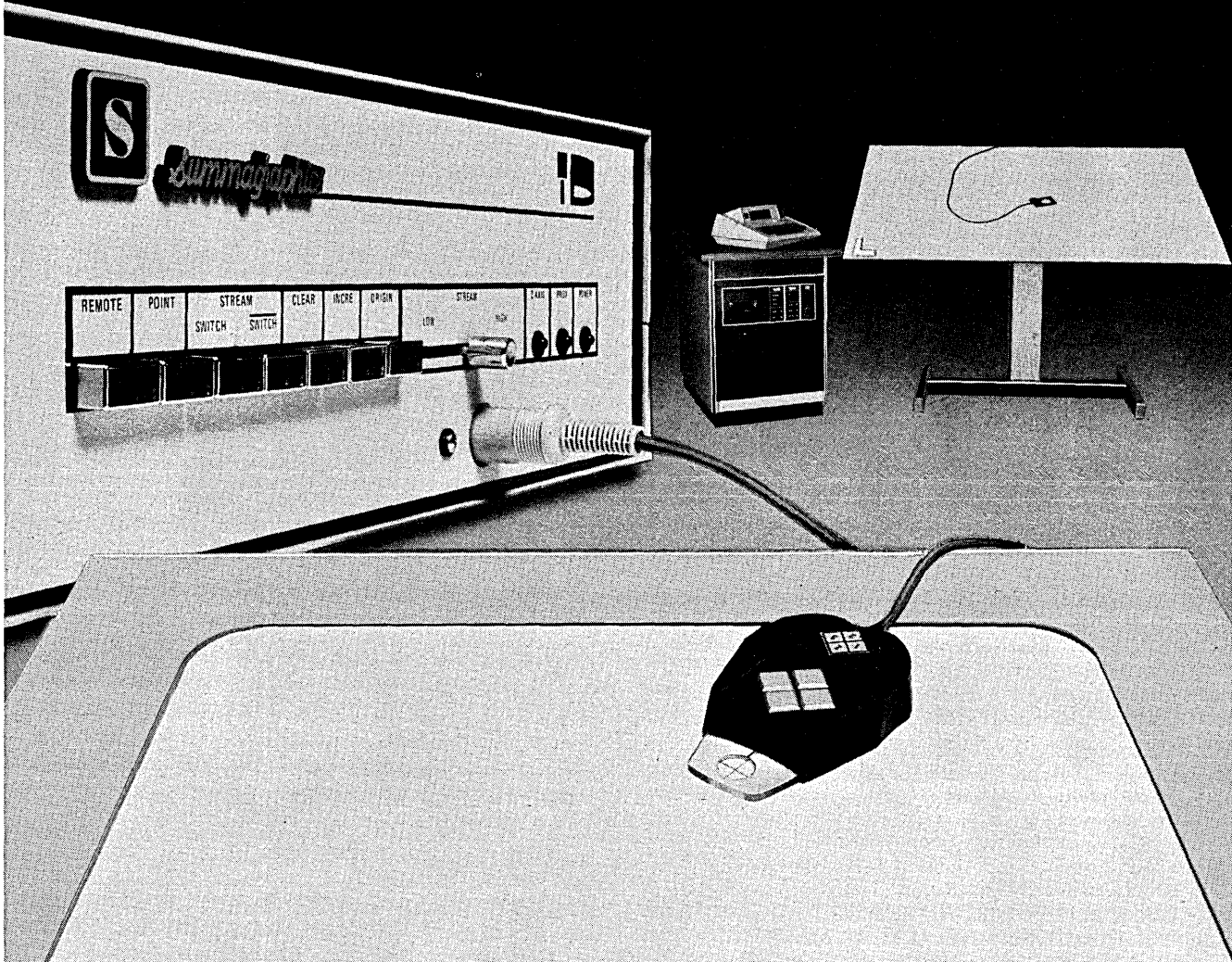

Summagraphics, the world's leading manufacturer of Data Tablet/Digitizers has added to its lead. We've added the Bendix computer graphics line of products; renowned for high accuracy and resolution.

We now offer the largest, most complete product line of digitizers for all your graphics applications. Whether your application is in drafting, cartography, circuit design, geophysics, land management, medical research, molecular modeling or other applications, we make the high quality digitizer for all your computer graphics needs. Digitizers with ultra-high accuracy and resolution. Digitizers with back-lit capability. Digitizers built with the reputation for quality and experience that

has made Summagraphics and Bendix the leaders in graphic digitizers.

We have Datagrid II®, the interactive drafting system and ID, the Intelligent Digitizer with built-in microprocessor controls. We even have Bit Pad™, the low cost digitizer for personal computing and small computer systems.

What was once a choice in digitizer manufacturers is now a decision. Summagraphics, the decision thousands of satisfied customers have made.



**Summagraphics**  
corporation

35 Brentwood Ave., Box 781, Fairfield, CT 06430  
Phone (203) 384-1344. TELEX 96-4348



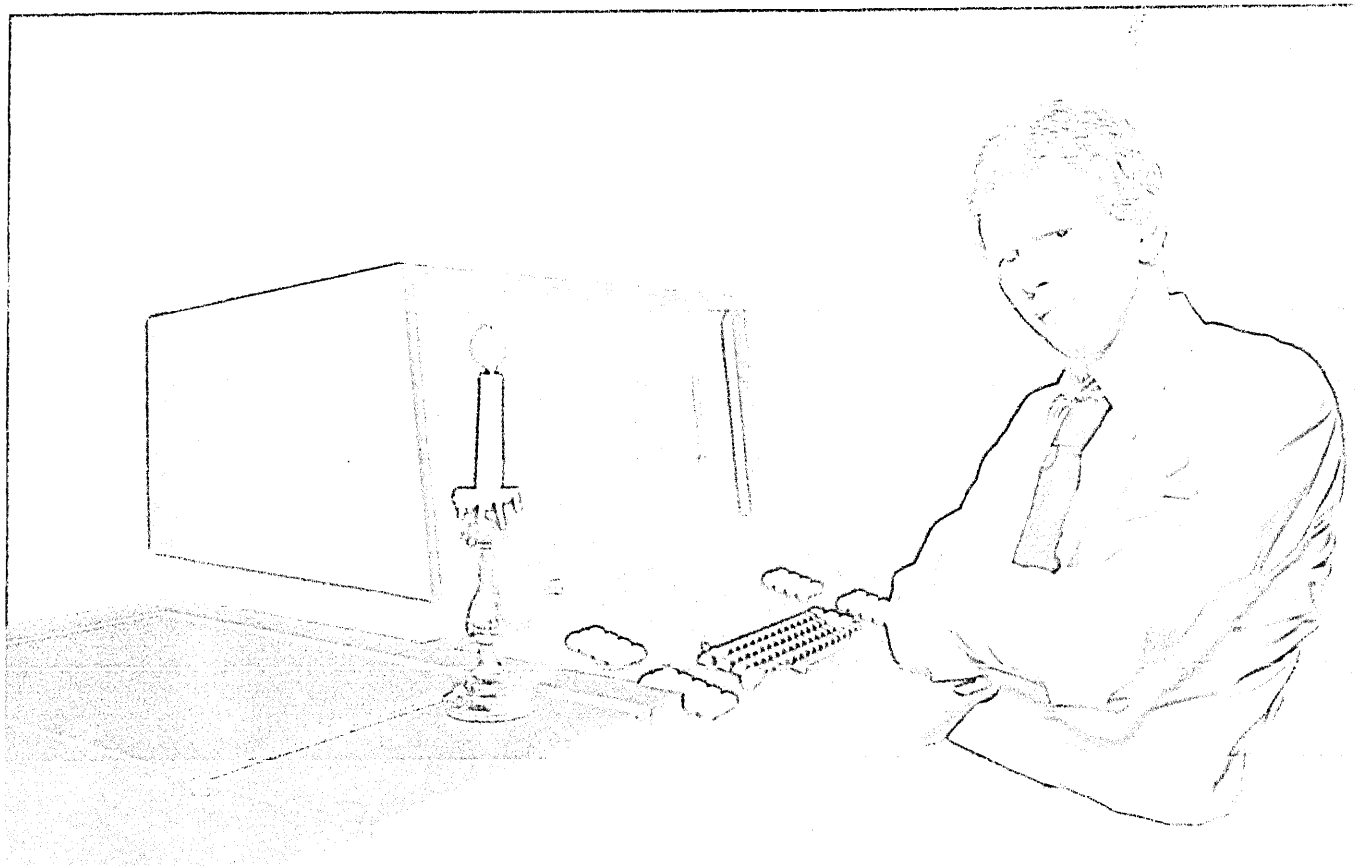

# How do you explain a brownout to a computer?

**The same way you explain the other unpredictable line anomalies found in today's commercial power. You don't.**

There is an answer, however, to this rapidly growing problem.

A Kato motor-generator set. It delivers a constant supply of clean, accurate power so you can ride out sudden voltage fluctuations that often shut down systems needlessly. In fact, you can continue operations indefinitely, despite voltage reductions of 20% or more.

And because an M-G set is the only method that provides **total** load isolation, you're fully protected against harmful spikes that result in costly, often untraceable computing errors.

Kato Engineered M-G sets do the job with energy saving efficiency and low maintenance requirements.

They're rugged, too. Our conservatively designed units withstand severe overloads that would destroy a solid-state device in seconds.

Ask us about the cost-advantages of using a Kato motor-generator set in your operation. We'll draw on our 50 years of experience in meeting your power conversion needs.

Call Kato Engineering Company, Mankato, Minnesota 56001. (507) 625-4011.

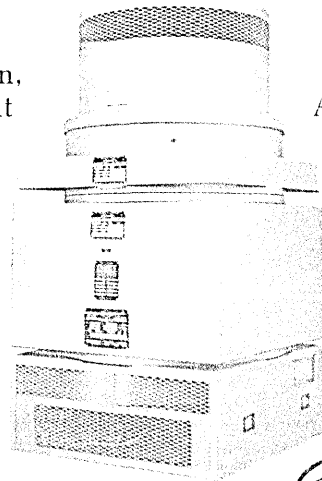

CIRCLE 69 ON READER CARD

**KATO**  
*Engineering* COMPANY

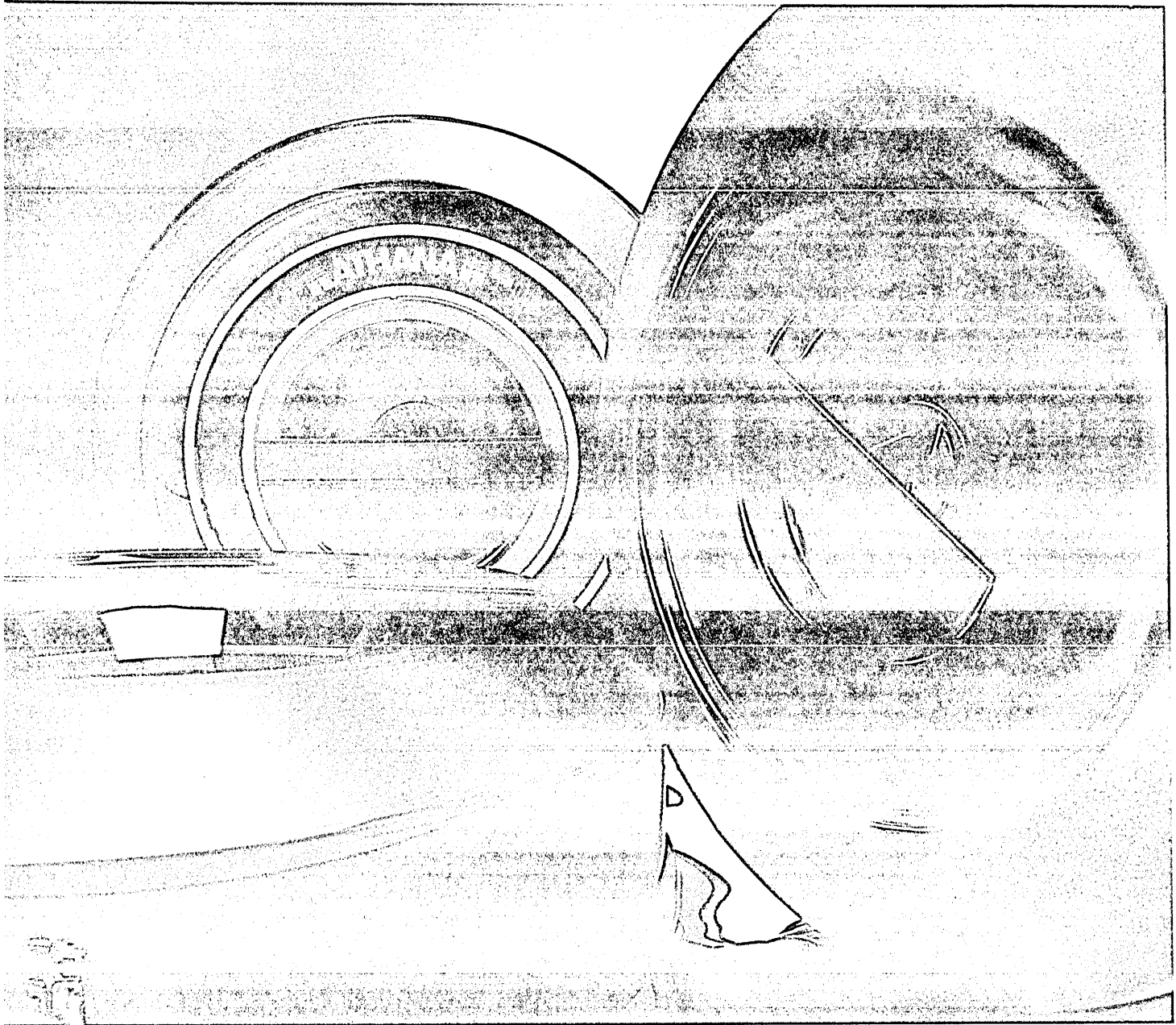

## An extraordinary value at a realistic price

**Data Cartridge Modules** are manufactured by ATHANA for all disk drives and systems which utilize these high technology product types. All ATHANA models in this product category are factory tested at the component level, servo-written, and fully certified. This quality control procedure assures the customer that the ATHANA DCM will perform in a satisfactory manner.

ATHANA produces a complete range of magnetic media products for the data and word processing industry. The quality of each ATHANA product and the service which is offered to the customer by a world-wide network of ATHANA distributors represents an *extraordinary* value.

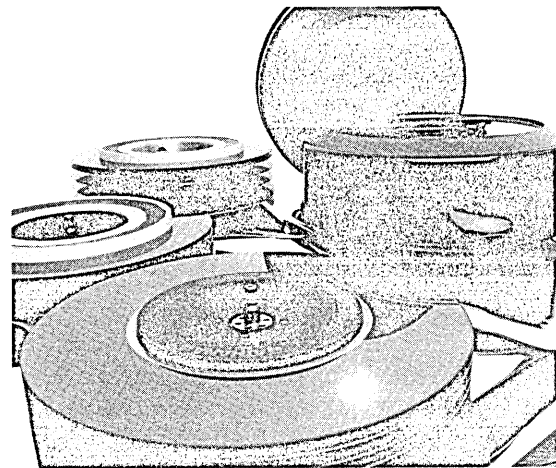

**ATHANA**

Post Office Box 3696 • Torrance, California 90510  
Telephone: (213) 775-3741 • Telex: 69-1502

# source data

SOURCE DATA provides information on books, courses, references, reports, periodicals, and vendor publications.

books

## Simulation with GPSS and GPSS V

by P. Bobillier, B. Kahan, and A. Probst

Prentice-Hall, Inc., New Jersey (1976)

511 pp.

\$18.50 (cloth)

The decision to learn to use simulation modeling as a tool may start out as an involvement but it often becomes a commitment, and I think the distinction is important. The best analogy I've heard is the one about ham and eggs: the hen was involved but the pig was committed. Hopefully, if one does pass through this metamorphic change, it will not be as painful as it was for the porker.

As soon as one experiences the breadth and depth afforded by this discipline, which remains both an art and a science, it is remarkable how many applications present themselves. Each year thousands of papers are published ranging over subjects as diverse as, for example, sawmill work scheduling, evacuation of buildings with elevators, studies of abnormal behavior, air traffic control, corporate simulation, management policy decisions, and on and on. And the popularity of this technology has only really gained momentum within the last two decades or so, roughly after the introduction of system dynamics modeling by Professor Forrester of MIT, General Purpose Simulation System (GPSS) by Geoffrey Gordon at IBM Corp., and well over a dozen other specialized simulation languages.

Models are attempts to imitate a system's behavior so as to make it possible to study and experiment with the complex internal interactions of a given sequential process of interest. Simulation permits controlled experimentation, time compression, and sensitivity analysis by changing the magnitude and distribution of the input variables. It eliminates, or at least minimizes, the disturbance caused if changes are made to a working system. And finally, it allows the experimenter to deal with problems that are totally intractable

using analytical methods. For example, it is now believed that finding an optimum scheduling algorithm for nearly any practical system of constraints and limited resources is computationally nondeterministic. Simulation allows for testing virtually any scheduling algorithm although the technique is less useful in searching for optima.

Perhaps before discussing the book a modest confession from this reviewer is in order. I learned to use GPSS several years ago as a means of solving a probabilistic queuing problem, for which the language is admirably designed, and I used Schriber (T.J. Schriber, *Simulation Using GPSS*, John Wiley & Sons, New York, 1974) as my inspiration, guide, and tutor. To date, I have not found any other text that matches the care, the comprehension, and the clarity of Schriber's work. So if what follows tends to be ever so slightly biased, I hope the reader will understand.

The text is organized along conventional lines. It reviews the basic concepts and limitations of simulation and demonstrates its utility with two discrete event simulation queuing problems (as opposed to the continuous differentials of Forrester). It then proceeds to briefly discuss the organization of a simulation study, the problem formulation, the choice of method, collection of data, error checking, validation, and critique of results. All this is presented within the first 50 pages, so the treatment is brief. However, references are included at the end of most chapters as an aid for the more diligent reader.

### Nuts and bolts

The nuts and bolts description of GPSS starts in Chapter IV, where the authors introduce some of the specialized syntax and terminology required of this high-level language. Although no attempt will be made here to describe the language—it *does* require a text to do that properly—it should be mentioned that part of the attraction of GPSS is that it is a flowchart-oriented language which uses a set of about 52 different blocks to define actions imposed on transactions as they proceed through the model. This richness can be overwhelming, so the authors choose a subset of the block-oriented instructions and describe them individually. The term "transaction" as used in GPSS refers to a unit of traffic that moves from block to block as execution of the model proceeds. For example, in a barbershop queue the customers can be considered transactions, with the appropriate statistics gathered about their

time in queue and time in process. At this point, about 25% through the volume, the first GPSS problem is presented and the reader can get a good idea as to how the parts of the program fit together. The rest of the book continues the case study approach, covering a selection of examples of increasing complexity. Major sections include simulation of an automatic warehouse, a subway system, a job shop, and a teleprocessing system. The latter example is quite lengthy and requires more than 800 lines of code to implement as demonstrated. There may be some pedagogical objection to this quantity of detail but it does demonstrate the size and structure of a practical problem. Incidentally, it also demonstrates why few people not directly involved with a model can or care to check its working details. If one is involved in using the results of a model and has not been active in its building, the best procedure is to thoroughly check the assumptions. The game is won or lost long before the results are tabulated.

The five appendices describe the job control cards and data sets; a listing of block statements and their graphical symbols; extensions to GPSS/360 made by GPSS V which is an upward compatible superset; a discussion of the generation of random numbers and variates; and a summary of the simulation languages SIMSCRIPT II, SIMPL/1, and SIMULA 67.

Interestingly, there is no section describing the important and rather complete capability built into GPSS to display error messages. Perhaps the authors were protecting the innocent student from learning that there are approximately 81 ways to make detected assembly program errors; 102 input errors; 299 execution errors; 68 output errors; and 14 warning messages. My general impression of the work is that it is a pretty good text to learn from in a course in which the student can ask questions of an instructor and have a dialog, but its dry style and dense format make it a real challenge if it is to be used as a manual for self-study. On that basis, I'll stick with Professor Schriber.

—John C. Alrich

Mr. Alrich has been involved with digits and digital systems since the early 1950s after graduating from the School of Engineering at Cal Berkeley. For the last six years he has been employed at Xerox Corp., El Segundo, Calif., where he is presently doing simulation modeling.

(Continued on page 56)

# CENTRAL INTELLIGENCE:

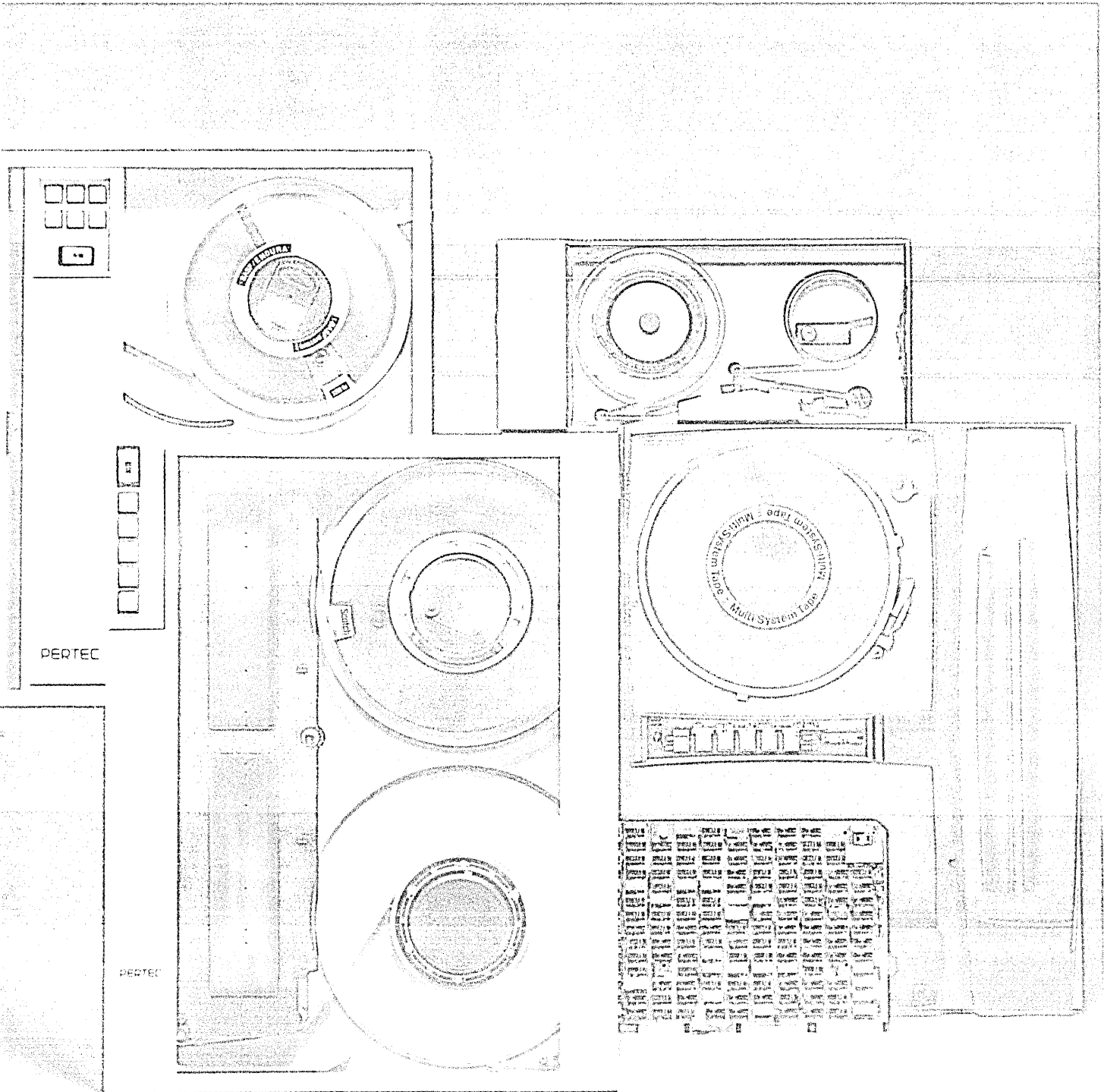



# The data formatter that came in out of the cold.

Tape drive intelligence has crossed the iron walls. And taken up residence *inside* a broad series of transports—through a special Microformatter™ that Pertec installs internally.

A real technology breakthrough for sure. But it's the hot savings potential that intrigues OEMs most.

Eliminates the need for any external formatter to control the reading and writing of data. Makes interface chores much easier.

Now add in the convenience and cost-efficiencies you'll realize with just one system to handle (and ship), instead of two separate devices.

**Saves integration time.** With the Microformatter built-in, a single interface can be used for 800 cpi NRZI, 1600 cpi PE, or dual formats.

**Saves redesign.** Formatted Tape Transports use the same Pertec industry-standard formatter interface. And the same Microformatter, to maintain parts commonality.

**Saves daisy-chain hassles.** Every master Formatted Transport can daisy-chain up to 3 more tape drives—either Pertec standards or our new Formatted models.

**Saves rack costs.** You free up former external-mount slots. And the single-board LSI

Microformatter is so compact it fits into each drive without restructuring standard rack mounts.

**Internal Formatting.** Deep down inside, you know it's right! And it's available in a flexible configuration range.

Formatted tension-arm: *FT7000*—compact 7" reel, NRZI or PE, 12.5 to 25 ips. *FT8000*—10½" reel; NRZI, PE, or dual NRZI/PE to 45 ips.

Formatted vacuum-column: *FT9000*—10½" reel, 37.5 to 75 ips NRZI, PE or dual. And *FT1000*—10½" reel, our vacuum column 125 ips high speed auto-thread, auto-load series, dual NRZI/PE.

**Fully proven product.** All are microformatted extensions of field-proven drives, produced by the world's largest independent manufacturer of peripheral equipment.

And backed by international sales/service facilities, with a long-term commitment to responsiveness. Making emergency assistance available on a 24-hour, 7-day basis, accessed through our toll-free 800 line.

At every level—product, sales, maintenance—Pertec intelligence has always recognized that cost-effectiveness is the central issue with OEMs.

- Please send full details on the Pertec Formatted Tape Transport Series.  
 Send pricing information as indicated on the RFQ below (no obligation or cost).

#### Request for Quote

Formatted Series #	Reel Size	Tape Velocity (ips)	Recording Mode	Quantity Required	Date Wanted	Send Specs
FT7000	7"	12.5-25	PE or NRZI			
FT8000	10½"	12.5-45	PE, NRZI, Dual			
FT9000 Vacuum Column	10½"	37.5-75	PE, NRZI, Dual			
FT1000 Vacuum Column	10½"	75-125	Dual NRZI/PE			

Name \_\_\_\_\_  
 Title \_\_\_\_\_ Phone \_\_\_\_\_ Ext \_\_\_\_\_

Please attach coupon/RFQ to company letterhead and return to Pertec, 9600 Irontdale Avenue, Chatsworth, CA 91311.

**For immediate requirements, call your nearest Pertec regional sales office:** Los Angeles (213) 996-1333. Ann Arbor, Michigan (313) 668-7980. Hudson, New Hampshire (603) 883-2100. England (Reading) 582115.

## PCC PERTEC

a division of Pertec Computer Corporation

# source data

(Continued from page 53)

## BOOK BRIEFS . . .

### Managing the Paperwork Pipeline: Achieving Cost-Effective Paperwork and Information Processing

by Monroe S. Kuttner  
John Wiley & Sons, Inc.  
Somerset, NJ 08873  
244 pp.

(1978)  
\$20.95

After making the argument that efficiency is not the same as effectiveness, the author spends the rest of the first half of the book explaining the planning and preparation steps for his particular plan for clerical effectiveness. The plan, entitled PACE (Program for the Advancement of Clerical Effectiveness), emphasizes the user's understanding of his own "paperwork pipeline" such that improvements can be made where needed (rather than being made, for instance, where they are popular). Much attention is given to staff organization and tasks. The last half of the book covers management techniques for the director or leader of the PACE clerical effectiveness program,

in "how-to" style. It also aims to give managers "enough information to prevent outside consultants or methods people from doing what they do best even though it may not be what the organization needs most to improve its clerical effectiveness." This book may be too analytical for some people, but is likely to be useful to an organization interested in overhauling its entire method of paperwork processing, which the author calls the "Achilles heel of business and government." Mr. Kuttner is manager, management advisory services, for the American Institute of Certified Public Accountants.



### Data Multiplexors

"One very important aspect to be realized is the development and adoption of protocols and access methods in host computer software so the reality of single-ended ITDM's going into a computer or computer front-end becomes a common and easily attainable result. The unwillingness of major computer

users to diverge from vendor-supported software will present some problems to the more innovative ITDM suppliers, who will find themselves getting more deeply involved with user computer programming than they might wish. Nevertheless, the trend toward the use of ITDM's, in the context of coming satellite TDMA environments, presents some interesting opportunities to the more agile data communications equipment vendors."

This articulate analysis is from a new report on data multiplexors which covers not only the state of the technology and the present projected market composition, but also contains results of a valuable user survey which includes such topics as the evolution of data communications management, multiplexor usage, and expected changes to come with the advent of sbs. Also discussed are preferential relationships that exist between certain suppliers and common carriers. From INTERNATIONAL RESOURCE DEVELOPMENT, INC., 125 Elm Street, P.O. Box 1131, New Canaan, CT 06840 (203) 966-5615.

### Forms Glossary

International Paper offers a nicely put together glossary for the business forms industry. It should be useful to users, suppliers, and manufacturers. There are clear diagrams of some major terms, such as the various nonimpact printing processes. \$2 from INTERNATIONAL PAPER CO., 220 East 42 St., New York, NY 10017.

### Information Center Study

Between 1970 and 1975 ten federal agencies under the name of USAC (Urban Information Systems Inter-Agency Committee) provided funding to six municipalities for the development of computer-based information systems that automated selected municipal functions, mostly delivery of services, with the by-product of data for management decision making. At the end of the project, the Dept. of Housing and Urban Development, lead member of USAC, gave rise to a support panel whose purpose was to evaluate the results of the USAC program. One major recommendation of the support panel was for the establishment of a national urban information systems resource center for research, technical assistance to local governments, and dissemination of information learned in the process. Because of the size and cost of such a project (projected cost for operation over a five year period is estimated at \$9 million), further study was deemed necessary. Public Policy Research Organization of UC Irvine was chosen (by HUD) for the task in view of its previous related research. The work of PPRO, which was supported by the

(Continued on page 61)

## NOW! A Complete Environment For Transaction Processing

### 1.) TAPS HAS ADDED A DATA MANAGER WITH...

- a) Automatic interfaces to your data from a CRT.
- b) English language retrieval using boolean questions.
- c) Real-time report writing to CRT's and Printers.
- d) Backout/Restart; Full Security; Inverted Index.

### 2.) TAPS BEST-SELLING APPLICATIONS MANAGER WITH...

- a) On-line building of Screens and Transactions.
- b) Twenty-two time saving utilities.
- c) Transparent interfaces to CICS, IMS/DC or other CM.

### 3.) TAPS SUPER-FAST COMMUNICATIONS MONITOR WHICH...

- a) Runs on minis and IBM Mainframes.
- b) Interfaces with all terminals.
- c) Permits inter-CPU communications.

### 4.) TAPS INTEGRATED TRANSACTION PROCESSOR WHICH...

- a) Builds on-line systems/products fast.
- b) Protects systems/products from operating systems, communications monitors, terminal networks and DBMSs.
- c) Permits systems/products to be moved from IBM Mainframes to HP3000, Interdata 32, DEC 11, and Series 1.

### DECISION STRATEGY CORPORATION

(800) 223-6548  
(212) 687-2660

708 Third Avenue  
New York, New York 10017

CIRCLE 146 ON READER CARD

# How Diablo improved my appearance.

By A. Letter

I didn't always look this good.

Sometimes I was even embarrassed to go out of the office. Then one day, my boss introduced me to the Diablo 1355 WP metal-clad print wheel. Suddenly my characters were coming out crisp. Proportionally spaced. And uniformly dense.

Since I discovered that Diablo has over 100 type styles, I'm never bored either. There's 88 characters to choose from in English. And 92 in foreign fonts. And the future looks even better. Because soon there will be 96 characters to choose from.

And thanks to the Diablo 1355 WP, I never have to worry about keeping up with the pace. Because the metal-clad wheel prints 40 characters-per-second.

It's durable too. In fact, the wheel that printed me today was no youngster. It was over 16 million characters old, but you'd never know it to look at me.

Not that I'm vain. But I am "camera ready" as soon as my page is finished.

And in my line of work it's important to make the right kind of impression.

Of course, it's only since they started using the Diablo 1355 WP metal-clad print wheel that I really became letter perfect.



## XEROX

Diablo and XEROX® are trademarks of XEROX CORPORATION.

CIRCLE 8 ON READER CARD

# Introducing the Norand<sup>®</sup> 101 Portable Data System

CIRCLE 107 ON READER CARD

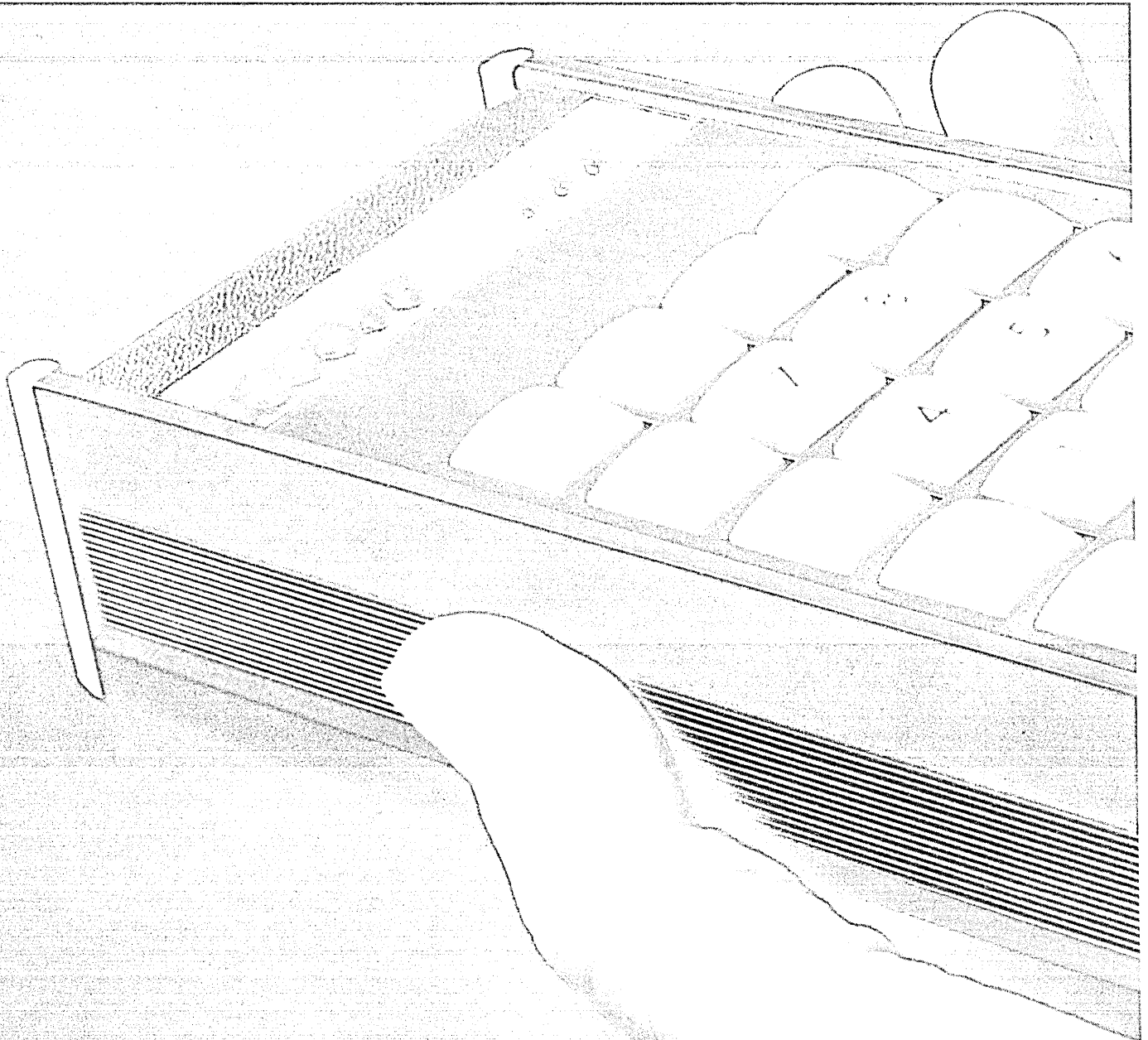



## THE PROGRAMMABLE TWO-WAY LINK TO YOUR COMPUTER

For years it's been a problem — some people compiling field data by hand to be fed into a computer. Or perhaps you simply couldn't find a device to do what you needed to do.

That was yesterday. Today, the Norand® Terminal for Remote Data System™ uses an ordinary telephone to send data to — and receive it from — your central computer.

The microprocessor technology built into the Norand TD makes it totally programmable — your particular business procedures could have to change to fit the unit.

Your Norand TD control program assures the accuracy of the data entered, and the unit's alphanumeric display guides your people through the program sequences. The display "instructs" your operators in their own language, whether it's cases, pounds, hours, dollars, etc.

For more information, contact the Norand Terminal, which can be seen with the Norand TD opened. It has an "out of order" lamp and a display screen, and can be used for many other applications. For more information, call the Norand Corporation, or call 1-800-573-5427, EXT. 119.

© 1984 Norand Corporation. All rights reserved. For more information write the Norand Corporation, or call 1-800-573-5427, EXT. 119.

There is a difference.

### COMPUTER SYSTEMS

1500 E. 17th Street  
1500 East Street S.E. Seattle, WA 98104



A subsidiary of a member of the Best Products Group.

Norand Corporation is a total communications, computer and software solutions provider for pharmacy companies. 1-800-573-5427. For more information.

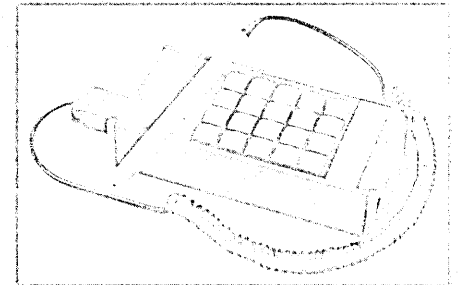
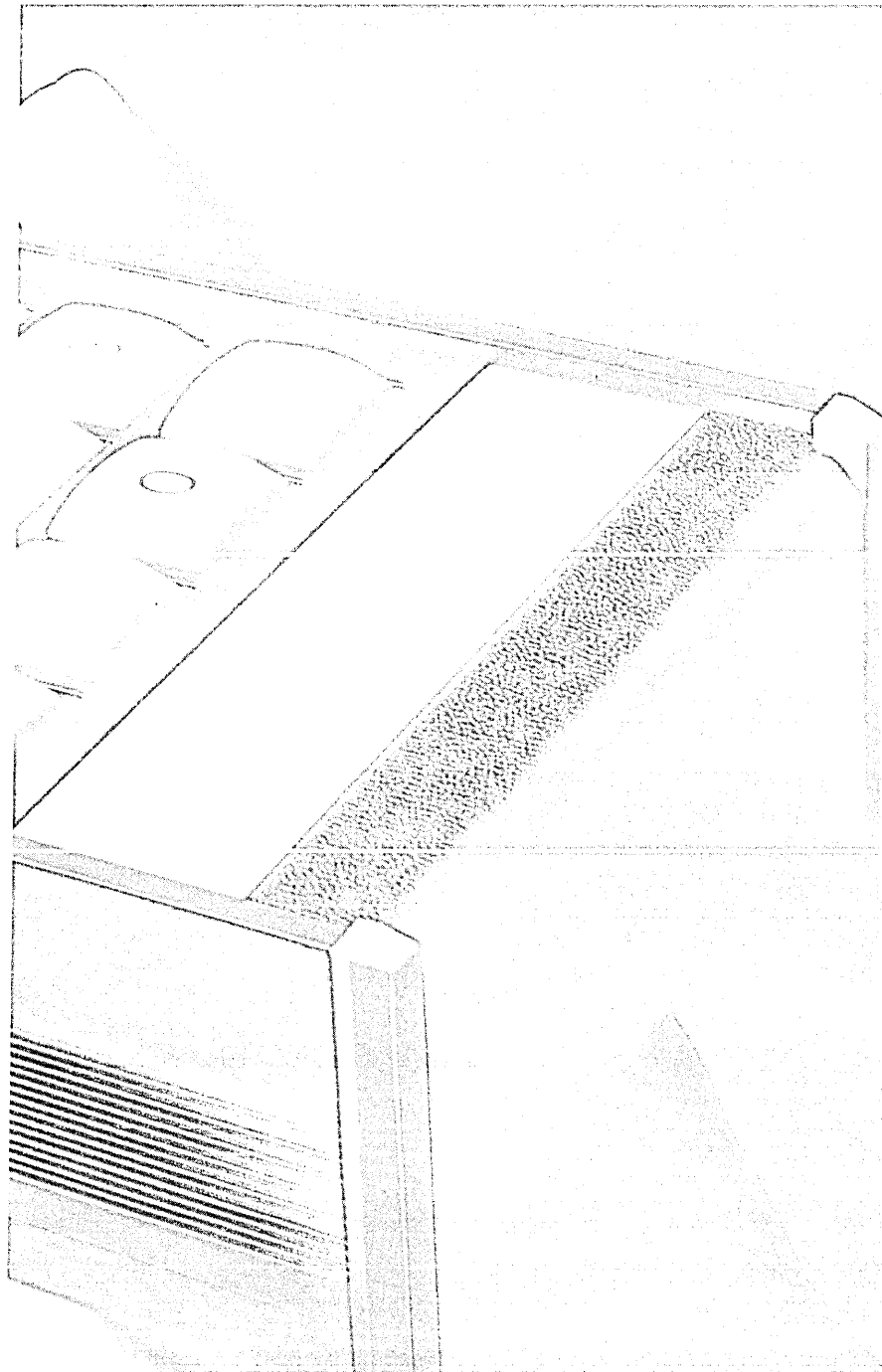

Optional wand scanner reads bar codes.

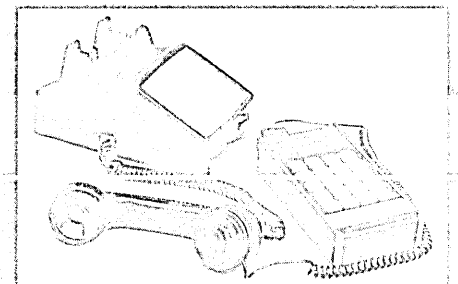

Telecommunicate over an ordinary telephone. Acoustic coupler shown here.

# A 32K byte dual floppy microcomputer system for only \$2900\* complete.

## Standard Features:

- Dual 8" floppys store 500,000 characters on line
- 32K bytes of static RAM
- RS-232 C at 75 to 19,200 baud
- 16 line parallel I/O
- Rack or tabletop mounting
- UL-recognized power supplies
- BUS oriented computer architecture
- Four slots used — four slots open for expansion
- Comes complete with disk BASIC
- Includes Interactive Assembler/Editor
- Main processor is an ultra-fast 6502A
- Has auxiliary Z-80 and 6800 micros which allow execution of virtually all 6502, 6800, 8080 and Z-80 code!
- User programmable interrupt vectors on all three micros

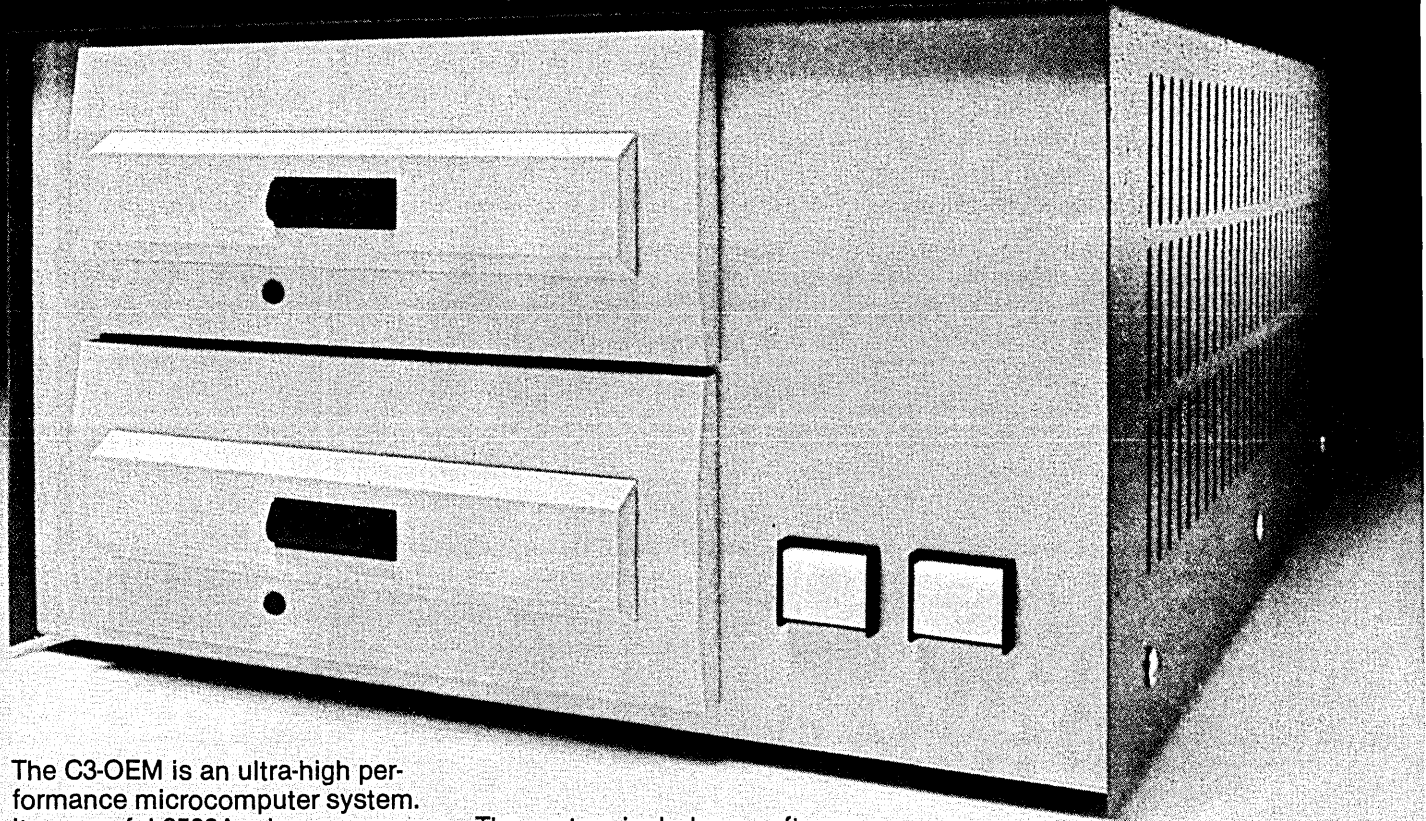

The C3-OEM is an ultra-high performance microcomputer system. Its powerful 6502A microprocessor (now triple sourced) out-benchmarks all 6800- and 8080-based computers in BASIC and machine code using the BASIC and assembler provided standard with this system.

In fact, the C3-OEM executes standard BASIC language programs at speed comparable to small 16 bit minicomputers.

Ohio Scientific has a vast library of low cost software for the high performance 6502A including an on-line debugger, a disassembler, several specialized disk operating systems and applications programs such as our word processor package and a data base management system. However, the C3-OEM is not just limited to 6502 based software. This remarkable machine also has a 6800 and a Z-80 microprocessor.

The system includes a software switch so that machine operation can be switched from one processor to another under software control!

So, one can start with existing 6800, 8080 or Z-80 programs while developing new software for the ultra-high performance 6502A.

The C3-OEM isn't cheap. It's a quality product with mechanical features like UL-recognized power supplies, a three-stage baked-on enamel finish and totally modular construction.

It is the product of Ohio Scientific's thousands of microcomputer systems experience. In fact, all the electronics of the C3-OEM have been in production for nearly a year and have field proven reliability. And, best of all, this machine is available now in quantity for immediate delivery!

A full spectrum of add-ons are now available including more memory, up to 16 serial ports, 96 parallel I/O lines, a video display, a parallel line printer interface and a 74 million byte Winchester disk drive.

\*25-49 unit price  
1-4 \$3590.  
5-9 \$3300.  
10-24 \$3100.

Phone (216) 562-3101  
or write for more information  
and the C3-OEM representative  
in your area.

**OHIO SCIENTIFIC**

1333 S. Chillicothe Rd.  
Aurora, OH 44202

# source data

(Continued from page 56)

National Science Foundation, included nationwide surveys of city and county information systems. The report recommends that the urban information center be created and federally funded for five years, with initial programs directed at the improvement of information for management, urban financial management capabilities and transfer of computer applications among local governments. The report, entitled "A National Information Systems Resource Center: Assessment of Need and Concept; Final Report," also discusses plans for implementation and periodic evaluation of the center's effectiveness. Copies of the report are available free of charge (while supplies last) from Dr. Kenneth L. Kraemer, Director, PPRO, Univ. of California, Irvine, CA 92717.

## Preprocessor for Productivity

Functions and benefits of preprocessors for COBOL programmers are described in this report. The author's research and experience are the basis of the discussion and case studies; also included in the report are descriptions of fourteen selected COBOL preprocessors, an overview of COBOL aids, suggestions for implementation, and references. \$12 prepaid from SHETAL ENTERPRISES, Dept. DNPR, 1787 B West Touhy, Chicago, IL 60626.

## Maintenance Marketplace

Originally the documentation of a multiclient study, the comprehensive four volume report *Maintenance Considerations in the Information Handling Marketplace* is being made available to the public. Presently available are Vol. 1, an executive summary of the research; Vol. 2, an overview and analysis of the personal computing marketplace, including maintenance considerations; and Vol. 4, a report on maintenance of dp equipment in the federal government. Yet to be published is Vol. 3, covering maintenance considerations in the business automation marketplace.

A companion volume, *The Kernel Planning Method*, explains the research methodology used, and is the only one of the volumes that is available separately. The "method" is a collection of formal techniques for identifying user needs and segmenting markets. The "kernel" is a discrete segment of a market or plan; the planning method attempts to develop from these kernels a generic corporate process with which market analysis and planning can be systematically applied to a given marketplace.

*The Kernel Planning Method* sells for

\$195. The five-volume set includes two copies of each volume and is priced at \$6,000. ALLTECH PUBLISHING CO., 212 Cooper Center, North Park Drive & Browning Road, Pennsauken, NJ 08109 (609) 662-2122.

## Audit and Control

Mr. William Perry, director of professional practice at the Institute of Internal Auditors, estimates that only 10% of auditors have an understanding of data processing, leaving a large number of auditors unqualified for today's business environment. This lack of dp qualification is attributed largely to the traditional separation between dp audit and internal audit groups. Mr. Perry dis-

cusses changes in the concept of audit and recommends solutions by way of control methodology, the involvement of auditors in systems development, training and qualifications of dp auditors, audit techniques, and senior management involvement. Much of the discussion is in response to an IBM-funded SRI study of computer audit and control, which Mr. Perry recommends as background material (available from IBM or, for a fee, from the Institute of Internal Auditors). "Systems Audability and Control," Vol. V, No. 1 of FAIM's Current Technology Report, is clearly and pleasantly written, and includes questions and answers and a bibliog-

(Continued on page 66)

## TERMINALS FROM TRANSNET

### PURCHASE 12-24 MONTH FULL OWNERSHIP PLAN 36 MONTH LEASE PLAN

DESCRIPTION	PURCHASE PRICE	PER MONTH		
		12 MOS.	24 MOS.	36 MOS.
DECwriter II .....	\$1,495	\$145	\$ 75	\$ 52
DECwriter III .....	2,895	275	145	99
DECprinter I .....	2,495	240	125	86
VT52 DECscope .....	1,695	162	85	59
VT55 DECgraphic CRT	2,695	260	135	94
ADM 3A CRT .....	875	84	45	30
ADDS Regent 100 .....	1,325	126	67	46
TI 745 Portable .....	1,875	175	94	65
TI 765 Bubble Mem. ...	2,995	285	152	99
TI 810 RO Printer .....	1,895	181	97	66
Data Products 2230 ...	7,900	725	395	275
QUME, Ltr. Qual. KSR .	3,195	306	163	112
QUME, Ltr. Qual. RO ..	2,795	268	143	98
FlexiFile 21, Flpy. Disk	1,995	190	102	70

FULL OWNERSHIP AFTER 12 OR 24 MONTHS  
10% PURCHASE OPTION AFTER 36 MONTHS

## ACCESSORIES AND PERIPHERAL EQUIPMENT

ACOUSTIC COUPLERS • MODEMS • THERMAL PAPER  
RIBBONS • INTERFACE MODULES • FLOPPY DISK UNITS

PROMPT DELIVERY • EFFICIENT SERVICE



**TRANSNET CORPORATION**  
2005 ROUTE 22, UNION, N.J. 07083  
**201-688-7800**

CIRCLE 170 ON READER CARD

# For Intelligent Family Planning

Buying intelligent terminals . . . think Ontel! We've planned and engineered our family of intelligent terminal systems to meet maximum OEM user needs. With the recent introduction of the Ontel OP-1/R, the first truly user-programmable intelligent terminal in its price range, we've broadened our product family. We now offer powerful cluster systems. Master terminals coupled with intelligent slaves provide unique distributive processing capabilities.

Ontel terminals are more than just well-designed, flexible and reliable . . . they're low-cost total systems all engineered to complete *your* systems family.

#### Buying Intelligent Terminals? Think Ontel!

Supplying the software you need is a must. We offer 3 high level languages, forms generation, word processing, text editing, extensive utilities and diagnostics . . . all running under Ontel's Disk or Diskette Operating System. Ontel software enables our users to reduce their development costs for a multitude of different applications.

A few more facts. Ontel terminals have a modular structure with up to 64K of memory and are designed for field upgrade. They're easily programmed and have a full range of controllers including communications, mass storage and printer interfaces.

# Think Ontel

**Contact Us Today For the Intelligent Answer**

Edward J. Heinze  
National Sales  
Manager

**Ontel Corporation**  
250 Crossways Park Dr.  
Woodbury, NY 11797  
(516) 364-2121







## An intelligent solution to image and graphic display problems Higher performance + lower price = optimum systems by Aydin Controls

THE NEW AYDIN CONTROLS Model 5216 Display Computer is the intelligent solution to your graphics and image processing display requirements. Why be locked into the limited capability "packaged terminal" approach now prevalent in the industry? The Model 5216 consists of a family of functional hardware and software modules from which you may configure a display system for stand-alone operation or for integration into your system. Simply select those modules which are consistent with your application. The Model 5216 provides multi-processing capability and multiple buss architecture for separate input/output, display processing, and display refresh functions to enhance system performance and flexibility. Whether you need a low-end alpha/graphic color terminal or a sophisticated multi-image, high resolution image processing display system (or anything in between), the Model 5216 display family is your answer.

### SALIENT FEATURES

- High-performance multi-processor buss architecture
- Pixel or graphic DMA block mode data transfer (800 nano-seconds per 16-bit pixel)
- Multiple pixels per word
- Wide selection of display formats including 512 x 512 x 64, 1024 x 1024 x 16, and up to 1024 x 512 x 16 bits per pixel at 60 Hz refresh rate
- Video pro-

- cessing through look-up table RAM at bit rates to over 40MHz
- Built-in vector and circle generation
- Four sizes of alpha characters
- High speed hardware math
- Both parallel and serial peripheral interfaces available
- User programmable.

### STANDARD HARDWARE MODULES

- Processor Module (16-bit)
- Processor Expansion Memory (up to 1 megabyte of PROM or RAM)
- Memory Buss Controller (sync and control)
- CPU I/O Module (DMA to host)
- Video Modules (several types available)
- Memory Modules (display formats from 256 x 256 to 1024 x 1024 x 16)
- Mass Storage Controllers (floppy disk and magnetic tape)
- Zoom Controller (2X, 4X, 8X and 16X)
- Hardware Math Modules (including vector/circle)
- Alphanumeric Channel Module (80 x 48 format, 256 unique symbols, 8 colors).

### STANDARD SOFTWARE MODULES

- AYDOS Operating Systems
- Software Support Modules
- AYGRAPH 2D or 3D Graphics Modules
- AYGRAPH Image Processing Modules
- Emulation Modules.

Configure your system from the Model 5216 family of Hardware and Software Modules and prove to yourself the cost/performance advantages of AYDIN CONTROLS for your application.

**AYDIN**  **CONTROLS**

444 Commerce Drive • Fort Washington, Pa. 19084

Phone (215) 542-7800 • TWX (510) 661-0518

One source for all your CRT display requirements

CIRCLE 19 ON READER CARD

“If you're scared,  
you make a decision  
that's safe.

If not, you make  
a decision that's right.

What we try to do  
is remove the fear.”

Tom Knight  
Product Manager



# 370 Add-on Memory

“We really believe that you can't do better than National's add-on memory for your IBM 370 computer. And so do a lot of other people. So I tell customers, 'look, right now there are hundreds of IBM 370's in the field using National Semiconductor memory. If you haven't heard our name it's only because until now, we haven't been selling directly to end users.'

But we actually have a larger share than anyone else in the 370/158 and 168 add-on market. We've delivered over 1200 megabytes. And with 30% of our business today going

to upgrading existing customers, we must be doing something right.

Now, National is offering 370 add-on memory direct — both the 158 and 168 models, as well as our Universal Memory, which interfaces with IBM's 135, 138, 145, and 148 processors.

I really believe we know more about 370 memories than even IBM. Because not only do we have to know intimately every component that goes into our products, we also have to know the IBM CPU's to which our products attach. This knowledge lets us make our memories less expensive

than IBM's, and better — than IBM's or anybody else's.

*Beat the heat.*

We build our IBM add-on memory with top-drawer, high density chips. All the bits work. So unlike most of our competitors we need no back up chips, no extra circuitry.

Our switching power supplies are twice as power efficient as linear units. They dissipate far less heat.

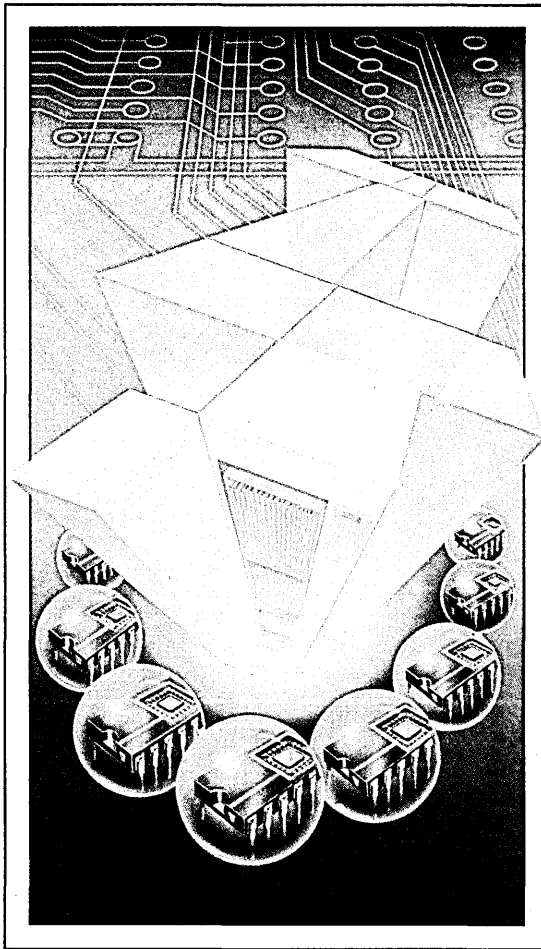

Which means we can run cooler on less power than any other 370 add-on anywhere. And they keep the juice flowing during power interruptions as long as 50 milliseconds.

Size? Our add-ons are the most compact in the industry. Sixteen megabytes can fit into a single frame.

You'd be shocked at how many times we make a sale just because our units fit where others won't.

For easy maintenance, our memory components are socketed. So in the rare event of a failing component, it alone needs to be replaced, instead of a whole printed circuit card.

We also make full use of IBM's error correction circuitry. Single-bit errors have no effect on system operation. Our advanced error detection circuitry and software diagnostics allow us to identify and replace failing components during scheduled maintenance. And with single-bit errors under control, double-bit errors just don't happen.

*Take a bold step.*

You know and I know that your D.P. budget is spent for system performance. Extra memory means extra performance. And National gives you more memory for your money. The equation is simple.

We understand the "safe" feeling you get by going with IBM memory. But consider. National has a bigger market share than any other independent supplier. We've been deeply committed to 370 add-on memories for years. We can meet all your 370 add-on requirements, whatever they may be, now and in the future.

If you still feel safer with IBM memory from IBM, fine. But if you want to take that bold, bold step and find out more about IBM System/370 add-on memory from National, contact me personally: Tom Knight, Product Manager, National Semiconductor Corporation, Drawer 3, 2900 Semiconductor Drive, Santa Clara, California 95051."

**Computer Products Group**  
≈ National Semiconductor Corporation

# source data

(Continued from page 61)

raphy of related reading. \$25. FAIM TECHNICAL PRODUCTS, INC., P.O. Box 1013, Melville, NY 11746.

## Medical Software

A directory of medical applications featuring 158 vendors is offered by Washington University's Biomedical Computer Laboratory for a mere \$1.25. Information on each program includes the percentage of software development effort spent in custom-tailoring to meet individual requirements and how widely

used the program is. Vendor information includes the company's emphasis and addresses and telephone numbers. Also included is a suggested systematic methodology for vendor selection. Contact: Mrs. Polly Raith, Monographs Secretary, Biomedical Computer Laboratory, Washington University, School of Medicine, 700 Euclid Ave., St. Louis, MO 63110.

## Remote vs. In-House

Herbert A. Seidman has put together a report analyzing the buying rationale of users faced with the in-house computing vs. computer services decision. Both users and vendors were interviewed. Reportedly surprising answers were

found to such questions as, "Is cost a primary motivator?" Down-time problems and their relevance to the in-house decision, migration paths of various types of dp consumers, and long range strategies are also explored. *Remote Computing Services vs. In-House Computers: An Analysis of the User's Choice* is \$750. SBS PUBLISHING, 4320 Stevens Creek Blvd., Suite 190, San Jose, CA 95129.

## Series/1 Users

Nearly 50 current users of the IBM Series/1 were interviewed for this report on user experience with the Series/1, including installation, problems with hardware and software, and analysis of user configurations and applications. Also discussed are where IBM will most likely expand the Series/1, potential market areas, data base management methods, and the displacement of other equipment by the Series/1. Price: \$175. SBS PUBLISHING, 4320 Stevens Creek Blvd, Suite 190, San Jose, CA 95129 (408) 243-8121.

## Tech Control

A March supplement to Auerbach's Data Communications Management series is available separately which discusses symptoms and probable causes of problems encountered in a multivendor data network. Diagnostic techniques and equipment are detailed. "Putting the Finger on Finger Pointing: A 'How-To' Manual on Tech Control" is \$10 (prepaid). AUERBACH PUBLISHERS, INC., 6560 North Park Drive, Pennsauken, NJ 08109.

## World Calendar of Shows

This regularly updated eighteen page listing of high technology exhibits and conferences is impressively international: countries from A to Z are listed, with dates, titles, and locations of upcoming events. Copies are free. TWI INTERNATIONAL EXHIBITOR SERVICES, 1120 Karlstad Drive, Sunnyvale CA 94086 (408) 745-7500.

# The picture worth a thousand words

Our new Series 600 Desktop Plotters. Providing simple, dependable, and responsive graphics which will convert literally masses of computer data into quickly interpreted, easily reproduced graphics. The Series 600 Plotters cost less. With unit prices starting at \$1,995. The Series 600 are among the least expensive plotters on the market. And they are easy to operate. Both the Series 600-050 and the 600-050 use readily available roll of format paper and are virtually maintenance free. They even take up less room. The Series 600 Plotters measure 19" x 15" x 27" and weigh only 30 lbs. And because they use standard size sprocketed format paper, full business paper filing is less of a problem than ever before.

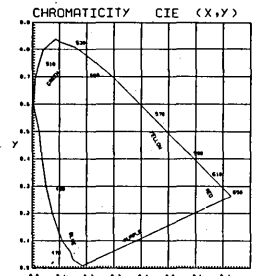
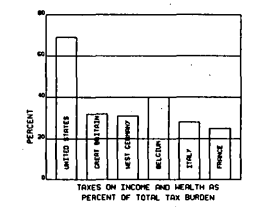
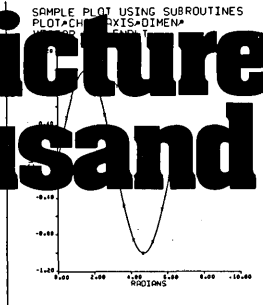

Small but mighty, the Series 600 Plotters are quite possibly the most versatile and functional desktop plotters ever made. They may be programmed for as many as 29 plotting functions, anything from alphamatics in any size, style or language to simple charts to complex maps and diagrams to any and every combination thereof. The Series 600-050 model is universally interfaced to operate with any computer through an RS232C Data Port. It plots at a speed of 1.9 in/sec. to 3.8 in/sec. The 600-050 model features a parallel port to computer interface. Write today for complete information on the new Series 600 Desktop Plotters.

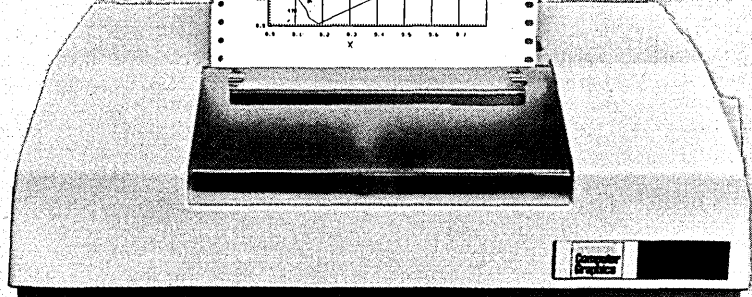

## Broomall Series 600 Desk Top Plotters

Yes, I'd like to know more about the 600 Series Desktop Plotters.

Name \_\_\_\_\_

Company \_\_\_\_\_

Address \_\_\_\_\_

City/State/Zip \_\_\_\_\_

Phone \_\_\_\_\_

**BFI**  
Broomall Industries, Inc.  
700 Abbott Drive,  
Broomall, Pa. 19008  
Telephone 215-328-1040

CIRCLE 121 ON READER CARD

# vendor literature

## Personal Computers

Tandy Computer's catalog may well become the Montgomery-Wards catalog of personal computing. In addition to including its sister-division Radio Shack's TRS-80 microcomputer, TC's catalog features processors from IMSAI, Vector Graphic, Technical Design Labs, Polymorphic Systems, Icom, South West Technical Products, and others.

(Continued on page 72)





**A Show and Conference**  
for  
**Vice Presidents in Charge**  
of  
**Information Management**  
(And for those who plan to be.)

**Mail the attached card** for complete details on the  
Fifth International Information Management Exposition & Conference  
McCormick Place, Chicago, Oct. 16-19, 1978  
or write: Clapp & Poliak Inc., Management, 245 Park Avenue, New York, NY 10017

New Developments from Systems...

# The New MOS

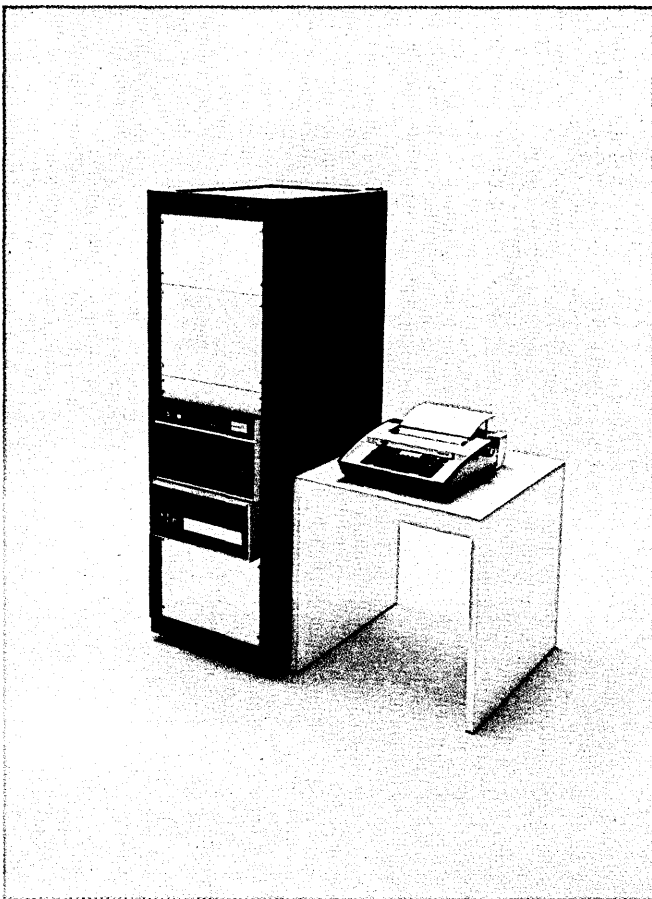

SEL 32/5720

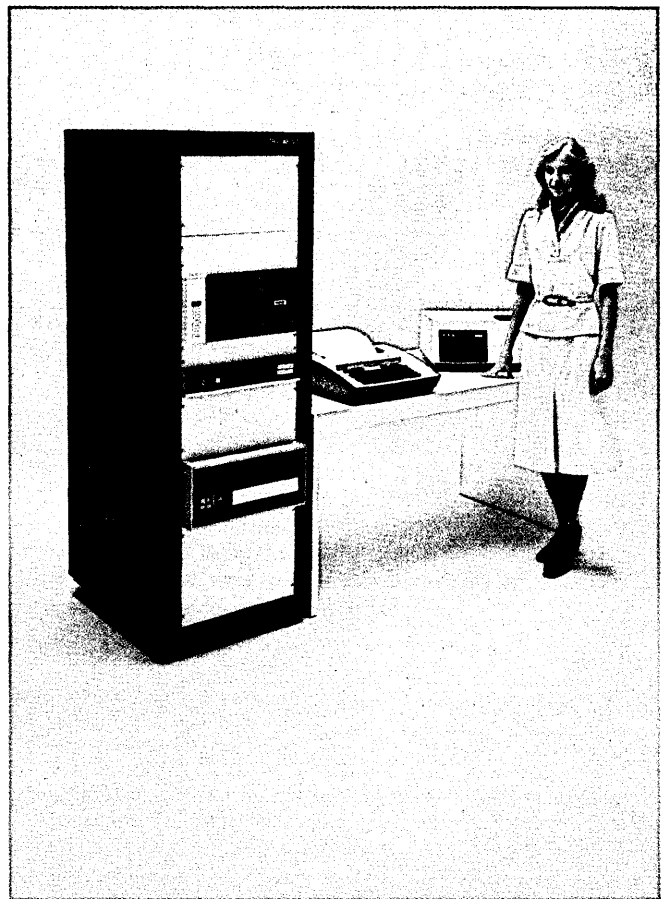

SEL 32/5730

Until now, you've either had to forego 16-bit pricing to get 32-bit performance, or you've had to give up 32-bit performance just to keep the budget in line.

No longer. Now you can invest in a full-blown 32-bit computer system and pay no more than you would for a 16-bit computer. And not have to worry about insufficient power for future needs.

Here's why: value engineering. We've taken our high-performance 32-bit computers, and

we've done some packaging that makes sense. We've added MOS memory. Expanded and fine-tuned our operationally-proven software. Made our systems more compact, more efficient. And we put it all together for a third less money.

The result? A broad family of 32-bit computer systems, perfect for jobs that require high thruputs like telemetry, seismic exploration, or research. Or for jobs that need lots of I/O; process control, simulation, or laboratory automation.

All are upward-compatible, so you can still grow, but start with a minimal investment.

If you'd like to have real performance, but can't overlook how effectively you use your budget, talk to us. We'll make sure that when you invest in SYSTEMS computers, more dollars will flow to your bottom line.

Call us. We're easy to talk to (305) 587-2900  
6901 West Sunrise Boulevard  
Ft. Lauderdale, Florida 33313.

# Packaged Systems.



SEL 32/5740



SEL 32/5750

# SYSTEMS

ENGINEERING LABORATORIES

# source data

(Continued from page 66)

And then there are terminals, both from the personal computer companies and mainstream dp firms, such as Lear Siegler, Soroc, and Intelligent Systems Corp. to name a few. Need a printer? They've got them, from more than half-a-dozen sources. Floppy and cassette units? They're in the book. For those doing custom hardware, there's components, pc boards, and tools. There also are sections on software and books. And, in what may be its first offering to the personal computing market, Computer Automation's Naked Mini-4 is offered, starting at the bare board and ranging up into a full system. This 52-page, four-color catalog is the nicest looking, and one of the most comprehensive, personal computing booklets we've seen to date. TANDY COMPUTERS, Fort Worth, Texas.

**FOR COPY CIRCLE 439 ON READER CARD**  
**Computer Security**

"Guidelines for Establishing a Computer Security Program" is intended to provide useful information and a practical framework for organizations which previously have not had the time or resources to implement an effective security program. The 12-page handbook presents, in outline form, the remarks of

Capt. Daniel Fannin (Dept. of Defense Computer Institute) at a workshop he led at this society's Fourth Annual Computer Security Conference, held last November. Major topic headings include "initiation of the computer security program development process," "security program development phases," "vulnerability/threat/risk analysis," and "planning for the analysis and design phase." COMPUTER SECURITY INSTITUTE, Hudson, Mass.

**FOR COPY CIRCLE 440 ON READER CARD**

## Data Communications Monitoring

The EMS-One Event Management System for monitoring and diagnosing data communications networks is described in a six-page, four-color brochure. The brochure covers automatic monitoring, automatic preventive maintenance, manual mode, and self-learn operating modes. System architecture and system capacity are explained. A functional block diagram shows one possible configuration. INTERTEL, INC., Burlington, Mass.

**FOR COPY CIRCLE 441 ON READER CARD**

## Mini/Micro Catalog

Mini and microcomputers—ranging from PDP-11/45 down to single board microcomputers from IMSAI, Cromemco, and MOS Technology—are included in this 72-page, illustrated catalog. Also included are printers, terminals, discs,

media, books, and tools. Many of the descriptions go to great lengths to provide useful, relevant information. For instance, the two-page description of Commodore's PET personal computer includes the data readers would expect—specs, service, delivery—and a rather unexpected section headed "When Not to Buy a PET" (when you want to use 8080 software or S-100 bus cards, or when you want quick delivery). NEWMAN COMPUTER EXCHANGE, INC., Ann Arbor, Mich.

**FOR COPY CIRCLE 442 ON READER CARD**

## Auditing Checklist

"Checklist for Performing DP Department Review," a two-page set of audit review questions, covers planning, management and organization, system controls, standards, personnel, and security. Prepared from audit guidelines used by accounting firms, the checklist also is contained in this vendor's audio cassette training course, Auditable Internal Control Systems (AUDICS). Contact the vendor for a free copy of the checklist. INFO 3, Woodland Hills, Calif.

**FOR COPY CIRCLE 443 ON READER CARD**

## Books

It takes 52 pages to list and describe the 600-plus books available from this publisher. "Computers, Calculators & Microprocessors" and "Hobby Electronics" are just two of the many sec-

(Continued on page 78)

# Send me the news

varian  
graphics

The first name in printer/plotters.

- "Printer/Plotter Considerations," a short course on electrostatic printing/plotting
- Actual samples from a Varian Graphics printer/plotter
- Varian Graphics hardware and software product line information

Also put me on your mailing list  Call me at (\_\_\_\_\_) \_\_\_\_\_

Name \_\_\_\_\_

Organization \_\_\_\_\_

City \_\_\_\_\_

State \_\_\_\_\_ Zip \_\_\_\_\_

Application(s) \_\_\_\_\_

Computer: \_\_\_\_\_

Operating System: \_\_\_\_\_



varian

611 Hansen Way, Box D-106, Palo Alto, California 94303  
(415) 494-3004/TWX 910-373-1731

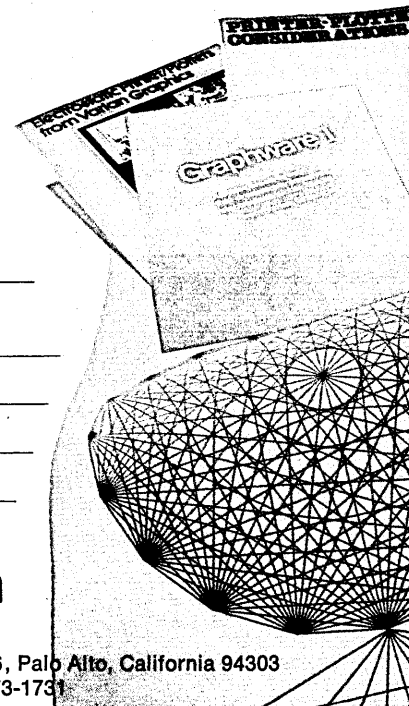



# Find out what's new in hard copy graphics from the people who were first

Varian  
graphics

When Varian introduced the first commercial electrostatic writing device in 1967, we set the pace in electrostatic graphics. That hasn't changed. Varian Graphics continues to provide the industry standard in quality, resolution and reliability—plus microprocessor intelligence, a variety of computer interfaces, comprehensive software and exceptional service.

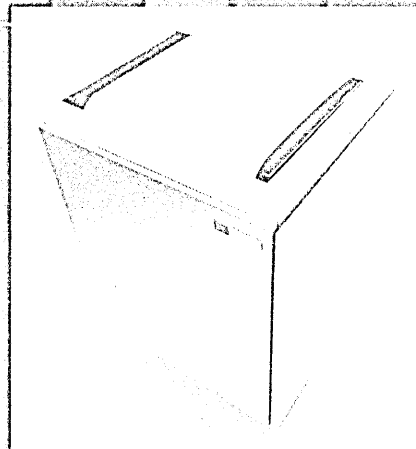

For an update on the latest in hard-copy graphics, mail the coupon (opposite), or call us at (415) 494-8000.

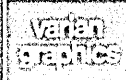
	<input type="text"/>
---	----------------------

*The first name in printer/plotters.*

611 Hansen Way  
Palo Alto, California 94308  
TWX: 910-874-1781

# THE SEARCH IS OVER

# NCS

## THE COMPUTING SYSTEM YOU'VE BEEN LOOKING FOR.

If you're responsible for a company subsidiary, division, department or operation with an eight-figure annual budget. And, if you're looking for your own computing system to handle your data processing workload. Then you know, and we know, you've got a tough job.

Because, up until now, you've been relying on someone else's computer—either in-house or timesharing. And, chances are, that computer is IBM-oriented. So, what you're looking for in your own computing system is one most like what you've been using.

And that's where your difficulties begin.

Since you can't find a system that will let you do things the way you're used to doing them, you face monumental problems. With program conversions. With people training. And, with hardware costs.

You're also concerned about adding applications to the system as your operations grow. And, you're worried about back-up before you even worry about start-up.

At best, you now find yourself trying to find a system that will solve just some of your problems. You're willing to compromise on the other problems. And, in the end, you'll settle for some kind of a system you can call your own.

# 3200

Well, prepare yourself for a pleasant surprise. You don't have to just settle anymore, because National CSS, Inc. is introducing the NCSS 3200 Series of computing systems.

**370-COMPATIBLE.** With the NCSS 3200 you can continue to do data processing the way you always have because the NCSS 3200 is 370-compatible. That's the way the operating system was designed over 10 years ago. It's 370-oriented which means you don't have to worry about program conversions. Or retraining your people.

**POWERFUL OPERATING SYSTEM.** With the NCSS 3200 you get the software power and versatility of a mainframe—but in a minicomputer package. So, when you consider price/performance, our mainframe architecture and minicomputer price puts you well ahead of the game.

**FULL BACK-UP.** With the NCSS 3200, should peak loads occur, you are completely backed up by the NCSS timesharing network of large-scale computers—linked by 70,000 miles of leased lines to 80 dial-up locations nationwide. This same network is also available to you for applications development both before and after your new NCSS 3200 arrives.

So, if you're looking for your own computing system, take a look at our brochure about the new NCSS 3200 Series. We think you'll find what you've been searching for.

Write or telephone toll-free:

**NATIONAL CSS**

127 Danbury Road  
Wilton, Connecticut 06897  
(800) 243-6119

In Connecticut: (800) 892-5575

# Realist

To have an intelligent system, the reader has to make sense.

Systems design is your key to a smart microfilm reader buy. But there are a lot of readers available on the market. How do you choose?

At Realist, we give you the best options in readers because we consider systems applications right from square one.

Front projection. Rear projection. Portability. We'll help you analyze your needs, so you can make a sensible decision. Because to make intelligent choices, you need intelligent alternatives.

Shown:

**REALIST VANTAGE.** The most functionally advanced COM reader on the market.

**REALIST EXECUTIVE & AGENT.** The world's only true portables. Each features a spacious briefcase with built-in fiche panels.

**REALIST VALLANT.** The lowest cost front projection reader of all major brands.

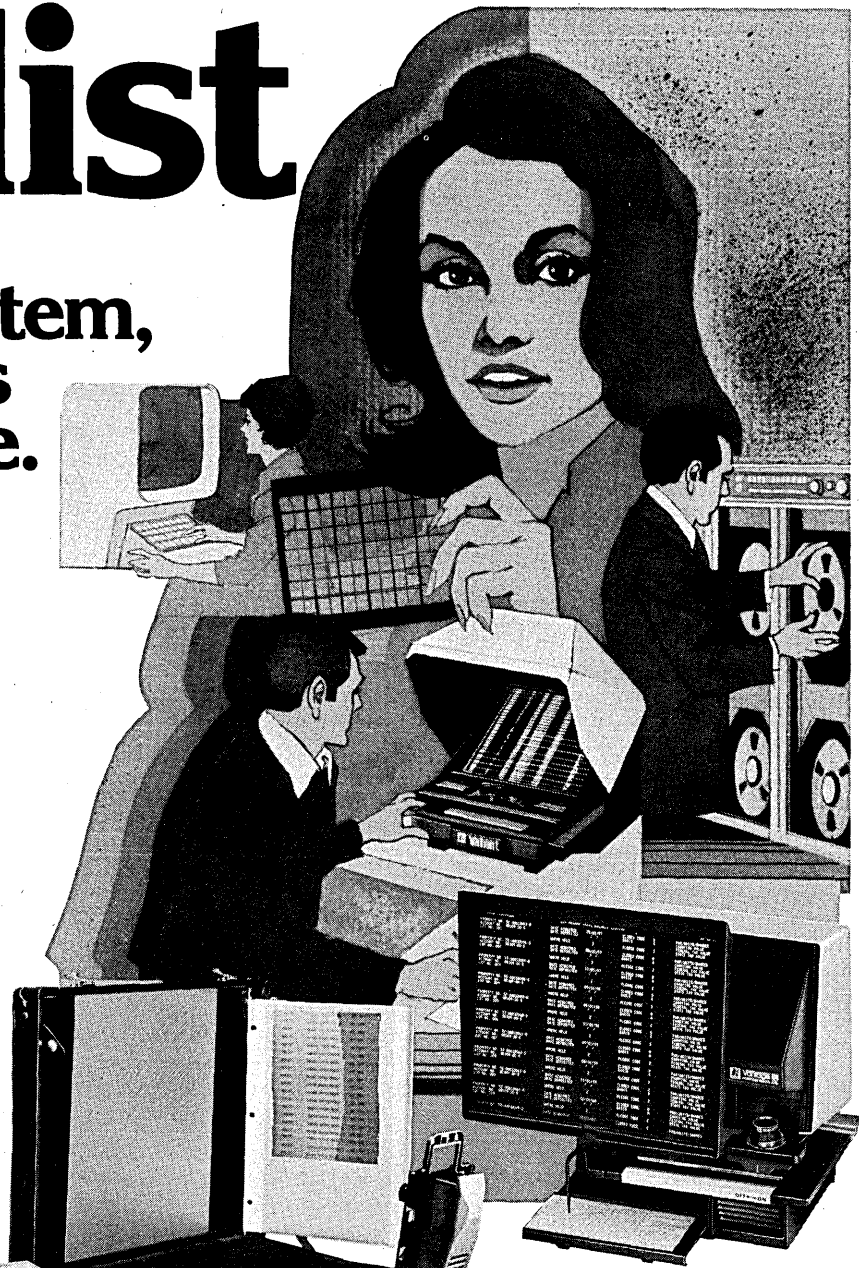

Anybody will sell you a reader. Realist will provide you with a great deal more: consultation on your microform system at no cost. For further information on the Realist line, call toll free: 1-800-558-8577.



**REALIST**

Realist, Inc.  
Microform Products Division  
N93 W16288 Megal Drive  
Menomonee Falls, WI 53051

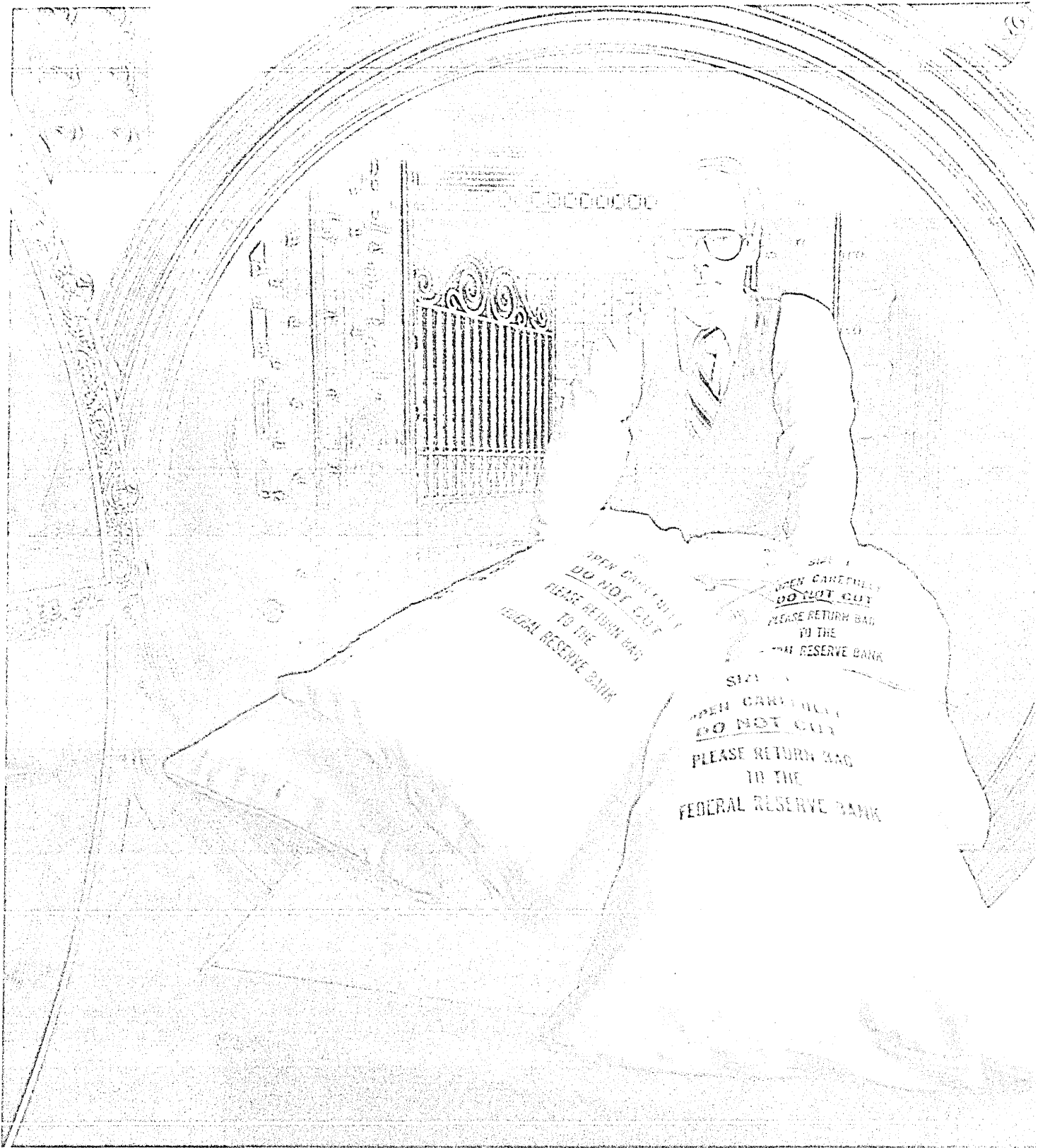

## The interactive database system that keeps a constant check on over 14,000 banks.

The Federal Deposit Insurance Corporation needed a way to manage details about the financial condition of each of its member banks. And handle over 32,000 inquiries a day.

They chose CCA's Model 204—the only DBMS designed from the start to be interactive.

Model 204 has the power to manipulate a vast amount of data, yet it's simple

enough to make that data accessible to anyone—even people who've never used a computer before.

If you need a DBMS for your IBM 370/138 or larger computer, find out why thousands of users nationwide are satisfied with Model 204. Contact Computer Corporation of America, 575 Technology Square, Cambridge, MA 02139, (617) 491-3670.

**Computer Corporation of America**



# source data

(Continued from page 72)

tion headings, which range from "Aviation & Hang Gliding" to "Crocheting." A few of the titles of potential interest to dp personnel (and particularly those leaning toward personal computing) are *Microprocessor / Microprogramming Handbook*, *Microprocessor Programming for Computer Hobbyist*, and *Build Your Own Working Robot*. TAB BOOKS, Blue Ridge Summit, Penn.

FOR COPY CIRCLE 444 ON READER CARD

## Leasing Programs

A four-page, two-color brochure outlines the lease plans offered for this vendor's line of computer power systems. Three types of lease plans are described: operating lease, lease-purchase, and purchase-option. For each, the brochure lists available terms (one to five years), initial payments (if any) and options during or at the end of the lease term. Instructions are provided for calculating lease rates based on the purchase price of the desired system and the term of the lease. The brochure also contains the procedure for completing the lease form. COMPUTER POWER SYSTEMS CORP., Long Beach, Calif.

FOR COPY CIRCLE 445 ON READER CARD

## Communication Test Sets

Data communications test sets are described in this eight-page, four-color brochure. The vendor's Data Tech 9600 and PMK04 Terminal Tester are highlighted, each receiving two pages and full-color illustrations. Applications and capabilities are detailed, and several block diagrams show how the Data Tech can be used. The brochure describes nine other related products, including the TMG-10 Test Message Generator, and DTP-4 Data Test Panel; each description includes a photograph. ATLANTIC RESEARCH CORP., Alexandria, Va.

FOR COPY CIRCLE 446 ON READER CARD

## Networking Software

The philosophy, structure, products, and services which allow networking with this vendor's minicomputers are described in a brochure entitled "DECnet Phase II—Networking Distributed Computers." The booklet summarizes software products, shows product functionality on communication and user/program levels, and discusses reliability, availability, and maintainability program features. DIGITAL EQUIPMENT CORP., Northboro, Mass.

FOR COPY CIRCLE 447 ON READER CARD

## Microprocessor Education

Books and educational products covering microprocessors and related applications are described in this 12-page, illustrated catalog. Books and self study course are broken out into introduc-

tory, intermediate, and specialized classifications. Among the titles offered are *Introduction to Personal and Business Computing*, *Bit-slice Encyclopedia*, and *Microprogrammed APL Implementation*; self-study courses include *Programming Microprocessors*, and *Microprocessor Interfacing Techniques*. Video tapes, foreign versions, and in-house training services also are covered. SYBEX, INC., Berkeley, Calif.

FOR COPY CIRCLE 448 ON READER CARD

## Network Directory

This public packet-switched network common carrier has published a directory of its subscribers that offer interactive computer based services to the public. The booklet first describes subscribers, listing their computers and primary applications, along with a company contact for further information. Another section covers more than 175 data bases that subscribers make available to other users. A cross-reference section provides an index to major applications. TYMNET, INC., Cupertino, Calif.

FOR COPY CIRCLE 449 ON READER CARD

# courses

## Micrographics

Three days of presentations, panel discussions, and case studies. Sessions will be offered on indexing, management techniques, advanced technologies, personnel policies and performance measurements, and potentials of optical, digital video and facsimile. Plenary sessions will address the converging technologies of micrographics and computers, and industry considerations. July 17-19 in Washington, D.C. Fee: \$330. Dept. PR, AIE Seminars, P.O. Box 3727, Santa Monica, CA 90403 (213) 450-0500.

## Software Engineering

Three professors—J.R. Abrial, B.W. Boehm, and C.A.R. Hoare—will present software methodology and practice in the July session of Computer Science Summer School. July 10-28. Presentations will be in French and English. 7,000 francs (about \$1,200); includes room and board. Contact: Secretariate des ecoles d'ete, 1, avenue du General de Gaulle, 92140 Clamart (France) 645.21.61.

## Coding and Information Theory

A course presenting the fundamentals of representation, storage, and transmission of data will be given by Richard Hamming July 17-21 at UCLA, August 7-11 at the Univ. of Toronto, and September 11-15 at Georgia Institute of

Technology. Covered will be error detection and prevention codes, efficiency enhancement through information compressing codes, and the information theory describing obtainable limits for error protection and efficiency. Practical illustrations and underlying philosophy are promised. \$475. UCLA Extension, 10995 Le Conte Ave., Los Angeles, CA 90024.

## On-line Audit Controls

Practical descriptions and case study analyses aimed at enabling the student to design and evaluate a system which has multiple security/privacy levels and rigid failure recovery requirements. Offered June 21-23 in Washington, D.C.; July 19-21 in San Francisco. Fee: \$425. The Institute for Professional Education, Suite 601, 1901 North Fort Myer Drive, Arlington, VA 22209.

## Software Audit and Control

A variety of techniques to protect against accidental or deliberate modification, destruction, or disclosure of sensitive data will be presented. The seminar will be a review of practical methods reinforced with studies of case histories. June 28-30 in Washington, D.C. Fee: \$450. EDP Audit Controls, Inc., 7700 Edgewater Drive, Suite 745, Oakland, CA 94621 (415) 638-4075.

## Networks

A comprehensive introduction to distributed processing and computer network system planning, implementation and design. Application illustrations are promised. To be held in Boston June 20-23 and in Aspen July 11-14. Fee: \$595. Integrated Computer Systems, 3304 Pico Blvd., P.O. Box 5339, Santa Monica, CA 90405 (213) 450-2060.

## Data Base Technical Management

Primarily designed for managers and senior dp staff. Covers data analysis and logical design, the development cycle, design methods, DBMS and case study-type design exercises. Offered in London July 24-25 and November 6-7. Fee: 145 pounds. Contact: The Registrar 106, BIS Applied Systems Ltd., 79-80 Blackfriars Road, London SE1 8HB (01) 928-9511.

## Word Processing

For potential and current users of word processing technology. Updates and forecasts of technical developments, case studies of successful applications, and management techniques. June 28-30 in Chicago. Fees: \$300 for individuals, \$235 for teams. Contact: Dept. DTM, AIE Seminars, P.O. Box 3727, Santa Monica, CA 90403 (213) 450-0500. \*

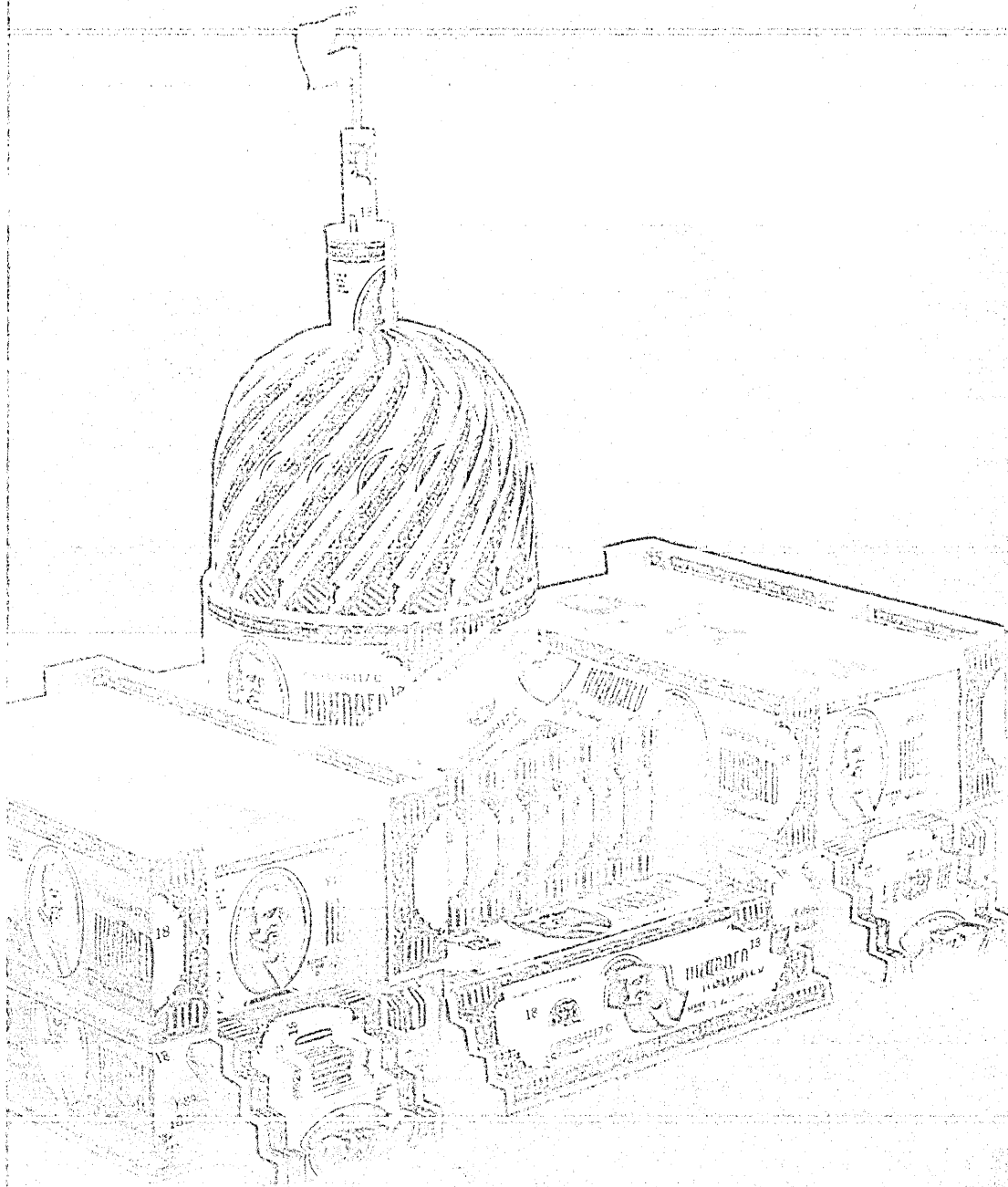

# ITEL LEASING EQUIPMENT FINANCE PROGRAMS MUNICIPAL FINANCE

Itel's Municipal Finance Program offers the most cost effective means of acquiring the capital equipment that every state and local government needs. We handle all types of tax-exempt financing, including conditional purchase as well as direct lease financing programs.

Our financing offers the most competitive rates of all municipal, voluntary and pay-as-you-go financing programs. Our interest rates are comparable with municipal bond rates.

No cost termination of the lease for non-appropriation of funds.

Financing for all types of equipment for virtually any terms (for 1 to 20 years)

Assistance with future refinancing opportunities of equipment and better utilization of existing leases.

Itel's sound record speaks for itself. In the past seven years, we've arranged financing for over \$3 billion of equipment. Our success has come

from showing our customers how to more effectively use their capital resources. Now, why not let Itel help you stretch tax dollars to fit your municipal equipment needs?

For further information about our Municipal Finance Program, contact: Albert J. DeLoe, Director

**ITEL**  
CORPORATION  
Financial Services Group

One Embarcadero Center  
San Francisco, California 94111

# The only source you need for remote batch, interactive, and distributed processing systems... HARRIS.

## **The Total Source**

When you're in the market for data processing products, it's important to remember one fact that is often overlooked: you're not just buying equipment, you're buying commitment.

That's why you should be looking at Harris as the only source you need, whether your requirements are for remote batch terminals, local or remote interactive terminals, data entry products or systems for distributed data processing.

Behind Harris products is an \$800 million per year company with a solid record of financial stability and growth. Data Communications is one of the largest Harris Divisions, with established products, seasoned field and support organizations, and a commitment to continuing leadership based on heavy investments in research and development.

You buy Harris products with confidence that we'll be around when you need us — not just today and tomorrow but years from now. And you can be assured that your product base will stay at the state-of-the-art with no danger of obsolescence.

## **Families of Products from a Single Vendor**

The Harris solution to your data processing problem is built around a modular hardware and software structure that grows with you as your requirements change and increase. We offer families of products and make it easy for you to upgrade within families. You set your own pace and Harris supports you all the way. And, if your processing calls for several different kinds of terminals, Harris can meet your needs... and give you all the advantages a single vendor can provide!

## **Remote Batch Terminals**

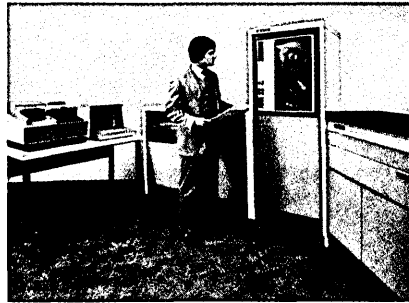

*HARRIS 1620 remote batch terminals feature multiple communication with up to four hosts simultaneously, a wide variety of popular emulators, and transmission speeds up to 56,000 bits per second.*

Harris offers three families of remote batch processing products for entry-level, medium function, and high-function applications: the Harris 500, 1200 and 1600 series respectively. As an example of the product-family concept, our economical Harris 1610 is built around a memory-based operating system, performs remote batch and media conversion and includes a wide variety of proven peripherals.

Step forward from the 1610 and you grow into our Harris 1620 with capabilities including multiple emulators (up to four concurrently), to most major mainframes. Either the 1610 or 1620 can be field-upgraded to our distributed data processing products.

## **Systems for Distributed Processing**

You can choose from four Harris 1600 systems for distributed data processing. The Harris 1650 is the first 1600 model to incorporate a mainframe-type disk operating system. It provides data entry and remote batch processing concurrently. Next, our Harris 1660 adds programmability in either interactive or batch modes and accommodates both format-driven and program-driven interactive applications. Then we offer the Harris 1670, featuring the significant advantages detailed below, and the Harris 1680 which uses dual processors for expanded concurrency capabilities.

## **Interactive Terminals**

For the growing interactive market, Harris offers the established 8000 series. The proven Harris 8170 emulates IBM 3270 models 1, 2, 11 and 12 and is SDLC compatible. Emulation is also provided for the IBM 3272 controller. Other Harris interactive products emulate Burroughs, Univac and Honeywell terminals. Our top-of-the-line 8180 includes dual diskettes with 500K bytes of off-line storage, five megabytes of disk storage (optional), and up to 96K bytes of memory. These enhancements permit applications such as local format storage, spooled print and queued transaction handling.



*HARRIS 8000 series terminals communicate interactively with IBM, Honeywell, Univac and Burroughs mainframes.*

## **Everything You Need for Distributed Processing... in One System**

We've combined the capabilities of our 8170 interactive product with our 1660 distributed data processing product, both leaders in their respective fields, to provide a powerful new system for distributed data processing. We call it the Harris 1670. It's the *one system* you've been waiting for that will perform five basic data processing functions: local or remote batch, data entry, local interaction and remote interaction *concurrently*. Combining two major Harris resources enables us to produce the 1670 in volume, assuring you a competitive price and unbeatable performance. This single, modular system can fill

your terminal requirements — batch, 3270-compatible, and data entry — and is capable of growing with your processing needs in all these areas.

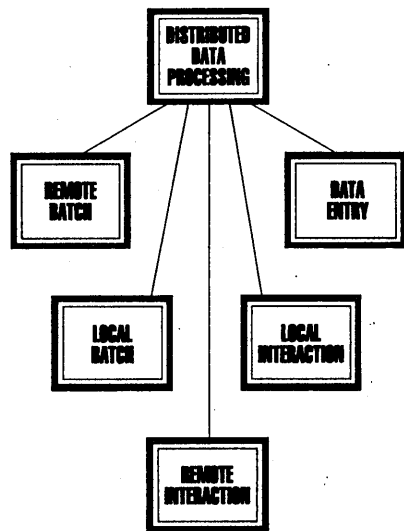

The five typical elements of a distributed data processing system.



Sophisticated new HARRIS 1670 distributed processing system offers local or remote batch processing, data entry, and local and remote interaction concurrently. CRTs are individually switchable between local and host files.

### Batch Processing

When devoted to remote batch communications, Harris' multi-task operating system enables the 1670 to perform any of the sophisticated RJE functions of the 1610 and 1620 models. In addition, the 1670 offers local batch processing with ANSI compatible COBOL and batch utilities, including SORT/MERGE.

### Data Entry

You can choose from two format-driven data entry packages, easily implemented by data entry personnel. The two packages, Format 10 and Format 41, make your data entry jobs simple, efficient and effective.

### User-Written Programs (Local Inquiry)

We offer an easily learned, English-like high level programming language (REGAL), for optimized screen management and for applications such as source document capture and

interaction with the local 1670 data base. CRTs running REGAL programs can be located either at the 1670 site or remotely. Additionally, the CRT can control station printers to produce required hard copy.

### Remote Inquiry (3270-Compatible Interaction)

This capability enables the CRT operator to connect through the 1670 to 3270-compatible programs at a remote host site.

Selectable Mode CRTs can be used to perform operations in the 1670 mode (including data entry and user-written programs), or to switch to 3270-compatible host programs. Switching is controlled individually at each station by the operator, and the system automatically ensures data integrity when switching from one mode to the other. Selectable Mode enables you to off-load the host by performing processing locally for the majority of your requirements, saving host

resources for those occasions when data is not stored locally. Compare this feature when you're evaluating distributed systems!

### No Changes Required at Your Host

The fact is, both RJE and 3270-compatible applications can be executed using the 1670 with no changes or new investment in host software. What's more, you continue to save since we can upgrade most Harris 1600 and 8170 systems to 1670s with minimal disruptions to your operations.

### Do It All with Harris

To sum up, there's no need now to shop around for a variety of systems to handle your requirements for remote batch, local or remote interaction or distributed data processing. Start with Harris and you're assured a migration path from the system you need today all the way to one you'll require in the future.

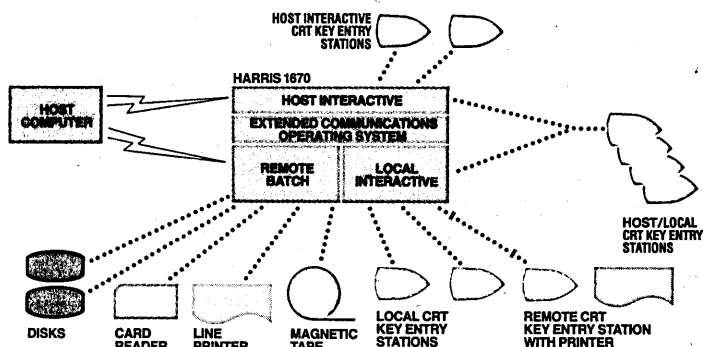

The new HARRIS 1670 combines the capabilities of the 1660 with concurrent interactive processing to a host mainframe ... and the HARRIS 1670 can be installed with no change in host software.

For more information, contact your nearest Harris sales office or: Harris Corporation, Data Communications Division, 11262 Indian Trail, P.O. Box 44076, Dallas, Texas 75234, (214) 620-4400.

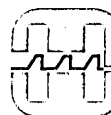

**HARRIS**  
COMMUNICATIONS AND  
INFORMATION HANDLING

The only source you need.

# Editor's Readout

---

John L. Kirkley, Editor

## A Scathing Look at U.S. Standards

Ordinarily government reports are about as interesting as a bowl of puffed rice. And about as nourishing.

An exception crossed our desk the other day and we'd not only like to tell you about it, but recommend that you order a copy of this 60 page typewritten document and set aside an hour for its perusal.

Issued April 19 by the General Accounting Office (and previewed in our January Look Ahead column), it's called "The Federal Information Processing Standards Program: Many Potential Benefits, Little Progress, and Many Problems."

Now standards are not the most fascinating topic that one encounters in computerdom or anywhere else. And when they are discussed in official documentese, you'd expect to be nodding off by the second paragraph.

But the tone of this report and the sweep of its perspective set it apart. Frustration and exasperation alternate with dire recommendations for government-initiated unilateral action. Federal agencies, particularly the National Bureau of Standards, are raked over the coals. In the appendix, case histories chronicle obstructionism, foot dragging and bureaucratic bumbling that would be ludicrous if the effects weren't so damaging.

The report opens with a simple but persuasive argument that the government, because of its size, needs standards. (And incidentally that the computer industry had best pay attention to the government's adp policy statements: the government is the world's largest user of dp resources, spending over \$10 billion each year for equipment and personnel. As of last September it owned or leased over 11,000 computers with a staff of over 150,000 technical personnel.)

Because few standards have been developed, because compliance with those that have has been slipshod at best, because the Brooks Act is not being enforced, "many federal agencies have become locked into suppliers of computers and related services." The number of noncompetitive procurements is rising, but so is the cost of computer program conversion, now running at a substantial \$450 million per year.

It's when the report focuses a baleful eye on the National Bureau of Standards' Institute for Computer Science and Technology that the tone becomes most acerbic. The report cites a pathetic track record: for example, NBS committed itself to publishing 13 federal standards in 1976; they issued two standards and six guidelines. In 1975 NBS said they would issue 20. They produced five standards and one guideline. And so it goes, back through the years.

Lack of funds, claims NBS. In so many words, GAO answers, hogwash. You've depended too much on the commercial sector, you haven't made standards visible to Congress and OMB, you haven't established priorities, exercised controls, and your top managers just haven't been interested.

But NBS isn't the only group to take it on the chin. Private industry is accused of self-serving foot-dragging, the Government Services Administration of ignoring its own rules, and the U.S. standards activities of being manipulated by special interest groups. And there's lots more.

But the real kicker is in the GAO recommendation, repeated several times so even the most inattentive will get the point. "The government should be prepared to develop and adopt standards unilaterally when it recognizes that industry or groups within industry are delaying excessively the development of essential federal standards."

The message to the computer industry is clear: "Get your act together or we'll do it for you." And would you want the organization that gave you the U.S. Post Office to set industry's standards?

Enough said. To order the report send \$1.00 to the U.S. General Accounting Office, Distribution Section, P.O. Box 20013, Washington, DC 20013. Reference the report by name, number FGMSD-78-23, and date, April 19, 1978.





Dear Ma:

Vadic's new modems direct-connect to any telephone line: residence, business, WATS, leased... can yours?

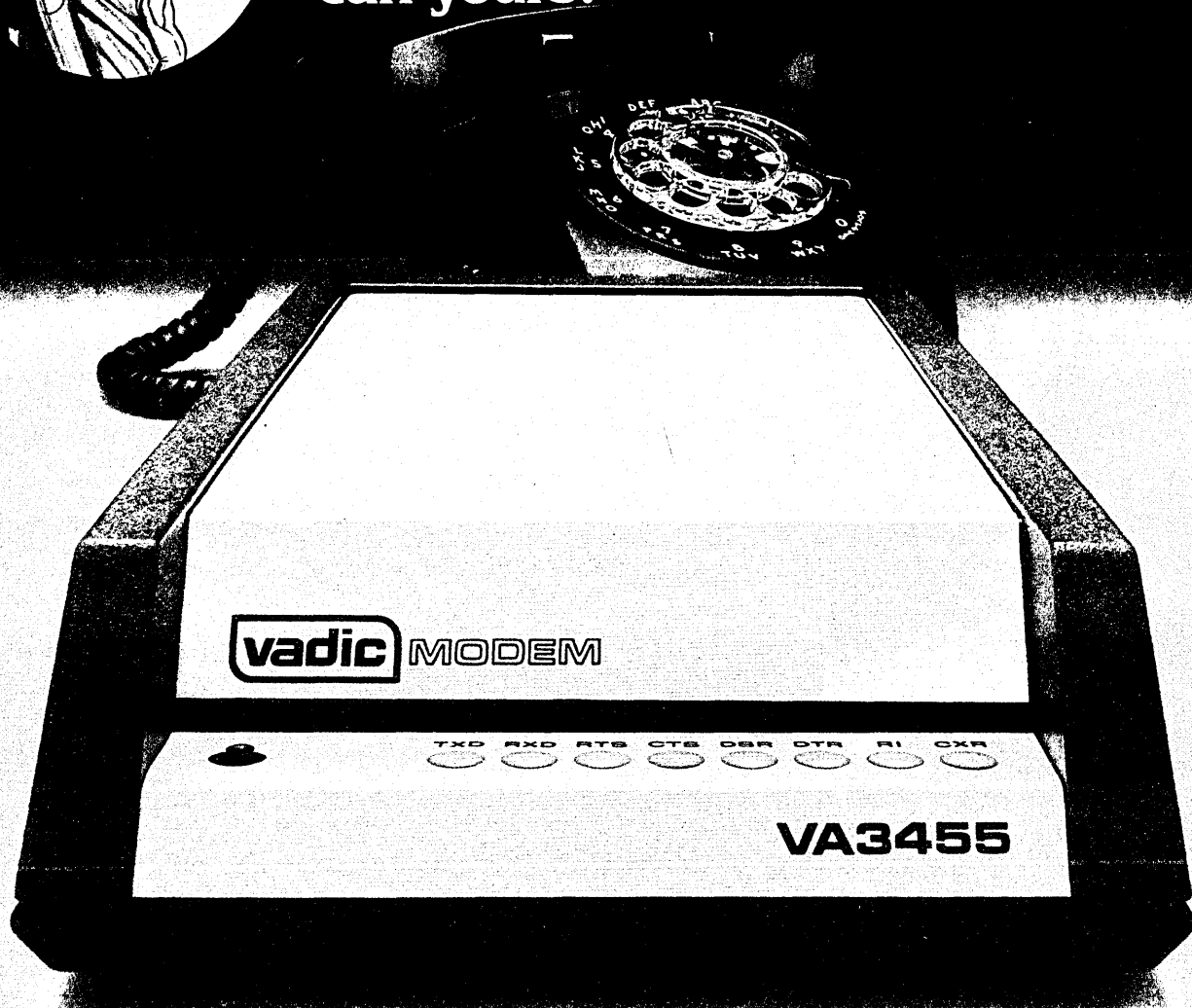

The day of the truly portable terminal has arrived, thanks to Vadic. You see, Ma, Vadic has a brand new line of highly styled, low profile modems specifically designed for remote terminal users.

These modems direct connect to any dial-up phone, be it residence, business, WATS, behind a PBX... you name it. This means users will no longer have to rent your DAA's, saving them money and space.

Can your modems do this, Ma, or do they require the more expensive data lines?

Whatever the terminal, Vadic has the modem — 1200bps, 300bps, full duplex, half duplex, dial-up leased line. They're simple to install. Just unplug the phone, plug the modem into the voice or data jack, connect the terminal and start communicating. Putting it simply, Ma, Vadic's new modems combine the portability of acoustic coupling with

the performance and reliability of direct connect.

A good example is the VA3455 shown above. It provides 1200bps full duplex operation over the switched network or two-wire leased line. It's the coolest running modem ever built. Requires less space, too, because the phone can sit on top of the modem, or modems can be stacked without creating a heat problem.

With these great new direct connect modems at the remote end, and Vadic's remarkable triple modem, which automatically becomes a VA3400, a 212A or a 103, at the computer site, Vadic has opened new vistas in data communications. The whole story is in Vadic's new 8-page brochure. Better phone, or write for yours today, Ma.

Your independent thinking son,

*Alexander Graham Jr.*

**Racal-Vadic** the new name for



Member of IDCMA

222 Caspian Drive, Sunnyvale, CA 94086 • Tel: (408) 744-0810 • TWX: 910-339-9297

**RACAL**  
The Electronics Group

CIRCLE 13 ON READER CARD

A new land speed record? A candidate for Guinness' Book of Records?

Perhaps so.

At any rate, Telefile Computer Products, Inc., of Irvine, California, decided to see if Telex' new high-performance tape drive really was as flexible as we've touted (and have a little fun along the way).

The results in Telefile's own words:

"We were impressed by Telex' engineering achievements and interfacing ease. To be able to offer such a variety of speeds and densities in a single basic unit seemed almost too good to be true.

"But Telex passed the test with flying colors.

"It means that our customers can upgrade and increase system performance simply by changing circuit modules and heads on site. This flexibility will help keep our spares, training and logistics costs down, too."

Telefile has since increased their tape order to 200 units including formatters.

Now they can offer users of various minicomputers

and major mainframes the full range of storage capability in their Matchmaker systems—high- and low-density disk drives with tape to match.

Look into Telex' new dual-density tape drives and triple-density formatters. You'll have full IBM compatibility, break speed records (forward and reverse) and be able to handle lower-density PE and NRZI data formats ... and GCR as well.

Telex has the only tape drive and formatter in its class that writes 0.3-inch interrecord gaps—without program restriction.

Get on the right track, contact: Dan O'Neill, Telex Computer Products, Inc., 6422 E. 41st St., Tulsa, OK 74135. Telephone: (918) 627-1111.

# TELEX®

Tape drive miniaturization ... in a big way.

## It went from 45 to 125 ips and 800 to 6250 bpi in 28 minutes flat.



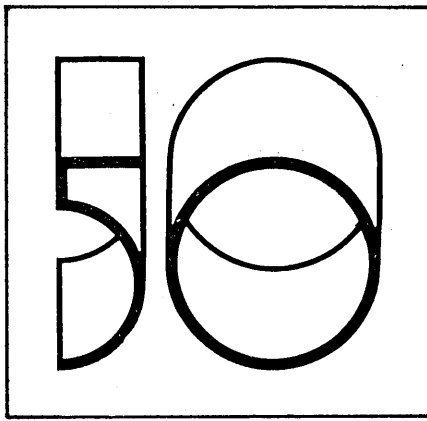

# The Top 50 U.S. Companies in the Data Processing Industry

by Oscar H. Rothenbuecher

---

A great deal of pushing and shoving went on as the industry grew to the \$30 billion level.

---

For the third consecutive year, Arthur D. Little, Inc. has produced DATAMATION's review of the U.S. data processing industry as represented by its top 50 participants. As in the last two years, it has been a challenging task. With the spreading of digital electronics in an ever wider array of equipment, just defining the boundaries of the industry is difficult. Identifying how many dollars of each company's gross revenues to apportion to dp products and services is tough as well, especially since such things are usually not called out in public financial reports and since the company in question may actually get its revenues from several industries. All of this leads to considerable research, analysis, and estimation.

Fortunately, some changes in reporting went into effect in 1977 in accordance with the provisions of the Statement of Financial Accounting Standards. Many companies began reporting dp revenues and international revenues separate from other figures. The changes have led to some restatement of 1976 figures, for our comparison with 1977 data, but overall will lead to more accurate and reliable information.

We're fortunate, too, in receiving more and more cooperation from the companies involved, which we deeply appreciate.

Still the job isn't easy, and we've had to simplify it as much as seemed reasonable. In the compilation presented, we have concentrated on the activities and related revenues concerned with general purpose data processing prod-

ucts and services offered to the end user community. We've excluded such specialized subjects as defense-related systems, pure data communications (where no "processing" is done), and stand-alone products with digital electronics such as electronic cash registers. Exceptions—or apparent exceptions—to even these simple rules have been made, as in the inclusion of point of sale *terminals*; such cases are clearly noted.

We've found that 1977 was a good year: cumulative 1977 revenues for the top 50 U.S. companies in the data processing industry amount to \$29.6 billion, an increase of 18.1% over the

---

## The Top 50 garner more than 95% of U.S. dp industry revenues.

---

previous year's restated level. For comparison, 1976 revenues were only about 14% higher than 1975's. The threshold for entry to the list was also up, to \$69 million, from \$55 million in 1976 and \$40 million in 1975. And only two companies on the list reported losses for the year.

The question always remains how accurately the top 50 companies reflect the whole U.S. data processing industry. As Fig. 1 shows, the concentration of revenue remains very high. While

The information presented in this article was compiled as a result of a study conducted for *Datamation* by Arthur D. Little, Inc. staff under the supervision of Mr. Rothenbuecher.

there are many companies below the \$69 million revenue level of the 50th position on the table, we conclude that the combined revenues of those firms probably amount to less than an additional \$1 billion; thus the top 50 companies garner more than 95% of U.S. data processing industry revenues. Within the boundaries of general financial and market coverage, it appears appropriate to say they represent the U.S. data processing industry very well.

### The "big seven"

As a group, the big seven continued to hold their leading position in 1977. The gap between them and number eight in line, Memorex, widened by 58% to \$632 million. It was "only" \$401 million the year before. And again IBM's data processing revenue of \$14,765 million accounts for about half of the revenues of the entire top 50 participants.

This doesn't suggest the lower group is stagnant, by any means. While the combined revenues of the big seven account for 78.5% of the top 50 group, and grew by 15.5%, the combined revenue of the other 43 grew 30.7%. This certainly reflects the potential and opportunities of new companies in a continuously evolving industry, but it should not distract from the market strength of the established leaders—the revenue growth of the big seven at \$3.1 billion is far larger than the \$1.4 billion growth of all the others taken together.

Some pushing and shoving has occurred in the top ranks, too. While IBM and Burroughs remained in their



## TOP COMPANIES

number one and number two positions, place number three is now claimed by NCR, moving up from 1976's sixth place. Utilizing its previously established base in retail and financial organizations, NCR effected the change from the cash register and accounting machine to the retail and financial terminal. (Again, much depends on where the borders of the data processing industry are drawn.) As a result, it now holds a leading position in these fields and its data processing revenues now account for almost two thirds of its total volume.

Control Data moved into fourth place, mainly because of its strong orientation in data processing services and its position as an oem peripherals supplier. Sperry Univac, reporting on a fiscal 1977 that ended in March of 1977, follows in fifth place. Digital Equipment, with a revenue increase of 44% for its fiscal 1977 ending in midyear, moved up to position six.

Honeywell Information Systems, conversely, had a different kind of change.

### In selling Compagnie Honeywell Bull to the French, HIS dropped from fourth to seventh place.

HIS now reports revenues which are reduced by the contribution of the former Compagnie Honeywell Bull, which was sold to the French to become part of France's computer company, Compagnie Internationale pour l'Informatique-Honeywell Bull (CII-HB). In previous years Honeywell's position reflected worldwide revenue; losing the impact of CII-HB revenue drops it to seventh place by official revenues, though its actual influence on the market may be considered larger on account of products and marketing shared with CII-HB.

### Product market shares

The share of dp industry growth attributable to computers themselves continues to decline; the mainframe area gained only 7% over the previous year. Notably, mainframe revenues of the big seven grew only 4% while the remainder is attributed to the new breed of plug-compatible mainframe suppliers. This low level of overall growth is considered due in part to the price reductions which occurred under competitive pressures. To a larger degree, it may be attributed to the generally lower shipment activity which occurs before new products reach volume output. Even so, because of their relatively high individual value, mainframe revenues accounted for nearly one quarter of the total industry volume.

And things are looking up for main-

frames. Order backlogs indicate that 1978 is likely to see considerable activity as new IBM 303X, Univac 1100, and NCR Criterion families enter the market in increasing numbers.

Increasing use of minicomputers in a multitude of dispersed situations again resulted in almost 21% revenue growth for the little-cpu sector. Still, at their much lower average ticket value, their share in the total dollar volume is only 8%.

### Revenues of the lower 43 are based more on service—and they're slowing.

The largest participant again is the peripherals and terminals category. This year it also became the category with the strongest growth, showing a revenue increase of 26% over 1976's level. This very healthy increase is attributed to expansion of many user applications, leading to strong demand and shipment levels for peripherals.

Similarly, the growing population of minicomputer systems draws with it a hefty demand for peripherals which adds to the latter's revenue growth. Finally, the tendency toward increasing use of interactive systems, mainframe-supported or minicomputer-based, from management office to manufacturing plant to retail cashier has brought a strong demand for terminals, which can be expected to continue in the foreseeable future.

Revenues attributed to services and

sales. For the remaining group of 43 firms, revenues in this category grew only by 8%; however, as these revenues of the 43 are in much larger degree based on data service operations, this slower growth bears further watching as it may reflect a trend to replacing outside service offerings with small in-house systems.

Revenues for media and supplies advanced nearly 20%, slightly more than the dp industry on the average. We attribute this to the rising demand for disc packs, tape, printer ribbons, etc., which in turn is predicated on the increasing volume of on-line storage capacity and related backup requirements, and also on the proliferation of remote processing and output sites.

### Changes in position

We find again that a number of companies changed their positions. For some, this occurred because their growth rate changed. For others, it happened because of another company's change or because of a redefinition in data processing contribution to gross revenues.

It takes only a "little" change, a few \$ million growth, to alter the position of a company among the last 10 in the list. And while two of the three that came off the end of the list showed good growth, their ouster was effected by three companies that came aboard: Pertec (which would have appeared last year, had it reported its acquisition of Computer Machinery Corp. on a consolidated basis), Litton Industries, and

## THE TOP FOREIGN CONTENDERS

Company	Country	1977*	
		DP Revenue Millions \$ U.S.	End of Fiscal Year
Fujitsu	Japan	\$856	March 31
CII-HB	France	\$765	Dec. 31
Hitachi	Japan	\$720	March 31
Siemens	West Germany	\$550	Sept. 30
Nippon Electric	Japan	\$400	March 31
Nixdorf	West Germany	\$384	Dec. 31
ICL	Great Britain	\$233	Sept. 30

\*Expressed as our best approximation considering fluctuating currency exchange rates. Note that the Japanese firms reported on a fiscal year ending on March 31, 1977—not 1978.

This listing shows what we believe to be the seven largest foreign-owned dp companies. By our estimates of their revenues, six of them fall into the revenue category of the first 10 top 50 U.S. dp companies, though none of them measure up to any of the U.S. "big seven."

software show an overall growth of 14.7%, less than the restated 16% level of advance attained in 1976. On the basis of the revenue source breakdown given in IBM's 1977 10-K statement, IBM's service and software revenues grew to 16%. For the big seven, as a whole the growth amounts to 18.6%, with a considerable portion originating in field service charges and software

Planning Research Corp.

Outside the big seven, the largest improvements in relative position were made by Amdahl (reflecting continued success of its plug-compatible mainframes) and by Data General, Tektronix, Texas Instruments, and Xerox (reflecting the popularity of the peripheral equipment and minicomputer families offered by these firms).

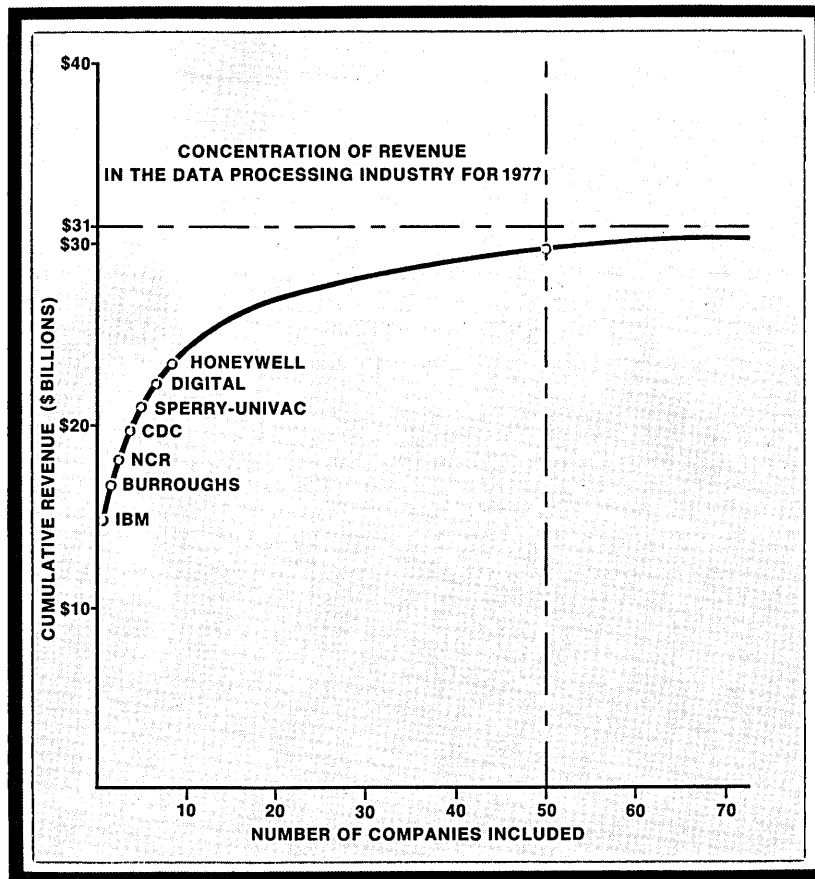

Fig. 1. Concentration of revenues in the dp industry's leaders remains very high. Although there are many firms which do not appear in the Top 50 list, their combined revenues probably would not bump the curve up by as much as \$1 billion.

1977 REVENUE INCREASES OF THE "BIG SEVEN"  
(in \$ millions)

	1976*	1977
IBM	\$12,717	\$14,765
Burroughs	1,630	1,844
NCR	1,390	1,574
Control Data	1,331	1,513
Sperry Univac	1,430	1,472
Digital	736	1,059
Honeywell	914	1,037
	\$20,148	\$23,264

\*Restated from last year to reflect additional data

Table 1. Revenues for the big seven alone were up more than \$3 billion over 1976 figures. The "other 43" increased their total earnings by about half that amount.

TOTAL DP REVENUES  
(in \$ millions)

	1976*	1977
Mainframes	\$ 6,583	\$ 7,036
Minicomputers	1,972	2,385
Peripherals & terminals	10,386	13,110
Service & software	4,722	5,414
Media & supplies	1,407	1,687
	\$25,070	\$29,632

\*Restated from last year to reflect additional data

Table 2. The combined revenues of the Top 50, above, are thought to be about 95% of total U.S. industry revenues. Thus this breakdown pretty well reflects what the entire industry is doing.

The largest losses in relative position were recorded by Bunker Ramo, General Automation, Mohawk Data Sciences, Raytheon, System Development Corp., Telex, and Tymshare. These declines reflect a variety of product line factors in effect during 1977, and in some cases new products may reverse the decline in 1978. These declines also reflect lower growth of the services and software segment in 1977 than in 1976.

### Moving up are Amdahl, Xerox, TI, Tektronix, and Data General.

Only two of the companies primarily associated with services and software improved their positions in 1977 (McDonnell Douglas and Informatics).

Finally, a "decline" in rank for one company may not reflect a bad year for that firm at all. It may only mean that some other company or companies did even better.

Overall, changes in the composition of the list were less pronounced than in 1976. 1977 was a more stable and (for most) a highly prosperous year.

### The top 50 table

The table on pages 88 and 89 shows the 50 top U.S. companies in the data processing industry. They are arranged in descending sequence by data processing revenue for their fiscal 1977 except in those instances where more than one company reports the same revenue, in which case they are run in alphabetical order.

Information on the right half of the table is generally taken from company annual reports. (Where no information is available on this basis, we have provided our estimate or indicated the lack of data.) Besides the *gross revenues* of each company for 1975, 1976, and 1977, and its net income/loss for 1977, we show the end of the fiscal year by which the company reports to make the reader aware of comparison problems.

The left side of the table contains information on the *data processing revenues* of each company. These data represent a mix of company-reported information and Arthur D. Little estimates.

Separately, for each company, we present a brief profile of their activities in text form, supplemented by a bar chart reflecting our views of the contribution which the product and service areas make to the total data processing revenues of each firm. These data processing revenues, as shown, are to reflect only those revenues which a company obtains by providing data processing products and services which are useful to the general user population, outside of its own organization. We therefore tried to exclude sales of military or other special purpose systems



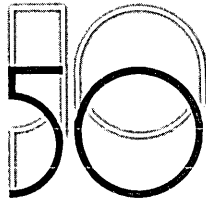

# THE TOP 50 U.S. COMPANIES IN THE DP INDUSTRY

Estimates for 1977

RANK	COMPANY	DP REVENUES \$M	DP REVENUES (% of total revenues)	U.S. DP REVENUES (% of total dp revenues)
1	International Business Machines	\$14,765	81%	50%
2	Burroughs	\$1,844	87%	59%
3	NCR	\$1,574	62%	51%
4	Control Data	\$1,513	66%	66%
5	Sperry Rand	\$1,472	45%	59%
6	Digital Equipment	\$1,059	100%	64%
7	Honeywell <sup>2</sup>	\$1,037	36%	63%
8	Memorex	\$405	90%	60%
9	Hewlett-Packard	\$402	30%	54%
10	TRW	\$350	11%	77%
11	Itel	\$286	71%	90%
12	Data General	\$255	100%	68%
13	3M	\$240	6%	80%
14	Automatic Data Processing	\$238	97%	92%
15	Xerox	\$209	4%	100%
16	General Electric	\$200	1%	80%
17	Amdahl	\$189	100%	81%
18	Computer Sciences	\$176	75%	80%
19	Storage Technology	\$162	100%	92%
20	Texas Instruments	\$160	8%	90%
21	Electronic Data Systems	\$157	96%	95%
22	Management Assistance	\$155	100%	61%
23	Mohawk Data Sciences	\$146	100%	43%
24	Harris	\$145	22%	90%
25	Data 100	\$138	100%	62%
26	Ampex	\$130	45%	53%
27	California Computer Products	\$114	97%	77%
28	Wang Laboratories	\$114	85%	55%
29	McDonnell Douglas	\$112	3%	100%
30	Teletype	\$110	41%	90%
31	General Instrument	\$106	23%	80%
32	Bunker Ramo	\$105	31%	90%
33	Dataproducts	\$104	90%	80%
34	System Development	\$104	80%	95%
35	Datapoint	\$103	100%	64%
36	Perkin-Elmer	\$103	24%	75%
37	Tymshare	\$101	100%	95%
38	Tektronix	\$100	22%	60%
39	Pertec Computer	\$95	100%	81%
40	Telex	\$90	76%	75%
41	Four-Phase Systems	\$89	100%	86%
42	Raytheon	\$85	3%	80%
43	General Automation	\$84	100%	75%
44	Sycor	\$77	100%	69%
45	Informatics	\$76	100%	93%
46	General Telephone & Electronics	\$75	1%	95%
47	Litton Industries	\$70	2%	75%
48	Recognition Equipment	\$70	93%	66%
49	Planning Research	\$69	37%	83%
50	Wily	\$69	97%	45%

<sup>1</sup>includes Commercial Credit Corp. data

<sup>2</sup>data shown excludes CII-HB

<sup>3</sup>restated data

Reported Data							
1975 TOTAL REVENUES \$M	1976 TOTAL REVENUES \$M	1977 TOTAL REVENUES \$M	1977 NET INCOME OR (LOSS) \$M	NUMBER OF EMPLOYEES	YEAR ENDING	76 RANK	77 RANK
\$14,437	\$16,304	\$18,133	\$2,719	310,155	Dec. 31	1	1
\$1,702	\$1,902	\$2,127	\$215	51,295	Dec. 31	2	2
\$2,166	\$2,313	\$2,522	\$144	64,000	Dec. 31	6	3
\$1,921 <sup>1</sup>	\$2,113 <sup>1</sup>	\$2,301 <sup>1</sup>	\$63	46,000	Dec. 31	5	4
\$3,041	\$3,203	\$3,270	\$157	85,684	March 31	3	5
\$534	\$736	\$1,059	\$109	36,000	July 2	7	6
\$2,292	\$2,495	\$2,911	\$145	75,840	Dec. 31	4	7
\$264	\$345	\$450	\$56	8,823	Dec. 31	9	8
\$981	\$1,112	\$1,360	\$122	35,100	Oct. 31	8	9
\$2,586	\$2,929	\$3,264	\$154	87,152	Dec. 31	10	10
\$204	\$260	\$402	\$32	3,900	Dec. 31	12	11
\$120	\$179	\$255	\$29	8,590	Sept. 24	17	12
\$3,127	\$3,514	\$3,980	\$413	80,000	Dec. 31	11	13
\$155	\$199 <sup>3</sup>	\$245	\$23	8,000	June 30	14	14
\$4,054	\$4,418	\$5,077	\$407	103,977	Dec. 31	22	15
\$14,105	\$15,698	\$17,519	\$1,088	384,000	Dec. 31	13	16
\$14	\$93	\$189	\$37 <sup>4</sup>	1,700	Dec. 31	26	17
\$177	\$220	\$235	\$12	7,300	April 1	15	18
\$99	\$122	\$162	\$11	3,988	Dec. 31	20	19
\$1,368	\$1,659	\$2,046	\$117	68,521	Dec. 31	41	20
\$119	\$129	\$164	\$16	6,386	June 30	18	21
\$95	\$123	\$155	\$18	3,500	Sept. 30	19	22
\$170	\$162	\$146	\$5	3,750	April 30	16	23
\$479	\$514	\$646	\$40	16,400	June 30	27	24
\$96	\$122	\$138	\$6	3,686	Dec. 31	21	25
\$242	\$258	\$287	\$9	10,800	April 30	24	26
\$123	\$122	\$118	(\$2)	2,440	June 30	23	27
\$76	\$97	\$134	\$9	3,200	June 30	32	28
\$3,255	\$3,543	\$3,545	\$123	61,577	Dec. 31	33	29
\$157E	\$180E	\$270E	NA	4,300E	Dec. 31	28	30
\$401	\$376	\$466	\$17	24,800	Feb. 28	30	31
\$289	\$316	\$341	\$10	9,700	Sept. 30	25	32
\$86	\$85	\$115	\$12	3,300	March 26	34	33
\$109	\$110	\$130	\$3	3,900	June 30	29	34
\$47	\$72	\$103	\$8	2,730	July 31	39	35
\$297	\$349	\$432	\$27	9,900	July 31	37	36
\$56	\$82	\$101	\$8	2,360	Dec. 31	31	37
\$337	\$367	\$455	\$44	14,637	May 31	45	38
\$48	\$37 <sup>5</sup>	\$95	\$5	2,099	March 25	—	39
\$106	\$106	\$119	\$3	3,149	March 31	35	40
\$50	\$63	\$89	\$9	2,100	Dec. 31	43	41
\$2,245	\$2,463	\$2,818	\$113	57,800	Dec. 31	36	42
\$56	\$71	\$84	\$2	1,750	July 31	38	43
\$55	\$67	\$77	\$3	1,772	Dec. 31	40	44
\$39	\$59	\$76	NA	2,300	Dec. 31	48	45
\$5,948	\$6,751	\$7,680	\$560	190,000	Dec. 31	42	46
\$3,433	\$3,355	\$3,443	\$56	94,000	July 31	—	47
\$59	\$65	\$75	\$7	1,885	Oct. 31	47	48
\$135	\$148	\$186	\$4	6,139	June 30	—	49
\$65	\$64	\$71	(\$5)	1,700	Dec. 31	46	50

<sup>1</sup> E estimated

NA not available

<sup>4</sup> after extraordinary credit

<sup>5</sup> redefined fiscal year, data is for nine months



which are not applicable to the general user community as well as, for example, Teletype's revenues from supplying terminals to its parent firm, AT&T.

The five product profile categories reflect:

- mainframes—general purpose computers (including native memory supplied with them but excluding peripherals and terminals)
- minicomputers—all end-user and oem minicomputers and their native memories, again exclusive of detachable peripherals and terminals
- peripherals and terminals—all units shipped as part of complete systems or shipped separately, including data entry equipment and add-on memory, but excluding equipment without functional connection to data processing systems, such as standalone electronic cash registers or word processors
- media and supplies—media such as disc packs, magnetic tapes, carbon ribbons, and incidental forms supplied by the 50 firms (Again, no major forms manufacturers are included.)
- software and services—software products and all types of usage, maintenance, third-party leasing, training, and customer assistance provided for a

fee (Data communication not involving processing is not considered part of the data processing industry under the scope of this analysis.)

**Disclaimer**

The information reported in this feature is based on data provided in annual reports, 10-K statements and other publications of the companies covered, by Moody's, Standard and Poor's, and Value Line financial services, or in trade publications. While our estimates represent the best efforts of Arthur D. Little, Inc., and DATAMATION on the basis of available information, we cannot in any way guarantee completeness or accuracy.

While our estimates were submitted to the companies in all cases and were often improved by company sources, those companies' policies in many instances precluded us from obtaining either desired details or comments. We may also have missed some firm which had unusual growth, or merged with another, or simply had very low "visibility."

Companies not listed, but having activities and volume qualifying them, are invited to contribute the appropriate information for future consideration.

For all our effort, inconsistencies and inaccuracies may have developed due to the peculiarities of reporting cycles and policies of companies covered. Contributing to these are the following

facts:

• The fiscal year by which companies report is not always identical to the calendar year, leading to differences in reporting periods, final adjustment considerations, and the like. Where this is the case, comparison of results for fiscal 1977 as presented by one company with those presented by another company for a fiscal 1977 of a different period may lead to some inequities.

• Identification of dp revenues and breakdowns of product class contributions are often not made available, or counts and definitions may vary from the mode which we selected.

• Double counting of oem-supplied products such as minicomputers or peripherals or terminals has probably occurred, because revenues of both the originating manufacturer and the assembling vendor are likely to include them. However, the inflating effect of this factor is probably of only minor impact in the context of total industry revenues.

While these factors may preclude us from reporting on individual situations with absolute accuracy, we feel assured by the increasing cooperation which we got in conducting this survey that its results represent the U.S. data processing industry in a most adequate manner and will serve as a useful reference.

**BUSINESS PROFILES (IN ORDER OF INDUSTRY RANKING)**

**1 International Business Machines Corporation  
Old Orchard Road, Armonk, NY 10504 (914) 765-1900**

At 81%, 1977 data processing revenues provided a larger share than ever of IBM's corporate revenues. Dp volume, again as compared to the previous year, advanced by more than 16% to \$14,765 million. Geographically, the sources of this revenue were about equally divided between domestic activities and the international marketplace.

During the year, IBM firmed up its position as the leading supplier to the worldwide data processing market by introducing a series of more cost-effective processor complexes, by significant price reductions for its large scale System/370 processors, by reducing the price for MOS memory in its product line by one third, and by a variety of other hardware and software product announcements and improvements.

The success of these actions not only is reflected in the revenue increase for 1977, but also in the backlog of unfilled orders for data processing machines and systems. IBM reports that by the end of 1977, that backlog had a monthly rental value or equivalent of \$285 million, an increase of 86% over the preceding year's level.

The growing user demand for direct accessibility to data storage, and related need for capacity expansion are considered major factors influencing volume of IBM peripherals and terminals shipped in 1977. In fact, we estimate that peripherals and terminals account for 47% of the firm's total data processing volume.

Mainframe revenues were the compound result of a number of factors, including shipments of the System/370 models 138 and 148, withholding effects in the large system category

in anticipation of the newly announced processor complexes, purchase conversion from former rental customers, and growing application requirements. We estimate mainframe revenues at 34% of the total. Minicomputer revenues and those derived from media and supplies are likely to account for 5% each, software products and services for 9% of the total data processing revenues.

Percentage of data processing business attributable to main product and service categories.

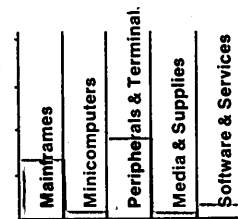

**2 Burroughs Corporation  
Burroughs Place, Detroit, MI 48232 (313) 972-7442**

The revenues which Burroughs obtained for data processing-related products and services advanced more than 13% over the previous year's level to \$1,844 million. Revenues reported in the large- and medium-size computer system category, which grew by 20%, showed the largest increase, despite the moderating effects of substantial price reductions.

The major contribution to Burroughs' data processing revenues, estimated at 35%, came from peripherals and terminals. Mainframes and minicomputers follow with a combined contribution of 31%. Services and software are estimated at 24%, media and supplies accounted for the remaining 10%.

The company continues in its efforts to strengthen its position in the giant computer field. During 1977 it announced an Attached Scientific Processor, attachable to Burroughs 6000 and 7000 class systems, designed for users who have both general purpose and scientific processing requirements.

Burroughs also continues to give extensive attention and support to the small user's needs with an upward-compatible line of small systems and software for growing processing needs.

It also continues to cultivate its position in the international marketplace, especially in Brazil, where it maintains a strong second position. Revenues from foreign operations contributed about 41% of the total.

Percentage of data processing business attributable to main product and service categories.

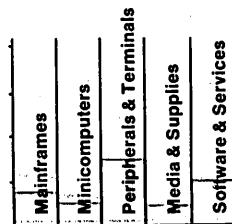

### 3 NCR Corporation 1700 S. Patterson Blvd., Dayton, OH 45479 (513) 449-2000

The transition which NCR's product offerings have been undergoing is reflected by the increasing share which data processing-related products and services take as part of the total business volume of the company. As a leading supplier of terminal and processing systems to retail and financial organizations, NCR profited from the strong trend in these industries to provide widespread data processing support such as at point of sale, bank teller, and factory locations. In consequence, NCR's restated equipment groupings show an increase of revenues from Retail Terminals and Systems in 1977 by 39.5% over the previous year.

Total data processing revenues have thus advanced from the restated level of 1976 by more than 13% to \$1,574 million. Of this, 39% is attributed to terminals and peripherals (excluding electronic cash registers which are not linked to data processing systems), 29% to mainframes and minicomputers, about 27% to services and software and 5% to media and supplies.

Foreign operations continued as strong contributors to the company's revenues, providing almost half of the total volume.

Percentage of data processing business attributable to main product and service categories.

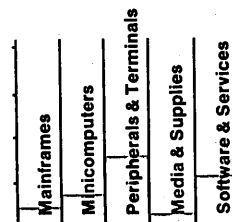

### 4 Control Data Corporation P.O. Box O, Minneapolis, MN 55440 (612) 853-8100

Control Data's computer business advanced to \$1,513 million, about 11% over the previous year's level. The strongest participant in those revenues was the services and software area, which we see contributing 40% to the total revenue volume of Control Data's computer business. This is attributable in part to the strong growth of CDC's data services, which are based in large part on the former IBM Service Bureau Corp. Another strong contributor is the revenue which the firm derives from the unbundling of its software in 1970, especially in light of its 1974 refinement to reflect more accurately true software development cost and value to users.

Late in 1977 Control Data announced a new pricing plan for specialized application computer software programs.

June, 1978

Under this new mode of usage pricing, customer payments for such software will be directly related to the volume of use: low use, as in the early stages of an application, will result in low charges. Increased usage of the software, determined by an accounting routine resident in each program, will lead to a directly corresponding rise in the charges.

Another major rise in revenues came from peripheral operations. These are not only related to CDC's own computer business, but also to a large number of oem customers, specifically in the growing minicomputer market.

We estimate that revenues from the peripheral business contributed about 35% of the total. Revenues from mainframes, slightly smaller than in the previous year, contributed about 15% of revenues. New models of the Cyber 170 family and a mainframe that is plug-compatible to IBM System/370 computers, the Omega 480, may be instrumental in improving revenues from this sector. The remaining 10% of the revenues are attributed to minicomputers, media and supplies.

Foreign operations accounted for about 34% of the total volume.

Percentage of data processing business attributable to main product and service categories.

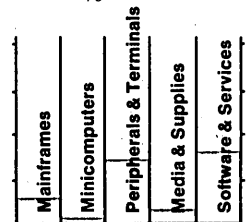

### 5 Sperry Rand Corporation 1290 Avenue of the Americas, New York, NY 10019 (212) 956-3273

During Sperry's fiscal 1977, its Univac Div. produced revenues of \$1,472 million, 45% of the corporate total volume. However, as Sperry Rand's fiscal year ends in March, Univac's business year is 9 months out of cycle with the six other major mainframe suppliers. Adjusted to a calendar year 1977 reporting, it would show revenues at a level of \$1,590 million.

As Sperry reports, its "1977" revenues increased only 3%, a situation which it attributes to increasingly complex marketing conditions, consisting of more intense competition in the United States with new vendors entering the industry, and greater government intervention in favor of indigenous companies abroad. Strong orders for the 1100 series of large computers and for the smaller 90/30 systems were reported, but of course did not take effect as sales in the reporting period.

Computer mainframes are estimated to account for approximately 33% of Univac's volume, peripherals and terminals for 41%. Minicomputers, which just began to come into shipment with the BC/7 small business system, may have accounted for 3%, media and supplies for 5%. Services and software contributed 18%.

About 41% of Univac's revenues came from its international activities.

Percentage of data processing business attributable to main product and service categories.

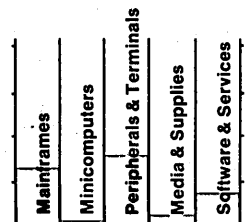

### 6 Digital Equipment Corporation 146 Main St., Maynard, MA 01754 (617) 897-5111

Digital Equipment's revenues in its fiscal 1977 amounted to \$1,059 million, representing an increase of 44% over the \$736 million level of the preceding year. This growth came as the result of a continuing increase in demand for Digital's products, which was met by the expansion of and addition to the company's production facilities domestically as well as



## TOP COMPANIES

abroad. It also resulted from the increasing breadth of Digital's product offerings which now range from the company's most powerful time-sharing computer, the DECsystem 1090, through a series of new medium-range DECsystem 20s to the small DEC Datasystems.

Additional printer, disc, and terminal offerings, together with competitive pricing continued to open new ranges to the marketing of DEC's products.

We attribute about 30% of the firm's revenue volume to minicomputer products, 11% to the larger mainframes, 37% to peripherals and terminals and about 2% to media and supplies. Software and services contributed nearly 20% to the total.

Approximately 36% of the volume originated from foreign sales.

Percentage of data processing business attributable to main product and service categories.

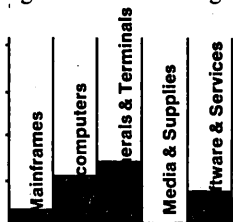

### 7 Honeywell Inc.

Honeywell Plaza, Minneapolis, MN 55408  
(612) 870-5200

The revenues which Honeywell derived from its Information Systems Div. are shown at \$1,037 million, reduced in comparison to last year's volume by the revenues of Compagnie Honeywell Bull which now is part of the French-majority owned Compagnie Internationale pour l'Informatique-Honeywell Bull (CII-HB). With the sale of CHB, Honeywell drops from fourth to seventh place in our tabulations.

On this basis, Honeywell Information System's revenues advanced 13.5% over the restated volume of \$914 million for the previous year and contribute 36% of total corporate revenues. Pro forma inclusion of CII-HB revenues would show a total of \$1,643 million, up 15% from last year's level.

Advances in the HIS revenues are based predominantly on the activities in the large systems area, complemented by the Level 6 minicomputer installations which Honeywell combines under the architectural framework of its distributed data processing system. The combined capabilities thus offered are credited by Honeywell with what it terms as the highest growth rate of installed base in the U.S. government market for any manufacturer in 1977.

Then too, in today's environment of growing data volumes, Honeywell's powerful Page Printing System has gained increasing acceptance as exemplified by the order for 13 of the systems by the Internal Revenue Service alone.

The contribution of small and medium systems produced by the now unconsolidated CII-HB thus is reduced in its relative share impact, but their acceptance was reported as continuing strongly, especially in the competitive international marketplace. In consequence, we see mainframe systems contributing 40% of Honeywell's Information System's revenues, a similar portion contributed by peripherals and terminals, plus minicomputers and media/supplies contributing 5% each, and 10% originating with services and software.

Percentage of data processing business attributable to main product and service categories.

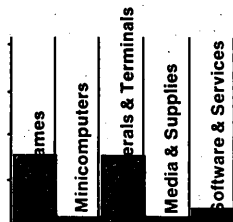

### 8 Memorex Corporation

San Tomas at Central Expressway, Santa Clara, CA  
95052 (408) 987-1000

The revenues Memorex obtained in its fiscal 1977 from data processing-related products grew 23% to \$405 million, as demand for its disc systems, semiconductor memory products, display terminals, and magnetic disc and tape media continued to expand.

We estimate that peripheral products and terminals account for almost two-thirds of Memorex's data processing-related revenues, with revenues from media and supplies making up the remainder. The foreign sales contribution is estimated at 40%.

Percentage of data processing business attributable to main product and service categories.

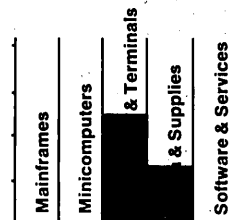

### 9 Hewlett-Packard Company

1501 Page Mill Road, Palo Alto, CA 94304  
(415) 493-1501

During its fiscal 1977, the contributions dp-related products and services made to Hewlett-Packard's total revenues are estimated to have grown to \$402 million. This volume is the result of the increasing acceptance H-P's minicomputer systems find throughout the end-user community; it also reflects a continuing trend of use for Hewlett-Packard minicomputers and peripherals by companies which market specialized computer systems.

We estimate that 29% of the Hewlett-Packard data processing-related volume is attributable to minicomputers, 53% to peripherals and terminals, while services and software contributed about 18%. International customers contributed 46% of the total.

Percentage of data processing business attributable to main product and service categories.

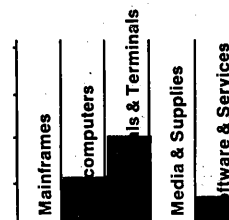

### 10 TRW Inc.

23555 Euclid Avenue, Cleveland, OH 44117  
(216) 383-2332

TRW's data processing-related activities continued in their expansion, resulting in an estimated volume of \$350 million. The major portion of this came from a variety of services, ranging from computer-based information services such as retail customer charge authorization systems, to field service and maintenance agreements for business machines manufactured by companies which find it more effective to use TRW's extensive service organization than build up and maintain their own.

Data processing-related product sales, comprising micro-processor-based point of sale terminals, banking terminals, and text editing devices, also advanced as general demand continued to grow.

We estimate that about 70% of TRW's dp revenues originate from services, 30% from terminals and peripheral products. Increasing activities of TRW Datacom involved in the international marketing of electronic systems for banking and retail application have increased the revenue contribution from foreign operations to an estimated 23%.



Percentage of data processing business attributable to main product and service categories.

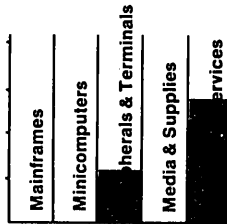

**11 ITEL Corporation**  
**One Embarcadero Center, San Francisco, CA 94111**  
**(415) 955-0000**

Itel Corp.'s dp revenues grew to \$286 million, representing an increase of 66% over the previous year's volume. This very strong advance is due in large part to a rapid growth in activities which Itel has recently added to its spectrum of offerings, such as plug-compatible mainframes. In the field of computer services, Itel's revenues have more than doubled during the year.

Revenues derived from the sales, leasing, and maintenance of computer equipment also rose sharply as Itel entered the business of supplying computer systems which are plug-compatible to IBM System/370 mainframes. Approximately 50 of the Advanced Systems were shipped in 1977.

Thus mainframes contributed about 31% of Itel's revenues, peripherals and terminals 37%. Revenues from services and software accounted for 29%, the remaining 3% originated from minicomputers, media and supplies.

International operations accounted for about 10% of Itel's dp revenues.

Percentage of data processing business attributable to main product and service categories.

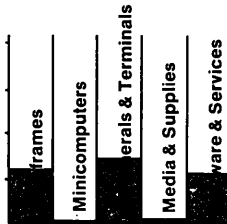

**12 Data General Corporation**  
**Route 9, Westboro, MA 01581 (617) 366-8911**

During fiscal 1977, the demand for minicomputer systems boosted Data General's shipments to more than 10,000 units. With a variety of new product offerings, enhancements to existing products, and an expanded array of services, its revenues grew by 42% over the previous year's level to \$255 million.

Minicomputers themselves are estimated to have contributed only 45% of this total. Peripherals and terminals comprise about half of the revenue volume, services and software the remaining 5%.

Data General's foreign business amounted to 32% of the total corporate revenue.

Percentage of data processing business attributable to main product and service categories.

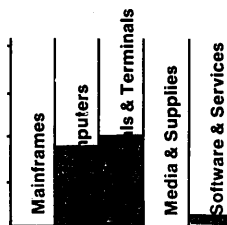

**13 3M Company**  
**3M Center, St. Paul, MN 55101 (612) 733-1110**

3M's activities in computer output microfilm equipment and data entry terminal systems continued to grow, as did its more conventional product line of disc packs, tapes, cartridges, and cassettes. We estimate that revenues from these activities amounted to \$240 million, with 90% contributed by magnetic media and supplies, 10% by peripheral and terminal equipment.

Percentage of data processing business attributable to main product and service categories.

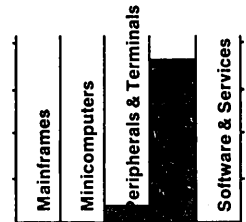

**14 Automatic Data Processing, Inc.**  
**405 Route 3, Clifton, NJ 07015 (201) 472-1000**

In its fiscal 1977, Automatic Data Processing actively expanded the volume and scope of data processing services which the company offers to a community of more than 40,000 customers in the United States, Europe, and Brazil. Through a variety of acquisitions, ADP added industry specializations, increased its on-line service capability, and expanded its geographical coverage.

As a result, its revenues from dp grew 21% to \$238 million. Approximately 8% of this came from the international marketplace.

Percentage of data processing business attributable to main product and service categories.

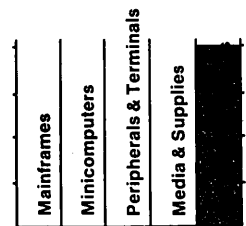

**15 Xerox Corporation**  
**Stamford, CT 06904 (203) 329-8711**

Xerox actively continued to expand its position as a supplier of data processing-related products and services. In the area of digital printing, its Versatec products and the Model 1200 computer printing system were complemented by the Model 9700 electronic printing system, which is capable of producing a great range of character and graphic images at high speed with outstanding quality. Xerox also expanded its line of word and text processing systems, and strengthened its position in the peripherals area with the acquisition of Shugart Associates, noted supplier of flexible disc drives.

Xerox also continues to provide computer services, primarily for small business enterprises.

We estimate that the company's dp revenues amounted to \$209 million with 87% originating from peripherals and terminals, 13% from software and services.

Percentage of data processing business attributable to main product and service categories.

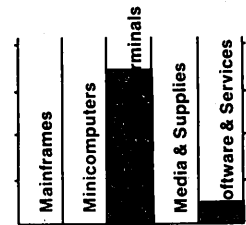

**16 General Electric Company**  
**3135 Easton Turnpike, Fairfield, CT 06431**  
**(203) 373-2211**

As before, General Electric provided dp products and services in two areas: computer services and telecommunications terminals.

From its headquarters in Rockville, Maryland, the Information Services Business Div. offers a variety of computer services. Connected to this location through a network of communication lines are a multitude of customer organi-

# Look closely.

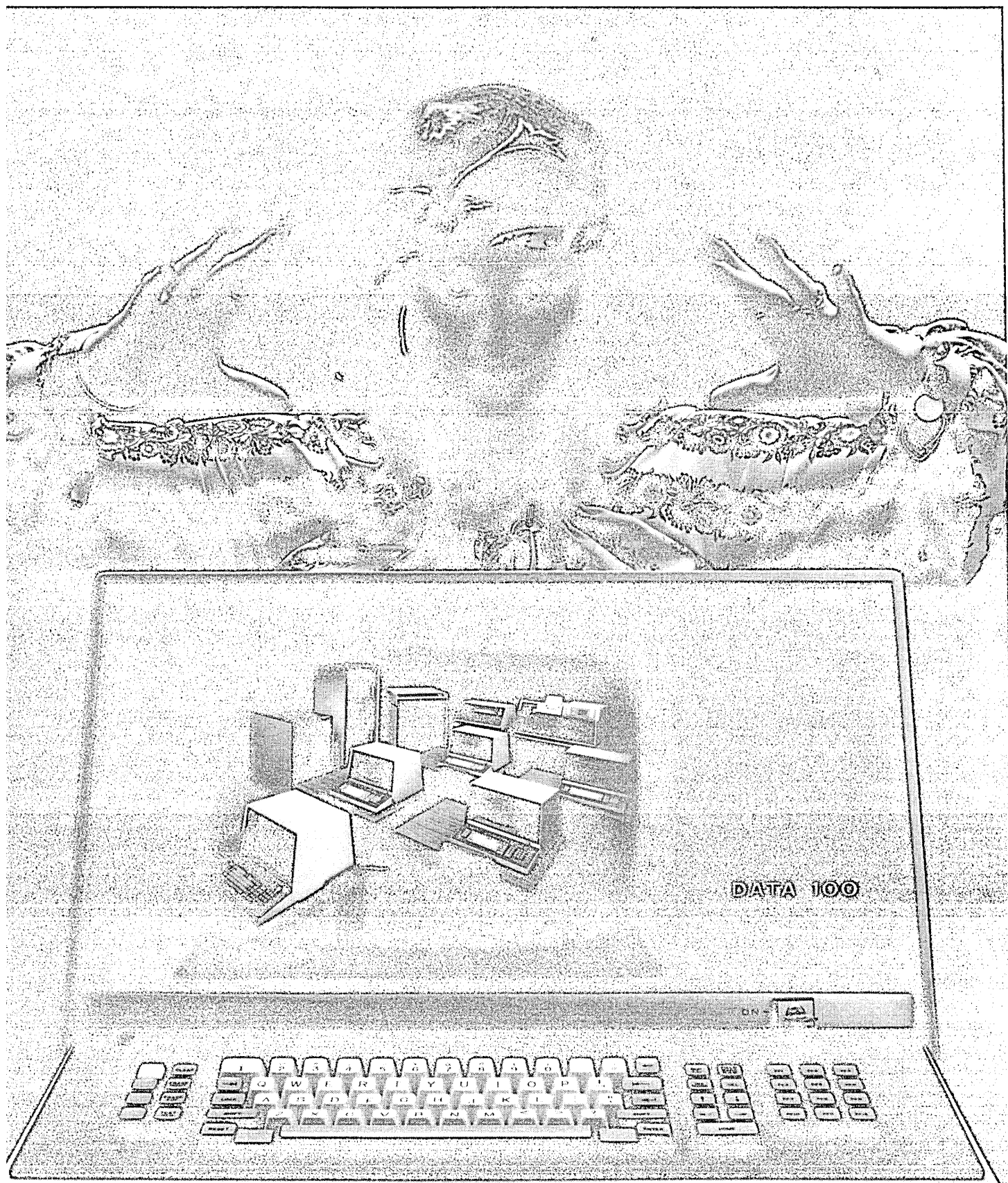

# Very closely at our new Model 85 remote information system.

## How many functions do you see?

There are more than meet the eye.

Batch communications and volume data entry should be easy to spot.

And on-line file management and stand-alone processing should be apparent to those who've kept up with Data 100's continuous progress in distributed processing.

But your needs keep growing.

And so does our commitment to fulfill those needs.

Our Model 85 remote information system introduces the functions of remote file management and high level language processing at your remote sites efficiently and economically.

Model 85 is a display based system featuring up to 100MB disk storage, 15 interactive work stations, a multi-tasking operating system and concurrent communications.

For ease of use, two disk based high level languages are available: RPGII and COBOL. With COBOL, a *local* compiler lets you compile programs on your Model 85. And a *cross* compiler allows stronger central site control by permitting you to compile and debug COBOL programs on the mainframe for execution on your Model 85.

The Model 85 gives your network the best of both worlds. The degree of central site control you need *and* remote processing capabilities to reduce communications costs and mainframe processing time.

And the Model 85 can communicate with our other proven Data 100 multifunction data processing products.

Now look closely at *your* growing needs for multifunction data processing.

Then call your nearest Data 100 sales office or one of the numbers listed below.

### DATA 100

C O R P O R A T I O N

multifunction data processing

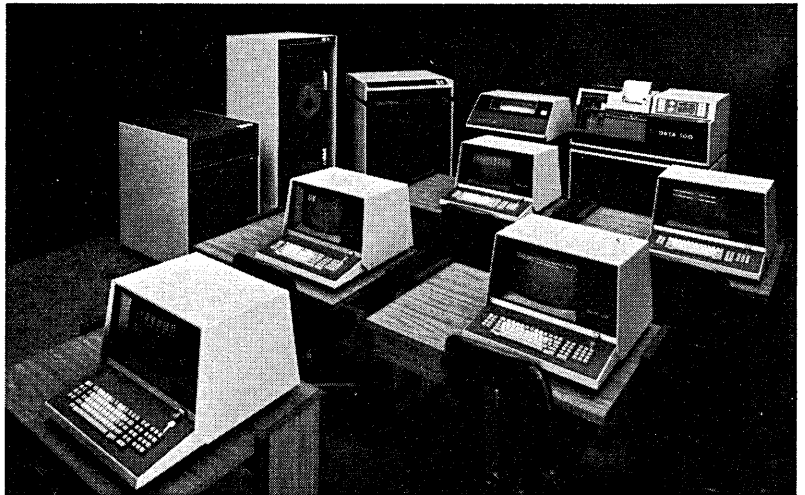

LOS ANGELES 213/645-4300 • SAN FRANCISCO 415/546-6000 • CHICAGO 312/992-0850 • BOSTON 617/848-6100 • DETROIT 313/358-5065 • MINNEAPOLIS 612/941-6500 • NEW YORK 212/867-6200 • PITTSBURGH 412/391-5425 • HOUSTON 713/784-4130 • WASHINGTON D.C. 703/790-5560 • WOODBRIDGE N.J. 201/634-7800 • ATLANTA 404/455-3895 • ST. LOUIS 314/878-4911 • TORONTO 416/494-0434 • MONTREAL 514/761-5894 • LONDON ENGLAND (05827) 63161 • MELBOURNE AUSTRALIA (03) 267-3544 • FRANKFURT GERMANY 72-04-71 • PARIS FRANCE 630-2144

CIRCLE 37 ON READER CARD



zations and two other computer centers in Cleveland and Amsterdam.

GE's Communications Products Dept. produces and markets the Terminet line of printer terminals.

We estimate that revenues from these two operations totalled nearly \$200 million in 1977, with computer services contributing 65%, terminal products 35%. Foreign market revenues are pegged at about 20% of the total.

Percentage of data processing business attributable to main product and service categories.

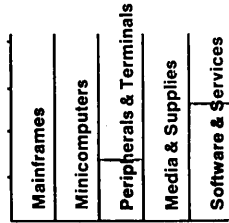

**17 Amdahl Corporation**  
1250 East Arques Avenue, Sunnyvale, CA 94086  
(408) 735-4011

Amdahl's revenues increased by 103% over the previous year's volume, an astonishing accomplishment considering the very competitive market in which the company established itself. As the major supplier of large computer mainframes which are plug-compatible with IBM's large System/370 computers, it offers a product line which was directly affected by the price reductions for existing products and by IBM's 1977 announcement of a new family of powerful processors. A reactive 29% price reduction by Amdahl for its 470 V/6 system resulted in significant gains in demand, and shipments more than doubled over the level of the preceding year.

Amdahl reports considerable customer loyalty in the short time of the company's existence with nearly one out of every four systems shipped in 1977 delivered to customers already operating an Amdahl system. Foreign marketing operations also expanded, primarily in Western Europe, and contributed about 19% of the 1977 revenues.

Percentage of data processing business attributable to main product and service categories.

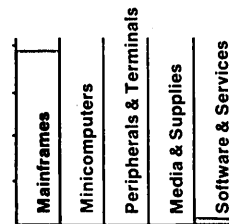

**18 Computer Sciences Corporation**  
650 N. Sepulveda Blvd., El Segundo, CA 90245  
(213) 678-0311

During fiscal 1977 Computer Sciences continued to expand its position as one of the major service organizations in the data processing industry. Revenues attributable to the end user dp community are estimated to have totalled \$176 million.

About three quarters of this volume is attributed to contract services ranging from computer software development to facilities management. The remaining quarter is derived from the operation of INFONET, a network of computer centers and communications service links to customer locations, which offer a broad range of remotely accessible computer programs. INFONET's revenues grew 19% in fiscal 1977, and a third computer center was added near Washington, D.C.

csc's international operations also were further extended, specifically in Europe, where another computer center was installed in Madrid. Revenues from foreign operations contributed 20% of the corporate total.

Percentage of data processing business attributable to main product and service categories.

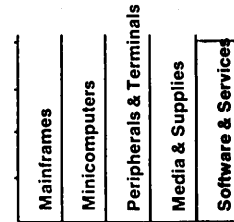

**19 Storage Technology Corporation**  
2270 South 88th Street, Louisville, CO 80027  
(303) 666-6581

Storage Technology's revenues increased by 33% to \$162 million. The expansion of its business volume is due to the increasing demand for disc subsystems which are compatible with IBM mainframes. These and magnetic tape systems account for 97% of stc's revenues. Minicomputer products, marketed under the Ultimacc trademark, account for 3% of revenues. Foreign sales account for about 8% of the total.

Percentage of data processing business attributable to main product and service categories.

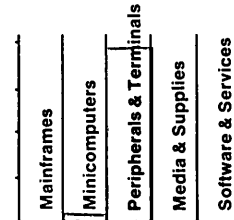

**20 Texas Instruments, Incorporated**  
13500 North Central Expressway, Dallas, TX 75222  
(214) 238-2011

The contribution Texas Instruments' data processing activities made to the corporate total grew strongly. We see the revenues derived from the company's minicomputer-based distributed processing systems and its line of terminals at the \$160 million level—higher than previously estimated—and continuing in their advance. Approximately half of the volume is attributed to peripherals and terminals, about 35% to the minicomputers themselves, and the remainder to software and service revenue. Foreign sales are estimated to provide 10% of the volume.

Percentage of data processing business attributable to main product and service categories.

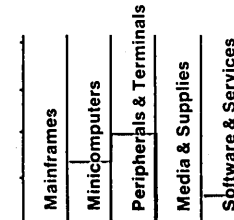

**21 Electronic Data Systems Corporation**  
7171 Forest Lane, Dallas, TX 75230 (214) 661-6000

In its fiscal 1977, Electronic Data Systems dp service revenues advanced to \$157 million. These revenues are derived from the operation of computer systems which Electronic Data Systems undertakes for customer organizations on a contract basis. As a specific service, the corporation is increasingly directing its attention to the processing of claims and benefits payments in insurance-type operations and state welfare programs.

Percentage of data processing business attributable to main product and service categories.

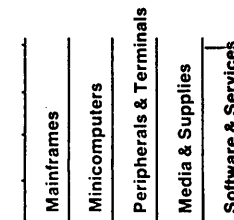

# Install the new **SERIES 2** **KEY-EDIT<sup>®</sup>** distributed data entry system today, and take care of tomorrow, too.

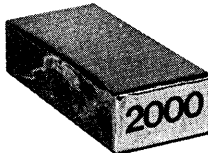
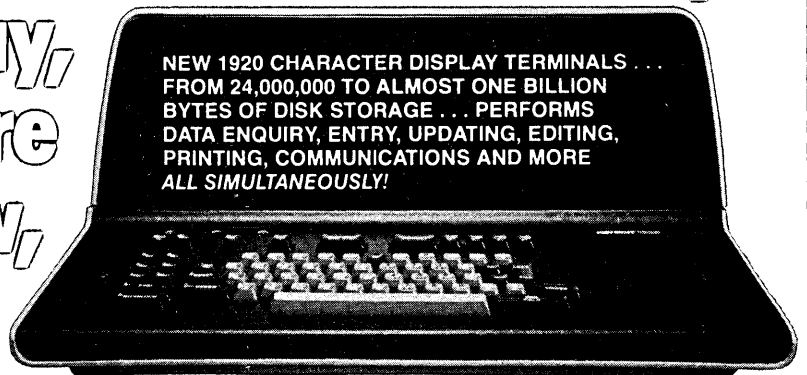

## **SERIES 2 — KEY-EDIT 2000**

**The low-cost alternative to key-punch, key-to-tape and first generation key-to-disk equipment.**

As a starter data entry system, you can't do better than a new KEY-EDIT 2000. You get all the advantages of the *proven* KEY-EDIT concept and software compatibility, but at lower costs than you might expect. Once you move into the shared-processor environment, future potential growth in sophisticated editing and control techniques is assured.

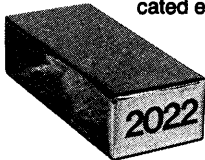

## **SERIES 2 — KEY-EDIT 2022**

**Replace remote batch and communications terminals with a multi-tasking stand-alone KEY-EDIT system.**

For high-performance communications in a data entry environment, you can't ask too much of the KEY-EDIT 2022. It combines the full capabilities of a high-speed remote batch terminal with a powerful multi-tasking key-entry stand alone *processing* system. You can *do more* with a KEY-EDIT 2022 because you *get more!*



## **SERIES 2 — KEY-EDIT 2024**

**The powerful distributed data entry system.**

System 2024 is a distributed data entry system that does it all, including transaction-oriented data collection at local or remote user operating departments. Unique file management techniques enable the user to enquire, enter, update and examine data *in real-time* without affecting the main central computer.

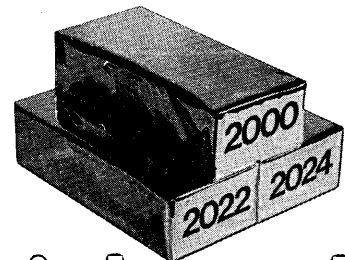

## We built it that way!

Get the complete story on the new SERIES 2 KEY-EDIT family, and what it can do for you. Call Manager, Product Marketing (416) 449-1120. Or write today.

We know you can rely on your KEY-EDIT SERIES 2 system today — and tomorrow, too. Because we built it that way!



# **CONSOLIDATED COMPUTER** INTERNATIONAL INC.

275 Wyman Street  
Waltham, Mass. 02154

Consolidated Computer has already installed over 20,000 KEY-EDIT terminals.

® Registered Trademark of Consolidated Computer, Inc.





**22 Management Assistance Inc.**  
3000 East 44th Street, New York, NY 10017  
(212) 557-8310

Strongly increasing sales of MAI's BASIC/FOUR system and related peripherals were the main contributor to the rise of the company's revenues which reached \$155 million in its fiscal 1977.

Continuing in the transition from an assembler of systems components to a manufacturer of computer systems, MAI now manufactures in-house the central processor of the BASIC/FOUR, the video display, and high speed printer. Then, to facilitate its entry into the word processing market, MAI acquired Avionic Products Engineering Corp. and now markets the Wordstream system through its own subsidiaries.

We estimate that minicomputers contributed 30% to the total revenue, peripherals and terminals 39%, service and software 31%. Foreign operations accounted for 39% of MAI total revenues.

Percentage of data processing business attributable to main product and service categories.

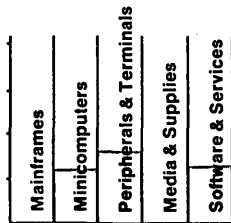

**23 Mohawk Data Sciences Corp.**  
1599 Littleton Road, Parsippany, NJ 07054  
(201) 540-9080

During fiscal 1977 total revenues attained by Mohawk Data Sciences amounted to \$146 million. A reduction in revenues against the previous year is attributed to reduced rental revenues due to sell-off of older equipment, lower sales in some foreign markets, and a planned reduction in oem sales.

Early in 1977 MDS introduced the Series 21, a new line of microprocessor-based data entry and processing devices for which it reports very positive customer response. About 90% of Mohawk's revenues are attributed to peripherals and terminals, 10% to media and supplies. About 57% of Mohawk's revenues derive from foreign markets.

Percentage of data processing business attributable to main product and service categories.

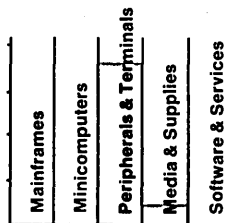

**24 Harris Corporation**  
55 Public Square, Cleveland, OH 44113 (216) 861-7900

The dp revenues which Harris obtained in its fiscal 1977 continued to grow very strongly and are estimated at \$145 million. A considerable part of this increase can be attributed to the acquisition of Sanders Data Systems in January of 1977. Harris' data processing product line now comprises powerful minicomputers, terminals, and electronic text editing and composition systems.

We estimate that 80% of the dp-related revenue is based on peripherals and terminals, 15% on minicomputers and 5% on

software and services. Only 10% of this volume is believed to originate in the foreign market.

Percentage of data processing business attributable to main product and service categories.

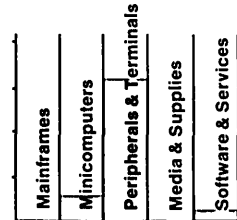

**25 Data 100 Corporation**  
6110 Blue Circle Drive, Minneapolis, MN 55435  
(612) 941-6500

Data 100 continued to expand its position as a major supplier of data entry-oriented peripherals and terminal systems. Revenues from peripherals and terminals make up about 75% of the company's total volume; minicomputers account for 20%, software and services the remaining 5%. Foreign operations contributed approximately 38% to the total revenues.

Percentage of data processing business attributable to main product and service categories.

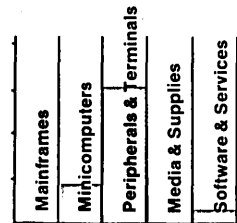

**26 Ampex Corporation**  
401 Broadway, Redwood City, CA 94063  
(415) 367-4456

The revenues which Ampex received from its data processing-related activities are estimated to have grown to \$130 million in fiscal 1977. The organization's continuing success in marketing its magnetic/core memory can be attributed to its specific product orientation to the growth of many established minicomputer installations. We estimate that 75% of Ampex's revenues come from the products in its memory and storage line. The contribution of media and supplies was 20%, service 5%.

About 47% of the volume is attributed to sales in the foreign market.

Percentage of data processing business attributable to main product and service categories.

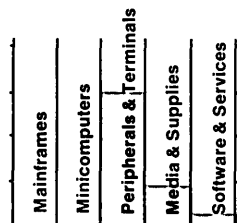

**27 California Computer Products, Inc.**  
2411 West La Palma Avenue, Anaheim, CA 92801  
(714) 821-2011

While CalComp added new models and enhancements to its disc drive and plotter products, its revenues in fiscal 1977 declined about 3%. Revenues from plotting equipment increased 7%, but the revenue from disc and tape products was down about 8%, due to a sizable decrease in shipments to certain major oem customers and a planned reduction in the company's lease base.

We estimate that about 90% of CalComp's revenue comes from peripherals and terminals, 5% each from media and supplies, software and services.

International sales constituted about 23% of the total revenue.

# ADDS SYSTEM 70. OEM.

good reasons why System 70 is easy to buy and even easier to sell

1 Buy a lot. Save a lot.  
Big OEM discounts mean money in the bank.

2 ADDS\* PLUS Data Entry Language, Advanced Diskette Operating System (ADOS), BASIC, FORTRAN IV, Assembler, editing and debugging software are all field proven. And, this extensive software simplifies implementation and saves you dollars.

3 We build 'em for you fast. Our 45 day delivery schedule means less inventory and more money in our pocket.

4 Our Nationwide service means you've got it easy. Over 50 service locations make sure that System 70s keep on working. We provide the service. You save the dollars.

5 With more than 65,000 terminals already installed, ADDS reputation for quality and reliability is unsurpassed.

6 Our terminals fit your customers. System 70's beautiful exterior is human engineered for maximum operator convenience and ease of operation.

7 IBM 3780, Burroughs and teletypewriter communications are all available, making System 70 the right choice for almost any distributed processing environment.



Quality, Reliability, Integrity. It all adds up to ADDS.

**ADDS** Applied Digital  
Data Systems Inc.  
100 Marcus Blvd., Hauppauge  
New York 11787 516-231-5400  
DEPT. 70.

I need more information  
on the System 70. OEM.

Name \_\_\_\_\_

Firm \_\_\_\_\_

Title \_\_\_\_\_

Address \_\_\_\_\_

City \_\_\_\_\_ State \_\_\_\_\_

Phone \_\_\_\_\_

CIRCLE 18 ON READER CARD

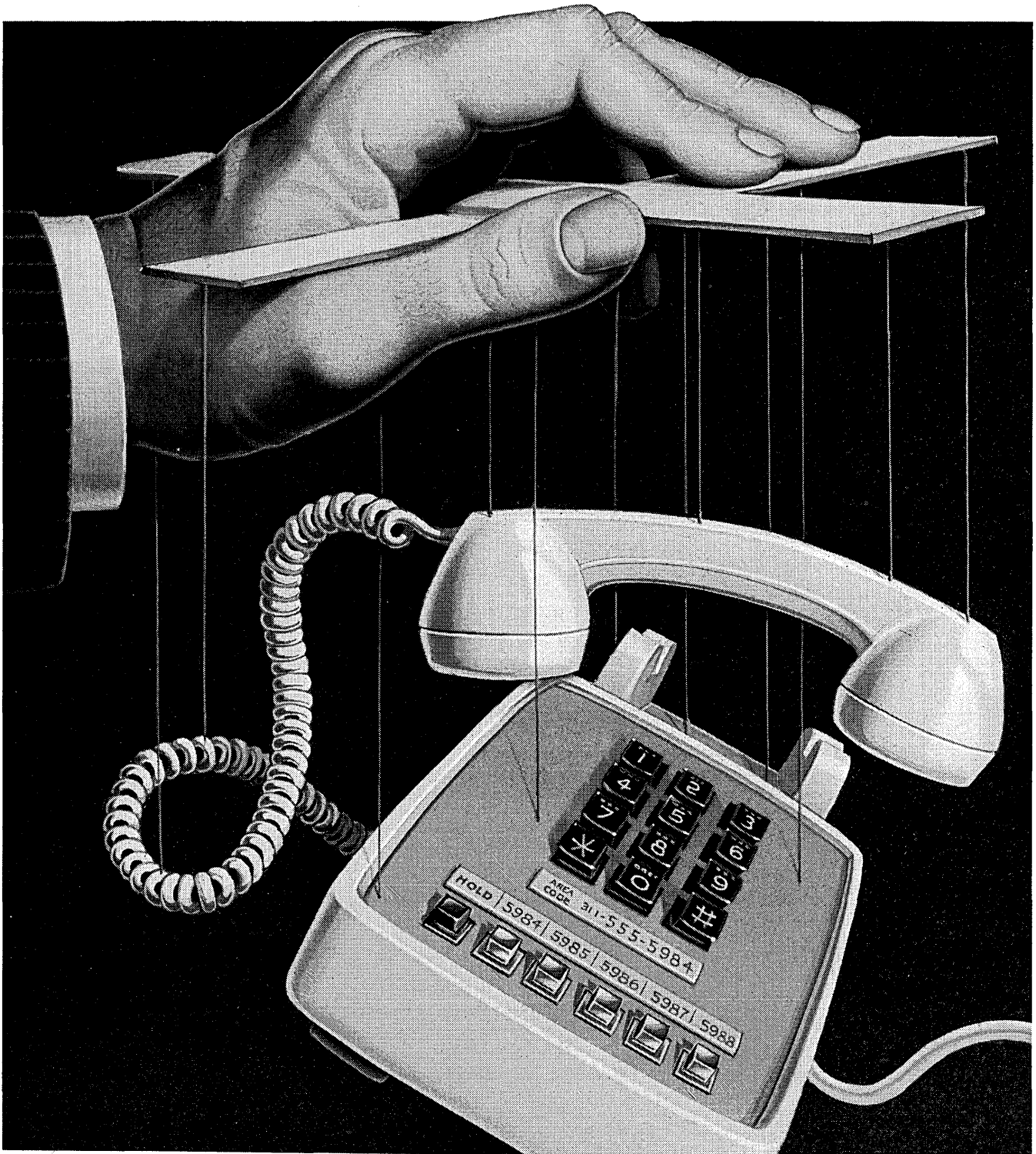

# ANNOUNCING CORPORATE CONTROL OF CORPORATE COMMUNICATIONS.

# PROBLEM:

You run a company with far-flung operations and rising phone bills. You want a better way to control both.

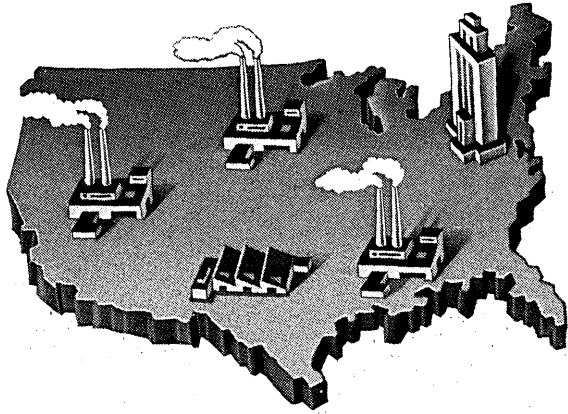

You want your communications to speed the work your people do, not frustrate them. To enable them to dial calls faster and not have to keep redialing when lines are busy.

You want access to a system that will let you make business calls from home or on the road, 24 hours a day, 7 days a week.

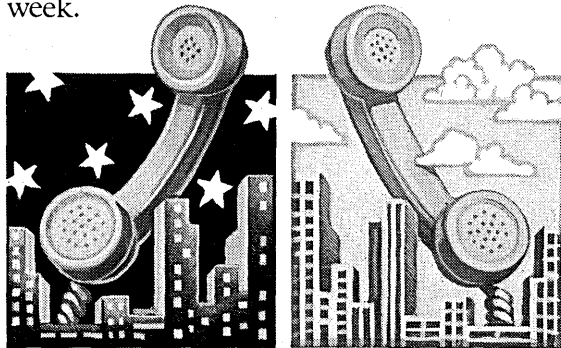

You want to be able to break out charges and allocate them by profit centers or even by individuals.

You want your communications system to monitor itself, to pinpoint troubles. A flexible system you can modify in response to personnel moves and day-to-day requirements.

In short, you want a system you can control, one you can change as your business changes.

It's here!

# SOLUTION:

Introducing a sophisticated system that gives your company control of its communications. Tell it what to do, and it does it. Automatically. Company-wide.

It's called Electronic Tandem Switching (ETS), a way to extend the advantages of Bell's famous Dimension® PBX to all locations on your corporate network.

By bringing together the various elements of your company communications into one, total, integrated system tailored to your specific needs, ETS does just about everything you've told us you want.

It offers over 150 capabilities to fit your individual needs, whatever they may be. It can select the most economical route for every call. It can redial busy numbers automatically and can assure immediate completion of high-priority calls. It can keep minute-by-minute calling records. It provides hands-on management and control, including the setting up of individual calling privileges and restrictions.

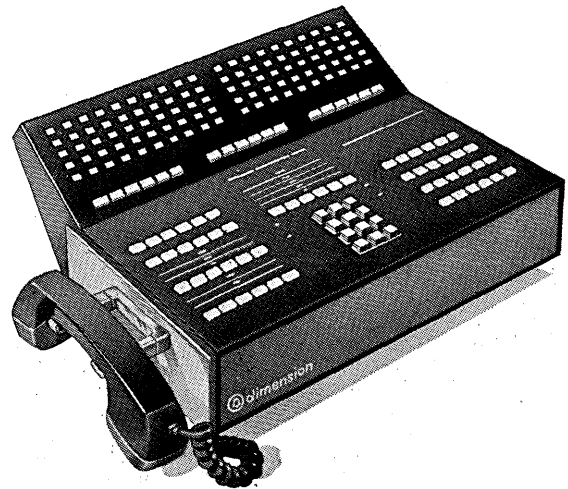

We have teams of problem-solvers ready to fit a Dimension ETS system to your operations and your budget. If you haven't talked systems with your Bell Account Representative lately, your company's missing something.

**The system is the solution.**





**NOW! FROM  
PRINTRONIX...**

**THE FIRST**

**600 LPM**

**RASTER MATRIX  
IMPACT LINE  
PRINTER/PLOTTERS!**

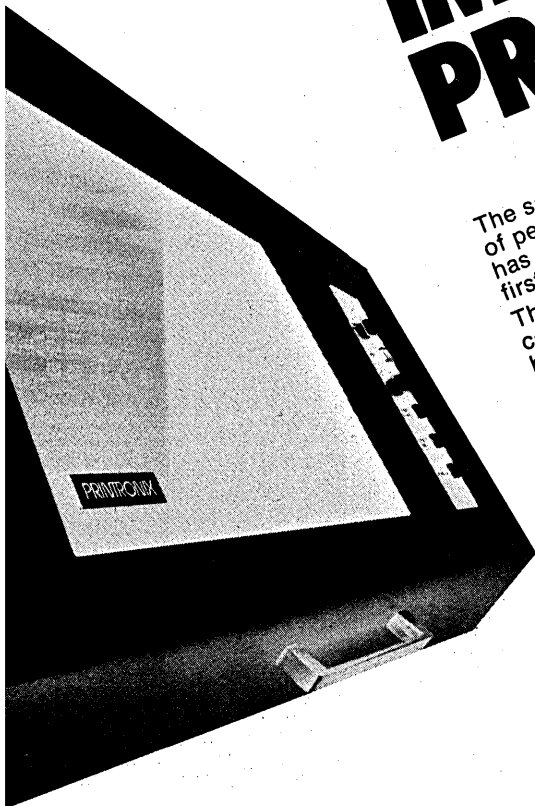

The same unique concept that offers you higher standards of performance in 150 and 300 lpm multi-copy line printing has been applied to produce the Printronix 600, the industry's first 600 lpm raster matrix impact line printer!

The elegantly simple print mechanism assures you of three cost/performance advantages no other impact, chain, drum or belt printer can equal. Unsurpassed print quality. Incomparable reliability, proven by more than 5000 units in the field. And, the capability to plot graphs, charts, bar codes, large character labels or what have you. Alphanumeric printing plus plotting capability for the same price, or less, than an alphanumeric printer alone.

Now Printronix spans the complete medium speed range with 150, 300 and 600 lpm models. At any speed . . . they're your best buy! Get all of the facts. Contact: Printronix, Inc., 17421 Derian, Irvine, CA 92714. (714) 549-8272

**PRINTRONIX**

**The leader in  
raster matrix technology**





Percentage of data processing business attributable to main product and service categories.

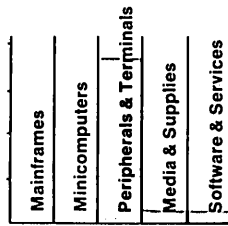

**28 Wang Laboratories Inc.**  
One Industrial Ave., Lowell, MA 01851 (617) 851-4111

During its fiscal 1977, Wang Laboratories enjoyed a 38% growth of its data processing-related revenues which grew to \$114 million and account for an estimated 85% of the total corporate revenues.

The company expanded the range of capabilities of its small computer systems with additional hardware and software features. It is successfully marketing a variety of industry-oriented program packages, and has gained a good foothold in the growing market for word processing systems.

About 40% of the revenues are attributed to minicomputers, 50% to peripherals and terminals. The remaining 10% stems from computer services and software.

Percentage of data processing business attributable to main product and service categories.

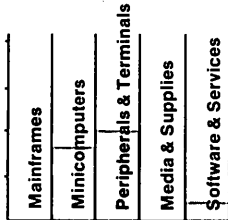

**29 McDonnell Douglas Corporation**  
P.O. Box 516, St. Louis, MO 61366 (314) 232-0232

McDonnell Douglas Automation Company's revenues obtained from outside customers increased by 45% and approached \$112 million. Almost two-thirds of this volume is derived from remote computer services. McAuto's Hospital Services Div., as one of the nation's largest suppliers of data processing services to health care institutions, was the major contributor. Another area of growing activity for McAuto is in providing computer software to companies engaged in manufacturing and distribution, to communications companies, and to organizations engaged in medical claims processing.

Percentage of data processing business attributable to main product and service categories.

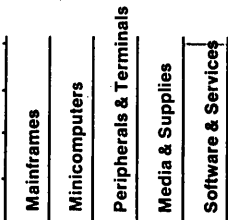

**30 Teletype Corporation**  
5555 Touhy Avenue, Skokie, IL 60076 (312) 982-2000

Teletype Corp., a wholly owned subsidiary of Western Electric Co., which is in turn owned by AT&T, benefitted from the increasing demand for terminal products for use in the general communications area as well as in data processing.

This became specifically apparent as 1977 was the first year in which the Dataspeed Models 40 and 43 became available in volume to commercial customers. In our view the shipment volume of these and older Teletype products which users apply in the data processing environment has advanced to a

level of about \$110 million, 40% of an estimated total of \$270 million.

Percentage of data processing business attributable to main product and service categories.

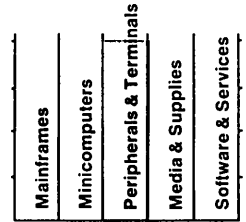

**31 General Instrument Corporation**  
1775 Broadway, New York, NY 10019 (212) 541-8200

The data processing-related activities of General Instrument concentrate in two areas: on-line real-time computer systems and associated equipment to the legalized gaming industry, and electronic point-of-sale systems with associated hardware and software.

We estimate that in fiscal 1977, GI grossed \$106 million from data processing-related activities, 60% of them from terminals and peripherals, 25% from software and services, and 15% from the minicomputer content of its systems.

Percentage of data processing business attributable to main product and service categories.

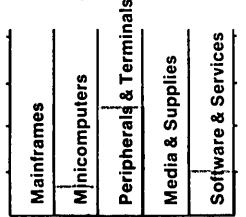

**32 Bunker Ramo Corporation**  
900 Commerce Drive, Oak Brook, IL 60521  
(312) 986-2700

Bunker Ramo's Information Systems Div. continued to be a major revenue contributor to the company in its fiscal 1977. Bunker Ramo operates a nationwide network of regional computer centers and high-speed data lines which disseminate stock quotations and other market information on all North American exchanges to some 20,000 terminals installed at subscribing brokers.

The company also continued actively in the marketing of its data terminal products to the banking, insurance, and other industries.

Dp revenues amounted to \$105 million: 40% from computer services, 25% from minicomputers, and 35% from peripherals and terminals. Only an estimated 10% of this revenue is derived from activities in foreign markets.

Percentage of data processing business attributable to main product and service categories.

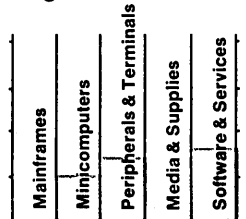

**33 Dataproducts Corporation**  
6219 De Soto Avenue, Woodland Hills, CA 91365  
(213) 887-8000

During Dataproduct's fiscal 1977, the company's revenues from its printer product line advanced by 44% and, with \$86 million, accounted for 75% of the total corporate revenues. Shipments from a new plant in Ireland were begun, directly serving demand by European customers.

Dataproducts still finds demand for its core memory products continuing. Despite the price reductions in this very competitive market, Dataproducts' revenues from core memories increased 33% over the preceding year.

Total dp-related revenues amounted to \$104 million, 90%



of the corporate total. Some 20% of it originated from international activities.

Percentage of data processing business attributable to main product and service categories.

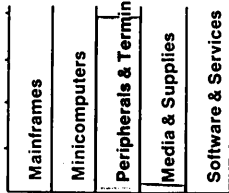

**34 System Development Corporation**  
2500 Colorado Ave., Santa Monica, CA 90406  
(213) 829-7511

During its fiscal 1977, the revenues which System Development Corp. derived from general purpose data processing services to the end user community are estimated to have grown to \$104 million. Their majority was derived from remote computer services and related software. Through the acquisition of organizations with market-specific expertise, such as Stockmaster for warehouse and distribution management systems and Moll Associates for financially oriented systems management services, SDC is trying to improve its situation-oriented marketing potential.

SDC also began the marketing of the TBM II mass storage system manufactured by Ampex Corp., as well as a variety of small, minicomputer-based systems, including an on-line banking system with teller inquiry and signature verification capabilities.

Remote computer services and software are estimated to contribute 90% to the company's data processing revenues, minicomputers and mass storage devices about 5% each.

Percentage of data processing business attributable to main product and service categories.

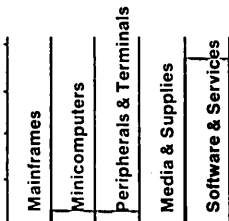

**35 Datapoint Corporation**  
8400 Datapoint Drive, San Antonio, TX 78284  
(512) 690-7000

During fiscal 1977 Datapoint's revenues grew by 34% as it continued in the successful expansion of its product line. This was achieved by the addition of several new models of dispersed small processors for data entry and local processing. It also began the manufacture and shipment of a matrix printer, and strengthened its position in the peripherals area with the acquisition of Amcomp.

We estimate that 30% of Datapoint's revenues came from minicomputers, 60% from peripherals and terminals, and about 10% from service and software.

About 36% of these revenues were derived from international marketing operations.

Percentage of data processing business attributable to main product and service categories.

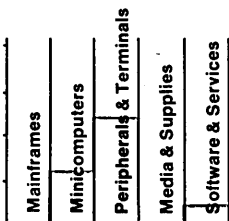

**36 Perkin-Elmer Corporation**  
Main Avenue, Norwalk, CT 06856 (203) 762-1000

The revenues which Perkin-Elmer obtains from its Data Systems Group advanced nearly 30% to \$103 million and account now for 24% of the total corporate revenue. We estimate that the minicomputer products of the Interdata Div. contributed about 55% of the total, peripherals and terminals produced by the WANGCO and Terminals divisions 40%, and that service and software revenues accounted for the remaining 5%. About 25% of Perkin-Elmer's data processing-related revenues originate from its international activities.

Percentage of data processing business attributable to main product and service categories.

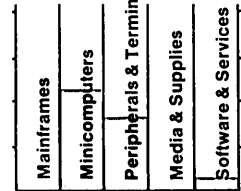

**37 Tymshare, Inc.**  
20705 Valley Green Drive, Cupertino, CA 05014  
(408) 446-6000

Tymshare's revenues continued to grow, reaching \$101 million as the demand for the services offered by the company further increased. In greatest demand were tax processing and hospital administrative services, where Tymshare had strengthened its position in the previous year with the acquisition of Unitax and Medical Data Systems. The expansion of remote computer services was facilitated through the company's TYMNET data communications network.

Tymshare's revenues are derived 96% from services, only 4% from the sale of terminal equipment related to the use of these services.

Percentage of data processing business attributable to main product and service categories.

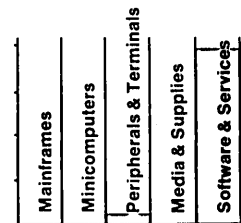

**38 Tektronix, Inc.**  
P.O. Box 500, Beaverton, OR 97077 (503) 644-0161

During fiscal 1977, data processing-related products continued to play an ever larger part in Tektronix's revenues. We estimate that graphic display systems and related terminal products accounted for \$100 million, 22% of total revenue, and that foreign sales accounted for about 40% of that volume.

Percentage of data processing business attributable to main product and service categories.

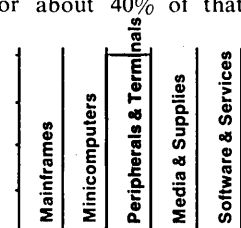

**39 Pertec Computer Corporation**  
12910 Culver Blvd., Los Angeles, CA 90066  
(213) 822-9222

Fiscal 1977 represents the first full operating year for Pertec Computer Corp. since its acquisition of Computer Machinery Corp. During that year Pertec also acquired iCOM, Inc., a manufacturer of microprocessor-based subsystems for microcomputers. Pertec's product spectrum now comprises mag-

# Each test takes us closer to absolute precision in magnetic media

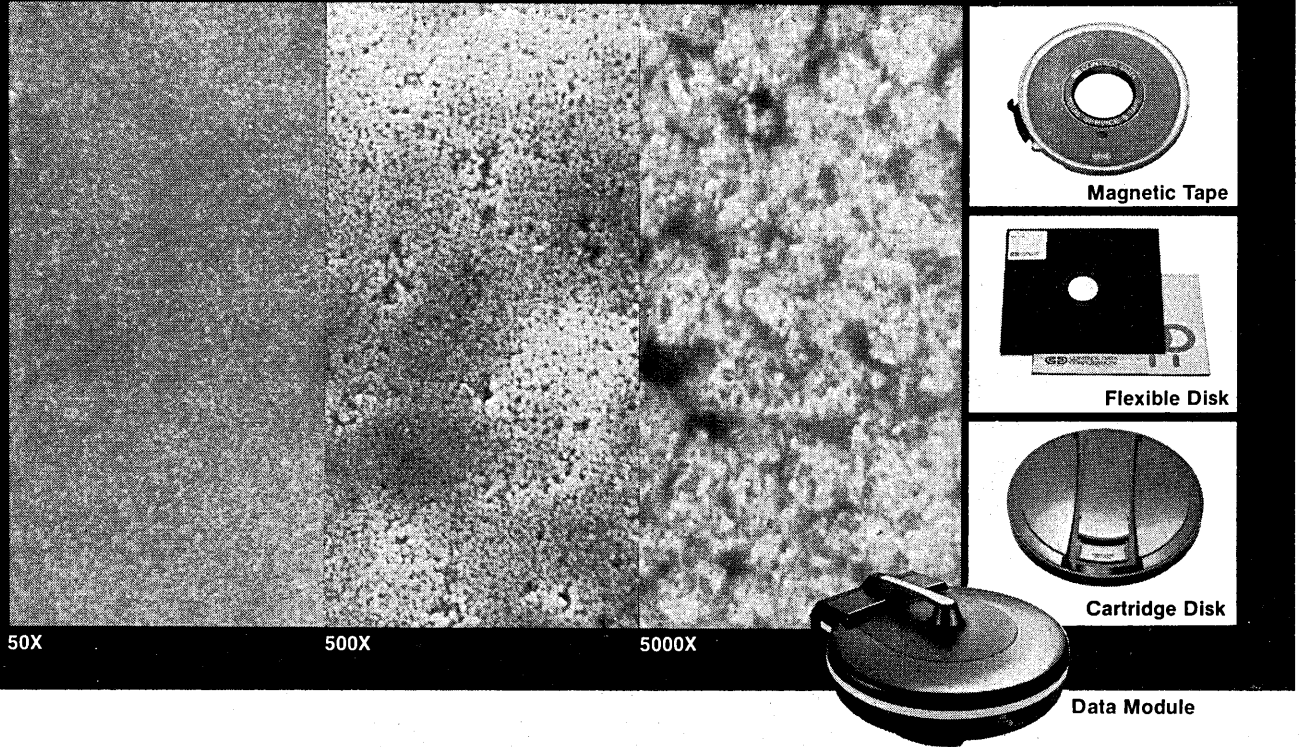

A close look at a section of disk through a scanning electron microscope taken at 50X, 500X and 5000X shows the magnetic oxide coating of the surface. The quality of the surface is of the utmost concern, because of the increasing requirement for higher densities.

Control Data has been responsible for many of the quantum jumps in information density. The higher densities and increased storage requirements of magnetic media demand absolute precision and unyielding quality control standards in their manufacture.

We supply disk packs and cartridges tested to tighter specs than industry standards... to help you prevent data loss. We even support each pack and cartridge with a unique warranty program.

We'd like to tell you more about our complete line of magnetic media. Call your local Control Data sales office. Or

send us the coupon below. We'll send you information on some of the improvements we've made. And how you can benefit from them.

Mr. W. B. Rodemann, Vice President  
Business Products Marketing  
Control Data Corporation  
P.O. Box 1980, Twin Cities Airport, MN 55111

D-68

Send me information on recent improvements in magnetic media.

Tell me more about:

Data Modules  Your Disk Packs for my \_\_\_\_\_ drive  
 Flexible Disks  Magnetic Tapes  Cartridge Disk

Name \_\_\_\_\_ Title \_\_\_\_\_

Company \_\_\_\_\_ Phone \_\_\_\_\_

Address \_\_\_\_\_

City \_\_\_\_\_ State \_\_\_\_\_ Zip \_\_\_\_\_

**CD** CONTROL DATA CORPORATION

**More than a computer company**



**On June 9,  
a new era  
in air cargo  
begins.**



# Announcing United Airlines' "Cargo Super Savers"

New round-the-clock widebody container savings program.

- ▣ One low flat charge in all widebody markets for every container type—gives you discounts up to 30%.
- ▣ Volume discounts can give you additional savings up to 10%.

**Save  
up to  
40%**

- ▣ No time-of-tender restrictions.
  - ▣ Truck rates, at jet speeds, on all widebody flights.
- The first significant new air cargo product and pricing breakthrough since de-regulation.
- Call your local United Air Cargo office for details.

## Think Big. Think United.

 UNITED AIRLINES CARGO

Subject to C.A.B. approval.





netic disc drives, tape transports, and small computers.

Directing its marketing specifically to the data entry and small business systems area, Pertec advanced its revenues to \$95 million. Approximately 72% of this volume is attributed to peripherals and terminals, about 15% to minicomputers, the remainder to software and services, media and supplies.

Percentage of data processing business attributable to main product and service categories.

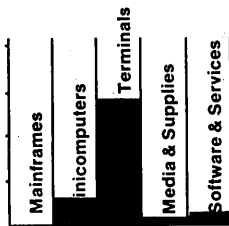

**40 Telex Corporation**  
P.O. Box 1526, Tulsa, OK 74101 (918) 627-2333

In fiscal 1977, Telex showed increased revenues, attributed in part to the expansion of its product scope into terminals—based on the acquisition of Terminal Communications in the previous year. Increasing customer demand for Telex's computer storage peripherals contributed also.

We estimate that the revenues attributable to data processing products and services amounted to \$90 million, with 85% originating from peripherals and terminals, 15% from services.

Percentage of data processing business attributable to main product and service categories.

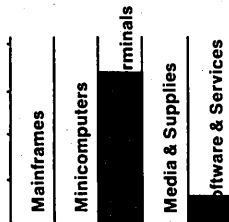

**41 Four-Phase Systems, Inc.**  
10700 North De Anza Blvd., Cupertino, CA 95014  
(408) 255-0900

Four-Phase's revenues climbed to nearly \$89 million, due to the continuing strong acceptance of the various models of the System IV family of transaction processing systems. Designed specifically for interactive network applications, the popularity of Four-Phase's products among the users lies in the effectiveness of combining local data entry and processing with an on-line inquiry interfacing capability to a remote host computer.

Minicomputer processors, peripherals and terminals combined for a share of about 80% of total revenues, with the remainder derived from software and services.

Percentage of data processing business attributable to main product and service categories.

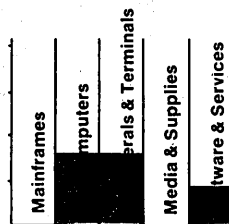

**42 Raytheon Company**  
141 Spring Street, Lexington, MA 02173  
(617) 862-6600

Commercial sales of data processing equipment by Raytheon's Data Systems Co. advanced with the increasing

acceptance of the company's programmable terminals and distributed processing systems. Revenues attributed to these activities amount to about 3% of the corporate total, or \$85 million. The largest share in this volume, about 80%, is held by terminal products, which have a specifically strong market with airline companies all over the world. Minicomputers account for about 15%, services and software for the remaining 5%.

Percentage of data processing business attributable to main product and service categories.

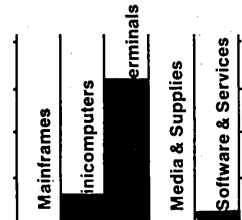

**43 General Automation, Inc.**  
1055 South East Street, Anaheim, CA 92805  
(714) 778-4800

With continuing strong demand, General Automation's oem minicomputer activities expanded further, accounting for an estimated 60% of the total revenues of \$84 million. Peripheral revenues contributed about 20%, as did software and services. Foreign activities accounted for 25% of the business volume.

Percentage of data processing business attributable to main product and service categories.

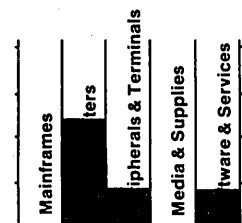

**44 Sycor Inc.**  
100 Phoenix Drive, Ann Arbor, MI 48104  
(313) 995-1121

The demand for Sycor's product line of data-entry-directed intelligent terminals and display systems continued strongly in the domestic market as increasing activities boosted the need for data entry devices. Foreign market revenues were lower than in the previous year, but volume shipments of Sycor 440 clustered terminal systems to the Brazilian computer firm Computadores e Sistemas Brasileiros S.A. (COBRA) aided improvement in the second half of the year. Total revenues advanced to \$77 million, of which international activities contributed about 31%.

Percentage of data processing business attributable to main product and service categories.

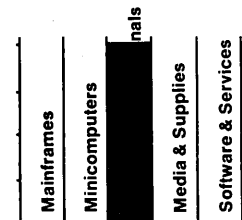

**45 Informatics, Inc.**  
21031 Ventura Blvd., Woodland Hills, CA 91364  
(213) 887-9040

Informatics strongest revenue growth was in information processing services, partly due to the acquisition of Management Horizons Data Systems. The fastest growing business segment within this area is Informatic's litigation information management, a computer-based system serving the legal profession.

# The new MDS 21/50. Series 21 grows bigger for you.

Mohawk Data Sciences announces System 21/50, the latest member of the Series 21 family of distributed processing systems.

System 21/50 doubles the power and doubles the capacity of Systems 21/20 and 21/40—but retains the pricing breakthroughs that have made Series 21 a worldwide solution to data entry, stand-alone operations and distributed processing requirements.

A System 21/50 performs multiple functions, uses high level language, and does the local office processing you need right now. And the System 21/50 grows with you. With

main memory up to 128K. With disk storage to 20 megabytes. With printers from 45 cps to 600 lpm. And with magnetic tape drives and communications options as you need them.

Now with three Series 21 systems to choose from, you can mix and match just the right amount of power for your dispersed locations. System 21/20 for easy conversion of source documents. Next, the System 21/40 for local processing power in small offices. And now, the new System 21/50 for more sophisticated applications requiring multi-programming, larger internal memory, and faster processing

speeds. Best of all, Systems 21/20 and 21/40 can be expanded to the System 21/50.

Wherever in the world you find Series 21, you'll find MDS customer support and field engineering as well. Our 300 worldwide sales and service offices serve over 6,500 customers around the globe.

Send us the coupon right now, and learn more about the MDS Series 21—the one-stop solution to your distributed processing needs. Or call James J. Byne, V.P. Sales, (201) 540-9080.

Series 21, MOBOL and MDS are trademarks of Mohawk Data Sciences.

*Multi-function concurrency: three tasks at same time.*

*Binary synchronous communications: Industry standard interfaces*

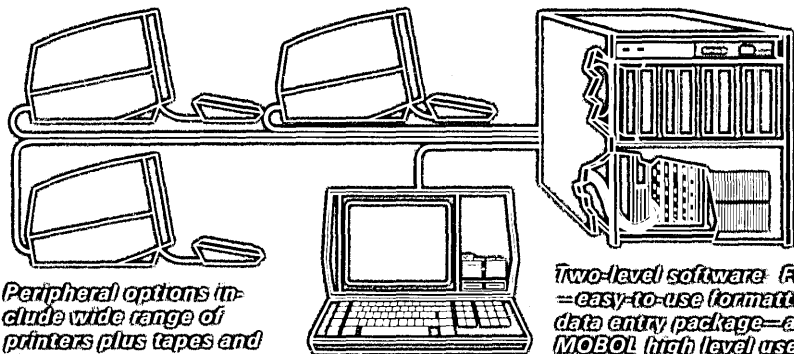

*Peripheral options include wide range of printers plus tapes and disks.*

*Two-level software: FDEP = easy-to-use formatted data entry package—and MOBOL high level user language.*

*From 1 to 4 operator stations, each with 1920-character screen; choice of keyboard styles.*

Mohawk Data Sciences  
1599 Littleton Road, Parsippany, N.J. 07054

Send me information on the MDS Series 21

System 21/50  System 21/40  
 System 21/20

Name \_\_\_\_\_  
Title \_\_\_\_\_  
Company \_\_\_\_\_  
Street \_\_\_\_\_  
City \_\_\_\_\_  
State \_\_\_\_\_ Zip \_\_\_\_\_

I'm in a hurry. Have a representative call.  
DM 678



**Mohawk Data Sciences**

CIRCLE 54 ON READER CARD





## TOP COMPANIES

The second most actively growing source of revenues is the software products area, led by MARK IV.

Percentage of data processing business attributable to main product and service categories.

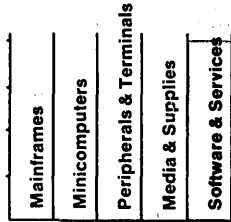

### 46 General Telephone & Electronics Corp. One Stamford Forum, Stamford, CT 06904 (203) 357-2000

The revenues which GTE Information Systems provided to the corporate total in 1977 are estimated to have grown \$75 million. Obtained for computerized services to the security trading industry, about 20% are derived from terminal products, 80% from the services rendered. Though sufficient to place the firm on DATAMATION's Top 50 list, dp revenues amount to only about 1% of GTE's gross.

Percentage of data processing business attributable to main product and service categories.

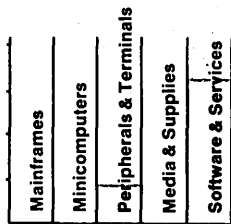

### 47 Litton Industries, Inc. 360 North Crescent Dr., Beverly Hills, CA 90210 (213) 273-7860

Dp products and services offered by Litton Industries' Business Machines and Retail Information Systems continued their expansion as retail organizations increased the installations of electronic support systems. We estimate that the firm's volume of point-of-sale terminal systems and small business computers reached \$70 million. Of this, 75% is attributed to terminals and peripherals, 5% to minicomputers, and 20% to services and software.

About a quarter of this volume is attributed to foreign operations.

Percentage of data processing business attributable to main product and service categories.

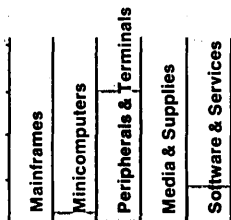

### 48 Recognition Equipment, Incorporated P.O. Box 22307, Dallas, TX 75222 (214) 438-8611

Revenues derived by Recognition Equipment in its fiscal 1977 came from its input equipment for data processing, such as its optical character readers for check processing and optical wands for point-of-sale use. About 70% of this \$70 million volume originates from peripherals and terminal products, 25% from services and software, and the remaining 5% from

the minicomputer content of some of the systems. About 34% was derived from foreign operations.

Percentage of data processing business attributable to main product and service categories.

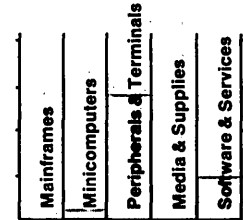

### 49 Planning Research Corp. 1850 K St., Washington, D.C. 20006 (202) 293-4700

PRC is mainly known for its work in planning and management for engineering and architectural clients. Recently it has also grown in a variety of dp services. These include systems development, turnkey installations, facilities management, computer processing, and some specialized ones like multiple listing services offered through its subsidiary Realtronics.

Of the corporation's total revenues, \$69 million, or 37%, is thought to come from these dp activities. And 17% of the \$69 million is estimated to originate with the operations of its U.K.-based affiliate, Logica.

Percentage of data processing business attributable to main product and service categories.

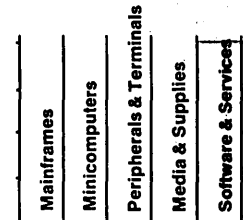

### 50 Wyly Corporation P.O. Box 6228, Dallas, TX 75222 (214) 688-7100

Holding up the rear, with a very respectable \$69 million in dp revenues, is Wyly. Since the termination of its SATRAN subsidiary in 1976, the corporation again depends on the data processing services of its University Computing Co. as the source of almost all of its revenues. Well established domestically and abroad (more than half of its revenues originate from international operations), it was able to expand these revenues to 97% of the corporate total of \$71 million.

Percentage of data processing business attributable to main product and service categories.

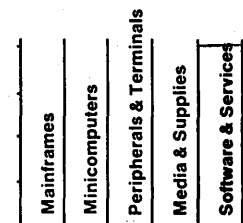

Mr. Rothenbuecher is a senior staff member of Arthur D. Little, Inc.'s Information Systems Planning and Management Group. He has been with the dp industry for more than 20 years. Presently he is doing applications, development, operations audit, product development, and marketing research for domestic and overseas clients.

# "I design the best!"

— John Jacobs, ADDS Chief Engineer

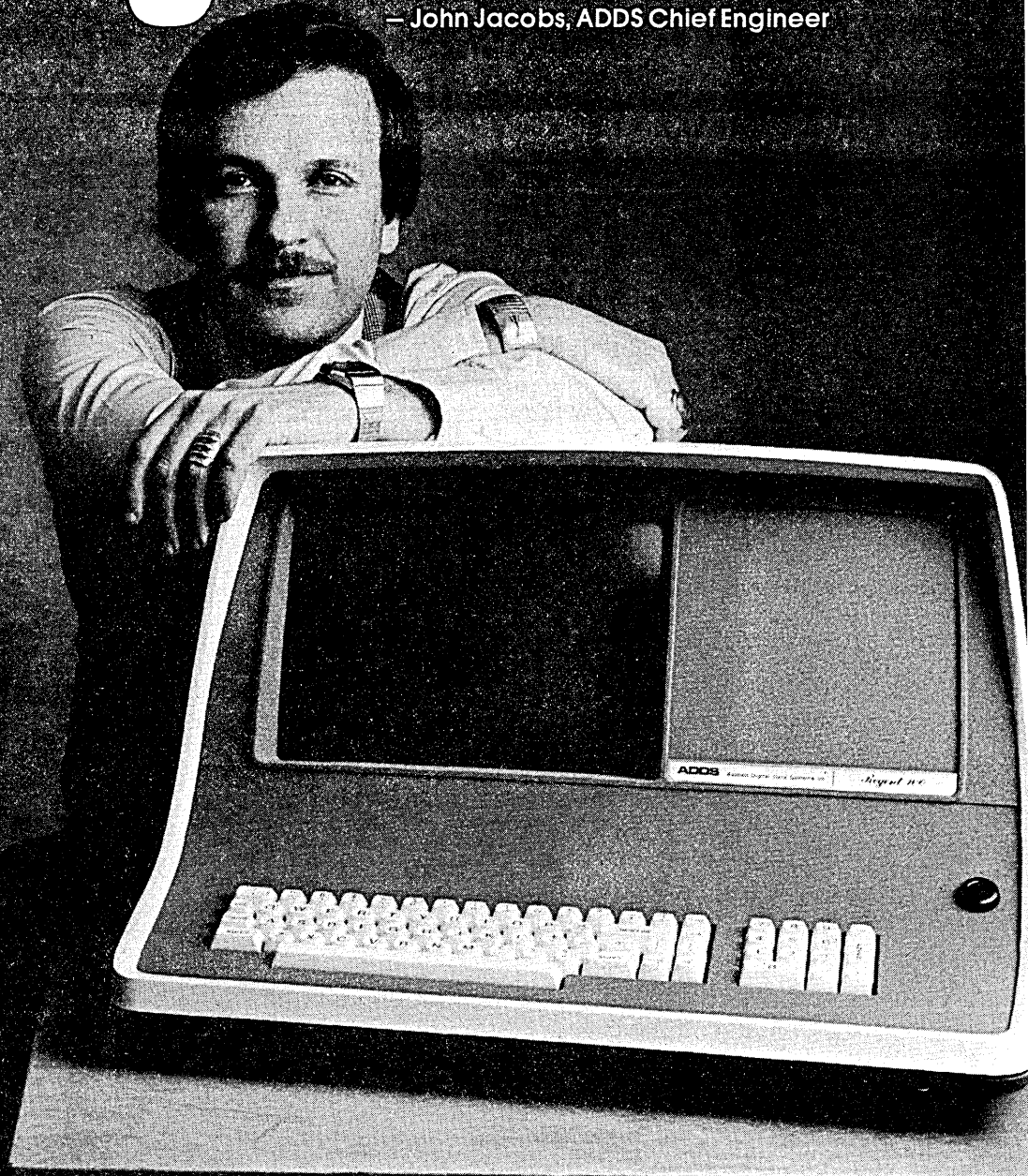

ADDS Regent is about the best TTY terminal money can buy. I know. I designed it.

State-of-the-art: Regent uses the highest performance microprocessor components available. I know. I specified them.

In fact, our sophisticated technology means Regent is a remarkably simple terminal. It has fewer components than most of our competitors.

That means fewer problems. And more Regent's in your future.

From the beginning, I've designed ADDS equipment to be the very best. And 65,000 installed terminals have proved me right.

ADDS Regent. Quality you can rely on.

ADDS, Applied Digital Data Systems Inc., 100 Marcus Blvd., Hauppauge, NY 11787, (516) 231-5400.

CIRCLE 11 ON READER CARD

# ADDS REGENT

**“A BUSINESSMAN WANTS  
A COMPUTER SYSTEM  
TAILORED TO HIS BUSINESS.  
AT A PRICE THAT WON'T  
DRIVE HIM OUT.”**

John S. Marr, President  
The Computer Center, Inc.  
Data General  
Business System Supplier  
Falmouth, ME





When the W. H. Shurtleff Company got together with The Computer Center and Data General's CS/40 small computer system, the chemistry was right. According to Shurtleff's President, William Poole, "The CS/40 allowed us, with the help of The Computer Center, to develop our own special industry packages. After 30 years in chemical distribution, we know the best way to run a successful business. We saw faster response

and more control would let us do an even better job. The CS/40 with our own software gives us what we wanted. And all for less money than we were spending with an on-line service bureau."

And John Marr of The Computer Center, "What's in the system and how it works lets me develop applications, sell and install first time users in the absolute minimum of time. My customers love it. The system is very easy to operate. And they can fit the system to their business, rather than change procedures that have made them successful. CS/40 is a super product. I've just ordered another 15 systems."

# "I'LL BUY THAT."

William W. Poole, President  
W. H. Shurtleff Company  
Portland, ME

## Data General

We make computers that make sense.

The CS/40 makes good business sense. Send me more information.

I'm an  end-user  business system supplier  
 I'm too busy to wait for brochures. Have someone contact me.

Name \_\_\_\_\_ Title \_\_\_\_\_

Company \_\_\_\_\_ Tel. No. \_\_\_\_\_

Address \_\_\_\_\_

City \_\_\_\_\_ State \_\_\_\_\_ Zip \_\_\_\_\_

Data General Corporation, Westboro, MA 01581, (617) 366-8911. Data General (Canada) Ltd., Ontario.  
Data General Europe, 61 rue de Courcelles, Paris, France, 766.51.78. Data General  
Australia, (03) 89-0633. Data General Ltd., Sao Paulo, Brazil.  
543-0138. © Data General Corporation, 1978. DM6

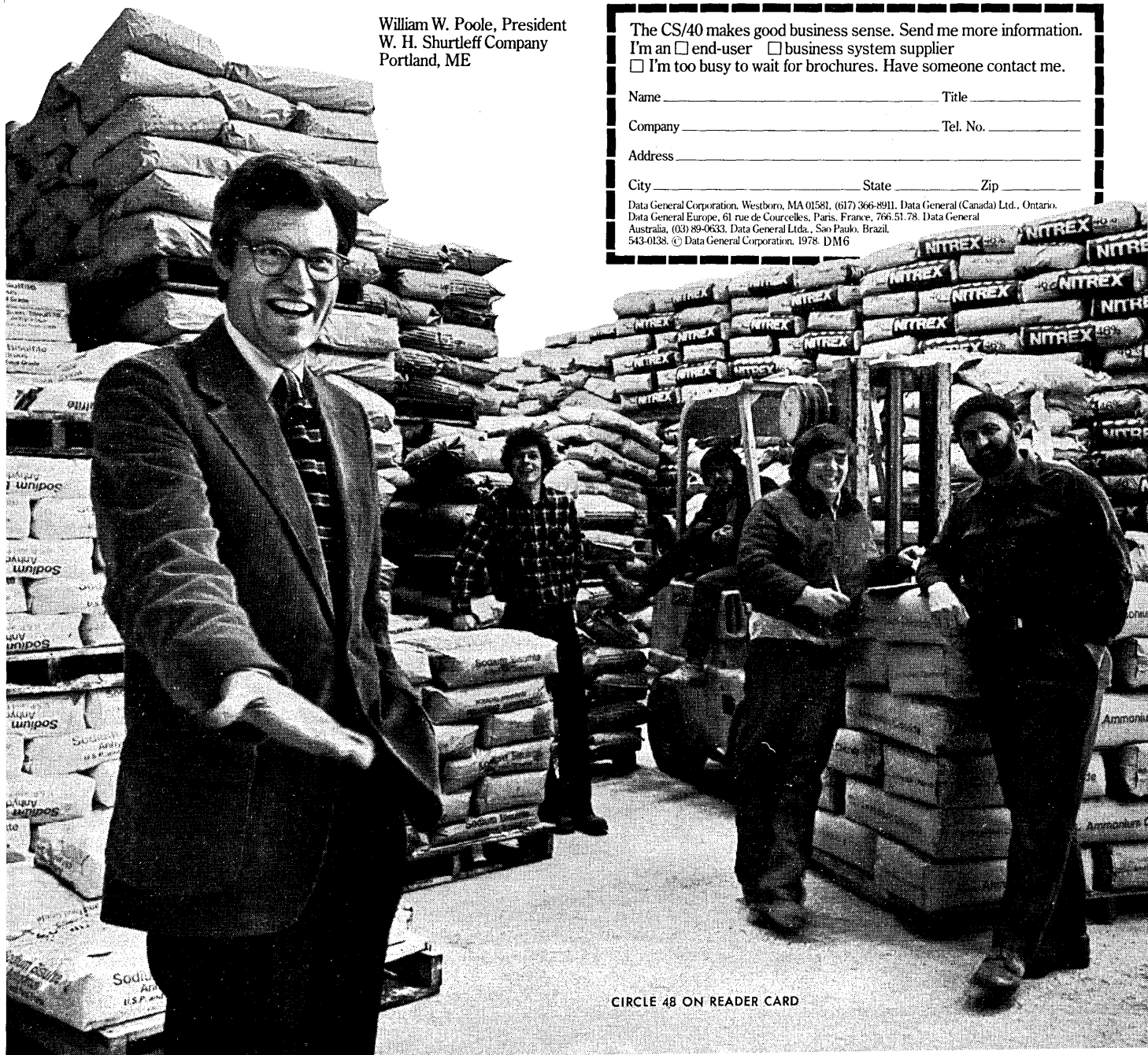

CIRCLE 48 ON READER CARD

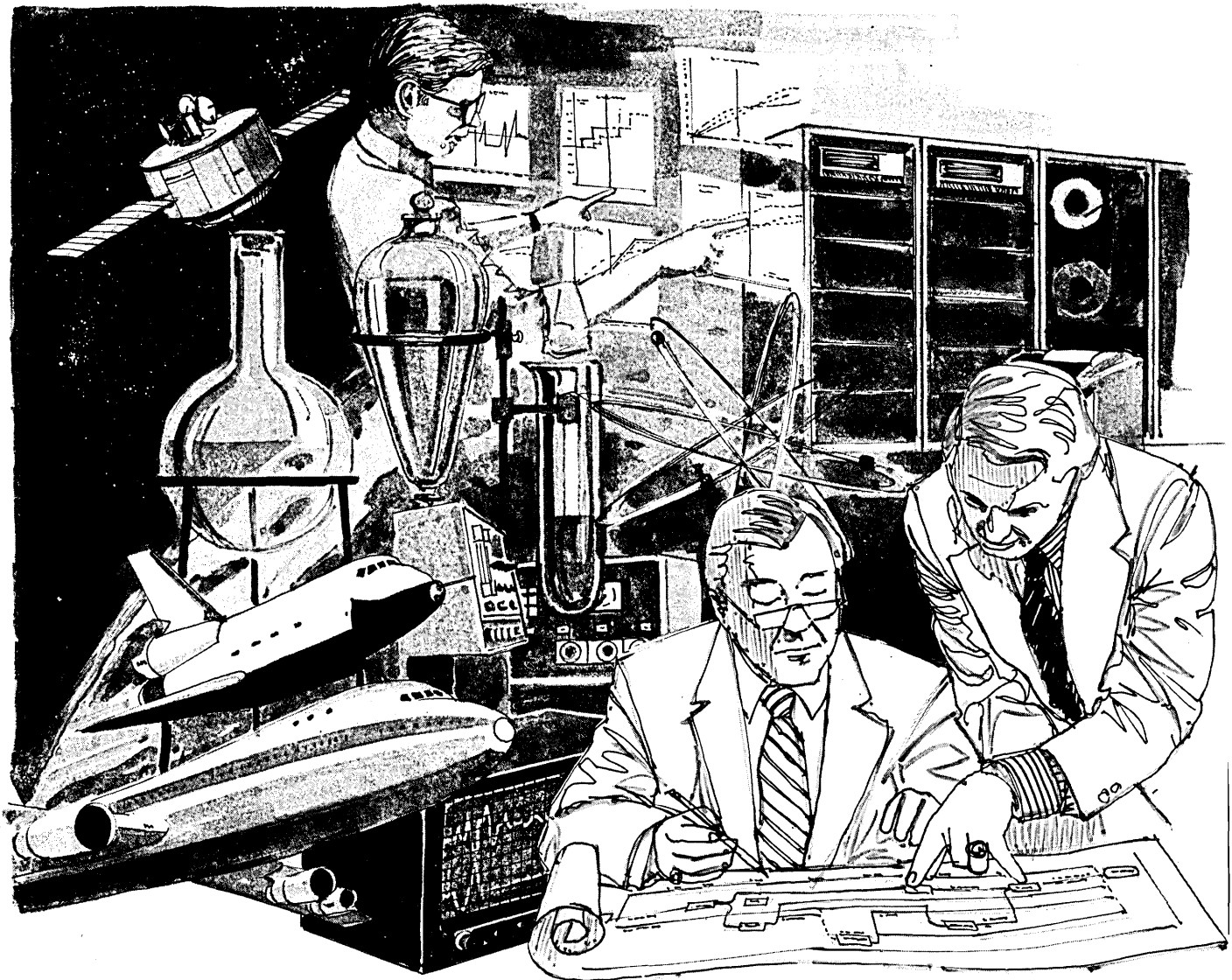

# "HANDS-ON" PROJECT MANAGEMENT

*EZPERT® Project Graphics System puts visibility into your project planning, scheduling, monitoring and control...when you need it, where you need it, and how you need it.*

If you're involved with project management you know how critical it is to see how a total project "fits" together, and how interdependent activities affect its day-to-day progress.

Now EZPERT puts that visibility into your hands—like no other system can—with *Time Scaled Networks, Gantt Barcharts and Cost/Manpower Graphs*...produced and updated automatically.

**Fast and accurate.**

EZPERT can give you totally revised and virtually error-free graphics within hours of a project change. So management decisions are always based on current and correct information.

**Easy to use.**

If you're currently using project management techniques, you're already doing most of the work. EZPERT uses the same basic information to automatically produce project graphics on an electrostatic, pen or microfilm plotter.

**Join the group.**

Leading manufacturing and aerospace companies, engineering/construction contractors, utilities, financial institutions and government agencies are already using EZPERT. Maybe you should be too. Call us for more information—today!

*Overseas Sales Representative inquiries invited.*



**SYSTONETICS, INC.**

600 N. Euclid Street, Anaheim, California 92801  
(714) 778-1600

# THE TALLY PRINTER TERMINAL

## Control 42 functions via the keyboard or the program

The Tally T-1612 Printer Terminal is designed for the user. It's loaded with functions and features. In addition to 42 programmable functions, which are available through the keyboard or through the user program, you get features like outstanding print quality, optimized bi-directional printing at 160 cps for bonus throughput, quiet operation for office use, lots of forms control conveniences, table top or pedestal mount and outstanding reliability that translates into low cost of ownership. And plenty more.

Unique features include six selectable type fonts in upper and lower case, LED column/line indicator, non-destructive memory providing pre-selected configuration on power up and 1k buffer standard (up to 4k optionally).

The Tally T-1612 is also available as a Receive Only printer. Both versions sustain a full 1200 Baud transmission rate. Or you can select 300, 600, 2400, 4800 or 9600 Baud operation.

Call Tally today.

# TALLY<sup>®</sup>

#### OEM SALES OFFICES

Boston (617) 272-8070

New York (516) 694-8444

Chicago (312) 325-9788

Los Angeles (213) 378-0805

Miami (305) 665-5751

San Jose (408) 247-0897

Seattle (206) 251-6730

San Antonio (512) 733-8153

Washington, D.C. (703) 471-1145

#### BUSINESS SYSTEMS SALES

Orinda, CA (415) 254-8350

CIRCLE 68 ON READER CARD



# Pick a number. Any number.



1700



1720

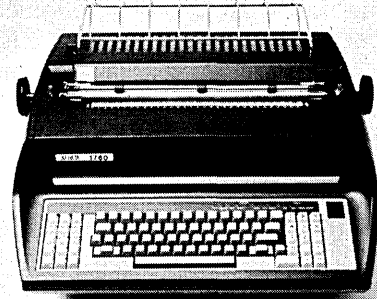

1760

The next time you pick a terminal, you don't have to gamble about which one to choose. Because Xerox has a number of communications terminals that are just right for you.

Like our 1700 and the new 1720. Both pay off with low cost operation, sharp, crisp characters from Diablo's HyType II print mechanism, 45 cps, and a full range of easily-changeable type styles. The 1720 also offers switch selectable ASCII and 2741-compatible codes. And when you consider that both terminals come with other features usually optional or not even available on most terminals you know that you've placed a good bet.

If you're doing on-line applications, then the Xerox 1760 is your lucky number. The new 1760 has an impact

matrix printer, which gives you both upper and lower case, rapid quality printing, and automatic bi-directional printing. The ASCII Coding lets you connect to almost any hardware and software system around. And if speed is the name of your game, the 1760 prints up to 200 cps.

For more information call Pete Hegerle, Xerox Data Systems Division, (213) 679-4511, or write him at 701 S. Aviation, El Segundo, CA 90245.

With the Xerox 1700, 1720, and 1760, there's no reason to take chances the next time you choose a terminal. Because each one of our numbers is a winner.

## XEROX

# Processing Satellite Data

by Eric Teicholz

---

Satellites have helped locate \$1 billion in oil reserves and hundreds of \$ millions in minerals, inventoried crops, estimated timber yields, monitored pollution, and studied urban sprawl. But *getting* their data is the easy part.

---

In July 1972, NASA launched the first Earth Resources Technology Satellite, LANDSAT 1 satellite, primarily for the U.S. Dept. of Agriculture and the since-renamed U.S. Geological Survey. The satellite's purpose was to gather information on the light and other radiation coming from the surface of the earth, primarily for studying the planet's natural resources. Such data gathering had been done primarily with aircraft before then, and primarily using cameras.

---

According to the *New York Times*, LANDSAT has even located better fishing spots for USGS scientists.

---

LANDSAT represented the first time anyone had used satellites for resource data gathering, and the first time multispectral sensors had been used in place of conventional cameras.

Since that first LANDSAT became operational, over \$1 billion in oil reserves and hundreds of \$ millions worth of mineral reserves have been located. Using LANDSAT data in conjunction with computer analyses, such as digital image enhancement, pattern recognition and classification techniques, analysts have inventoried millions of acres of crops and forests, estimated timber and crop yields, located millions of gallons of surface water, determined watershed characteristics, developed base maps and land-use maps for the world,

studied urban growth patterns and demographic characteristics, monitored water quality and air and water pollutants, located geological faults, and

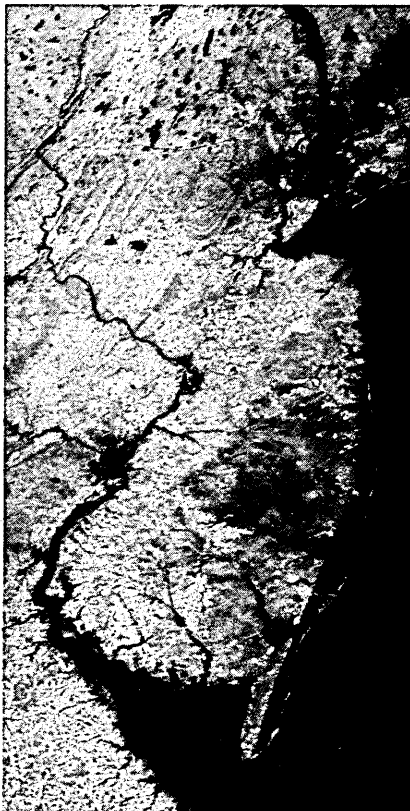

Photomosaic of New York/New Jersey area constructed from three LANDSAT frames. Courtesy of Image Processing Inc.

answered basic questions about the quality of our environment. The *New York Times* reported that LANDSAT even located better bass fishing grounds in Virginia for USGS scientists.

Now there are three U.S. LANDSAT's, each orbiting the earth every 103 minutes. All carry multispectral scanners that sense radiation within five wavelength bands in the visible and infrared portions of the electromagnetic spectrum. This data is communi-

---

Using conventional methods the inventory would take two years and cost ten times as much.

---

cated to earth receiving stations located in the United States, Canada, Italy, and Brazil; by the end of this year, there will be a station in Iran as well.

This data is exploited in a variety of ways for a great number of applications. However, most remote sensing applications do not rely on satellite technology alone. Multilayered data collection systems, incorporating ground and aircraft observation, are usually employed. On-site field investigations to determine "ground truth"—what's really on the ground—are essential for interpreting remotely sensed data of any kind. Aircraft are used because they are able to acquire data both at a higher spatial resolution than satellites provide, and on a more flexible



## SATELLITE DATA

schedule. (Satellites are, after all, run on a rather firmly fixed timetable.)

The LANDSATs' benefits come from their high altitude (920km or 571 miles above the surface), which results in their "observing" a large area at one time (a field of about 185 x 185km), and their high resolution, which allows them to discriminate between features on the ground which are as little as 80 meters apart. In addition, the repetitive nature of their observations (each passes over the same points every 18 days) is very helpful in detecting changes on the ground.

### Applications of LANDSAT data

Current major applications for LANDSAT data include:

**Agriculture:** Remote sensing has been employed to better manage agricultural systems and for accurate and timely determination of the output of key agricultural commodities. The resolution and frequency of satellite coverage is not adequate to enable decision making

### Crops on fields as small as five acres can be accurately identified.

related to planting, fertilizing, watering, or crop quality evaluation, but the data can be used for things like soil classification. For example, LANDSAT data has been used to prepare soil maps at scales ranging from 1:50,000 to 1:250,000. (For comparison, maps for marking trails, roads, and houses—which are portrayed as small dots—are drawn at a reduction of 1:24,000.)

Satellite sensing turns out to be an extremely cost effective way to gather data for those maps. Where the cost of computer analysis will run roughly 0.2¢ per hectare (a metric unit equal to 2.47 acres), aircraft data for the same area would be roughly 1.5¢ per hectare. And the ability to digitally overlay soil maps on base maps leads to the capability of determining *potential* agricultural development as well. Although this might be done with maps made using aircraft scanning too, using the satellite data is more convenient and less expensive.

Another agricultural application is in inventorying crops. Due to differences in growth patterns and planting and harvesting dates, certain crops can be identified by the satellites. Again, the regularity of the bird's orbit proves beneficial in this.

The accuracy of LANDSAT data for crop identification in wheat growing areas in the United States is being studied in a USGS project called the Large Area Crop Inventory Experiment (LACIE). The project is monitoring

wheat planting, yields, and crop conditions and checking the data against ground truth and conventional data to determine the accuracy of LANDSAT forecasting.

So far, the accuracy of the data is 90% or better for fields of 20 acres or larger. Crop identification has been achieved with approximately 75% accuracy on plots as small as five acres.

**Land use:** Land use planning is concerned with the development and management of land for purposes such as food, housing, urbanization, manufacturing, and transportation. An objective of planning is to match development and land use with population

tion, industrial uses, irrigation, power generation, and recreation.

About 90% of the fresh water resources of the earth consist of ground water stored in regional aquifers. LANDSAT images, underlaid with various sedimentary geological features, provide an excellent bases for mapping shallow aquifers. The data is used directly to determine their boundaries, recharge and discharge areas, and the location of springs.

Also, LANDSAT imagery is used for depicting crystalline rocks where water has been commonly found in openings along joints and fractures.

Finally, LANDSAT data serves as an

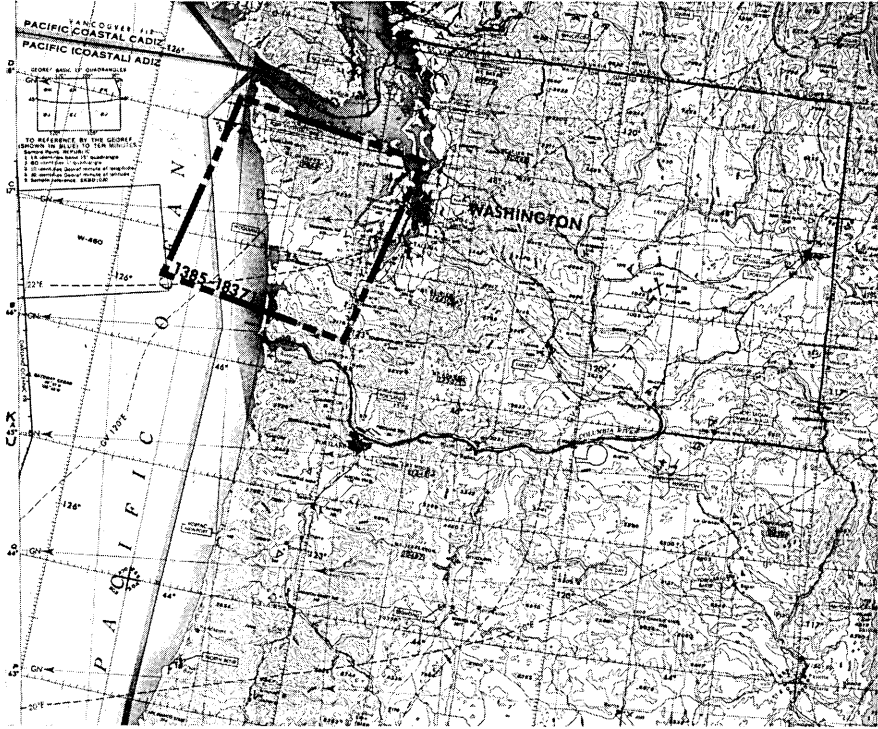

The Washington State area corresponding to the satellite image at right.

growth and natural conditions in order to provide adequate food and material supplies with a minimal negative impact on the environment. Although LANDSAT imagery is used for regional planning and development, it is not yet accurate enough for detailed planning, such as for urban development. Urban planners must still rely heavily on airborne and other small-scale land use inventories.

**Geology:** Although the information received from LANDSAT will rarely in itself lead to the location of mineral, oil, or gas resources, LANDSAT locates major geologic elements which generally serve as a guide to the selection of smaller targets.

**Hydrology:** A major goal of remote sensing for hydrological applications is to observe and measure water quality and quantity. This is highly dynamic, requiring repetitive observations to monitor changes. Data is used for allocating water resources for consump-

tion, industrial uses, irrigation, power generation, and recreation. exploration base to help determine the strategy for ground water prospecting by offering information on surface rocks, fracture patterns, and the vegetative and geomorphic indicators of shallow aquifers.

**Forest and rangeland management:** LANDSAT data is used to provide basic information on the extent and location of forest resources and the changes occurring within them. Sensor data has contributed to classification of timber types; sampling procedures for estimating timber value; monitoring of clear-cut forest cutting; mapping of forest fire burns; and calculation of timber volume.

One study undertaken by the State of Washington described an inventory of 4.05 million hectares (1.6 million acres) of forest land at a cost of approximately \$200,000. Using conventional methods, the same inventory would take two years to complete and cost ten times as much.

Forage or rangeland monitoring by LANDSAT has been used to recognize potential fire hazards, project the anticipated weight of livestock, and determine the extent to which drought and grazing reduced available forage. Fortunately, almost all types of range vegetation are easily differentiated with current LANDSAT sensors.

Still, results thus far have been mixed. Successful studies using satellite data to provide high quality range condition reporting or trend monitoring and forecasting are practically nonexistent.

*Marine sciences:* NASA's oceanography and marine resources program is

attempting to use remote sensing to manage marine resources within coastal zones, to help use oceans more effectively as transportation routes, and, in general, to contribute to the advancement of marine biology and oceanog-

### The satellite can even measure water depths down to 20 meters.

raphy. Satellite data is used to support applications in hydrography, currents and circulation, and fish studies.

Hydrography is concerned with the measurement of ocean properties in-

cluding physical, chemical, geometrical, and optical features of the coastal and open zones of the oceans. It concerns parameters such as ice movement, temperature, ocean surface topography, salinity and other chemical properties, marine life, land/sea interface characteristics, bathymetry (water depth), and water color. In areas of low or moderate turbidity, the satellite can even make depth measurements up to 20 meters, for updating the locations of reefs and shoals.

Knowledge of coastal currents is vital in coastal areas for planning by land use commissions and port authorities, for proper location of sewage effluents by

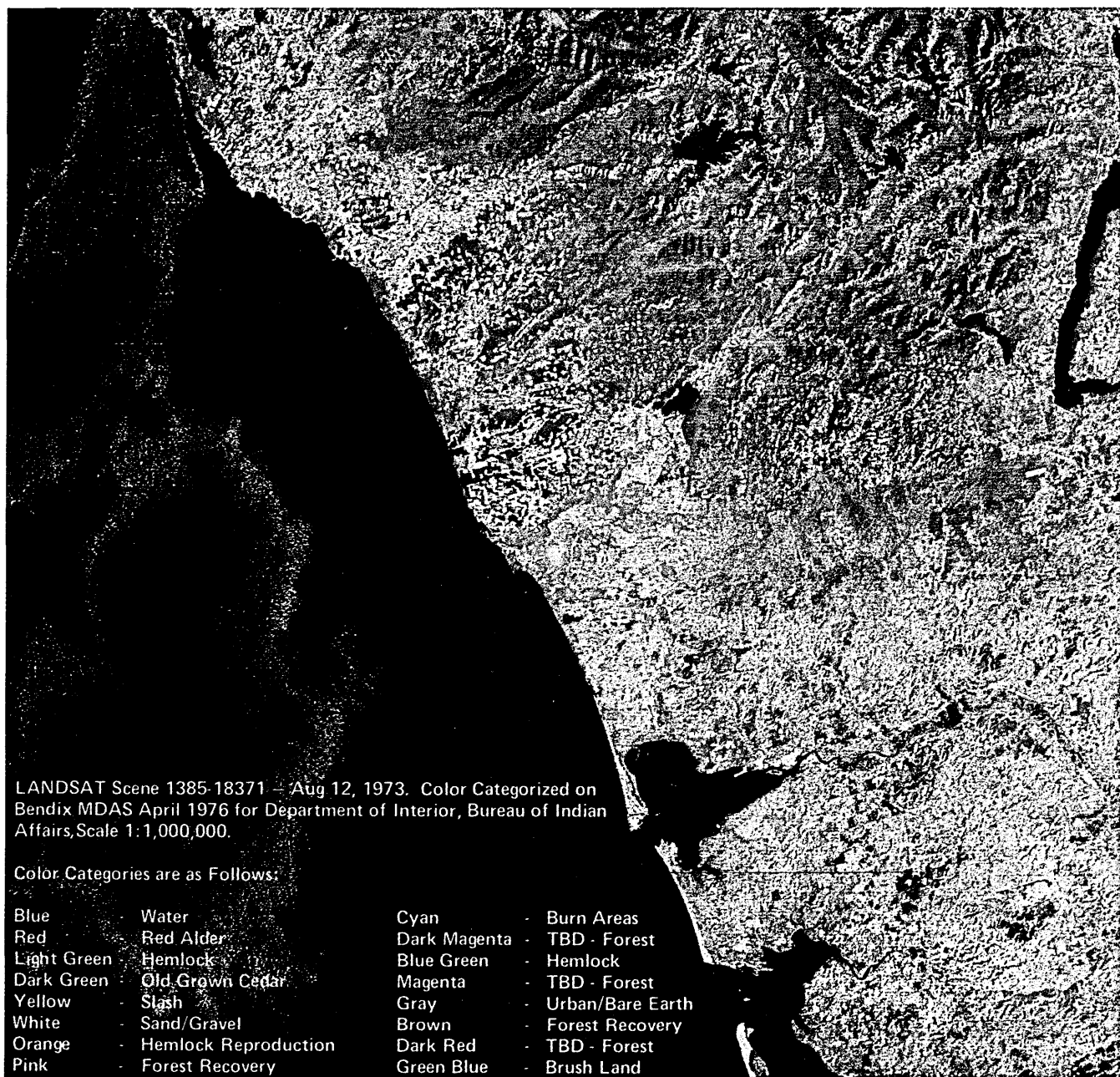

Bendix Aerospace Systems Div. produced the image above as part of a land use and forestry study of the Quinault Indian Reservation in Washington State. Satellite data for the area was collected using two bands of the visible spectrum and one band in the near infrared to produce a composite image of the scene.

Then, local consultants who were familiar with the area identified what was really on the ground for several small sections of the composite. A Bendix image processing system was used to correlate that "ground truth" with other areas of the scene, and to produce the false color image shown.

## SATELLITE DATA

sanitation districts, for management of sport and commercial fishing, and for studying marine ecological conditions. Here LANDSAT has proven its ability to portray sediment distribution and movement which in turn directly reflect the turbidity and flow direction of the water mass, especially near shores.

Turbidity and current measurement can also aid in locating and monitoring fish concentrations. Interfaces between water zones can be detected by surface manifestations and these zones are known to have significant concentrations of fish. Plankton concentrations are detectable by reflectance or turbidity observations as well. In general, however, food chain relationships are highly complex and it is difficult to draw any significant conclusions from the data available from LANDSAT or any remote sensing technology. There have been no operational successes to date in

this area of resource management.

**Cartography:** LANDSAT imagery has proven to be of immense value for small scale cartographic applications—especially in the production of planimetric base maps such as surveyors and engineers might use. Satellite data images have mapping errors of only 200 to 450 meters, which exceeds the U.S. National Map standards up to scales of 1:250,000. These can be digitally fitted

### IBM offers terminal time for processing satellite data . . . outside the U.S.

to an appropriate geodata grid, and thematic information from sources such as land use classifications can then be overlaid.

**Environmental quality:** This aspect of remote sensing concerns itself with questions related to the environmental impact of manmade developments, the

quality of life, and the determination of processes related to development and exploration which can be carried out with minimal adverse effects. LANDSAT helps in two ways: first, by providing a regional overview of the total environment in terms of land, water, and air as seen by parts of an integrated ecological system; and second, through providing a repetitive or seasonal look at areas of concern, to detect changes that can affect the environment.

The satellite data has been used to monitor conservation and reclamation efforts, strip mining impact, and other environmentally related activities.

LANDSAT can be used to measure suspended solids of chemical waste; for the detection of acid, iron wastes, and oil spills; for the determination of disposal patterns in turbid waters; for detection of large scale ocean dumping; and for monitoring lake eutrophication and algal blooms.

So far, the data has been used to help

Remote sensing is used for studying objects from great distances, including studying remote galaxies using optical and radio telescopes, and studying the earth using satellites and aircraft. In the case of the earth, the technology involves measuring the natural radiation, magnetic field, and signal reflectance of ground or water surfaces.

The "sensor" most often used for studying the earth is the aerial camera. However, conventional cameras are limited to studying visible light and some portions of the infrared spectrum, a rather small portion of the total electromagnetic spectrum. To expand the range of what can be studied, a wide variety of kinds of sensors have been developed. These are generally categorized into two different types: passive and active.

Passive sensors are those which pick up emitted radiation; active sensors provide their own signals and record the reflectance.

Much of the energy being sensed by passive sensors comes directly or indirectly from the sun. Some of the sun's radiated energy is immediately reflected by the earth; some is absorbed and later emitted in a pattern of wavelengths, or "signature," that is unique to the material doing the emitting. Both kinds are important to passive remote sensing.

Whereas photographic film has been the primary medium for capturing that reflected and emitted radiation, multispectral scanners are coming into increased use. These devices detect a relatively wide range of radiation—including visible light, infrared and heat

## What Is Remote Sensing?

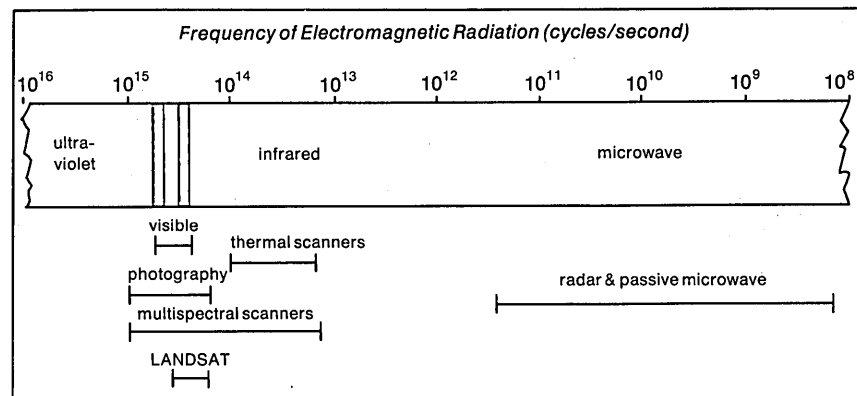

radiation, and sometimes ultra-violet—and generate electronic signals from which photograph-like images can be produced.

However, even multispectral scanners see only a portion of the total spectrum. Longer wavelength sensors, including those active systems using microwave and radar, further expand the range.

Sensors of all kinds have been carried aloft by balloons, conventional planes, high altitude reconnaissance aircraft, or satellites in order to obtain information on a scale appropriate to the particular problem under investigation. The use of satellites began in 1972 with the launching of LANDSAT I. That satellite and LANDSAT II both carry two kinds of sensors. The first is a return beam vidicon system consisting of a high resolution three-band, three-camera tv system. The second is a multispectral scanner consisting of an oscillating mirror and optics to deflect the radiation received onto an array of detectors; the particular detectors used in LANDSAT's I and II

are sensitive to wavelengths in four spectral bands in the visible and near-infrared regions. LANDSAT C, launched in March, added a fifth band in the far-infrared region.

Each portion of the electromagnetic spectrum has unique properties which allow for different kinds of investigation. For example, the infrared sensors detect and monitor heat pollution, volcanic activity, and geothermal activity. Microwave sensors, for another example, do not see visible or infrared radiation, but they can penetrate cloud cover and even light vegetation.

In the case of the LANDSAT's, all of the data from all of the sensors is continually transmitted to the ground, there to be recorded on ultrahigh-density magnetic tape. Then computer techniques come into play for removing sensor and geometric distortion, overlaying images, image enhancement, and for extracting information related to spectral, temporal, and spatial characteristics of the region observed. \*

determine the source and dispersion of smoke plumes, the influence of air pollution on climate and weather, for the detection of urban haze and atmospheric particles. It is particularly useful to determine the presence of invisible pollutants.

The primary advantage of satellite coverage is that the large area covered allows observation of the aerial extent of airborne pollutants and their effect on a regional scale.

### Processing the data

Extracting usable information from sensor data is a large and complex data processing problem. The multispectral scanner onboard the LANDSAT's, for example, employs 24 detectors which are sensitive to visible and infrared light, has a 9.95msec sampling interval, a 6-bit sample word length, 3,240 samples per scan line, and 2,340 scan lines per band. A four-band multispectral scanner thus generates more than  $3 \times 10^7$  bytes per picture.

This data is originally captured on ultrahigh-density magnetic tape (10,000bpi). It must be converted to computer compatible densities, corrected for a variety of sensor errors, overlaid with other scenes, enhanced, classified, and interpreted by manual, interactive, or automated methods. Only then can its spectral, temporal, and spatial characteristics be exploited.

The resulting work product is a picture of an area of the earth as seen from the satellite. Instead of being a photograph, however, the picture is composed of thousands of discrete picture elements, each of which is a tiny cell (pixel) with a discrete level of brightness (gray scale level). The number of picture elements and the brightness levels displayed are functions of the graphics display systems used to analyze the data.

Each picture cell transmitted from the satellite is assigned one of 64 values by the scanner. It is the vast number of pixels necessary for one picture from one band of the scanner, plus the sophisticated math done on each before it is displayed, which result in an extremely high computational load on the cpu. This, in turn, is leading to the adoption of array processors by most of the manufacturers of image processing systems.

An understanding of the processing involved comes most easily by walking through an example. Consider the large color picture on page 119. This was one of the products delivered to the Bureau of Indian Affairs by Bendix Aerospace Systems Div. as part of a forestry study in 1975.

The data for this image (remember, it is not a photograph, at least not in the usual sense) was collected by LANDSAT as it passed over the State of Washington on August 12, 1973. As it passed,

LANDSAT recorded data on a strip 100 nautical miles wide, using its multispectral scanner. Data was collected in four spectral bands: green wavelengths of 0.5 to 0.6 micrometers), red (0.6 to 0.7 micrometers), and two bands in the near infrared (0.7 to 0.8 and 0.8 to 1.1 micrometers).

The data was picked up by ground stations and relayed to the Goddard Space Flight Center, where it was converted into framed images covering an area of 100x100 nautical miles and translated to computer compatible tape format. From there the tapes went to Bendix, where enlarged false color composites using bands 4, 5, and 7 were prepared.

The images were then returned to the Bureau of Indian Affairs. There another contractor annotated representative areas of land use or vegetation categories using aerial photographs and personal knowledge of the sites. Those areas were typically more than 30 acres in size and relatively easy to locate in the LANDSAT data due to their close proximity to water bodies, clear cut

---

### Satellite analysis is being accepted as a pragmatic tool at a surprisingly rapid rate.

---

areas, roads, or other easily detectable ground features. Then the images went back to Bendix again, where the satellite data was geometrically corrected.

The geometric correction involves the use of ground control points, identifiable features like road intersections whose longitude and latitude are known. When the satellite image is displayed on a screen, the researcher can move the cursor to the identifiable feature in the image and key in the known longitude and latitude. The system uses the keyed data as a correction parameter. Given coordinate data for several points, it can generate an algorithm to transform the image into its true coordinates. The same algorithm may then be applied to other images—from other bands or from other satellite passes over the same piece of real estate.

The first step in the actual analysis of the image is similar, except that it involves a different kind of knowledge of the features on the ground. The analyst again moves the cursor over a given area of the display and then, instead of entering longitude and latitude data, enters some other code based on the ground truth—in the case of the Quinault reservation, a code based on the annotations made for land use or ground cover by the Bureau of Indian Affairs' contractor.

For this project, codes were assigned to categories such as kinds of trees,

water, gravel, etc., as is portrayed on the image on page 119. (Where ground truth data was not available, some are marked TBD for "to be determined.") The image processing system is then able to find other areas on the image which have the same characteristics, and assign the same code to them. Then, these category codes may be assigned new colors or gray scale values as desired, and new display data reproduced in graphic form or stored for even further processing.

The computer's role isn't over with the production of the image data and images. Other outputs will include tabulations of the amount of any one kind of timber in the area, for example, and maps showing only that category (overlaid on base maps with roads, etc.) Some of the output products are produced as listings, some as false color maps on a drum film recorder (again, as the image on page 119, but note that the text is added photographically), some as transparent overlays or transparencies.

### The systems available

The author, in conjunction with Business Automation Services International, Inc. of New York, recently conducted a study for the Algerian government on such specialized image processing systems that could handle LANDSAT data and data from airborne sensing systems. Included in the criteria for the systems were that they should:

- support current and future requirements as currently envisioned within the LANDSAT program
- support a multiuser environment without serious performance degradation
- support remote user stations through microwave or other long-line communications
- have extensive software and be backed by extensive training support
- support an archival data base management system
- be able to directly interface an IBM 370
- provide array processors for high throughput.

Six turnkey systems and one software system were compared. The hardware included International Imaging Systems' (I<sup>2</sup>S) System 101, CDC's Cyber-Ikon system, the Bendix Multispectral Data Analysis System, General Electric's DIPS system, Electro-Magnetic System Laboratory's IDIMS Image Processing System, and Comtol's Vision 1. The software reviewed was IBM's ER-MAN II.

Candidates were reviewed in terms of

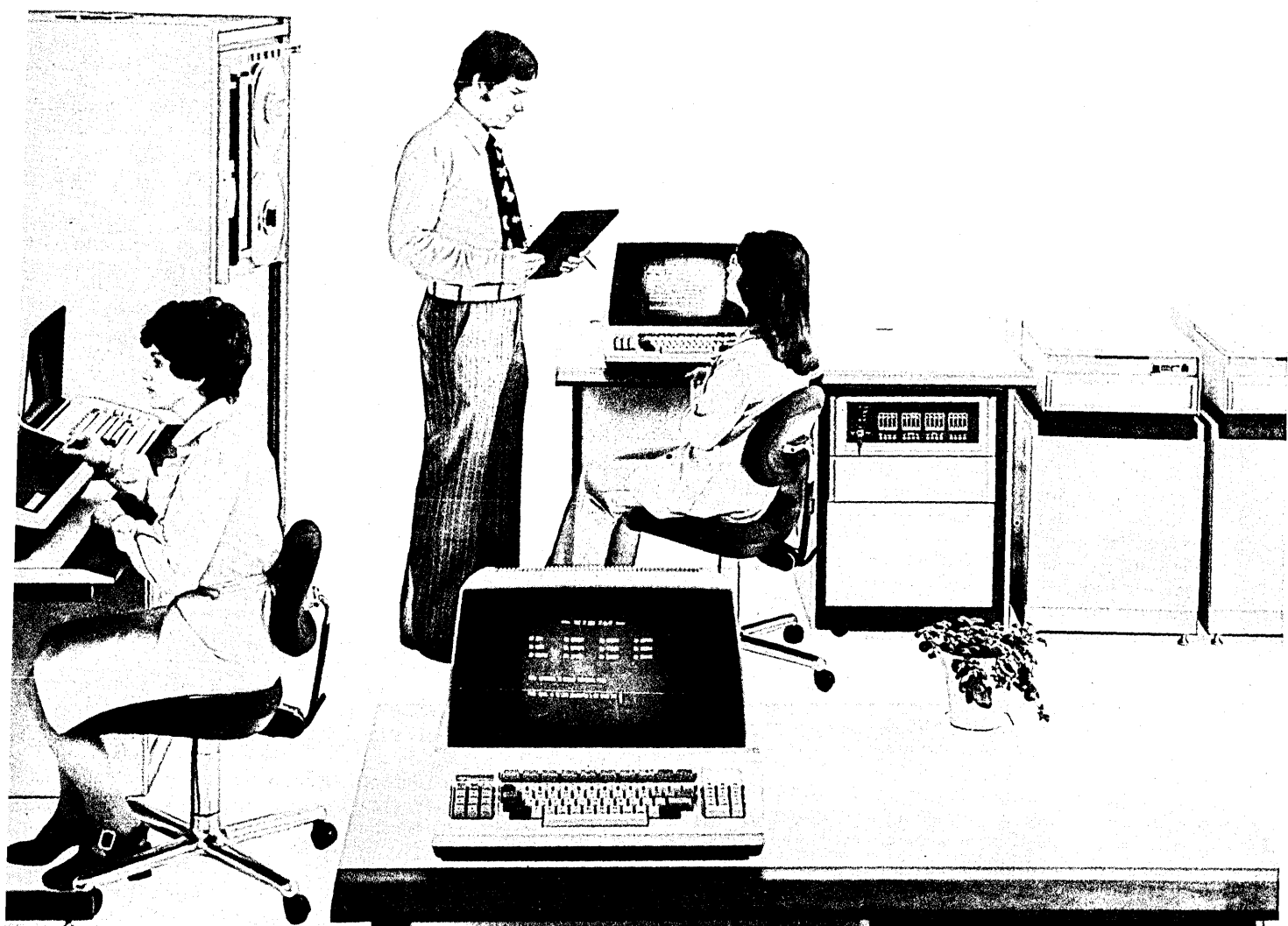



# Master of Business Administration.

## TI's DS990 Commercial System.

When we designed the DS990 disk-based commercial system, we made sure it could get down to business in a hurry.

Our computer system can apply itself to a wide range of commercial operations using your application software—general ledger, payroll, accounts receivable and payable, invoicing, order entry, inventory control, sales analysis and general accounting.

To make sure it would make light work of office workloads, as well as increase productivity, we combined the processing power of our Model 990/10 computer with our capable DX10 commercial operating system.

### Our well-educated DX10.

The brains behind our DS990 is our DX10 multitasking operating system, which supplies interactive computing power and prompting capabilities, while it supports multi-terminal applications and program development.

It is DX10 that provides perhaps the most extensive and versatile minicomputer job control tool available today—SCI, the System Command Interpreter, a collection of over 170 procedures that gives the DS990 a flexibility no other minicomputer on the market has.

DX10 speaks a choice of high-level commercial languages: COBOL, RPG-II, BASIC, Business BASIC, FORTRAN IV and PASCAL.

DX10 provides an extremely broad range of utilities, built-in supporting routines, custom system generation capabilities and four powerful interactive program development tools—text editor, macro assembler, link

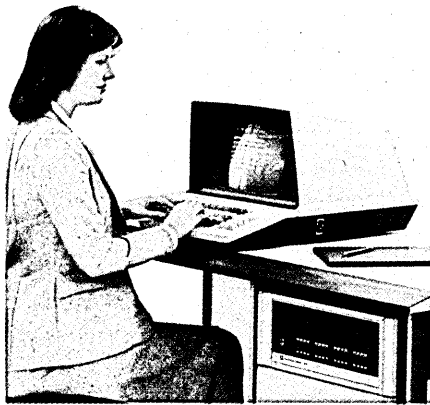

editor and symbolic debugging packages—all at no extra charge.

DX10 offers comprehensive file management—it supports sequential, relative record and multikey indexed files. When it is multikey indexing, it can automatically expand or contract the key lists, reducing the need to periodically rebuild and reorganize files.

And DX10 makes your operator's life and job easier—by utilizing its interactive video mode to guide the operator to required data step by step, minimizing the tedious and time-consuming chore of referring to operator manuals.

### We've done our homework.

Not all businesses require the same amount of business administration. So, we've packaged our DS990 in a choice of models.

The DS990 Model 4 includes a 990/10 computer with 128K bytes of error-correcting memory, a Model 911 video display terminal, one DS10 disk drive with 5 megabytes of fixed disk and 5 megabytes of removable disk pack storage.

When you're ready to store more information at your fingertips, we're ready for you: our DS990 Model 6 increases your disk pack capacity to 50 megabytes; our DS990 Model 8, to 100 megabytes.

Our DS990 comes as a completely packaged system, ready for your application software. Which means every unit is built, tested, shipped and installed as a system, so it can begin mastering your business administration in a hurry.

We've increased your productivity and throughput by including all four essential computing functions—memory management, program management, file management and high-level programming languages. We're offering more technology, along with over 30 years of experience in the electronics industry; the technical expertise and support of our worldwide organization of factory-trained sales and service engineers; TI-CARE\*, our computer-automated service dispatching and information system; and we offer it all for less money than competitive systems.

To see how we can put our master of business administration to work under your administration, and within your reach, call your nearest TI sales office, or write Texas Instruments Incorporated, Digital Systems Division, P. O. Box 1444, M/S 784, Houston, Texas 77001. Or call (512) 258-7305.



**TEXAS INSTRUMENTS**  
INCORPORATED

\*Service Mark of Texas Instruments  
Copyright © 1978, Texas Instruments Incorporated

# TEXAS INSTRUMENTS.

We put computing within everyone's reach.

# Typical Image Processing Systems

Manufacturer	Bendix	Comtal	Control Data	Electromagnetic System Laboratory
<b>Model highlights</b>	M-DAS	Vision I	Cyber-Ikon	IDIMS II
Number installed	4 installed	40 installed	New product	9 installed
Processor	DEC PDP-11/35 or 70	DEC LSI-11	Cyber 18/20	H-P 3000 II
Array processor?	Array processor avail	No array processor	Array processor avail	Array processor avail
Color monitor	320x240 or 512x512	512x512 or 1025x1024	640x525 display	512x512 display
Interactive terminals	Up to 4 terminals	One terminal (alphanumeric)	One color display	Up to 10 terminals
<b>Hardware</b>				
Memory	28K to 1MB memory	16K words	292K (16-bit) words	128K words memory
Recommended disc	1.2M words (batch DOS)	No disc (ROM)	Two 50MB disc	300MB disc
Standard mag tape	Two @ 800bpi or 1600bpi	Two @ 800bpi or 1600bpi	Two @ 800bpi or 1600bpi	Two @ 800bpi
Support 10,000bpi tape? (min.)	Supports ultrahigh density	No ultrahigh density support	Supports ultrahigh density	No ultrahigh density support
Film input?	Film input supported	Film input supported	Film input supported	Film input supported
Film output?	Film output supported	Film output supported	Film output supported	Film output supported
<b>Software</b>				
Basic support level	Medium level support	Low level support	Medium level support	High level support
Data base manager	In-house dbms avail	No dbms	No dbms	File manager for each user
<b>Processing</b>				
Simultaneous processing	16 bands (software)	3 bands (software)	4 bands (hardware)	Any number (software)
Simultaneous display	16 bands displayed	8 bands displayed	16 bands displayed	Any number displayed
Simultaneous search on:	49 parameters	4 parameters	256 parameters	180 parameters
IBM 370 interface	Medium utilization	Medium utilization	370 interface available	Standard 370 interface
<b>Strengths</b>	Accepts airborne data Good support/training Good cost/performance	Highly interactive High quality image Low cost	Very high throughput Good growth potential Video overlay Programmable terminal	Good flexibility Good growth potential Good dbms support
<b>Weaknesses</b>	Relatively slow Low growth potential	No growth potential Limited software	Limited software Unproven in field	Military orientation
<b>Basic turnkey price</b>	\$300,000-\$750,000	\$100,000-\$215,000	Approx. \$1.3 million	\$225,000-\$750,000

Manufacturer	General Electric	IBM	International Imaging Systems
<b>Model highlights</b>	DIPS	ER-MAN II	System 101
Number installed	11 installed	4 installed	3 installed
Processor	DEC PDP-11/35 or 70	IBM 370	H-P 3000 II
Array processor?	Array processor avail	Array proc to be avail	Array processor avail
Color monitor	512x512 display	512x512 display	512x512 display
Interactive terminals	Up to four terminals	One terminal	Up to 17 terminals
<b>Hardware</b>			
Memory	256K words memory	350KB memory	256KB memory
Recommended disc	Two @ 85M words	30MB disc	50MB disc
Standard mag tape	Two @ 800bpi or 1600bpi	1 to 4 mag tapes	Two @ 1600bpi
Support 10,000bpi tape? (min.)	Supports ultrahigh density	No ultrahigh density support	Supports ultrahigh density
Film input?	Film input supported	Video input only	Film input supported
Film output?	Film output supported	Film output supported	Film output supported
<b>Software</b>			
Basic support level	High Level support	High level support	High level support
Data base manager	No dbms	IBM 3850 interface	File manager for each user
<b>Processing</b>			
Simultaneous processing	5 bands (hard)/ 16 (soft)	Any number bands (software)	19 bands (hard)/ 36 (soft)
Simultaneous display	5 bands + 1 video	30 bands displayed	14 bands displayed
Simultaneous search on:	8 parameters	60 parameters	64 parameters
IBM 370 interface	Medium utilization	Runs on 370	Medium utilization
<b>Strengths</b>	Extensive software Large user group Video overlay Good support/training	Low software cost Good software library	Programmable terminal Extensive software Video overlay Good growth potential
<b>Weaknesses</b>	Limited bands Relatively slow Expensive	No support non-IBM hard Used only by IBM to date	Small company
<b>Basic turnkey price</b>	\$350,000-\$4 million	\$55,200 (software only)	\$275,000-\$750,000

Table 1. These systems are not intended to be comparable. Nor do they well reflect the breadth of these manufacturer's lines. The information presented was collected by the author for a study commissioned by the Algerian government, as mentioned

in the text. Even the prices reflect that application. The purpose here is to show the wide range of products available for processing satellite data.



# The Outer Limits of Distributed Data Processing.

MSI's portable terminals extend data's point of entry far beyond your perimeter of stationary workstations. Even in the most sophisticated distributed networks, source data is still being manually transcribed at the source and then physically carried to the operator of a key-entry installation. Using MSI's portable terminals, the data can be entered at the source by the people who are already working there.

Meeting the challenge of increasingly more complex data handling jobs and ever-larger data volumes, MSI's new family of portable terminals provide a broad range of functional capabilities: 4K to 48K words of CMOS segmentable memory, both key entry and optical wand scanning of various numerical bar codes, throwaway-batteries, asynchronous communications, and both LED and LCD displays. And because MSI's terminals are user-programmable, each terminal can be parameterized to suit its particular application and its working environment at the outermost reaches of source data entry.

*For further information please write to  
William B. Patton, Vice President-Marketing.*

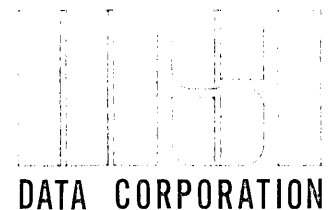

**THE LEADER IN PORTABLE DATA TERMINALS**  
340 Fischer Avenue, Costa Mesa, CA 92627 (714) 549-6000

Atlanta (404) 691-7207 • Boston (617) 848-6450 • Charlotte (704) 525-2130 • Chicago (312) 392-8300 • Dallas (214) 270-6535 • Denver (303) 750-3333 • Detroit (313) 642-1970 • Honolulu (808) 955-1195  
Houston (713) 664-4244 • Los Angeles (213) 692-0674 • (714) 522-0914 • Memphis (901) 795-1230 • Milwaukee (414) 251-1774 • Minneapolis (612) 941-4030 • Greater New York (201) 567-3790 • Ohio (216) 486-1500 • Orlando (305) 834-5336  
Philadelphia (609) 779-8940 • Pittsburgh (412) 941-8020 • St. Louis (314) 291-3080 • San Francisco (415) 944-0550 • Seattle (206) 575-3115 • Toronto (416) 638-0034 • Vancouver (604) 906-1911 • Washington D.C. (703) 560-5400  
Caracas, Venezuela 781-8888 • Eindhoven, Netherlands 040-433584/TELEX 51168 • Johannesburg, South Africa 786-2280/TELEX 8-3362  
London, United Kingdom 0628-33121/TELEX 851-847-889 • Melbourne, Australia (03) 211-1022/TELEX AA31604 • Milan, Italy 02-879246 • Karlsruhe, West Germany (49-701) 386735  
Oslo, Norway 01/204030/TELEX 19419 • Paris, France 686-5412/TELEX 84-742-01 • Tokyo, Japan 03 (543) 7611/TELEX (L.A.) 67-4436

CIRCLE 133 ON READER CARD

# SIEMENS

## Laser Printer ND-2. 21,000 lines per minute. Fast is not the word for it. Fastest is.

### Speed plus practicality.

The ND-2 was designed to print 21,000 lines per minute (that's 8,000 12-inch printouts per hour). But speed isn't everything. You also need practicality. Plain paper printing stock. User changeable printing drum... and then only after 3 million perfect copies.

### One good benefit deserves another. And another.... and...

The ND-2 Laser Printer duplicates, masks out at different positions in the copies, prints with variable fonts and also different character sizes and spacings within the same line, and gives you the choice of three line spacings. The ND-2 also utilizes a forms overlay feature, thus eliminating the need for preprinted forms. Even at top operating speed, the character quality is suitable for OCR applications.

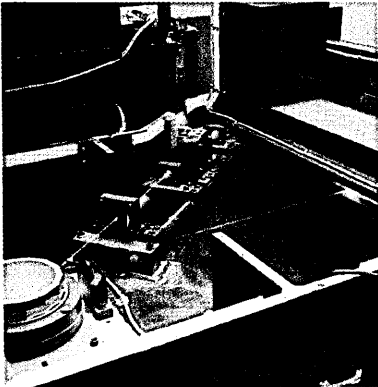

Fastest is not the only word to describe the Siemens ND-2 Laser Printer. Easy... maintenance free... reliable... and silent... are others. **Siemens Impact on Non-Impact Printing Technology.**

Siemens research and development efforts in printing technology not only created the ND-2 Laser Printer, but has produced the first truly practical low-cost ink-jet terminal printer in the industry. **Ink-Jet Printing. Fast and Silent.**

In seeking to design the ideal printer, we sought more than simple speed and economy. We also concentrated on human engineering. A reduction in noise levels. And we succeeded in all three areas. The Siemens-developed Ink-Jet Printing mechanism works on the vacuum principle and attains a top printing speed of 270 incredibly quiet characters per second on untreated paper in a script that is highly legible, smear proof, and indelible.

All you hear is the rustle of paper. And you **never** have to replace the Print Head.

To prove these points to yourself and know more about the strengths of Siemens and their family of Computer Peripherals, contact us at:

**Siemens Corporation**  
OEM Division, 1440 Allec Street  
Anaheim, California 92805  
(714) 991-9700



## Responsive products from a responsible company.





## SATELLITE DATA

hardware and software characteristics and cost. Selection criteria included modularity (growth potential, relative immunity from obsolescence), flexibility (capability to support a wide variety of data input), minimal overall cost (initial investment, maintenance, growth, training) and software availability (initial provision of software, ease of program revision, maintenance and development). The systems reviewed (see Table 1, p. 124) are not intended to be directly comparable. Nor do they well represent the breadth of the product lines of the manufacturers involved. However, they do suggest the wide range of products available for this application.

### Services available

An increasing number of public and private companies are offering LANDSAT-related user services. Services usually consist either of offering the raw imagery in machine readable form or, more commonly, offering digitally enhanced images. Service bureaus, in some cases, also offer sophisticated computer models as analysis aids.

The imagery itself may be obtained from the Earth Resources Observation System (EROS) Data Center in Sioux Falls, South Dakota, which is operated by the Department of the Interior. EROS offers either raw imagery or radio-

---

### LANDSAT D will produce 10 times as much data—so everyone must upgrade.

---

metrically and geometrically corrected imagery as standard products, but will usually not perform data classification and analysis of the data. The EROS Center did about \$3 million worth of business last year, not including purchases made directly by NASA. About 33% of that was done with foreign governments, 20% with U.S. federal government, another 20% with U.S. industry, 13% with U.S. academic institutions, and 15% with private individuals. Of foreign sales, most of the imagery is finding its way to the Middle Eastern countries, particularly Iran. In fact, what processing is performed at EROS is primarily related to petroleum and mineral exploration, followed by forestry-related uses.

The three major commercial service firms offering general consulting, data enhancement, and interpretation services related to LANDSAT are the Earth Satellite Corp., IBM, and GE.

*Earth Satellite Corp.:* Earthsat is an eight-year-old company that has done approximately \$22 million in sales with 23 U.S. government agencies, 23 state governments, 56 private companies, 24

foreign governments, and some multinational groups including the Organization of American States, the United Nations, and the World Bank. It now does about \$2 million in business per year.

Two years ago, about 50% was R&D work and 50% operationally oriented. But there's been a change. Approximately 95% of the business now is operational and only 5% R&D.

The obvious conclusion of these figures is that satellite technology is gaining acceptance as a pragmatic tool at a surprisingly rapid rate. Major applications of Earthsat include oil and mineral exploration, followed by crop production predictions using a computer model with data derived from LANDSAT and meteorological satellites.

*IBM:* IBM has been working in LANDSAT analysis for two years. An integrated set of software routines, originally developed for the NASA-Johnson Space Center, has been installed in scientific centers in Madrid, Spain, and in Mexico City. Individual projects have been established with government agencies of these and other countries to address specific problems—primarily in the areas of geology, crop inventory, and land use analysis.

IBM currently offers terminal time for sale on an hourly basis to customers at their data centers outside the U.S., but under its CDC settlement cannot yet make those facilities available domestically.

*General Electric:* GE has performed digital image analysis services for the public since 1974. Principal applications include geology, land use and urban planning, hydrology, agriculture, and forestry. The company manufactures its own turnkey Image 100 system which it has extended for service bureau work. Customers are said to be increasingly concerned with semioperational analyses rather than exploratory or research work. Interactive image analysis is supplemented increasingly with automatic image data processing of increasingly larger geographic areas of interest. The shift in GE's customer base has been from mainly federal government to a combination of federal government, regional/state/local government, private sector, and international customers.

There is also growth in the firm's digital image enhancement and enhanced image products as opposed to simple classification of features in a scene—particularly for geologists and mineral prospectors. Like IBM's, GE's customer data base often includes LANDSAT data supplemented with digital image data from other sources.

### The 1980s

Technical innovation in the development of satellite technology will have a profound influence on applications. For

example, orbital lifetimes of satellites have gone from three to seven to ten years. This is actually considered a *disadvantage* by some users because of the expected advances in satellite technology, making cost effective design optimal only over a relatively short life span.

Individuals geographically isolated by mountains and water will receive direct television broadcasts from satellites. There will also be numerous additional tv channels; the number is currently limited by spectrum congestion. Another satellite, the Nav Star global positioning system sponsored by the Department of Defense, will provide high accuracy position fixing for international navigation, aviation, and maritime systems.

But perhaps more importantly, the major benefit of emerging satellite technology will be for the location of new natural resources, especially petroleum and mineral resources. The two multispectral scanners located on-board LANDSAT's I and II, which have already recorded over 450,000 scenes of the world's land areas, are fairly limited compared to the spectral ranges of the new sensors launched recently on LANDSAT C and to be launched on LANDSAT D within the next few years.

Plans for the next five years alone include the following:

*Space shuttle:* The major NASA program to date is the Space Shuttle, which will provide space transportation for the

---

### A 1979 Space Shuttle mission will carry aloft microwave sensors.

---

next two decades. The orbiter vehicle is designed to work in space and then land as an aircraft; therefore, it can be recycled. NASA estimates that there will be between 30 and 50 missions a year performed with the shuttle. Experiments may either be mounted in a 18.3 meter by 4.6 meter cargo bay where crew members can access instruments, or be carried into space and left there. One shuttle flight, slated for 1979, will carry passive and active microwave sensors to provide high resolution soil moisture data.

*Thematic mapper:* LANDSAT D, scheduled for a 1981 launching by the space shuttle, will monitor either six or seven multispectral channels, and provide six times the resolution of either LANDSAT I or II. The thematic mapper (a second generation multispectral scanner), will differentiate and record 250 levels of radiation intensity (gray levels) compared with the existing 64 levels, and will provide higher color sensitivity, increased infrared channel capability, and higher geometric and radiometric registration capabilities. The greatest benefit of the mapper, which will have 30 meter

# Consider Cincom

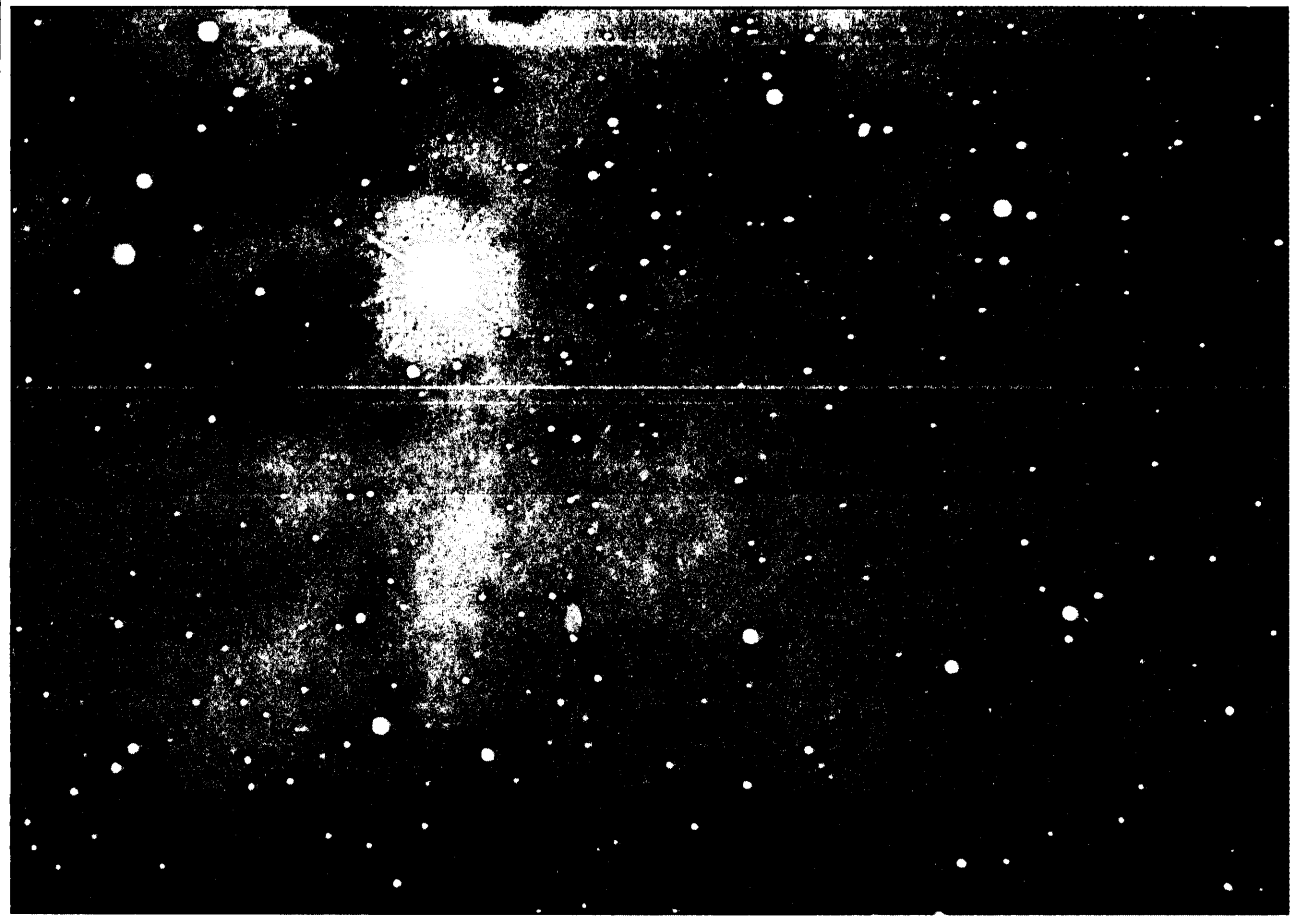

## We provide data base and on-line software designed specifically for the needs of the '80's.

The new TOTAL and ENVIRON/1 Series '80' data base/data communication systems are more than the most advanced DB/DC Technology available today. They are also the beginning of the future in information system software for the '80's.

Conceived and developed after a decade of experience in over 2,000 customer DB/DC environments, TOTAL and ENVIRON/1 Series '80', plus a variety of related software products...such as the new T-ASK query facility...are directed toward the information system challenges of the '80's. They will form the nucleus and launch pad for the many end-user oriented soft-

ware tools emanating from Cincom's substantial research and development commitment.

If you consider this type of product development commitment...coupled with a worldwide service support organization in 42 cities, in 11 different countries, on every continent...except Antarctica...to be important to your DB/DC success, shouldn't you consider Cincom?

U.S.A. 2300 Montana Avenue Cincinnati, Ohio 45211  
(513) 662-2300

International 17-17 Rue Montoyer 1040 Brussels, Belgium  
(02) 511-65-48

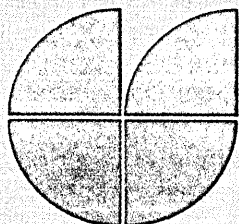

**Cincom Systems, Inc.**  
The TOTAL Information Systems People.

# Sperry Univac minis are doing

In Portland, Oregon, Sperry Univac minis help the Police Bureau come to the rescue hundreds of times a day.

Beaverton Police Computer Services has installed a full array of minis for emergency response, criminal justice, records, training, and other police functions.

For instance, the Beaverton Police Bureau has installed a full array of minis for emergency response, criminal justice, records, training, and other police functions. The minis are used for a variety of purposes, including:

• **Emergency Response:** The minis are used to process emergency calls and dispatch police officers. This helps the police respond more quickly to emergencies.

stantly updated. Much of the paperwork required of field officers is eliminated. And the data base it generates is used for uniform crime reporting and resource allocation.

Beaverton Computer Services has found that our minis are most effective and efficient when used in conjunction with real time, on-line data processing. This means that the data is always up-to-date and available to all users. One and all of them are supported by the great software.

If you have a system application, we can immediately show you how to use it for it. Whether it be business data processing



## alarming things in Portland.

ing, scientific, instrument control, or data communications.

For more information, write to us at Sperry Univac Mini-Computer Operations, 2722 Michelson Drive, Irvine, California 92713. Or call (714) 833-2400.

In Europe, write Headquarters, Mini-Computer Operations, London NW10 8LS, England.

We'd like to hear from you. Even if your system application isn't as arresting as the one in Portland.

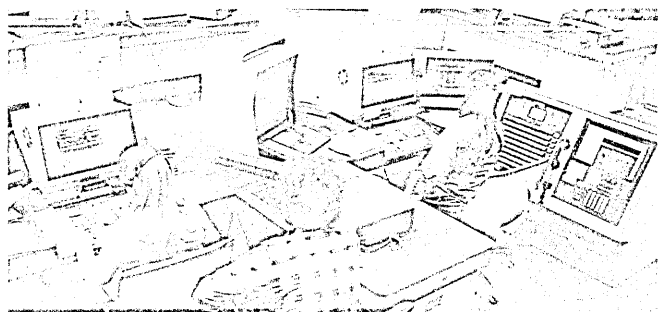

**SPERRY + UNIVAC**  
SPERRY UNIVAC IS A DIVISION OF  
SPERRY RAND CORPORATION

## SATELLITE DATA

resolution, will be for urban area data analysis and other applications needing high resolution.

**MAGSAT:** The MAGSAT mission, to be launched in 1979, will measure magnetic fields to identify major anomalies of the earth's crust. The primary objectives of the mission will be to update magnetic charts and to explore for resources with scalar and vector magnetometers.

**Large format cameras:** An early shuttle mission will carry a high resolution stereo camera system with the camera itself having a 12-inch focal length and using 9x18 inch film. It will have 15-meter resolution and be used for black and white, color, or color infrared photographs of sufficiently high resolution to make new topographic and cartographic applications possible.

**GEOSAT:** GEOSAT started as a private ad hoc committee set up in 1976 by 100 geologically based companies to work with NASA on a variety of projects. The industry-sponsored committee has made several recommendations to NASA primarily to promote the use of remote sensing technologies for locating oil and gas, geothermal, and mineral resources, and also for engineering and environmental geology. Recommendations of the GEOSAT committee include the STEREOSAT and SEASAT missions (described below) as well as a program to provide stereoscopic coverage and improvements in ground resolution by means of a camera that would be carried by the space shuttle system.

GEOSAT is also recommending the use of synthetic aperture (side-looking) radar to provide geologists with topographic and geomorphic information where continuous coverage is difficult to obtain using other types of sensors. This technology was proven in the mapping of the Amazon River Basin in Brazil.

Finally, the GEOSAT group is working with NASA on expanding the LACIE Large Area Crop Inventory Program from identification and forecasting of wheat to other crops as well.

The GEOSAT program is significant in that it represents the first time that information which was previously considered proprietary will be supplied to outsiders by commercial mineral and petroleum companies.

**STEREOSAT:** This mission will utilize dual telescopes and sensors to provide high resolution black and white three-dimensional stereoscopic imagery in digital form. Although the mission is not planned to be of sufficient resolution to determine cartographic relief, stereoscopic imagery will delineate linear features and characteristics of low relief areas which will, in turn, permit interpretation and measurement of ter-

rain and slope, primarily for purposes of petroleum exploration.

**SEASAT:** This is an all weather day/night ocean monitoring satellite launched by an Atlas booster on an 800 kilometer near-polar orbit on May 18 of this year. According to NASA, this satellite will probably be a precursor to a system of several microwave sensors probing the seas at numerous frequencies. SEASAT will be able to detect ships intruding in the 200 mile offshore limit, even in unfavorable weather conditions, will warn ships of approaching storms, and will be able to detect stress in Arctic ice floes. Its sensors will be used to improve weather forecasting by providing data on sea temperatures, wave spectra, and surface wind speeds. NASA has estimated potential industry

---

### SEASAT will detect ships intruding in the 200 mile offshore limit.

---

savings of up to \$2 billion between 1985 and the year 2000. SEASAT's sensors include a short pulse radar altimeter, a wind field scatterometer, an experimental synthetic aperture (side-looking) radar system, and a passive microwave radiometer.

**Heat capacity map mission:** The HCMM mission (scheduled for late this year) is one of NASA's application explorer missions whose purpose will be to pass over local areas of interest at both the hottest and coldest times of the day to obtain data on the heat capacity of the terrain and to measure soil moisture content and thermal effluents. The satellite sensors, having only a 500 meter resolution, will also determine the heat capacity for various rock types.

#### A few roadblocks

The development of these technical capabilities is not without its problems and open questions. Several government agencies are currently debating priorities and many problems of integrating existing and future technology have not yet been solved. For example, NASA has not yet funded the launching of LANDSAT D because of the added cost to a program which is currently estimated at over \$300 million. NASA maintains that existing users should pay for these capabilities. This raises the question as to the role of the U.S. in maintaining, and further developing, this valuable international resource for developing countries.

Also, the U.S. Geological Survey maintains that the LANDSAT D thematic mapper does not satisfy current data user needs and that the planned lower altitude of the satellite will increase resolution but result in gaps between flight paths. Data continuity will simply be destroyed. This in turn raises addi-

tional questions related to the role of research versus the operational potentials of continuous satellite coverage.

Then there is the question of the compatibility between the resolution of the thematic mapper data and existing multispectral scanners. Most of the existing image processing systems are simply not equipped to handle the additional channel capacity or the vast amounts of new data that will be generated from LANDSAT D—up to ten times the current data levels. This data rate will result in the need to upgrade receiving stations (at an extremely high cost) and will result in an image processing cost of over \$1,000 per frame. Some compromise between the USGS and NASA must be reached if existing users and data collection systems can be employed when LANDSAT D is launched.

The first years of satellite coverage of the earth have seen sensor systems progress from largely R&D applications to a transitional period where several cost beneficial applications of satellite technology have been proven but are not yet readily accepted by the potential user community. However, private industry has not yet taken an active role in marketing the technology, and the government has not yet committed itself to making satellite remote sensing an active operational program. Fortunately, it appears that President Carter will favor satellite remote sensing applications, and therefore encourage their transition to operational programs.

The experiments to date have proved their value. Cost effective hardware and software is already available. In short, the technology will be ready when we are. \*

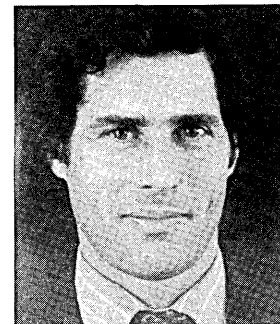

Mr. Teicholz is the associate director of Harvard Univ.'s Laboratory for Computer Graphics and Spatial Analysis. He also teaches in the university's Graduate School of Design. The author of a specialized report entitled *Computer Cartography: Worldwide Technology and Markets* (International Technology Marketing, Newton, Mass., 1976), he has directed projects involving the use of computer graphic technology in Algeria, the Philippines, Iran, Venezuela, and the U.S.



# "I can give you ten reasons why our OMEGA 480 is the better business decision."



Donald E. Roepke, Group Vice President  
Peripheral Systems, Control Data Corporation

"First of all, there's the *price*. Our OMEGA 480-1 has greater *throughput* than a 370/138—yet it costs about the same. And our 480-11 exceeds 370/148 performance but costs substantially less!

"And an OMEGA 480 system requires about one quarter the *power* and one half the *floor space* of the comparable 370.

"Of course we designed it to be *field-upgradable*. That means you can start with the smaller OMEGA 480-1 now, and upgrade to the larger processor when your needs require the higher performance.

"And there's software. OMEGA 480 supports, without modification, most IBM operating systems, program products and user programs.

"Financing can be important, too. Several attractive options are available through our *Installment Sales Plan* or from a selection of 3- to 7-year *leases*.

"But most importantly is the *service, experience* and *support* you want. You

get it from Control Data. Our support organizations have more than 8,000 dedicated hardware and software specialists—including many with years of IBM system experience.

"That experience comes from servicing more than 1,400 current IBM users, and maintaining such Control Data plug-compatible peripherals as Disk, Tape, Memory, Printer and Mass Storage Systems.

"Why not decide for yourself whether the OMEGA 480 is the better business decision for you. Call 612/853-7600. Or contact your local Control Data representative. Tell him Don Roepke sent you."

 CONTROL DATA  
CORPORATION

**More than a computer company**

CIRCLE 100 ON READER CARD

# The Expanding Realm of Computer Cartography

by Geoffrey H. Dutton and William G. Nisen

The emphasis in information processing in the 1960s was on hardware, in the 1970s on software. In the 1980s it will be on data bases, and computer cartography will emerge as a superior tool in accessing and interpreting their contents.

A United States government agency wanted to determine the best site in the country for locating a solar energy research facility.

Public health researchers at a major university needed to examine the potential correlation between geographic location and the incidence of cancer.

The market research division of a national manufacturer wanted to know where it ought to locate production facilities in the 1980s based upon a detailed projection of supply and demand. The staff also needed to be able to communicate their recommendations to senior management.

A common solution in each of these situations was the use of computer generated maps to reduce voluminous amounts of data into easily interpretable formats.

Only recently has private industry, with a few exceptions, developed an appreciation for what computer maps can do for marketing, plant siting, and resource exploration and inventory. Though many firms moved quickly to automate personnel files, accounting data, and sales statistics in the '50s and '60s, computer map representation of information was consistently ignored throughout the business world.

It may well be, though, that business was better off ignoring computer mapping, at least until recently. Effective programs for producing maps have been available since the mid-'60s, but earlier ones were troublesome to install, cumbersome to use, and required novel forms of data which were difficult to acquire or frustrating to produce. Only within the last five years have mapping data bases and software become ubiquitous and sophisticated enough to begin to fulfill the potential of computer cartography.

## What is computer cartography?

Computer cartography is a relatively new science, developed within the last 25 years and just beginning to be recognized as an effective tool in information management. Its origins can be traced to forward-looking geographers and city planners who realized that the computer, even in its infancy, could alleviate the onerous task of mapping vast quantities of spatial data.

Today, computer cartography is called upon as a means to analyze and interpret information for all types of applications. These applications are usually accompanied by voluminous data sets which possess either an implied or explicit spatial perspective. But before an examination of specific applications is undertaken, we should answer the question of why use a computer to produce a map if man has been making maps for thousands of years.

Conventional cartography is a mixture of art and science, with a heavy emphasis on art. As such, the production of an individual map is a fairly time consuming process. Consequently, as analytical tools, maps have been regarded as an end and not as a means. However, in the 1960s when maps began to be viewed as dynamic models, a need arose for rapidly produced maps that could accurately portray immense amounts of information.

Computer generated maps take advantage of a computer's unique capability to manipulate large volumes of data and produce graphic displays. The resulting maps contain graphic patterns which man is able to interpret and give meaning to. Thus, computer mapping is an example of a highly symbiotic relationship between man and machine.

## The data requirement

Computer cartography, like many other computer applications, needs voluminous data; however, its appetite has proved somewhat more voracious than most, usually requiring not one data base but two.

The need for two data bases stems from a map's capability for illustrating both the status of a theme or subject, and also its spatial properties, that is, location. Consequently, the first step in the production of a computer map is the development or use of an already existing cartographic data base. The cartographic data base contains, at a minimum, x-y coordinates that describe the shape of the study area and any sub-areas, such as the United States by states.

It is important to note that numerous such geographic data bases currently exist. Probably the most widely used are the Census Bureau's DIME (Dual Inde-

pendent Map Encoding) files. These contain spatial data on a variety of levels, such as by census tract and county. Other readily available cartographic data bases are: the World Data Bank's I and II which define international boundaries; the Urban Atlas Files which define census tract outlines within metropolitan areas (see Fig. 1); and numerous others of our own at Harvard's Laboratory for Computer Graphics and Spatial Analysis.

The second type of data base needed for a successful computer mapping endeavor is the conventional thematic or statistical data base. These are much like any other data base except that they are keyed to territories in some way. Good examples of this type would be U.S. census of population and housing data, or a firm's total sales by territory.

While the two types of data bases needed for the construction of a computer map have been treated as independent entities, they also may coexist in a merged file. Recently, the term "geographic base file" has been coined to describe this type of file.

Before discussing what happens to that data, it's important to categorize the computer mapping process into its three components: data capture, data processing, and information display. Note that data and information are not used synonymously. Data, in this context, refers to the largest set of facts that have not been condensed and are thus of little use to an analyst or decision maker. Information, on the other hand, is a subset of the larger data set and is composed of facts relevant to the present issue or problem.

## Capturing the data

The spatial data collection component of the mapping process is usually the most time consuming of all computer mapping tasks. To assist computer cartographers a variety of digitizers and scanners have been developed. The main function of both devices is to digitally record coordinate information from a variety of sources, such as maps and photographs.

The most predominant type of digitizer is the manual version which requires that an operator move a tracking head or cursor to a specific point on

a map or photograph and record the coordinates of that point. Many manufacturers, such as Talos, Summagraphics, and Numonics, offer a variety of models ranging in price from \$3,000 to \$15,000. The pricing differential reflects increased capability with respect to accuracy, resolution, and repeatability.

Numerous advances have been made in manually oriented digitizer technology, the most recent and important being the integration of microcomputers to transform, verify, and edit coordinate information. This advancement has spurred new interest in performing all digitizing activities in an off-line configuration, usually recording onto either cassettes or floppy discs.

Data capture through the use of manual digitizers, even with microprocessors, still remains a heavily labor intensive process. It usually accounts for a large portion of allocated funding for most computer mapping applications. However, an alternative is available. This alternative incorporates the use of scanning apparatus to perceive and record the coordinate information.

Using scanning, human intervention is kept to a minimum but there are still some major obstacles to be overcome. First, there is a high capitalization cost. The price for a scanning digitizer is currently in the \$200,000 to \$500,000 range. In addition, vast amounts of data are generated which necessitate line generalization or filtering to reduce the redundancy in the coordinate information and to convert the data into a vector format.

Still, cartographic data base creation remains one of the largest hurdles in the making of a computer map. In the 1960s the most significant expenditures were for hardware, and during the 1970s for software. But by the 1980s, the most significant expenditures will be for data bases.

### Processing it

Once the data bases have been acquired or constructed, some of the data manipulations that may be performed include editing, sorting, transformation, scaling, rotating, packing, and filtering. Often arithmetical operations,

such as area calculations, and statistical analyses accompany the map making process. Those various supporting computations demand fast cpu's and, until recently, very large memories; but large memory capacity is no longer a prerequisite due to advances in the optimization of cartographic data structures.

The equipment for *production* mapping includes:

- a cpu fast enough to handle sometimes voluminous amounts of data
- random access storage devices to allow rapid access to large data bases
- tape drives for archival storage and to facilitate off-line plotting
- appropriate terminals for data display and editing—storage crt's for vector oriented graphics and refresh crt's for raster graphics

- high speed communications links between the cpu and display terminals

In the past, the huge amounts of data, coupled with numerous manipulations,

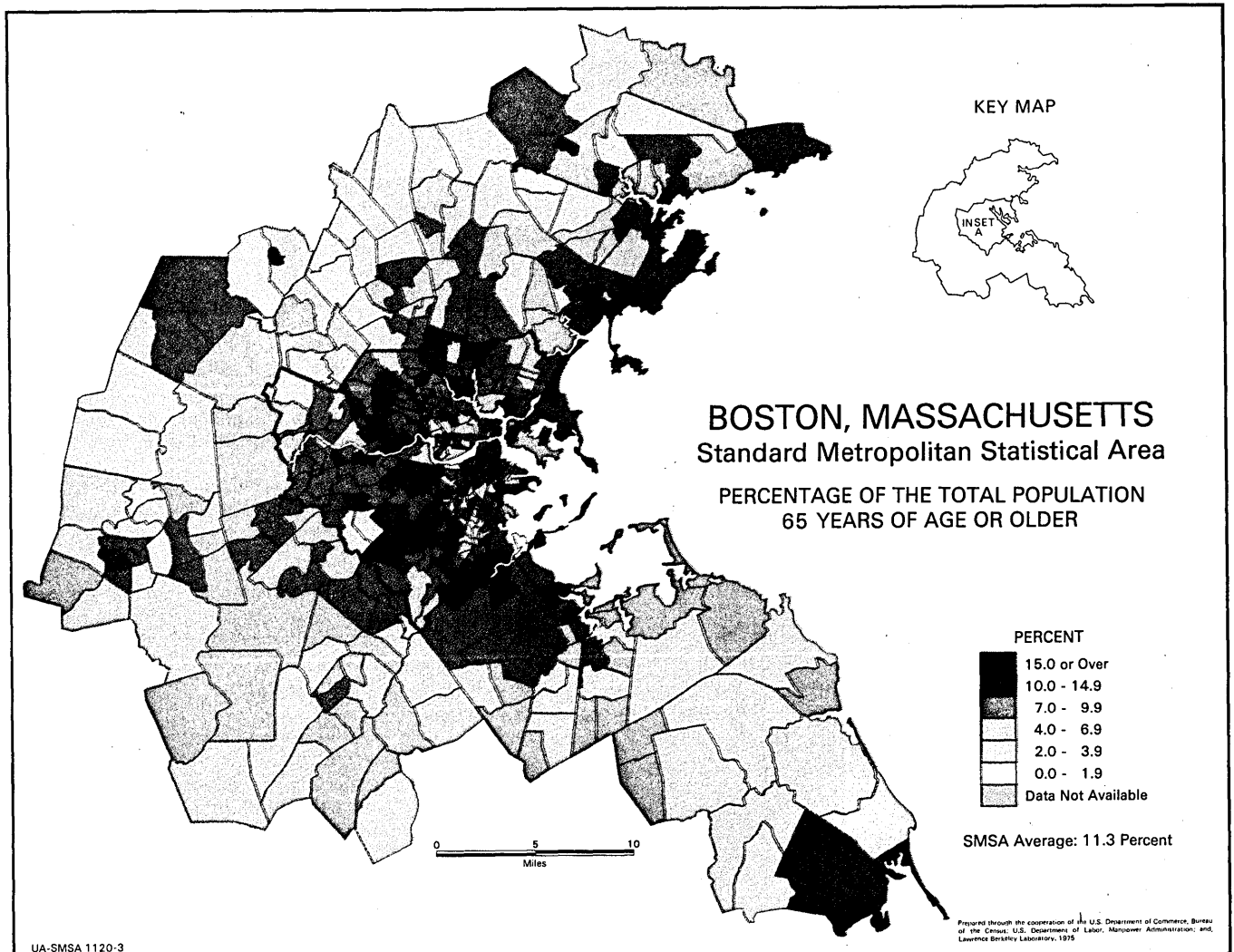

Fig. 1. Computer cartography is a prime example of a kind of information processing which makes good use of both man and machine. Where automated systems are at their best in

repetitive operations, like redrawing the maps, humans are far better than any computerized system at interpreting the results.

## CARTOGRAPHY

required the speed and versatility of large cpu's. However, with recent advances in memory technology and the optimization of cartographic data structures, minicomputers now are forming the basis for some very sophisticated computer mapping systems (see Fig. 2).

### Displaying it

The very first computer maps to be produced were merely alphanumeric printouts which meant very little to anyone until an overlay of geographic boundaries was superimposed. From this crude beginning have arisen many sophisticated output peripherals which have increased both the information content of the resulting maps and also their aesthetic appeal.

Today as in preceding years, the impact printer and pen plotter dominate the area of computer cartographic output. When the map is to be used in an educational or analytical capacity, impact printer output is quite desirable due to the speed and simplicity of production. The pen plotter, in most cases, produces a much more eye pleasing product, and allows for producing perspective maps more easily.

Advances in crt technology have not only introduced new avenues for graphic display, but have introduced the concept of interactive mapping. Both storage and refresh crt's are finding heavy use in computer cartography. Augmented by an attached hardcopy unit, the storage crt offers the output quality usually achieved only with a pen plotter and the low cost usually associated with an impact printer. This combination of devices is likely to find increased utilization in its future.

Numerous other devices have been developed for the production of computer maps but have not yet come into widespread use. For example, light spot-projectors for exposing photographic film, computer output microfilm recorders, electron beam recorders, and jet ink plotters all possess attributes that would make them very attractive to the computer map making community; only their cost effectiveness needs to be determined.

### The software side

The software side is maturing rapidly, too, with more packages available each year. One of the first software routines that is needed is for skew correction, to compensate for slight misalignments of source material during the digitizing process. Software should also be available to allow for the digitizing of source documents of various scales, and to offer the digitizer operator rudimentary editing capabilities.

It is essential to have a robust editing capability. An ability to delete and add

single line segments (vectors) or multiple line segments (chains) is crucial. The ability to check whether geographic shapes are closed figures is also essential. If these editing functions can be done interactively, that's of even greater help, especially on graphics terminals.

Filtering, or the removal of redundant coordinate data, is useful. And in some instances, the volume of nonredundant coordinate data is large enough to bind the host computer, making data generalization absolutely essential. Data generalization is also of great value when the output scale is much smaller than that of the original source material. In such cases, successive points become exceedingly close to one

the task, numerous programs have been written.

Software should also be available for such utilitarian functions as sorting and data packing.

In addition to the standard plot command and printer command software, the user should have software to produce either shaded (choropleth) maps, perspective (3-D) maps, and/or isarithm (contour) maps.

### Cartographic data bases, the hard part

It is the structure of geographic data bases which determines the bottom line of what computer cartography can and cannot accomplish. Two major thrusts

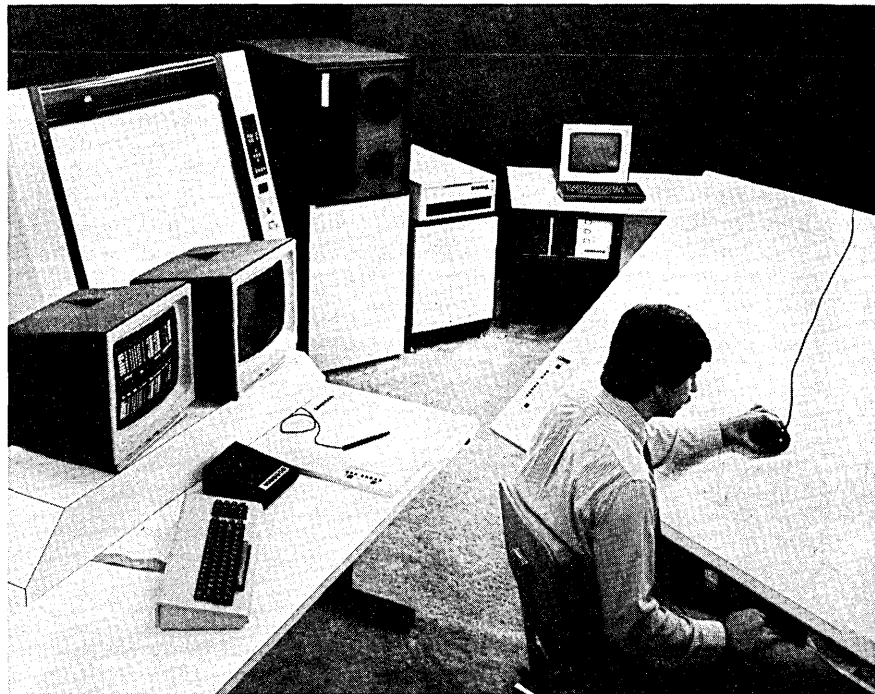

Fig. 2. Not long ago, one of the components of an interactive graphics system for cartography had to be a large scale computer; the amount of data demanded it. Developments in the software for handling geographic data bases—as well as in the power of minicomputers—have largely eliminated this requirement.

New systems, like the IGS-500 announced by CalComp this month, provide sufficient power in a minicomputer-based package—the biggest part being the combined plotter/digitizer.

another, so that much of the coordinate information is redundant. Then data generalization can substantially reduce processing time without sacrificing much apparent line detail.

Other useful software modules permit the computer mapper to choose, from a variety of map projections, one appropriate to his final objective. This normally requires that the coordinates be stored as latitude-longitude data, but "inverse projections" are available to restore already projected coordinates to geodetic form.

If one is interested in producing a contour (or "isarithmetic") map, it is necessary to have two-dimensional interpolation software available that readies the data for final portrayal. Since there apparently is no one best method for

of development have been of the *gridded* data base and the *vector* data base. Although a certain amount of compatibility exists between the two, they represent rather different concepts and representations of space, and each has its own special advantages.

Gridded data bases are the simpler to conceptualize, generate and use, but may be expensive to process, and impose a fixed minimum resolution which may be inconvenient. In gridded form, map data are stored as matrices, with each grid cell of uniform size and (rectangular) shape. One type of information is represented by an array, with the row and column location of a cell being an implicit geographic location for the datum stored in that cell.

The grid thus partitions the space of

## Making a Map

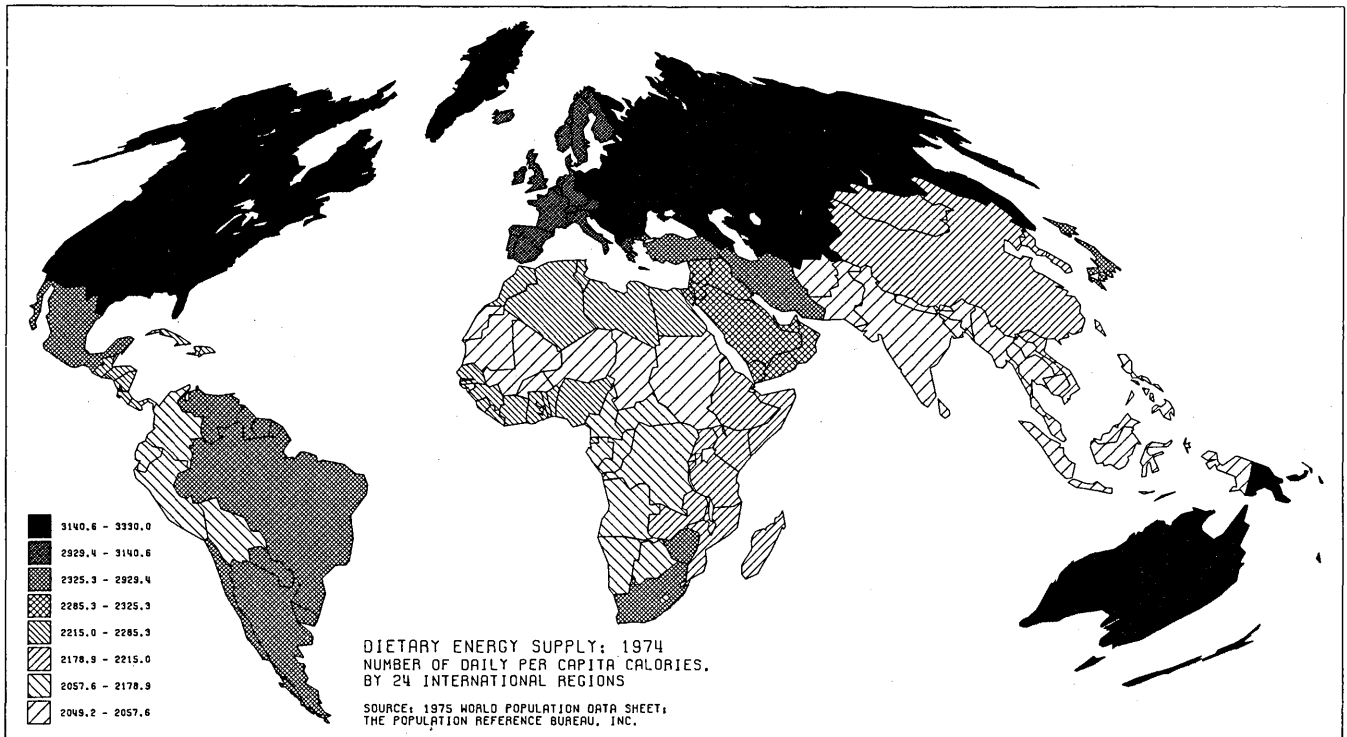

MAPS PREPARED BY HARVARD LABORATORY FOR COMPUTER GRAPHICS & SPATIAL ANALYSIS IN ASSOCIATION WITH THE AMERICAN GEOGRAPHICAL SOCIETY

The map illustrated is a shaded-zone or *choropleth* (to use cartographers' language) map produced using a computer. The automated production of such maps is becoming commonplace, but does not really represent a unique capability of the computer, as such maps have been manually drafted for years. By automating the choropleth map, however, its production can be greatly speeded and accurately controlled, opening new avenues of application.

To produce a map most programs require at least two data bases, a cartographic data base (CDB) and a

statistical data base (SDB). A CDB contains digitized coordinates of locations on the surface of the earth; in this example, the CDB consists of simplified country outlines, or polygons of irregular shape. Each polygon in the CDB is keyed to a value in the SDB by some appropriate identifier (in this case, two-letter country mnemonic codes).

In the CDB, a polygon consists of a list of points, each a pair of Cartesian x-y coordinates obtained by digitizing some original source map. In the SDB, stored separately, each country is simply represented as an identifier fol-

lowed by one or more statistics of interest to the user of the data.

A choropleth map generally portrays only one set of statistics at once, so it may require a series of maps to summarize all the data in a SDB. This is precisely where computer cartography outperforms manual methods; the human effort required to produce each new map is minimal if the procedures are automated, but if not, the cartographer must redraft nearly everything when asked to map new statistics. \*

the map into discrete locations, each of which has an attribute describing the theme of the coverage. To handle two or more attributes, a complete data matrix is needed for each.

The use of gridded data has become prevalent for several reasons. One is the simplicity of grids as data structures. They are easy to store and manipulate, especially in FORTRAN, which is by far the most widely used language in computer cartography. Another reason is that data can be automatically captured by image scanning in a grid or raster format (the distinction between a grid and a raster is small, often only based on the size or number of cells used; also, "raster" is frequently applied to data as captured or as displayed, while "grid" is applied to data as stored or manipulated). For example, LANDSAT satellite images (see page 119)

are raster data (although in their raw form are not compatible with any grid-mapping software).

Scanning digitizers have been developed to automatically produce raster data from maps or other source documents. Historically, hardware constraints also initially favored the stor-

### Fortran is by far the most widely used language.

age of data in gridded form. That is, the earliest computer maps were displayed on line printers. In order to produce graphics on line printers in the form of maps, values must be calculated for each printing position on each line of print output. This necessitates a grid, which must either be input as such or calculated.

As a result of these factors, and also

since certain operations (such as comparison or overlay of two or more coverages) are more difficult to program given nongridded data, gridded data bases continue to be widely used.

The other major approach in handling cartographic data involves *vector* data structures. Vector storage relates to keeping data as line descriptions, where natural or cultural features such as coastlines or state boundaries are captured by measuring coordinates from maps describing the location of points where each line changes direction. Linear features are thus described as lists of coordinates, which break curved lines into a series of straight segments.

The amount of detail captured depends on how many points are chosen to represent a given line, and on measurement error. Closed figures, such as counties or islands, are described by fol-





# The new Harris S123 and S570. You get the capability you need at capacities you can afford.

Harris introduces the S123 and the S570.

These two new computer systems expand the range of VULCAN, Harris's applications proven Virtual Memory Operating System, offering new products for both smaller and larger users.

Both the S123 and the S570 offer mainframe capability.

Both operate with COBOL, FORTRAN, APL, BASIC V, RPG II, FORGO, SNOBOL... and TOTAL, concurrently.

Both are versatile. From dedicated applications to broad general purpose use. Conventional batch processing to demanding real-time modes of operation. Single site to deployed computer facilities. Multiple user concurrence to concurrent multiple uses.

The difference is capacity.

The S123 is the entry level system. It has the capacity to support up to eight terminal users. 144K bytes of real memory, 768K bytes of virtual memory.

The S570 can support up to 64 terminal users. It has up to 3M bytes of real memory. 12M bytes of virtual memory.

All Harris computer systems, from the S123 through the S570, are VULCAN based. All reflect the dependability, predictability and reliability that only a highly efficient, fully matured operating system can deliver. VULCAN based also means that you can grow with Harris without a costly change in applications software and files.

If your need is distributed processing, time sharing, data base management, or any type of concurrent multi-use applications, benchmark Harris.

**Harris Computer Systems, 1200 Gateway Drive, Fort Lauderdale, Florida 33309. Telephone: (305) 974-1700. Europe: Harris Systems, Ltd., 145 Farnham Road, Slough, SL1 4XD, England.**

**All at once, it's Harris.**

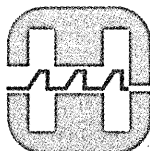

**HARRIS**  
COMMUNICATIONS AND  
INFORMATION HANDLING

## CARTOGRAPHY

lowing their boundaries to make a circuit, ending with the same point where digitizing began. Algorithms exist which can recognize those closed figures (which are generically termed *polygons*). Given such a polygon, algorithms can be applied to calculate its area, its center of gravity, and perimeter, and to determine whether a given location is inside it or outside.

Polygon format is widely used to describe administrative zones, such as counties or census tracts. In fact, when such zones vary greatly in size, as do census tracts, polygonal descriptions are the most sensible approach.

### From line printers to 3-D

The most straightforward way to describe zones, and the first to be employed, is as independent polygons. But although this is perhaps the simplest way for someone to prepare a cartographic data base, it usually requires that all internal boundaries be represented twice, and this means extra digitizing effort.

Polygon plotting is a kind of averaging. That is, each polygon usually represents one nonspatial attribute—population density, caloric intake, or whatever. Showing the variation of an attribute over an area requires a different technique.

One such technique is contour plotting. This is generally done by measuring a variable at specific locations and then interpolating over the region. Each such sample point is simply a pair of coordinates plus an associated value. Examples of this technique are common in the earth sciences, where core or well samples are obtained for a region at certain test stations, as are weather and oceanographic observations.

Interpolating these observations to discern some underlying trend requires the assumption that a continuous distribution exists, such that the given data points are glimpses at some smooth surface which undulates across the study region.

A more interesting portrayal of a surface can be obtained by mapping it in three dimensions rather than as a contour map. This is an area that has been pioneered by developments in computer mapping. The portrayal is usually accomplished by constructing a series of parallel profiles or horizons which are sufficiently closely spaced to appear as a surface. Most surface perspective programs use this form of representation, although some plot profiles in two directions instead of one, creating a "fishnet" effect to define a surface.

Three-dimensional perspectives can also be generated to represent zone data, raised-polygon or *prism maps*. If

the data have been gridded, polygons can be shown in 3-D nearly as effectively as continuous surface data. But given a great many (more than about 80) polygons to map, particularly if the spatial pattern of their attribute values is very irregular, the 3-D image may be difficult to read.

(Our problems involved in producing 3-D prism maps from vector data were not really resolved until last year, with the development of the PRISM program at the laboratory. One or two programs to map polygon data in 3-D had been developed prior to PRISM, but could not handle much detail, requiring the polygons to be severely schematic. It turned out that the crucial element in allowing arbitrarily complex polygon boundaries to be mapped was the type of data structure used to store the boundaries.)

### Cartography meets topology

In the early '70s it became apparent that more sophisticated data structures were needed not only for plotting vector data, but for editing it, controlling

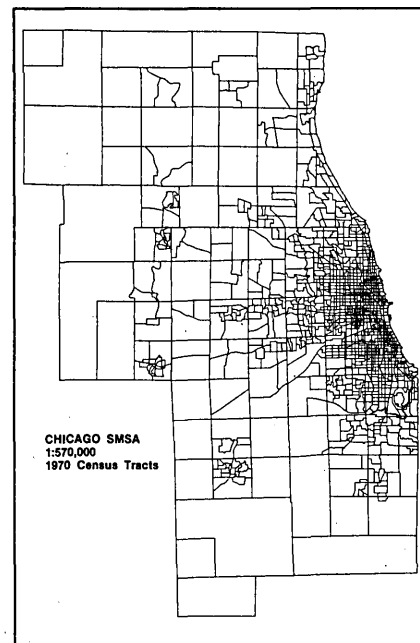

Fig. 3. One recent significant development in cartography is the concept of "chaining." As an example, the 12,326 segments which make up the boundaries of Chicago's census tracts can be represented as 3,547 chains—a reduction of almost 72% in the number of entities to be processed.

detail, and using geographic base files for analytical purposes. The fundamentals for such second-generation data structures were worked out during the late '60s by the Census Use Study at the U.S. Bureau of the Census.

There Dr. James Corbett, an applied mathematician, and his associates developed a data structure for vector data which employed topological principles, calling it Dual Independent Map Encoding, or DIME. Using the topological model of two-dimensional mani-

folds the Census Use group found a method of encoding city block faces (which bound enumeration districts) in a way which allowed a variety of uses of the resultant geographic base file.

The uses include being able to assemble polygons representing blocks, and to aggregate these into block groups, census tracts, minor civil divisions and so on, and also to automatically match street addresses to blocks or census tracts. The latter application was the primary motivation for this work, as it greatly simplified the distribution and tabulation of census questionnaires.

The "applications spinoff" of DIME, however, far exceeded any expectations, and continues apace.

The DIME topological model, formidable as it may sound, is simplicity itself. Each block face, if straight, is defined by a single vector, or DIME segment. Curved block faces may have any number of segments, but each is treated the same, for the segment constitutes the elemental record used by DIME. A network of segments has properties of connectedness and adjacency which can be described locally, segment by segment.

Unfortunately, because DIME was developed for assigning geographic coordinates to entities, not for mapping, there is no explicit representation of polygons in a true DIME file. Many variants have arisen which restructure segments into larger connected elements, both linear and areal.

To make a polygon, for instance, one searches a DIME file to locate all segments which have the polygon listed as lying either on the segment's left or right side. Their node names are then paired to link nodes together, forming the polygon. Obviously, this procedure is slow and expensive, but it need not be done very often.

### Chains and abstractions

One way to streamline DIME and other cartographic data base structures, is to link all the segments which constitute a curvy boundary into a list, and to assign to this whole chain of points the topological properties which all the segments have in common. The chain thus has one left and one right polygon, address range, census tract, etc., still only two true nodes, but potentially many points. The more irregular the geometry of the network being represented, the more efficient chaining becomes.

A good example of a fairly rectangular base file is the 12,326 segments of a highly detailed DIME file of the Chicago area's 1,410 census tracts—which requires 3,547 chains to represent it, or 28.8% of the number of segments (see Fig. 3).

A file with a good many more natural boundaries, the widely used U.S. County DIME File, contains 11,372 seg-

# THE NEC SPINWRITERS:

# PRINTERS MADE FOR PEOPLE.

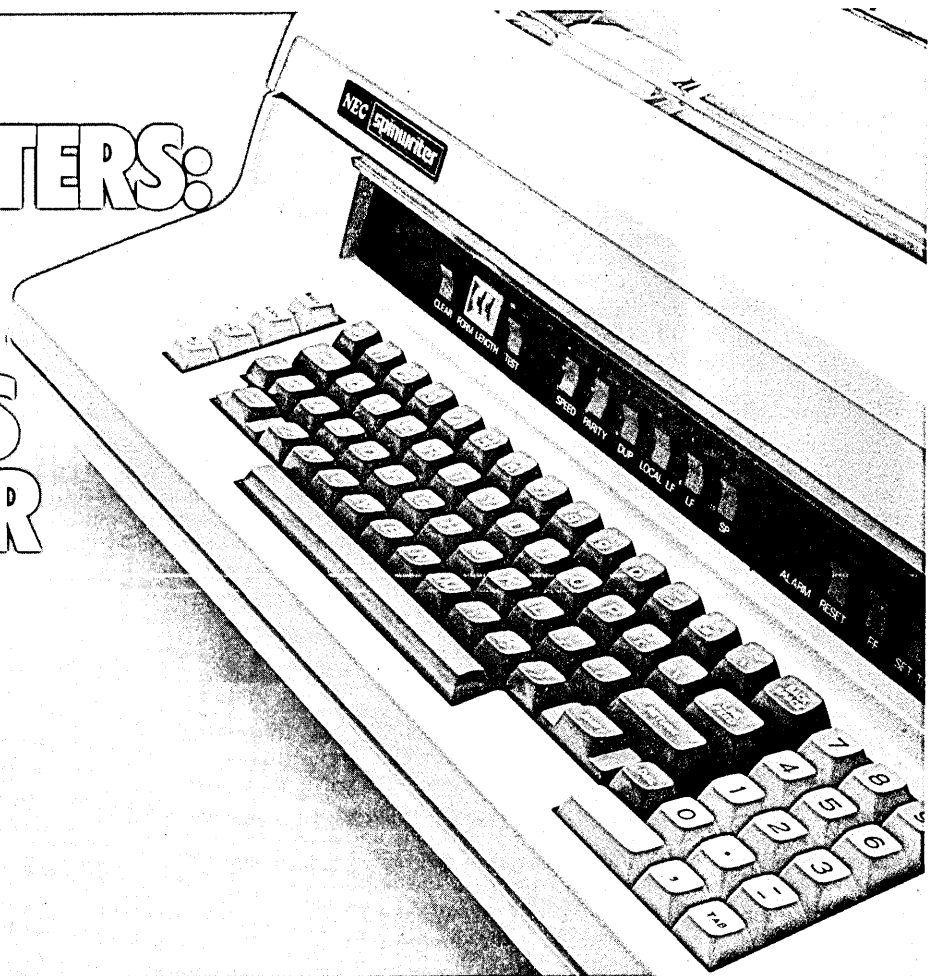

It takes craftsmanship and attention to detail to make a fine automobile, a fine watch, or a fine character printer. Those qualities, available at low cost, have made the Spinwriter family from NEC Information Systems the finest character printers available.

Spinwriters offer performance beyond that of today's best character printers, at prices averaging 10 percent below competition. But NEC craftsmanship extends beyond performance and price, to features designed for the people who use Spinwriters. No other character printers are as easy to operate, as reliable, or as easy to repair.

Die-cast aluminum housings lined with sound-absorbing foam make Spinwriters quieter than office typewriters — and as easy to use.

Spinwriter housings swing open for easy operator access to ribbons and the thimble element, and easy access for service personnel to Spinwriters' modular components. Ribbons, thimble elements, and forms-handling modules can be replaced within seconds.

Spinwriter keyboard send/receive (KSR) printers also provide easier operator access to controls offering more functional capabilities than other character printers provide. A thumbwheel switch enables your operators to specify the precise forms length desired, and they can specify vertical spacing at

either six or eight lines per inch. The unique Spinwriter self-test feature is enhanced to include the interface and communications lines in on-line applications.

Compare Spinwriters with the printers you use now, and see how NEC craftsmanship makes Spinwriters different. See the difference in Spinwriters' smooth-contoured styling, and feel the difference in durability. The appearance, and the ruggedness of Spinwriter printers allow them to fit well in every environment.

Tell me more about the Spinwriter family.

- Please have a sales representative call.
- Please send literature.

Name: \_\_\_\_\_

Title: \_\_\_\_\_

Company: \_\_\_\_\_

Street: \_\_\_\_\_

City: \_\_\_\_\_ State: \_\_\_\_\_ Zip: \_\_\_\_\_

Telephone: \_\_\_\_\_

To find out more about how NEC craftsmanship makes Spinwriters the finest character printers available, fill out the coupon, or call NEC Information Systems, Five Militia Drive, Lexington, Mass. 02173 (617) 862-3120.

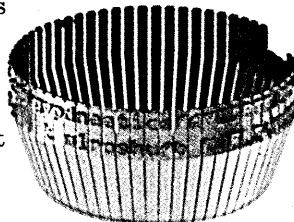

## NEC

### **NEC Information Systems, Inc.**

Eastern Office: NEC Information Systems, Inc., Richard Gilbert, 5 Militia Drive, Lexington, Massachusetts 02173 (617) 862-3420.  
Central Office: NEC Information Systems, Inc., Steve Kadash, 3400 South Dixie Drive, Suite 105, Dayton, Ohio 45459 (513) 294-6254.  
West Coast Office: NEC Information Systems, Inc., Marty Rubin, 8939 S. Sepulveda Blvd., Suite 330, Los Angeles, California 90045 (213) 670-7346.

## CARTOGRAPHY

ments which serve as state boundaries as well as county boundaries. When connected into the 169 chains which bound the 49 polygons (the contiguous states plus the District of Columbia), the number of objects is reduced by 98.5%.

Assembling polygons from chains is clearly much more efficient than assembling the segments directly. Essentially, conversion to chain format simply eliminates spurious nodes, ones at which only two segments meet. The resultant chains, however many points they each may contain, represent the "edges" in the network graph to which one may abstract any geographic base file. The ability to do so, while not appropriate for cartographic representation, plays an important part in the analytic uses of geographic base files.

One application where network abstraction is necessary is traffic flow analysis. Given a street network schematized into topological form, it is possible to simulate vehicular flow, including one-way and turn restrictions, speed limits, and traffic lane capacity. The actual geometry of the network is not really relevant, but its topology is crucial to such simulations, which can evaluate the impact of building a shopping center on its neighborhood's streets, optimize the routing of school buses, fire engines or garbage trucks, or aid in real-time control of traffic signals.

### Where it's paying off

Computer cartographic techniques are currently being used in a broad range of application areas. They include, but are not limited to, public safety, transportation planning, natural resource and environmental science, public health, market research, energy, city and regional planning, and information systems. In almost all of these, the computer cartographic outputs have been used as means to an end as well as an end in themselves, but in all cases they have been a boon to managers and researchers.

The public safety sector is making increased use of computer mapping to allocate men and equipment to potential trouble spots. Also, interactive techniques are being used to track the occurrence of crime in an attempt to discover the spatial characteristics of the *modus operandi*.

The field of transportation has been one of the most active areas using computer mapping. Primarily, work has been directed to evaluating the effects of alternative routes and mixing of urban rail and bus transportation.

The fastest growing use of computer cartography is in the assessment of environmental impacts of proposed projects and resulting land-use decisions. No

other method has been shown to be as effective for analysis and presentations as maps have, and since most analysis is done under fairly severe time constraints, computer produced maps have found abundant use. Particular attention has been paid to the computer cartographic ability to overlay various themes—soils, slopes, vegetation, and land use—to produce a composite map. This technique is referred to as polygon overlay.

Researchers in public health and epidemiology are finding computer assisted cartography a valuable tool in predicting and depicting the possible diffusion of an epidemic, as well as searching for correlations of environmental factors with incidence of cancer. Also, use has been made of computer maps to examine the relationship of chronic disease mortality and components of the socioeconomic environment.

Recently, a great deal of attention has been placed on computer cartography as a vehicle to assist in the making of market research decisions. For example, work has been initiated to interface computer cartographic routines with large data bases containing demographic and economic information. The resulting computer maps will be used to help select sites for new stores and evaluate the market penetration of various products.

The field of energy research is possibly the most diverse field currently utilizing computer cartographic technology. Computer maps have been employed not only to estimate oil and coal reserves, but also to select optimum sites for energy research and demonstration centers.

City and regional planners were among the first professionals to recognize the benefits of applying computer mapping to their everyday tasks. Computer maps have been used to determine such diverse things as sun shadow cast by proposed skyscrapers, property assessments, and potential use of proposed public facilities.

And finally, computer cartography has been used in multidisciplinary contexts such as in geographical information systems and management information systems. More and more top executives will be receiving information from their information systems in map form. Management will no longer be faced with the impossible task of assimilating vast quantities of statistics. A small number of graphic displays will allow for the rapid comprehension of significant trends and important exceptions.

The full impact of computer cartography on the computer professional has yet to be felt, as more and more scientists and executives look to this tool for help in handling the information explosion. We can now say with some cer-

tainty that the great emphasis in the computer field in the 1980s will be on the construction and use of data bases, and that computer cartography will emerge as a superior means of accessing and interpreting the data contained in them. \*

*Further examples of current applications of computer cartography will be displayed and discussed at a major "International User's Conference on Computer Mapping Software and Data Bases: Application and Dissemination" by the Harvard Laboratory, July 23 to July 28 in Cambridge, Mass. For more information about the conference, contact Mr. Ira Alterman at the Center for Management Research (617) 738-5027.*



Mr. Dutton is an applications programmer/analyst at the Harvard Univ. Laboratory for Computer Graphics and Spatial Analysis. For the last nine years he has been performing a variety of research and applications work including the development of macrogeographic models of population and income distribution, the production of mapping software, and the design and use of spatial allocation models.

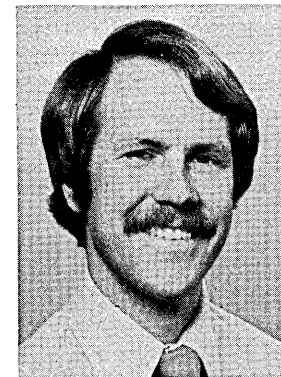

Mr. Nisen is the director of distribution services for the Laboratory for Computer Graphics and Spatial Analysis. Before coming to the lab, he worked as director of operations for Compumatrix, a firm specializing in computer cartography as a tool in environmental analysis. His recent work has been in the use of computer graphics in an epidemiological investigation.



I try to do every job now.

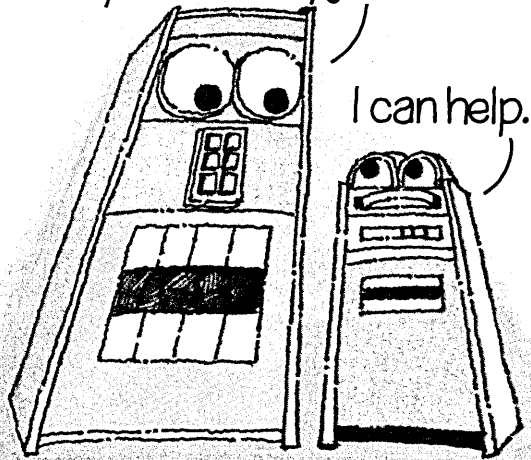

I can help.

I need someone who speaks my language.

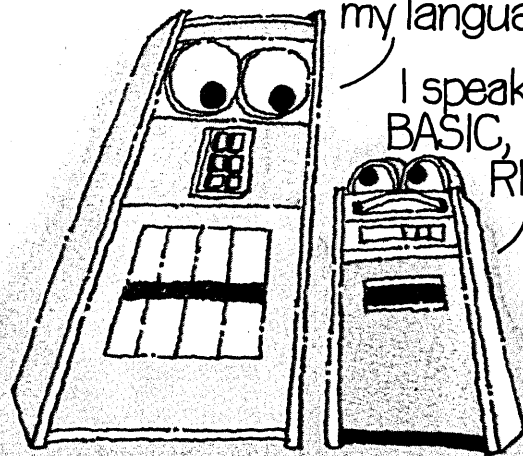

I speak COBOL,  
BASIC, FORTRAN,  
RPG.

I need someone to take a load off my shoulders.

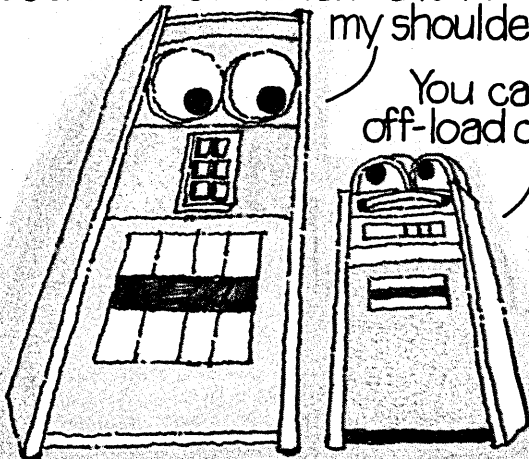

You can  
off-load on me.

I need someone who's compatible.

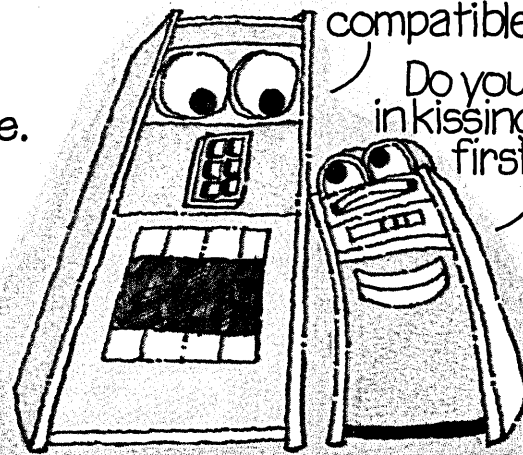

Do you believe  
in kissing on the  
first data?

## We solve problems without creating new ones.

Some computers can create more problems than they solve. Especially if they mean new ways to work. New languages to learn. And new staff to train.

Digital's interactive Data-systems are different. They're designed to work with you and your big systems. They're main-frame compatible, and they offer high-level software capabilities you're already used to. Such as COBOL, BASIC, FORTRAN, RPG, SORT, QUERY, and multi-key ISAM. All executing simultaneously. They also offer industry-compatible communications. As well as data base management capability, transaction processing capability and distributed

data processing capability.

Using our tools, you can get maximum performance with a minimum of staff retraining. You can get a system that can communicate with the systems you already have in place. You can get high throughput at a low cost of conversion. You can do all this. And more.

And since Digital offers a broad range of systems, you can select the right combination of both hardware and software for your application. No matter whether it's transaction processing, general-purpose computing or performance-tuned applications.

In short, Digital offers

everything you need to turn business problems like data entry, inventory control and customer-base inquiries into real business opportunities. To find out more, call your nearest Digital sales office, or write Digital Equipment Corporation, Business Products Group, MK-2/H32, Merrimack, N.H. 03054. European headquarters: 12, av. des Morgines, 1213 Petit-Lancy/Geneva. In Canada: Digital Equipment of Canada, Ltd.

**digital**

**MODCOMP Classic. A lot of computer. But not a lot of money.**

Our new MODCOMP Classic costs less than any other super mini. Yet, in benchmark tests, it's outperformed the best of them. The reasons?

- A super fast floating point processor.
- 7 MIP files and 240 registers for lightning fast context switching.
- Unique multi-word architecture.
- MOS of core memory with effective cycle times as low as 125 nanoseconds.
- An enhanced Fortran oriented instruction set.
- I/O processors that can handle up to eight million bytes per second.
- An optional communications processor

which provides a multiplexed direct memory path for up to 256 full duplex lines.

• And a CPU that can execute many instructions in 200 nanoseconds.

**Built to save you the biggest expense of all — downtime.**

The Classic features our exclusive wire-wrapped PC boards that are more reliable and easier to service than soldered boards. Hardware diagnostics and test connectors that allow you to test all components quickly. And PC boards that plug in and out for fast replacement.

You also get our product development tools to help you get your system up and running fast. And our service and support to keep your system running successfully.

**A complete family of computers. Plus field-proven software.**

Classic is a complete family of computers. Supported by a full complement of peripherals, process I/O interfaces and software operating systems. And it's upward compatible with all MODCOMP computers.

Whether you're a computer user or OEM, if you're thinking about buying or expanding a computer system, consider cost/performance, reliability and ease of implementation.

And consider Classic. Because it will probably be your first choice on all three counts.

Send for our MODCOMP Classic brochure.

**When you put a name like  
Classic on a new computer, you've either  
got a lot of nerve. Or a lot of computer.**

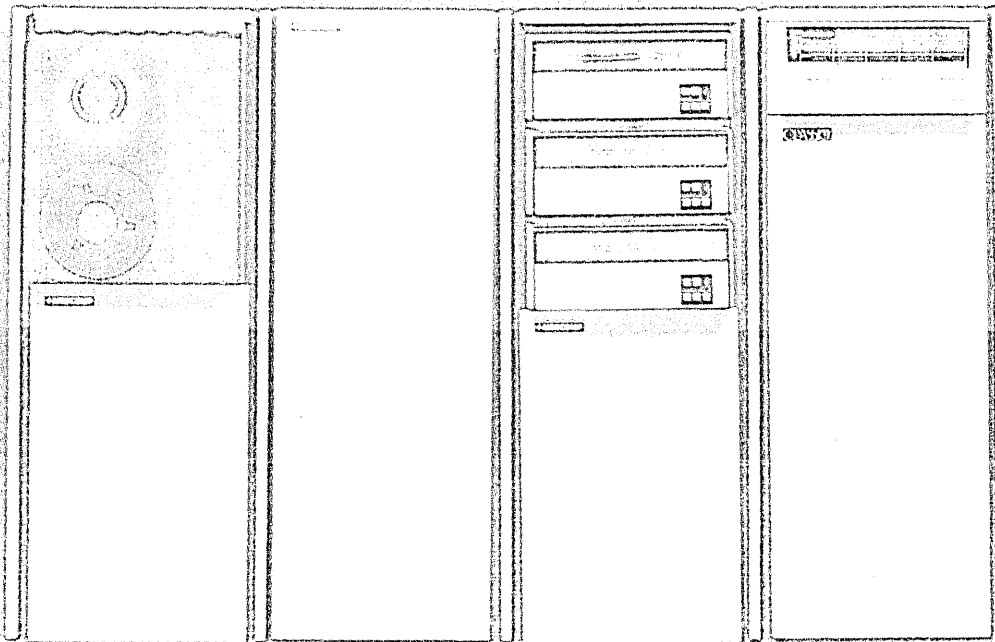

**CLASSIC / MODCOMP**  
Dedicated to your success

Modular Computer Systems, Inc., 1650 W. McNab Road, Ft. Lauderdale, FL 33309 • Phone (305) 974-1380  
See the MODCOMP Classic at booth # 1507 during the 1978 National Computer Conference.

# The Last of the First

by Aubrey Dahl

The Univac II was a marvelous collection of 5,200 vacuum tubes, 18,000 crystal diodes, 184,000 magnetic cores, hundreds of feet of plumbing, and countless miles of wires. It's a wonder that it worked at all; but work it did—for more than 18 years.

The year 1958 was not exactly a banner year in the course of human events, but it did usher in a computing classic when Sperry Rand first presented the Universal Automatic Computer Model II (Univac II) to the world.

It was not only one of the most powerful computers of that time, it was a veritable workhorse, persevering in varied environments on many different applications, and working on and on over the years far beyond the time of its expected obsolescence.

But, inevitably, even reluctantly, the end came.

What is believed to be the last existing functional Univac II in the world finally stopped reading, writing, and computing this March when it was retired after more than 18 years of reliable, sometimes even incredible, service.

The last 13 of those 18 years were devoted to the processing of accounting data for Computer Data Corp., an enterprising Gardena, Calif., service bureau, where the first generation machine was kept alive with third generation software developed by the firm.

Univac II was able to support the accounting needs of an extraordinary number of Computer Data customers, more than 1,000, who probably didn't realize or care that their work was being done on the clanking antique.

Computer Data's president, Thomas Pryor, bought the machine from Pacific Finance in Los Angeles in 1964 when, at a youthful 5 years old, it *already* was obsolete. But the price was right and Pryor had a need and a fondness for the wondrous instrument.

The cost of the computer was minimal compared to the expense incurred during installation. Much larger in size than an IBM 370/168 and less powerful than a present-day mini (in fact, it is being replaced by one—the Sperry-Univac V76), the Univac II was moved by cutting out a wall in the building that housed it, and carting it across town to

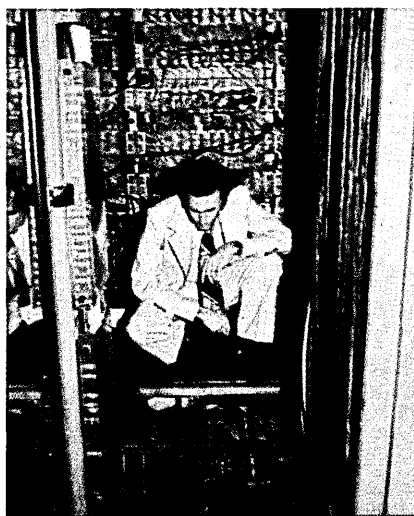

Gardena, where a building had finally been located that had a back door large enough to accommodate its unwieldy size. It wouldn't have been much more trouble to disassemble, move, and reassemble a two-bedroom house.

When Sperry Rand first built the Univac II, it was hailed as an impressive achievement in the emerging science of automated data processing. And, indeed, it was, even though only about 32 were ever built.

*Think back. 1958 was also the year of the hula hoop.*

*And it was only a year after the introduction of the Edsel.*

The Univac II had much greater speed (160usec add time versus 525) and memory (10,000 12-bit words of core versus 1,000 words of mercury delay line) than its predecessor, the Univac I, which is often acknowledged as the first commercial computer.

Characterized by tube technology, the II boasted more than 5,000 vacuum tubes, or "valves," uncounted miles of wiring, an immense water cooling system, an enormous, tricky console, and a central processor that was 9 feet high, 10 feet wide, and 14 feet long.

## A walk-in cpu

In fact, the cpu was so large that it had a door on it and interior space enough for a person to stand up and move around in it. The computer and its peripherals, which together weighed more than 8 tons, required a room with about 2,000 square feet of floor space. Its water cooling equipment was nearly as big. Input was in the form of ½-inch magnetic metallic foil tape on reels that weighed about 2½ pounds—each—and were, as one might expect, very durable. The foil tape is no longer made, but the original tapes worked fine right up until the end. When a bad spot appeared on the tape, it was possible to simply punch a hole in it at that point and continue to use it; the tape drives would skip over the hole.

The II was not basically a punched card machine, as were most of its brethren. That magnetic foil tape was the input medium, too. Data entry was done, as it had been on the Univac I, using key-to-tape devices—long before the Mohawk Data Sciences engineers and others put their minds to the matter.

Unlike newer machines, Univac II had a radio speaker that was used to "listen" to its operations when troubleshooting the system. Any deviation in the sound of the noisy computer, and the bug usually was spotted. Inventive programmers took advantage of this feature, in dull moments, and wrote routines to make it play music. What modern day machine would be able to sing "Auld Lang Syne" at its unplugging ceremony as the II did?

According to various users of the old machine, it was the most complicated and overdesigned piece of equipment ever built—and one of the most dependable.

*It was in 1958 that the first U.S. earth satellite, the Explorer I, went into orbit and discovered the Van Allen radiation belt circling the globe. Globe? That*

## LAST OF FIRST

same year, another space probe, the *Vanguard I*, determined that the earth is slightly pear-shaped.

And Tim Tam won the Kentucky Derby.

Other users of the Univac II system included the U.S. Navy Electronics Supply Office, the Department of Agriculture Commodity Stabilization Service, U.S. Steel, Metropolitan Life, and Pacific Mutual Life.

These organizations bought their systems new at a price of around \$1½ million each. Tom Pryor bought his secondhand, after it had been used for five years by Pacific Finance. He estimated that with knocking out a building wall, moving, and the setting up—which included installing an \$80,000

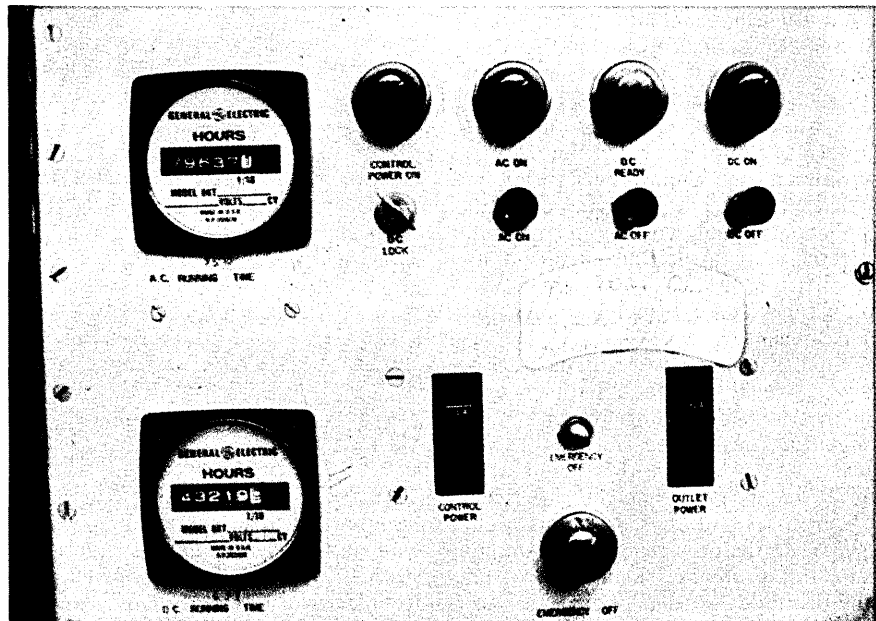
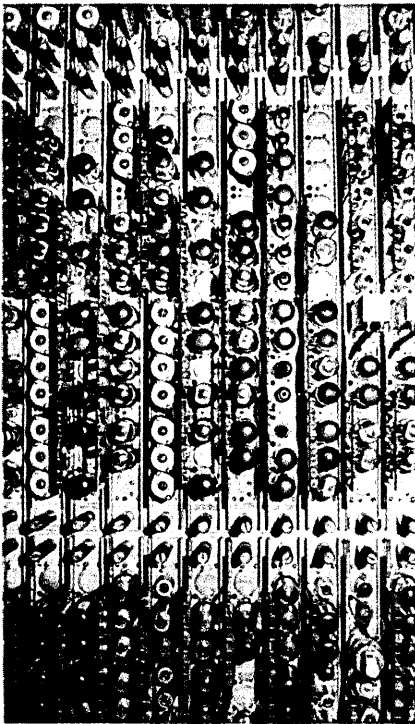

water cooling system—the machine cost him \$250,000. That's about \$20,000 a year for 13 years service he's enjoyed—dirt cheap.

The "high speed" printer that worked with the computer was actually a Univac I device that was five years older than the Univac II. It was capable of a then-incredible 600 lines per minute on alphanumerics and was good for 800 lpm when pushed a little. It was still capable of this performance at the end.

### The software lives on

The programming language used with the computer was, appropriately enough, machine language. But the third generation software developed by Computer Data over the years enabled Univac II to perform accounting appli-

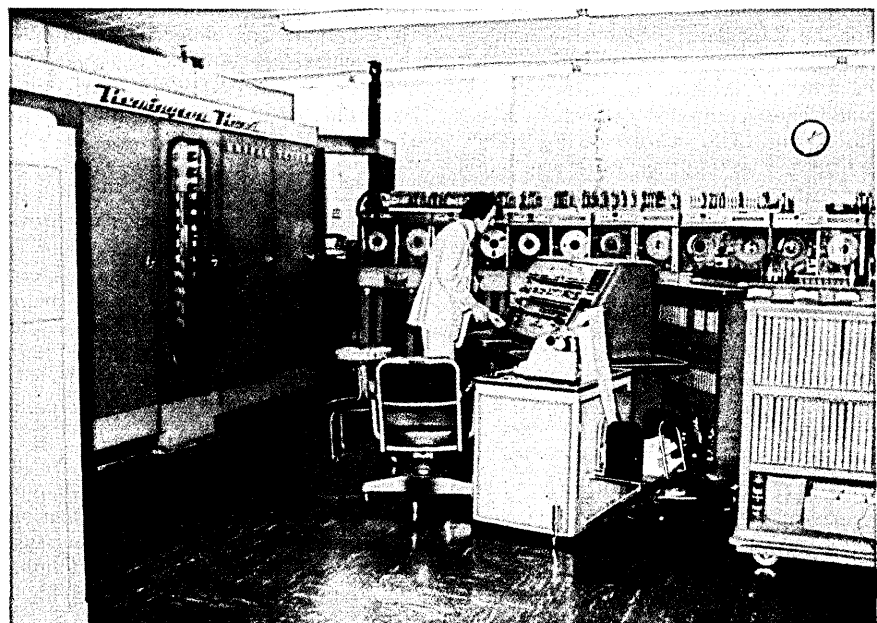

cations that included payroll, accounts payable and receivable, invoicing, and inventory control in a kind of "pipelined" batch mode.

Computer Data had developed, among other functions, a monitor that allowed each customer's applications to be handled separately, but processed all like operations sequentially in what might be called a "sub-batch."

Although all the accounting programs are integrated with each other, they are structured into standalone modules. The specific requirements of each client are accommodated by the coding of selected options in each module. These options are recorded by entering what is equivalent to a company profile on each firm whose work is to be processed. The programs then per-

form as if they are custom programs especially designed for that particular company, except that all of the invoicing for all of the clients is done in one pass, then all of the accounts payable, etc.

Because of the modularity, a user could begin with less than the full system and know that when he developed the need and was ready for it, the expanded system would be available to him. In a way, the concept was a cross between tab processing techniques and batch processing. Yet it was highly efficient in that, unlike batch or even multiprogramming in batch, it avoided continual loading and unloading of programs. And of course the machine was built long before multiprogramming was introduced.

The software has been converted to the Sperry-Univac (nee Varian Data Machines) V76, and will be made available to installations using Varian computers in accounting applications—like an old man teaching his grandchildren a few tricks. All of the accounting systems will be offered by Computer Data; they may be offered by Sperry-Univac's Mini-Computer Operation as well.

*The U.S. was approaching the end of a decade that had been relatively calm and peaceful, even though controversy continued to flare over the continued development of nuclear weapons. The so-called minorities were asserting themselves in a way that would ultimately result in the publication of a book named "Roots" and a new awareness of human legacies.*

The machine was an incredibly reliable worker from its beginning. "It had only two down times of more than eight hours in 12 years of operation," said Pryor.

#### Through fire and flood

But those down times were certainly singular. In one instance, the machine began to function sporadically and thorough troubleshooting failed to turn up the cause of the malfunction (the computer wasn't operating well enough to execute the fault-finding routines).

Then someone thought he smelled smoke coming from the top of the cpu. He climbed a ladder (remember, the cpu is 9 feet tall) and found that there was cable erosion from what he later called "tired insulation"—the cable, which had been about a full inch thick, had frayed away over the years to a 1/4-inch strand. Still the machine had run on. And so the cable was cut and spliced, fresh insulation material was wrapped around it, power was turned back on, and the Univac II again operated with its customary reliability.

*Arnold Palmer was the PGA's leading money winner in 1958 with \$42,507. Skirts were getting shorter and the nuclear powered submarine USS Nautilus made the first under-ice cross-*

Its vacuum tube technology clearly identifies the Univac II as being a first generation machine, and even with its panels closed, there's something about the shape of its cabinetry that marks it as an antique. Certainly its walk-in cpu is a good clue. (In the photo on page 145, Richard Means is shown inside the processor, where he has lifted a portion of the flooring to expose the chilled-water plumbing.)

Other aspects of the machine don't seem so dated. Its line printer was a Univac I device, introduced in about 1951, but quite capable of printing at 600 lpm—even faster when pushed. The tape drives have dual vacuum columns, making them look more recent, but used metal foil tape. Notably there were no card devices attached to the machine. Input was primarily through key-to-tape devices, which Remington Rand pioneered.

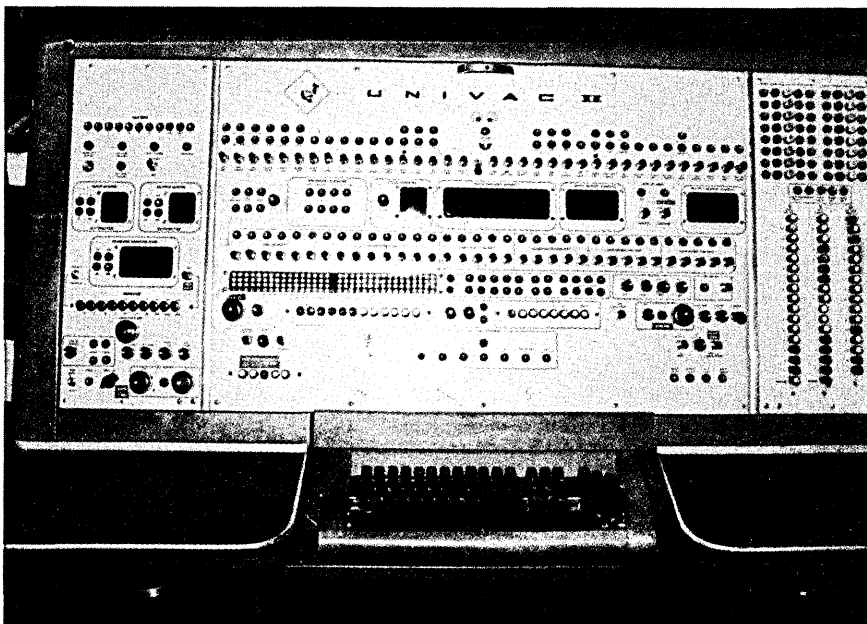
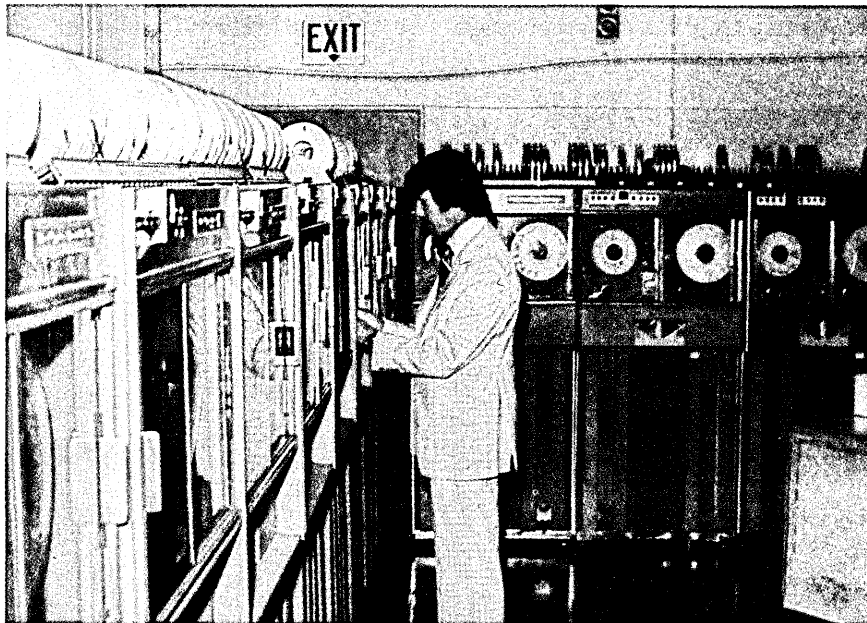



# Powerful new way to write interactive data entry programs:

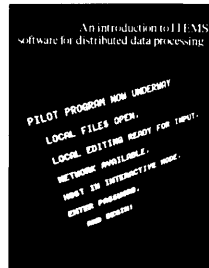

## ITEMS™

ITEMS software — the INCOTERM Transaction Entry Management System — is a virtual storage operating system for distributed data processing. A powerful software development tool that can dramatically reduce the time required to create and implement versatile application programs.

ITEMS software gives the system designer such operating advantages as extensive local editing, local screen format and data storage, local data entry control, interactive and stand-alone processing options, as well as security procedures. Implementation is greatly simplified. Mainframe application programs continue without workflow interruption.

User experience shows that 20% to 30% of all interactively entered data results in error. ITEMS software offers an efficient solution to this costly problem while enhancing data entry throughput and reducing mainframe overhead. ITEMS software operates on standard INCOTERM Series 30 or Series 40

Intelligent Terminals with diskette or rigid disk storage. Up to eight display stations and eight printers can be operated independently under sixteen concurrent programs. Operators are guided by editing attributes for each input field; 25th line messages prompt accurate keying. Why not discover how you can use the full power of ITEMS software on your existing network without extensive conversion procedures. Call or write for complete details.

More power  
to your  
terminal.

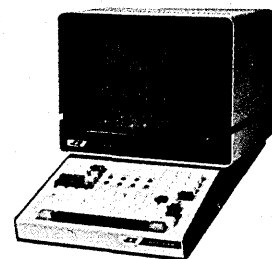

**INCOTERM®**  
CORPORATION

A Subsidiary of Honeywell Inc.  
65 Walnut Street, Wellesley Hills, Massachusetts 02181  
Telephone: (617) 237-2100

## LAST OF FIRST

*ing of the North Pole on its way from Hawaii to Iceland.*

Another time at Computer Data the big machine went down due to a plumbing problem. When the door to the mainframe was opened, water gushed out onto the floor.

The computer, Uniservo II tape drives, and power supply all were cooled by a system that pumped water chilled to 50° at a rate of 130 gallons a minute through copper piping. One of the pipes that ran under the floor of the computer had sprung a leak and water was jetting into the air like a small geyser. The first step taken was to cover up the leak with whatever material was at hand—"keep operating" was the watchword.

Water or no water, only *after* the shift was ended was the extent of the damage surveyed. The floor was soaked and the drainage hole under the floor of the cpu was under water. There was water, water everywhere. An ordinary hand pump was purchased from a nearby builder's supply outlet, hoses were attached, and the pumping proceeded. Fans were turned on and placed to help the moisture evaporate. And in a matter of hours, the job was finished.

Almost. When the Univac equipment was moved in, an 18-inch-deep trough had been dug in the cement floor between the mainframe and the console to hold the cables connecting them. The trough had been covered over with fitted wood planking. When the cover was lifted, the trough was found to be brimming with water, the cables completely inundated. The machine had run in spite of this. And there wasn't a single short circuit in the system.

### Succumbing to old age

Richard Means, Computer Data's engineer who watched over the Univac II for the past 13 years, and who worked for Sperry Rand on a similar machine for three years before that, said that it was a "phenomenal" computer in terms of dependability.

"I have taken components out of it for maintenance or whatever and it just wasn't supposed to keep on working, but somehow, it did. It made some kind of inner adjustment and stayed on. Incredible!"

However, Means added that each morning he came to work during the months before the computer was phased out, he kept his fingers crossed and said a little prayer.

To help maintain his machine, Pryor bought Univac components as spare parts when other machines came to the end of service over the years, and kept them in rented space in a warehouse next to his company. The warehouse has become an archive of first genera-

tion computer hardware.

*President Eisenhower signed the Presidential Pension Law in 1958, and sent Vice President Nixon on a goodwill tour of South America, where he was mobbed in Caracas, Venezuela.*

*And the Supreme Court reordered school integration in Little Rock, Arkansas. The more things change, etc.*

A change in business requirements in the mid-1970s and the continuing growth of the company led Computer Data to the installation of an on-line system that could also continue the firm's time-tested batch operation.

Cost considerations and performance were major factors in the decision to make the conversion to the V76 minicomputer, which is currently priced at about half of what the secondhand Univac II had cost and provides a great deal more capacity, speed, and power.

The V76 minicomputer has two 64K 16-bit memory modules. The mini has semi-conductor memories instead of core, and two 92MB discs. According to Pryor, the continuing drop in the price of discs was another reason for the conversion.

Another cost factor was the electricity bill. It was running about \$2,500 a month, with the Univac II accounting for about 80% of it. When the V76 was added during the changeover, Pryor said that he hadn't noticed an increase of even \$100 in the monthly bill. Now that the V76 is being used exclusively, the savings are, at the least, substantial.

There were other, more particular, grounds for making the change. Even with the extensive spare parts inventory, maintenance grew increasingly difficult. And qualified technicians understandably became scarce.

Pryor explained that engineers trained in tube technology for computers had become a vanishing breed because tube logic had not been taught to undergraduate engineers in recent years. Thus, as the need for a certain proficiency diminishes, so does the proficiency, itself.

*1958 was the first year that airlines carried more transatlantic passengers than ships and the year of the first jet service across the Atlantic, by BOAC. Charles de Gaulle became the President of France, and President Eisenhower sent 5,000 Marines to Lebanon.*

*And the John Birch Society was founded.*

*And Althea Gibson repeated as national woman's tennis singles champion at Forest Hills.*

### Scrap or souvenirs?

There is, of course, a nostalgic concern that the last functioning Univac II has been consigned to history. When asked why he had used the old workhorse for so long, Pryor answered, "Because I owned it and it worked, and I

wanted to wait until minicomputers became usable and could provide the right kind of accounting software support to go with our own system programming."

The ultimate disposition of the venerable computer is still a matter of some conjecture. Pryor thought he might rent warehouse space for it and the spare parts and preserve what is now a relic for future interest, if he finds it economically feasible.

On the other hand, he might, as he said, just save some of it and sell the rest for scrap metal or souvenirs.

Dick Means had some thoughts on that subject. "The Varian operation undoubtedly will bring in new business with its advanced technology, but it wasn't that the demands were too great on the Univac—it was just over the hill."

He smiled. "As for reducing the machine to scrap, you have to remember that it's Mr. Pryor's baby—he could never watch anyone take a hammer to it."

*The Pioneer moon rocket was launched in 1958. It didn't reach the moon but it achieved an altitude of 79,000 miles, 30 times as high as any previous man-made object.*

The Univac II family set its records as well. Its last member was operating productively 20 years after the series introduction, its meter having recorded 43,219.9 hours of processing, 79,637.1 hours of being powered up. Those marks may never be equalled. \*



Mr. Dahl is currently with the public relations firm of LeAnce & Co. in Newport Beach, Calif. His association with the data processing industry goes back about half of the Univac II's lifetime, and at one point he was the head of *Datamation's* news department.



## Out of disk space? No problem — just ask the boss for some more disk drives. Again.

On the other hand, you might suggest he take a look at the UCC-3/ADAM Disk Management System.

This software package can vastly increase the availability of usable disk space... *without spending a cent on expensive new hardware.* Because, chances are, your shop already has all the disk space it needs... it's just not being used efficiently.

UCC-3 eliminates disk fragmentation and maximizes DASD space usage efficiency. It produces complete reports that allow you to analyze your disk space problem. Next, based on your criteria, it will solve the problem by automatically migrating selected data sets to tape and scratching unneeded and invalid data sets. Then, UCC-3 will keep the problem from recurring by controlling data set allocation.

Don't ask your boss to buy another disk drive until you've called us at 1-(800)-527-3250 (in Texas, call 214-688-7313). Or circle 90

A Tape Mgmt System that protects data from

loss or destruction (UCC-1). Circle 91

A DOS Under OS System that lets you use DOS programs, without reprogramming, as you convert to OS (UCC-2). Circle 92

A PDS Space Mgmt System that eliminates PDS compression (UCC-6). Circle 93

A Data Dictionary/Mgr that really gets IMS under control (UCC-10). Circle 94

A Job/Recovery Mgmt System that makes restarts and reruns simple (UCC-15). Circle 95

A GL/Financial Control System that Accounting has been dreaming of (UCC-FCS). Circle 96

An IMS Database Verifier checks physical pointers, finds errors before they become problems (UCC-40). Circle 97

An IMS Database Space Utilization Program pinpoints DB loading problems (UCC-41). Circle 98

A broad line of Banking and Thrift software. Circle 99

Software packages like these. One more way—

## We're helping the computer to do more of the work.

**UCC**

P. O. Box 47911 — Dallas, Texas 75247

Canada: 797 Don Mills Road—Don Mills, Ontario M3B 1Z3 • Europe: 1258 London Road—London, U.K. SW16 4EG

# What Keeps Your Communications Equipment Running Smoothly?

## General Electric Service

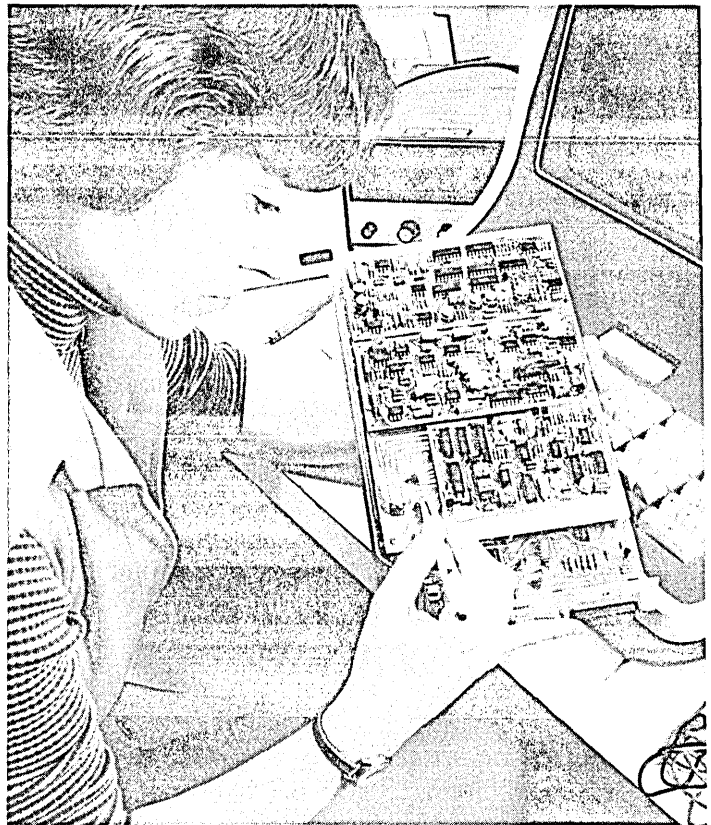
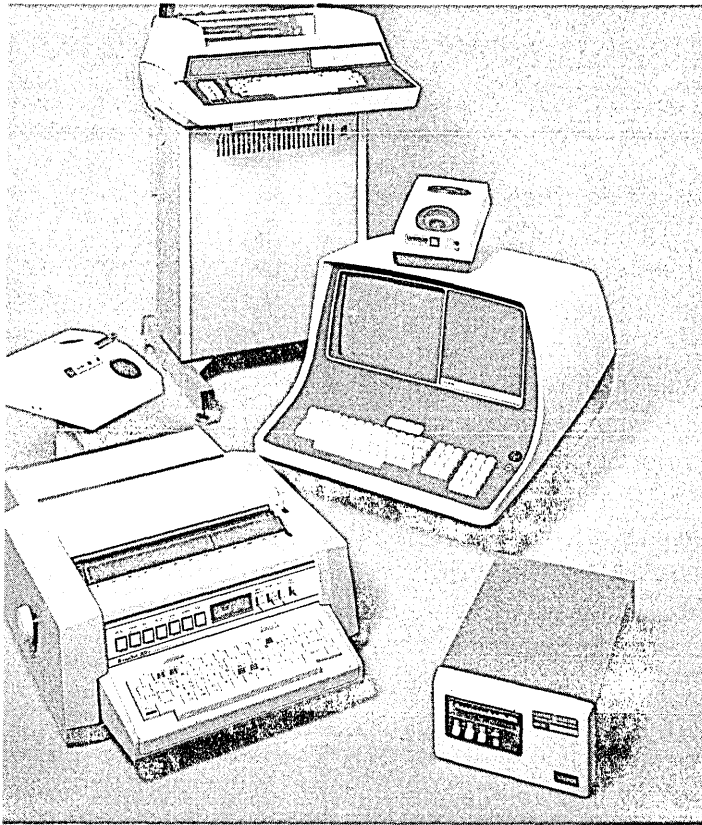

Like any other complex mechanism, communications equipment occasionally malfunctions and requires regular maintenance. That's why you should know about General Electric's communications equipment service if you use, manufacture, or resell such equipment.

General Electric Instrumentation and Communications Equipment Service Shops are located in major cities across the country, with factory-trained GE technicians who can respond quickly when your equipment, or your customer's, requires maintenance or repair. Our master file of the equipment's service history can speed things up, too.

Call when you need service, or take advantage of our complete service "package" (where a flat monthly charge covers preventive maintenance, replacement parts, and service labor).

In addition to service, we sell and lease the TermiNet<sup>®</sup> Printers, ADDS Video Display Terminals, the VADIC 3400 Full Duplex 1200 Baud Modem, and the reliable Livermore 76B Coupler.

If you manufacture, resell, or use communications equipment, keep it running smoothly and efficiently — and at low cost — with communications equipment service by General Electric.

For more information contact Manager-Communications Equipment Services, General Electric Company, Apparatus Service Division, Building 4, Room 210, 1 River Road, Schenectady, N.Y. 12345.

GENERAL  ELECTRIC



# Facing Financial Realities in Banking

by Robert Chapman

Fully automated on-line systems are not always cost justifiable, but the alternatives need not be painful.

By early June 1976, a special Bankers Trust task force had developed the specifications for a custom multiprocessor system which would put all its branch banks on-line and carry the firm into the age of computerized automation. All monetary transactions and account status inquiries were to be entered through crt terminals. Balancing the cash drawers at the end of the day would be a breeze, and many paper documents which previously flowed from the branches to central operations would be made unnecessary.

The system had one fatal flaw, however. It couldn't be cost justified. Nor, we learned, had other banks been able to cost justify such systems. The declining cost of electronic automation simply hadn't declined far enough.

After that initial failure, the task force went on to a series of successes in defining a system with an acceptable return on investment, training hundreds of bank personnel in its operation, and bringing the bank's branches on-line at a rate of as many as 39 sites per week. And in retrospect, we wonder whether the cultural shock involved would have prevented our going from a manual system to our original target of a completely automated system in a single leap.

For background, Bankers Trust Co. is a major New York City commercial bank, the ninth largest bank in the U.S., and maintains some 200 branches throughout New York State. The project described here involved the installation of the bank's first electronic teller terminals in 103 of those offices, spread over a geographical area of 70x60 miles. Prior to this project, the bank had no network of any kind linking those branches.

## Beginning with optimism

In January 1975, Bankers Trust had formed the task force and given it the charter of devising the best way of using automation to assist branch banking. The task force was intentionally positioned as a bridge organization between the users (Metropolitan Banking Dept.) and the developers (Computer Systems Dept.) in an attempt to overcome prior frictions. As head of the task force, I reported administratively to the head of MBD, but for project-related decisions and guidance I reported to the Business

Review Group, consisting of senior managers from both MBD and CSD, according to the skills needed at the time. Clearly, the survival of this type of liaison organization would depend on the good will of both departments.

The problem set before the task force was to combat the inflationary pressure of labor-intensive processing using the declining (but still too high) cost of electronic automation.

By June 1976, we had a competently prepared functional specification describing a system with some 88 separate transactions. It became obvious at that time that we were faced with a serious cost/benefit problem: the system was going to cost a lot, and the benefits to be expected from it would not begin to meet the bank's return-on-investment (ROI) criteria. A set of rough financial data is given in Table 1.

We then belatedly turned full attention to the ROI question. We re-examined all the ROI analyses over a period of about three months; the results got worse. The most serious problem was that although the system could help the teller balance more quickly at the end of the day (which had been counted as a benefit), we still had

to pay for the whole work day. We talked to every bank that we could find which was considering branch automation and which was of a comparable size to our own to see if they had achieved cost-justification. We did not find any, and we were unable to find any flaw in our unattractive calculations.

We then tried to define a system of lesser function and better ROI by selecting from the full-function system those features with the best return. In spite of lots of work, we were unable to define a cost-justifiable system, or in most cases even one with a positive ROI.

## Falling back to the real world

By the fall of 1976, we had firmly decided against the full-function approach. Our efforts turned to an "inquiry and hold" system which would give tellers an automated trial balance. That is, the system would present customers' balances and allow those balances to be decremented in real-time as tellers paid out money to customers, but it would not be on-line to the real files. Its files would be loaded each morning and scratched the next morning.

As part of the system, we decided to

Looking at Costs versus Benefits	
One-Time Cost	\$3M
Branch Terminal Hardware	2
Central Site Hardware	1
MBD Labor	1
Software	1
One-Time Other Labor Costs, Incl. Conversion	0-3
<b>Total One-time Cost</b>	<b>\$7-10M</b>
New Operating Costs, Annual	
Hardware Maint.—Central	\$.1
Branch	.2-.3
Software Maint.	.2-.3
Data Center Operations	.2-.3
Telephone	.15
<b>Total New Operating Costs</b>	<b>\$.85-\$1.15M</b>
Benefits, Annual	
Banking Operations	\$.5
Branches (labor reduction)	.8
Data Center (one less CPU)	.8
<b>Total Benefits</b>	<b>\$2.1M</b>

Table 1. It soon became apparent that it would take Bankers Trust over five years to break even on a full-function system, and that would be using the best-case numbers. The big part of the expense came from being on-line to the real files.

**Before your  
access control methods  
turn into a monster...**

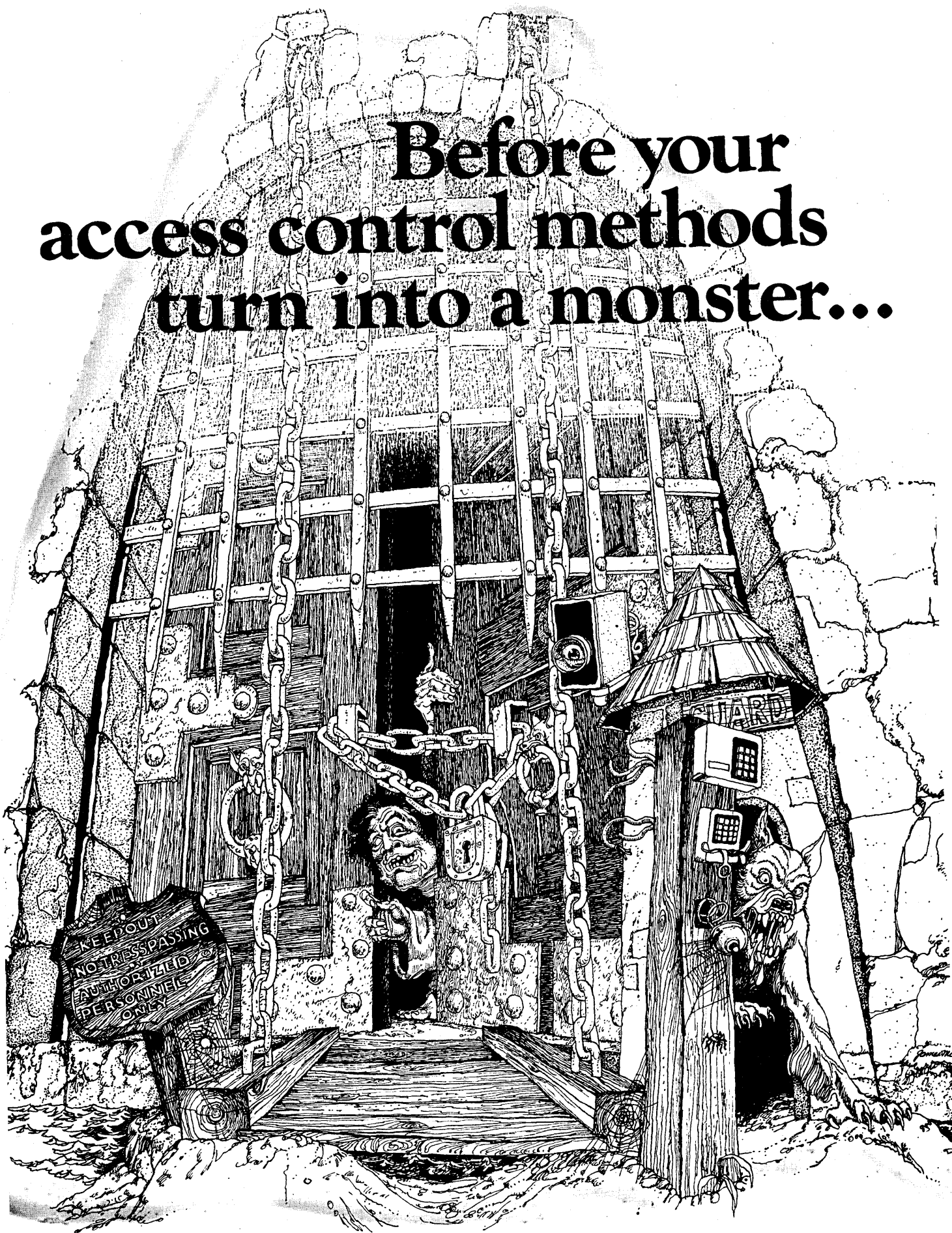

## ...Consider the hidden alternative - Schlage Electronics Access Control System

Planning and operating access controls can take on monstrous proportions—and costs! That's why Schlage Electronics has coupled over 50 years of security leadership with the most advanced electronics concepts to provide a *systems approach* to access control. The Schlage system operates by proximity. A hidden sensor reads an electronically coded credit-card-size command card and transmits signals to a control unit which regulates valid access and invalid attempts. There are no troublesome keys, key holes, card slots, or push buttons that can be subject to vandalism or abuse. Before you buy or specify another piece of equipment for controlling access to parking areas, perimeter doors, computer rooms, elevators, or other sensitive areas, consider the "hidden alternative" from Schlage. We'll send you details on the systems approach that takes the nightmares out of access control. Call toll-free (800) 538-1755. In California (408) 736-8430.

### SCHLAGE ELECTRONICS

A Schlage Lock Company  
1135 E. Arques Avenue  
Sunnyvale, California 94086  
(408) 736-8430



LIKE A FREE PRINT of this cartoon illustration, suitable for framing and adding your own caption, and without advertising message? Just write on your letterhead to Schlage Electronics.

## FINANCIAL REALITIES

issue plastic identification cards, called Pass-key cards, to each of our checking account customers. The cards are used for customer identification, and contain encrypted versions of the checking account numbers on the mag stripe—which relieves the teller of having to key them.

This system has come to be called ACCESS, Automated Customer Communication and Electronic Service System. ACCESS was not cost-justified and is not now cost-justifiable. Rather, its justification is to establish competence in new (electronic) ways of doing business, at minimum cost, and to show our employees and customers some modern improvements. The expenditure is viewed partly as an alternative to other forms of *advertising*.

In November, we put out a request for quotation to several vendors, asking for hardware and packaged software to provide the "inquiry and hold" and other transactions. By mid-December 1976, the project had chosen the vendor, the only one which seemed able to offer a proven software package, a simple system which could be implemented on a tight schedule, the right hardware delivery schedule, and an affordable price.

Meanwhile, task force members began preparing the functional specification for the system, showing exact transaction input formats, responses, keyboard layouts, error recovery requirements, fallback procedures, etc. Funding approval to proceed was given in mid-February, with a target date of live operation in October. We knew that this was a tight schedule, and made conscious efforts to trim the size of the job to the available time. Nevertheless, we found ourselves working at the maximum rate for that entire period.

The hardware system is shown in Fig. 1. Some 121 locations (branches and processing centers) are served by 18 1200baud asynchronous multidrop lines. The telephone lines can be switched between cpu's in any configuration, although the software design defines two fixed groups of lines which must be switched as units.

There is a maximum of 30-odd terminals per line, with a total of 416 terminals in the network. The terminals are Burroughs TT602-2s, which have 10 numeric keys, 11 user-defined function keys for transaction entry, and a 16-digit display. The terminal stores up to 150 characters of data which is transmitted in one block during input or output. There is a "page" key allowing the user to search through the data that has been keyed or the response sent by the cpu. The terminal also contains a magnetic stripe reader for plastic cards.

The telephone line configuration and

the number of terminals per line were chosen with the aid of a Burroughs simulator package (SPARTAN), and live operation has shown no problems with the resulting configuration. The central site hardware was simulated also to assure adequate transaction rate capability.

The central site consists of two Burroughs B2700 processors, each with dual channels to a common 180MB of

23msec fixed-head disc, one channel to six common tape drives, plus a card reader, printer, and console. Either or both cpu's can be used in the on-line system as both are dedicated to ACCESS.

The transactions chosen are shown in Table 2. They are symmetrical transactions for savings accounts and checking accounts.

The data base is derived from the overnight batch processing runs (the

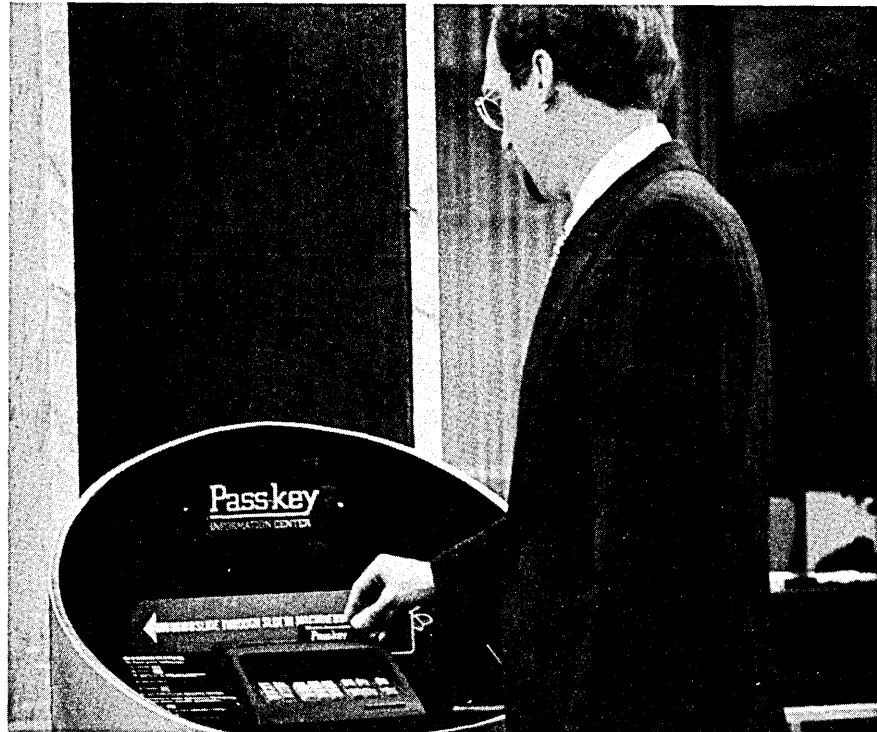

Customers' accounts were put on-line with Bankers Trust's inquiry-and-hold system. Now individuals may check the status of their accounts through terminals in the bank branches using Pass-key cards. (The cards have a magnetic stripe with an encrypted account number.) Tellers have similar terminals for recording the day's transactions.

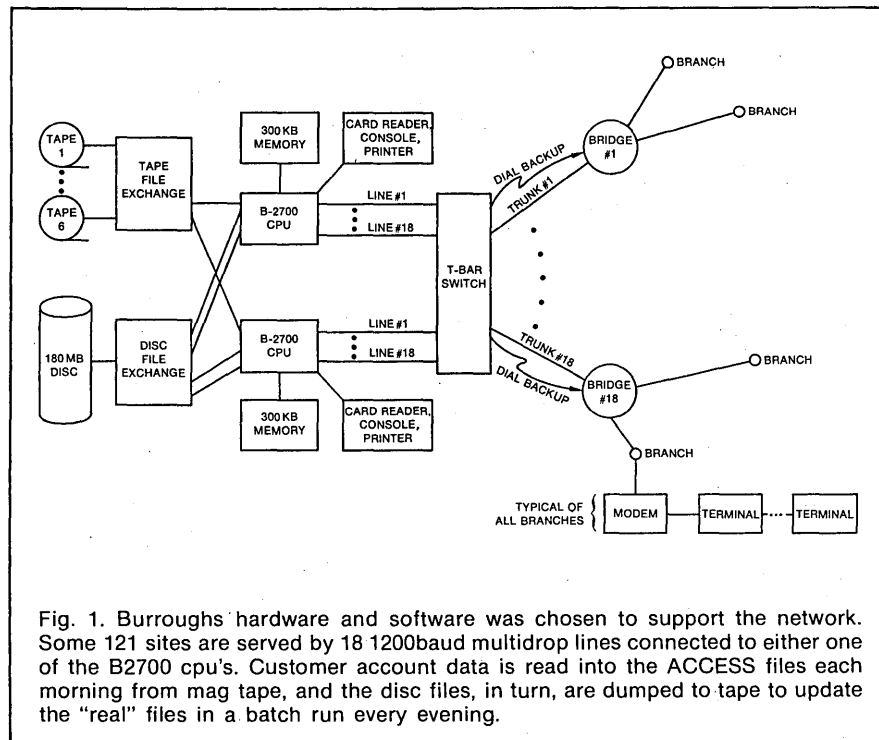

Fig. 1. Burroughs hardware and software was chosen to support the network. Some 121 sites are served by 18 1200baud multidrop lines connected to either one of the B2700 cpu's. Customer account data is read into the ACCESS files each morning from mag tape, and the disc files, in turn, are dumped to tape to update the "real" files in a batch run every evening.

legal records of the bank) and transferred by magnetic tape to ACCESS each morning. There, the balances are decremented during the day's business, and the file discarded at the next successful morning update.

### Staffing for coordination

The implementation team's size was purposely held down to reduce communication problems and cost. In retrospect, it was too low; we could have used one more person in each of technical writing, batch interface software development, and in the procedures and training areas. We had no backup personnel and were fortunate that no personal problems kept individuals from working. In addition, we asked people to postpone vacation time until it was convenient for the project, and a lot of evening and weekend time was put in by all hands.

Since MBD and CSD occupy separate buildings about a half-hour apart, the question of where to locate the task

force came up at various times. Initially, the personnel were split between the two locations. In early 1976, we recognized that this separation was causing an "us" versus "them" problem, and the group was consolidated at the user's site. This arrangement lasted until the spring of 1977 when it became important to be close to the computers and the entire task force moved to the development site. This was probably the first time that user personnel had taken up residence in the technology department. Without this move, our chances of performing would have been severely impacted; no telephone system can compete with being able to walk into a person's office and get a question answered.

One of the major questions we faced was how reliable to make the communication network. The specific questions were whether to provide dial backup or network diagnostic equipment to isolate line faults to the various vendors. Dial backup was provided for the 16

largest branches and for all trunks to the remote hubs (where the trunks fan out to individual branches).

Another question concerned how many terminals to install (resolution: one for two tellers in busy offices, down to one for five tellers in other offices).

### The project is the people

Due to the relatively small size of this project, we were able to use simple tools to control and measure progress. A PERT technique was used for charting major tasks, supplemented by a "to-do" list of lesser items, and both were reviewed every 7 to 14 days at project review meetings.

The PERT chart had activities as nodes, with each node giving the name of the task, people responsible, planned start and end dates, and actual start and end dates. It was maintained by hand by the project secretary, for a total cost of 2 to 4 hours per week, plus \$600 in reproduction expenses.

The action item list was a memo pad of critical but small tasks that were pending for project members. Each entry gave the task name, person responsible, due date when we knew one, and resolution of the task when completed. This list was also reviewed and updated at every project review meeting; old items were crossed off and new ones added without retyping.

In addition to these activities, there was a weekly review with Burroughs to check on hardware progress. Initially, these addressed delivery schedules, installation plans, and terminal preparation. In the operational environment, they now emphasize reliability, maintenance activities, and hardware upgrades.

We were fortunate in having superior technical people on the project: both CSD and MBD were determined to have a success, and contributed good people to the effort.

One person did the entire on-line software development, using the structure of the Burroughs RIS software package, but actually recoding it. From a start in April, we were running test transactions in July. There followed several weeks of intensive but informal testing-and-repair effort—running test transactions during the day and repairing the software at night. During this testing, we corrected errors in the functional specification (either ambiguously defined requirements or requirements that looked good on paper but not in practice) and in the code. After about two weeks of this, we had a pretty stable but not fully accepted on-line system.

Two people developed the batch-to-ACCESS data base conversion software. This included extraction of the batch system files, format conversion, and loading of these files on the Burroughs side.

Transaction	Information provided
Checking account balance inquiry	available balance overdraft line available balance total available balance checking account book balance
checking account uncollected-funds inquiry	for one day for two days beyond two days
checking account hold placement	notifies teller whether account has sufficient funds to cover a check presented for cashing
checking account hold inquiry	total number of holds placed total amount of holds placed
savings account balance inquiry	total available balance computer balance passbook balance penalty closeout amount
savings account unavailable inquiry	total unavailable funds except legal, collateral, or administrative holds legal, collateral, or administrative holds
savings account hold placement	notifies teller as to whether account has sufficient funds to cover a withdrawal
savings account hold inquiry	total number of holds placed total amount of holds placed
display last hold	amount and account number of last hold placed from a terminal

Table 2. The system actually implemented performs only about 25% of the functions initially specified for a full-blown version, but they're the most important 25%.



# The new DEC SYSTEM-2020 mainframe.

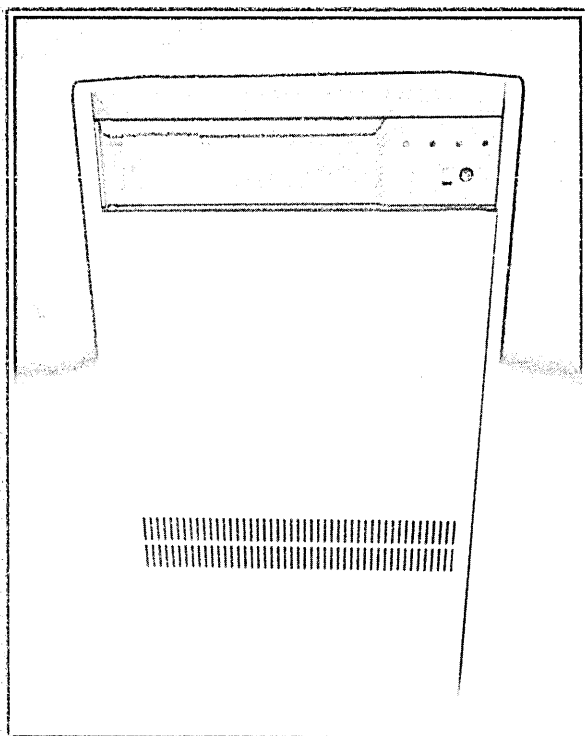

# Surprisingly easy to use.

The new \$150,000 DECSYSTEM-2020 is more than the world's lowest priced mainframe.

It's also the easiest to use.

The secret is in the software. The TOPS-20 virtual memory operating system and the high-level language compilers. The same proven software that runs on our larger DECSYSTEM-20 family mainframes. Designed from the start to let both skilled and unskilled programmers learn quickly, get more work done, and make fewer mistakes.

Here's what you get:

**Unique PUSH/POP commands.** PUSH lets you interrupt what you're working on and go to new programming — as many times as you like. It gives you essentially another virtual machine. POP gets you back to the previous program.

**Interactive debugging** at the source language level at run time without recompilation. And you debug in English, not octal like other systems.

**Superior tutorial aids.**

If you have a rough idea of a command, you can type in an abbreviation and the system will list all similar ones. When you recognize the command you want, you just type it in. You can abbreviate commands you're expert at, and get instant help when you're unsure. So you can use the system without the manual in your lap.

**Fewer keystrokes.** Most commands require an absolute minimum number of keystrokes — an

average of 40% fewer than our nearest competitor.

**Forgiving operation.** You can get out of an editing session and have the system ignore the changes you made. You can even *un*-delete a file you mistakenly got rid of.

**Unified user interface.** And all these user interface features look the same to the programmer regardless of the language or application software.

All of which makes the DECSYSTEM-2020 as easy to use as a programmable calculator.

Since the DECSYSTEM-2020 is so easy to use, it can be run by the people who need it. So you don't need a whole separate operating staff. In fact, all you need is someone to mount disks and tapes, or to feed card readers and line printers. A claim no other mainframe maker can match.

In addition, batch can be run from a terminal. If there's a power failure, the system will restart itself. And with automatic SYSGEN, you don't need system wizards to configure and run the machine.

With people representing 65-70% of DP center costs, the DECSYSTEM-2020's

ease-of-use features are looking just as attractive as its incredibly low price.

To find out more, simply write us below.

**digital**  
LARGE COMPUTER GROUP

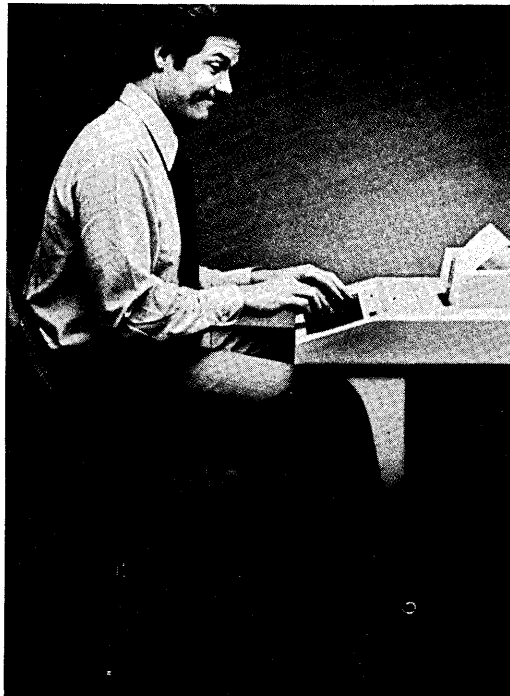

Please send your new 24-page color brochure, **DECSYSTEM-2020 — the World's Lowest Priced Mainframe.**

Please have a sales representative call.

Name \_\_\_\_\_

Title \_\_\_\_\_

Company \_\_\_\_\_

Address \_\_\_\_\_

City \_\_\_\_\_ State \_\_\_\_\_ Zip \_\_\_\_\_

Telephone \_\_\_\_\_

Send to: Digital Equipment Corporation, MR1/M-49, 200 Forest St.,  
Marlboro, MA 01752. Tel. 617-481-9511, ext. 6885.

All Digital mainframe systems are now available to qualified OEMs. A-6-8

## FINANCIAL REALITIES

Two others worked on the cardholder software to track issued cards and proper customer names.

One person worked full time on writing transaction reporting and system performance reporting software. (The functional specification contained no requirements in this area.) This person was also our Burroughs system consultant, a very valuable position to us since our technical people had no prior Burroughs experience.

The stability of the software has been impressive. We have found only two or three logic errors since the system went live, and no crashes have been attributed to the application software. We attribute this to COBOL implementation, single-threaded system, and, again, to talented people.

### Training more than 700 users

We spent a lot of effort on training branch people. One person was dedicated from May through September to developing training materials, training the bank trainers, and scheduling attendance at training sessions.

In late July we presented a slide-tape show at seven sites. This introduction showed pictures of the terminal, two typical transactions, how customers would use our plastic card, etc. Our branch training staff presented the material and discussed new manual procedures that were to be followed after ACCESS was installed. All attendees were given handouts.

Beginning in August, we ran hands-on training at three sites, three sessions per day at each, plus 40 one-day sessions at remote branches. More than 700 tellers each attended one of these sessions where terminals were available for practice. Each attendee keyed transactions and saw responses exactly as he would during live use.

As terminals were installed in each branch, they were turned on for tellers' practice. In some cases, terminals were ready for practice two months before the system became operational. In effect, we began live operation of the system well before acceptance testing had been completed.

In all, each teller received 3 to 4 hours of classroom instruction and an unknown amount of in-branch practice. We believe much of the credit for the final success of the system belongs to the training staff.

### Getting 121 sites ready

Installation of modems, phone lines, and terminals in every branch was a major effort. The first step was to survey all branch sites, producing a floor plan sketch of the branch to show all equipment locations. About three man-months were required for this.

These plans were then given to our vendors. One bank person coordinated the vendors' work at every branch, using a master schedule sheet. Installation planning started in May, and the last terminal was installed in late September.

We used a general contractor for the physical branch modifications, which included adding another 110v line in 75% of the branches, building mounting plates for the modem and shelves for the power supply for each terminal, modifying dividers between adjacent tellers, drilling holes for cables, etc. These costs averaged \$260 per terminal installed. Initially, there was some concern about construction people working in the branches during customer hours. This proved not to be a problem, and all work was done during the normal day shift.

Equally important was the central site telephone and computer center installation, which required review and modification of space, power, and air conditioning. Considerable effort was expended in acceptance testing of the new equipment, as well.

Telephone network installation and testing was handled by the bank's own telecommunications department staff. In coordination with the telephone company, they designed the network, tested the lines and modems, rerouted where original lines were of poor quality, etc.

Preparation of each terminal prior to installation at the branch was done at the bank's central facility by Burroughs' personnel. This included strap-

### An exhaustive test would take 200 million cases; we settled for 800.

ping the terminal options and testing each unit. A bank person was responsible for controlling this activity.

As part of installation, data center procedures had to be developed for governing mag tape exchange among ACCESS and both the 370 batch systems and the plastic card embossing center; and for shipping reports to users.

The users created many of the acceptance tests and participated in their execution and error analysis.

For the on-line system, some 800 transactions constituted the acceptance test. (We estimated that there are about 200 million cases to do an exhaustive test.) The test was broken into five parts, and in each case, we reran each part until the whole thing worked. The parts tested:

- the on-line transactions with normal morning data base update, to determine that the normal case works properly
- a limited set of on-line transactions with a late data base update, to determine that prior holds are carried

forward properly

- the same limited set of transactions over a three-day span which is short one data base update, to determine that the correct holds are carried forward

- a limited set of transactions spanning an artificial system crash and switch-over to the other cpu, to determine that the system can be restarted under a "best case" outage

- "simultaneous" transactions entered from multiple terminals on each cpu against the same account, to determine that the arbitration logic for simultaneous disc file access works properly.

For the cardholder system one set of 220 transactions was used, in a mode similar to the on-line tests. Again, only a fraction of the possible cases could be tested.

An exception to this process was the transaction rate test. This was prepared at the users' request, but executed without direct user involvement. We used one cpu to drive the other, connecting the two through null modems (hardware that simulates modems). The system's audit log was then used to measure the achieved transaction rate. This was a valuable test. It immediately pointed to a need for more core memory (to reduce the number of overlays), and this observation has been confirmed in live operation.

### Bringing up 30 sites per week

At the conclusion of most of the acceptance tests, but driven also by schedule commitments, we began to bring the branches up for live use. A schedule for all branches was published, with a target of 45 branches per week: 15 each on Tuesday, Wednesday, and Thursday (slack days). One week in advance of its go-live date, each branch was warned of the need for every teller to spend some time practicing transactions. On the first day of live operation in each branch, we had a trainer on-site to assist in resolving problems. We had established by that time a central trouble desk for all operational problems: hardware, procedures, etc. All branches were directed to call there for support, and it was heavily used; four incoming lines and three people were required to handle the load throughout the five week period during which the branches were put on-line.

We actually brought up 26, 29, 36, 15, 8, and 7 locations per week (103 branches, 9 regional processing centers, and 9 other sites). There was some reshuffling of the schedule during that time to work around individual branch problems. Our original four-week schedule extended to six.

We had one tremendous piece of luck: our plastic card issuing process was unable to meet our initial schedule.

# The \$6,000\* DP Center.



## IMSAI Introduces the VDP-80

Until now, owning real computing power meant paying unreal prices. Announcing the IMSAI VDP-80 Video Data Processor, a complete computer, intelligent terminal and megabyte floppy disk mass storage system. All in one compact cabinet. All for just \$5995\*. A complete desk top DP center.

For small business applications, the VDP-80 places a stand-alone computer at your fingertips. And, our full line of add-on peripherals, assures that the system can be expanded as your needs do.

For the large business user, with an existing central mainframe, the VDP-80 is the ultimate remote processor. You have the advantage of powerful local processing capability, plus the epitome in cost-effectiveness for implementing a distributed data communications network.

Take a close look at the following features. Then you'll know why we call our VDP-80 the desk top DP center.

□ **Powerful, High-Speed, Central Processor.** 3 mHz Intel 8085 microprocessor. 32K RAM memory (expandable to 196K). Parallel and serial I/O. Asynch, synch and bisynch communications. Programmable baud rates (.05-56 KB).

□ **Megabyte Mass Storage.** PerSci dual floppy, double density disk drive standard. One million byte storage capacity. Three floppy disk drives can be added-on, providing 4 million bytes of on-line storage.

□ **Drives Printers, Plotters, Terminals, Modems and Tape Drives.** Supports up to six terminals or modems, and four tape drives. Drives plotters, serial printers and line printers (up to 300 lpm).

□ **12" CRT, 24x80 Field, User Programmable Font.** Character and line insert/delete allows fast program correction and text editing. Inverse video and programmable field allows highlighting or enlarging graphics of information display. Titled fields protect information blocks from being written over accidentally. Programmable font (up to 256 different characters) allows foreign language and special purpose character forms.

□ **Alphanumeric Intelligent Keyboard.** 62-pad main keyboard. Programmable 12-pad numeric keyboard. 12-pad control keyboard. Standard typewriter and calculator keyboard layouts. "N" key roll over reduces operator error during high-speed data entry.

□ **Commercial BASIC, FORTRAN IV, DOS Software.** Built-in ROM monitor allows extensive debugging and diagnostics. BASIC, interactive or compiler version. FORTRAN IV level 2 ANSI compiler. DOS-enhanced CP/M.\*\*

Distributed processing, financial reporting and analysis, word processing, whatever your application, the VDP-80 is your answer.

**Dial (415) 483-2093, and we'll tell you how you can put our \$5995\* DP Center on your desk top. When it comes to small business computers, Just Ask IMSAI.**

\*Base price VDP-80/1000, \$5995, with 32K RAM memory and dual double density floppy disk drive. U.S. Domestic Price Only. Features and prices subject to change without notice.  
\*\*CP/M is a trademark of Digital Research Corporation.

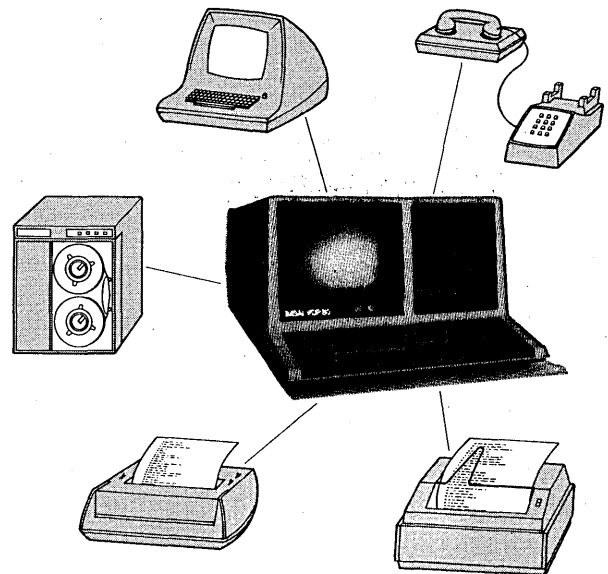

**IMSAI®**  
The Standard of Excellence  
in Microcomputer Systems

IMSAI Manufacturing Corporation  
14860 Wicks Blvd.  
San Leandro, CA 94577  
(415) 483-2093 TWX 910-366-7287

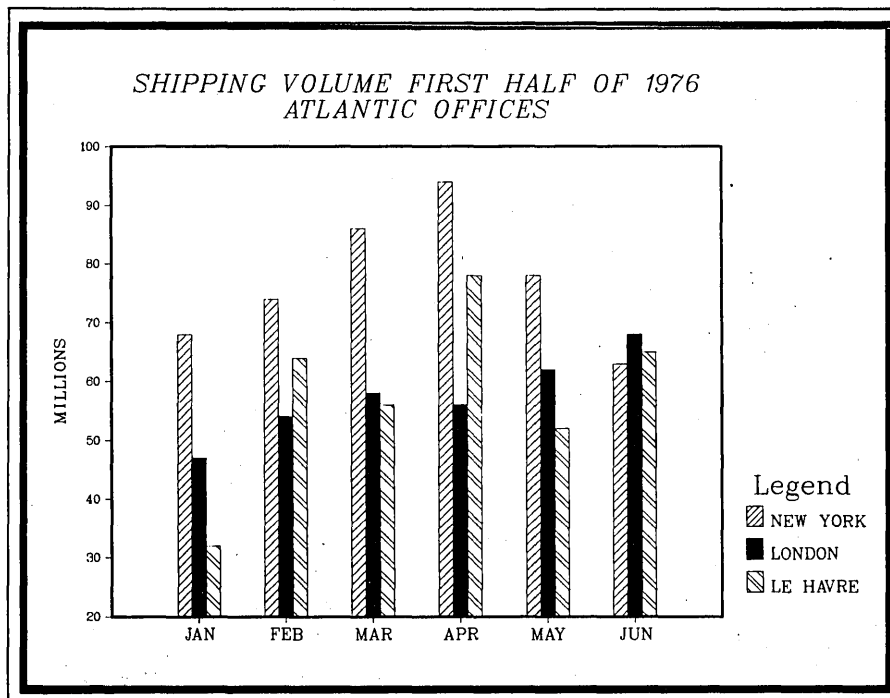

To generate this graph with  
**TELLAGRAF**™ software, the only  
 language you need to know is  
 English.

Give management a break. Translate your company's statistical reports into easy-to-read charts. With **TELL-A-GRAF**, bar, line, and pie charts are created with simple English sentences, like "GENERATE A MONTHLY BAR CHART." Even ad-libbing is allowed—if **TELL-A-GRAF** doesn't understand, it says so, in English.

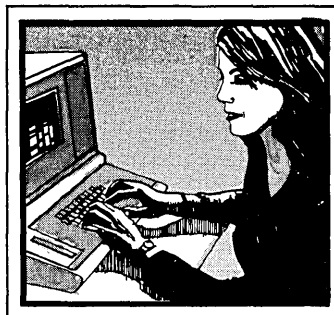

worldwide, is available for virtual storage IBM machines. Ask us about other versions under development.

Visualize your business with **TELL-A-GRAF**.

**The only language you need to know is English.**

Sixty-eight standard business graphs are built in. You can try out several graph types and pick the one that best highlights your data. Additional flexibility is achieved through a system of overrides and options which transform standard graphs into intricately tailored plots.

**TELL-A-GRAF** will chart on any graphics device: CRT, pen plotter, electrostatic printer/plotter, or COM (microfilm) recorder.

**TELL-A-GRAF**, based on the **DISSPLA**® system which is in use at over 140 installations

**TELLAGRAF**™

Data Representation Graphics Software  
 A proprietary software product of ISSCO

For information call Sunny Harris (714) 452-0170  
 or write

**ISSCO**®

**Integrated Software Systems Corporation**

4186 Sorrento Valley Blvd., Suite G, San Diego, California 92121

In Washington, D.C. contact: **Applied Urbanetics, Inc.**  
 1701 K St., NW, Washington, D.C. 20006, Telephone (202) 331-1800

In Europe contact: **Repko b.v.**, van Blankenburgstraat 58  
 The Hague, Holland, Telephone 070-608425



## FINANCIAL REALITIES

Items	%	Comment																																																
3,837	13%	Overhead Transactions																																																
		<table border="1"> <thead> <tr> <th>Items</th> <th>%</th> <th></th> </tr> </thead> <tbody> <tr> <td>2,302*</td> <td>8%</td> <td>miskeyed</td> </tr> <tr> <td>752</td> <td>2%</td> <td>sign on</td> </tr> <tr> <td>284</td> <td>1%</td> <td>sign-off</td> </tr> <tr> <td>187*</td> <td>1%</td> <td>trans before sign-on</td> </tr> <tr> <td>311</td> <td>1%</td> <td>customer-operated</td> </tr> <tr> <td></td> <td></td> <td>lobby terminal errors</td> </tr> <tr> <td>1</td> <td>0%</td> <td>change date too early</td> </tr> <tr> <td>3,837</td> <td>13%</td> <td></td> </tr> </tbody> </table>	Items	%		2,302*	8%	miskeyed	752	2%	sign on	284	1%	sign-off	187*	1%	trans before sign-on	311	1%	customer-operated			lobby terminal errors	1	0%	change date too early	3,837	13%																						
Items	%																																																	
2,302*	8%	miskeyed																																																
752	2%	sign on																																																
284	1%	sign-off																																																
187*	1%	trans before sign-on																																																
311	1%	customer-operated																																																
		lobby terminal errors																																																
1	0%	change date too early																																																
3,837	13%																																																	
4,125	15%	Savings inquiries and holds by teller																																																
18,234	64%	Checking inquiries and holds by teller																																																
		<table border="1"> <thead> <tr> <th>Checking</th> <th>Savings</th> <th>Comment</th> </tr> <tr> <th>Items</th> <th>%</th> <th>Items</th> <th>%</th> <th></th> </tr> </thead> <tbody> <tr> <td>2,975</td> <td>10%</td> <td>619</td> <td>2%</td> <td>holds less than \$50</td> </tr> <tr> <td>2,502</td> <td>9%</td> <td>578</td> <td>2%</td> <td>holds \$50.00-\$99.99</td> </tr> <tr> <td>4,248</td> <td>15%</td> <td>1,443</td> <td>5%</td> <td>holds \$100.00-\$299.99</td> </tr> <tr> <td>1,914</td> <td>7%</td> <td>330</td> <td>1%</td> <td>holds \$300.00-\$999.99</td> </tr> <tr> <td>678</td> <td>2%</td> <td>165</td> <td>1%</td> <td>holds greater than \$1,000.00</td> </tr> <tr> <td>12,317</td> <td>43%</td> <td>3,135</td> <td>11%</td> <td>all holds</td> </tr> <tr> <td>5,917</td> <td>21%</td> <td>990</td> <td>3%</td> <td>inquiries</td> </tr> <tr> <td>18,234</td> <td>64%</td> <td>4,125</td> <td>14%</td> <td>all teller transactions</td> </tr> </tbody> </table>	Checking	Savings	Comment	Items	%	Items	%		2,975	10%	619	2%	holds less than \$50	2,502	9%	578	2%	holds \$50.00-\$99.99	4,248	15%	1,443	5%	holds \$100.00-\$299.99	1,914	7%	330	1%	holds \$300.00-\$999.99	678	2%	165	1%	holds greater than \$1,000.00	12,317	43%	3,135	11%	all holds	5,917	21%	990	3%	inquiries	18,234	64%	4,125	14%	all teller transactions
Checking	Savings	Comment																																																
Items	%	Items	%																																															
2,975	10%	619	2%	holds less than \$50																																														
2,502	9%	578	2%	holds \$50.00-\$99.99																																														
4,248	15%	1,443	5%	holds \$100.00-\$299.99																																														
1,914	7%	330	1%	holds \$300.00-\$999.99																																														
678	2%	165	1%	holds greater than \$1,000.00																																														
12,317	43%	3,135	11%	all holds																																														
5,917	21%	990	3%	inquiries																																														
18,234	64%	4,125	14%	all teller transactions																																														
2,245	8%	Checking inquiries by customers																																																
28,441	100%																																																	

Table 3. More than 28,000 transactions per day are now processed by the system.

We had scheduled the system turn-on and first receipt of cards by customers to be simultaneous for best marketing impact. When cards started arriving in customers' hands we received a sizable number of calls from customers and branch people. Had this peak and the branch startup peak coincided, we would not have had enough trained people to respond.

### So far, so good

The first seven months of ACCESS operation have been remarkably smooth. Our problems were concentrated in a few areas, which, while painful, were not mysterious and were fairly readily resolved.

The single most serious problem was terminal "streaming": the case of one terminal transmitting continuously, thereby preventing communication with any terminal on that line. The problem is in the design of the firmware in the terminal. Burroughs supported us very effectively in finding ways to program around the problem at the host, and is redesigning the firmware to correct the problem.

Another potential problem, actually known before we went live, is that the network control language design and the terminal firmware design are incompatible in one area: when the network

control software fails to receive the correct response to a group poll, it reverts to a specific poll to identify the problem. The terminals are manually strap-pable to recognize either group or specific poll, but not both. This problem has had no serious impact for us, but we cannot tell at the central site when a terminal is down.

We spent several man-weeks in talking to other users of similar equipment without discovering these problems. The moral of all this: checking out vendor qualifications through other customers is of limited value unless you can find a user with a system identical to yours in size of network, exact model of terminal, exact software and release number, exact telephone physical circuit connections, etc.; and it's not an easy task to verify that the systems are identical.

We have operated ACCESS long enough to have accumulated some reasonable statistics. Based on once-a-month analysis of the transaction log, we find that: the frequency of transaction types is stable, with values shown in Table 3, and daily volume ranges between 17,000 and 28,000 transactions. The ratio of peak to average traffic, measured over 10-minute intervals, is 1.26 (we had guessed 1.6 during design), and our peaks occur at 9-9:30 a.m. and either 1-2 p.m. or 2-3 p.m.,

depending on the day.

Customer acceptance of the Pass-key card is much higher than we might have guessed it would be: 50% of all issued cards were validated within three months. (Validation requires each card recipient to appear at a branch with his Pass-key and suitable identification, proving that the card was delivered to the correct person.)

Employee acceptance of personal Pass-key cards has been particularly high because the customer-operated lobby terminals offer the easiest method for an employee to obtain his checking account balance as well.

Branch personnel have accepted the system very well. A measure is the high

**"We no longer get checks we cashed at the tellers' windows returned for insufficient funds."**

level of complaint whenever it's down. One spontaneous comment from the branches: "We no longer get checks that we cashed at the tellers' windows returned to us for insufficient funds."

By all reasonable standards, this project has been a major success for the bank. The system went on-line on the scheduled date, and for less than the estimated cost. Both customers and branch personnel use ACCESS and seem to receive the proper level of information from it. The software has been reliable; we have found only two or three logic errors and no crashes have been attributed to it.

In short, falling back to something less than a full-blown system hasn't been painful at all. \*

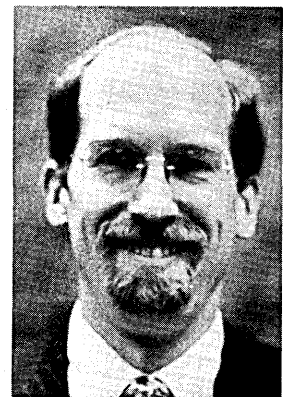

Mr. Chapman is project director for retail banking at Bankers Trust. His efforts are aimed primarily at reducing the cost of providing banking services, and thus he was the leader for the ACCESS development project chronicled in the text.

He came to Bankers from a position as vp of engineering for Compata, Inc., in Los Angeles, and before that had been a member of the technical staff at Xerox Data Systems.



The reason Epoch 4 has made it to the top in the Netherlands is because it deserved to.

## Quality. When you have it, the world finds out fast.

When you're moving into the future as fast as the Netherlands, you use a lot of computer tape. And you quickly find out which ones deliver and which ones don't.

When Graham introduced Epoch 4

several years back, we promised a tougher tape, a fully certified tape, a tape that would guarantee more throughput, and less downtime and overtime.

And we've delivered on those

promises. So much so that we've delivered millions of reels of Epoch 4 all over the world.

Epoch 4 is the patented one. The one that's proven itself through billions of passes.



**GRAHAM MAGNETICS** *Proven around the world.*

Graham, Texas 76046

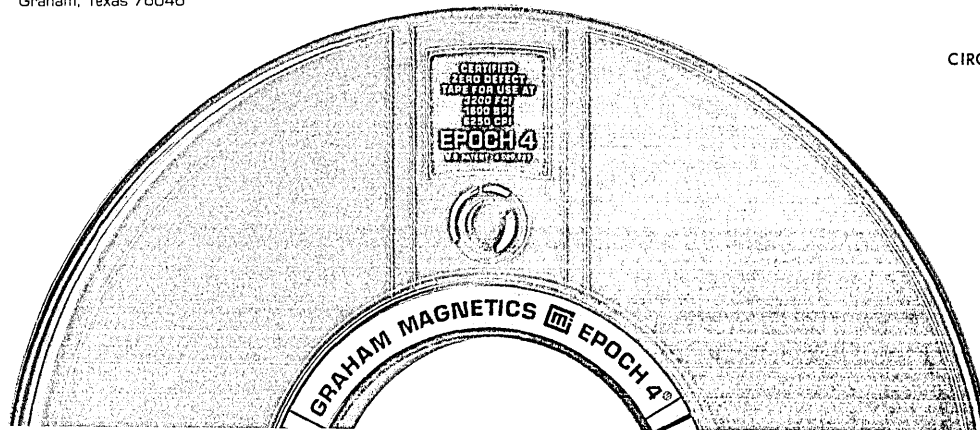

CIRCLE 44 ON READER CARD

# Integrating Text and Data Processing on a Small System

by Thomas Plum

---

If records of data can be made to look like lines of text, then a text editor can be made to look like a data base management system.

---

As computing power grows continually cheaper, a certain dream recurs in the musings of the decision-maker: one's own system with no interminable delays in defining and creating new data bases and applications. A system so readily accessible that it could really eliminate a growing pile of paper reports by keeping them all on disc or tape. One simple enough to prevent unpleasant surprises.

To avoid having that small system dream become a nightmare—which it easily can do—we must face two trends existing in larger systems: (1) software costs are increasing while hardware costs decrease; and (2) maintenance and modification costs grow to become the major component of those software costs.

I'm afraid these same maintenance cost problems will overtake many small systems being developed today simply because they so often follow a pattern inherited from maintenance prone, tightly coupled large systems: the programs embody many detailed assumptions about the data they process.

A fundamental observation is that maintenance and modification costs are minimized by building with highly independent modules which perform their application functions with the least possible coupling. In many large systems, programs and data can be decoupled by

using a data base management system (DBMS). Unfortunately, such systems are sizable and not available for small cpu's. Even if available, a DBMS would be an expensive investment for a decision-maker who has only occasional use for data management facilities. Also, the data format used by most data base systems is incompatible with the formats used in most text processing systems; so if data and text processing are linked for that "dream" system, extra processing is required in going from one to the other.

## It can be done

A system developed this past year for internal use at the New York office of

---

In all cases, the system which is simplest for its human users will be the cheapest in the long run.

---

Yourdon, inc. took what we think is a new approach to merging text and data processing while reducing data dependent maintenance. Our approach was actually twofold. First, to maintain for-

mat compatibility between text and computational processing, the data is recorded in text form; that is, records in a file become lines in text. Second, to decouple the programs from the data, each record (line) contains self-defining field descriptions.

The concepts of the system are general and simple enough that anyone with a minicomputer or even hobby computer could construct a similar one using only a text editor and a few general purpose utilities. Once constructed, there will be lots of uses. Within this year, many applications have found a home on ours, including:

- *Printing:* Several books have been typeset (including program listings).
- *Accounting:* Accounts receivable are maintained on-line; invoices are produced in daily batches.
- *Data entry:* Registration (the "order entry" of our seminar business) is also done on-line.
- *Information retrieval:* This has taken the form of bibliographies on several topics.
- *On-line management information:* Our "mailing list" is continually

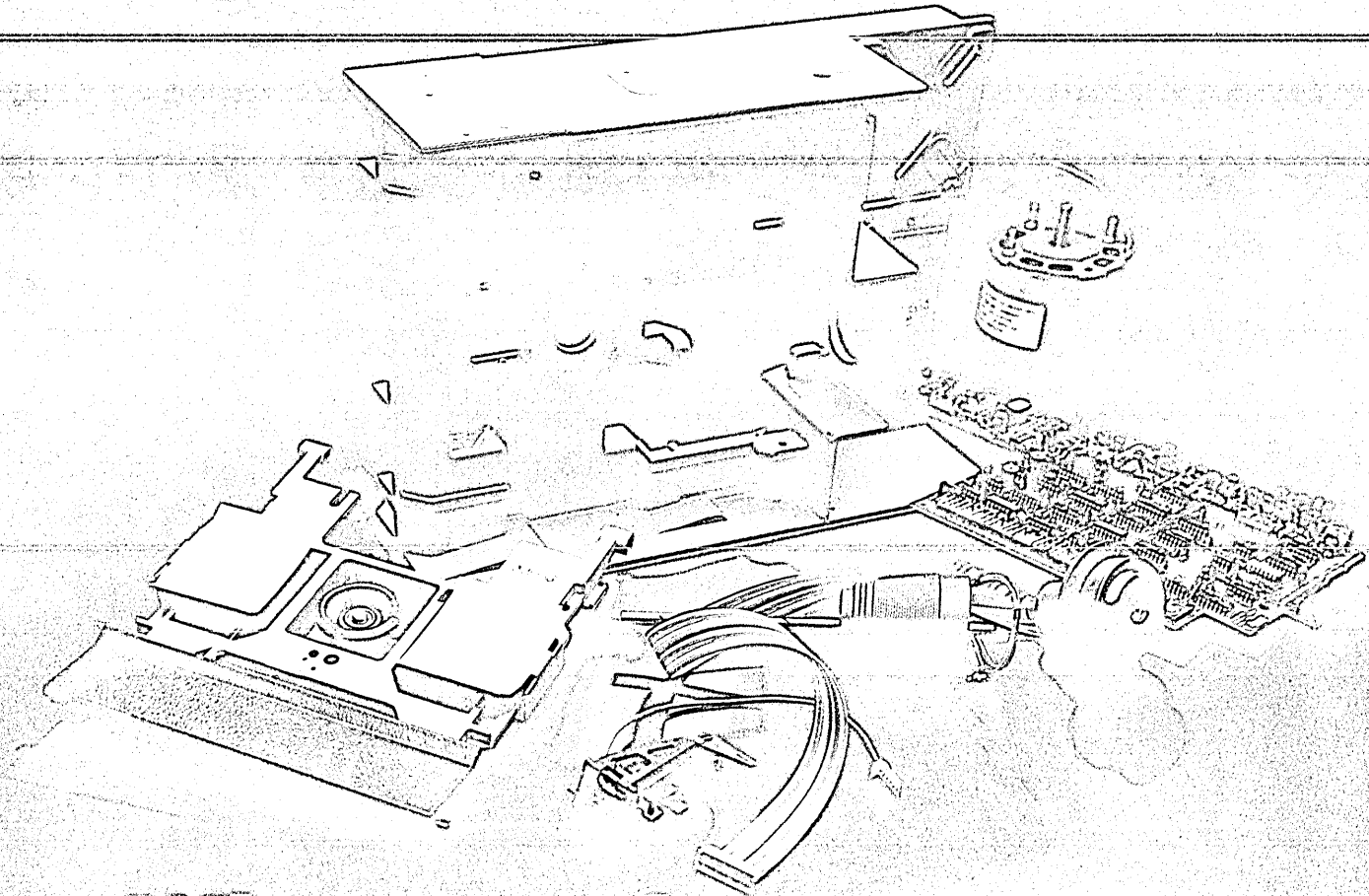

# When you break down you see why it's so hard to slip. Something special for PDP.

When the Remex III disk system was introduced, all the talk was about the accompanying software.

Like how we can pack more data per disk and accomplish fast block transfers. IBM compatibility. Software that's easy to use and more.

But our hard wearers can always tell you the message all its own.

We feature high quality disk drive mechanical components, including precision heads with geometry identical to that of IBM.

Instead of the typical teeth-screw configurations, we incorporate a V-profile lead screw and ball bearing stylus carriage. You get faster stopping with far less friction. And no worry about register disk realignment maintenance to assure track-to-track seeking accuracy.

To precisely center diskettes, Remex has replaced the usual (and cheaper) media cone with a special flexible clutch mechanism.

Naturally, this kind of preventive engineering helps keep drives from wearing out. But more

important, it helps you get the most out of what's on the disk. By providing precise (constant) rotation and low torque start-up, you can store and retrieve data with the same ease and accuracy as a tape drive. And you can do it with a gentle touch. No need to worry about the diskette being damaged by a rough start or stop.

For ease of use, the plastic package Remex boasts for the rugged flexible disk system is packed with control electronics and up to four drives capable of over 30,000 hours of normal use. With nationwide service to back it up.

For more information, contact Ex-Cell-O Corporation, Remex Division, 1735 East Altier St., P.O. Box 019533, Irvine, CA 92713. Phone: (714) 557-6360. TWX: (910) 595-1715.

**Ex-Cell-O Corporation**

**REMAX DIVISION**

Paper isn't the only thing we look good on.

## INTEGRATING

queried and updated from a dozen terminals distributed around the office. (I put "mailing list" in quotes since this data base really records all the business information we have about the people who are our contacts, friends, relatives, competitors, etc.)

A mailing list is the clearest example of an application midway between traditional *data* processing and traditional *text* processing. Historically, it was the first major application of our system, which illustrates the capabilities of a small set of functional modules. Our first mailing list was transcribed from some 5,000 Rolodex cards. The data flow looked like Fig. 1.

This system contains all the basic components of a general record processing system:

- **Entering the data:** A typist entered the name and address information in a compact format which was expanded by using a "canned" editor script to put it into the data base format.
- **On-line queries and updates:** Corrections and changes were made directly to the file with the editor.
- **Bulk output:** The records were sorted by zip code and passed through a program to put them into the 4-across format for printing. (We used a general purpose print program for the formatting.)

One of our basic design goals was to avoid changing any programs if we added or changed a field definition of the data being stored. We achieved this variability by encoding the field description right into the data. The key idea here was to select a set of brief names for each data field (two-letter names sufficed for us) and to delimit the field names with special characters (shown here as the "colon" and "semicolon" characters).

For example, the typist's entry of

Mr. John Jones  
111 Main St.  
Ames, IA 45678

was encoded into

mx:Mr.;fn:John;ln:Jones;aa:111 Main St.;tn:Ames;st:IA;zp:45678;

### The essential tool: a smart text editor

Nowadays one can build or buy a text editor program for only a small extra sum above the cost of the underlying

equipment. (As minimum equipment to run such a program, one needs a terminal, a small computer, and some bulk storage such as diskette or tape cassettes.)

Here are some of the commands you can give to such an editor:

- **COPY:** Copy text from keyboard to a file.
- **MOVE:** Move a block of text such as "In the first place . . . not our responsibility" to a designated

---

Field descriptions are encoded right in the data lines so that the data can be decoupled from the programs.

---

place in the text. The three dots represent a special text editor abbreviation meaning "any string of text in between."

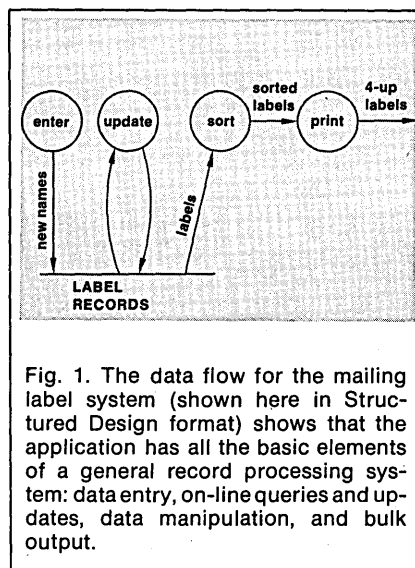

Fig. 1. The data flow for the mailing label system (shown here in Structured Design format) shows that the application has all the basic elements of a general record processing system: data entry, on-line queries and updates, data manipulation, and bulk output.

- **FIND:** Find a given pattern (such as "bouillon").
- **CHANGE:** Change a given piece of text to a new value (such as "bullion").
- **FOR ALL:** This modifier applies an editor command wholesale to an entire file, useful in correcting a consistent misspelling (as FOR ALL LINES, CHANGE "bouillon" TO "bullion") or to look at selected lines (as FOR ALL LINES CONTAINING "model x-35" PRINT).

To illustrate the usefulness of this format, we could extract a mailing list of our customers in New York by giving the editor a command to print all lines containing the characters "st:NY".

To change an address, we would locate the individual record by searching for the line that contains sufficient information to locate the individual, such as "fn:John;ln:Jones;...zp:45678". Having found the right line, a CHANGE command can replace the part of the record we want to change; we might change "aa:..." to "aa: P.O. Box 14;" for example.

To see how easily the details of this data format can be changed, consider how easy it was to add a new "history" field to record the fact that certain special mailings were sent to selected individuals. The field was added onto the records by simply finding the lines we wanted to mark, and tacking the text "hi: COBOL mailing" onto the end of the line.

To maintain consistency among the different uses of data within the office, we constructed a data field dictionary which defined the meaning of each two-letter code in the system. We have added order entry, financial reporting, and revenue forecasting into this system, with the corresponding invention of new field codes into the data field dictionary.

One important characteristic of recording data in this way is that people can read these data base records without any special conversion programs. And any special updating or patching of the files can be done directly with the editor, avoiding the extra cost of having to program such maintenance.

### Scaling up

The mailing list system shown in Fig. 1 exemplifies the skeletal systems which can be quickly created without custom programming. As our system grew, we did need custom programmed parts. These probably cost us about the same amount as if we'd used traditional dp style data with fixed formats and binary numbers, but our maintenance and modification costs for them were lower. We have changed the fields contained in the mailing list records five times so far, with more changes planned, and no program changes have been needed.

One technical detail complicated this simple picture: the size of the file. Rather than processing all 5,000 records on each pass of the mailing list, we split it into small chapters or subfiles according to the first few letters of the last-name field. This scheme—a quasi-direct access set of unsorted bins—has served adequately during the growth of the mailing list from 5,000 to 20,000 names. Had a true indexed sequential access method file-handler been available to us, we would probably have used it, while maintaining the same field encoding format for the individual records.

The most important custom programmed feature added to the system in



# TEAC MT-2: THE VALUE-PACKED CASSETTE DATA PACK

MORE PERFORMANCE FOR LOWER PRICE

## The case for digital cassette

An all-round winner, digital cassette is easier to handle, lower in cost and smaller than floppy disk. Data transfer rate is approximately 40 times faster than Kansas City Standard audio cassettes. And operating cost is considerably lower than conventional data cartridges.

## Maximum reliability

Small size is no detriment to this unit's reliability and precision. Soft error rate is better than  $1 \times 10^{-9}$  bits. MTBF is 10,000 hours—real durability, and tape-life spans an outstanding 1000 passes or more thanks to superior transport design.

## Easier maintenance

The uncomplicated structure of the MT-2 is another big plus. Two reel motors and a disc encoder are the only moving parts—fewer servicing problems, less spare-parts storage and lower maintenance cost.

## Wide-range compatibility

The MT-2 is totally compatible with ISO, ANSI, JIS and ECMA phase encoding standards. You can read tapes recorded on other machines complying to these standards, and vice versa.

## Easy microprocessor interface

The MT-2 is available in four versions, two of which incorporate a unique interface controller developed by TEAC especially for this unit. It features a simplified design, and lets you connect the MT-2 to the bus lines of 8080, 6800 and Z-80 or equivalent series microprocessors for greater flexibility and convenience than conventional, high-priced outboard devices.



**TEAC**

The model pictured here has an interface controller.

TEAC CORPORATION: 3-7-3, Naka-cho, Musashino, Tokyo, Japan.  
U.S.A.: B.J. Wolfe Enterprises Inc., 10760 Burbank Blvd., North Hollywood, Calif. 91610 England: International Instruments Ltd., Cross Lances Rd., Hounslow, Middx W. Germany: nbn Elektronik Starnberg, 813 Starnberg, Max-Emanuel-Str. 8 France: Tekelec Alrtronic S.A., Cite des Bruyeres, Rue Carle-Vernet 92 Sevres Holland: SIMAC

Electronics, Vernstraat 20, Veldhoven Italy: A.E.S.S.E. S.R.L. Corso Lodi, 47 20139 Milano Norway: Rodland & Røllismo A.S., Gladengveien 3A, Oslo 6 Sweden: Scantele ab, Tengdahl Sgatan 24, 11641 Stockholm Denmark: Danbit, Plantagevej 23, 2680 Scolrod Strand Switzerland: Wenger Datentechnik, Bruderholzstrasse 45, 4053 Basel Australia: Jacoby, Mitchell Ltd., P.O. Box 70, Kingsgrove, N.S.W. 2208

CIRCLE 103 ON READER CARD

# Racal-Milgo's new modems make sure you get every millisecond's worth from your data channels.

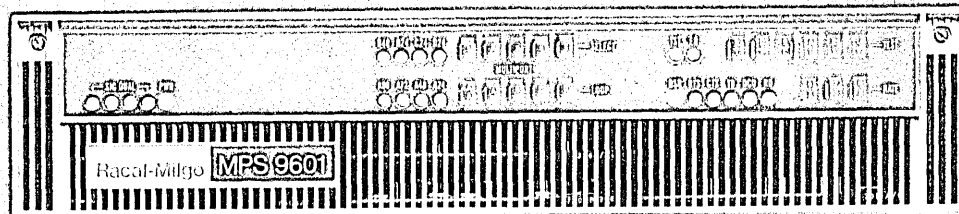

The MPS 9601 series includes 6 models of synchronous modems that deliver full 9600 bit-per-second data transmission in both point-to-point and multipoint networks. The modems offer unique cost saving advantages such as FASTTRAN™ ultra-fast 80 millisecond response time and DYNAPORT™ automatic channel allocation as well as multipoint operation and modem sharing. Models are available with CCITT V.29 modulation.

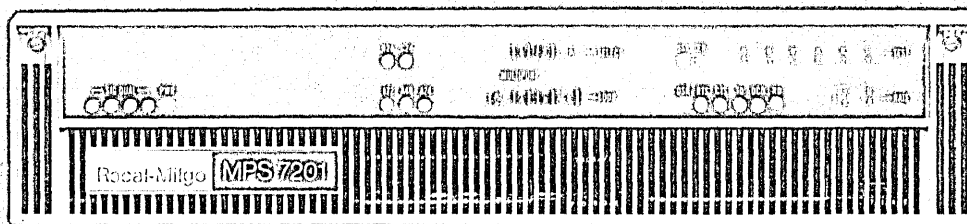

The MPS 7201 modem series provides synchronous 7200 bps data communication over unconditioned lines in point-to-point or multipoint networks. Four models offer a selection of high efficiency features that include up to three independent ports, FASTTRAN™ ultra-fast response time, diagnostics and DYNAPORT™ automatic channel allocation.

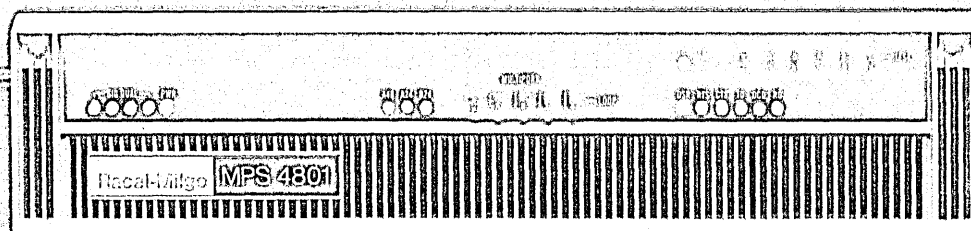

The MPS 4801 series offers optimum 4800 bps data communication over unconditioned lines in point-to-point or multipoint networks. Modems in this series are available with either a single 4800 bps data port, or with two 2400 bps ports. Cost-saving options, including DYNAPORT and FASTTRAN, are available in this series.

The exceptional advantages offered in this new series of microprocessor-based modems are fully described in our 12-page brochure. We'll gladly rush you a copy.

Racal-Milgo™ — the new name for 

 PALM  
MEMBER OF  
TELECOM FORUM

Racal-Milgo Information Systems, Inc.

8600 NW 41st Street Miami, Florida 33166 Telephone (305) 592-8600 TWX: 810-848-6588

© 1978

In Europe: Racal-Milgo Limited, Reading, Berks, England

member of  
TELECOM FORUM

CIRCLE 105 ON READER CARD

## INTEGRATING

the months after the first skeleton version was a data entry program which prompted the typist and validated the information entered. Highly accurate data entry should probably not be attempted without such a program; the editor-based skeleton system is more suited to the quick construction of a file which can be useful even if a few percent of the records contain errors.

We had frequent need of a sort program, and our test-formatted records served us well here too. The sort utility available with our UNIX operating system is text oriented in that one can specify a field-separator character to it, and it will sort by fields instead of by fixed-column locations. With minor augmentations to this sort utility, we are able to sort files by using actual field names such as "zp" for "zip code" and "ln" for "last name," such as this:

```
Sort labels BY zp ln.
```

During the first year of this system, our report generation facilities were quite primitive but highly flexible. (We are currently building a real report generator package. Like the other utility programs in the system, it will be made

considerably simpler by its independence from any specific record formats.) The typical strategy in the absence of a report writer is to select records from a file by some matching criterion, spread certain fields into a multicolumn layout

### Auxiliary custom programs probably cost the same as for "traditional" dp, but their maintenance is cheaper.

by inserting tab characters, and pass the resulting file through a program which tabulates sums of columns of numbers. This combination of utility programs produces, for example, accounts receivable reports like this:

- 1) Extract receivables using a command such as FOR ALL LINES NOT CONTAINING "ao: 0." WRITE.
- 2) Insert TAB characters to space the "amount owed" into the proper column—"two (or more) months overdue, one month overdue, current, due next month, due in two months" gives a five-month spread.
- 3) Tabulate receivables.

The output of the report looks something like Fig. 2.

Several variations of the data format described above show how the idea of human-readable data can be accommodated to different situations. Some of them use a multi-line record which requires an end-of-record character (shown here as a "box" or □). Each of them could be augmented by allowing a tag-end field as a space to insert later-invented fields such as the history field described above.

- *Fixed-length, fixed-position fields:*  
Mr. John Jones 111 Main St.
- *Variable-length, fixed-position fields:*  
Mr.;John;Jones;111 Main St.;
- *Multi-line, fixed-position fields:*  
Mr.  
John  
Jones  
111 Main St.  
□
- *Multi-line, self-describing fields:*  
mx: Mr.  
fn: John  
ln: Jones  
aa: 111 Main St.  
□

#### What It takes

Our own integrated text-and-data-processing system is implemented on a

**Still squeezing data through the old-fashioned way?**

If you would like to put up to 16 asynchronous terminals on one telephone line, read on.

MICOM's smart Micro800 Data Concentrator has obsoleted the good, old-fashioned TDM or time-division multiplexor. If you prefer to call it a statistical multiplexor or intelligent TDM, feel free. Either way, the Micro-800 provides retransmission on error and, typically, double the efficiency of TDM. It's not a penny more than a TDM, so why not order a pair on a sale-or-return basis? No strings attached.

**Concentrate. It's cheaper!**

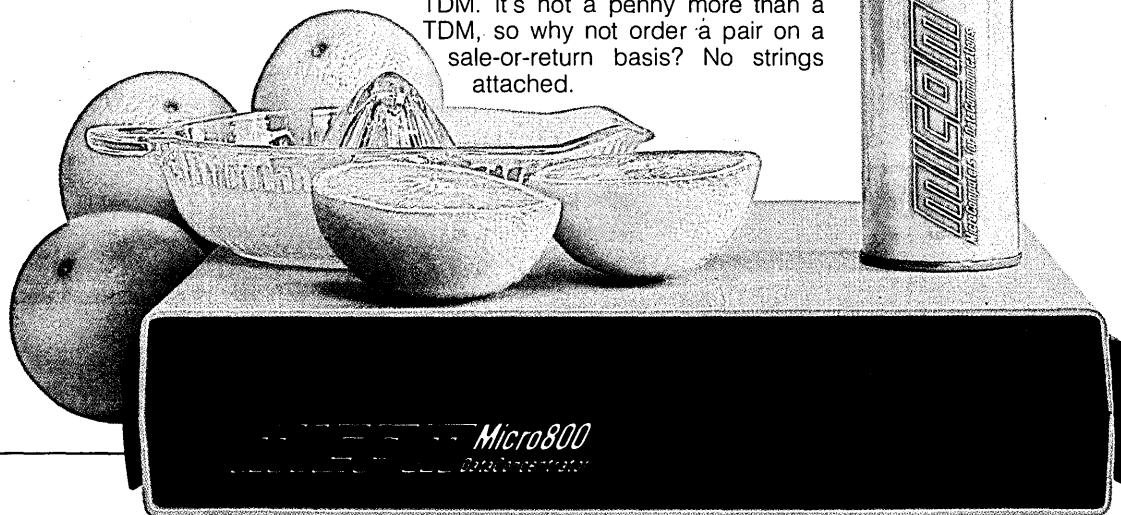

**MICOM** MicroComputers for DataCommunications

MICOM SYSTEMS, INC. • 9551 Iroindale Ave. • Chatsworth, CA 91311 • Tel. 213/882-6890 • TWX 910/494-4910  
CIRCLE 160 ON READER CARD

# Control Data's experience in Flexible Disk Drives helps bring success to OEM's

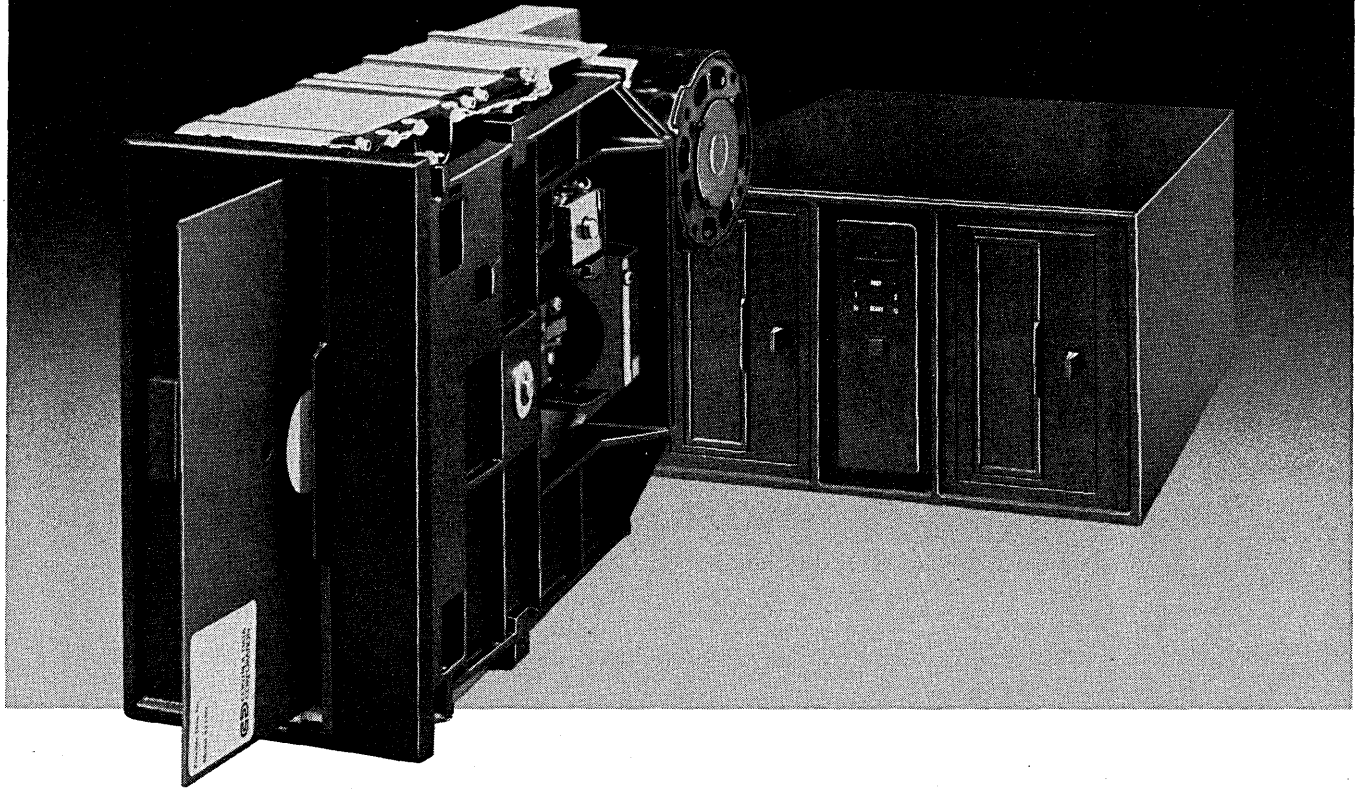

In the past two years alone, Control Data has built more than 50,000 floppies for our OEM customers. Experience and success. It means quality and reliability that you can pass along to your customer.

Control Data now offers a complete line of flexible disk drives and subsystems. From our Model 9400 first introduced in 1973 to our recently announced two-sided, double-density Model 9406.

Select the one that's right for your application:

MODEL	9400	9404	9406	9474 Subsystem
Capacity (Megabytes)	0.4	0.4-0.8	0.8-1.6	0.4-6.4
Type of Recording	FM	FM or MFM	FM or MFM	FM or MFM
IBM Compatibility	FD23	FD23	FD43	N/A
Interface	STAR	DAISY	DAISY	DAISY

Put quality behind your nameplate. Call 405/946-5421 or if in Europe, contact one of our European representatives. Or mail return coupon to:

Terry J. Hardie, Product Sales Manager  
Control Data Corporation, 4000 NW 39th  
Oklahoma City, Oklahoma 73112.

D-68

Please tell me more about your

flexible disk drives       flexible disk drive subsystems

Name \_\_\_\_\_ Title \_\_\_\_\_

Firm \_\_\_\_\_ Phone \_\_\_\_\_

Address \_\_\_\_\_

City \_\_\_\_\_ State \_\_\_\_\_ Zip \_\_\_\_\_

**CD** CONTROL DATA CORPORATION

**More than a computer company**



# Who? What? When? Where? Why?



## That's what data collection is all about.

**EPIC DATA** offers you a simple, practical, flexible family of data collection products which can economically provide you with the information you need to answer these questions. Information which allows you to create reports on inventory status, job costing, production control, payroll, maintenance scheduling, access control, equipment circulation, time and attendance, goods consignment and circulation control so that management can make better decisions to reduce costs. And thereby increase profit.

**WHO** All data collected by the system can be pre-prepared. Or, where required, you may input variable data. By simply inserting his identification badge, punched or magnetic stripe, or reading the card's bar code, your employee tells the computer who he is.

**WHAT** Job cards, bar codes or key depression — all assigned by management — tell the computer exactly what he's doing.

**WHEN** An internal clock records when he started and when he finished.

**WHERE** The location of the terminal or variable key input tells the computer where he's working while travelling cards, bar codes or key depressions on the terminal input the amount of inventory being worked on or used.

**WHY** This collected data may then be prepared into reports telling you who worked on what, when, where, how many, and, often why or why not this operation was profitable.

**CALL US TODAY.** An Epic Data representative is ready to discuss how our simple, practical, flexible data collection systems can improve your profits.

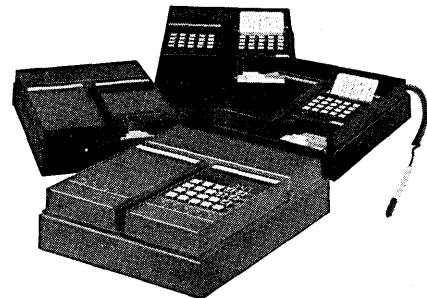

epic data

In U.S.A.: 6350 LBJ Freeway/Dallas, TX 75240  
Phone (214) 387-3121/TWX 910-860-5676

International: 7280 River Road, Richmond, B.C. Canada  
Phone (604) 273-9146/Telex 04-355701

**U.S. Sales Offices:** 6350 LBJ Freeway, Suite 282, Dallas, TX 75240, (214) 387-3121 • 3415 Hickory Trail, Downers Grove, IL 60515, (312) 968-8620 • 1724 South Heather Hill Rd., Hacienda Heights, CA 91745, (213) 965-2886

Representatives: ARIZONA BFA Corporation (602) 994-5400 • CALIFORNIA Moxon Electronics (714) 635-7600 • FLORIDA COL-INS-CO (305) 423-7615 • ILLINOIS Systems Marketing Corp. (312) 593-6220 • KANSAS/MISSOURI Digital Systems Sales (816) 765-3337 • MARYLAND TE Corporation (301) 340-0303 • MASSACHUSETTS J & J Associates (617) 729-5770 • MICHIGAN/OHIO WKM Associates, Inc. (313) 588-2300, (216) 267-0445 • NEW YORK Cane Technical Sales (914) 698-4411 • NEW YORK Ossmann Instruments (315) 437-6666 • PENNSYLVANIA WKM Associates (412) 892-2953 • TEXAS DMA (713) 780-2511 • WASHINGTON DPM Associates (206) 453-9082 • UNITED KINGDOM Sintrom Ellinor Ltd. Reading (0734) 85464



# Meet NCR's Migration Path Engineering concept for computer systems.

**It means you don't pay a penalty for success.**

Too many EDP systems prove to be blind alleys for their owners. When the need for additional power and versatility outgrows their system's capacity, they discover that the change to more capable hardware will entail sweeping software changes, too. Rewriting programming that has become obsolete overnight takes time, costs money and can disrupt their entire operation.

Not so for owners of an NCR 8000 series system. You'll pay no penalty

for success. NCR's Migration Path Engineering insures that current programs can be transferred to a more advanced configuration without revision. No need to sacrifice your current programming to gain increased EDP capabilities; your software can move up right along with you.

Avoid the pitfalls of a dead-end system. The NCR 8000 series includes a state-of-the-art system designed to meet all your current EDP needs. As your requirements grow, the ease of your eventual transition to a more powerful configuration in the series is assured. And each of

NCR's continuing additions to that series will include the far-sighted advantages of Migration Path Engineering.

For more information about NCR's Migration Path Engineering and NCR's 8000 series systems, call your local NCR representative. Or write to EDP systems, NCR Corporation, Box 606, Dayton, Ohio 45401.

**NCR**  
Complete Computer Systems

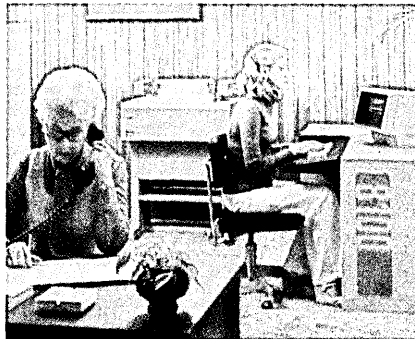

**THE 8100 FAMILY** provides interactive direct processing in low-cost, easy-to-operate desk-size models. Systems allow instantaneous entry, reporting and updating in a wide range of preprogrammed applications that are fully compatible with higher levels of the 8000 series.

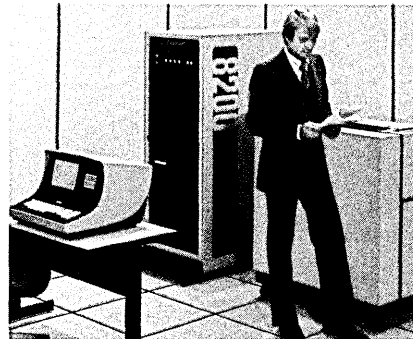

**THE 8200 FAMILY** permits simultaneous processing of multiple interactive applications. Economical, versatile and compact, each system is supplemented by a broad array of preprogrammed applications. Early return on investment and trouble-free upward migration in the series is assured.

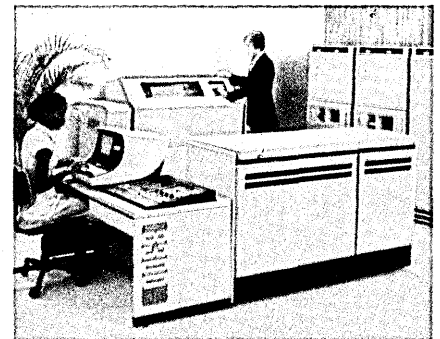

**THE 8300 FAMILY** handles conventional batch, online and multiprogram processing. Disk-oriented, modular architecture and an extensive selection of software packages facilitates full expansion to peak capacity and a smooth transition to more powerful NCR systems.



**THE 8400 FAMILY** offers the advantages of multi-mode operation. Flexible disk firmware makes the change from interactive applications to conventional processing in real or virtual memory modes quick and easy. Migration to advanced configurations poses no problem.



**THE 8500 FAMILY**, with its full complement of peripherals and terminals, provides multi-mode flexibility, distributed intelligence efficiency, online program development ability and NCR's most sophisticated, state-of-the-art operating system software.

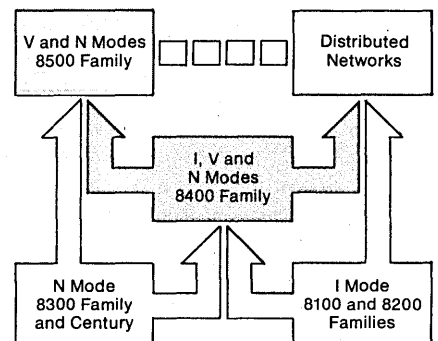

**MIGRATION PATH ENGINEERING** insures that, whatever the requirements of your expanding business, the hardware, firmware and software created for each family of NCR's 8000 series facilitates your progress toward greater EDP versatility and processing power.

# Now available: ruggedized terminals that cost less and do more.

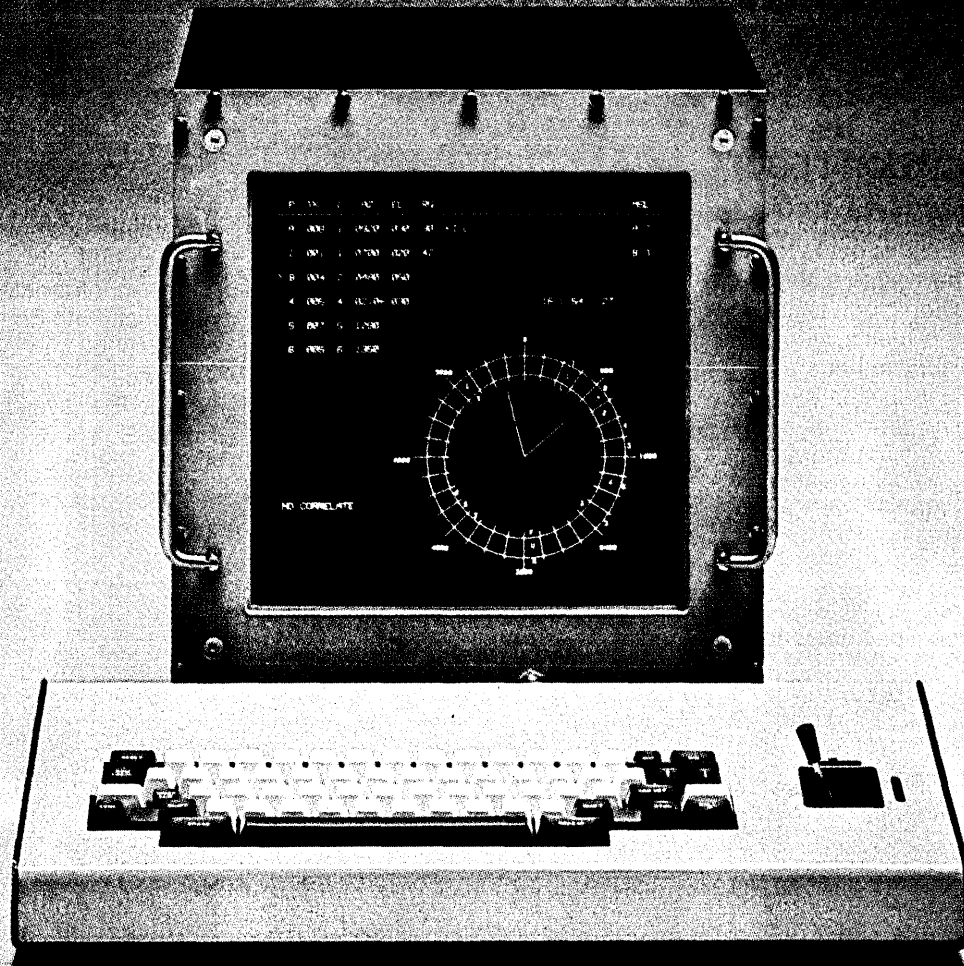

**Immediately available.** The Interstate Electronics Alpha/Graphic Model PD 3000 plasma display computer terminal. It's qualified for reliable operation in the military environmental spectrum: mobile or fixed ground, shipboard, and airborne. And the price won't strain the most rigid budget.

Costing thousands of dollars less than competitive units, the PD 3000 provides more capabilities, such as alphanumeric and graphics display—standard. Or both 5 x 7 and 7 x 9 dot matrices for character font.

Among many functions, it generates and displays all standard alphanumeric characters and complete graphics, and decodes and implements the complete ASCII character and control set. It also has a full ASCII-compatible solid-state keyboard.

This small (13" x 14" x 12", 53 lb.) unit features a flicker-free,

distortion-free flat display.

The -RFI-EMI enclosure to meet MIL-E-5400R, MIL-STD-901C, and MIL-STD-461 is standard.

PD 3000 offers high-altitude capability (20,000 ft. operating; 70,000 ft. nonoperating), high-resolution graphics, with more than 4000 characters displayed, and an operating temperature range of -32°C to 55°C.

Proven software includes a

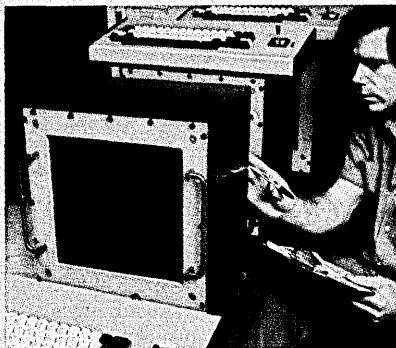

real-time/high-level macroinstruction set that provides subroutines for display control, alphanumeric display, incremental and vector graphics. Custom software and engineering are also available.

Some 200 field personnel, located worldwide, provide a major support effort.

We're delivering.

Write for the complete PD 3000 data package to Interstate Electronics Corporation, Don Poulos, Computer Products, 1001 E. Ball Rd., P.O. Box 3117, Anaheim, CA 92803.

**INTERSTATE  
ELECTRONICS  
CORPORATION**

SUBSIDIARY OF **ATC**

**Information Processing and Display.  
Systems. Products. Services.**

# INTEGRATING

REPORT OF SERIES p INVOICES RECEIVABLE AT END-OF-MONTH 7712 (I.E. START-OF-MONTH 7801)  
 THIS IS AN UNOFFICIAL PROVISIONAL REPORT UNTIL APPROVED BY ACCOUNTING DEPARTMENT  
 TODAY'S DATE IS:  
 Wed Jan 4 15:42:48 EST 1978  
 (PAYMENTS MADE DURING MONTH 7801 ARE SHOWN IN THE mp COLUMN, BUT ARE NOT REFLECTED IN THE ao COLUMNS)

ni	di	dd	am	mp	ao	<-2 mo	-2 mo	-1 mo	Current	+1 mo
p00194	771004	771104	9000.00	9000.00	9000.00			9000.00		
p00202	771006	771106	250.00	0.00	250.00			250.00		
p00215	771028	771128	12500.00	0.00	12500.00			12500.00		
p00219	771122	771222	11575.00	0.00	11575.00				11575.00	
p00226	771110	771210	1282.16	0.00	1282.16				1282.16	
p00228	771115	771215	134.99	0.00	134.99				134.99	
p00232	771118	771218	500.00	0.00	500.00				500.00	
p00235	771128	771228	800.00	800.00	800.00				800.00	
p00236	771128	771228	11575.00	0.00	11575.00				11575.00	
p00237	771129	771229	6320.00	0.00	6320.00				6320.00	
p00239	771130	771230	4500.00	0.00	4500.00				4500.00	
p00245	771209	780109	1537.50	1537.50	1537.50					1537.50
p00246	771212	780112	5500.00	5500.00	5500.00					5500.00
p00247	771213	780113	317.32	317.32	317.32					317.32
p00248	771214	780114	300.00	0.00	300.00					300.00
p00249	771214	780114	341.00	0.00	341.00					341.00
p00250	771216	780116	2037.60	2037.60	2037.60					2037.60
p00251	771220	780120	9150.00	0.00	9150.00					9150.00
p00252	771220	780120	2111.23	0.00	2111.23					2111.23
p00253	771230	780130	4603.50	0.00	4603.50					4603.50
p00254	771230	780130	3000.00	0.00	3000.00					3000.00
p00255	771230	780130	727.75	0.00	727.75					727.75
p00256	771230	780130	1545.00	0.00	1545.00					1545.00
TOTAL			89608.05	19192.42	89608.05	0.00	0.00	21750.00	36687.15	31170.90

--- END OF REPORT ---

ni = invoice number  
 di = date of invoice  
 dd = date due  
 am = amount  
 mp = this month's payments  
 ao = amount owed

Fig. 2. The typical strategy, in the absence of a report generator, is to select records by some matching criteria, spread certain fields into a multicolumn layout by inserting tab

characters, and pass the resulting text file through a program which sums the columns of numbers. The result looks like this accounts receivable report.

somewhat specialized prototyping system, a Digital Equipment PDP-11/45 running Bell Labs' UNIX operating system. Besides the applications described above, we make use of this system for the development of our proprietary compilers for the "C" language. The equipment used for all these applications includes the PDP-11/45 mainframe with 124K of core, 80MB of disc, two dozen terminals with telecommunication hardware, and a Graphic Systems Inc. phototypesetter. Total cost for a similar configuration purchased new would be around \$175,000. Excluding the book publishing applications would drop the phototypesetter from the configuration.

A system to handle the business applications (including the 20,000-record on-line data base) could be implemented on a smaller scale system such as a Datapoint 4520 with 48K of core, 5MB disc, four terminals, and a 200lpm printer for a total cost of around \$45,000.

At the small end of the scale, a similar application needing only 1,000 records on-line might be implemented on one of the many new microprocessor-based small systems such as a Datapoint 1500 with 32K of random-access

memory and 250KB on a removable diskette (all for about \$6,000).

The system described above has grown to a full on-line information system for a \$3 million per year business. The record format has served well without modifications during this growth. Its advantages of compatibility between text processing and data processing have minimized our investment in custom programming and made our data highly accessible to a staff trained mainly in the text processing facilities of the system. Data base reorganizations and reformatings have been kept to a minimum.

For the user of a basically text-oriented system (either home hobbyist system or sophisticated word processing system) with occasional data processing needs, an approach like this can provide a low cost record keeping facility. Even within a data processing environment, a record format like this can be cost-effective for applications with data field volatility or demands for quick implementation, provided that a text editor is available with the necessary features. And even the largest projects may find it of use for the creation of a breadboard or prototype system during a top-down implementation. In all cases, the

system which is the simplest for its human users will be the cheapest in the long run. \*

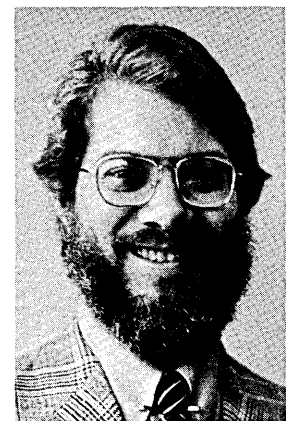

Dr. Plum is the director of application software development with Yourdon inc. He also teaches courses on system design and human factors. His dp career began with writing programs for an IBM 1401 at Wrigley Gum Co., and prior to joining Yourdon he also had been a professor at the State Univ. of New York and an officer of Ethnotech Inc.

# Monitoring Data Integrity

by Robert Fried

---

Many attempts at periodic reviews of data peter out as user checks become more perfunctory. To avoid that, provide more than just error checking in users' reports.

---

When a data system has multiple users, its validity, correctness, and completeness are often a matter of conjecture, especially when some data items tend to be reported infrequently. In a single-user application, the problem is ameliorated somewhat by the fact that the user is often aware of gaps or other anomalies and can consider them when responding to requests for information from the system. In a multiple-user environment, no such "clearinghouse" is likely to exist. In such cases, requests for information retrieval are likely to be forwarded to the data processing department or to the user who is most closely identified with the application.

The problem is often compounded when retrieval requests are routinely processed without assessment of data set condition; invalid, incomplete, or incorrect data may be used to drive program logic, causing anomalies to pervade other records or files.

One approach to solving or reducing the size of this problem is through validating input before its application to the system's files. Although quite effective (if done properly and completely), this method often fails to detect anomalies that depend on (or affect) complex interrelationships between data items, records, or data sets. Further, it sometimes may be desirable to allow erroneous input to affect the data set in some way, as in the case of an on-line, transaction oriented system when multiple transactions may be necessary to produce a valid result.

A technique frequently relied on to assure data integrity is the production of reports for periodic, exhaustive review of the data set. While this may appear moderately successful for a short period following its introduction, effectiveness rapidly declines as users tend to make their reviews more and more perfunctory and superficial. In fact, human review of actual data values can be

effective only when the data set is of both insignificant volume and trivial structure.

These realities argue for the creation of some sort of automatic, that is, programmatic, evaluation of data integrity; but this leads to another set of problems. If, as proposed at the outset, we are dealing with multiple users, who

---

## A vicious cycle: invalid, incomplete, or incorrect data often drives other programs to cause errors in other records and files.

---

will perform the review of the evaluation? If central responsibility for the data set does not exist, as is often the case, multiple users need individual incentives to review and repair problems within the data set—especially when the philosophy of the organization is that the data processing function is responsible for just the valid processing of data, and that the users, severally and individually, are responsible for correctness and completeness.

### The goals

At the State Univ. of New York Computing Center, there was general satisfaction with the quality of input validation and file maintenance exception reporting tools in use, but the problems outlined above pointed up the need for a *post-hoc* quality assurance tool. Sampling existing data sets indicated the need for a regularly scheduled evaluation-reporting procedure and led to the formulation of the following objectives:

- As much programmatic evaluation as possible should be performed.
- Evaluation should be user oriented.

- Benefits other than error reporting should accrue to the user.
- Where multiple users exist, reporting should be tailored to the individual users.
- Data set evaluation should facilitate the detection of trends in quality change, if possible.

In attempting to meet these objectives, it soon became clear that comprehensive data set evaluation would involve a "family" of analysis programs. Because we had previously designed and implemented a tool to facilitate the production of COBOL program generators, we decided that "condition report" programs would be generated to meet individual user's needs. (Had this tool not been available, multiple condition report programs would still have been produced using standard methods.)

An analysis of the proposed condition report from a user-benefit viewpoint led to considering four types of reporting:

1. Errors: conditions that indicate definite failures, whether caused by a user, the hardware, or the application program.
2. Discrepancies: conditions that indicate possible failures, either human or programmatic, but which do not necessarily invalidate the data set.
3. Exception notes: conditions that do not in any way indicate discrepancies, but which should be called to the user's attention, indicating significant changes of a record's status, for example.
4. Counts: frequencies of occurrence of user-defined conditions that could help in answering day-to-day questions about the user's par-

# FOR RENT... NOW...

The amazingly advanced new Data Mark Analyzer - Halcyon's 803A - that speaks your computer's language.

The new Halcyon 803A is unique in solving data communication problems - and it's the only one that works on any computer platform. It's unique because it works on any computer - IBM, CDC, DEC, PDP, and many others. It's unique because it's the only one that can be used on any computer - IBM, CDC, DEC, PDP, and many others. It's unique because it's the only one that can be used on any computer - IBM, CDC, DEC, PDP, and many others.

Use it to bring up new facilities, evaluate existing ones, or test hardware. Run the 803A and the Standard 2004 command code can generate a 2004 Standard 2004 message in ASCII or EBCDIC or as well as a 511 and 2007 Standard Standard. Standard for other analysis. It can handle printing and graphics. It's unique in that it can handle any type of data. It's unique in that it can handle any type of data. It's unique in that it can handle any type of data.

When you call, we'll give you a free illustrated Rental Catalog. Call us today at (916) 442-8082. We'll be glad to help you. We'll be glad to help you. We'll be glad to help you.

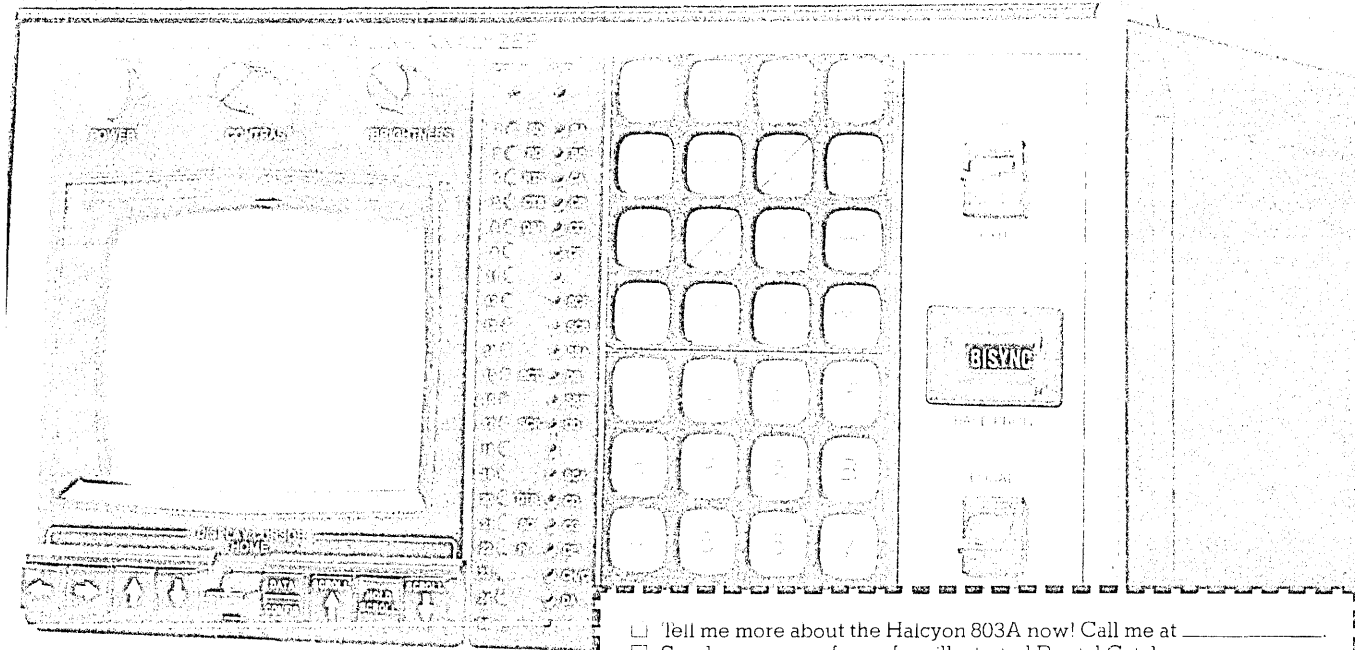

Halcyon, Inc.

- Tell me more about the Halcyon 803A now! Call me at \_\_\_\_\_
- Send me a copy of your free illustrated Rental Catalog.
- I might be interested in buying - on a money-back guarantee basis - some of your late-model, well-maintained "previously owned" equipment. Please send me your Equipment Sales Catalog.
- I have a pressing need right now for the following: \_\_\_\_\_

Please phone me immediately at \_\_\_\_\_

NAME \_\_\_\_\_ TITLE \_\_\_\_\_

COMPANY \_\_\_\_\_

ADDRESS \_\_\_\_\_

CITY \_\_\_\_\_ STATE \_\_\_\_\_ ZIP \_\_\_\_\_

PHONE NUMBER \_\_\_\_\_ EXTENSION \_\_\_\_\_

Complete this coupon and return it today to **GSA #GS-04S-REI, 19347 Londelius St., Northridge, CA 91324.** 21963 Neg

- Another of the companies
- Northridge, CA (213) 993-RENT (7368)
  - Anaheim, CA (714) 879-0561
  - Mountain View, CA (415) 968-8845
  - Fort Lauderdale, FL (305) 771-3500
  - Des Plaines, IL (312) 827-6670
  - Burlington, MA (617) 273-2770
  - Rexdale, Ontario (416) 675-7513
  - Montreal, Quebec (514) 681-9246
  - Vancouver, B.C. (604) 684-6623
  - Gaithersburg, MD (301) 948-0620
  - Oakland, NJ (201) 337-3757
  - Cleveland, OH (216) 442-8080
  - Dallas, TX (214) 661-8082
  - Houston, TX (713) 780-7218
  - Seattle, WA (206) 641-6444



## MONITORING

ticular data set, including trend information.

### The report

To provide the user with the combination of a useful data set evaluation tool and a handy reference document, we decided to produce a three-part report.

The first part identifies every record in which a reportable condition (error, discrepancy or note) has been detected and enumerates those conditions by code and name. This section is used when correcting anomalies on a record-

by-record basis.

The second report section is a condition-to-record cross-reference. Organized by condition code, entries point to records appearing in the first section in which the reportable conditions exist. Users often find this part helpful in eliminating specific discrepancies across the data set.

The final section of the document is the condition report summary. Two copies of this are produced and one is maintained in the computing center for use both as a timely status report on the application's data set and as an historical evaluation tool. The most valuable use of the Computing Center copy has been in advising potential data

users of the expected reliability of their output.

Designed to be produced after each significant update, the summary report provides a concise history of the data set's condition over a period of 12 updates, a period which may vary from a few days to several months, depending on the volatility of the data. We judged the 12-update period to be long enough to indicate trends, but not so long as to overload the user with data. On special request, the user may obtain a condition analysis extending over an even longer period, since the summary counts can be maintained in the system for up to 100 generations.

In addition to the display of raw counts for each active condition (a condition is "active" only if it existed in the 12-update analysis period), errors and discrepancies are analyzed further in terms of the entire data set and the subset containing anomalies. An error-discrepancy distribution is also produced

---

The most valuable use of the data center's copy has been in advising users of the expected reliability of their output.

---

which provides a facility for detecting gross malfunctions of hardware, software, and user processes.

With the exception of condition tests designed by the computing center staff to detect hardware and software malfunctions, all conditions are specified or approved by the users. Because user orientation was a basic design objective, flexibility features were included to allow the user to fine tune the reporting:

1. With minimal programmer intervention, the user can add and delete condition tests. Definitions (logical determinants) of conditions can also be changed easily. When conditions are changed (or when change is requested), users are provided with program-generated documentation of condition definitions.
2. When they are specified, conditions can be assigned class codes and priorities. Users may then request that only specific conditions or condition classes be reported. This facility allows users to tailor output for specific discrepancy correction tasks.
3. High-volume errors and discrepancies (the limits are user specified) are denoted by a code ("L") on the summary report, indicating that detail reporting ceased when the defined limit was reached. This feature reduces the size of the detail report during periods when the user expects certain discrepancies or errors to occur frequently and does not require their reporting.

# The perfect pair.

The AJ 860 teleprinter terminal handles a range of half or full duplex line speeds, switch-selectable, up to 1200 baud.

The AJ 1245 acoustic coupler/modem handles a range of half or full duplex line speeds, switch-selectable, up to 1200 baud.

In short, they're the perfect pair, made for each other.

And each is an outstanding partner in its own right. The AJ 860, for example, produces clear, crisp characters, has many standard features for high performance, and can be equipped with a range of options for special needs—including APL and Graphics character sets.



The AJ 1245 can be used as an acoustic coupler or a DAA originate modem. Switching is automatic. Whether used as a coupler or a modem, it has advanced features to improve your data communications.

Get full details on the perfect pair. Call your nearest AJ sales office. Or write Anderson Jacobson, Inc., 521 Charcot Avenue, San Jose, California 95131, (408)-263-8520. In Canada, Anderson Jacobson Ltd./Ltee., Ottawa, Ontario.



 **ANDERSON  
JACOBSON**

CIRCLE 136 ON READER CARD

# We wrote the book on distributed networks.

With more than 250 networks installed and running, including several in our own plants, Hewlett-Packard knows a lot about dedicating computers to production tasks and tying them together into information systems.

Our DS/1000 software, which took 30 man-years to develop, is designed to make running your factory's production and operations management tasks much more efficient. It lets you set up economical links between our powerful HP 1000 real-time computers.

With the HP approach, you can cut overall costs by sharing peripherals. For example, any computer in the network can use any printer. You can also maintain control by writing all the programs on one HP 1000, then downloading them to the computers doing the work. And if one system is down, you can transfer jobs to one that isn't.

You can also write programs to access and update data files on remote HP 1000s, using the same program requests as you would for your local computer. So if you want to know some test results that took place on another system, you'll get up-to-the-minute numbers instead of yesterday's out-of-date news.

When you request this remote data, the system's

store and forward communications pass the information from node to node quite transparently. (It's this feature that cuts the cost of putting together a large network and lets you add nodes without rewriting your application software.)

The next important step is linking the HP 1000 network with our HP 3000 general purpose computer. This gives you access to high-level business languages. And you can transmit information from factory to front office for top management review, for updating cost accounting and inventory control, and for summaries requiring batch processing.

## Now you can see the movie.

Obviously, there's a great deal more to our distributed networks than we can tell you here. So we'd like to show you our new 20-minute movie that tells it all. Just send us the coupon and we'll arrange a private showing that could be a real revelation.



HEWLETT  PACKARD

Yes, I'm interested in seeing the HP 1000 distributed systems network movie.

- Get in touch to arrange a showing of your movie.
- Send me printed information only.

Name \_\_\_\_\_ Title \_\_\_\_\_

Company \_\_\_\_\_ Phone \_\_\_\_\_

Address \_\_\_\_\_

City/State/Zip \_\_\_\_\_

Mail to: Hewlett-Packard, Attn: Larry Turner,  
11000 Wolfe Road, Dept. 422, Cupertino CA 95014

# T-Bar makes history

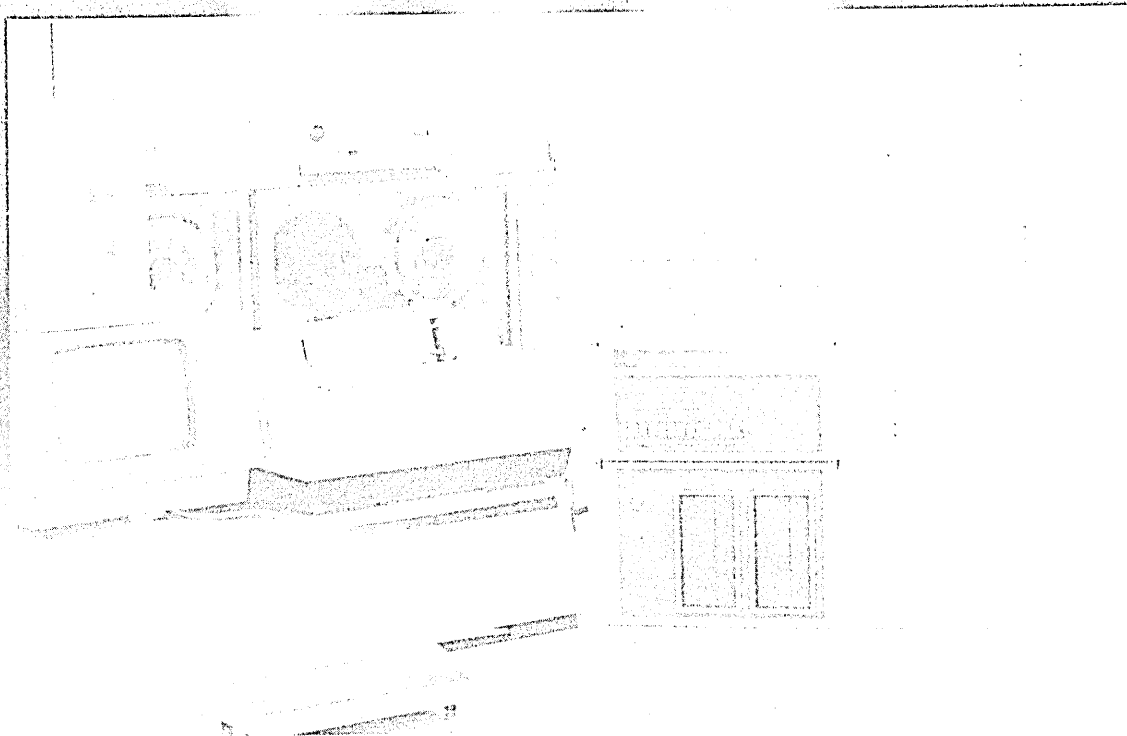

**3915 ... the world's first high-capacity computer peripheral interface switch.**

**3916 ... the first remotely controlled computer peripheral interface switch.**

**3917 ... and now the first microprocessor-based INTELLIGENT MATRIX CONTROL.**

The T-Bar 3917 provides complete real-time system control right at the terminal.

The 3917 displays, right at the terminal, which computer channels are connected to which

peripherals. Want to make a change? You can do it directly at the keyboard. The new connections, once again, are immediately displayed on screen.

With the 3917, you can effect computer room reconfiguration decisions and know the consequences instantly.

For details, write to T-Bar, Computer Switching Division, 141 Danbury Road, Wilton, CT 06897. Or call us at (203) 762-8351.

**T-Bar** INCORPORATED  
COMPUTER SWITCHING DIVISION

T-Bar Inc., 1978

## MONITORING

### The results

Evaluation of the efficacy of the condition report concept, after two years of experience with four user-tailored versions in three application areas, indicates that the initial development was worthwhile. (The review consisted of an analysis of error rate trends and a survey of user reaction. The most notable results of the review indicate both increased user satisfaction and an increase in data integrity as measured by condition report criteria.)

The results showed:

1. The inception of each report caused an immediate improvement in data integrity as a result of the users' new awareness of long-standing problems and their initial efforts to correct them. Most corrections were done through normal file maintenance procedures, but some required correction or redesign of erroneous production software.
2. Two otherwise undetected hardware failures were found in a timely manner as a result of con-

### Two otherwise undetected hardware errors were found.

dition report indications, allowing immediate recovery of several destroyed or damaged records.

3. Users have requested changes in the reporting of conditions, indicating their active use of the condition reports.
4. Downward trends in error frequencies and discrepancies (ex-

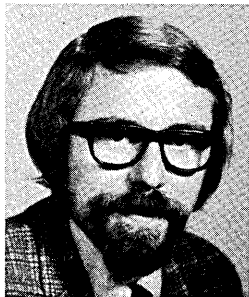

Mr. Fried is a senior software writer at Digital Equipment Corp. Prior to joining DEC, he held dp positions with the State Univ. of New York College at Oneonta, where his responsibilities have included design and development of both applications and systems software. Before joining SUNY in 1970, Mr. Fried held dp positions with the ITT-Sheraton Corp. and RCA, and worked as an independent systems consultant.

cept during expected error-prone periods) indicate the reports' continuing use as a correction tool.

5. Several users have become more aware of the cyclic nature of some systems (and the integrity of their data sets), allowing them to schedule their use of the data to coincide with the "ripeness" of the information and the cleanliness of the data set.
6. The validity and utility (or futility) of proposed data set uses has often been easily predicted by analysis of the applicable condition report, avoiding needless expenditure of programmer and production staff effort.

In summary, the condition report has been found to be useful as a continuing long-term tool for monitoring data set integrity, and while the desired form might vary from one installation to another, the basic concepts (user orientation, flexibility, continuity, and history maintenance) should prove useful to most organizations.

As tools of this type come into wider use, they tend to engender user confidence in the data processing function as a whole as well as in specific data sets, a confidence that is not misplaced, because monitoring tools not only certify the integrity of a data set, but also indicate a management commitment to excellence in data processing. #

## We have over 1400 man years invested in our computer graphics system!

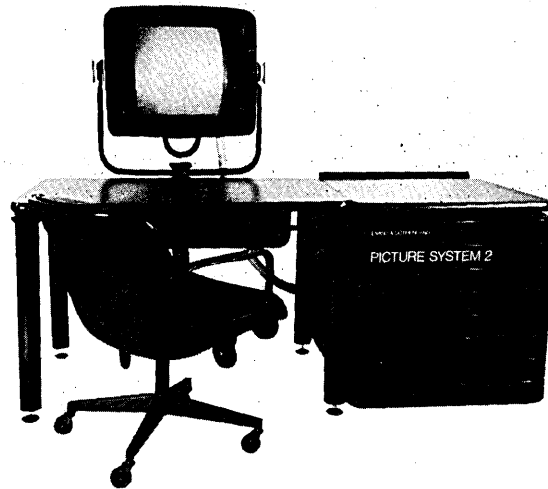

EVANS & SUTHERLAND has been the leader in the development of computer graphics systems for 10 years now. In those 10 years of learning and development we have invested over 1400 man years. That's an impressive figure! We are proud of it and even more proud of our newest product development called PICTURE SYSTEM 2. 1400 years of computer graphics understanding form a solid hardware and software foundation for this high performance 3-D computer graphics system. Hardware capabilities like true-perspective computation, zooming, clipping, and depth-cueing are readily accessible to the user through an extensive set of FORTRAN—or Assembly Language—callable subroutines called the Graphics Software Package. PICTURE SYSTEM 2 is a carefully balanced combination of computer graphics hardware and support software that can satisfy a broad spectrum of computer graphics applications from flight simulation to molecular modeling to computer-aided design.

Give us a call. We're the Computer Graphics People  
580 Arapeen Drive  
Salt Lake City, Utah 84108  
(801) 582-5847

We have offices in: Seattle, San Francisco, Los Angeles,  
Salt Lake City, Chicago, Detroit, Dallas, Atlanta, New York City,  
Washington, D.C., Frankfurt and Tokyo.

## EVANS & SUTHERLAND

# COMPLETE AND MAIL THIS COUPON FOR THE FULL STORY ON DAY-FLO® PRE-INKED ROLLERS

Please  send me brochures describing Day-Flo Pre-Inked Rollers;  contact me, immediately, concerning my particular application.

Name \_\_\_\_\_

Firm \_\_\_\_\_

Address \_\_\_\_\_

City \_\_\_\_\_ State \_\_\_\_\_ Zip \_\_\_\_\_

Phone \_\_\_\_\_

Consider Dayco's complete line of microporous pre-inked rollers. Custom designed to fit your system or application.

Pre-inked rollers for credit card im-  
printers, check encoders, character  
printers, print-outs, ribbon re-inking,  
high-speed character printers, on-

line marking and a number of other  
printing and marking applications.

For the full story on the finest and most  
complete line of pre-inked rollers  
made, phone 513/226-5866. Or com-  
plete and mail this coupon to: Dayco  
Corporation, Marketing Services, 333  
West First Street, Dayton, Ohio 45402.

**DAYCO**  
CORPORATION



PRINTING PRODUCTS DIVISION

© 1978 Dayco



# Alphanumeric Display Terminal Survey

by David H. Axner and Fonnie H. Reagan

---

Not counting specialized products, or those available from leasing companies, or those which are part of other systems, or those with comprehensive graphics, there are still 170 models or series to consider.

---

The convenience, speed, and glamour associated with display terminals have made them an integral part of even the smallest computer installation. The demand for them seems unlimited.

Because of the diversity of their uses, it is no longer practical to lump all devices with a screen and keyboard into the same category. Since features and capabilities vary widely, it is generally more useful to define a terminal by application, such as banking, brokerage, or industrial data collection. But while specialized terminals make up a large portion of the display market, the biggest segment still consists of general purpose interactive displays.

Not surprisingly, IBM dominates this sector of the industry, accounting for at least 50% of the total installed base.

## Major display markets

The general purpose display industry has focused its attention on three principal markets: Teletype replacement, IBM 3270 replacement, and user/programmable terminals.

The most active of these markets has been and will most likely continue to be that of the Teletype replacement, be-

---

## Teletype Corp. was forced to change its image.

---

cause it represents the greatest profit potential for the small terminal manufacturers.

The IBM 2260 and its replacements have long passed their peak of market penetration and are now offered by a few independents on an "as available" basis. Thus, the IBM-replacement industry is now directed mainly toward the 3270.

Numerous independent vendors offer direct replacements for IBM's 3270. Among these are Computer Optics, Courier, Four-Phase Systems, Genesis One, Incoterm, Memorex, Raytheon, Harris (Sanders), Sycor, Telex Terminal Communications, and Trivex. Although these independents have made

inroads into that market, 75% of all installed 3270-type terminals are IBM's.

As one might expect, the independents are offering more than just substantial price reductions. Enhancements include additional screen sizes, increased configuration flexibility, greater printing capabilities, user-programmable data validation, display enhancements, etc. Not all these enhancements are offered for the same terminal, so users should examine each product separately for those characteristics that satisfy the needs of their specific applications.

The third market, that of user-programmable terminals which are based on microprocessors or minicomputers,

---

## Independents have made inroads into the 3270 market, but 75% of the products are still IBM's.

---

really overlaps into the second by virtue of their ability to emulate virtually any terminal. These versatile terminals are less vulnerable to obsolescence and promise to capture both the older IBM 2260 and newer 3270 replacement markets. In addition, many programmable terminals can be equipped with an extensive complement of peripheral

equipment and can effectively perform a wide variety of local data editing, formatting, and processing functions.

But IBM will not make it easy for independents to penetrate its market. The announcement of the 3274/3276/3278 display components last May anticipated industry estimates by a year and set new targets for the independents in terms of cost and display capacity. IBM has also provided a method for integrating all of a user's computing facilities into a single system with distributed resources by first introducing SDLC, then SNA, and now ACF (Advanced Communications Function). This too will have an impact on the market as replacement and add-on products surface.

Vendors competing in the IBM market will have to incorporate SDLC compatibility for their products to stay viable. Many are already in the process of doing this, while others plan to shortly. Fortunately for them, microprocessor-based display terminal manufacturers can provide SDLC compatibility by merely changing the microprograms that control terminal operation. Even less affected are vendors marketing low-

---

## IBM accounts for at least 50% of the installed base.

---

speed (asynchronous) Teletype-compatible terminals; they need not concern themselves with SDLC in the immediate future as long as there is a large population of Teletypes to attack; but they will eventually have to respond to IBM's 3767 and 3770 series teleprinters which can operate with SDLC.

## The controversial Teletype 40

But as important as IBM is, it is not the only major force in the display industry. Teletype Corp. is making a strong bid for a substantial market share. While the independent crt manufacturers were busy replacing Teletype terminals, Teletype Corp. witnessed steadily declining revenues—a strong

This article and the accompanying tables were adapted from source material printed in *Datapro 70*, a three-volume looseleaf reference service published by Datapro Research Corp. Substantial revisions were made by *Datamation*.

The report, "All About Alphanumeric Display Terminals," on which this article is based can be obtained separately from Datapro at 1805 Underwood Blvd., Delray, NJ 08075. The price is \$12.

## SURVEY

impetus that forced Teletype to change its image from that of an old-line supplier of low-speed, message-oriented equipment to that of a sophisticated terminal manufacturer. Though long dedicated to the production of teleprinters and punched tape equipment, Teletype gained experience with crt terminals in the late 1960s, when development began on communication display terminals for AT&T in-house applications such as order entry.

Teletype's impressive display terminal, the Model 40, was unveiled in May 1973. The unit was offered on a purchase-only basis by Teletype, a subsidiary of AT&T's Western Electric Co., and

### Even vendors of Teletype-compatible products will one day have to respond to IBM's challenge.

as the Dataspeed 40 Service, a tariffed offering from AT&T and its Bell System operating companies. The Model 40 offered a significant collection of capabilities and features at very competitive prices. Teletype has since expanded its original Model 40 into three asynchronous versions for dial-up, leased point-to-point, and multipoint (multidrop) applications. And in May 1975, Teletype introduced a clustered, synchronous version of the Model 40 that provides hardware and software compatibility with the binary synchronous version of the IBM 3270.

The joint introduction of the Teletype Model 40 and AT&T Dataspeed 40 service spread waves of apprehension that penetrated the very foundation of the communications terminal industry, which is largely composed of small, independent manufacturers. The independents complained bitterly that AT&T was entering the data processing business, which it is prohibited from doing by the FCC. They charged that the Model 40 was clearly designed for data processing purposes and not just for message transmission as were the earlier teleprinters. AT&T repudiated the accusation, claiming that the offering was just an advance in telecommunications technology and "in no way constitutes a data processing service."

Four years have passed since its introduction in 1973, and in spite of all the controversy and legal hassles, the Dataspeed 40 received its final okay from the FCC in February. And the Model 40 has become a target for a brand new market. At least one vendor, Racal-Milgo (the modem maker), is offering a compatible product, its 40+, with the now-typical characteristics of a terminal

emulator: compatibility plus additional features.

### Reading the charts

Keeping up with all these changes requires an occasional comprehensive survey. In putting together this one, we set out to include terminals which are primarily alphanumeric, rather than graphic (although a limited graphic capability may be an added feature), because alphanumeric terminals are attracting most of the attention and generating most of the revenue in the current display market. Graphic display terminals account for only a small portion of the overall market, although the number is growing as their dropping cost makes them more competitive with alphanumeric-only terminals.

offer them under a different product name. Neither of those kinds of companies are represented here.

The accompanying charts summarize the characteristics of more than 170 commercially available alphanumeric display terminals from 76 vendors. In cases where two or more terminals manufactured by the same company have primarily the same specifications, the listings were combined with the differences noted. This was done in an effort to indicate product groupings as well as to be concise.

Most categories listed are fairly self-explanatory, but it may be helpful to outline the information we have included in the *Model Highlights* section. Here we tried to present the major features offered by a particular terminal.



Announced last May, the IBM 3278 display station, shown here in design models, can be grouped in clusters of up to 32 units in a BSC or SDLC network. Four screen capacities are offered with the largest allowing a display of up to 3,440 characters.

We also sought out interactive displays, providing for input by keyboard, and those considered general purpose, which are of interest to the widest audience.

We asked manufacturers to give us information on devices which spend 50% or more of their uptime in terminal use, connected remotely to a central processing unit. While many of today's alphanumeric display terminals have considerable standalone capability, we are concerned here with terminal use.

And further, we are concerned with manufacturers of devices. There are many excellent companies which buy display terminals and include them in their own, sometimes elegant, systems. Others buy terminals on an oem basis, relabel or sometimes modify them, and

Along with screen size, we list display capabilities designed to enhance the readability of the data as it appears on the screen.

The *Display Features* section lists many of the features which give each product its own "personality":

- *Color.* Characters or fields can be separated by color, which can also be used to identify conditions or types of data. Few display terminals offer color, mainly due to cost, but those that do offer as many as eight colors.

- *Reverse video.* Some can display a negative image, that is, data normally displayed in white on dark background is displayed in black on a white background. Characters or fields can be displayed in reverse video.

- **Brightness levels.** Different kinds of information can be separated by displaying each type—such as a fixed format versus entered data—at a different intensity level.

- **Blinking.** This may be applied to a single character or an entire field to attract attention.

- **Cursor.** The cursor marks the position on the screen where the next character will be read or written. Some blink, others keep moving as long as the control key remains depressed. (All cursors should be of the nondestructive type.) Some terminals also have an addressable/readable cursor; this means the position of the cursor can be read and controlled by an application program in the host.

Some applications require viewing



The 4025 is a microprocessor-based display terminal recently introduced as part of the Tektronix 4020 Series. It is designed to make limited graphics available to the alphanumeric user at prices consistent with alphanumeric-only display terminals.

more data than can be displayed at one time. The following features satisfy this need:

- **Scrolling.** All displayed lines of data move up or down by one line as a new line is added.

- **Paging.** Terminals with sufficient memory capacity may store two or more "pages" of data and display any selected page.

Two more display features are important for data entry and transmission:

- **Protected format.** Portions of the display screen may be "protected" from inadvertent alteration or erasure. This permits a printed form to be duplicated on the screen and data entered only into the blank spaces, reducing entry time and the possibility for error.

- **Partial screen transmit.** This has two uses. It promotes line economies by transmitting only the keyed data (the fixed format remains displayed and the "blanks" are erased for the next entry) and allows transmission of only a portion of even the entered data when not all is needed by the application program.

While discussing display features, it also seems like a good time to make an observation of a significant change in

technology reflected in this survey.

Until recently the crt was virtually the sole means used to display dynamic information, but other methods are now gaining popularity. These non-crt devices include LED's (light emitting diodes, such as those used in calculators and watches), plasma (gaseous displays such as the Burroughs Self-Scan panel), liquid-crystal displays, etc. But though some of these are listed, crt's still dominate the industry because they are by far the cheapest method for displaying large amounts of data.

LED and plasma displays are currently limited to showing a few characters or a line of some two to three dozen characters (although Burroughs uses its Self-Scan panel to display up to 480 characters in a 12-line by 40-character

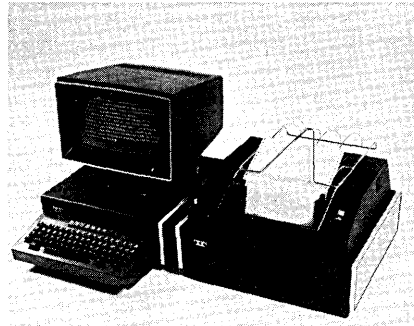

The newest member of the Teletype 40/4 series is a desktop, standalone version featuring an integrated terminal controller. An interstate tariff filed with the FCC became effective March 23, and Bell System operating companies will soon file intrastate tariffs.

format in its TD 730 unit). Because of their prohibitive costs for displaying large quantities of data, easily handled on the 2,000-character crt's in current use, solid-state displays are still a long way from replacing the ubiquitous cathode ray tube.

Under *Communications*, the other features section probably also requires some explanation. Here we are concerned with special features that facilitate communications, such as polling and addressing, and auto answer capability.

In multiple terminal configurations, it's important that a terminal be able to distinguish a control message intended for it alone. *Addressing* informs the terminal that a message for it is coming so that it will be conditioned to receive.

The *Polling* feature is also important in a multiterminal network. Each terminal is polled in a continuous loop until one is found ready to send. At the end of its transmission the next terminal in the loop is polled, and so forth.

*Auto answer* refers to the facility for unattended operation whereby incoming calls are automatically answered and messages received without human intervention.

## NG

A word about missing data. As always, some manufacturers chose not to answer some questions. "Number of products shipped" is a favorite to be left unanswered. Missing data that, in our opinion, creates a serious or suspect omission is replaced with the symbol NG, for "Not Given." Other, less significant omissions are indicated by a dash.

Where the reasons for no entry are self-evident (for instance, no program loading method is mentioned because there is no processor to program), the entry also may show a dash.

## Want more information?

DATAMATION's goal in publishing surveys of this kind is to provide a starting point for anyone interested in these products. More detailed information can be obtained on a particular device either by contacting the manufacturer directly at the address shown in the Vendor Index or by circling the appropriate number on the reader service card bound into this issue.

(Charts start on page 186)



Mr. Axner is responsible for research and reports on terminals for *Datapro Reports on Data Communications*. He previously was responsible for reports on peripherals in *Datapro 70*.



Mr. Reagan is managing editor of *Datapro Reports on Data Communications*, at Datapro Research Corp., Delran, N.J. Prior to taking this position, he was responsible for the preparation of Datapro's reports on data entry, computer peripherals, and data communication products for *Datapro 70*.

Manufacturer	Ann Arbor	Ann Arbor	ADDS	ADDS	ADDS
<b>Model Highlights</b> 1st ship/# shipped Standalone or cluster Display format Character format Character code Programmable? Editing? Compatibility	Series 200 05/70 10,000 shipped Standalone 8x32/ 40x80 5x7 or 7x9 dot matrix ASCII Not programmable Opt. char & line editing Teletype compatible	Model 400E 12/77 200 shipped Standalone 10x40/ 24x80 5x7 or 7x10 dot matrix ASCII Not programmable Opt. char & line editing Teletype compatible	MRD 980; Consul 980/A/B 11/74 5,000+ shipped Standalone 24 lines of 80 chars 5x7 dot matrix ASCII Not programmable Char & line editing Teletype compatible (980); IBM 3270/3275 (980A); Burroughs TD.800 (980B)	Envoy 620 10/75 300 shipped Standalone 24 lines of 80 chars 5x7 dot matrix ASCII Not programmable No editing Teletype compatible	Consul 620 04/76, 2,600 shipped Standalone 24 lines of 80 chars 5x7 dot matrix ASCII Not programmable No editing Teletype compatible
<b>Display Features</b>	9- to 23-inch screen Opt. color, reverse video, brightness levels and blinking; scrolling, address cursor; opt. protect & partial transmit	8 x 10 screen Reverse video, bright- ness levels, blinking, scrolling, paging, ad- dress cursor (opt. read); protect & partial transmit	12-inch screen Reverse video, brightness levels, blinking, scrolling, address cursor (980A & B), protect, partial transmit	5-inch screen Scrolling, address/ read cursor	8 x 10 screen Scrolling, address cursor
<b>Communications</b> Line protocol Transmission Speed Interfaces Other features	Asynchronous ASCII Full- or half-duplex Up to 9,600bps RS232C, CCITT, curr loop, TTL Poll/addressing optional	Asynchronous ASCII Full- or half-duplex Up to 9,600bps RS232C; opt. curr loop	Asynchronous/synchronous ASCII or BSC Full- or half-duplex Up to 9,600 bps RS232C or current loop Poll/addressing (980A & B)	Asynchronous ASCII Full- or half-duplex Up to 9,600bps RS232C, CCITT, curr loop Coupler std.	Asynchronous ASCII Full- or half-duplex Up to 9,600 bps RS232C, CCITT, curr loop
<b>Keyboard</b>	Detachable; Teletype style with numeric pad	Detachable; data entry style with numeric pad	Detachable (opt.); typewriter style with numeric pad	Typewriter style	Detachable (opt); type- writer style
<b>Peripherals</b>	Audio alarm opt.		Cassette, diskette interface, impact printer (980), impact/ non-impact printer (980B); audio alarm, composite video	Cassette, diskette inter- face, non-impact printer, audio alarm	Impact printer, audio alarm, composite video
<b>Display Pricing</b> 1-year lease/maint	— —	\$1,210-\$1,500 —	\$2,800/\$3,200/\$2,700 \$132/month (980B)	\$2,250 —	\$1,595 —
<b>Controller Pricing</b> 1-year lease/maint	\$720-\$1,345 —	— —	\$1,995 (MRD 980) —	— —	— —
<b>Comments</b>	Series 200 is available as circuit boards with monitor in desk or rack mounting		MRD is rack mount con- troller; 980 Series also available from NCR as 796 Series	Portable terminal inte- grated into a carrying case	

Manufacturer	ADDS	ADDS	ADDS	ADDS	Beehive
<b>Model Highlights</b> 1st ship/# shipped Standalone or cluster Display format Character format Character code Programmable? Editing? Compatibility	Consul 580 & MRD 380 1973 16,000 shipped Standalone 24 lines of 80 chars 5x7 dot matrix ASCII Not programmable Character editing Teletype compatible	MRD 460 09/75 200 shipped Standalone 24 lines of 80 chars 5x7 dot matrix ASCII Not programmable No editing Teletype compatible	Consul 920 04/70 1,500 shipped Standalone 24 lines of 80 chars 5x7 dot matrix ASCII Not programmable No editing Teletype compatible	Regent 100 & Regent 200 08/77 3,000+ shipped Standalone 24 lines of 80 chars 8x8 dot matrix ASCII Not programmable Opt char & line edit (200) Teletype compatible	Mini Bee 2 08/73 7,700+ shipped Standalone 25 lines of 80 chars 5x7 dot matrix ASCII Not programmable Character editing Teletype compatible
<b>Display Features</b>	12-inch screen Scrolling, address cursor, partial transmit	9¼-inch screen 8 colors, reverse video, brightness levels, blink- ing, address cursor, protect, partial transmit	12-inch screen Reverse video, bright- ness levels, blinking, scrolling, address/ read cursor, protect, partial transmit	12-inch screen Reverse video, bright- ness levels, blinking, scrolling, address/read cursor, protect (200), partial transmit (200)	6.5x8.4 screen Brightness levels and blinking, scrolling, protect, partial transmit
<b>Communications</b> Line protocol Transmission Speed Interfaces Other features	Asynchronous ASCII Full- or half-duplex Up to 9,600 bps RS232C; opt. curr loop	Asynchronous ASCII Full- or half-duplex Up to 1,500 cps RS232C, CCITT, curr loop	Asynchronous ASCII Full- or half-duplex Up to 9,600 bps RS232C; opt. curr loop	Asynchronous ASCII Full- or half-duplex 75 to 9,600bps RS232C and current loop	Asynchronous ASCII Full- or half-duplex Up to 9,600bps RS232C
<b>Keyboard</b>	Detachable (opt.); type- writer style with numeric pad	Detachable; typewriter style with numeric pad	Detachable (opt.); type- writer style with numeric pad	Detachable (opt.); type- writer style with numeric pad	Typewriter style
<b>Peripherals</b>	Cassette, diskette inter- face, non-impact printer, audio alarm	Cassette, diskette inter- face	Cassette, diskette inter- face, non-impact printer, audio alarm, composite video	RS232C interface pro- vided	Cassette, diskette inter- face
<b>Display Pricing</b> 1-year lease/maint	\$1,795 (580) —	Vendor will not release pricing	\$2,600 —	\$1,325-\$1,450/\$1,795-\$1,940 —	\$1,795 Purchase only
<b>Controller Pricing</b> 1-year lease/maint	\$1,195 (380) —	— —	— —	— —	— —
<b>Comments</b>	Also available from NCR as part of 796 Series; MRD 380 is rack-mount controller			Features include termi- nal status line, limited graphics, and terminal bypass printing	



Manufacturer	Beehive	Beehive	Beehive	Beehive	Braegon
<b>Model Highlights</b> 1st ship/# shipped Standalone or cluster Display format Character format Character code Programmable? Editing? Compatibility	B 150 06/76 6,000 shipped Standalone 24 lines of 80 chars 5x7 dot matrix ASCII Not programmable Opt. char editing Teletype compatible	B 300 and B 400 05/73 8,000+ shipped Standalone 25 lines of 80 chars 5x7 dot matrix ASCII Not programmable Character editing Teletype compatible (300); opt. protocols (400)	B 550 08/76 1,500 shipped Standalone 25 lines of 80 chars 7x8 dot matrix ASCII Programmable Character editing Teletype compatible	B 800 11/76 # shipped NG Up to 16-unit cluster 25 lines of 80 chars 5x7 dot matrix ASCII Programmable Programmable editing Teletype compatible	Virtual Terminal System Date & shipments NG Up to 36-unit cluster 12x40/ 24x80 7x9 dot matrix ASCII or EBCDIC Programmable opt. Opt. char & line editing IBM 3270 & 3780 compatible
<b>Display Features</b>	6.5 x 8.4 screen Blinking, scrolling, address cursor, opt. protect and partial transmit	6.5 x 8.4 screen Reverse video, blink- ing, scrolling, paging, address/read cursor, protect, partial transmit	6.5 x 8.4 or 7 x 9 screen Reverse video, blinking, scrolling, paging, address/ read cursor, protect, partial transmit	6.5 x 8.4 screen Scrolling, address/ read cursor	12-inch screen Reverse video, bright- ness levels, blinking, scrolling opt., address/ read cursor, protect, partial transmit
<b>Communications</b> Line protocol Transmission Speed Interfaces Other features	Asynchronous ASCII Full- or half-duplex Up to 19,200bps RS232C or current loop Autoanswer std.	Asynchronous/synchronous ASCII Full- or half-duplex Up to 9,600bps RS232C Poll/addressing opt. (std. 400)	Asynchronous Full- or half-duplex Up to 19,200bps RS232C	Asynchronous/synchronous ASCII or BSC Full- or half-duplex 110 to 9,600bps RS232C or current loop Poll/addressing std., autoanswer opt.	Synchronous BSC or SDLC Full- or half-duplex 1,200 to 19,200bps RS232C Poll/addressing std., autoanswer opt.
<b>Keyboard</b>	Typewriter style with numeric pad	Detachable; typewriter style with numeric pad	Detachable; typewriter style with numeric pad	Detachable; typewriter style (Selectric opt.) with numeric pad	Detachable; typewriter or data entry style with numeric pad
<b>Peripherals</b>	Printer interface, audio alarm	Printer interface, audio alarm	Audio alarm	Impact printer, disk, line printers, card readers, mag tape, 4K to 32K word memory	Impact printer, opt. diskette, card readers, 4.8MB disk, 256KB memory
<b>Display Pricing</b> 1-year lease/maint	\$1,595-\$1,770 Purchase only	\$3,295/\$3,695 Purchase only	\$2,930 base Purchase only	\$5,945 base Purchase only	\$2,250 \$76/month
<b>Controller Pricing</b> 1-year lease/maint	—	—	—	—	\$9,000 \$247/month
<b>Comments</b>	An enhanced version of the earlier B 100	Formerly Super Bee 2 and 3; 15-inch screen and rack mount optional	Enhanced B 500; avail- able with up to 48K RAM & 7K ROM or PROM 8080A microprocessor	Contains 16-bit processor compatible with Data Gen- eral Nova 1200	Supports up to 64 devices

Manufacturer	Bunker Ramo	Burroughs	Burroughs	Compugraphic	Computek
<b>Model Highlights</b> 1st ship/# shipped Standalone or cluster Display format Character format Character code Programmable? Editing? Compatibility	System 90 Date & shipments NG Up to 32-unit cluster 12x40/80; 24x80 5x7 dot matrix ASCII or EBCDIC Programmable Character editing IBM 3270 (opt. 2260/ 2265), BR 2200 compatible	TD 730 06/77 # shipped NG Standalone 12 lines of 40 chars 5x7 dot matrix ASCII Not programmable Char & line editing Burroughs compatible (IBM 3275 opt.)	TD 830 08/76 # shipped NG Standalone 25 lines of 80 chars 5x7 dot matrix ASCII Not programmable Char & line editing Burroughs compatible (IBM 3275 opt.)	MDT-400 10/77 500 shipped Standalone 16 lines of 80 chars 7x9 dot matrix ASCII Programmable Char & line editing IBM 2780-BSC, opt. Teletype compatible	Econotext 01/78 10 shipped Standalone or 4-unit cluste 25 lines of 80 chars 14x20 dot matrix ASCII and EBCDIC Programmable Char & line editing Teletype compatible
<b>Display Features</b>	Variable size screen Brightness levels, blink- ing, address/read cursor, protect, partial transmit	4.7 x 8.4 screen Blinking, scrolling, paging, address/read cursor, protect, partial transmit	7½ x 9 screen Reverse video, bright- ness levels, blinking, scrolling, paging, address/read cursor, protect, partial transmit	4.75 x 6.875 screen Reverse video, bright- ness levels, blinking, scrolling, paging, address cursor, pro- tect, partial transmit	12-inch screen Reverse video, bright- ness levels, blinking, scrolling, paging, opt. protect, opt. partial transmit
<b>Communications</b> Line protocol Transmission Speed Interfaces Other features	Synchronous BSC or SDLC Full- or half-duplex Up to 9,600bps RS232C Poll/addressing, auto- answer and modem opt.	Asynchronous/synchronous BSC or Burroughs Full- or half-duplex Up to 38,400bps RS232C	Asynchronous/synchronous BSC or Burroughs Full- or half-duplex Up to 38,400bps RS232C	Asynchronous/synchronous BSC Full- or half-duplex Up to 9,600bps RS232C Autoanswer opt.	Asynchronous/synchronou ASCII or BSC Full- or half-duplex 110 to 19,200bps RS232C Poll/addressing std., autoanswer opt.
<b>Keyboard</b>	Detachable; typewriter style with numeric pad	Detachable; typewriter style with opt. numeric pad	Detachable; typewriter style with opt. numeric pad	Typewriter style with opt. numeric pad	Detachable; typewriter style
<b>Peripherals</b>	Impact printer, dual diskette, audio alarm, opt. ID reader	Single/dual cassette, impact printer, line printers, audio alarm, ID card reader	Single/dual cassette, impact printer, line printers, audio alarm, ID card reader	Single mini-diskette, impact printer	1 to 6 disk drives, impact printer
<b>Display Pricing</b> 1-year lease/maint	\$1,510 —	\$3,635-\$4,585 \$115-\$142/month	\$4,285-\$5,235 \$135-\$162/month	\$4,500 —	\$3,850 base —
<b>Controller Pricing</b> 1-year lease/maint	\$8,260 —	—	—	—	—
<b>Comments</b>	Supersedes BR 2200 system			Based on MDT-350 intelligent text editing terminal	Designed for text editing



Manufacturer	CompuTek	CompuTek	Computer Optics	Computer Peripherals	Conrac
<b>Model Highlights</b> 1st ship/# shipped Standalone or cluster Display format Character format Character code Programmable? Editing? Compatibility	200 Series 10/72 3,500+ shipped Standalone or 4-unit cluster 12 or 25 lines of 80 chars 14x20 dot matrix ASCII or EBCDIC Programmable Opt. char & line editing Teletype compatible, and IBM 3270, 2260/2265	216 Series 06/77 75 shipped Standalone or 4-unit cluster 24 lines of 80 chars 7x9 dot matrix ASCII or EBCDIC Programmable Char & line editing Teletype compatible, IBM 3270 and others opt.	CO-77/78 1st Qr '74 5,000 shipped Standalone or 32-unit cluster 12x40/ 43x80 7x9 dot matrix ASCII or EBCDIC User-defined hardware Char & line editing IBM 3270 Series compatible	COPS Family 10/77 500 shipped Standalone 24 lines of 80 chars 5x7 or 7x9 dot matrix ASCII Not programmable No editing Teletype compatible, opt. ADDS, DEC, Hazel- line & Lear Sidgler emulators	480 Series 05/78 2,500+ shipped Standalone 26 lines of 80 chars 5x9 dot matrix ASCII; others opt. Programmable Char & line editing Teletype, Burroughs TD 700/800, Univac U100/200 compatible
<b>Display Features</b>	12- or 15-inch screen Reverse video opt., brightness levels, blink- ing, scrolling, paging, address/read cursor, protect, partial transmit	12- or 15-inch screen Reverse video opt., brightness levels, blinking, scrolling, paging, address/read cursor, protect, opt. partial transmit	15-inch screen Brightness levels, address/read cursor, protect, partial transmit	12-inch screen Reverse video, scrolling, address/read cursor	6½ x 8½ screen Brightness levels, blinking, scrolling, paging, address/read cursor, protect, partial transmit
<b>Communications</b> Line protocol Transmission Speed Interfaces Other features	Asynchronous/synchronous ASCII or BSC Full- or half-duplex 110 to 19,200 bps RS232C Autoanswer opt.	Asynchronous/synchronous ASCII, BSC or SDLC Full- or half-duplex 110 to 19,200bps RS232C Poll/addressing std., autoanswer opt.	Synchronous BSC or SDLC Full- or half-duplex 1,200 to 9,600bps RS232C	Asynchronous ASCII Full- or half-duplex 110 to 19,200bps RS232C and current loop Opt. coupler	Asynchronous/synchronous ASCII; others opt. Full- or half-duplex 50 to 9,600bps RS232C or current loop Poll/addressing and autoanswer opt.
<b>Keyboard</b>	Detachable; typewriter style with numeric pad, others avail.	Detachable; typewriter style with numeric pad, others avail.	Detachable; typewriter style with numeric pad, others avail.	Detachable; typewriter style with opt. numeric pad	Typewriter style with opt. numeric pad
<b>Peripherals</b>	Single/dual cassette, 1-6 diskettes, impact printer, card readers, line printers, audio alarm	1-6 diskettes, impact printer, 10MB disk, 9-1k. tape, audio alarm, ID reader, light pen	3274 type diskette, impact printer, badge reader, light pen	Impact printer, opt. bar code reader and printer controller for terminal sharing	Opt. diskette and serial printer, audio alarm std.; parallel printer sharing
<b>Display Pricing</b> -year lease/maint	\$5,000 base —	\$4,000 base —	\$2,600 \$78/month	\$750-\$1,750 \$39-\$113/month	\$1,600-\$4,000 —
<b>Controller Pricing</b> -year lease/maint	\$4,980 —	— —	\$6,800 \$212/month	— —	— —
<b>Comments</b>					Up to 49K bytes of RAM and PROM

Manufacturer	Control Data	Control Data	Control Data	Control Data	Courier
<b>Model Highlights</b> 1st ship/# shipped Standalone or cluster Display format Character format Character code Programmable? Editing? Compatibility	Model 711 06/71 1,000 shipped Standalone, multi-drop 16 lines of 80 chars 5x9 dot matrix ASCII Not programmable Opt. char & line editing	Model 714 07/73 500 shipped Up to 15-unit cluster 8 or 16 lines of 80 chars 5x9 dot matrix ASCII Not programmable Opt. char & line editing	Models 751 and 752 09/76 1,000+ shipped Standalone 24 lines of 80 chars 7x9 dot matrix ASCII Not programmable Char & line edit (751 only) Teletype compatible	Models 92451 and 92452 10/75 # shipped NG Stand. (275); 32-cluster (270,277) 12x80/ 24x80 opt. 7x9 dot matrix ASCII Not programmable Opt. char & line edit (51) Teletype compatible	270 Series 1974 # shipped NG Stand. (275); 32-cluster (270,277) 12x40/ to 43x80 7x9 dot matrix ASCII or EBCDIC Not programmable Character editing IBM 3270 compatible
<b>Display Features</b>	8 x 10 screen Reverse video, scrolling, opt. protect and partial transmit	8 x 10 screen Reverse video, scroll- ing, opt. protect and partial transmit	12-inch screen Brightness levels, blinking, scrolling, paging, address/read cursor, protect, partial transmit	8 x 5½ screen Brightness levels, blinking, scrolling (51), paging (opt. 51), address/ read cursor (address only 52), protect and partial transmit (opt. 51)	7 x 10 screen Reverse video opt., brightness levels, blinking opt., address/ read cursor, protect, partial transmit
<b>Communications</b> Line protocol Transmission Speed Interfaces Other features	Synchronous ASCII or CDC BSC Half-duplex 2,000 to 4,800bps RS232C Poll/addressing and autoanswer std.	Synchronous ASCII or CDC BSC Full- or half-duplex 2,000 to 4,800bps RS232C or current loop Poll/addressing and autoanswer std.	Asynchronous ASCII Full- or half-duplex 110 to 9,600bps RS232C Poll/addressing and autoanswer opt. (751)	Asynchronous ASCII Full- or half-duplex 110 to 9,600bps RS232B/C, CCITT V.24 Poll/addressing and autoanswer opt. (51)	Synchronous BSC, SDLC, 270 Half-duplex 9,600bps RS232B/C Poll/addressing std.
<b>Keyboard</b>	Typewriter style with numeric pad	Typewriter keyboard with numeric pad	Detachable; typewriter style with numeric pad	Detachable; typewriter style with numeric pad (std. 51, opt. 52)	Detachable; typewriter or data entry style with opt. numeric pad
<b>Peripherals</b>	Impact or non-impact printer, audio alarm	Impact or non-impact printer, audio alarm	Single/dual cassette (751), impact or non- impact printer, audio alarm	S-D cassette and disk- ette (opt. 51), impact or non-impact printer, audio alarm	Single diskette drive (270), impact printer (270 and 275)
<b>Display Pricing</b> 1-year lease/maint	\$3,969-\$4,662 \$110-\$140/month	\$3,465-\$4,095 \$85-101/month	\$3,150-\$3,765/\$1,650-\$1,750 \$100-\$134; \$55/month	\$2,000-\$2,350/\$1,000-\$1,500 —	Vendor will not release pricing
<b>Controller Pricing</b> 1-year lease/maint	— —	\$5,300-\$6,013 \$134-\$150/mo (2-yr)	— —	— —	— —
<b>Comments</b>				Model 92451 had 1K-6K RAM, 4K-8K PROM memory	

Manufacturer	Courier	Data 100	Data General	DatagraphIX	Datamedia
<b>Model Highlights</b> 1st ship/# shipped Standalone or cluster Display format Character format Character code Programmable? Editing? Compatibility	700 1977 # shipped NG Standalone or 32-unit cluster 12x80/ 24/80 7 x 10 dot matrix ASCII Not programmable Char & line editing Honeywell 7700 and 7760 VIP compatible	Model 82 02/77 450 shipped Up to 18-unit cluster 24 lines of 80 chars 7x9 dot matrix EBCDIC Not programmable Char & line editing IBM 3270 compatible	Models 6052 and 6053 10/76 # shipped NG Standalone 24 lines of 80 chars 5x7/5x8 dot matrix ASCII Not programmable No editing Teletype compatible	DataMAX 132A 11/77 # shipped NG Standalone 30 lines of 132 chars Characteron ASCII Not programmable Char & line editing Teletype compatible Others available	Elite 1520 06/75 1,000+ shipped Standalone 24 lines of 80 chars 5x7/9 dot matrix ASCII Not programmable No editing Teletype compatible
<b>Display Features</b>	7 x 10 screen Reverse video cursor only, brightness levels, blinking, address cursor, protect, partial transmit	14-inch screen Brightness levels, opt. blinking, read cursor, protect, partial transmit	6 x 9 screen Brightness levels (6053), blinking, scrolling, address cursor	8 x 11 screen Brightness levels, scrolling, address/ read cursor, partial transmit	6 x 9 screen Scrolling, address cursor
<b>Communications</b> Line protocol Transmission Speed Interfaces Other features	Synchronous VIP Half-duplex To 9,600bps RS232C	Synchronous BSC or SDLC Full- or half-duplex Up to 9,600bps RS232C Poll/addressing and autoanswer std.	Asynchronous ASCII Full-duplex 110 to 9,600bps RS232C	Asynchronous ASCII Full- or half-duplex 110 to 9,600bps RS232C or current loop	Asynchronous APL or ASCII Full- or half-duplex 50 to 9,600bps RS232C, CCITT V.24 Opt. modem & coupler
<b>Keyboard</b>	Detachable; typewriter or data entry style with opt. numeric pad	Detachable; typewriter or data entry style	Detachable; typewriter style with numeric pad	Detachable; typewriter style	Detachable; typewriter style with opt. numeric pad
<b>Peripherals</b>	Diskette (cluster only), impact printer	Single diskette drive, line printers, audio alarm	Impact printer, audio alarm	Printer interface, audio alarm	Printer interface, audio alarm
<b>Display Pricing</b> 1-year lease/maint	Vendor will not release pricing	\$3,066 \$91/month	\$1,990/\$2,290 Purchase only	\$3,950-\$4,450 \$226-\$263/month	\$2,150-\$2,200 \$85/month
<b>Controller Pricing</b> 1-year lease/maint		\$9,942 \$252/month	\$400 —	— —	— —
<b>Comments</b>		Available as a single- or dual-processor config. or on- and off- line data entry and batch processing; attached applications processor adds COBOL and RPG capability			For APL users; available in portable version with small screen

Manufacturer	Datamedia	Datamedia	Datamedia	Datapoint	Datapoint
<b>Model Highlights</b> 1st ship/# shipped Standalone or cluster Display format Character format Character code Programmable? Editing? Compatibility	Elite 1521A 06/77 1,000+ shipped Standalone 24 lines of 80 chars 5x7/9 dot matrix ASCII Not programmable No editing Teletype compatible	Elite 2500A and 4000A 07/73 1,000+ shipped Standalone 24 lines of 80 chars 5x7/9 dot matrix ASCII/CII Programmable (4000A) Opt. char & line editing Teletype compatible	Elite 3025A and 3052A 01/78 # shipped NG Standalone 24 lines of 80 chars 5x9 dot matrix ASCII Not programmable Char & line editing	3600 and 3610 12/74 2,400 shipped Standalone 24 lines of 80 chars 5x7 dot matrix ASCII Not programmable No editing Datashare/Multiform compatible	1100 Series 02/75 700+ shipped Standalone or 4-unit cluster 12 lines of 80 chars 5x7 Standalone ASCII or EBCDIC Programmable Programmable editing Opt. IBM and Teletype compatible
<b>Display Features</b>	6 x 9 screen Brightness levels, scrolling, address cursor	6 x 9 screen Reverse video (4000A), brightness levels, blink- ing, scrolling, paging (4000A), address cursor, protect, partial transmit	6 x 9 screen Reverse video, bright- ness levels, blinking, scrolling, paging opt. (3025A), address/read cursor, protect, partial transmit	5 x 8 screen 1 color, scrolling, address cursor	3½ x 7 screen Scrolling, paging, programmable cursor, protect, partial transmit
<b>Communications</b> Line protocol Transmission Speed Interfaces Other features	Asynchronous ASCII Full- or half-duplex 50 to 9,600bps RS232C	Asynchronous ASCII Full- or half-duplex 50 to 9,600bps RS232C or current loop Poll/addressing opt. (4000A), opt. modem, opt. coupler (4000A)	Asynchronous/synchronous ASCII Full- or half-duplex 50 to 9,600bps RS232C or current loop	Asynchronous ASCII Full-duplex 110 to 9,600bps RS232B/C	Asynchronous/synchronous ASCII, BSC or SDLC Full- or half-duplex Up to 40.8Kbps RS232C Opt. poll/addressing, autoansw, modem, coupler
<b>Keyboard</b>	Detachable; typewriter style with opt. numeric pad	Detachable; typewriter style with numeric pad	Detachable; typewriter style with numeric pad	Typewriter style with numeric pad	Typewriter style with numeric pad
<b>Peripherals</b>	Audio alarm; RS232C interface provided	Audio alarm; RS232C interface provided	RS232C interface provided	Impact printer, audio alarm	1 to 4 diskettes; impact printer, matrix, belt & drum printers & 7-/9-tk, mag tape drives
<b>Display Pricing</b> 1-year lease/maint	\$1,200-\$1,250 \$65/month	\$2,080-\$2,480 (2500A) \$85-\$95/month (2500A)	\$1,700 \$85/month	\$1,950 \$77/month	\$13,790-\$16,890 \$313-\$475/month
<b>Controller Pricing</b> 1-year lease/maint	—	—	—	—	—
<b>Comments</b>					



Manufacturer	Datapoint	Dataview	Dataview	Dataview	Delta Data
<b>Model Highlights</b> 1st ship/# shipped Standalone or cluster Display format Character format Character code Programmable? Editing? Compatibility	1500 09/77 # shipped NG Standalone 24 lines of 80 chars 5x7 dot matrix ASCII or EBCDIC Programmable Programmable editing Opt. IBM 3780 and Teletype compatible; others available	Marquis 01/77 # shipped NG Standalone 24 lines of 80 chars 5x7 dot matrix ASCII Not programmable No editing Teletype compatible	Marquis/X-Y 09/77 # shipped NG Standalone 24 lines of 80 chars 7x9 dot matrix ASCII or EBCDIC Not programmable No editing	Monarch and Titan 01/78 # shipped NG Standalone 24 lines of 80 chars 7x9 dot matrix ASCII or EBCDIC Not programmable Char & line editing Teletype compatible IBM, DEC, others opt.	Models 4000 and 4500 02/75 2,000+ shipped Standalone 25 lines of 80 chars 5x7 dot matrix ASCII Programmable Char & line editing Teletype compatible or IBM 3270/2260/2265
<b>Display Features</b>	5.5 x 8.35 screen Brightness levels, blinking, scrolling, paging, programmable cursor, protect, partial transmit	12-inch screen Scrolling, address/ read cursor	7 x 9 screen Reverse video, bright- ness levels, scrolling, address cursor (read opt.)	7 x 9 screen Reverse video, bright- ness levels, blinking (Titan), scrolling, paging, address/read cursor, protect, partial transmit	6 x 11 screen Reverse video, bright- ness levels, blinking, scrolling, paging, address/read cursor, protect, partial transmit
<b>Communications</b> Line protocol Transmission Speed Interfaces Other features	Asynchronous/synchronous ASCII Full- or half-duplex 50 to 9,600bps RS232C Poll/addressing opt., autoanswer std.	Asynchronous ASCII Full- or half-duplex Up to 9,600bps RS232C or current loop	Asynchronous ASCII Full- or half-duplex 75 to 9,600bps RS232C or current loop	Asynchronous/synchronous ASCII/BSC/SDLC Full- or half-duplex 75 to 19,200bps RS232C or current loop Poll/addressing (opt. Monarch; std. Titan)	Asynchronous/synchronous ASCII, others Full- or half-duplex 110 to 9,600bps RS232C (B/C, 4500); curr loop Poll/addressing and auto- answer opt.
<b>Keyboard</b>	Typewriter style with numeric pad	Typewriter style	Detachable (opt.); type- writer style with opt. numeric pad	Detachable (opt.); type- writer style with numeric pad	Detachable (opt.); typewriter style with numeric pad
<b>Peripherals</b>	Dual diskette drives, printer interface, opt. Freedom printer	Audio alarm	RS232C interface provided	RS232C interface provided	Single and dual cassette & diskette, impact/non- impact printer, audio alarm, light pen opt., others
<b>Display Pricing</b> 1-year lease/maint	— —	— —	— —	\$1,435-\$1,995/\$2,195 base —	\$2,425/\$3,750-\$4,450 \$122/\$178-\$208/month
<b>Controller Pricing</b> 1-year lease/maint	\$5,950 Purchase only	\$1,195 —	\$895-\$1,295 —	— —	— —
<b>Comments</b>	Price includes dual diskette drives, pro- cessor with 4K ROM & 32K RAM, comm. interface, & software			Emulation protocol for several prominent terminals; Intel 8055; split data rates	4000 offers PROM or ROM to 16K with user program; 4500 memory can be mixed ROM, PROM, RAM to 20K; software available

Manufacturer	Delta Data	Delta Data	Delta Data	Delta Data	Delta Data	Digi-Log
<b>Model Highlights</b> 1st ship/# shipped Standalone or cluster Display format Character format Character code Programmable? Editing? Compatibility	Model 4100 11/77 # shipped NG Standalone 25 lines of 80 chars 5x7 dot matrix ASCII Not programmable Char & line editing Teletype compatible	Model 4050 05/76 1,000 shipped Standalone 25 lines of 80 chars 5x7 dot matrix ASCII; others opt. Programmable Char & line editing Teletype, Burroughs, Univac and Honeywell compatible	Model 4300E 06/76 300 shipped Standalone 25 lines of 80 chars 5x7 dot matrix ASCII; others opt. Not programmable Char & line editing Teletype compatible	Model 6500 Controller 07/77 30+ shipped Up to 8-unit cluster 25 lines of 80 chars 5 x 7 dot matrix ASCII Programmable Char & line editing Teletype or IBM 3780 compatible	Model 6500 Controller 07/77 30+ shipped Up to 8-unit cluster 25 lines of 80 chars 5 x 7 dot matrix ASCII Programmable Char & line editing Teletype or IBM 3780 compatible	Microterm II 04/76 # shipped NG Standalone 24 lines of 80 chars 7x11 dot matrix Programmable codes Programmable Char & line editing Teletype compatible with emulator for IBM 2780
<b>Display Features</b>	6 x 11 screen Reverse video, blink- ing, scrolling, paging, address/read cursor, protect, partial transmit	6x11 screen Reverse video, opt. brightness levels, blinking, scrolling, paging, address/read cursor, protect, partial transmit	6 x 11 screen Reverse video, opt. brightness levels, blinking, scrolling, paging, address/read cursor, protect, partial transmit	Uses any of the Delta 4000 Series displays except 4050	6 x 9 screen Reverse video, bright- ness levels, blinking, scrolling, paging, address/read cursor, protect, partial transmit	
<b>Communications</b> Line protocol Transmission Speed Interfaces Other features	Asynchronous/synchronous ASCII Full- or half-duplex 110 to 9,600bps RS232C or current loop Poll/addressing opt.	Asynchronous/synchronous ASCII Full- or half-duplex 110 to 9,600bps RS232C or current loop Opt. poll/addressing and autoanswer	Asynchronous/synchronous ASCII Full- or half-duplex 110 to 9,600bps RS232C Poll/addressing opt.	Asynchronous/synchronous ASCII or BSC Full- or half-duplex 110 to 4,800bps RS232C	Asynchronous/synchronous Full- or half-duplex 50 to 19,200bps RS232C Poll/addressing and autoanswer	
<b>Keyboard</b>	Typewriter style with numeric pad	Detachable (opt.); typewriter style with numeric pad	Detachable (opt.); type- writer style with numeric pad	Detachable (opt.); type- writer style with numeric pad	Typewriter style with numeric pad	
<b>Peripherals</b>	Cassette, diskette inter- face, impact printer	Cassette, diskette inter- face, impact/non-impact printer, audio alarm, opt. light pen	Cassette, diskette inter- face, impact printer	1 to 6 diskettes, impact printer	Cassette interface, single/dual diskette, impact/non-impact printer	
<b>Display Pricing</b> 1-year lease/maint	\$1,795 Purchase only	\$2,995 \$150/month	\$3,500-\$3,755 \$168-\$178/month	— —	\$6,170-\$9,175 —	
<b>Controller Pricing</b> 1-year lease/maint	— —	— —	— —	\$5,960 base \$314/month base	— —	
<b>Comments</b>			Designed for text editing	Features 32K to 64K bytes of RAM memory and two 8080 micro- processors	Software includes text processor and program- mable protocols; dual Z-80's	

Manufacturer	Digi-Log	DEC	DEC	DEC	Elbit
<b>Model Highlights</b> 1st ship/# shipped Standalone or cluster Display format Character format Character code Programmable? Editing? Compatibility	TeleComputer II 09/75 800+ shipped Up to 10-unit standalone 16x40/ 16x80 5x7 dot matrix ASCII Not programmable No editing Teletype compatible	Model VT-50 09/74 # shipped NG Standalone 12 lines of 80 chars 5x7 dot matrix ASCII Not programmable No editing Teletype compatible	VT-52 and VT-61/t 12/75 # shipped NG Standalone 24 lines of 80 chars 7x7/7x8 dot matrix ASCII Not programmable Char and line edit (VT-61/t) Teletype compatible	DEC station 78 09/77 # shipped NG Standalone 24 lines of 80 chars 7x7 dot matrix ASCII Programmable Programmable editing Teletype compatible	DS 1920 01/76 # shipped NG Standalone 24 lines of 80 chars 5x8 dot matrix ASCII Not programmable Character editing Teletype compatible
<b>Display Features</b>	Variable size screen Blinking, scrolling, opt. address cursor	8.7 x 4.3 screen Scrolling	8.7 x 4.3 screen Address cursor, partial transmit	8.7 x 4.3 screen Scrolling, paging, address cursor, protect, partial transmit	8 x 5¼/6¼ x 10¼ screen Blinking, scrolling, opt. address/read cursor, protect, partial transmit
<b>Communications</b> Line protocol Transmission Speed Interfaces Other features	Asynchronous ASCII Full- or half-duplex 75 to 9,600bps RS232C, CCITT, curr loop Opt. modem and coupler	Asynchronous ASCII Full- or half-duplex 75 to 9,600bps RS232C Opt. coupler	Asynchronous ASCII (VT-61/t) Full- or half-duplex 75 to 9,600bps RS232C or current loop	Asynchronous ASCII Full- or half-duplex 50 to 19,200bps RS232C (two) Poll/addressing std.	Asynchronous ASCII Full- or half-duplex 110 to 9,600bps RS232B/C or current loop
<b>Keyboard</b>	Detachable; Teletype style	Typewriter style	Typewriter style with numeric pad	Typewriter style with numeric pad	Detachable; typewriter style with numeric pad
<b>Peripherals</b>	5-inch portable CRT, audio alarm, RS232C interface	Non-impact printer, audio alarm	Non-impact printer, audio alarm	Dual diskette, parallel printer interface	Printer interface, audio alarm
<b>Display Pricing</b> 1-year lease/maint	\$250-\$350 —	\$1,450 Purchase only	\$2,310/\$3,100 Purchase only	\$7,995 base Purchase only	\$1,150-\$1,784 Purchase only
<b>Controller Pricing</b> 1-year lease/maint	\$1,395-\$1,570 —	\$60 —	— —	— —	— —
<b>Comments</b>	Can attach to a TV monitor	Provides local copy of displayed data via integral printer		Price includes LSI PDP-8 with 32K RAM, dual diskette drives, and all software	

Manufacturer	Four-Phase	Four-Phase	Four-Phase	Genesis One	Goodwood
<b>Model Highlights</b> 1st ship/# shipped Standalone or cluster Display format Character format Character code Programmable? Editing? Compatibility	System IV/40 07/73 see IV/70 UP to 16-unit cluster 24x48/ 24x80 7x9 dot matrix ASCII or EBCDIC Programmable Char & line editing IBM 3270, 2260/2265, and 2848 compatible; others	System IV/50 12/76 see IV/70 Standalone or 24-cluster 24x48/ 24x80 7x9 dot matrix ASCII or EBCDIC Programmable Char & line editing IBM 3270, 2260/2265, 3770 compatible; others	System IV/70 02/71 35,000+ shipped (all) Up to 32-unit cluster 24x48/ 24x80 7x9 dot matrix ASCII or EBCDIC Programmable Char & line editing IBM 3270, 2260/2265, and 2848; others	G77C "The Plug" 01/75 5,000 shipped Up to 32-unit cluster 12x40/ 24x80 5x7 dot matrix Not programmable Character editing IBM 3270 compatible	GDS-100 04/73 100+ shipped Standalone 12x40/ 24x80 5x7 dot matrix IBM Correspondence Not programmable No editing IBM 2701, 2741 compatible
<b>Display Features</b>	7¼ x 10¼ screen Brightness levels, blinking, scrolling, paging, address/read cursor, protect, partial transmit	7¼ x 10¼ screen Brightness levels, blinking, scrolling, paging, address/read cursor, protect, partial transmit	7¼ x 10¼ screen Brightness levels, blinking, scrolling, paging, address/read cursor, protect, partial transmit	7 x 10¼ screen Brightness levels, address/read cursor, protect, partial transmit	Variable size screen Scrolling, address cursor
<b>Communications</b> Line protocol Transmission Speed Interfaces Other features	Asynchronous/synchronous BSC or SDLC Full- or half-duplex 1,200 to 9,600bps RS232B/C Poll/addressing and autoanswer std.	Asynchronous/synchronous BSC or SDLC Full- or half-duplex 1,200 to 9,600bps RS232B/C Poll/addressing and autoanswer std.	Asynchronous/synchronous BSC or SDLC Full- or half-duplex 1,200 to 9,600bps RS232B/C Poll/addressing and autoanswer std.	See comments	Asynchronous IBM 2741 Full-duplex 134.5bps RS232C Coupler std.
<b>Keyboard</b>	Detachable; typewriter style with numeric pad	Detachable; typewriter style with numeric pad	Detachable; typewriter style with numeric pad	Detachable; typewriter style with numeric pad	Detachable; typewriter style
<b>Peripherals</b>	Diskette, impact printer, disk & tape drives, card reader, line printer, opt. audio alarm	Diskette, impact printer, disk drives & line printers, audio alarm opt.	Diskette, impact printer, disk & tape drives, card reader, line printers, opt. audio alarm	Impact printer, audio alarm, ID card reader, opt. light pen	
<b>Display Pricing</b> 1-year lease/maint	\$1,915 \$47/month	\$2,415 \$51/month	\$1,915 \$47/month	\$3,800 #113/month (2-year)	\$1,800-\$2,200 —
<b>Controller Pricing</b> 1-year lease/maint	\$13,865 \$295/month	\$17,085 \$199/month	\$16,000 \$370/month	— —	— —
<b>Comments</b>	Available with System IV/30; see IV/70	Avail. with System IV/55, a small term- inal with 1 or 2 display stations & limited capability	Avail. with System IV/30, a small term- inal with 1 or 2 display stations and limited capability	Replaces IBM 3277-2 Display Station; plugs into IBM 3271-2 (remote) or 3272-2 (local) Control Units, System 370 via Local Display Adapter, or 3771	Portable controller with keyboard; uses video monitor; re- places the IBM 2741



# The complete IBM 360/370. Only

**On-line** systems emulate IBM 3211/3811 or 1403/2821 printer controllers. No changes are required in IBM hardware, operating system or application software. The

intelligent controller adapts to changes in computer models, channel protocols or new applications. And the system accepts vector data

for fast electrostatic plotting without excessive CPU or I/O overhead.

## 72 sec.

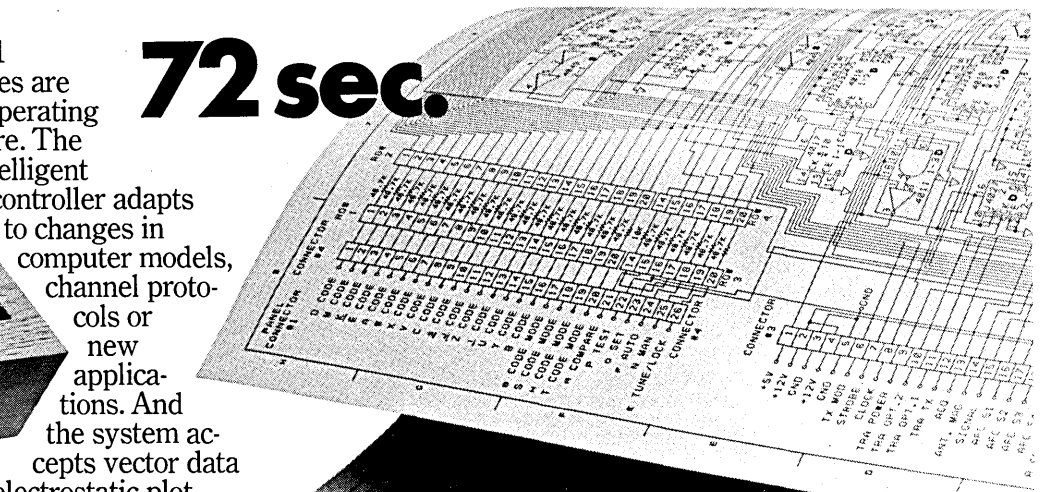
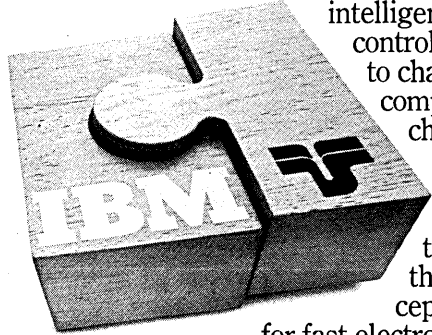

NO.	DESCRIPTION	UNIT
800	DESIGN	100
801	CONSTRUCTION	100
802	PRODUCTION	100
803	TESTING	100
804	REVISIONS	100
805	FINAL DESIGN	100
806	PROTOTYPE	100
807	FINAL PRODUCTION	100
808	REVISIONS	100
809	FINAL DESIGN	100
810	PROTOTYPE	100
811	FINAL PRODUCTION	100
812	REVISIONS	100
813	FINAL DESIGN	100
814	PROTOTYPE	100
815	FINAL PRODUCTION	100
816	REVISIONS	100
817	FINAL DESIGN	100
818	PROTOTYPE	100
819	FINAL PRODUCTION	100
820	REVISIONS	100
821	FINAL DESIGN	100
822	PROTOTYPE	100
823	FINAL PRODUCTION	100
824	REVISIONS	100
825	FINAL DESIGN	100
826	PROTOTYPE	100
827	FINAL PRODUCTION	100
828	REVISIONS	100
829	FINAL DESIGN	100
830	PROTOTYPE	100
831	FINAL PRODUCTION	100
832	REVISIONS	100
833	FINAL DESIGN	100
834	PROTOTYPE	100
835	FINAL PRODUCTION	100
836	REVISIONS	100
837	FINAL DESIGN	100
838	PROTOTYPE	100
839	FINAL PRODUCTION	100
840	REVISIONS	100



"One weekend we needed fifty maps. Our Versatec got them out in two days. We simply couldn't have done it on CalComp."

Only Versatec can give you ten paper widths —from economical 8-1/2" to super-wide 72".

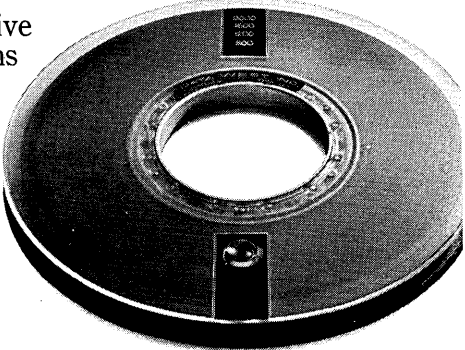

**Off-line** systems accept vector, raster or print data on IBM-compatible tapes.

Versatec plots courtesy of Oakridge National Laboratory-Computer Sciences Division, Sandia Laboratories, City of Atlanta, and Systonetics. Use does not necessarily reflect their endorsement.



# output system for y from Versatec.

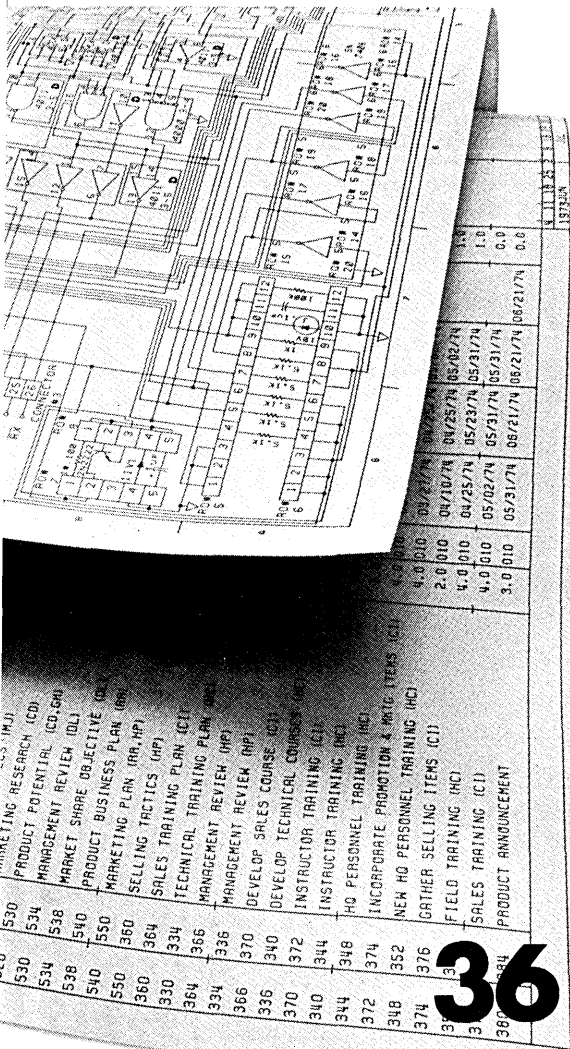

**88 sec.**

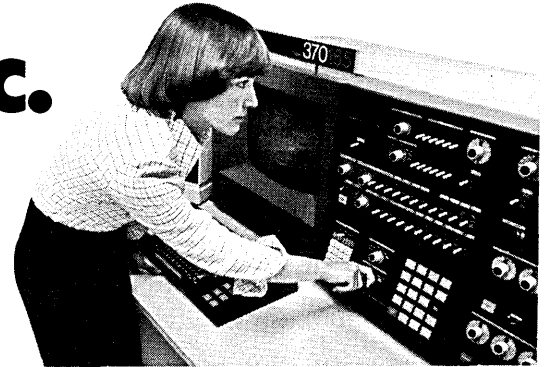

"CPU time is no problem. Total I/O and CPU time for 33,000 vectors is less than ten seconds"

Don't wait. Check the readers' service number for Users' Report and system brochure. The coupon will bring you specific facts and samples.

Versatec  
2805 Bowers Avenue  
Santa Clara, California 95051  
(408) 988-2800

Send facts:

- The 360/370 output system
  - On-line  Off-line
  - Remote
- IBM Users' Report
- Plotters, printers and printer/plotters (Paper widths: 8-1/2", 11", 20", 22", 24", 36", 42", 50", 63", 72")
  - Hard copy from CRT
  - Hard copy from video sources
- Versaplot™ software

Send samples:

- Computer aided design
- Mapping
- Production drawings
- Business graphics
- Scientific graphics
- Printing
- Gray scale halftones

**36 sec.**

**Remote** systems with Remote Spooling Vector Processor (RSVP™) accept vector, raster or print data via teleprocessing lines. Emulating IBM 2780/3780 terminals, RSVP provides complete remote job entry. Remote operation controls provide for transfer from line to tape or printer/plotter with automatic copies available to printer/plotter immediately after reception. Local operation supports tape to printer/plotter; card to tape or printer.



Computer model and operating system \_\_\_\_\_

Name \_\_\_\_\_ Telephone \_\_\_\_\_

Organization \_\_\_\_\_

Address \_\_\_\_\_

City, State and Zip \_\_\_\_\_



™RSVP and Versaplot are Versatec trademarks. \*XEROX is a trademark of XEROX CORPORATION.

Manufacturer	Goodwood	Goodwood	Harris	Harris	Harris
<b>Model Highlights</b> 1st ship/# shipped Standalone or cluster Display format Character format Character code Programmable? Editing? Compatibility	GDS-300, -400 & -500 07/84 # shipped NG Stand. or 4/B/16-cluster 8x32/ 24x80 5x7 dot matrix ASCII Not programmable No editing Teletype compatible or IBM 3270, 2260/2265	GDS-366 Date and shipments NG Up to 32-unit cluster 24 lines of 80 chars 5x7 dot matrix ASCII Programmable Char & line editing Teletype compatible; IBM 2780/3780	804/810 12/71 2,000+ shipped Standalone or cluster 12 or 24 x 40 or 80 5x7 dot matrix ASCII or EBCDIC Programmable Opt. char & line editing IBM 2260/2265 compatible	8170 and 8180 1974 5,000 shipped Up to 32-unit cluster 12 or 24 x 40 or 80 7x9 dot matrix EBCDIC or ASCII Programmable Char & opt. line editing IBM 3270 BSC, SDLC compatible; 2260/2265 (8170)	8210 and 8220 1975 450 shipped Stand. or 32-cluster 12, 14 or 24 x 80;16x64 7x9 dot matrix ASCII Not programmable Char & line editing Univac 100/200 com- patible (8210); Bur- roughs TD 800 (8220)
<b>Display Features</b>	Variable size screen Reverse video opt., blinking, address cursor	12-inch screen Reverse video, brightness levels, blinking, scrolling, paging, address/ read cursor, protect, partial transmit	7½ x 9½ screen Brightness levels, blinking, address/ read cursor, opt. protect and partial transmit	12-inch screen Brightness levels, blinking, address/ read cursor, protect, partial transmit	12-inch screen Brightness levels, blinking, address/ read cursor, protect, partial transmit
<b>Communications</b> Line protocol Transmission Speed Interfaces Other features	Asynchronous ASCII Full-duplex 1,200 to 9,600bps RS232C Opt. autoanswer (400 & 500)	Asynchronous/synchronous ASCII Full- or half-duplex 300 to 9,600bps RS232C	Asynchronous/synchronous BSC or SDLC Full- or half-duplex 110 to 9,600bps RS232C Poll/addressing and autoanswer opt.	Synchronous BSC/SDLC Half-duplex 1,200 to 9,600bps RS232C Poll/addressing std., autoanswer opt.	Asynchronous/synchronous ASCII Full- or half-duplex 4,800 to 9,600/300 to 9,600bps RS232C Poll/addressing std.
<b>Keyboard</b>	Detachable; typewriter style with opt. numeric pad	Detachable; typewriter style with numeric pad	Typewriter or data entry style with numeric pad	Detachable; typewriter or data entry style with numeric pad	Detachable; typewriter or data entry style with numeric pad
<b>Peripherals</b>	Light pen	Cassette, diskette, serial printer, disk, audio alarm	Dual cassette, impact printer, card reader, disk, audio alarm, light pen, mag tape (810)	Opt. dual diskette (8180), impact printer, disk drive (8180), audio alarm, light pen, ID card reader	Opt. dual diskette, impact printer, audio alarm
<b>Display Pricing</b> 1-year lease/maint	Vendor will not release pricing	Vendor will not release pricing	\$1,500 \$75/month	\$71,600/\$38,060 (6 displays) \$2,120;\$1,035/mo. (3-yr)	\$136,810/\$104,460 \$4,015;\$1,355/mo. (3-yr)
<b>Controller Pricing</b> 1-year lease/maint	—	—	\$7,000 \$2000/month	—	—
<b>Comments</b>			804 is stand-alone sys- tem; 810 is cluster system; former Sanders Data Systems products	Former Sanders Data Systems products	Former Sanders Data Systems products

Manufacturer	Harris	Hazeltine	Hazeltine	Hazeltine	Hazeltine
<b>Model Highlights</b> 1st ship/# shipped Standalone or cluster Display format Character format Character code Programmable? Editing? Compatibility	8770 1976 500 shipped Stand. or 32-cluster 12 or 24 x 80 or 22x48 7x9 dot matrix ASCII Not programmable Char & line editing Honeywell 775/7700 compatible	1000 & 1200 06/73 see 1500 Standalone 12 or 24 lines x 80 5x7 dot matrix ASCII Not programmable No editing Teletype compatible	1500 Series 06/73 65,000+ all models Standalone 24 lines of 80 chars 7x10 dot matrix ASCII Not programmable Line editing Teletype compatible	2000 and 3000 10/70 see 1500 Standalone 22 or 27 x 74/ 25x80 5x7 dot matrix ASCII Not programmable Char & line editing Teletype compatible (2000); customer- specified (3000)	Modular One 02/76 see 1500 Standalone 24 lines of 80 chars 7x9 dot matrix ASCII Not programmable Opt. char & line editing Teletype, Burroughs, Honeywell & Univac compatible
<b>Display Features</b>	12-inch screen Brightness levels, blinking, address/ read cursor, protect	4.6 x 9.2 screen Scrolling	6 x 9 screen Reverse video, brightness levels, scrolling, address/ read cursor, protect, partial transmit	6 x 8½ screen Brightness levels, blinking, scrolling, paging, address cursor, protect, partial transmit	6 x 9 screen Reverse video, brightness levels, blinking, scrolling, address/read cursor, protect, partial transmit
<b>Communications</b> Line protocol Transmission Speed Interfaces Other features	Synchronous Half-duplex 2,000 to 4,800bps RS232C Poll/addressing std.	Asynchronous ASCII Full- or half-duplex 110 to 9,600bps RS232B/C or curr loop Autoanswer opt.	Asynchronous ASCII Full- or half-duplex Up to 19,200bps RS232C or current loop	Async (synch opt.) User-defined Full- or half-duplex 110 to 9,600bps RS232B/C Poll/addressing (3000)	Async (sync. opt.) User-defined Full- or half-duplex 110 to 9,600bps RS232B/C Opt. poll/addressing
<b>Keyboard</b>	Detachable; typewriter or data entry style with numeric pad	Teletype style	Typewriter style with numeric pad	Detachable; Teletype style with numeric pad	Detachable; typewriter style with numeric pad
<b>Peripherals</b>	Opt. dual diskette, impact printer, audio alarm	Non-impact printer (1200), audio alarm	Serial printer inter- face	Dual cassette, impact/ non-impact printer, audio alarm	Audio alarm
<b>Display Pricing</b> 1-year lease/maint	\$39,700 \$1,090/month (3-yr)	\$1,590 (1200) \$65/month (1200)	\$1,225-\$1,650 \$130-\$173/month	\$2,250/\$3,900 \$98;\$125/month	\$1,650 \$125/month
<b>Controller Pricing</b> 1-year lease/maint	—	—	—	\$50-\$75/month	—
<b>Comments</b>	Former Sanders Data Systems products	1000 is only available refurbished for \$750	Contains Intel 8080 microprocessor; 1520 has 2K print buffer		



in RS-232 digital recorders

# Techtran does it best!



## New Datacassette Series

**\$950** and up  
... singles & duals available

- Now ANSI/ECMA compatible and TI 733, NCR...
- New character string search
- New powerful text editor
- AC & battery power
- Microprocessor controlled

## New Mini disc Series

**only \$1395**  
... much lower in OEM quantities

- Over 200K capacity per disc
- Hi speed random file access
- File directory on each disc automatically recorded/updated
- Self-initialized recording preformatted discs not required
- Microprocessor is resident program no operator loading

Nobody does it better

# TECHTRAN

INDUSTRIES, INC

200 Commerce Drive, Rochester, New York 14623  
Tel: (716) 334-9640 TWX: 510-253-3246  
Los Angeles Tel: (213) 349-0775

**Send for details today**

Manufacturer	Hewlett-Packard	Hewlett-Packard	Hewlett-Packard	Honeywell	Honeywell
<b>Model Highlights</b>	2640B	2641A and 2645A	2648A and 2649A	VIP 7100/7105	VIP 7200
1st ship/# shipped	01/76 25,000+ all mode	10/76 see 2640B	11/76 # shipped NG	12/75 200+ shipped	05/77 500+ shipped
Standalone or cluster	Standalone	Standalone	Standalone	Standalone	Standalone
Display format	24 lines of 80 chars	24 lines of 80 chars	24 lines of 80 chars	12 lines of 80 chars	24 lines of 80 chars
Character format	7x9 dot matrix	7x9 dot matrix	7x9 dot matrix	5x7 dot matrix	5x7 dot matrix
Character code	ASCII	ASCII or EBCDIC	ASCII, EBCDIC, user-spec	ASCII	ASCII
Programmable?	Not programmable	Not programmable	Programmable (2649A)	Not programmable	Not programmable
Editing?	Char & line editing	Char & line editing	Char & line editing	No editing	No editing
Compatibility	Opt. Teletype compatible	Opt. Teletype compatible	Teletype compatible (2648A)	Teletype compatible	Teletype compatible
<b>Display Features</b>	5 x 10 screen Reverse video, brightness levels, opt. blinking, scrolling, paging, address/read cursor, protect, partial transmit	5 x 10 screen Reverse video, brightness levels, opt. blinking, scrolling, paging, address/read cursor, protect, partial transmit	5 x 10 screen Reverse video, brightness levels, opt. blinking, scrolling (opt. 2649A), paging, address/read cursor, protect, partial transmit	12-inch screen Scrolling	12-inch screen Brightness levels, opt. blinking, scrolling, address/ read cursor
<b>Communications</b>	Asynchronous ASCII	Synchronous ASCII or BSC	Asynchronous/synchronous ASCII or BSC	Asynchronous ASCII	Asynchronous ASCII
Line protocol	Full- or half-duplex	Full- or half-duplex	Full- or half-duplex	Full-duplex	Full- or half-duplex
Transmission	110 to 2,400bps	110 to 9,600bps	110 to 9,600bps	75 to 9,600bps	75 to 9,600bps
Speed	RS232C or current loop	RS232C or current loop	RS232C or current loop	RS232C, CCITT, curr loop	RS232C or current loop
Interfaces	Autoanswer opt.	Poll/addressing and autoanswer opt.	Poll/addressing and autoanswer opt.		
Other features					
<b>Keyboard</b>	Detachable; typewriter style with numeric pad	Detachable; typewriter style with numeric pad	Detachable; typewriter style, opt. numeric pad (2649A)	Detachable; typewriter style	Detachable; typewriter style with numeric pad
<b>Peripherals</b>	Impact/non-impact printer, audio alarm	Dual cassette drive, impact/non-impact printer, audio alarm	Dual cassette drive, printer interface, audio alarm	Audio alarm	
<b>Display Pricing</b>	\$2,600	\$4,100/\$3,500	\$5,500/\$2,150-\$6,000	\$1,500	\$1,580-\$1,980
1-year lease/maint	\$137/month	\$216; \$184/month	\$290/month (2648A)	Purchase only	Purchase only
<b>Controller Pricing</b>	—	—	—	—	—
1-year lease/maint	—	—	—	—	—
<b>Comments</b>			2648A has graphics capability with 360 x 720 dot matrix; plotting software		

Manufacturer	Honeywell	Honeywell	Honeywell	IBM	IBM
<b>Model Highlights</b>	VIP 7700	VIP 7700R/7705R	VIP 7760	3275	3276
1st ship/# shipped	10/73 5,000+ shipped	03/77 2,000+ shipped	05/76 2,000+ shipped	1972 # shipped NG	02/78 # shipped NG
Standalone or cluster	Stand. or 10-unit cluster	Up to 10-unit standalone	8- to 32-unit cluster	Standalone	Up to 8-unit cluster
Display format	12 or 24 lines of 80	24 lines of 80 chars	12 or 24 lines of 80	12 or 24 lines of 80	24/32/40/43 x 80
Character format	5x7 dot matrix	5x7 dot matrix	7x9 dot matrix	7x9 dot matrix	7x9 or 14 dot matrix
Character code	Honeywell	ASCII	ASCII	ASCII or EBCDIC	ASCII or EBCDIC
Programmable?	Not programmable	Not programmable	Not programmable	Not programmable	Not programmable
Editing?	Char & line editing	Char & line editing	Char & line editing	Character editing	Character editing
Compatibility	Honeywell compatible	Honeywell compatible	Honeywell compatible	IBM 3270 System compatible	IBM 3270 System compatible
<b>Display Features</b>	5½ x 8½ screen Blinking, address cursor, protect, partial	12-inch screen Blinking, address cursor, protect, partial transmit	6 x 9 screen Blinking, paging, address/read cursor, protect, partial transmit	14-inch screen Brightness levels, address cursor, protect, partial transmit	14-inch screen Brightness levels, address cursor, protect, partial transmit
<b>Communications</b>	Asynchronous ASCII	Synchronous Honeywell	Synchronous VIP	Synchronous BSC/SDLC	Synchronous BSC/SDLC
Line protocol	Half-duplex	Half-duplex	Full- or half-duplex	Full- or half-duplex	Full- or half-duplex
Transmission	2,000 to 4,800bps	2400, 4800 or 9600bps	2400,4800 or 9600bps	1,200 to 9,600bps	1,200 to 9,600bps
Speed	RS232C	RS232C or CCITT	RS232C or CCITT V.24	RS232C	RS232C
Interfaces	Poll/addressing std., autoanswer opt.	Poll/addressing std., autoanswer opt.	Poll/addressing std., autoanswer opt.	Poll/addressing std.	Poll/addressing std.
Other features					
<b>Keyboard</b>	Typewriter style with numeric pad	Detachable; typewriter style with numeric pad	Detachable (opt.); typewriter style with numeric pad	Several detachable styles avail. with numeric pad	Several detachable styles avail. with numeric pad
<b>Peripherals</b>	Dual cassette, im- pact printer, opt. ID card reader	Impact printer	Diskette, opt. printer	Impact printer, audio alarm, ID card reader, opt. light pen	Impact printer, audio alarm, ID card reader, opt. light pen
<b>Display Pricing</b>	\$4,860-\$8,770	—	\$1,750	\$5,290-\$11,009	\$6,390
1-year lease/maint	\$157-\$285/month	\$174/month	\$51/month	\$150-\$360/month	—
<b>Controller Pricing</b>	\$3,025	\$3,390-\$3,990	\$16,800	—	—
1-year lease/maint	\$98/month	—	\$462/month	—	\$142/month (2-year)
<b>Comments</b>					



Manufacturer	IBM	IBM	IBM	IBM	Incoterm
<b>Model Highlights</b> 1st ship/# shipped Standalone or cluster Display format Character format Character code Programmable? Editing? Compatibility	3277 1972 # shipped NG Remote or local cluster 12/24 x 40/80 7x9 dot matrix EBCDIC; ASCII Not programmable Char & line editing IBM 3270; 3790 compatible	3278 03/78 # shipped NG Remote or local cluster 12/24 x 40/80 7x9 dot matrix EBCDIC; ASCII Not programmable Char & line editing IBM 3270; 3790 compatible	3790 1975 # shipped NG Up to 16-unit cluster 12x40/24x80 7x9 dot matrix EBCDIC Not programmable Character editing	5837 1976 # shipped NG Standalone 6 lines of 40 chars Gas panel ASCII or EBCDIC Not programmable No editing IBM 3275 compatible	SPD 300 Series 1974 # shipped NG 32-cluster/standalone 12 or 24 x 40 or 80 7x10 dot matrix ASCII or EBCDIC Not programmable Char & line editing IBM 3270 BSC compatible
<b>Display Features</b>	14-inch screen Address cursor, blinking, protect, partial transmit	14-inch screen Address cursor, blinking, protect, partial transmit	14-inch screen Brightness levels, address cursor, protect, partial transmit	Brightness levels, scrolling, protect	6½ x 9 screen Brightness levels, blinking, address/ read cursor, protect, partial transmit
<b>Communications</b> Line protocol Transmission Speed Interfaces Other features	Synchronous BSC or SDLC Full- or half-duplex 2,000 to 9,600bps RS232C Poll/addressing std.	Synchronous BSC or SDLC Full- or half-duplex 2,000 to 9,600bps RS232C Poll/addressing std.	Synchronous SDLC Half-duplex 1,200 or 2,400bps RS232C opt. Poll/addressing std., modem opt.	Synchronous BSC/SDLC Half-duplex 1,200 to 7,200bps RS232C Poll/addressing std., opt. 1200bps modem	Synchronous BSC/SDLC Full- or half-duplex 1,200 to 9,600bps RS232C Poll/addressing std.
<b>Keyboard</b>	6 detachable keyboard styles with numeric pad	6 detachable keyboard styles with numeric pad	Detachable; typewriter style with numeric pad	Block style with numeric pad	Detachable; typewriter style with numeric pad
<b>Peripherals</b>	3 character printers, line printer, bi-direc. matrix printer all opt.	3 character printers, line printer, bi-direc. matrix printer all opt.	IBM 3793 printer, disk, remote termi- nals, audio alarm, ID reader, light pen	Remote sensors	Cassette, dual diskette, impact printer, audio alarm
<b>Display Pricing</b> 1-year lease/maint	\$2,470-\$3,200 \$67-\$103/month	\$2,205-\$2,835 \$70-\$89/month		\$12,545-\$15,000 \$385-\$494/mo (5-yr)	Vendor will not release pricing
<b>Controller Pricing</b> 1-year lease/maint	\$4,735-\$6,945 \$148-\$248/month	\$5,630-\$7,550 \$148-\$248/month		—	—
<b>Comments</b>			Shared-processor system; pricing depends upon con- figuration	Data collection termi- nal for rugged factory environment; handles up to 16 lines to sensors	Incoterm was acquired by Honeywell early in 1978

Manufacturer	Incoterm	Incoterm	Incoterm	Inforex	Informer
<b>Model Highlights</b> 1st ship/# shipped Standalone or cluster Display format Character format Character code Programmable? Editing? Compatibility	SPD 10 Family 06/70 8,000+ shipped Standalone 15/30x64; 12/25x80 7x10, 8x12/14 (opt.) ASCII or EBCDIC Programmable Opt. char & line editing Teletype or IBM 3275 compatible	SPD 15 Family 04/74 # shipped NG Up to 32-unit cluster 12/24x80 or 15/30x64 7x10; 8x12 opt. ASCII or EBCDIC Programmable Opt. char & line editing Teletype compatible; IBM 3270	SPD 20 Family 1977 # shipped NG Up to 32-unit cluster 12 or 25 lines of 80 7x10; 8x12 opt. ASCII or EBCDIC Programmable Opt. char & line editing Teletype compatible; IBM 3270, 2260, others	7000 04/77 # shipped NG Standalone or 8-cluster 24 lines of 80 chars 5x7 dot matrix ASCII or EBCDIC Programmable Character editing IBM 2780/3780 com- patible	301 & 302 Series 08/73 7,000+ shipped Stand (301) 128-cl (302) 16 lines of 32 chars 5x7 dot matrix ASCII Not programmable No editing Teletype compatible
<b>Display Features</b>	6½ x 9 screen Brightness levels, opt. blinking, opt. scrolling, address/ read cursor, opt. protect and partial transmit	6½ x 9 screen Brightness levels, opt. blinking, scrolling and paging; address/read cursor, protect, opt. partial transmit	6½ x 9 screen Brightness levels, opt. blinking, scrolling and paging; address/ read cursor, protect, opt. partial transmit	6 x 8.4 screen Brightness levels, blinking, scrolling, address/read cursor, protect, partial transmit	3½ x 4½ screen Brightness levels, scrolling (301), address cursor, protect (302), partial transmit (302)
<b>Communications</b> Line protocol Transmission Speed Interfaces Other features	Asynchronous/synchronous BSC or SDLC Full- or half-duplex Up to 9,600bps RS232C Opt. poll/addressing and autoanswer	Asynchronous/synchronous BSC/SDLC Full- or half-duplex Up to 9,600bps RS232C Opt. poll/addressing and autoanswer	Asynchronous/synchronous BSC/SDLC Full- or half-duplex Up to 9,600bps RS232C Opt. poll/addressing	Synchronous BSC Full- or half-duplex Up to 9,600bps RS232C Autoanswer	Asynchronous ASCII Full- or half-duplex 110 to 9,600bps RS232C Poll/addressing opt./ autoanswer (302), coupler
<b>Keyboard</b>	Several detachable styles avail. with opt. numeric pad	Several detachable styles avail. with opt. numeric pad	Several detachable styles avail. with opt. numeric pad	Detachable; typewriter style with numeric pad	Typewriter style with numeric pad
<b>Peripherals</b>	Single/dual diskette, impact printer, card readers & punches, mag tape drives, audio alarm	Single/dual diskette, impact printer, card readers & punches, mag tape drives, audio alarm	Single/dual diskette, cassette, impact printer, disk, line printers, card read- ers, mag tape, audio alarm	Impact printer, 10MB disk, mag tape, audio alarm, line printer, opt. diskette	Impact printer, audio alarm
<b>Display Pricing</b> 1-year lease/maint	Vendor will not release pricing	Vendor will not release pricing	Vendor will not release pricing	\$11,500;\$35,250-\$140,411 \$324/\$1,015-\$4,019/mo	\$1,890-\$2,480 —
<b>Controller Pricing</b> 1-year lease/maint				—	—
<b>Comments</b>	Software support in- cludes emulators and assemblers; up to 32 displays per line via multiplexor	Software support in- cludes emulators for IBM, Univac & Bur- roughs, and assemblers		Base price includes 1 display with processor memory and 10MB disk drive	Versions avail. for executive use, with keyboard in drawer or rack mounted



Manufacturer	Informer	Infoton	Infoton	Infoton	Intelligent Systems
<b>Model Highlights</b> 1st ship/# shipped Standalone or cluster Display format Character format Character code Programmable? Editing? Compatibility	303 Series 08/76 1,000 shipped Up to 4-unit cluster 12 x 40 or 24 x 80 5x7 dot matrix ASCII Not programmable No editing Teletype compatible; IBM 3270 BSC opt.	Vistar/GTX & /Satellite 04/76 1,300 shipped Standalone 24 lines of 80 chars 5x7 dot matrix ASCII Not programmable No editing Teletype compatible	Vistar/2 and /3 03/75 700 shipped Standalone 24 lines of 80 chars 5x7 dot matrix ASCII Not programmable Char editing Teletype compatible	200 and 400 08/77 # shipped NG Standalone 24 x 80/ 25 x 80 9x9 dot matrix ASCII Not programmable Char & line edit (400) Teletype compatible	Intecolor 8001 1975 2,500 shipped Standalone 25 or 48 x 80 5x7 dot matrix ASCII Programmable Opt. char & line editing Teletype or ADDS compatible
<b>Display Features</b>	3½ x 4½; 5¼ x 6¾ screen Brightness levels, address cursor, protect, partial transmit	7 x 9 screen Scrolling, address cursor, and partial transmit (Satellite)	7 x 9 screen Reverse video, brightness levels, blinking (/3), scrolling, address/ read cursor, protect, partial transmit	18 x 24 screen Reverse video, scrolling, address/ read cursor, protect and partial transmit (400)	10 x 13 screen 8 colors, opt. re- verse video, blinking, opt. scrolling & paging, address/read cursor, opt. protect, partial transmit
<b>Communications</b> Line protocol Transmission Speed Interfaces Other features	Asynchronous ASCII Full- or half-duplex 50 to 9,600bps RS232C Poll/addressing and autoanswer std.	Asynchronous ASCII Full- or half-duplex 50 to 9,600bps RS232C or CCITT V.24	Asynchronous ASCII Full- or half-duplex 50 to 9,600bps RS232C or CCITT V. 24 Opt. poll/addressing and autoanswer	Asynchronous ASCII Full- or half-duplex 50 to 19,200bps RS232C or current loop Poll/addressing opt. (400); opt. modem	Asynchronous ASCII Full- or half-duplex 110 to 9,600bps RS232C
<b>Keyboard</b>	Typewriter style with numeric pad (D-303)	Detachable; Teletype or typewriter style with numeric pad	Detachable; typewriter style with numeric pad	Detachable; typewriter style with opt. numeric pad, others avail.	Detachable; typewriter style with opt. numeric pad
<b>Peripherals</b>	Impact printer, audio alarm	Audio alarm, serial printer interface (Satellite)	Audio alarm, serial printer interface	Serial printer interface	Diskette, serial printer
<b>Display Pricing</b> 1-year lease/maint	\$3,230-\$10,430 —	\$1,335/\$1,975 Purchase only	\$3,075/\$3,075 Purchase only	\$1,195-\$1,295/\$1,525-\$1,595 Purchase only	\$1,650 Purchase only
<b>Controller Pricing</b> 1-year lease/maint	—	—	—	—	—
<b>Comments</b>	Terminals feature signature capture and display for verification				Features std. & opt. graphics modes; powered by an Intel 8080 microprocessor

Manufacturer	International Computers	International Computers	International Computers	International Computers	International Computers
<b>Model Highlights</b> 1st ship/# shipped Standalone or cluster Display format Character format Character code Programmable? Editing? Compatibility	1501 1971 6,000 shipped Standalone or cluster 4 or 8 lines of 32 chars 5x8 dot matrix ASCII or EBCDIC Programmable No editing IBM BSC compatible; Teletype, Honeywell, Univac and CDC opt.	1502 1974 500 shipped Standalone or cluster 24 lines of 80 chars 5x10 dot matrix ASCII or EBCDIC Programmable Opt. char & line editing IBM BSC compatible; Teletype, Honeywell, Univac & CDC opt.	1501-40 1975 500 shipped Stand. or 16-cluster 4 or 8 x 32/ 24x80 5x8, 5x10 dot matrix ASCII or EBCDIC Programmable No editing IBM BSC compatible; Teletype, Honeywell, Univac & CDC opt.	1503 1974 500 shipped Stand. or 16-cluster 4 or 8 x 32/ 24x80 5x8, 5x10 dot matrix ASCII or EBCDIC Programmable Opt. char & line editing IBM BSC compatible; Teletype, Honeywell, Univac & CDC opt.	2382/2381 1972 10,000 shipped Standalone 24 lines of 80 chars 7x9 dot matrix ASCII Not programmable Char & line editing ICL
<b>Display Features</b>	5-inch screen Blinking, scrolling, paging, programmable cursor, protect, partial transmit	12-inch screen Blinking, scrolling, paging, program- mable cursor, protect, partial transmit	5-inch screen Opt. blinking and scrolling; paging, programmable cursor, protect, partial transmit	5-in or 12-in screen Opt. blinking and scrolling; paging, programmable cursor, protect, partial transmit	8 x 10 screen Brightness levels, blinking, scrolling, paging, programmable cursor, protect, partial transmit
<b>Communications</b> Line protocol Transmission Speed Interfaces Other features	Asynchronous/synchronous BSC Full- or half-duplex 1,800 to 9,600bps RS232C or CCITT Poll/addressing, opt. autoanswer	Asynchronous/synchronous BSC Full- or half-duplex 1,800 to 9,600bps RS232C or CCITT Poll/addressing, opt. autoanswer	Asynchronous/synchronous BSC Full- or half-duplex 1,800 to 9,600bps RS232C or CCITT Poll/addressing std., autoanswer std.*	Asynchronous/synchronous BSC Full- or half-duplex 1,800 to 9,600bps RS232C or CCITT Poll/addressing and autoanswer opt.	Asynchronous/synchronous BSC Half-duplex (2381) 2,400bps No interface Poll/addressing std.
<b>Keyboard</b>	Keypunch or typewriter style with opt. numeric pad	Detachable; keypunch or typewriter styles with numeric pad	Keypunch or type- writer style	Detachable; keypunch or typewriter style with numeric pad	Detachable; typewriter style with numeric pad
<b>Peripherals</b>	Dual cassette, impact printer	Dual cassette, impact printer	Dual cassette, 2.5M fixed disk, impact printer	Dual cassette, disk- ette, impact printer	
<b>Display Pricing</b> 1-year lease/maint	\$5,200-\$12,000 \$197-\$450/month	\$9,720-\$16,500 \$346-\$600/month	\$13,623-\$22,000 \$470-\$842/month	\$18,000-\$30,000 \$672-\$1,123/month	\$3,900 —
<b>Controller Pricing</b> 1-year lease/maint	—	—	—	—	—
<b>Comments</b>	Handles up to 63 peripherals including line printers and mag tape drives	Handles up to 63 peripherals including line printers and mag tape drives	Handles up to 63 peripherals includ- ing line printers and mag tape drives	Handles up to 63 peripherals includ- ing line printers and mag tape drives	*For use with ICL System Ten Computer

Introducing  
the industry's  
first 128K x 18  
PDP®-11  
ADD-IN

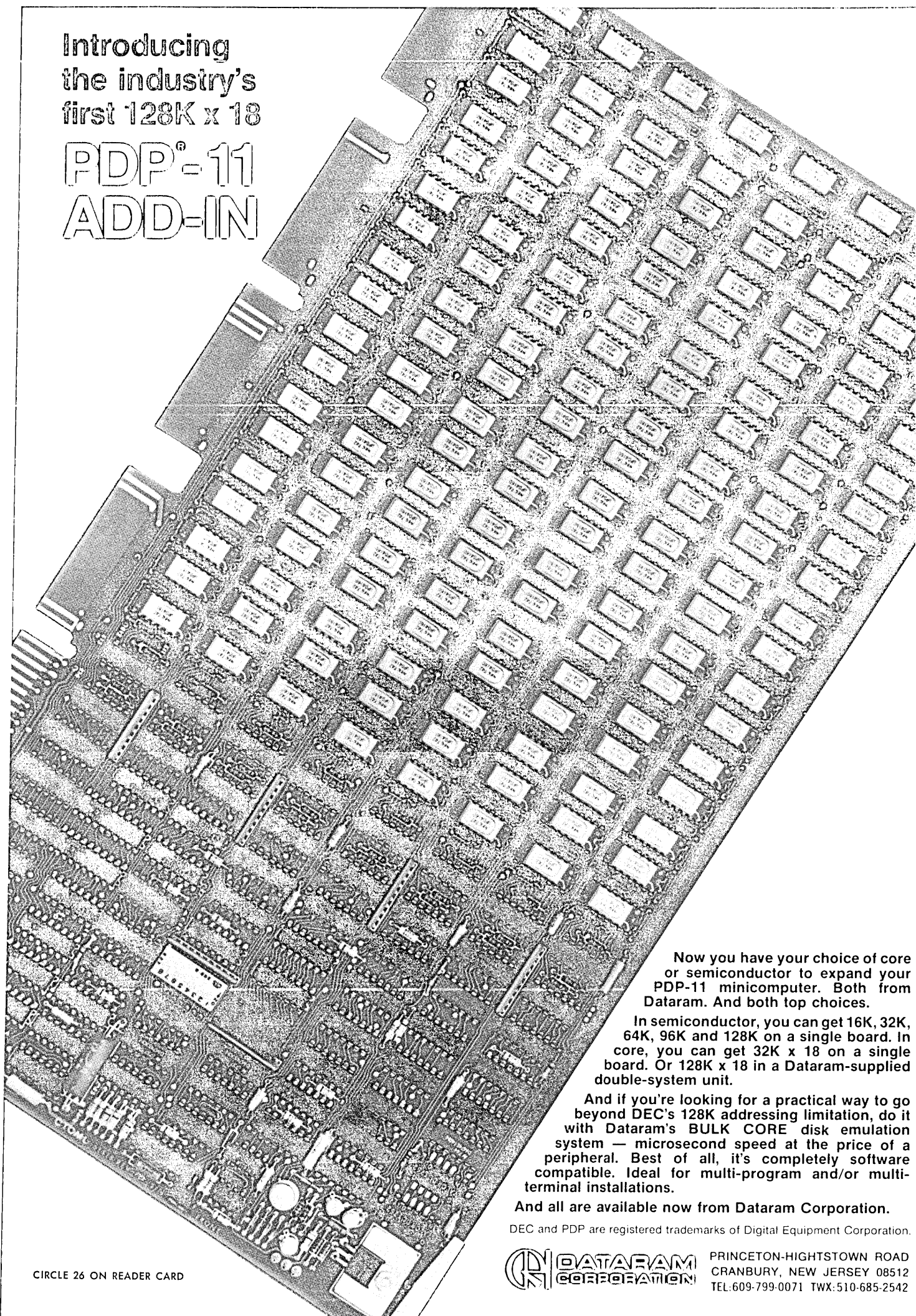

Now you have your choice of core or semiconductor to expand your PDP-11 minicomputer. Both from Dataram. And both top choices.

In semiconductor, you can get 16K, 32K, 64K, 96K and 128K on a single board. In core, you can get 32K x 18 on a single board. Or 128K x 18 in a Dataram-supplied double-system unit.

And if you're looking for a practical way to go beyond DEC's 128K addressing limitation, do it with Dataram's BULK CORE disk emulation system — microsecond speed at the price of a peripheral. Best of all, it's completely software compatible. Ideal for multi-program and/or multi-terminal installations.

And all are available now from Dataram Corporation.

DEC and PDP are registered trademarks of Digital Equipment Corporation.

CIRCLE 26 ON READER CARD

 **DATARAM  
CORPORATION**

PRINCETON-HIGHTSTOWN ROAD  
CRANBURY, NEW JERSEY 08512  
TEL: 609-799-0071 TWX: 510-685-2542



Manufacturer	International Computers	ITT	ITT	Interlec	Kustom
<b>Model Highlights</b> 1st ship/# shipped Standalone or cluster Display format Character format Character code Programmable? Editing? Compatibility	7502 1975 20,000 shipped Standalone or 24-cluster 24 lines of 80 chars 5x7, 5x9 dot matrix ASCII Not programmable Opt. char & line editing IBM 3270 or Teletype compatible	Model 3501 Asciscope 12/72 1,000 shipped Standalone 12 lines of 80 chars 5x7 dot matrix ASCII Not programmable No editing	Model 3100 Alphascope 09/70 1,000 shipped Standalone or 32-cluster 6/12/17/24 x 40 or 80 5x7 dot matrix ASCII Not programmable Character editing IBM 2260/2265 compatible	Intertube 03/78 # shipped NG Stand. or 255-cluster 25 lines of 80 chars 8x8 dot matrix ASCII, opt. EBCDIC Programmable Char & line editing Teletype compatible; opt. IBM 2260/2265, Burroughs & Univac	MCT-10 03/72 1,000 shipped Standalone 8 lines of 32 chars 5x7 dot matrix ASCII Not programmable No editing IBM 3275 compatible
<b>Display Features</b>	7 x 10 screen Brightness levels, blinking, scrolling, paging, programmable cursor, protect, partial transmit	5 x 8 screen Scrolling, partial transmit	5 x 8 screen Opt. protect and partial transmit	12-inch screen Reverse video, brightness levels, blinking, scrolling, paging, address/ read cursor, protect, partial transmit	3.38 x 9.18 plasma Partial transmit
<b>Communications</b> Line protocol Transmission Speed Interfaces Other features	Asynchronous/synchronous BSC Half-duplex 1,200 to 9,600bps RS232C Poll/addressing std., coupler opt.	Asynchronous ASCII Full- or half-duplex 110,300,1200 or 2400bps RS232C Integral modem and coupler	Asynchronous ASCII Half-duplex 1200,2400 or 4800bps RS232C Poll/addressing std.	Asynchronous/synchronous ASCII or SDLC Full- or half-duplex Up to 19,200bps RS232C; opt. curr loop Poll/addressing std., autoanswer opt.	Synchronous ASCII Full- or half-duplex 886 or 1,300bps No interface Poll/addressing, autoanswer, integral modem
<b>Keyboard</b>	Detachable; typewriter style with numeric pad	Teletype style	Typewriter style with opt. numeric pad	Typewriter or data entry style with numeric pad	Typewriter style
<b>Peripherals</b>	Cassette, diskette, impact printer	Impact/non-impact printer, audio alarm	Impact/non-impact printer, audio alarm	Cassette, dual disk- ette, impact printer	Non-impact printer, audio alarm
<b>Display Pricing</b> 1-year lease/maint	\$2,330-\$3,500 \$67-\$200/month	\$2,195 \$74/month	\$1,200-\$1,400 \$40-\$45/month	\$784-\$1,295 —	\$3,650 —
<b>Controller Pricing</b> 1-year lease/maint	— \$252-\$1,159/month	— —	\$6,150-\$68,525 \$95-\$1,920/month	— —	— —
<b>Comments</b>	For use with ICL 2900 computers	—	—	Uses Z-80 processor; 25th line is used for display status; dealer discounts available	Mobile terminal for communication with 2-way radio

Manufacturer	Lear Siegler	Lear Siegler	Lear Siegler	Lear Siegler	Megadata
<b>Model Highlights</b> 1st ship/# shipped Standalone or cluster Display format Character format Character code Programmable? Editing? Compatibility	ADM-1A 08/73 see ADM-3A Standalone 24 lines of 80 chars 5x7 dot matrix ASCII Not programmable Opt. char & line editing Teletype & Datapoint compatible	ADM-2 06/74 see ADM-3A Standalone 24 lines of 80 chars 5x9 dot matrix ASCII Not programmable Opt. char & line editing Teletype or Bur- roughs TD-800 compatible	ADM-3A 01/76 20,000+ all mods Standalone 24 lines of 80 chars 5x7 dot matrix ASCII Not programmable No editing Teletype compatible	VDP-400 10/77 50 shipped Standalone 25 lines of 80 chars 7x9 dot matrix ASCII Programmable Char & line editing Teletype compatible	System 700 02/76 300 shipped Standalone or 8-cluster 24x80 or 32x18 7x9, 8x10/12, 12x15 ASCII or EBCDIC Not programmable Char & line editing Teletype compatible; IBM 3270, 2260/2265, Honeywell & Univac
<b>Display Features</b>	7½ x 9½ screen Scrolling, address/ read cursor, protect, opt. partial transmit	7½ x 9½ screen Blinking, scrolling, address/read cursor, protect, partial transmit	7½ x 9½ screen Scrolling	15-inch screen Reverse video, brightness levels, blinking, scrolling, paging, address/ read cursor, protect, partial transmit	8½ x 11 screen Reverse video, brightness levels, blinking, scrolling, paging, address/ read cursor, protect, partial transmit
<b>Communications</b> Line protocol Transmission Speed Interfaces Other features	Asynchronous ASCII Full- or half-duplex 110 to 9,600bps RS232C or current loop Poll/addressing opt.	Asynchronous/synchronous ASCII Full- or half-duplex 110 to 9,600bps RS232C or current loop Poll/addressing opt.	Asynchronous ASCII Full- or half-duplex 110 to 19,200bps RS232C or current loop Autoanswer opt.	Asynchronous/synchronous ASCII Full- or half-duplex Up to 9,600bps RS232C or current loop Poll/addressing opt.	Asynchronous/synchronous ASCII/BSC/SDLC Full- or half-duplex Up to 19,200bps RS232C, CCITT or curr loop Poll/addressing std., autoanswer, modem and coupler opt.
<b>Keyboard</b>	Typewriter style with opt. numeric pad	Detachable; typewriter style with numeric pad	Teletype style with opt. numeric pad	Detachable; typewriter style with numeric pad	Detachable; typewriter style with opt. numeric pad
<b>Peripherals</b>	Impact printer, opt. audio alarm	Impact printer, audio alarm	Audio alarm	Impact printer	Single/dual cassette & diskette, impact/non- impact printer, mag tape, disk, line printers, audio alarm, ID reader, light pen
<b>Display Pricing</b> 1-year lease/maint	\$1,595 Purchase only	\$2,095 Purchase only	\$895 Purchase only	\$3,995 Purchase only	\$2,950-\$12,000 —
<b>Controller Pricing</b> 1-year lease/maint	— —	— —	— —	— —	\$6,400-\$9,400 —
<b>Comments</b>	—	—	Also available in a kit version	Contains 16-bit pro- cessor with 20K-32KB ROM & 6K-32KB RAM	Microprocessor-based with 4K to 64KB memory; uses DEC assembly language; word processing configuration offered

# GOULD GIVES YOU THREE REMOTE GRAPHICS CAPABILITIES.

RJE/RBT CONFIGURATION  
USER OR TIME SHARE HOST COMPUTER

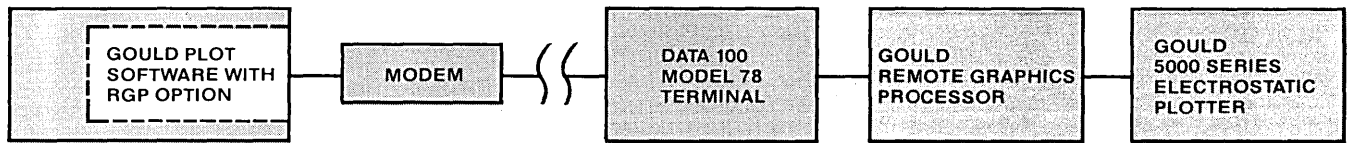

2780 BI-SYNC EMULATION  
USER OR TIME SHARE  
HOST COMPUTER

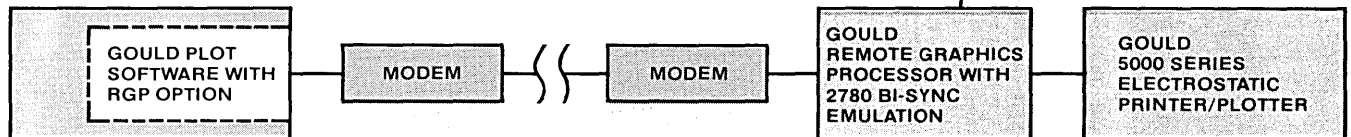

Talk about versatility. That's what you get with Gould's Remote Graphics Processor teamed with our Electrostatic Printer/Plotter.

You can use them with your Data 100 Model 78. Or as a 2780 Bi-Synch emulator. Or in a time share mode with either.

The RGP accepts serial input data from your RJE or RBT terminal (RS232C protocol) for plotting. The 2780 Bi-Synch emulator connects directly to a modem and operates stand-alone for plotting and printing. Both versions can be used with a time share service bureau at a nominal extra cost.

The Gould RGP is a microcomputer based, intelligent-interface which performs character decoding and decompression of graphic data in a highly encoded character form and transmitted by your mainframe or handled by your standard spooling software. The 2780 emulator performs appropriate

handshake and error checking routines.

Gould software is available for IBM 360/370 series, Univac 1100 series and Control Data 6000, 7000 or Cyber 70 Series mainframes.

Paper speed is a function of baud rate and the complexity of the plot, and ranges from 0.04 to 1.0 in/sec. An optional CRT terminal is available to add the SEND function to the standard 2780 receive-only version.

If you use or plan to use remote graphics, you owe it to yourself to look into the Gould RGP/electrostatic printer/

plotter combination.

Contact Gould, Instruments Division, 3631 Perkins Ave., Cleveland, OH 44114. Phone: (216) 361-3315.

For brochures call toll free (800) 325-6400. ext. 77. In Missouri: (800) 342-6600.

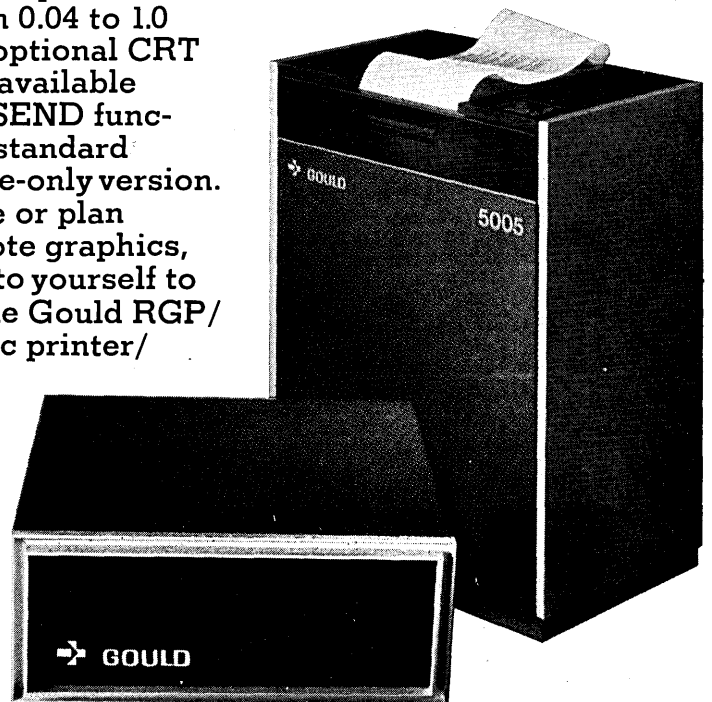

**NOW!**



478 LISTED  
EDP EQUIPMENT  
NFPA-TYPE II



**GOULD**

Manufacturer	Megadata	Megadata	Memorex	Mohawk	NCR
<b>Model Highlights</b> 1st ship/# shipped Standalone or cluster Display format Character format Character code Programmable? Editing? Compatibility	SIR-1000 C-4/8 1973 500+ shipped Standalone 24 lines of 84 chars 7x8 dot matrix ASCII Not programmable Char & line editing Teletype compatible, IBM 3275, 2265, Burroughs & Univac	MC-77 01/77 1,500 shipped Standalone or 8-cluster 24 lines of 80 chars 7x9 dot matrix ASCII Not programmable Char & line editing Teletype compatible; IBM 3277, Hazeltine & Univac	1377-4 05/76 10,000+ shipped Up to 32-unit cluster 24 lines of 80 chars 7x9 dot matrix ASCII or EBCDIC Not programmable Character editing IBM 3270 compatible	MDS Series 21 05/77 # shipped NG Standalone or 4-cluster 12 x 40/ 24 x 80 7x9 dot matrix EBCDIC Programmable Char & line editing IBM 3270/75 and 2260/65 compatible	796 Series 01/74 13,000+ shipped Standalone 24 lines of 80 chars 5x7 dot matrix ASCII Not programmable Char & line editing Teletype compatible
<b>Display Features</b>	10 x 10 screen 4 or 8 colors; opt. reverse video; brightness levels, blinking, scrolling, opt. paging, address/ read cursor, protect, partial transmit	7½ x 9½ screen Brightness levels and blinking opt., scrolling, paging, address/read cursor, protect, partial transmit	7 x 9½ screen Brightness levels, address/read cursor, protect, partial transmit	15-inch screen Reverse video, brightness levels, blinking, scrolling, paging, address cursor, protect, partial transmit	8 x 10 screen Brightness levels, blinking, scrolling, address/read cursor, protect, partial transmit
<b>Communications</b> Line protocol Transmission Speed Interfaces Other features	Asynchronous ASCII Half-duplex Up to 19,200bps RS232C Poll/addressing std.; autoanswer, modem & coupler opt.	Asynchronous ASCII Full- or half-duplex Up to 19,200bps RS232C or current loop Poll/addressing std.	Synchronous BSC or SDLC Full- or half-duplex 1,200 to 7,200bps RS232C Poll/addressing std.	Synchronous BSC or SDLC Full- or half-duplex 600 to 9,600bps RS232C Poll/addressing and autoanswer opt.	Asynchronous ASCII Full- or half-duplex 110 to 9,600bps RS232C Poll/addressing; opt. modem or coupler
<b>Keyboard</b>	Detachable (opt.); type- writer style with numeric pad	Typewriter or data entry style with numeric pad	Typewriter or data entry style with opt. numeric pad	Detachable; typewriter style with opt. numeric pad	Typewriter style with numeric pad
<b>Peripherals</b>	Single/dual cassette & diskette, impact printer, card reader, paper tape punch, audio alarm, ID card reader	Single/dual diskette, impact printer	Audio alarm, opt. light pen	1 to 3 diskettes, impact printer, mag tape, cartridge disk	Non-impact printer, audio alarm
<b>Display Pricing</b> 1-year lease/maint	\$5,000-\$7,500 —	\$2,250-\$3,250 —	\$3,800-\$4,775 \$130-\$163/month	\$1,978-\$2,131 \$51-\$54/month	\$2,000-\$3,500 \$80-\$150/month
<b>Controller Pricing</b> 1-year lease/maint	— —	— —	— —	\$6,270-\$7,660 \$190-\$232/month	— —
<b>Comments</b>			Microprocessor-based replacement for IBM 3277-2; attaches to IBM controller	Prices include 1 display unit & controller with 1 diskette drive	Manufactured by ADDS

Manufacturer	Olivetti	Olivetti	Olivetti	Omron	Ontel
<b>Model Highlights</b> 1st ship/# shipped Standalone or cluster Display format Character format Character code Programmable? Editing? Compatibility	DE-520 02/71 20,500 shipped Standalone 11 lines of 31 chars 5x7 dot matrix ASCII or EBCDIC Programmable No editing Teletype, Univac DCT 200 or Bur- roughs compatible	TCV-278 11/76 200 shipped Standalone or 24-cluster 24 lines of 80 chars 5x7 dot matrix ASCII or EBCDIC Programmable Character editing Teletype compatible	TCV-280 04/76 # shipped NG Up to 16-unit cluster 24 lines of 80 chars 5x7 dot matrix ASCII or EBCDIC Not programmable Character editing IBM compatible	8030 Series 08/76 500+ shipped Standalone 24 lines of 80 chars 9x14 dot matrix ASCII or EBCDIC Programmable (opt.) Char & line editing Teletype compatible; Burroughs & Univac opt.	OP-1 11/74 3,500+ shipped Standalone or 4-cluster 20,24 or 25 x 80 5x10 or 13/11 dot ASCII or EBCDIC Programmable Char & line editing Teletype compatible; IBM 3275, 2780, Hazeltine
<b>Display Features</b>	4½ x 5½ screen Brightness levels, blinking, paging, address/read cursor, protect, partial transmit	12-inch screen Brightness levels, scrolling, address/ read cursor, protect, partial transmit	15-inch screen Brightness levels, blinking, address/ read cursor, protect, partial transmit	8 x 10 screen Reverse video, brightness levels, blinking, scrolling, paging, address/ read cursor, protect, partial transmit	7 x 10 screen Reverse video, bright- ness levels, blinking, scrolling, address/ read cursor, protect, partial transmit
<b>Communications</b> Line protocol Transmission Speed Interfaces Other features	Asynchronous/synchronous ASCII or BSC Full- or half-duplex 110 to 4,800bps RS232C Poll/addressing std., autoanswer opt.	Asynchronous/synchronous ASCII or BSC Full- or half-duplex 600 to 4,800bps RS232C Poll/addressing std.	Synchronous BSC or SDLC Full- or half-duplex 1,200 to 9,600bps RS232C Poll/addressing std.	Asynchronous/synchronous ASCII or BSC Full- or half-duplex Up to 9,600bps RS232C or current loop Poll/addressing and autoanswer opt.	Asynchronous/synchronous ASCII or BSC Full- or half-duplex Up to 9,600bps RS232C or current loop Opt. poll/addressing, autoanswer and modem
<b>Keyboard</b>	Typewriter or data entry style	Detachable; typewriter or data entry style with opt. numeric pad	Detachable; typewriter keypunch or data entry style with opt. numeric pad	Typewriter or data entry style with numeric pad	Detachable; Teletype style with numeric pad
<b>Peripherals</b>	Single/dual cassette, dual diskette, impact printer, audio alarm	Dual diskette, impact printer, audio alarm	Impact printer	Dual diskette, serial printer interface, audio alarm	1-4 cassette or diskette drives, impact/non- impact printer, audio alarm
<b>Display Pricing</b> 1-year lease/maint	\$5,600-\$20,000 \$154-\$193/mo (2-yr)	\$6,700 \$261/month (2-year)	\$2,700-\$4,785 \$57-\$99/month	\$3,100-\$7,850 base Purchase only	\$1,695-\$5,550 Sold OEM only
<b>Controller Pricing</b> 1-year lease/maint	— —	— —	\$4,820-\$11,530 \$110-\$269/month	— —	— —
<b>Comments</b>	Manufactured by Sycor as Model 340; uses Olivetti TPS language		Prices include 66-key keyboard; TCV-280 is a Sycor 290 designed to Olivetti specs	Uses Intel 8080 micro- processor with 4K to 64K RAM; contains 4K PROM loader	Price based on quantity of 100; 10- or 20-MB disk drive; IBM-compat- ible tape drives available





# Your in-basket holds more than paper

It seems like everyone sends you requests for reports of computerized data. They sure pile up fast. But you know that behind every one of those requests is a decisionmaker whose job effectiveness rests on being able to make his decisions from information . . . which you can provide.

Does he get it on time? Every time?

If not, EASYTRIEVE can help you do away with the mountain of requests. To get information back to that decisionmaker in record time.

EASYTRIEVE is the free form information retrieval system that works with simple English key words. The system does the formatting, the page-numbering, report dating. It is load-and-go. It is simple to learn and apply, yet can be the basis for entire job accounting systems, modeling and financial systems, auditor programs . . . the list is endless.

EASYTRIEVE, the Datapro Honor Roll software system in use at over 1,500 IBM 360/370 data centers around the world. From the people at Pansophic. Offices near you throughout the world.

## PANSOPHIC

709 Enterprise Drive, Oak Brook, IL 60521

# 800-323-7335

CIRCLE 57 ON READER CARD



Manufacturer	Perkin-Elmer	Perkin-Elmer	Perry	Perlec	Piantronics
<b>Model Highlights</b> 1st ship/# shipped Standalone or cluster Display format Character format Character code Programmable? Editing? Compatibility	Model 1100 02/77 # shipped NG Standalone 24 lines of 80 chars 7x11 dot matrix ASCII Not programmable No editing Teletype compatible	Model 1200 03/77 # shipped NG Standalone 24 lines of 80 chars 7x11 dot matrix ASCII Not programmable Char & line editing	PE 9000 Series 07/77 600 shipped Standalone 8 x 60; 16 or 24 x 80 5x7 dot matrix ASCII Not programmable Opt. char & line editing Teletype compatible	Model 7100 04/74 7,000+ shipped Standalone 12 or 24 x 80 7x9 dot matrix ASCII Not programmable Char & line editing Teletype compatible	VJ Set D9-150A/G 04/73 4,000 shipped Standalone 4 or 8 lines of 18 5x7 dot matrix ASCII or DMTF Not programmable No editing Teletype compatible
<b>Display Features</b>	12-inch screen Reverse video opt., scrolling, address/ read cursor	12-inch screen Reverse video opt., brightness levels, blinking, scrolling, address/read cursor, protect, partial transmit	9- or 12-inch screen Blinking, scrolling, paging, address cursor	5½ x 8¼ screen Reverse video, scrolling, address/ read cursor, protect, partial transmit	3-inch screen Blinking
<b>Communications</b> Line protocol Transmission Speed Interfaces Other features	Asynchronous ASCII Full- or half-duplex 75 to 9,600bps RS232C, CCITT or curr loop	Asynchronous ASCII Full- or half-duplex 75 to 9,600bps RS232C, CCITT or curr loop Opt. poll/addressing	Asynchronous ASCII Full- or half-duplex 50 to 9,600bps RS232C or current loop	Asynchronous/synchronous ASCII Full- or half-duplex Up to 9,600bps RS232C Poll/addressing and autoanswer std., modem opt.	Asynchronous ASCII Half-duplex 110, 150 or 300bps RS232C Integral modem
<b>Keyboard</b>	Typewriter style with opt. numeric pad	Detachable (opt.); typewriter style with numeric pad	Typewriter style with numeric pad	Detachable; typewriter style with opt. numeric pad	Detachable; Touch- Tone 12-key or typewriter style
<b>Peripherals</b>	Impact/non-impact printer, audio alarm	Impact/non-impact printer, audio alarm	Cassette, diskette interface, impact printer, audio alarm	Impact printer, audio alarm	Audio alarm
<b>Display Pricing</b> 1-year lease/maint	\$1,440 base Purchase only	\$2,195 Purchase only	\$975-2,250 Purchase only	\$2,250 Sold OEM only	— \$30-\$55/month
<b>Controller Pricing</b> 1-year lease/maint	—	—	—	—	—
<b>Comments</b>			Several models of Centronics printers are available	Above price is based on quantity of 250 to 500	Leased to user by local telephone co.

Manufacturer	Racal-Milgo	Racal-Milgo	Racal-Milgo	Raytheon	Raytheon
<b>Model Highlights</b> 1st ship/# shipped Standalone or cluster Display format Character format Character code Programmable? Editing? Compatibility	ICC 40 + Data Display 02/75 500+ shipped Standalone 24 lines of 80 chars 7x11 dot matrix ASCII Not programmable Char & line editing IBM 2265 compatible	ICC 40 + MPL 02/76 1,000+ shipped Standalone 24 lines of 80 chars 7x11 dot matrix ASCII Not programmable Char & line editing AT&T #8A1 compatible	System 400 10/76 300+ shipped Standalone 12 or 24 x 80 7x11 dot matrix ASCII Not programmable Char & line editing IBM 3275, 2265, Honey- well, Univac compatible	PTS-100 09/72 50,000 shipped Standalone or 32-cluster 12 or 30 x 64 7x7/9 dot matrix ASCII or EBCDIC Programmable Char & line editing IBM 3270 BSC, 2260/5, Teletype, Univac, PARS compatible	PTS-1200 MKI & MKII 06/78 # shipped NG 8- or 24-unit cluster 12 or 24 x 80 7x9 dot matrix ASCII or EBCDIC Programmable Char & line editing IBM 3271 BSC, 2780 & 3780 compatible
<b>Display Features</b>	5¼ x 10½ screen Reverse video, bright- ness levels, blinking, opt. scrolling and paging, address cursor, opt. protect, partial transmit	5¼ x 10½ screen Reverse video opt., brightness levels, blinking opt., scroll- ing, address cursor, protect opt., partial transmit	5¼ x 10½ screen Reverse video, bright- ness levels, blinking, address cursor, protect, partial transmit	7 x 10 screen Brightness levels, blinking, address/ read cursor, protect, partial transmit	15-inch screen Brightness levels, blinking, scrolling, paging, address/read cursor, protect, partial transmit
<b>Communications</b> Line protocol Transmission Speed Interfaces Other features	Asynchronous/synchronous ASCII Full- or half-duplex Up to 3,600bps RS232C Opt. poll/addressing, autoanswer, integral modem	Asynchronous Bell 8A1 Full- or half-duplex 1,200 to 4,800bps RS232C Poll/addressing std., autoanswer opt.	Asynchronous/synchronous IBM, HIS, Univac Full- or half-duplex 50 to 9,600bps RS232C Poll/addressing std., autoanswer opt.	Asynchronous/synchronous BSC/PARS/U 100 Full- or half-duplex Up to 9,600bps RS232C or CCITT V.24 Poll/addressing std., autoanswer opt.	Synchronous BSC Full- or half-duplex Up to 9,600bps RS232C Poll/addressing opt.
<b>Keyboard</b>	Detachable; typewriter style	Detachable; typewriter style with opt. numeric pad	Detachable; typewriter style with opt. numeric pad	Detachable; typewriter style with opt. numeric pad	Detachable; typewriter or data entry style with numeric pad
<b>Peripherals</b>	Impact printer, audio alarm	Impact printer, audio alarm	Impact printer, audio alarm	1-4 cassette drives, impact printer, disk, card reader, audio alarm, ID reader	Cassette, impact printer
<b>Display Pricing</b> 1-year lease/maint	\$3,750-\$4,195 \$140-\$170/month	\$4,585-\$5,020 \$161-\$191/month	\$4,550-\$5,750 \$150-\$180/month	\$1,630 \$45/month	\$2,030 \$51/month
<b>Controller Pricing</b> 1-year lease/maint	—	—	—	\$5,670-\$24,100 \$242-\$568/month	\$23,120/\$23,555 \$631; \$554/month
<b>Comments</b>	40+10 printer is a modi- fied Okidata CP110; 40+20 printer is a modified GE TermiNet 1200; calculator firmware is optional			Number of units in- stalled includes PTS-100 & PTS-200	Controller price in- cludes 64K memory; MKI has 10MB disk



Manufacturer	Scientific Measurement Systems	Soroc	Sycor	Sycor	Sycor
<b>Model Highlights</b> 1st ship/# shipped Standalone or cluster Display format Character format Character code Programmable? Editing? Compatibility	SMS 1920 09/74 225 shipped Standalone 24 lines of 80 chars 5x7 dot matrix ASCII Not programmable Char & line editing Teletype compatible	IQ 120 11/76 4,000 shipped Standalone 24 lines of 80 chars 5x7 dot matrix ASCII Not programmable No editing Teletype compatible	250 Series 10/73 36,000+ shipped Stand/up to 32-unit cluster 12 x 40 or 24 x 80 9x7 dot matrix ASCII or EBCDIC Not programmable Char & line editing IBM 3270 BSC compatible	291 and 296 12/77 # shipped NG 16- or 8-unit cluster 24 lines of 80 chars 9x7 dot matrix ASCII or EBCDIC Not programmable Character editing IBM 3270 BSC/SDLC compatible	340 02/71 32,000+ shipped Standalone 9 lines of 64 chars 5x7 dot matrix ASCII or EBCDIC Not programmable No editing Teletype compatible
<b>Display Features</b>	7 x 10 screen Reverse video, brightness levels, scrolling, paging, address cursor, protect, partial transmit	12-inch screen Brightness levels, scrolling, address cursor, protect, partial transmit	4.5 x 8.2; 5.8 x 8.5 screen Brightness levels, blinking, address/read cursor, protect, partial transmit	15-inch screen Brightness levels, address cursor, protect, partial transmit	7 1/4 x 5 1/2 screen Scrolling, protect, partial transmit
<b>Communications</b> Line protocol Transmission Speed Interfaces Other features	Async/opt. sync SDLC Full- or half-duplex 50 to 19,200bps RS232C or current loop	Asynchronous ASCII Full- or half-duplex 75 to 19,200bps RS232C or current loop	Synchronous BSC Half-duplex 1,200 to 4,800bps RS232C Poll/addressing and autoanswer	Synchronous BSC or SDLC Full- or half-duplex 1,200 to 9,600bps RS232C Poll/addressing	Asynchronous/synchronous ASCII or BSC Half-duplex 75 to 4,800bps RS232C opt. Autoanswer opt.
<b>Keyboard</b>	Teletype or keypunch style with numeric pad	Typewriter style with numeric pad	Detachable; typewriter or data entry style with opt. numeric pad	Detachable; typewriter or keypunch style with opt. numeric pad	Typewriter style with numeric pad
<b>Peripherals</b>	Cassette, diskette, impact printer		Dual diskette, impact printer, audio alarm, ID card reader, opt. light pen	Impact printer, opt. ID card reader and light pen	Dual/single cassette, dual diskette, impact printer, card reader, line printers, mag tape units, audio alarm
<b>Display Pricing</b> 1-year lease/maint	\$2,245 —	\$995 Purchase only	\$5,378-\$10,220 \$142-\$447/month	\$2,700 \$57/month	\$6,600-\$23,720 \$187-\$593/month
<b>Controller Pricing</b> 1-year lease/maint	—	—	— \$111-\$156/mo. (251)	\$11,530/\$7,520 \$269; \$167/month	—
<b>Comments</b>					

Manufacturer	Sycor	Sycor	Sycor	Tano	TEC
<b>Model Highlights</b> 1st ship/# shipped Standalone or cluster Display format Character format Character code Programmable? Editing? Compatibility	350 and 351 09/75 3,400+ shipped Standalone 9 lines of 64 chars 5x7 dot matrix ASCII or EBCDIC Programmable No editing Teletype compatible; IBM 2770, 2780, 3780	410 and 440 03/76 2,400 shipped Standalone/8-cluster 9 lines of 64 chars 5x7 dot matrix ASCII or EBCDIC Programmable No editing Teletype compatible; IBM 2270, 2780, 3780	405 and 445 30 1978 2- or 8-cluster 25 lines of 80 chars 7x12 dot matrix ASCII or EBCDIC Programmable No editing	Outpost 7 04/77 125 shipped Standalone 24 lines of 80 chars 7x9 dot matrix ASCII or EBCDIC Programmable Char & line editing Teletype 33/35 & 40 compatible	Model 70 04/77 800 shipped Standalone 25 lines of 80 chars 7x9 dot matrix ASCII Not programmable Opt. char & line editing Teletype compatible, Univac, Honeywell VIP 7700, Burroughs TD 830
<b>Display Features</b>	9 x 9 screen Blinking, protect	7 x 9 1/2 screen Brightness levels, blinking, protect	7.75 x 10.4 screen Brightness levels, blinking	12-inch screen Reverse video, brightness levels, blinking, scrolling, paging, address/read cursor, protect, partial transmit	6 x 9 screen Reverse video, brightness levels & blinking opt.; scrolling, opt. paging, address/read cursor; opt. protect and partial transmit
<b>Communications</b> Line protocol Transmission Speed Interfaces Other features	Asynchronous/synchronous BSC Half-duplex 110 to 4,800bps RS232C Autoanswer std.	Asynchronous/synchronous BSC Half-duplex 110 to 9,600bps RS232C Poll/addressing and autoanswer	Asynchronous/synchronous BSC or SDLC Full- or half-duplex Up to 9,600bps RS232C	Asynchronous/synchronous ASCII/EBCDIC Full- or half-duplex 110 to 9,600bps RS232C or current loop Poll/addressing	Async/opt. synchronous Depends on compatibility chosen Full- or half-duplex 50 to 9,600bps RS232C, TTL, curr loop Poll/addressing opt.
<b>Keyboard</b>	Detachable; typewriter or data entry style with numeric pad	Typewriter or data entry style with numeric pad	Detachable; typewriter or data entry style	Typewriter or data entry style with numeric pad	Detachable; typewriter or Teletype style with opt. numeric pad
<b>Peripherals</b>	Dual diskette, impact printer, card reader, line printers, mag tape, audio alarm	Cassette, diskette, impact printer, card reader, line printers, mag tape, audio alarm	Cassette (445), 1-4 diskettes, impact printer, line printer, disk drives (445), 9-tk. mag tape drive	Single/dual cassette, diskette, & printer interface, audio alarm, opt. ID card reader	Diskette, impact/non-impact printer
<b>Display Pricing</b> 1-year lease/maint	\$9,600-\$26,100/ \$16,100-\$31,700 \$292-\$809; \$400-\$917/mo	\$21,150-\$33,020/\$1,800-\$2,300 \$600-\$954; \$44-\$54/month	\$3,600/\$2,800 \$83; \$65/month	\$2,660-\$3,240 \$213/month	\$1,535-\$1,975 —
<b>Controller Pricing</b> 1-year lease/maint	Included Included	Included Included (410); \$444-\$609/mo.	\$6,250/\$22,500 \$167; \$555/month	— —	— —
<b>Comments</b>			64-256KB memory available; 5 to 70MB disk & Sycor link	Available with APL and extended ANSI BASIC	

Manufacturer	TEC	TEC	TEC	TEC	TEC
<b>Model Highlights</b> 1st ship/# shipped Standalone or cluster Display format Character format Character code Programmable? Editing? Compatibility	410/415, 420/425 & 430/435 02/70 6,000 shipped Standalone 20 x 50 or 24 x 80 5x7 dot matrix ASCII Not programmable Char & line editing	Model 440 01/72 850 shipped Standalone 24 lines of 80 chars 5x7 dot matrix ASCII Not programmable No editing Teletype compatible	450/455 and 460/465 1970 4,480 shipped Standalone 20 x 50 or 24 x 80 5x7 dot matrix ASCII Not programmable Char & line editing Teletype compatible (450/455)	Model 500 04/78 50 shipped Standalone 25 lines of 80 chars 7x9 dot matrix ASCII Not programmable No editing Teletype, ADM-3A compatible	1400 and 2400 Series 11/74 4,500 shipped Standalone 12 or 24 x 80 5x7 dot matrix ASCII Not programmable No editing Teletype compatible
<b>Display Features</b>	6 x 9 screen Reverse video opt., blinking, scrolling, address/read cursor, protect	6 x 9 screen Scrolling	6 x 9 screen Blinking, scrolling, address/read cursor, protect, partial transmit	6 x 9 screen Reverse video, scrolling, address/ read cursor	6 x 9 screen Brightness levels, blinking, scrolling, address/read cursor, protect, partial transmit
<b>Communications</b> Line protocol Transmission Speed Interfaces Other features	Asynchronous ASCII Full- or half-duplex 110 to 9,600bps RS232C or current loop Poll/addressing (420/425)	Asynchronous ASCII Full- or half-duplex 110 to 9,600bps RS232C or current loop	Asynchronous ASCII/Burroughs Full- or half-duplex 110 to 9,600bps RS232C or current loop Poll/addressing (460/465)	Asynchronous ASCII Full- or half-duplex 50 to 9,600bps RS232C, TTL or curr loop	Asynchronous ASCII Full- or half-duplex 110 to 9,600bps RS232C or current loop
<b>Keyboard</b>	Detachable; Teletype style with opt. numeric pad	Detachable; Teletype style	Detachable; Teletype or typewriter style with numeric pad	Teletype style with opt. numeric pad	Detachable; Teletype style with opt. numeric pad
<b>Peripherals</b>	Printer interface, audio alarm	Printer interface, audio alarm	Diskette, printer interface, audio alarm	Diskette, impact/non- impact printer	Cassette & printer interface, audio alarm
<b>Display Pricing</b> 1-year lease/maint	\$2,440-\$2,700 Purchase only	\$1,920 Purchase only	\$2,480 Purchase only	\$995 —	\$1,125-\$1,725 Purchase only
<b>Controller Pricing</b> 1-year lease/maint	—	—	—	—	—
<b>Comments</b>	410/415 have parallel (TTL logic) interface; 420/425 have serial inter- face; rack-mounted units available		Rack mount available		

Manufacturer	Tektronix	Teleram	Teleray	Teleray	Teletype
<b>Model Highlights</b> 1st ship/# shipped Standalone or cluster Display format Character format Character code Programmable? Editing? Compatibility	4024/4025 1977 # shipped NG Standalone 34 lines of 80 chars 8x14 dot matrix ASCII Not programmable Char & line editing IBM compatible	P-1800 10/74 500+ shipped Standalone 14 lines of 44 chars 7x9 dot matrix ASCII, TTY, others User-defined firmware Char & line editing Teletype, DEC, Data Gen- eral, General Automation compatible; others	3000 Series 1972 # shipped NG Standalone 40 or 80 x 24 chars 5x7/5x9 dot matrix ASCII Not programmable No editing Teletype compatible	4000 Series 1977 # shipped NG Standalone 24 lines of 80 chars 5x9 dot matrix ASCII; Burroughs 4041's are programmable Char & line edit (4041's) Teletype compatible (4041's Burroughs com- patible)	Models 40/1, 40/2 & 40/3 10/73 # shipped NG Standalone/3-cluster 24 lines of 80 chars 7x9 dot matrix ASCII Not programmable Char & line editing Teletype compatible (except 40/3)
<b>Display Features</b>	6.7 x 9 screen Brightness levels, blinking, scrolling, paging, partial transmit	4½ x 5½ screen Scrolling, address/read cursor, partial transmit	6½ x 8½ or 8x10 screen Reverse video opt., scrolling	6½ x 8½ screen Reverse video, bright- ness levels & blinking; scrolling, paging, address cursor, protect and partial transmit	5¼ x 11¼ screen Brightness levels, blinking, scrolling, opt. paging, opt. protect, partial transmit
<b>Communications</b> Line protocol Transmission Speed Interfaces Other features	Asynchronous ASCII Full- or half-duplex 50 to 9,600bps RS232C or current loop Poll/addressing opt.	Asynchronous ASCII Full- or half-duplex 110 to 1,200bps RS232C Poll/addressing, auto- answer & coupler std.	Asynchronous ASCII Full- or half-duplex 50 to 9,600bps RS232C, TTL, curr loop Opt. modem & coupler	Asynchronous ASCII, Burroughs Full- or half-duplex 50 to 9,600bps RS232C, TTL, curr, 2-wire Poll/addressing (4041 BB), opt. modem	Asynchronous ASCII Half-duplex 1,050 or 1,200bps RS232C Poll/addressing, autoanswer
<b>Keyboard</b>	Detachable; typewriter style with numeric pad	Typewriter style with single numeric pad	Detachable (opt.); type- writer style with opt. numeric pad	Detachable (opt.); type- writer style with opt. numeric pad	Typewriter style (40/3 detachable)
<b>Peripherals</b>	Impact printer, hard copy unit, cartridge tape drive, plotter	Cassette, diskette, & printer interface, ID card reader	Diskette, impact printer, TV monitors, bar code readers, cluster printer, audio alarm	Diskette, impact printer, TV monitors & audio alarm (exc. 4041 BB)	Impact printer, audio alarm
<b>Display Pricing</b> 1-year lease/maint	\$2,995/\$3,595 base prices Purchase only	\$4,995 \$450/month	\$1,150-\$1,960 \$65-\$109/month	\$1,750-\$1,950 \$73-\$81/month	\$3,066-\$3,881 Purchase only
<b>Controller Pricing</b> 1-year lease/maint	—	—	—	—	—
<b>Comments</b>	Has 4K to 32K memory; graphics opt; designed for A/N user who wants growth to graphics		Rack mount, remote monitors & other customs available		40/1 & /2 for use on dial network; /3 for multipoint leased-line operation; avail. from AT&T as Dataspeed 40



# You won't believe our Ballistic™ Printer until you see one in print. And in person.

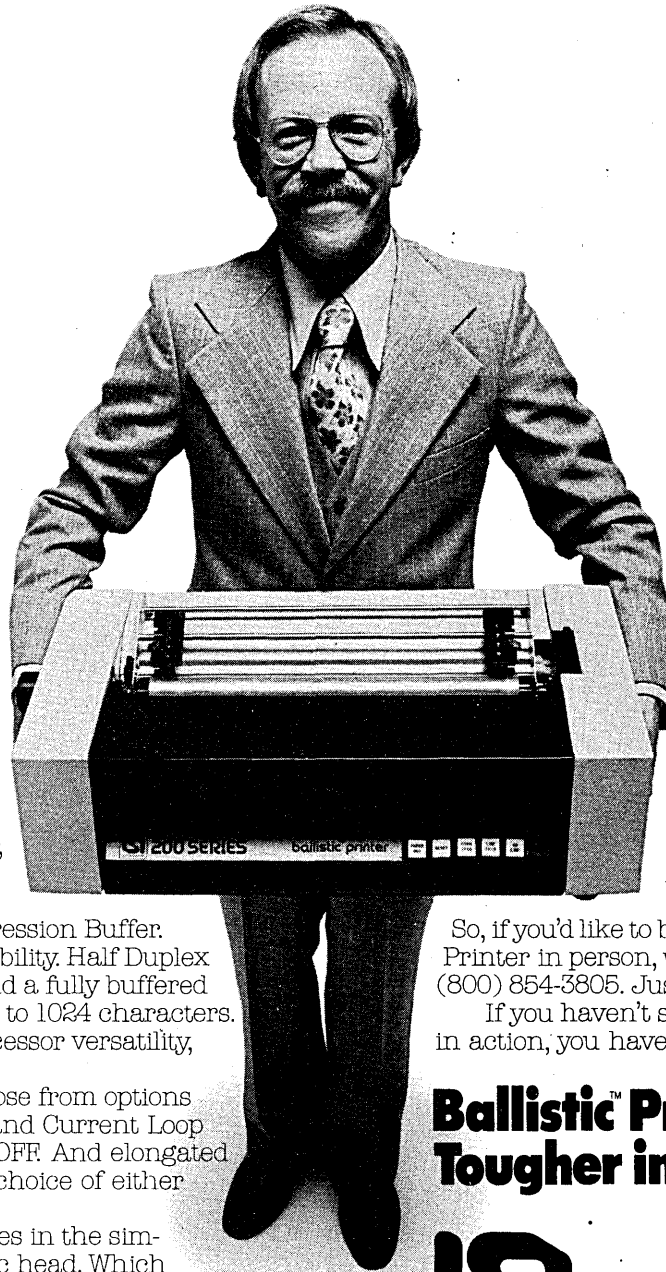

Unless you've been in hiding, you've probably heard about LSI's family of Ballistic Printers. Built with the same proven dependability of the Dumb Terminal and his Smarter Brothers.

Our latest matrix printer, the 200A, comes with standard features like a Space and Blank Character Compression Buffer. Tabbing over Blank Spaces ability. Half Duplex or Full Duplex Operation. And a fully buffered input, optionally expandable to 1024 characters. Not to mention its microprocessor versatility, and firmware flexibility.

To top it off, you can choose from options like Serial, RS232, Parallel, and Current Loop interfaces. Polling. X-ON, X-OFF. And elongated character capability with a choice of either 10, 12 or 16.5 Pitch.

The Printer's reliability lies in the simplicity of its patented Ballistic head. Which ballistically propels the matrix wires to assure longer head life. Eliminating tube clogging with inks, dust,

and paper fibers. Even wire tip wear is substantially reduced.

The Ballistic Printer uses a five-start lead screw and servo to print bi-directionally at 180 cps. Direct, simple, positive. And very accurate.

But, seeing is believing.

So, if you'd like to be amazed by our Ballistic Printer in person, write or call us toll free (800) 854-3805. Just ask for Tom Hudspeth.

If you haven't seen the Ballistic Printer in action, you haven't seen ballistic printing.

## Ballistic™ Printer. Tougher in the long run.



LEAR SIEGLER, INC.  
ELECTRONIC INSTRUMENTATION DIVISION  
DATA PRODUCTS

Lear Siegler, Inc./E.I.D., Data Products, 714 Brookhurst St., Anaheim, CA 92803; (800) 854-3805. In California (714) 774-1010.



Manufacturer	Teletype	Telex-Terminal Communications	Termiflex	Terminal Data	Terminal Data
<b>Model Highlights</b> 1st ship/# shipped Standalone or cluster Display format Character format Character code Programmable? Editing? Compatibility	Model 40/4 11/75 # shipped NG Up to 24-unit cluster 24 lines of 80 chars 7x9 dot matrix ASCII or EBCDIC Not programmable Char & line editing IBM 3270 BSC compatible	TC 270 Series 01/74 # shipped NG Standalone/to 36-cluster 12 x 40 or 24 x 80 7x9 or 7x8 dot matrix ASCII or EBCDIC Not programmable Char & line editing IBM 3270 compatible	Handheld terminals 06/74 3,200+ shipped Standalone 1-4 x 6-20 5x7 dot matrix (LED) ASCII Not programmable No editing Teletype compatible	650 09/75 # shipped NG Standalone 24 x 80 or 48 x 80 7x9 ASCII Programmable Opt. char & line editing Teletype & T1 Silent 700 compatible	675 03/77 # shipped NG Standalone 16 lines of 64 chars 5x7 ASCII Not programmable No editing Teletype & T1 Silent 700 compatible
<b>Display Features</b>	5 1/4 x 11 1/4 screen Brightness levels, blinking, address/ read cursor, protect, partial transmit	14-inch screen 1 color, brightness levels, address/read cursor, protect, partial transmit	2 x 4 screen Scrolling (HT/2 & HT/8)	19-inch screen 8 colors, reverse video, blinking, opt. scrolling, address/ read cursor, opt. protect & partial transmit	9-inch screen
<b>Communications</b>	Synchronous (BSC) Half-duplex	Synchronous BSC or SDLC Half-duplex	Asynchronous ASCII	Asynchronous ASCII	Asynchronous ASCII
Line protocol			Full- or half-duplex	Full- or half-duplex	Full- or half-duplex
Transmission Speed	2400,4800 or 9600bps RS232C	1,200 to 4,800bps RS232C	110 to 1,200bps RS232C or current loop	110 to 9,600bps RS232C	110 to 9,600bps RS232C
Interfaces	Poll/addressing and autoanswer std.	Poll/addressing std.	Poll/addressing opt.	Poll/addressing and autoanswer opt.	
Other features					
<b>Keyboard</b>	Detachable (opt.); type- writer or data entry style with opt. numeric pad	Detachable typewriter or data entry style with numeric pad	Modified "Touch- Tone" style	Typewriter or data entry style with opt. numeric pad	Detachable; typewriter or data entry style
<b>Peripherals</b>	Impact printer, audio alarm	Impact printer, opt. audio alarm	Audio alarm	Diskette, impact printer	Diskette, impact printer
<b>Display Pricing</b>	\$960-\$1,184 1-year lease/maint Purchase only	\$2,200-\$4,100 \$86-\$104/plus maint.	\$495-\$3,995 Purchase only	\$1,650 up \$125-\$250/month	\$795-\$995 base \$45-\$125/month
<b>Controller Pricing</b>	\$5,143-\$43,135 1-year lease/maint Purchase only	—	—	—	—
<b>Comments</b>	Avail. from AT&T as Dataspeed 40/4		Models vary in display format		



## Meet 3 Members of The Diskwriter Family

**Available Now!**  
**\$1795<sup>00</sup>** and up

- English Language Commands
- Keyboard Selectable H/F Duplex
- Plug to EIA Plug Compatible
- Text Editor
- Global Searching
- Global Changes
- Modify Any Line of Data
- Immediate Intelligence

- Keyboard Driven
- Selective/Partial Transmit
- Forward/Reverse Scrolling
- Forms Handling
- Print Any/All Lines
- 83K to 166K Storage
- Selectable S/R Baud Rate
- 629 to 1250 Lines of Data
- Immediate Deliveries

- 10% Discount c.w.o.
- Dual EIA Ports
- Display Any/All Lines
- No Buttons or Switches
- Split Baud Rates
- Reduce Connect Time
- Lightweight & Portable
- Field Tested
- Store & Forward
- Memory Based Editor

Hands On Terminals, Inc.

Call or Write: **JIM GIBSON, Marketing Manager**  
1215 SE Ivon, Portland, OR 97202 - (503)231-1057

# This open letter should close our deal.



## FUNDING SYSTEMS CORPORATION

ONE THOUSAND RIDG PLAZA

PITTSBURGH, PA. 15238

(412) 963-9870

President

Dear Reader:

Our Leasing Division has recently completed a \$20 million tax oriented leased equipment program with the leasing subsidiary of one of the world's largest business and office machine manufacturers. The transaction was very simple.

1. The manufacturer's leasing company transferred legal title to the equipment to Funding Systems.
2. Funding Systems paid the manufacturer's leasing company 100% of the revenues generated by the equipment for 7 years.
3. Funding Systems paid the manufacturer's leasing company \$1 million in cash.

Funding Systems Corporation is a public company traded in the over the counter market with interests in the energy field, heavy equipment manufacturing and chemicals. It has, through its leasing division, during the past one and one-half years, consummated in excess of \$175 million of tax oriented leasing transactions involving high technology equipment.

If you are interested in discussing a similar transaction involving your company, please call me toll free on 800-245-6544.

Sincerely,

Stanley B. Scheinman

SBS:crs

**Call toll-free: 800-245-6544**

# IS DATAP SLOWING

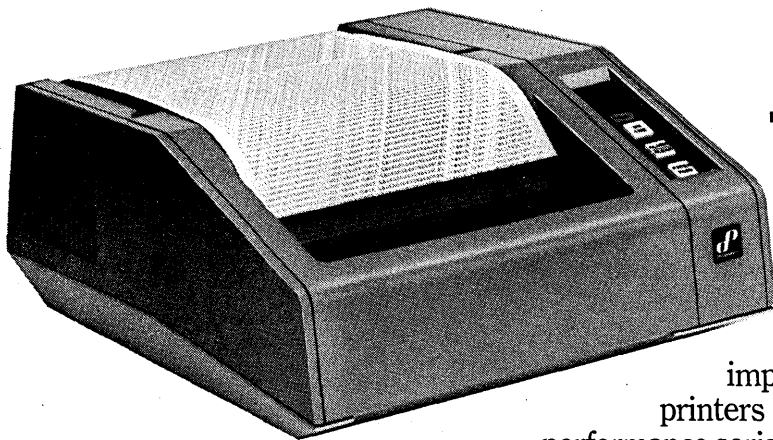

## **THE T-80 THERMAL PRINTER. 80 CPS.**

Definitely.

The company that built an impeccable reputation with its line printers is now delivering two high-performance serial printers with speeds of 80 CPS and 200 LPM... the slow end of the scale.

First, the T-80. The strong, silent type. With its non-impact thermal technology, it's ideal in applications where quiet is of the essence. In hospitals, for instance. Or open office situations. And in communications and instrumentation.

It is also the logical supplement to your CRT if you need occasional hard copy printouts.

And even though we call it slow, the T-80 is nearly three times as fast as most other thermal printers. Yet it costs about the same.

But for all its economy, the T-80 maintains the Dataproducts tradition of die-hard dependability.

A unique solid-state print head and a minimum of moving parts guarantee that.

And the head is readily changed by any operator in 10 easy seconds. The T-80. A top performer at 80 CPS.

# PRODUCTS DOWN?

## **THE M-200 MATRIX PRINTER. 200 LPM.**

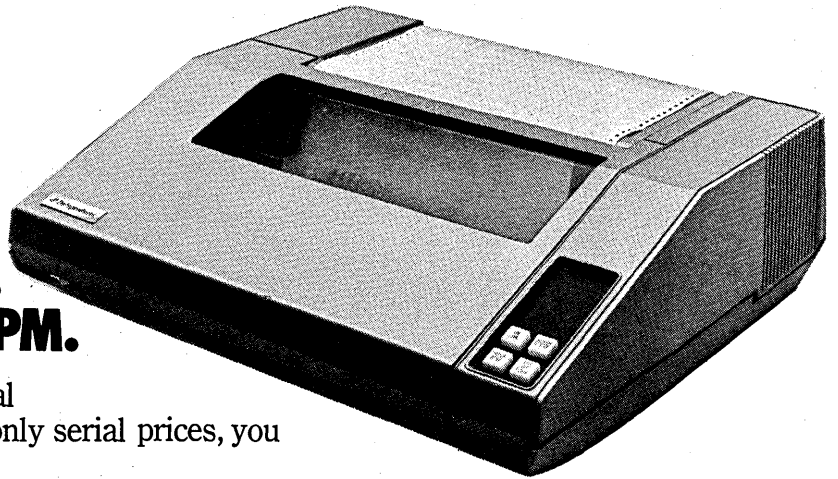

The M-200, too, is a serial printer. But, though you pay only serial prices, you get line printer performance.

How did we pull off this bit of wizardry?

Well, one major factor is our revolutionary 14-wire, dual-column print head.

A design that combines the speed and long life of multiple heads, with the flexibility of a single head. And it's got a life expectancy of about three years in normal use.

Any operator can change the M-200's head easily. And since the head price is so reasonable, you can pay for the change easily, too.

Like all products from The Printer Company, the M-200 is a reliable workhorse. Made even more so by its optional self-diagnostic system.

If something should go wrong, the system tells you if you can fix it yourself. Or if you can't, it tells you what to tell the serviceman. That saves him one trip. And saves you down-time.

The M-200 and T-80 serial printers. From now on, when you want to take it slow, you don't have to take any less than Dataproducts.



## **THE PRINTER COMPANY**

Telex: 69-8492/Darmstaedter Landstrasse 199, Frankfurt, W. Germany. Tel: 681-034, Telex: 841-416344.



Manufacturer	Texas Instruments	Trivex	Trivex	Univac	Univac
<b>Model Highlights</b>	770	40/80	Plus 70	Uniscope 100	Uniscope 200
1st ship/# shipped	06/77 # shipped NG	04/71 4,000 shipped	05/75 2,000+ shipped	05/70 # shipped NG	02/75 # shipped NG
Standalone or cluster	Standalone	Stand. or 32-cluster	Stand. or 32-cluster	Standalone	Standalone
Display format	24 lines of 80 chars	6/12 x 40 or 12x80	25 lines of 80 chars	12 x 80/ 16x64	24 lines of 64 or 80
Character format	7x9 dot matrix	5x7 dot matrix	7x9 dot matrix	Stroke	7x9 dot matrix
Character code	ASCII or EBCDIC	ASCII	EBCDIC	ASCII	ASCII
Programmable?	Programmable	Not programmable	Not programmable	Not programmable	Not programmable
Editing?	Character editing	Char & line editing	Character editing	Char & line editing	Char & line editing
Compatibility	Teletype, IBM 3780, & TI 742 compatible	IBM 2260/2265 compatible	IBM 3270/3275 compatible	Univac compatible	Univac compatible
<b>Display Features</b>	6 x 9 screen Reverse video, brightness levels, blinking, scrolling, paging, address/read cursor, protect, partial transmit	6 x 9 screen Blinking, address/read cursor, protect	8 x 11 screen Brightness levels, blinking, address/read cursor, protect, partial transmit	5 x 10 screen Blinking, scrolling, address/read cursor, protect, partial transmit	7 x 10 screen Blinking, scrolling, address/read cursor, protect, partial transmit
<b>Communications</b>	Asynchronous/synchronous ASCII or BSC Full- or half-duplex 110 to 4,800bps RS232C Poll/addressing, opt. autoanswer, opt. integral modem	Asynchronous/synchronous ASCII Half-duplex Up to 9,600bps RS232C Poll/addressing std.	Synchronous BSC or SDLC Half-duplex 110 to 9,600bps RS232C Poll/addressing std., autoanswer opt.	Asynchronous/synchronous ASCII Univac Half-duplex Up to 9,600bps RS232C Poll/addressing and autoanswer std.	Asynchronous/synchronous ASCII Univac Half-duplex Up to 9,600bps RS232C Poll/addressing and autoanswer opt.
<b>Keyboard</b>	Typewriter style with numeric pad	Detachable; typewriter or data entry style with numeric pad	Detachable; typewriter or data entry style with opt. numeric pad	Typewriter style with opt. numeric pad	Typewriter style with opt. numeric pad
<b>Peripherals</b>	Dual mini cartridge cassette, opt. integral printer, line printer, audio alarm	Impact printer	Impact printer; audio alarm; ID card reader & opt. light pen	Dual cassette, impact/non-impact printer, audio alarm	Dual cassette, impact/non-impact printer, audio alarm
<b>Display Pricing</b>	\$4,995 1-year lease/maint \$210/month	Vendor will not release pricing	\$2,900 \$85/month	\$3,945-\$4,365 \$150-\$168/month	\$4,640-\$5,038 \$169-\$187/month
<b>Controller Pricing</b>	— —		\$4,185 \$150(remote);\$187(local)	\$2,036-\$2,849 (mux) \$53-\$76/month (mux)	\$2,036-\$2,849 (mux) \$53-\$76/month (mux)
<b>Comments</b>	Based on 16-bit TMS 9900 microprocessor; contains 24K ROM & 8K-24K RAM; 200KB minicartridge			Two multiplexors can be cascaded to accommodate up to 31 terminals	Two multiplexors can be cascaded to accommodate up to 31 terminals

**Q1 CORPORATION**  
the first company to  
develop, manufacture and market  
microcomputer systems has now introduced  
the Q1 / Lite, the ultimate office machine

• Hauppauge, New York 11787  
Telephone: (516) 543-7800  
Telex: (510) 226-3730

Manufacturer	Univac	Video Data Systems	Video Data Systems	Wang Laboratories	Wang Laboratories
<b>Model Highlights</b>	UTS 400	100 Series	CG 1000	PCS & PCS-II	WCS-15
1st ship/# shipped	09/76 # shipped NG	03/73 250 shipped	03/75 50 shipped	04/76 791 shipped	10/77 2,000 shipped
Standalone or cluster	Stand. or 3-/6-cluster	Up to 32	Up to 32	Standalone	Standalone
Display format	12 or 24 x 64 or 80	8 x 32 to 24 x 80	8 or 16 x 32	16 x 24/ 24 x 80	16 x 24 or 24 x 80
Character format	7x9 dot matrix	7x8; 10x14 dot matrix	10x14 dot matrix	5x7/7x9 dot matrix	5x7 or 7x9 dot matrix
Character code	ASCII	ASCII	ASCII	ASCII or EBCDIC	ASCII or EBCDIC
Programmable?	User-created programs	Not programmable	Not programmable	Programmable	Programmable
Editing?	Char & line editing	No editing	Line editing optional	Char & line editing	Char & line editing
Compatibility	Univac compatible	Teletype compatible	Teletype compatible	Teletype, IBM 2741/3741 & 2780/3780, Burroughs TC 500 compatible	Teletype, IBM, Burroughs compatible
<b>Display Features</b>	7 x 10 screen Brightness levels, blinking, scrolling, address/read cursor, protect, partial transmit	Variable size screen Reverse video opt., blinking, scrolling	Variable size screen Reverse video opt., blinking, address/read cursor	5½ x 7½ screen Scrolling, address/read cursor, protect, partial transmit	7½ x 9½ screen Scrolling, address/read cursor, protect, partial transmit
<b>Communications</b>	Asynchronous/synchronous ASCII Univac Half-duplex Up to 9,600bps RS232C Poll/addressing and autoanswer opt.	Asynchronous/synchronous ASCII Full- or half-duplex Up to 9,600bps RS232C Opt. autoanswer, opt. integral modem and coupler	Asynchronous ASCII Full- or half-duplex Up to 1,200bps RS232C	Asynchronous/synchronous ASCII/BSC/Burroughs Full- or half-duplex 75/110 to 9,600bps RS232C Poll/addressing opt. (PCS-II), autoanswer opt., PCS-II, integral modem (PCS)	Asynchronous/synchronous ASCII/BSC/Burroughs Full- or half-duplex 75 to 9,600bps RS232C Poll/addressing and autoanswer opt.
<b>Keyboard</b>	Detachable; typewriter style with numeric pad	Detachable; typewriter style with numeric pad	Detachable (opt.); typewriter style with opt. numeric pad	Typewriter style with numeric pad	Typewriter style with numeric pad
<b>Peripherals</b>	Dual cassette, dual diskette, impact/non-impact printer	Cassette interface, ID card reader	Cassette interface, ID card reader	Cassette (PCS), diskette (PCS-II), impact printer, audio alarm	Single, dual, triple diskette; impact printer
<b>Display Pricing</b>	\$7,560-\$11,520 (instr.) \$282-\$346/month (master)	—	—	\$5,400/\$6,200 \$270; \$310/month	\$10,200 \$510/month
<b>Controller Pricing</b>	\$4,454-\$9,375 \$165-\$280/month	\$495-\$1995 Purchase only	\$1,995-\$4,995 Purchase only	\$1,000	\$2,000
<b>Comments</b>	Prices for slave units are \$128 on 1-yr lease for display station; \$4,440 on purchase of display station	Controller uses video monitor for display; also available in printer circuit boards	Controller uses video monitor for display	Basic price above includes cassette tape drive or single diskette drive (PCS-II); each additional emulator is priced at \$200	

## The DELTA 4050 Display Terminal with proven Burroughs, Honeywell & Univac emulation



Performance proven around the world



### USE THE DELTA 4050 FOR EXISTING AND NEW APPLICATIONS

When you need an emulating terminal, consider the DELTA 4050—the terminal that offers *true* emulation for your existing software. Most so-called "emulating" terminals provide nothing more than communications capability. That limitation will work for some new applications, but what of current jobs? That's where the DELTA 4050 outshines them all: it gets right down to business without modifications. Think of the time you'll save, and the problems you'll avoid.

While you're at it, think about the operating features you'd like to have in your display terminal system. You'll find them in the DELTA 4050 which offers more features and advantages, is more economical and is easier to use than the computer manufacturers' or other companys' emulating terminals. Compare the DELTA 4050 with the others; we think you'll be quite pleased at what you see. Call us now for full details.

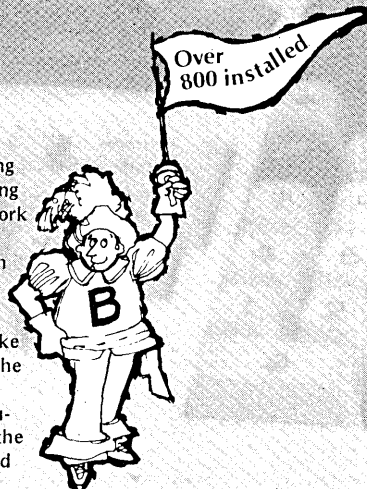

DELTA DATA SYSTEMS Corporation  
Woodhaven Industrial Park  
Cornwells Heights, PA 19020  
Phone: (215) 639-9400  
U.K. Subsidiary:  
DELTA DATA SYSTEMS LTD.  
Welwyn Garden 33833

# Now can divide

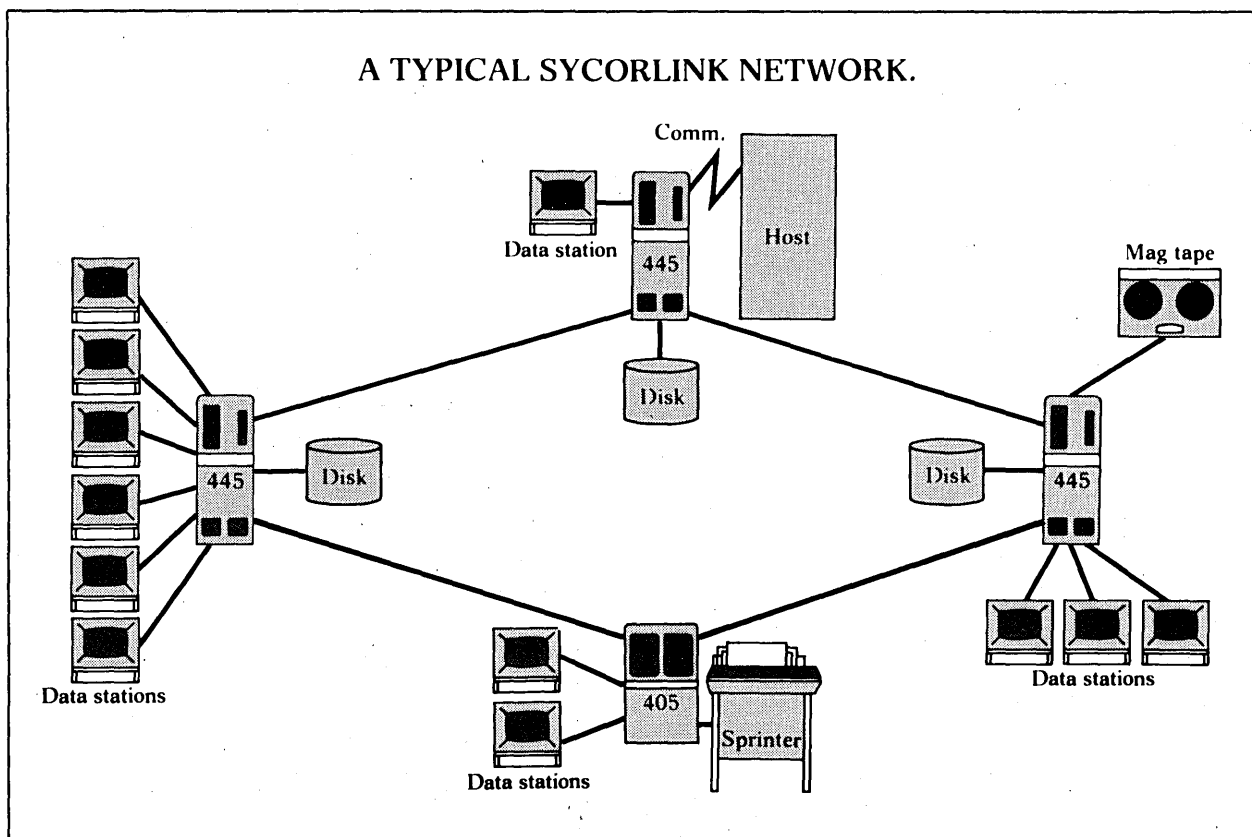

Sycorlink™ is a revolutionary resource sharing feature that lets you distribute the power and resources of computer systems throughout your organization. And conquer the problem of providing all your departments with the services they're looking for. At a price you're looking for.

In a nutshell, the Sycorlink networking feature is distributed processing the way it was meant to be.

## Put the power of your network at every work station.

With Sycorlink, every system in the network

can be tailored to handle the processing tasks of individual departments. And at the same time give authorized users in any department the power to access the files and peripherals of every other system in the network.

A user at any work station can access any file on any disk in the network. At the push of a key. Any file on any disk can be printed on any printer in the network. Any file can be transmitted to the host.

Any system in the network can process data from any file on any disk located at any other node in the network. And a system can be dropped out for maintenance or service

# you and conquer.

without disrupting the flow of data to and from any other node.

## **Match the workhorse to the work load.**

The Sycor 405 and 445 distributed processing systems can be mixed and matched in a Sycorlink network to create individual processing nodes with just the right amount of power for a specific department or location.

And while each node may be individually configured, it can access the files of another node just about as fast as its own files. Communicating this fast within the network allows nodes to share expensive peripherals, such as a line printer. So any way you put it together, your Sycorlink network has the performance capability that can get your job done. The way you want it done.

This means you never have to overequip any location, paying for power you don't need. Your first step in building your distributed processing network is the right one — with nothing to trip you up down the road.

## **Get started on a no-detour growth path.**

The upward compatibility of the Sycor 400 series lets you grow your network without redesigning your system or replacing hardware. We call it planned nonobsolescence.

As your needs at a specific site grow, our compatible 405 and 445 systems let you upgrade without reprogramming or introducing unfamiliar hardware to your operators.

## **Install systems up to a half mile apart.**

A Sycorlink network permits installation of systems up to a half mile away from each other. The systems are connected to each other by coaxial cables. This lets you increase your computer power simply by adding another system to the network. Without reprogramming.

Sycor's security-conscious software makes sure all disk files can be protected to prevent unauthorized access. You get peace of mind. And costs are kept to a minimum.

## **Link up your departments with Sycorlink. Call 800-521-2838 toll-free.**

Sycor pioneered the concept of distributed data processing more than ten years ago. Since then we've been at the cutting edge of distributed processing technology. With over 100 service centers located within a half-hour drive of 1750 North American cities, and 40,000 systems installed, we're ready to help you bring your users state-of-the-art service in distributed processing. They deserve it.

To find out more about how Sycorlink can help you conquer distributed processing problems, call Tony Fazio, VP Sales, at the number above. Or write Sycor, Inc., Ann Arbor, Michigan 48104.

Better yet, contact a nearby sales office. We're in the Yellow Pages under Data Processing Equipment.

**Sycor puts computer power where the work is.**

TM

# SYCOR®



Manufacturer	Western Union	Westinghouse Canada	Wintek	Wyle	Zentec
<b>Model Highlights</b>	Video 100	1625	Model B-R-B	Series 8000 & 9000	Model 9003
1st ship/# shipped	12/75 5,000 shipped	11/76 3,000 shipped	01/76 200+ shipped	1972 # shipped NG	06/75 3,000+ shipped
Standalone or cluster	Standalone	Stand. or 32-cluster	Standalone	Stand. or 16/32-cluster	Standalone or 2-cluster
Display format	12 or 24 x 80	12/18/24 x 80	16 lines of 80 chars	12 x 40/80; 24 x 80	24 lines of 80 chars
Character format	5x7 dot matrix	5x7/9 dot matrix	5x7 dot matrix	5x7 dot matrix	7x9 dot matrix
Character code	ASCII	ASCII	ASCII	ASCII or EBCDIC	ASCII
Programmable?	Not programmable	Not programmable	Not programmable	Not programmable	Programmable
Editing?	No editing	Char & line editing	Character editing	Char edit: line (9000)	Char & line editing
Compatibility	Teletype compatible	Teletype compatible; or user-specified		IBM 3275 & 2265 compatible	Teletype, IBM 3270/327 and opt. SDLC compatible
<b>Display Features</b>	5½ x 8¼ screen Address cursor	6½ x 8½ screen Reverse video, brightness levels and blinking; scrolling; paging; address/read cursor; protect; partial transmit	5½ x 7 screen Scrolling	7 x 9 screen Reverse video opt., brightness levels, blinking opt., scrolling, paging (9000); address/read cursor; protect, partial transmit	15-inch screen Reverse video, brightness levels, blinking, scrolling, paging, address/read cursor, protect, partial transmit
<b>Communications</b>	Asynchronous ASCII	Asynchronous/synchronous (ASCII; user-defined)	Asynchronous ASCII	Asynchronous/synchronous ASCII or BSC	Asynchronous/synchronous ASCII/BSC/SDLC
Line protocol	Full- or half-duplex	Full- or half-duplex	Full- or half-duplex	Full- or half-duplex	Full- or half-duplex
Transmission Speed	110 to 19,200bps	110-2,400/50-9,600bps	110 to 9,600bps	1,200 to 9,600bps	110 to 9,600bps
Interfaces	RS232C	RS232B/C, CCITT V.24	RS232C	RS232C	RS232C; MIL-188 B/C
Other features	Autoanswer opt.	Poll/addressing and opt. integral modem	Poll/addressing, auto-answer, opt. integral modem and coupler	Poll/addressing; auto-answer opt. (9000)	Polling/addressing opt.
<b>Keyboard</b>	Typewriter style with opt. numeric pad	Detachable; typewriter style with opt. numeric pad	Detachable; Teletype style	Detachable (9000); typewriter or data entry style with opt. numeric pad	Detachable; typewriter style with numeric pad
<b>Peripherals</b>	Cassette, single or dual diskette, impact printer, audio alarm	RS232C interface provided	Cassette	Impact printer, opt. cassette & diskette and opt. audio alarm	Cassette interface, 1-3 diskettes, impact printer, audio alarm
<b>Display Pricing</b>	\$860 1-year lease/maint \$65/month	\$3,1000 —	\$875 Purchase only	Vendor will not release pricing	\$3,900-\$8,000 —
<b>Controller Pricing</b>	— 1-year lease/maint —	\$4,000 —	— —	— —	\$3,900 base —
<b>Comments</b>	Built by Lear Siegler as ADM-3 and ADM-3A	1625 controller is standard CRT with addition of one plug-in module; interconnection of CRTs is via two twisted pairs		Discounts available based on lease term & number of units per system; 9000 is microprogrammable	Microprocessor-based unit (Intel 8080) with 6 to 64KB memory

## CONVERTING?



Try the experts. DASD Corporation encourages test evaluations of all of our language translators.

**RPG/RPG II to COBOL (DOS or OS)** will accept all types of RPG and produce **ANS COBOL**. Most translations are 100% error free. Our modular **COBOL** simplifies maintainability.

**SYSTEM/3 COBOL to OS COBOL** makes this tedious, redundant conversion completely automatic. We're 97% clean, which frees a lot of man hours for more important tasks.

**DOS COBOL to OS COBOL** is basically a difference of syntax, but may mean a lot of wasted man hours.

**GE MAP to OS COBOL** will allow immediate upgrade of your **GE 400** series to full **ANS COBOL**.

**360/20 BAL to 360/370 OS ALC** is an extremely solid product eliminating a monotonous programming job.

**DASD TRANSLATORS SAVE TIME AND MONEY.**

Many service options are available: lease, conversion only, conversion and clean compile; full conversion responsibility including testing and JCL.

For a prompt solution to your conversion problems, write or call today.

**DASD CORPORATION**  
National Marketing  
1480 Renaissance Drive—Suite 315  
Park Ridge, Illinois 60068  
312/299-5005



## What if your computer died?

Would your company be able to continue its business operation? Would you be able to recover? Where would you go to process your data processing workload? Do you have a backup computer facility?

You may qualify for limited membership in a national network of Recovery Operation Centers, all equipped with supporting utilities and data communication systems to suit its members' needs.

Let us hear from you. We're the leading management consultant in computer security, the proven name, advancing the state of the art through our work with 400 major corporations.



**Data Processing Security** INCORPORATED

Dallas/Fort Worth: 235 N.E. Loop 820  
Hurst, Texas 76053 817/589-2244  
Regional Offices:  
Atlanta Chicago Los Angeles New York

# Display Terminal Vendor Index

For additional information regarding the products listed in this survey, please contact the vendors directly, either at the addresses shown or by circling the appropriate number on the reader service card bound into this issue.

**Ann Arbor Terminals Inc.**  
6107 Jackson Road  
Ann Arbor, MI 48103  
(313) 769-0926  
CIRCLE 465 ON READER CARD

**Applied Digital Data Systems Inc.**  
100 Marcus Blvd.  
Hauppauge, NY 11787  
(516) 231-5400  
CIRCLE 466 ON READER CARD

**Beehive International**  
4910 Amelia Earhart Drive  
Box 25668  
Salt Lake City, UT 84125  
(801) 335-6000  
CIRCLE 467 ON READER CARD

**The Braegan Corp.**  
20740 Valley Green Drive  
Cupertino, CA 95014  
(408) 255-4200  
CIRCLE 468 ON READER CARD

**Bunker Ramo Corp.**  
Trumbull Industrial Park  
Trumbull, CT 06609  
(203) 377-4141  
CIRCLE 469 ON READER CARD

**Burroughs Corp.**  
Business Machines Group  
Burroughs Place  
Detroit, MI 48232  
(313) 972-9115  
CIRCLE 470 ON READER CARD

**Compugraphic Corp.**  
80 Industrial Way  
Wilmington, MA 01887  
(617) 944-6555  
CIRCLE 471 ON READER CARD

**Computek Inc.**  
143 Albany Street  
Cambridge, MA 02139  
(617) 272-8100  
CIRCLE 472 ON READER CARD

**Computer Optics Inc.**  
Berkshire Industrial Park  
Bethel, CT 06801  
(203) 744-6720  
CIRCLE 473 ON READER CARD

**Computer Peripheral Corp.**  
1225 Connecticut Ave.  
Bridgeport, CT 06607  
(203) 333-8339  
CIRCLE 474 ON READER CARD

**Conrac Corp.**  
600 N. Rimsdale Ave.  
Covina, CA 91722  
(213) 966-3511  
CIRCLE 475 ON READER CARD

**Control Data Corp.**  
8100 34th Ave. South  
Minneapolis, MN 55420  
(612) 853-4656  
CIRCLE 476 ON READER CARD

**Courier Terminal Systems Inc.**  
2202 E. University Drive  
Phoenix, AZ 85034  
(602) 244-1392  
CIRCLE 477 ON READER CARD

**Data 100 Corp.**  
6110 Blue Circle Drive  
Minnetonka, MN 55343  
P.O. Box 1222  
Minneapolis, MN 55440  
(612) 941-6500  
CIRCLE 478 ON READER CARD

**Data General Corp.**  
Route 9  
Southboro, MA 01772  
(617) 485-9100  
CIRCLE 479 ON READER CARD

**DatagraphiX Inc.**  
P.O. Box 82449  
San Diego, CA 92138  
(714) 291-9960  
CIRCLE 480 ON READER CARD

**Datamedia Corp.**  
7300 N. Crescent Blvd.  
Pennsauken, NJ 08110  
(609) 665-2382  
CIRCLE 481 ON READER CARD

**Datapoint Corp.**  
9725 Datapoint Drive  
San Antonio, TX 78284  
(512) 696-4520  
CIRCLE 482 ON READER CARD

**Dataview Inc.**  
23A Dana Street  
Malden, MA 02148  
(617) 322-2244  
CIRCLE 483 ON READER CARD

**Delta Data Systems Corp.**  
Woodhaven Industrial Park  
Cornwells Heights, PA 19020  
(215) 639-9400  
CIRCLE 484 ON READER CARD

**Digi-Log Systems Inc.**  
Babylon Road  
Horsham, PA 19044  
(215) 672-0800  
CIRCLE 485 ON READER CARD

**Digital Equipment Corp.**  
Main Street  
Maynard, MA 01754  
(617) 897-5111  
CIRCLE 486 ON READER CARD

**Elbit U.S.A.**  
8100 34th Ave. South  
Box 0  
Minneapolis, MN 55440  
(612) 853-7050  
CIRCLE 487 ON READER CARD

**Four Phase Systems Inc.**  
19333 Vallco Parkway  
Cupertino, CA 95014  
(408) 255-0900  
CIRCLE 488 ON READER CARD

**Genesis One Computer Corp.**  
300 East 44th Street  
New York, NY 10017  
(212) 557-3500  
CIRCLE 489 ON READER CARD

**Goodwood Data Systems Ltd.**  
150 Rosamond Street  
Carleton Place, Ontario,  
Canada 7C3P4  
CIRCLE 490 ON READER CARD

**Harris Communications Systems Inc.**  
11262 Indian Trail  
P.O. Box 44076  
Dallas, TX 75234  
(214) 620-4400  
CIRCLE 491 ON READER CARD

**Hazeltine Corp.**  
Cuba Hill Road  
Greenlawn, NY 11740  
(516) 261-7000  
CIRCLE 492 ON READER CARD

**Hewlett-Packard**  
1501 Page Mill Road  
Palo Alto, CA 94304  
(415) 493-1501  
CIRCLE 493 ON READER CARD

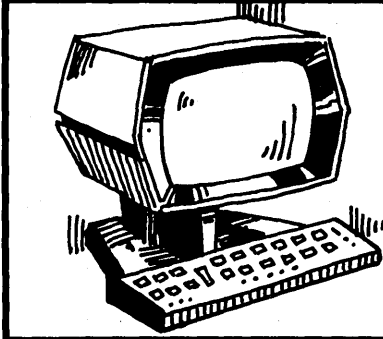

## CICS USERS

DASD's new utility map generator (MAPGEN) will increase your BMS coding productivity by at least 75%.

MAPGEN is not a new language. It is a system where the completion of a simple specification form will greatly improve accuracy by eliminating unnecessary data, add flexibility and greatly simplify maintenance. All DFHMDS, DFHMDSI and DFHMDF macro source statements are program generated.

A hard copy image of each screen is automatically printed at the time the map is defined.

'Map build' features aid in the use of extended features under CICS/VS.

Call or write today

**DASD CORPORATION**  
National Marketing  
1480 Renaissance Drive—Suite 315  
Park Ridge, Illinois 60068  
312/299-5005



CIRCLE 144 ON READER CARD

## DISPLAY TERMINAL VENDOR INDEX

**Honeywell Information Systems**  
60 Walnut Street  
Wellesley Hills, MA 02181  
(617) 237-4100  
CIRCLE 494 ON READER CARD

**International Business Machines Corp. (IBM)**  
Data Processing Division  
1133 Westchester Ave.  
White Plains, NY 10604  
(914) 696-1900  
CIRCLE 495 ON READER CARD

**Incoterm Corp.**  
65 Walnut Street  
Wellesley Hills, MA 02181  
(617) 237-2100  
CIRCLE 496 ON READER CARD

**Inforex Inc.**  
21 North Ave.  
Burlington, MA 18103  
(617) 272-6470  
CIRCLE 497 ON READER CARD

**Informer Inc.**  
8332 Osage Ave.  
Los Angeles, CA 90045  
(213) 649-2030  
CIRCLE 498 ON READER CARD

**Infoton Inc.**  
Second Ave.  
Burlington, MA 01803  
(617) 272-6660  
CIRCLE 499 ON READER CARD

**Intelligent Systems Corp.**  
2405 Pine Forrest Drive  
Norcross, GA 30071  
(404) 449-5961  
CIRCLE 500 ON READER CARD

**International Computers (ICL) Inc.**  
Turnpike Plaza  
197 Highway 18  
East Brunswick, NJ 08816  
(201) 246-3400  
CIRCLE 501 ON READER CARD

**International Telephone & Telegraph Corp. (ITT)**  
Data Equipment & Systems  
East Union Ave.  
East Rutherford, NJ 07073  
(201) 935-3900  
CIRCLE 502 ON READER CARD

**Intertec Data Systems Corp.**  
1851 Interstate 85 South  
Charlotte, NC 28208  
(704) 377-0300  
CIRCLE 503 ON READER CARD

**Kustom Electronics Inc.**  
Data Communications Div.  
1010 West Chestnut  
Chanute, KS 66720  
(316) 431-4380  
CIRCLE 504 ON READER CARD

**Lear Siegler Inc.**  
Electronic Instru. Div.  
714 N. Brookhurst Street  
Anaheim, CA 93803  
(714) 774-1010  
CIRCLE 505 ON READER CARD

**Megadata Computer & Communications Corp.**  
35 Orville Drive  
Bohemia, NY 11716  
(516) 589-6800  
CIRCLE 506 ON READER CARD

**Memorex Corp.**  
Equipment Group  
San Tomas at Central Expwy.  
Santa Clara, CA 95052  
(408) 987-3412  
CIRCLE 507 ON READER CARD

**Mohawk Data Sciences Corp.**  
1599 Littleton Road  
Parsippany, NJ 07054  
(201) 540-9080  
CIRCLE 508 ON READER CARD

**NCR Corp.**  
EDP Products Group  
Building 23, 3rd Floor  
Main & K Streets

Dayton, OH 45409  
(513) 449-6620  
CIRCLE 509 ON READER CARD

**Olivetti Corp. of America**  
500 Park Ave.  
New York, NY 10022  
(212) 371-5500  
CIRCLE 510 ON READER CARD

**Omron Systems Inc.**  
432 Toyama Drive  
Sunnyvale, CA 94086  
(408) 734-8400  
CIRCLE 511 ON READER CARD

**Ontel Corp.**  
250 Crossway Park Drive  
Woodbury, NY 11797  
(516) 364-2121  
CIRCLE 512 ON READER CARD

**Perkin-Elmer Data Systems Terminals Division**  
Route 10 & Emery Ave.  
Randolph, NJ 07801  
(201) 366-5550  
CIRCLE 513 ON READER CARD

**Perry Electronics**  
2424 Atlantic Ave.  
Raleigh, NC 27604  
(919) 833-2554  
CIRCLE 514 ON READER CARD

**Pertec Business Systems**  
17112 Armstrong Ave.  
Santa Ana, CA 92705  
(714) 540-8340  
CIRCLE 515 ON READER CARD

## Stocking genuine DEC computer spares

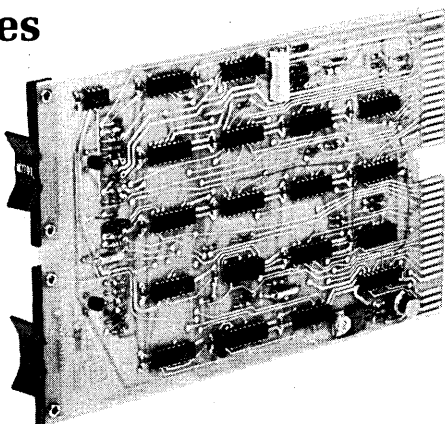

...  
call  
**Radgo.** Radgo is stocked and staffed to help you with your requirements for most general purpose K&M series and many computer spare modules manufactured by Digital Equipment Corporation — at factory prices. We also stock a large assortment of COMPUTER SUPPLIES.

Call today:  
(513) 752-6880.  
Outside Ohio:  
(800) 543-1986

**radgo**  
3988 McMann  
Cincinnati, Ohio 45245

CIRCLE 134 ON READER CARD

## THE HAWK LETS YOU SEE DATA.



**Captures and stores information.  
Makes solving data communications  
problems easy.**

The Hawk 4000. IDS's advanced microprocessor-based Data Trap that can monitor, transmit, and receive data between a modem and terminal on a 9-inch, 512 character screen. It's smart enough to spot a programmed 127 character sequence and store 4096 characters in non volatile memory for analysis with or without Idle Deletion. Polling is tested at the push of a button.

- All switches stored in memory & displayed on screen
- BISYNC, SDLC, HDLC, ADCCP standard protocols
- Full duplex, asynchronous or synchronous up to 19,200 bps
- Complete polling test and simulation
- ASCII, EBCDIC, Hexadecimal, Octal, BAUDOT, EBCD, IBM Selectric, IPARS, FIELD, TRANSCODE formats



**INTERNATIONAL  
DATA  
SCIENCES, INC.**  
ALBANY TEL. LINKER'S IN DATA COMMUNICATIONS

100 Nashua St., Prov., R.I. 02904 • Tel. (401) 274-5100 • TWX 710-381-0285  
Export: EMEC, Box 1285, Hallandale, Florida 33009

CIRCLE 156 ON READER CARD

**DATAMATION**

**Plantronics Inc.**  
385 Reed Street  
Santa Clara, CA 95050  
(408) 249-1160  
CIRCLE 516 ON READER CARD

**Racal-Milgo Inc.**  
8600 N.W. 41st Street  
Miami, FL 33166  
(305) 592-8600  
CIRCLE 517 ON READER CARD

**Raytheon Data Systems Co.**  
1415 Boston-Providence TnPk.  
Norwood, MA 02162  
(617) 762-6700  
CIRCLE 518 ON READER CARD

**Scientific Measurement Systems Inc.**  
26 Olney Ave.  
Cherry Hill, NJ 08003  
(609) 424-5220  
CIRCLE 519 ON READER CARD

**Soroc Technology Inc.**  
165 Freedom Ave.  
Anaheim, CA 92801  
(714) 992-2860  
CIRCLE 520 ON READER CARD

**Sycor Inc.**  
100 Phoenix Drive  
Ann Arbor, MI 48104  
(313) 971-0900  
CIRCLE 521 ON READER CARD

**Tano Corp.**  
4521 West Napoleon Ave.  
Metairie, LA 70001

(504) 888-4884  
CIRCLE 522 ON READER CARD

**TEC Inc.**  
2727 N. Fairview Ave.  
Tucson, AZ 85705  
(602) 792-2230  
CIRCLE 523 ON READER CARD

**Tektronix Inc.**  
P.O. Box 500  
Beaverton, OR 97005  
(503) 644-0161  
CIRCLE 524 ON READER CARD

**Teleram Communications Corp.**  
1032 Mamaroneck Ave.  
Mamaroneck, NY 10543  
(914) 698-7789  
CIRCLE 525 ON READER CARD

**Teleray Inc.**  
P.O. Box 24064  
Minneapolis, MN 55424  
(612) 942-3300  
CIRCLE 526 ON READER CARD

**Teletype Corp.**  
5555 Touhy Avenue  
Skokie, IL 60076  
(312) 982-2000  
CIRCLE 527 ON READER CARD

**Telex Terminal Communications Inc.**  
3301 Terminal Drive  
Raleigh, NC 27611  
(919) 834-5251  
CIRCLE 528 ON READER CARD

**Termiflex Corp.**  
17 Airport Road  
P.O. Box 1123  
Nashua, NH 03060  
(603) 889-3883  
CIRCLE 529 ON READER CARD

**Terminal Data Corp.**  
11878 Coaley Circle  
Rockville, MD 20852  
(301) 881-7655  
CIRCLE 530 ON READER CARD

**Texas Instruments Inc.**  
Digital Systems Division  
12203 Southwest Freeway  
P.O. Box 1444  
Houston, TX 77001  
(713) 494-5115  
CIRCLE 531 ON READER CARD

**Trivex Inc.**  
Information Systems Div.  
3180 Red Hill Ave.  
Cost Mesa, CA 92626  
(714) 546-7781  
CIRCLE 532 ON READER CARD

**Univac Division**  
Sperry Rand Corp.  
P.O. Box 500  
Blue Bell, PA 19422  
(215) 542-4011  
CIRCLE 533 ON READER CARD

**Video Data Systems**  
657 Old Willets Path  
Hauppauge, NY 11787

(516) 234-1010  
CIRCLE 534 ON READER CARD

**Wang Laboratories Inc.**  
836 North Street  
Tewksbury, MA 01876  
(617) 851-4111  
CIRCLE 535 ON READER CARD

**Western Union Data Services Co.**  
70 McKee Drive  
Mahwah, NJ 07430  
(201) 529-1170  
CIRCLE 536 ON READER CARD

**Westinghouse Canada Ltd.**  
Box 5009  
Burlington, Ontario  
Canada L7R 4B3  
(416) 528-8811  
CIRCLE 537 ON READER CARD

**Wintek Corp.**  
902 N. 9th Street  
Lafayette, IN 47904  
(317) 742-6802  
CIRCLE 538 ON READER CARD

**Wyle Computer Products**  
3200 Magruder Blvd.  
Hampton, VA 23666  
(804) 838-0122  
CIRCLE 539 ON READER CARD

**Zentec Corp.**  
2368-C Walsh Ave.  
Santa Clara, CA 95050  
(408) 246-7662  
CIRCLE 540 ON READER CARD

**No one  
knows more  
about servicing  
Centronics  
Printers than  
Centronics.**

And no one can offer you a more cost effective service contract. For full details call today. Toll free: 1-800-258-1952. Or write Centronics Data Computer Corp., Hudson, NH 03051.

**CENTRONICS® SERVICE**  
Simply Better

CIRCLE 142 ON READER CARD

# EIA CABLES

5 feet \$18.00      25 feet \$28.00  
15 feet \$23.00      40 feet \$35.50  
50 feet \$40.00

SPECIFY CONNECTORS AS  
MALE/MALE, MALE/FEMALE OR  
FEMALE/FEMALE.

Delivery  
From Stock



Prices apply  
all quantities,  
U.S. only,  
FOB Springfield, Va.



*Dynatech Data Systems*

7644 DYNATECH CT.  
SPRINGFIELD, VA 22153  
PHONE: 703-569-9000

A DYNATECH  
COMPANY

# AT LOW PRICES

CIRCLE 150 ON READER CARD



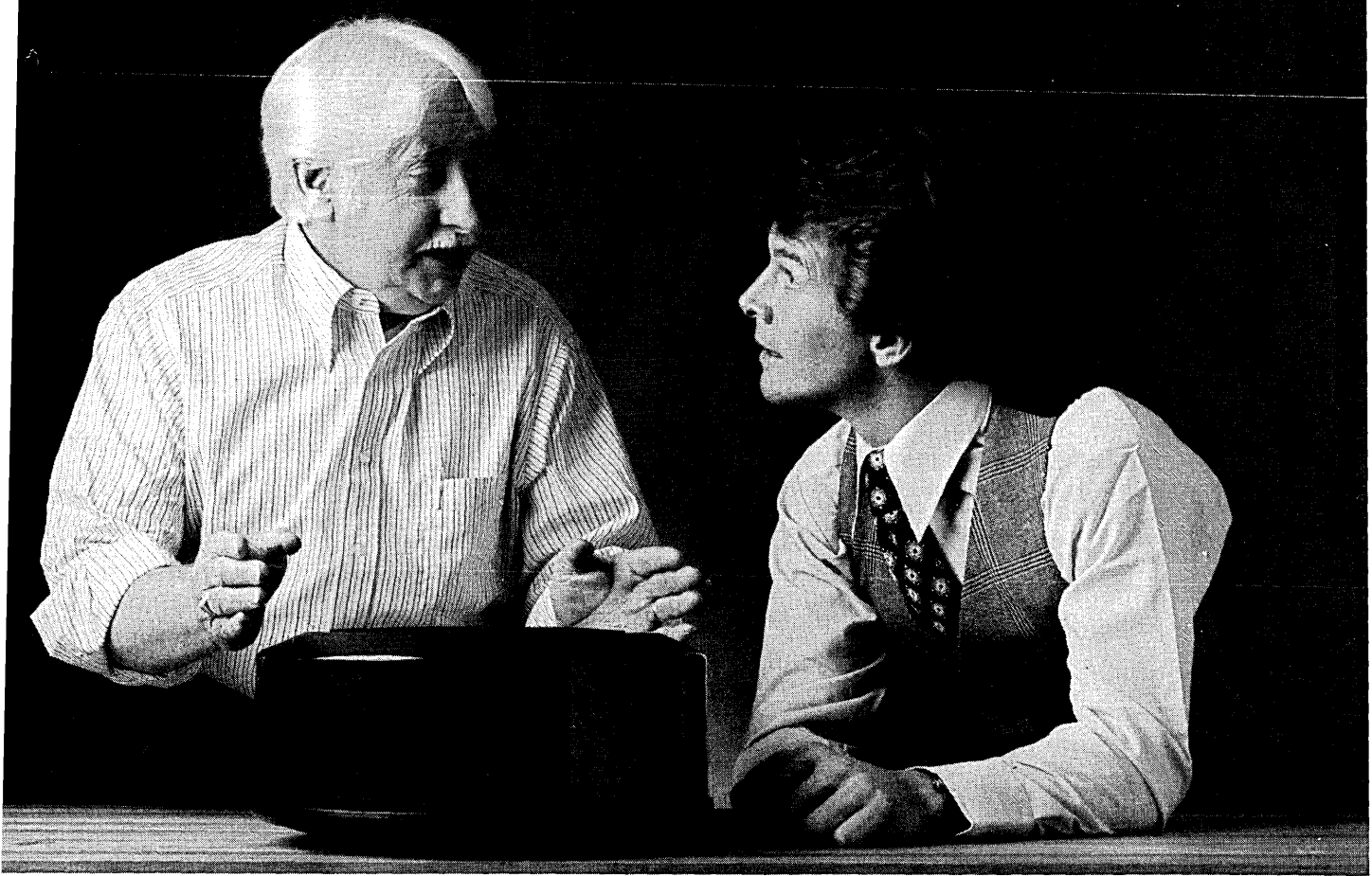

## **Reliability.** **It's passed on from generation to generation.**

At last count, we'd produced over 1,000,000 disc packs and cartridges spanning seven generations of significant changes. Each new generation has offered major advances in technology. Greater capacities, faster access, improved price/performance.

But with all the changes, through each generation, one thing has never changed; the Memorex commitment to make every disc pack the most reliable in the industry.

It's made possible by our people—because it's their commitment to uncompromising standards of quality that have made Memorex disc packs the industry's standard of value.

We make 12 different models of disc packs. Models for Memorex disc drives and for IBM, CDC, Honeywell, NCR, Calcomp, Sperry-Univac and Ampex drives, too.

Every model we make has to pass over 100 manufacturing inspections before a single disc pack is ever passed on to a customer. And every disc pack we lease or sell is backed by a written warranty agreement, and supported by the largest field organization of dedicated media specialists in the computer industry.

All to make Memorex disc packs the ones you can rely on for generations to come.

Call your Memorex representative or distributor in principal cities worldwide. Or contact us at 1500 Memorex Drive, MS-0060, Santa Clara, CA 95052. Call (408) 987-3177.

# **MEMOREX**CELLENCE



## State Government

# The Teale Center Five Years Later

California's state data center, hub of an equipment procurement controversy, now serves more than double number of agencies originally assigned to it

California's Teale Data Center, hub of an equipment procurement controversy which lasted more than two years (March 1974, p. 122) has moved into its fifth year of operation, serving more than double the number of state agencies originally assigned to it.

And it's saving the state money. "At a minimum, Teale has saved the state \$10,000 in hard cash and another \$10,000 in cost avoidance," said center director, Ira B. Isbell.

The procurement controversy wound down last year when the state paid IBM \$987,668 after two years of negotiation over who damaged whom and to what extent when IBM failed to convert the state's Department of Motor Vehicles computer operations into the Teale center by an agreed upon date. IBM acknowledged its failure to meet the deadline but wanted money for development work. The state contended it was damaged for things like continued rental to Univac for DMV equipment, continued salaries to personnel in the DMV separate center, and the fact that it was unable to implement a staggered renewal system for motor vehicle registration as soon as it had intended. Each side gave a little. IBM originally had asked \$4 million for its conversion efforts.

DMV never was converted to Teale. It continues to operate its own separate center using Univac equipment, separated by a windowed wall from the IBM-based Teale shop. "They're at capacity. They'll have to go out to bid for an upgrade soon," said Isbell of DMV.

Isbell himself grew up with DMV and served as director of its data processing center before the Teale center was created. The Teale center is housed in a DMV building and Isbell occupies the same office he did before he switched jobs. "I'm the only guy who ever left DMV and never moved."

### A minor hero

He feels his selection as Teale center director might have had something to do with how he handled a fire situation on Christmas night of 1972. "I received a call at home that there was a fire on the fifth floor. The data center was on the

second floor. Luckily, a few weeks before we had been having some trouble with the cafeteria and I had gone out and purchased a number of Sears plastic car covers. I was able to get every piece of equipment covered in time and I became a minor hero."

The original Teale center was in downtown Sacramento, but was moved because "we have a fine site here." The transfer was done over a weekend and was accompanied by an upgrade from one 370/165 to two and conversion from HASP to ASP. "The system flew on Monday."

### There is now talk of a Teale Center Number Two to provide better backup.

Legislation creating the center was enacted in mid-'72 and was authored by the man whose name it bears, State Senator Stephen P. Teale. Teale retired from the Senate in December 1972. The bill originally established four consolidated centers but the others were unfunded during the controversy surrounding the Teale procurement. Now, partly due to the success of Teale, the state is in the process of establishing a second, a Health and Welfare Center. Isbell said there also is talk of a Teale Center Number Two to provide better backup.

Initially, the center was almost totally IBM. The equipment it started with, in addition to the two 3-megabyte 370/165's, included 32 spindles of disc, 14 tape drives, three printers, five card reader/printers, and several 370X boxes, all from IBM.

Today it has two 370/168's, both model 3's and one with an attached processor; Intel disc drives; Intel memory; a wide variety of terminals; Four Phase distributed processing systems and some 30 Data 100 satellite miniprocessors.

### Storage problem

Isbell said storage is beginning to become a problem. The center has 70,000 reels of tape and some 40,000 discs. He's looking into mass storage and to upgrad-

ing his disc drives to the Winchester type. At the time he added the attached processor, he said, he also considered a multi-processor. "AP turned out to be the lowest cost and it was a good buy. We predicted a 30% improvement in throughput. It's been closer to 50%."

Cutover of users' work from existing agency-owned computer systems to the Teale center began with the Department of Transportation (Caltrans) workload. Between August 1972 and June 1975, designated Teale users, Teale personnel and system vendors worked together to convert systems, programs and data. By the end of Fiscal Year 1974-75 the center was fully operational, serving 32 state customers. These initial consolidations, Isbell said, made possible the release of six existing computer systems. The Department of Finance estimated that a \$35,000 per month savings in equipment costs was yielded.

Today the center serves 70 state entities, some of which abandoned systems of their own and some far too small to ever have been able to justify computer services on their own.

Specific services offered are batched processing, time-sharing option, real-time systems, graphic plotting and bursting, decollating and delivering computer printout.

Initial budgets for the center were derived from funds transferred from departments scheduled to receive Teale services and from new funding for conversion efforts. On July 1, 1975, the Teale Data Center billing system went into effect and the center became a fully reimbursable unit within state government.

### Discounts allowed

Isbell said its rates are based on utilization of resource cost centers and are reviewed periodically to ensure that they are equitable. To encourage efficient utilization of resources, he said, customers are allowed a 35% discount for processing during off-shift hours. To further encourage use of available weekend processing capacity, a 50% discount was offered for some processing beginning May 1, 1977.

A few months after the billing system

# news in perspective

was implemented, a cash flow problem developed. Revenue collected was not sufficient to cover all costs. Isbell said this was due primarily to reductions in Caltrans' data processing. The Teale Data Center Advisory Committee considered recommending increasing rates or adding a surcharge for services. However, Isbell said, because the interagency agreements with center users were collectively adequate to cover expenditures, the Department of Finance Director and the Secretary of the Business and Transportation Agency (under whose jurisdiction Teale falls) decided to encumber these funds and transfer them to the center. Any money collected in excess of actual services rendered was credited to the appropriate user and repaid during FY 1976-77. At the close of FY 1975-76, Teale owed approximately \$1 million to its customers. This was completely repaid by the end of FY 1976-77.

To improve cash flow and provide a more stable financial base, the Teale center sought and got legislation establishing a revolving fund in the State Treasury. The legislation, effective January 1, 1977, allows for retention of excess reimbursements at the close of a fiscal period and provides that rates for services be adjusted when the revolving fund exceeds \$2,000,000 at the end of any fiscal year.

Last July, Isbell said, "rates were reduced 20% across the board." He said another reduction of 1% will be made this July. "As business keeps coming in, our costs get lower," he explained.

Although the center's batch workload has increased 12% per year and real-time systems 40% per year, Isbell said, budgets have shown minimal growth. Actual expenditures for Fiscal Years 1974-75, 1975-76 and 1976-77 were less than the approved budgets.

## Held the line

Isbell said the center has held the line on budget increases by: "monitoring all expenditures to ensure that they are absolutely necessary; conducting personnel utilization studies which determine the most effective use of personnel; and by reassigning or loaning staff to meet functional needs of the organization rather than requesting additional staff."

Budgets and actual expenditures were for FY 1974-75, \$10,515,624 and \$9,604,350; for FY 1975-76, \$10,017,727 and \$9,612,002; and for FY 1976-77, \$10,951,991 and \$10,584,735. Isbell said the budget for FY 1977-78 (ending July 1) is \$11,148,214. He predicted actual expenditures will be under this amount.

In 1975, the State Legislature mandated a study of Teale Data Center by an

outside consulting firm. Boeing Computer Services did the study and, among other things, recommended that Teale should purchase its two 168's and should consider acquiring additional equipment to augment both the existing computer system and its attendant peripherals and that this equipment could be supplied by other than IBM.

After the Boeing study, Teale recommended to the Business and Transportation Agency Secretary that the two 168's be purchased and the Secretary accepted the recommendation. On June 1, 1975, the computers were purchased. Isbell said this purchase will result in net savings of \$4.4 million over a five year period.

Following the Boeing recommendation that Teale consider acquiring peripheral equipment from vendors other

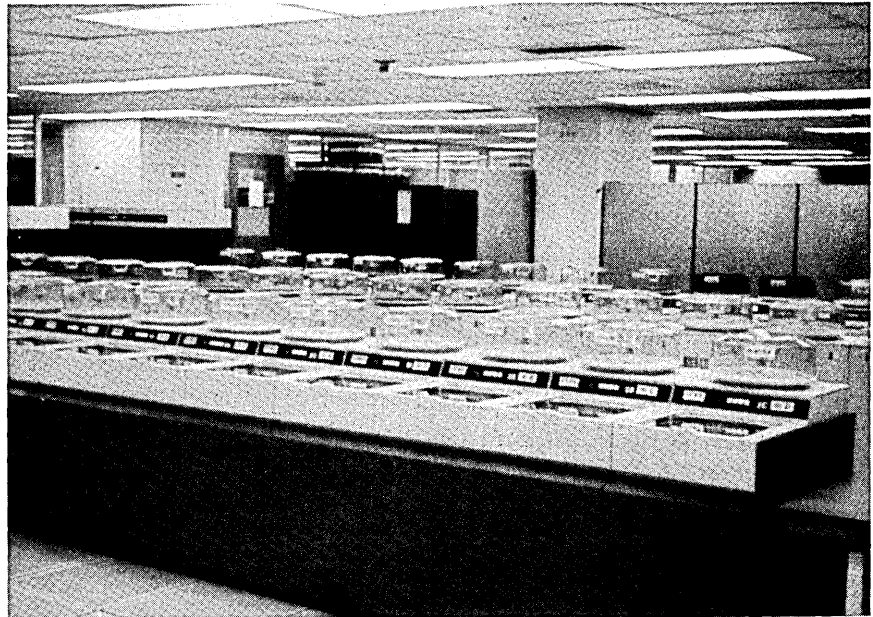
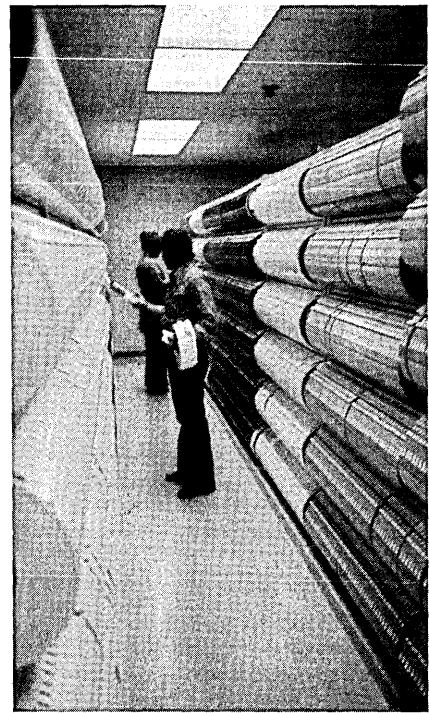

WITH some 40,000 discs and 70,000 reels of tape, Teale center looks into mass storage and an upgrade of disc drives to the Winchester type.

than IBM, the center in late June 1975 agreed to lease 52 disc drives from ITEL Corp. Estimated yearly savings from this agreement, Isbell said, are \$200,000.

## Benchmarked IMS

In 1977, Teale added an Advanced Text Management System (ATMS) and the Adabas data base management system produced by Software a.g. to the services it affords customers. "We benchmarked IMS (IBM's data base management system) but we never used it."

Isbell said workload projections obtained from major center users indicate increases in on-line processing and a continuance of current batch processing requirements. For Teale to maintain acceptable response times for the on-line

systems and favorable turn-around times for batch jobs under increased workload demands, he said, additional computing capacity is required. He said feasibility studies currently are underway for acquiring additional computing power and for acquiring high speed, higher density disc drives for each system.

The Teale center is highly secure from a physical standpoint—entrance through man-traps, an extensive Halon fire system. Isbell is looking into improved software security. He also wants to develop a recovery program. "We have one but it isn't adequate."

One thing he doesn't want for the future is another hotly contested procurement. He doesn't think this will happen.

—Edith Myers

# Dramatic Turnaround at Memorex

Sales in five years have nearly tripled and employment has been doubled

Memorex Corp., the company that five years ago was desperately seeking to be acquired, now is on an acquisition kick of its own. It's a sign of the admirable position the Santa Clara, Calif., maker of peripherals and magnetic media, is in following a dramatic turnaround.

Four years ago its stock was selling at \$1.50 per share. Two years ago it was \$8, and today it's above \$40. But from here on, it appears, it's all uphill for Memorex.

Under Robert C. Wilson, only the second chief executive officer at Memorex, the company has made unbelievable gains. Wilson, who took over for founding president Larry Spitters in May 1974, has increased the company's net worth

looser structure are more than reactions to what IBM announces. The company, for example, recently was the first to announce a cache-fronted disc drive capability. Its 3770 provides from one to 18 megabytes of CCD memory to speed up accesses from data bases stored in Memorex's equivalents of the IBM 3330 and 3350 drives. Further, the company is expected soon to announce a hardware/software combination referred to internally as the Super Three. It is designed to extend the capability of the IBM System/3 model 10, enabling it to handle up to 16 3277 terminals and enabling the user to stay longer with the S/3, instead of having to migrate to an S/34.

Earlier this year Memorex elevated its

a user to reconfigure his network and monitor and control it from the console. And that crt console can be remoted over a communications line. The company shortly will be offering SDLC support for it under NCP-VTAM, as well as a software package that allows a user from his terminal to connect himself to the application in whatever host he wishes. The latter will be called the terminal initiated applications switching package, something not available functionally from IBM without going through the full conversion to VTAM.

## Importance of software

"So we have a number of things like that," boasts Allen, "such as packet net-

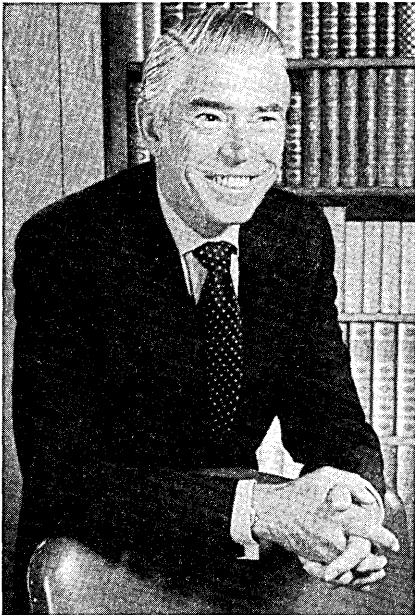

ROBERT C. WILSON: In his office, left, and in jogging togs early last month during Memorex's first annual Fitness Day run, a four-mile run which Wilson joined at the 100-yard mark and

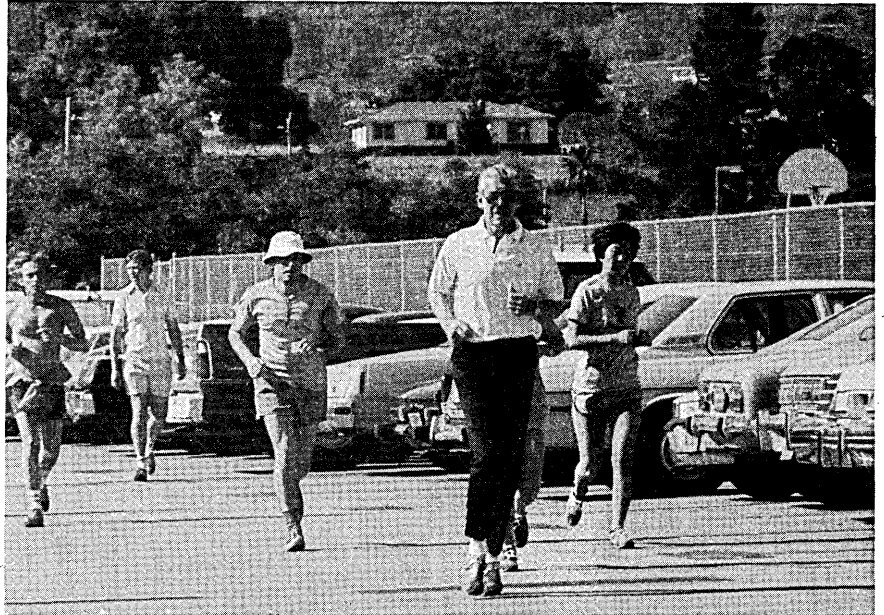

completed. He said earlier he planned to run only two miles, the distance he jogs daily, but ended up finishing the run with about 200 other Memorex employees.

from a negative \$87 million in 1973 to \$114 million at the end of '77, has decreased total debt from \$301 million to \$113 million, and has transformed a company that lost \$119 million in '73 to one that chalked up a profit of \$56 million last year.

Nor is all this the result of retrenchment or mere belt-tightening. In the same period, the company has increased sales from \$177 million to \$450 million and doubled employment to 10,000. Last year, it reorganized from the centralized management instituted by Wilson when he took over to a decentralized structure that allows for more autonomy.

Products being developed by this

communications division to group status. And that group, too, is taking the initiative. "We're the only independent manufacturer who offers both the front-end processing capability at the host end and the remote terminal subsystem," says the group's vice president and general manager Richard C. Allen. He had headed the communications division and before that was vp of engineering.

Since 1970 or so, Memorex has been delivering its 1270 terminal controller, continued demand for which has caused the firm to reinstitute manufacturing of it. Allen also has a programmable unit, the 1380, which can emulate an IBM 270X attached to a 370 host; further it enables

work interfaces in a dual-processor version, which will be coming along in the next few months in the 1380 product." He adds that the importance of software in future products can be seen in the head count in his engineering staff. "We've added a lot of people in the last year, and our head count mix now stands 60% software, 40% hardware." It's a reversal from the immediate past.

Allen sees his market primarily as the large- and medium-sized users of IBM 370s and System/3s, but views this only "as a stepping stone to building ourselves into a full network capability supplier." He looks to moving more intelligence out to the remote terminals and to the front-



# news in perspective

end processor, and supplying more of the support equipment needed to minimize the finger pointing that goes on when something isn't working. "We want to be able to take the full responsibility for the user's network," he explains. "We will be providing everything, short of the actual transmission path."

He notes the company has begun to add intelligence to hardware, that all new controllers have self-test and built-in diagnostic features. "But the kind of intel-

states that equipment products comprise some 61% of total revenues, steadily outpacing media products. And overseas sales last year accounted for 37% of the total.)

Plant's group is a combination of the former oem division and last year's acquisition of the Southern California-based Business Systems Technology Inc., manufacturer of peripherals for small systems. To oem's it sells only disc. But through its BST facility it sells to end



MEMOREX LEADERS: Richard C. Allen, left, vice president and general manager, Communications Group; A. Keith Plant, vp and general manager of General Systems Group; and Marcello Gumucio, vp and general manager of Large Storage Systems Group.

ligence I see us going to is far in excess of that. We will be moving toward intelligence that will allow the user to do more of his processing and storage locally at the terminal system." But the group executive evades a question about providing a standalone processor, saying there are so many processors in the hardware that it's difficult to talk about standalones.

Allen, whose group recently occupied an 86,000 square-foot building in nearby Cupertino—to the envy of executives still in crowded facilities in the headquarters complex—says he also sees Memorex participating somehow in the growth not only of data communications but also voice, image, and electronic mail. Unable to be more specific than that and without getting specific about future products, he says he would not place those segments of the market off-limits to himself.

## General systems group

Also serving a bullish market is the General Systems Group under vp-general manager A. Keith Plant. His group, serving oem's and end users in the small systems market, is said to be growing at the same 40% to 60% rate as that marketplace. He is not allowed to be more specific than that, nor to disclose his group's percentage of the total Memorex business.

(The company, in its annual report,

users not only Memorex disc drives but also Cypher Data tape drives, Data Printer printers, and add-on memories. The group, for example, attaches 200MB disc drives to Hewlett-Packard 3000s at user sites, as well as 550-, 750-, and 1200-lpm printers.

## Memorex soon will announce a hardware/software combination referred to internally as the Super Three.

With the entree to small end users that came with the acquisition of BST, surely Memorex could add a standalone processor, right? Plant is no more specific in answering this question than was Allen. He explains that they're adding more functions to peripherals, coming close to providing the capabilities of a simple processor. "We're probably there in certain offerings now, but it's not called a system," he replies. "The whole one-stop shopping basket of products today comes together and offers everything but that processor. So that would be a simple step for us to take, but it's not a step that we plan right now."

Plant, a Canadian by birth and an engineer by education, reviews his product line. He says they're "coming on fast"

with IBM-compatible floppy discs, that they're starting to produce a two-headed floppy, and that he thinks Memorex has a leadership position in noncompatible drives.

One may recall that when IBM came to the marketplace with its floppy disc drive, Memorex was already there—but with a product noncompatible with IBM's. Shugart Assoc., a later arrival, then took the leadership position among independents in the IBM-compatible floppy market, so Memorex may well be the leading producer of noncompatible floppies.

Plant lays out three categories of hard discs. In the low range (5MB to 25MB) he has no products. In the midrange (25MB to 150MB) he has two, a single-spindle, 29MB mod 660, which is the old 2314 and very successful in his oem program. He also has a fixed-disc Winchester product with from 25 to 75MB and a second version that will take it up to 150MB. In the high range is the 677, a 200MB drive in the 3330 class, and the 657, which is a 317MB in the Winchester class. So he has all the markets covered except the low range.

"And that low range is a source of much concern to me and many other people right now," he notes. They're looking to fill that gap, he adds, "but at this point the definition is pretty fuzzy."

## Large storage

There's a third equipment product group that deserved the opportunity to deny its interest in selling a computer. The Large Storage Systems Group under Marcello Gumucio, formerly of Hewlett-Packard, is the large disc drive arm that has kept Memorex in the high ranks of the DATAMATION Top 50.

"I don't see, at the present time, that we will go and compete head-on with IBM, offering a total solution to the customer's problems," says the nattily dressed 40-year-old vice president. "But I do see an opportunity in the marketplace for what I call intelligent subsystems, back-end processors. I think it's pretty clear that more and more intelligence is going into the controllers, moving away from what we used to call the cpu."

Nor does the soft-spoken Gumucio wax ecstatic about a mass store. He says they're interested in the technology and are watching IBM's and Control Data's marketing efforts. "But at the present time I have no plans to introduce a massive launch on the 3850."

Equally evasive on the computer issue is chairman Wilson, who says he doesn't figure they're prepared to handle mainframes. "Clearly, our capabilities are such that we're probably in a better posture to do that than a lot of other people," he admits, adding: "If, at the right time, that looks like the right thing to do, then we'll do it."

As noted in these pages last month, a number of manufacturers of computers has emerged, all in the Silicon Valley



area, and Wilson acknowledges that "a lot of people" have been in to talk to them about selling computers. "That's something we would consider," he says, "but it's not fundamental to our basic information storage and communications thrust."

#### Once a mainframer

Because the company is in the midst of its antitrust litigation with IBM, Wilson is not able to say much about Memorex's earlier entry into the mainframe business. Back in 1972 the company saw two major markets for its noncompatible computers—as standalone replacements

### Memorex has a leadership in noncompatible disc drives.

for the IBM 360/20 (there was 360/20 emulation) and as remote communications processors. "I think the concept appears to have been very sound," Wilson comments. "I think the market requirement was there . . ." But, of course, the mainframe venture was to fail with a resounding thud heard around the financial community, and that failure was to contribute to the near demise of the corporation. It was a very sharp departure from the original charter of the company.

Memorex Corp. was founded in 1961 as a manufacturer of magnetic computer tape. It introduced its first product the following year, later expanding its product line to include instrumentation tape in 1963 and television video tape in '64. The company went public in 1965.

With first deliveries in 1967 of disc packs, the company continued in the recording media business but was getting into the hardware manufacturing line. This was followed by the introduction that same year of its first plug-compatible disc drive. Memorex's common stock was listed on the New York Stock Exchange in 1968, and the company chalked up sales of more than \$50 million. In 1969 when its earnings were \$6.9 million on sales of \$74 million, the company's stock hit an all-time high of \$173.

By 1971 it had shipped its 10,000th disc drive, employed some 5,700, had revenues of \$110 million, but lost almost \$13.4 million. It was in 1972 that Memorex introduced two mainframes, the Systems/40 and 50, products that were not terribly successful in the marketplace. They were phased out of the product line in the summer of '73, but not before they created an enormous financial drain on the corporation. The venture was written off for \$39 million.

A significant milestone was reached in '72 when, for the first time, the company realized more revenues from leases than from outright sales. Lease revenues increased by 71% over the previous year

and the company returned to the black with net income of \$1.2 million on revenues of \$145 million.

But the joy was to be short-lived. The next year, although revenues continued to climb to \$177 million, the company lost \$119 million. Charges against income, in addition to the abandoned mainframe business, included \$37 million for changes in accounting policy and \$20 million in asset revaluation and methods of figuring depreciation. And in the final month of the year, Memorex filed its \$3-billion antitrust suit against IBM.

#### Spitters resigned

But on April 26, 1974, board chairman and president Laurence L. Spitters resigned, the last of the four company cofounders to leave and its only chief executive officer. Spitters, only 47 years old at the time, left behind a company shackled by debts pegged at more than \$300 million, one struggling to stay in the plug-compatible peripherals business—indeed, one fighting for survival.

Perhaps the main factor going for it was the large indebtedness to one lender, the Bank of America. The nation's largest bank had the choice of closing off any more funds for Memorex, thus bringing down the House That Spitters Built and taking the largest loss in its history, or finding a way to cut its losses. It settled on Robert C. Wilson and the terms under which he would take over.

"The first priority was really to establish a situation that made it possible to build a quality company," Wilson says. "Many of the ingredients were there."

#### Networks

## Bell's ACS Network

Service will support terminals made by both AT&T and IBM

As various AT&T units struggle with the gargantuan task of whipping the firm's Advanced Communications System plan into shape for a filing with the Federal Communications Commission, more specifications on the big new digital data communications network are leaking out. And, as the outline of the planned service begins to flesh out, it is becoming evident that the Bell System may never again be the same.

Initially AT&T had hoped to announce the service at the National Computer Conference in June, but that goal slipped away as the Bell System struggled to pull together the loose ends of ACS. However, knowledgeable sources both within and without AT&T believe that a formal announcement may be imminent and feel certain that it will be announced before the end of the year.

The company was in growth markets with products that had a reputation for quality, and it had good people. "The ingredient that was not present was cash," he adds. And so before he took the job he got a restructuring of the debt. "That's really what made the whole thing doable. Having accomplished that, the first mission was one of building attitude within the company." Having the cash made it possible to go ahead with certain projects, like product development. And this, in turn, changed the employees' attitudes to one of focusing on opportunities in the future, rather than on problems of the past.

"Then, I think, we had to manage our cash very carefully." So Wilson gave the company a cash orientation, stressing thrift and conservation practices among employees and cash management among executives. To this day, one wall of vice president Keith Plant's office is covered with graphs of cash movement as seen from what seems to be a dozen perspectives.

But while rebuilding profitability, the company at the same time had to invest "in futures," as Wilson likes to say. "The first phase was the turnaround, and that took place in 1974. To me, that's just the first step. And then what I call the restoration period, restoring profit and confidence and balance sheet and momentum and so on. And then posturing for continuity for growth—that's the phase we're in at the present time."

—Edward K. Yasaki

(Note: This is the second in a series on turnarounds in the computer peripherals business.)

AT&T documents on ACS obtained by DATAMATION reveal that there will be some surprises in the service. For one thing, ACS' early service will support popular terminals manufactured by both AT&T and IBM. The AT&T-manufactured terminals to be supported include the Dataspeed models, 1, 2, 3, and 4 and Teletype models 33/35 and 43. In one category of planned service the 40/4 will be offered with bisync. The IBM terminals planned for support include the 2740-11, the 3270 with bisync and the 2780 with bisync. It is not yet clear whether the early service will support terminals manufactured by other terminal makers.

#### Supports international standard

Moreover, AT&T is committed to supporting an interface that is compatible

# news in perspective

with the CCITT's X.25 international standard as well as a new Bell System interface called "message level interface." The X.25 standard will interconnect terminals communicating with host computers. Link level will cover a full duplex, bit-oriented HDLC standard, and some additional higher level X.25 standards will be included in ACS. AT&T's message level interface will provide for the transfer of messages between ACS itself and host computers. The goal of the AT&T interface apparently is eventually to eliminate complicated host computer telecommunications access methods similar to IBM's TCAM and BTAM.

When will ACS be available to users? That appears to be the unanswerable question. Some linkups were originally scheduled for September of 1980, but the date currently bandied about AT&T is late 1982. Further complicating the timetable is the FCC, which will have to rule on ACS and the service itself is expected to draw protests from some computer manufacturers. The FCC deliberations on the issue could take several months or even a few years.

## Additional services

In addition, the Bell network will be evolutionary and additional services and offerings can be expected to be put forth

## Digital data network should be announced before year-end, with service starting in late 1982.

as the ACS plan unravels. ACS is increasingly falling under the aegis of AT&T's Long Lines division and the rumor that Long Lines will file with the FCC has prompted speculation that Archie J. McGill, a former IBM vice president who has been in charge of ACS to date, will be named to a new post at Long Lines, possibly as vice president of marketing there. McGill is currently in charge of AT&T's Market Management and Development in the business area.

A user will have three ways of connecting to ACS. He can have his own private line terminal; he can use a public terminal, more or less buying occasional service from AT&T in a service bureau manner; or he can have a "dedicated dial-in port." The latter probably would be provided by AT&T.

## Other aspects

In addition, AT&T internal documents reveal some more interesting aspects of the service. To wit:

—The National Bureau of Standards'

algorithm developed by IBM will be available for customers desiring tight data security. "A cryptographic machine," states one AT&T document, "using the NBS algorithm, will be available for use by customers who wish to encrypt data entrusted to the network."

—Initial transmission speeds appear to be in the medium range. Speeds up to 1800bps asynchronous and 9600bps synchronous will be provided in dedicated full duplex network access for some services. A host access speed of 56,000bps will also be supported.

—Customers will receive a User Billing Number, which is a ten digit number like the telephone company's regular directory listing with area codes.

—ACS customer programs will be both interactive and noninteractive. The largest program to be executed on interactive

## Financial

# Breaking It Out

## Maintenance and program product revenues shine for IBM

In recent months, IBM played its usual tricks on the industry by doing the unexpected. While observers anticipated an announcement of its E Series of low end computers and its ORBIT communications systems, IBM slipped them the 3033 multiprocessor instead. And the usual boredom with IBM's always improving annual reports changed to intense interest when the company offered financial data never disclosed before in its so-called 10-K, an annual report filed with the Securities and Exchange Commission.

It not only showed how much sales of dp equipment have increased, it also showed how much maintenance and program products now mean to IBM's revenue. And the company broke down the extent to which data processing and office products each contribute to its coffers (see Table 1).

While data processing continues to grow and provide the lion's share of IBM's revenues and operating income, its share is declining as office products gathers strength from the growth of office automation. Office products growth in 1977 of 17.8% was better than data processing, as expected.

Outright purchases for data processing systems (which includes the company's dp operations and its General Systems Div.) accounted for a major portion of IBM's revenue growth. Hardware rentals

processors is 32K bytes while the largest for noninteractive processors is 64K bytes.

—Customers will be able to prepare their own programs for use with ACS, but AT&T plans to establish "network language support centers" to assist users in preparing application programs. Special software development terminals for users will communicate with the network language support centers.

AT&T will develop application packages for use with terminals and these will have heavy message and broad spectrum communications uses. ACS appears to be aiming heavily at data entry applications, utilizing both interactive and non-interactive processor resources.

"Data records collected from different terminals," one AT&T document states, "can be individually validated, batched, and delivered as a single large message to some prespecified destination at predetermined intervals."

—W. David Gardner

and services income was growing in relatively miniscule amounts.

## Purchases up 21%

Sales of equipment in 1977 increased by about \$800 million, or 21%, to \$4.5 billion. It was up by 44% in 1976. And when compared with 1973, IBM's outright purchases have more than doubled—from \$1.87 billion to \$4.5 billion.

Meanwhile, revenue from hardware rentals and services, now at \$8.16 billion,

## IBM issued a quiet statement that it will continue to operate subsidiaries that are 100% owned by the company overseas.

increased by about a third in the last five years. But in each of the last two years, this segment grew by only 2% or less—a paltry \$175–200 million a year.

The company is doing its best to hype purchases. Besides the purchase decreases on much of the 370 equipment in 1977 and the low purchase and lease pricing it offered on the new 303X equipment, IBM has in recent months made two additional moves. It decreased the 370/148 and 138 processor prices by about 20%—even though deliveries are still at a

very high level around the world. And then, it chopped prices in many European countries, including prices on the 303X line on which it has scarcely begun deliveries. In Switzerland and Germany, 303Xs and other 370 gear, was cut in purchase price by as much as 20% to 30%. And where rental and lease prices were changed, the reductions were not as great as in purchase.

IBM noted in its 10-K report that foreign purchase revenues have lagged the U.S., but they are growing. Apparently the company intends to insure that that

field engineering division on a profit center basis. The rise in maintenance charges has reflected its attempt to keep escalating labor and training costs in perspective. (The 3033 is supposed to be a real money-maker for field engineering. One IBMer claims that it is so reliable that its maintenance men will be "as lonely as the Maytag repair man.")

In program products, IBM has such a vast portfolio that if just one of each package were licensed, revenues would be several hundred thousand dollars a month. Some analysts feel IBM has

Europe's current contribution has dropped to just over 65% of non-U.S. revenues, indicating that other areas of IBM's world are growing considerably, particularly in the Middle East, Far East, and Latin America.

Whether the growing number of nations demanding majority ownership in multinational operations and/or developing their own indigenous industries will have a material effect on IBM revenues abroad has yet to be seen. But IBM has noted in its annual report and from the podium that it is disturbed over U.S. government policies that will hamper industry's foreign operations (such as recent tax reforms), about the tariff structure of other nations, and about the potential dangers to U.S. industry of growing Japanese strength in data processing. IBM also showed its long list of 100%-owned subsidiaries abroad, a quiet statement of its strong intentions to keep them that way.

One of the more fascinating statistics in the report is the amount of money IBM has—more than \$10 billion in current assets, which includes \$251,891,000 in cold cash and \$5,154,738 in marketable securities. The latter figure actually is about \$800 million less than last year, but in 1977 IBM purchased some 3.2 million of its own shares and canceled them—at a cost of \$904 million. Currently, IBM shares outstanding at \$18.30 earnings per share are fewer than there were in 1975, when earnings were \$13.35 a share. The IBM move to buy its shares was emulated by many computer firms in the bear market of 1977.

—Angeline Pantages

### IBM'S TWO BIG MONEY-MAKERS

#### Data Processing Office Products

(Millions of Dollars)

Gross income—customers	\$14,765	\$2,824
Intersegment transfers	73	15
<b>Total</b>	<b>\$14,838</b>	<b>\$2,839</b>
Operating income	\$ 4,432	\$ 267
Percentage of total revenue 1977	81%	15.6%
Percentage of operating income 1977	87%	5.2%
Percentage of total revenue 1973	84%	not given
Increase in revenue '77 vs. '76	10.1%	17.8%
Increase in revenue '77 vs. '73	37%	not given

Table 1: Revenues from data processing include operations of Data Processing Div. and General Systems Div.

trend will continue.

#### Maintenance

Meanwhile, IBM's monthly revenues from maintenance, program products, and supplies are growing like wildfire, nearly doubling in revenue since 1973. In 1977, IBM increased its revenues from these sources by more than \$300 million over 1976, posting a \$1.45 billion total. The company actually is adding more income per year from maintenance and program products than it is from hardware rentals and services, which increased only \$200 million last year.

Maintenance revenues, which generally amount to more than 10% of the monthly rental value of the increasing number of purchased systems installed recently by IBM, has grown considerably because IBM several years ago put the

passed the half-billion dollar mark in annual program product revenues.

#### Overseas revenues

IBM also broke out its overseas revenues this year for the Europe/Middle East/Africa and Americas/Far East op-

### Outright sales to foreigners have lagged but IBM takes steps to insure it will change.

erations, rather than only reporting non-U.S. income (see Table 2). Europe, which in the early 1970s contributed up to 75% of IBM's foreign revenues, still has the lion's share. But based on information IBM gave this year, it's calculated that

### GEOGRAPHIC BREAKDOWN OF IBM REVENUES

	Europe/ Americas/ Far East		
	United States	Middle East/ Africa	Americas/ Far East
	(Millions of Dollars)		
Gross income—Customers.....	\$ 9,008	\$6,391	\$2,734
Interarea transfers.....	675	284	250
<b>Total.....</b>	<b>\$ 9,683</b>	<b>\$6,675</b>	<b>\$2,984</b>
Net earnings.....	\$ 1,503	\$ 889	\$ 344
Assets at December 31, 1977.....	\$10,007	\$6,650	\$2,593

Table 2: Europe still accounts for lion's share of IBM revenues, but it's declining as other foreign markets open up.

#### Mainframers

### The World of IBM

The magazine *Business Week* recently attempted to rank the top U.S. multinational companies according to their exports, but was turned down by the largest company in the world, General Motors, and by IBM, the largest computer company in the world. This is strange and almost unpatriotic behavior because the magazine only wanted to underscore the

**Average foreign IBM sales per employee is in the order of \$75,000 per year, almost 60% higher than in the U.S.**

generally assumed large contributions made by leading American multinationals toward reducing our horrendous trade deficits resulting from increasing imports of oil and other goods.

# news in perspective

**The Largest IBM Companies in the World**

Company	Sales in Millions of \$ U.S.	Estimated Number of Employees	Average Sales per Employee	Year of Data
IBM Corp.	18,133	310,155	\$ 58,464	1977
IBM USA	9,008	188,000	47,914	1977
IBM Deutschland	2,522	24,215	104,150	1976
IBM France	1,971	20,000 +	98,550	1977
IBM Japan	1,200	12,000	100,000	1976
IBM Canada	969	11,000	88,090	1977
IBM UK	840	13,391	62,729	1976
IBM Italia	704	8,815	79,863	1976
IBM Nederland	421	5,691	73,976	1976
IBM Sweden	331	3,524	93,927	1976
IBM Belgium	274	2,517	108,859	1977
IBM Switzerland	223	2,419	92,186	1977
IBM Spain	225	2,476	90,870	1976
IBM Australia	200	2,000 +	100,000	1977
IBM Brazil	200	1,000 +	200,000	1977
IBM South Africa	163	1,478	110,884	1976
IBM Denmark	144	1,521	94,674	1976
IBM Austria	75	1,206	62,500	1976
IBM Mexico	70	1,300	53,846	1976
IBM Norway	67	761	88,000	1976
IBM Venezuela	65	800	81,250	1976
IBM Finland	57	809	70,580	1975
IBM India	50	800	62,500	1977

SOURCE: 21st Century Research.

In the face of growing protectionist movements in Western Europe and the developing countries, proposed U.S. taxation of foreign earnings, and expanding activity of organizations such as the Centre on Transnational Corporations of the United Nations, corporate export and import dependence is becoming increasingly important to corporate profits.

In addition, IBM already has had a series of confrontations in several countries. In India it has decided to pull out rather than allow Indian participation in its marketing and production operations. In Indonesia, Iran, Brazil, Nigeria, and Malaysia, new agreements were negotiated but in most cases IBM found itself operating under more restrictive conditions than before (April, p. 181).

We've managed to rank 22 of the largest IBM subsidiaries according to their sales and employment in specific countries in which they operate. We've found that average foreign IBM sales per employee are in the order of \$75,000 per year, almost 60% higher than comparable estimates for IBM domestic operations. This, of course, is the reason for one argument that foreign governments have with IBM: they claim it does not invest sufficiently in local research and development. It also is one good reason for high profitability of IBM foreign subsidiaries, but makes them vulnerable to future harassment and the object of foreign envy.

It is interesting to note that the loss of

IBM India will be negligible and most of the markets recently in dispute do not even make it to the list of top twenty countries. Brazil is the one exception and appears to be one of IBM's most promising subsidiaries, even if much of its production is exported to other IBM markets and it is barred from selling minicomputers in Brazil. Perhaps this is why IBM

hardly made any noise at all when Brazil recently reserved its minicomputer markets exclusively for domestically controlled manufacturers.

—Bohdan O. Szuprowicz  
(Mr. Szuprowicz, founder of 21st Century Research, writes frequently for this magazine on international markets.)

## Regions

# Computers for Sale

Florida emerges as a major hub of data processing industry

Traditionally a mecca for tourists, retirees, and college students looking for a spree in the sunshine, Florida is rapidly emerging as one of the major hubs of the U.S. data processing industry.

Today, in fact, Florida serves as corporate headquarters for a dozen or more dp companies, and numerous other firms—IBM, Sperry Univac, and Honeywell among others—have established major manufacturing plants in the state.

Why Florida? One reason, of course, is the climate. Companies which relocate here like the idea they're not going to lose production time because of the kind of bad weather that brought business in much of the country to a standstill last winter. Moreover, firms generally are

able to attract dp talent at lower salaries than they'd have to pay up north. "There's an influx of highly competent people who willingly pay the price for sunshine in the form of lower wages," says Florida native Joseph Auer, president of International Computer Negotiations, Inc. in Winter Park. "But living costs are considerably less here than up north as well."

The stability that Florida affords is also appealing, corporate managers assert. "It's a binary state," notes Harold N. Morris, vice president and general manager of Harris Corp.'s Computer Systems Division in Ft. Lauderdale. "People either love it or hate it, and those that love it don't want to leave once they're here."

They're usually family people who want to get away from the IBM 'I've been moved' syndrome."

"Once people are settled down here you practically have to blast them out with dynamite to get them to change jobs," adds Auer.

#### Traced to space program

Florida's involvement with electronics and dp can be traced back to the early days of the NASA space program and some of the companies the program gave birth to—most notably Radiation, Inc. Radiation, a Melbourne, Fla. manufacturer of sophisticated space-communications components and systems, attracted a core of highly talented engineers and technicians, many of whom went on to head up other Florida-based concerns.

In fact, after Radiation was acquired in 1967 by Harris Corp., Radiation alumni went on to dominate Harris' management. Today five of Harris' seven top officers, including president Joseph A. Boyd, are Radiation grads.

Additionally, Radiation alumnus A.G. "Gus" Randolph was one of the founders of Systems Engineering Laboratories, Inc., the Plantation, Fla. firm he now heads. S. Ray Halbert founded and is chairman and president of Documation in Melbourne. And Harold Morris founded Datacraft in Ft. Lauderdale and went on to run that organization after Harris purchased it and made it the nucleus of its computer systems operation.

#### Others come

As these firms developed, other computer, data communications and peripherals concerns began popping up around



RADIATION, INC. alumni A. G. Randolph, left, and S. Ray Halbert. Randolph left company to found Systems Engineering Laboratories in Plantation, Fla. and Halbert left to form Documation in Melbourne.



JOHN STERLING OF DOCUMATION  
Selling trips to Florida

the state—Modcomp in Ft. Lauderdale, OBM Business Machines in Melbourne, Milgo (now Racal Milgo) in Miami and Paradyne in Largo. Further, Honeywell set up manufacturing operations in Tampa and St. Petersburg in the 1960s, Sperry Univac situated its defense systems plant in Clearwater a few years ago, and IBM's General Systems Div. opened up a huge Boca Raton facility that now turns out System/7, Series/1 and Serial Matrix Printers among other products.

And while a number of Florida firms experienced growing pains along the



way, business today is generally flourishing. IBM's Boca Raton operation is turning out equipment so fast GSD is expanding the plant by another 500,000 square feet. Modcomp's v.p. of finance projects the minicomputer's revenues should jump to \$65 or \$70 million this year, up from \$54 million in 1977. Moreover, Modcomp recently announced a new line, the Classic, with significant performance improvements over the Modcomp-IV, and the firm has a number of additional products, including a single board microcomputer called the 7810, in the works.

Similarly, Systems Engineering Labs under Gus Randolph has been racking up impressive financial gains. This year the 32-bit computer manufacturer should generate from \$50 to \$55 million in revenues, Randolph says, and \$5 million in pre-tax profits. Last year's equivalent figures were about \$31 million and \$1.5 million respectively.

But the expanded scope of Florida business is not limited to what shows up on the balance sheet. Traditionally many firms here, SEL among them, have restricted sales primarily to the government and scientific areas, or have sold

---

### Florida's involvement with electronics and dp can be traced back to the early days of the NASA space program and some of the companies the program gave birth to.

---

mainly to oem customers. That's changing now, however.

For example, SEL is about to move into new nongovernment, 32-bit oriented markets in the private sector. "We're not going into areas that are dominated by any one large supplier," Thompson explains. "We're not going to try to take on DEC or IBM. Nor can we compete on all fronts, supplying everything to everybody."

#### Careful shots

Instead, the firm will take carefully selected shots in the manufacturing field, for example, with automated design planning and control reporting systems among other products. It will also try to sell top management on the cost-efficiencies of SEL equipment. "Our selling methods will change," Thompson explains, noting that in the past SEL has marketed gear primarily on a technical basis. "The people we're bringing into marketing now are not from computer companies but from the industries we intend to serve."

At the same time SEL is busy upgrading its 32-bit software, software it developed nine years ago for the 8600 series and



## news in perspective

which provides an edge over some of the newer 32-bit mini offerings with software that's not fully developed, SEL believes.

One more significant development: SEL intends to introduce a low cost (under \$50,000) mini that's compatible with the rest of its line and which will enable 16-bit users to migrate up.

New products are also on tap at fast growing Documation in Melbourne. The 8½-year-old firm, which started out manufacturing vacuum-pick card handling equipment, plans to add a remote job

entry system, a card and printer remote interface called CAPRI (May, pg. 288), and a text editing system to its line.

But for now the big story at Documation is the fact that the company has moved strongly into the end user market with an array of high technology card and printer input/output subsystems and a line of impact printers that extend from a 1,000 lpm printer to IMPACT 3000, the recently introduced 3,000 lpm product that's 50% faster than IBM's fastest impact offering, the 3211.

## two totally new concepts



### concept 100

concept 100 is a fresh idea for systems users/developers who want high performance video display features plus human engineered design and low prices. Advanced concepts enable "windowing," forms control, text editing, graphics, multiple pages of memory, multiple character sets, programmable function keys, character accents, the economy of shared printing, and much more. concept 100's compact and attractive human designed display features a tilt/swivel non-glare screen, a movable fine feel keyboard, and a price of only \$1260.\*

CIRCLE 50 ON READER CARD

### concept APL

concept APL at last brings advanced microprocessor power to APL programmers and users. Full and true overstrike provides a high quality APL display without sacrificing any of the features of concept 100. At \$1400,\* concept APL is the lowest priced APL/ASCII terminal on the market. For details, call or write today.

CIRCLE 51 ON READER CARD

\*quantity of 50 price.

**HDS**  
human designed systems, inc.

3700 Market Street, Philadelphia, Pennsylvania 19104 (215) 382-5000

Today, the company, which generated \$33 million in revenues for the past fiscal year (up from \$18 million the previous year), has some 300 printers installed at 200 customer locations and another 160 printers on order, John C. Sterling, the firm's v.p. of domestic marketing, reports.

#### End user identity

To gain this kind of market Documation had to shake its old oem image. "We had no end user identity," Sterling notes. "Occasionally people would know our name, but they didn't know our capabilities. With our early customers we weren't selling printers. We were selling trips to Florida."

Even after customers left Documation with a compulsory tan and a good impression of the firm's technical talents, an additional problem remained. Users who purchased early Documation printers were often disturbed that the font size was slightly smaller than that of IBM's 1403 printer. "We got our act together and adjusted the size to make it a few mills larger than IBM," Sterling explains,

The people we're bringing into marketing now are not from computer companies but from the industries we intend to serve.

noting that psychologically the larger size worked in Documation's behalf.

With the larger font size, its high speed, and a price tag that's \$10,000 less than the 3211, Documation's IMPACT product is being used increasingly as part of high speed IBM 370/158 and 168, as well as in plug compatible, configurations, Sterling says. And Documation chairman and president S. Ray Halbert sees IBM's 303X systems as opening up an even more promising market. "IBM enhanced the capacity of its systems," Halbert says. "But it has a problem supplying the peripherals to go with them."

That's a problem that works very much in Documation's favor, Halbert believes.

#### Harris moving

Harris Corp., which is in the process of moving its corporate headquarters from Cleveland to Melbourne, is also adding new products and expanding its business in the information processing area at full tilt. Now one of the two largest industrial employers in Florida, the company is, among other enterprises, aggressively pursuing the fiber optics business and has already installed fiber optics systems in both this country and Canada. "We won't address the low end of the market," Fiber Optic Systems department director William R. Fitzgerald says. "We're interested in high technology applications."

Targeted applications for fiber optics

data link systems include intracomputer/peripheral communications, such as the test project Harris has installed at its Melbourne facility linking crt's with its computer, and the so-called "office of the future," Fitzgerald asserts.

Meanwhile, the firm's computer division in Ft. Lauderdale is, like SEL, shifting its sights more to commercial, rather than scientific, business. Toward this end, the group, which reportedly generates between \$25 and \$30 million annually (Harris does not disclose revenues of its individual business entities), has recently introduced COBOL and data base management software systems as well as a virtual memory multiuser operating system.

Moreover, the division is "totally committed to distributed processing," v.p. Harold Morris says, and has positioned its high-number-crunching, interactive

Series 100 systems to run off Harris 1600 Series terminals in a distributed environment.

At the same time Morris notes his group will make a bigger play for end user customers, which today constitute about 20% of the division's business, and will introduce a 48-bit (Harris currently utilizes 24-bit architecture) supermini that will have horsepower and memory capacity comparable to that of DEC's VAX 11/780.

"We're gaining increasing recognition that we're a viable alternative to Digital and Hewlett-Packard," Morris says of the competitive company he intends the computer group to keep. And with the resources of Harris Corp. behind it, the group may eventually have the big mini vendors looking over their shoulders.

—Laton McCartney

ing his former job to his new one, he reflects on "the difference between watching a bull fight and being in the ring."

Now in the center of that "ring," Carr as ADTS leader carries the same mandate as his predecessors. And it's this mandate, legislated into law 13 years ago as the Brooks Act, that the zealous Carr vows he is committed to following. Under this landmark law, GSA was given primary operational responsibility for coordinating a government-wide adp management system.

It's no secret that over the years this awesome responsibility hasn't always been carried out the way the framers of that enabling legislation had originally intended. "You look at what GSA has done," Carr declares. "They haven't really defined what that system is. They haven't coordinated it and they haven't managed it. We, in fact, have focused on procurement."

This heavy emphasis on procurement has been a constant complaint of many federal computer followers. Carr wants to change this. "One of the first things we want to do," he says, "is to try and move upstream from the actual procurement activity . . . (but) not with the idea," he stresses, of imposing "regulations to specify how agencies will do system planning . . . I don't think that makes any sense."

"But," he continues, "I think we ought to be involved early enough so that we can suggest what the problems are further downstream if (an agency) does get the procurement. We may be able to offer alternatives to what the agency is trying to do . . . I think there are things we can do in looking at the total acquisition program for the federal government over a longer stretch of time."

Trying to be more specific on how to achieve this early-on involvement goal, Carr says he will implement this type of effort "on an agency by agency basis as the opportunity presents itself." He said he is pulling for the agency's "computer executives" (as opposed to the agency computer managers) to recognize the need for early liaisons with GSA. And once aware of this need, he's hoping that they will take the appropriate initiative to set up such a scheme. "It's going to take time," he concedes, "but I'd rather have a small amount of success in a half dozen agencies than have a program that isn't successful in any of them."

#### Central authority

Carr, who admits that he hasn't "been able to spend as much time with the agencies as I thought I would," has nonetheless been mulling over ways to get agencies back into the adp management loop. This has also been a hot topic for the Congressional computer watchdogs on Texas Congressman Jack Brooks' Government Operations Committee, which is holding another round of over-

## Government

# GSA's Frank Carr

Agency's dp chief advocates more use of adp technology

"Today in the federal government we do not have a group or organization that is playing an advocacy role. There's no one," insists Frank Carr, head of the General Services Administration's Automated Data & Telecommunications Service, "that really comes out, for example, and says the federal government should make more use of adp and communications technology."

No one indeed has filled this advocacy void—no one until now, for that's exactly the role the 52-year-old commissioner sees his ADTS team taking on.

"There are things (in computers and communications)," the former Westinghouse Electric Corp. executive declares, "that the federal government ought to be doing that we're simply not doing." For example, "a larger percentage of the budget ought to go into technology," he points out, "because the benefits we get will be offsetting in terms of allowing us to decrease costs or increase effectiveness of the services delivered."

On the job for 11 months, Carr, who is a sailing enthusiast, has spent much of his time brainstorming ways to bring his methodical management mentality to bear on problems plaguing federal adp and telecommunications users. Serving as a sounding board for a varied and often conflicting constituency, which includes the vocal Congressional, agency, and vendor communities, Carr has listened attentively to all the often repeated gripes and suggestions on what GSA should or should not be doing. He now has his own ideas on what some of those responsibilities should be.

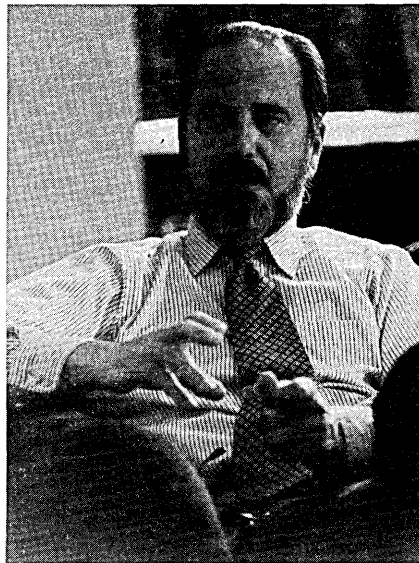

PHOTOS BY NEMO NIEMANN

**"I'm still learning, still planning and the implementation presumably will go on forever."**

#### Still learning

"I'm still learning, still planning, and the implementation presumably will go on forever," he explains. While some aspects of his job "were very familiar" to him since his 25 years of work at Westinghouse involved him in dp and communications as well as government-related tasks, he still candidly admits he had some catch-up learning to do. Compar-

# The Raytheon Checklist.

## A distributed processing user's best friend.

The term distributed processing is new enough that many people, both users and manufacturers, mean many different things when they talk about it.

Rather than try to add another definition to the many now existing, Raytheon Data Systems has prepared this comparative

checklist of the major functions that might normally be considered attributes of any distributed processing system. Regardless of the distributed processing system you eventually select, there are a number of capabilities

you will want that system to possess. Obviously, the more features the system has, the greater its capacity to do all

the work you have planned now—or might need tomorrow.

Our checklist itemizes many of the most important features you should consider. They are not the only features, but we think they are the most important.

And—to make the point that Raytheon's PTS/1200 MARK-I and MARK-II systems are extraordinarily powerful distributed processing systems—we've taken the liberty of itemizing their capabilities in each of the columns shown. Do that with other vendors' equipment, and we think you'll choose Raytheon.

**Then check prices. The MARK-I is lowest.**

After you've looked at the variety of products on the market, you'll also want to see what each costs.

We can tell you about Raytheon's pricing. The PTS/1200 MARK-I is the lowest. By low, we mean up to 30 per cent below the most popular alternative models. The PTS/1200 MARK-II costs a little more, but is more than twice as powerful as the MARK-I. You won't be able to compare its cost directly with other equipment, because no other equipment can come close to matching its performance.

Solving the installation and productivity problems that these users encounter takes patience, skill and the commitment of an experienced vendor. It takes going beyond a standard product, and finding customized solutions, and often products, to meet a user's requirement.

Most of all, it takes doing it. Over and over and over again. Raytheon has done it over and over and over again.

**Fast, easy installation and growth is vital.**

Not shown in the checklist is another vital aspect of distributed processing systems—immediacy of installation and ease of expansion. The Raytheon PTS/1200 MARK-I can be installed in less than a day, with no change to host hardware, or systems or applications software. You become productive right away. And when you want to grow, you simply add capacity—within a single system, or by adding additional systems or devices. Every PTS/1200 is compatible with every other—and with your host mainframe system and protocols in almost every case.

**Look hard at experience too.**

Beyond the hardware, the price and the easy compatibility, there is the experience factor. The vendor with experience can save the user without it a lot of grief.

Raytheon is the world's largest non-mainframe supplier of intelligent terminals and distributed processing systems. Some of our customers use more than 2,000 Raytheon terminals in data networks located at more than 300 locations either domestically or around the world. Many others have one or several PTS/1200 distributed processing systems at work in remote locations, linked on-line to a central mainframe.

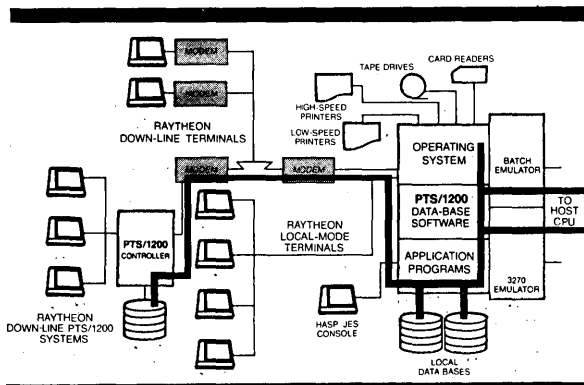

Shown above is a typical schematic of a PTS/1200 distributed processing system with a hierarchy of local data bases, multiple terminals in multiple applications, all linked by one or more protocols to a central mainframe.



A typical four-station MARK-I system with a 64K-byte controller, 10 MB disk, and one 165cps printer leases for \$850 per month, including all software and maintenance.

# The 54-Point Checklist

Feature	Typical Configuration	Importance of Feature	Product Capabilities			
			PTS/1200	Brand X	Brand Y	Brand Z
<b>INTELLIGENCE</b>	<ul style="list-style-type: none"> <li>Dependent totally on host processor</li> <li>Stand-alone (non-shareable) intelligence in each station</li> <li>Small-cluster (shared by 1-8 stations)</li> <li>Large-cluster (shared by 1-24 or more stations)</li> </ul>	Intelligence is based upon the amount of available program-mable memory a system possesses. Its purpose is to facilitate local application development and execution. The larger the available memory, the better the applications freedom.	N/A All resources shareable by all stations 64K to 128K bytes 64K to 128K bytes			
<b>CONTROLLER</b>	<ul style="list-style-type: none"> <li>Word size</li> <li>Number of operator stations per controller</li> <li>Number of peripheral attachments per controller</li> <li>Availability of high level languages</li> <li>Ability to perform multi-tasking</li> </ul>	The controller is the central processor of a distributed system. Its power in terms of word size, attachment capacities, programmability and ability to perform multiple tasks concurrently is the key limiting factor in its ultimate performance.	16-bit 1-8 stations, or 1-24 stations 1-4 peripherals, or 1-20 peripherals Yes: MACROL; COBOL in the future Yes Up to 32 tasks concurrently on one controller			
<b>TERMINALS</b>	<ul style="list-style-type: none"> <li>Variety of screen sizes</li> <li>Variety of keyboard options</li> <li>Availability of user-definable function keys</li> <li>Ability to provide operator prompting</li> <li>Ability to attach remote terminals on phone line</li> </ul>	The terminal is the point of operator interface and should be capable of being comfortable to use, easy to use, and easily matched to one or many different applications through customizing.	960 or 1920 3270 type-writer, data entry 16 program function keys; plus any key programmable Yes: by screen, audio and light indicators Yes			
<b>PERIPHERAL ATTACHMENTS</b>	<ul style="list-style-type: none"> <li>Number of attachments per controller</li> <li>Low-speed printer devices</li> <li>High-speed printer devices</li> <li>Card reading devices</li> <li>Magnetic tape transports</li> <li>Printer's word processing quality</li> </ul>	The ability to attach a variety of peripheral equipment of various speeds and capacities is a measure of the range of work a system can do.	1-4, or 1-20, any combination 45-165 CPS 3 models 300 LPM and 600 LPM 300 CPM 800 and 1600 BPI Yes			
<b>COMMUNICATIONS PROTOCOLS</b>	<ul style="list-style-type: none"> <li>Asynchronous</li> <li>Synchronous</li> <li>Binary Synchronous — Batch</li> <li>— Interactive</li> <li>Synchronous Data Link Control (SDLC)</li> </ul>	The ability to support more than one protocol — at the same time on the same system — adds immeasurably to the number of tasks and number of networks a system can work in without additional user development effort.	Yes: TTY RS-232 Yes Yes Yes: in 1979			
<b>INTELLIGENT 3270 OPERATIONS</b>	<ul style="list-style-type: none"> <li>Local format storage</li> <li>Local printing</li> <li>Ability to access and update local data bases</li> <li>Transactions stored locally, batched for transmission to host</li> <li>Field verification at each terminal location</li> <li>Application program decides when to go to host</li> </ul>	This feature assures that the system can work immediately and easily with the most popular terminal devices in use today, and extend the performance of those devices in a variety of ways.	Yes Yes Yes Yes Yes			
<b>EMULATION CAPABILITIES</b>	<ul style="list-style-type: none"> <li>3270 interactive (dumb)</li> <li>3270 interactive (intelligent)</li> <li>2780 batch</li> <li>3780 batch</li> <li>SDLC batch/interactive</li> <li>HASP remote job entry</li> <li>Non-IBM protocols</li> <li>Specialized protocols</li> </ul>	Emulators are software tools that permit a system to operate as a look-alike under other vendors protocols and procedures. Their advantage is to permit direct and immediate attachment to networks using a specific device protocol.	Yes Yes Yes Yes Yes: in 1979 Yes Yes Yes			
<b>DATA BASE STORAGE</b>	<ul style="list-style-type: none"> <li>Multiple disk storage capacities</li> <li>Memory management software</li> <li>Ability to expand to very large local storage</li> </ul>	Local data base storage under sound memory management techniques assures powerful local filing, easy off-loading of large central files and elimination of unnecessary communications to and from host.	Yes: from 10 to 320MB Yes Yes: to 320 MB per system			
<b>SOFTWARE LANGUAGE</b>	<ul style="list-style-type: none"> <li>Assembly language</li> <li>Strong macro command repertoire</li> <li>High-level compiler language(s)</li> <li>Easy-to-learn and use</li> <li>Numerous screen manipulation and interactive programming aids</li> <li>Parameter-driven aids where required</li> </ul>	Language is the facility that makes it possible to tap the power of the basic system by allowing applications to be written easily. Simple but rich high-level language that can be learned easily by programmers or used by non-programmers extend a system's reach that much further.	Yes: not needed by user personnel Yes: 150 instructions MACROL now; COBOL in 1979 Yes Yes Yes: for format creation and source data entry			
<b>NETWORK ENHANCEMENTS</b>	<ul style="list-style-type: none"> <li>Concurrent communications operation</li> <li>Downline control of multipoint networks</li> <li>Remote program development support for mainframe in any language</li> <li>Teleprinter network on terminal lines</li> <li>Downline program debugging</li> <li>Downline terminal loading</li> <li>High-speed data transmission rates</li> </ul>		Yes: batch and interactive at same time Yes: up to 10 drops per controller Yes Yes: on same lines at same time Yes Yes To 9600 BPS			

## Raytheon—50,000+ terminals in use now.

When you select Raytheon, you are selecting a total single-source supplier who has installed more than 50,000 intelligent terminals. A supplier with a worldwide field maintenance organization that is linked together by its own distributed processing network that keeps track of every equipment outage for every customer. A supplier that does not need to offer third-party leasing, because it maintains its own self-financed leasing company. And a supplier whose customer list includes a very high percentage of the world's largest industrial, commercial, financial, insurance and government data systems users. Raytheon. The company to pick when you've completed your distributed processing checklist.

Tell me more about the Raytheon PTS/1200 distributed processing family:

- MARK-I  
 MARK-II

Tell me more about some of the features shown on The Checklist. I'm especially interested in:

- \_\_\_\_\_
- \_\_\_\_\_
- \_\_\_\_\_
- \_\_\_\_\_

- Have a salesman call.  
 Send me more information.

Name: \_\_\_\_\_

Title: \_\_\_\_\_

Company: \_\_\_\_\_

Street: \_\_\_\_\_

City: \_\_\_\_\_

State: \_\_\_\_\_ ZIP: \_\_\_\_\_

Intelligent Terminals, Minicomputers, Distributed and Word Processing Systems

## RAYTHEON DATA SYSTEMS

1415 BOSTON-PROVIDENCE TURNPIKE • NORWOOD, MASSACHUSETTS 02062

Call Director, Field Marketing, at (800) 225-9874 (toll free)

Inside Massachusetts call (617) 762-6700 • TWX: 710 336-0646 • TELEX: 92-4408

ATLANTA (404) 321-3064 • BOSTON (617) 237-4190 • CHICAGO (312) 694-4420 • DALLAS (214) 661-9722 • DENVER (303) 371-0990 • DETROIT (313) 358-3990 • GREENSBORO (919) 294-5811 • HARTFORD (203) 289-8281 • HOUSTON (713) 771-5851 • KANSAS CITY (816) 561-9333 • LOS ANGELES (714) 979-5800 • MIAMI (305) 592-3884 • MINNEAPOLIS (612) 854-2666 • NEW YORK CITY (212) 661-2790 and (212) 895-2667 • PHILADELPHIA (609) 665-8466 • PITTSBURGH (412) 281-2117 • SAN FRANCISCO (415) 692-4640 • SEATTLE (206) 453-0650 • TULSA (918) 663-7852 • WASHINGTON, D.C. (703) 979-6100 • OVERSEAS: AMSTERDAM (020-93-0787) • FRANKFURT (49-6196-48829) • AUSTRALIA (61-2-297721)

# news in perspective

sight hearings, possibly this month. Some of the President's Reorganization Project (PRP) reports on adp are also zeroing in on the need for beefed-up computer management muscle through greater centralization of authority at the department level.

This new plan to bolster agency adp management might scare some federal computer managers who feel such a move would kill any initiative for better management in subordinate agencies. Carr, who thinks the basic concept "is a good one," believes these fears are justified "if the central adp group begins to exercise its muscle in an unintelligent way and if it isn't capable." But he quickly adds that it's "really more of a question of how it's implemented as opposed to the concept, which I think is basically good."

His reasoning: "The stronger central adp organization you can have in an agency, the less need there is for strength in some other central organization. There's less need for ADTS—GSA—to exercise muscle. If the central agency group does its job, it will make GSA's job easier and we should . . . get into fewer conflicts as a result."

GSA, under this setup, should also get that early-on agency involvement that's so much a part of Carr's "upstream" approach. With this type of framework, Carr foresees ADTS "working out basic ground rules and deciding (with the agency groups) how to deal with specific kinds of cases. 'They're the ones,' he reasons, 'that . . . would anticipate the kinds of problems that maybe we (GSA) ought to be brought in on.'" Such an arrangement, he maintains, "shouldn't cut off communications between GSA and the subordinate agencies." He also notes that the setup could be flexible—in other words, every agency group would not have to be organized the same way.

## Advocacy role

As part of the new advocacy role being taken on by GSA, Carr sees more involvement with smaller agencies. There are approximately 60 agencies in this category; each with an employee workforce of around 2,000. Often these agencies, hamstrung by meager staffs, simply don't know how to take advantage of adp. And that's where GSA can help, according to Carr. One way for GSA to offer this kind of help is through a small agency technical assistance program which the ADTS chief confirms "is a good idea."

He's also worked out a plan to pull together some ADTS activities that formerly were separated. A main overriding goal has been to couple adp and telecommunications procurement activities. And as part of a small reorganization last

January, various other changes were made including moving the standards group closer to procurement and slotting the agency services division under procurement. The telecommunications office was restructured to include a voice communications systems division and a data communications systems division.

## Compliance

Carr says that as part of the new closer coupling of procurement and standards activities in ADTS, all agency request for proposals (RFP) will be reviewed to see whether an agency has in fact complied with standards requirements. This hasn't been done in the past, he explains, because ADTS' small standards group was spending most of its time in standards development, a job that clearly belongs to the National Bureau of Standards.

Certain standards follow-through would also ease the crunch of software conversion—a chore that most federal dper's tenaciously resist even when under

Infonet Div., the TSP multiple-award schedule contracts (of which there are 34 to date) operate like computer-hardware schedule awards, enabling agencies to order services (batch, time-sharing and data-base processing) from the schedules rather than having to make separate procurements.

Carr says the TSP program is going well. "Everything I hear from vendors and agencies indicates considerable satisfaction with it," he affirms. Designed to trim excessive bureaucratic red tape, the program, according to the ADTS chief, has been received "favorably" because it gives "the agencies an easier way of getting to the market. And since it's aggregating the demand for the market, it's also easier for the vendors to organize to get to the federal market," he contends.

While GSA has been encouraging agencies to wean themselves away from the Computer Sciences' Infonet services, the procurement authority itself has had its own problems in making the breakoff. So much so that it was compelled to sole-source a contract with CSC which, if stretched out for the full four year length of time, could net the company \$40 mil-

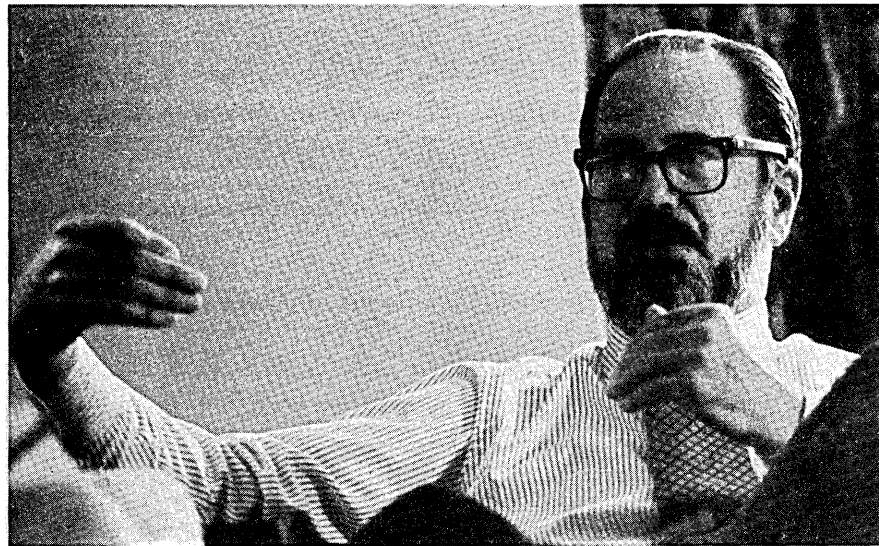

**"The stronger central adp organization you can have in an agency, the less need there is for strength in some other central organization."**

the gun to implement a system switch. Carr declares that he is "disturbed" by the way conversion is being handled in the federal government. "We tackle it (conversion) on a case by case basis," he complains. "We're applying certain rules which viewed one way make sense and viewed another way make no sense at all."

Converting to another system is a problem that ADTS has become increasingly aware of since its implementation of the Teleprocessing Services Program in August 1976. Replacing GSA's former contract with Computer Sciences Corp.'s

lion. (Ironically, that's almost the same amount of money the company pulled in during the approximately four years its earlier government-wide contract was in effect.)

## Carr defends action

Troubleshooters on Capitol Hill have launched a preliminary probe into the deal, which they feel besmirches GSA's holier-than-thou image. Carr defends the action, explaining that "it was necessary to maintain continuity of operations." He also adds that the agency is not "necessarily going to go out the full



length of time (under the CSC contract)."

Carr is equally pragmatic about GSA's past failures, which he maintains are not really failures but "rather a lack of endeavor in the areas that I think we ought to be engaged in." In addition to the misplaced procurement focus, he feels that the agency has not questioned to the fullest extent possible agencies' requirements determinations.

Carr cites "resource constraints" as one of the reasons GSA hasn't been able to do the job it should be doing. A case in point—GSA's resources over the past 10 years or more have increased only about 10% and there are no significant boosts in the FY 1979 ADTS budget which was hammered out before Carr really came on board.

Carr thinks GSA's past budget methodology has been faulty. "Here we are," he retorts, "operating a machine that's creaking along. It needs structural repairs. It's not producing at anywhere near the level it ought to be producing at, and we're trying to fine tune it. It's entirely the wrong way to go."

A better way, according to Carr, is not to do what's been the tendency all along—asking "for small increases to add a few people here and a few people there." Instead the ADTS leader has pro-

posed "a different approach" which will be reflected in the FY budget requests for 1980-1982 that currently are being worked on. In those budgets, he confirms, "we'll be going out after bigger chunks of resources against specific major objectives . . ." While Carr is committed to this approach, he is reluctant to pinpoint exactly which programs will be benefitting from those "bigger chunks of resources" since all the details have yet to be finalized.

And while GSA is trying to get its act together, the agencies themselves have a little work of their own to do in shaping up their internal procurement procedures, which often spawn excessive delays and conflicts with GSA regulations. Carr readily concedes this trouble spot and points out that while GSA can try to make it easier for agencies to procure gear and services, the agencies still must battle their own sometimes overly rigid rules.

The agencies as well as the vendors have been clamoring in recent years for GSA to make minicomputer purchases easier. Most of that problem will be solved with the raising of the blanket delegation of procurement authority (see box) from \$50,000 to \$300,000. As a result, agencies will be able to go out

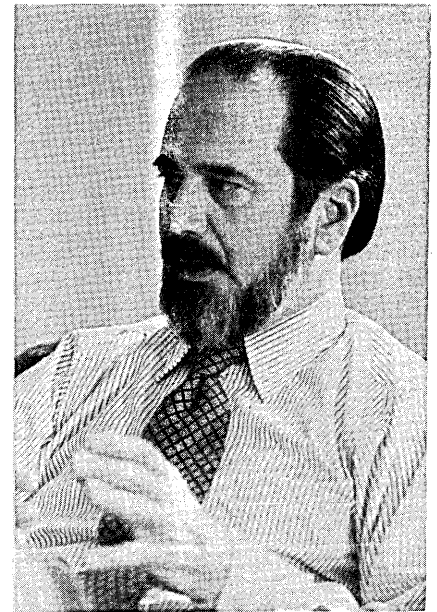

**"I think someone in the federal government ought to be concerning themselves with the variety of minicomputers we are putting in."**

## Carr Answers Three Charges Against GSA

During the summer of 1976, Texas Congressman Jack Brooks' Government Operations Committee held oversight hearings to determine exactly how closely the Brooks Act (Public Law 89-306) was being followed. Passed in the fall of 1965, the act sets up a rigorous federal adp program, with responsibilities being channeled to the central management agencies which chiefly consist of the Office of Management & Budget (formerly known as the Bureau of the Budget), the General Services Administration and the National Bureau of Standards.

The finger-pointing follow-up report, detailing the failings of each of these adp authorities, comes down particularly hard on GSA. In light of the upcoming Congressional hearings, Frank Carr, commissioner of GSA's ADTS operation, was asked to comment against the agency in the two-year-old report.

**"GSA has repeatedly authorized noncompetitive procurements which were not adequately justified."**

**CARR'S RESPONSE:** "It's hard for me to put myself back at that time to be able to say whether or not that was a justified charge. And it's even difficult for me to counter the charge today because I can't say that I'm aware of all

those cases where we have delegated authority for sole source procurements. But I would say that there are an awful lot of sole source procurements that tend to get justified on the basis of the need of the agency to stay in business. It's a set of circumstances that dictates the sole source procurement, but that doesn't necessarily mean that the sole source procurement is justified on its merits. If the agency had in fact planned things differently at some prior point in time, then at that particular point in time, they could have gone competitive . . . You cannot justify all the sole source procurements on their own merits, but you in effect must give them (the agencies) the authority to proceed because you can't stop the operation dead in its tracks.

**"GSA has not provided adequate management guidance to user agencies."**

**CARR'S RESPONSE:** "I think that's true . . . but that doesn't mean we haven't provided any. It's whether or not it's adequate. I don't think it's adequate. We have to try to get more resources to do the job we ought to be doing. I'm not simply saying I want more resources. I'm not taking that criticism as being a sufficient basis in itself for more resources. But (I'm) trying to get the story across to those who make the resource allocation decision as to why we ought to get more and why it ought to be GSA that's getting it rather

than somebody else. For example, I don't think GSA should be getting more resources in order to do a job that an agency can do for itself . . . What we ought to be looking for are those opportunities where we can do something that agencies cannot do individually—that we can act for them as their agent—to treat them in a collective fashion. Those are the kinds of things that we ought to be identifying and those are the ones that we ought to be getting resources for."

**"GSA has failed to enforce regulations and restrictions in adp procurement authority delegated (to) user agencies."**

**CARR'S RESPONSE:** "I think that is true. There are two aspects to that. One is in the standards area. We have not enforced the standards. Within ADTS, the small standards group that we had was spending most of its time in standards development which is NBS' responsibility. And one of the changes we've made is we've taken that group and moved it into the procurement shop where their efforts are being redirected toward standards enforcement. The second part of that is that we have a hard time trying to keep up with the agency procurement requests that come in and deal with the delegations. We simply don't have the manpower to do the kind of follow-up on the delegations. The charge is correct and it's true today." \*

# Announcing

Hazeltine proudly announces our newest and lowest-price addition to the Leadership Line of Economy Terminals, a worthy companion to the famous Hazeltine 1500 Series.

- It takes a major High-Technology Company like Hazeltine to:
  - Effectively apply advanced microprocessor technology to achieve the 1400's Ultra-High Reliability.
  - Implement unrelenting QA/production procedures to achieve the 1400's Ultra-High Quality.
  - Design and build a terminal that delivers More Performance Per Dollar than any other TTY-compatible terminal now on the market.
  - Meet the growing needs of the video terminal markets—OEM, End-User and Personal Computing.



# NOW

# Hazeltine 14000

## Available



**Hazeltine Corporation, Computer Terminal Equipment, Greenlawn, N.Y. 11740 (516) 549-8800 Telex 96-1435**

EAST: N.Y. (212) 586-1970    CENTRAL: Chicago (312) 986-1414    SOUTH: Atlanta (404) 952-8444    WEST: Burlingame (S.F.) (415) 342-6070  
ENGLAND: Hazeltine Ltd. 01-948-3111 Telex (851)-928572    GERMANY: Hazeltine GmbH 0611-590748 Telex (841)-416924  
FOR WORLDWIDE SALES INFORMATION CALL: (516) 549-8800

on a mini buy without GSA having to be middleman.

## Qualms over minis

Carr believes this is "the right way to go," but he also admits to qualms over "the aggregate impact of minicomputers." He explains why: "I think that someone in the federal government ought to be concerning themselves with the variety of minicomputers we are putting in; also with how we go about training people to use them and how these systems are being designed, their languages and documentation and so on." What GSA should do, he says, is "make it easier for people to procure (mini's), but at the same time, we ought to be doing something to channel the way in which they are utilized."

This note of caution is characteristic of Carr. And it's this cautionary attitude which tends to belie his essentially optimistic nature. Indeed, he seems to exude optimism when talking about his job and the things he hopes to accomplish. "I was optimistic when I came on board," he declares, "and I'm still optimistic. I came on board and said I was going to stay here longer than any prior commis-

sioner, which is 22 months."

Traveling for nearly an hour every day to get to his job from his home in the sailing city of Annapolis, Md., Carr spends up to 12 hours each day in the office. He candidly concedes of course that he'd "rather be sailing" and even that he has "my good days and my bad days." But still the optimism is there.

What's been "valuable" to him is the input he's gotten from the government and private sector dp community. He recognizes the inherent conflicts among all these interested parties and doesn't pretend he can satisfy all of them. "First of all you recognize the fact that you're not Einstein. So you don't try to solve all the problems. What you do is try to establish some kind of framework within which those problems can be handled."

As an illustration of one of GSA's stickier and more significant problems, Carr cites the "frictions" that have sprung up over the years between GSA and the office of Management & Budget, another key adp player. And once again, he gets back to the importance of targeting a role.

"I think the big problem," he reflects, "has been identifying (GSA-ADTS) role . . . If we play an advocacy role, identify-

Although ADTS commissioner Frank Carr concedes that GSA has limited itself, particularly in . . . focusing on procurement as opposed to the entire acquisition process," he also recognizes there are certain procurement issues which need prompt attention. Some of these pressing procurement issues are scheduled to be resolved by the beginning of next month (his one year anniversary) or by year end. The following is a brief compilation of the procurement-related action items on the commissioner's agenda.

## Delegation of Procurement Authority (DPA)

Dollar thresholds will be upped from \$50,000 to \$300,000, the amounts varying according to the type of procurement method used. It will only be applicable to off-schedule or competitive procurements with advertisement required in the *Commerce Business Daily*. Implementation target—July.

## Agency Certification Program

Referred to by government revampers as the "earned autonomy" concept, the program would grant certain worthy agencies the right to handle their own procurements without GSA involvement. Under this setup, GSA

# Remote Job En Information wa

Your total RJE processing solution supported by a practical no-risk financial arrangement.

**Reliability.** RJE systems can be configured to satisfy a variety of processing requirements—simple or complex—encompassing the full range of RJE peripheral devices. DPF systems can communicate not only with IBM, but with UNIVAC, CDC and others as well.

**Capability.** DPF has assembled and integrated field-proven processors and components within a single product family. These devices have been performing successfully for many years and have earned a reputation for reliability and ease of operation.

**Flexibility.** You won't be stuck with today's system if it doesn't solve your needs tomorrow. DPF will structure a lease that affords you the opportunity to change configurations as required, and stay within your budget constraints.

**Price-Performance.** You will be given an opportunity to select the peripheral devices which best service your processing requirements and budget.

- Printers—up to 1500 lpm.
- Card Readers—up to 1000 cpm.
- Tape Drives—800 or 1600 bpl.
- Other Peripherals Available.

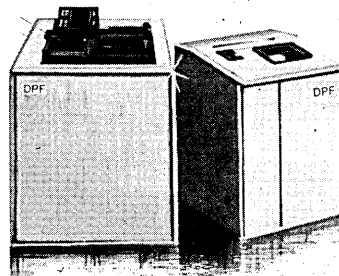

## Procurement Action Items

would initially work with individual agencies, scrutinizing closely their past procurement track records and policies before letting them loose on their own. Carr explains that these good behavior agencies would be given a blanket delegation to make their own procurement decisions which would be reviewed by GSA on a yearly basis.

### Classification

Since most dp hardware comes under separate GSA schedule contracts which operate under strict sanctions against sole source orders, some savvy suppliers have started to move their wares off the ADTS schedules and onto the looser Federal Supply System (FSS) schedules where they feel they can get orders easier and where they don't have to compete under a request for proposals (RFP) as frequently. Carr reports that he is working with FSS commissioner Robert Graham to resolve the classification problem by first going through the various schedules and identifying those for adp. In the second step, a decision will be made, he says, on how those times will be procured. Implementation target—July.

### Federal Management Circular (FMC) 74-5

This GSA procurement regulation

spells out, and not too clearly either, what agencies must do in order to justify a buy before they can go out with a procurement. The regulation, which one federal dper carps "could have been written in ancient Greek," will be revised, as will the Federal Procurement Regulations (FPR) and the Federal Property Management Regulations (FPMR). Implementation target-year-end.

### Agency Annual Plan Submissions (FPMR 101-32.15)

This requirement forced agencies to turn over every year to the Office of Management & Budget their upcoming adp plans. Agency adpers complain that the requirement was "garbage" as one government insider put it. "All anybody did was pull out whatever they had in their files on major projects." The reg was suspended by GSA at OMB's request but is now up for reactivation through the budget office "but not in the same form," adds Carr. GSA will get this agency planning data through OMB and it will be tied into the multiyear budget cycle. \*

ing that as being the specific role we're going to play, then that starts to define what some of those relationships ought to be, indicating that we ought to act in a way that represents the collective interests of agencies as opposed to second guessing individual agencies.

"We have not been an advocate. And I don't think we (GSA) have understood our role and I don't think OMB has understood what our role has been. But I do think it's possible," he declares confidently, "to get this . . . understood and start to work together."

—Linda Flato

## Software Taxes

### Unimpressed in California

"What are we taxing here? I don't have a good understanding."

George E. Reilly, a member of California's State Board of Equalization, may have gone right to the heart of the problem with this statement made during the opening moments last month of a board hearing on Rule 1502 covering "Automatic Data Processing Services and Equipment."

The board has been imposing sales and use taxes on software and some

When you need it.  
Immediately.

**The DPF Approach.** Tomorrow you may need a larger, more sophisticated system, a system with the ability to go beyond RJE requirements. Our years of total processing experience has enabled DPF to develop a leasing policy to give a data processing professional the hardware and financial flexibility needed to keep up with increasing demands. This total combination of technical and fiscal expertise offers the only single-source solution—with IBM and IBM compatible hardware and software capability—to the problem of trying to select from the multitudes of system approaches on the market today.

DPF, a Fortune 500 company, is the largest independent computer leasing company in the country with a computer portfolio in excess of \$450 million, at original cost.

**dpf**  
INCORPORATED

I'm interested in hearing more about the DPF approach to RJE.

- Please have your representative contact me.  
 Please send me a brochure and more information.

Name \_\_\_\_\_

Title \_\_\_\_\_

Phone Number/Ext. \_\_\_\_\_

Company \_\_\_\_\_

Address \_\_\_\_\_

City \_\_\_\_\_ State/Zip \_\_\_\_\_

For immediate information call: (914) 428-5000, or send coupon to:

RJE  
DPF Incorporated  
141 Central Park Ave., S.  
Hartsdale, New York 10530



# Over 43 million records are now under new management.



**System 200™**  
by A.B. Dick/Scott is bringing efficient, cost-effective information management to massive volumes of government, banking, law enforcement, insurance and personnel records.

The record speaks for itself. As a highly flexible and completely updatable micrographic record processing system, System 200 has rolled up an

The durability and quality of System 200 File Film images and a built-in audit trail help assure file integrity.

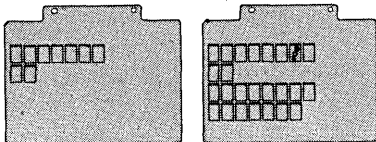

A single piece of 4" x 6" File Film accommodates 60 legal size or 98 letter-size documents. Images can be recorded or updated in just seconds.

File Film has an add-on capability and can be updated. Prior recorded documents can be readily annotated for record control purposes.

impressive string of application success stories.

The key to its growing reputation and enthusiastic acceptance among administrative and record processing personnel is the overall accuracy, immediacy, durability, and completeness of information that can be stored on System 200 File Film.

The following on-the-job profiles demonstrate the flexibility of System 200 and its capacity to meet a wide range of record management requirements.

## Rapid updating and confidentiality ideal for Colorado police records.

When the Colorado Springs, Colorado, police department looked for ways to replace its outmoded paper arrest and identification files, System 200 joined the force.



File Film containing some 40,000 criminal records has been structured to provide a complete unit record containing everything from fingerprints and mug shots to written court depositions.

Lt. Ernest Adams, the department records manager, recently noted that System 200

"provides better access and distribution of file information for those who have a legitimate right to the information and better control against intrusion from those who do not."

## A tactical weapon in the U.S. Army's war on paperwork.

With over 785,000 individual files containing 52 million document pages, the daily battle to maintain U.S. Army service records was a formidable task.



Each day, about 1000 records must be created or retired, 30,000 new pages added to existing files, and 2500 user requests fulfilled.

By linking System 200 with a minicomputer and automated retrieval techniques, the Army Personnel Center has dramatically reduced response and retrieval time while tightening file control and integrity. The System is expected to do away with a paper mass that once occupied 4700 filing cabinets and 35,000 square feet of floor space. It also will reduce operating costs significantly.

## System 200 speeds service on insurance claims.

Claim examiners at the Guardian Life Insurance Company of America find that System 200 not only saves valuable file search and retrieval time but enables them to offer their policyholders prompt, efficient service on health insurance claims.

Each examiner keeps duplicates of the company's master File Film of over 350,000 documents in a small tray on his desktop. This provides instant access to each policyholder's complete, fully updated claim file



and enables examiners to respond quickly and efficiently to all incoming mail or telephone inquiries.

A Guardian vice president notes that "While space and labor savings alone justified the cost of the system, it was the advantage of near-instant file accessibility for servicing our policyholders that confirmed our decision."

## Helping Citibank manage 22,000 personnel records.



Faced with the dual problem of maintaining cost-effective control and tight security over the personnel records of 22,000 employees, Citibank of New York turned to System 200 for some practical, farsighted solutions.

The System 200 Citibank installation provides a centrally located master file containing File Film of each employee. This is updated at frequent intervals to provide the latest and most accurate information. Updated copies of all record changes made in the master file are sent to appropriate satellite files at the bank's major divisions for on-the-spot reference.

In addition to providing efficient information management controls, System 200 will enable Citibank to respond to the requirements of privacy laws by providing employees with ready access to updated file informa-

tion while protecting them against unauthorized access to their records.

## Find out how System 200 can go to work for you.

To learn more about System 200, attach your business card to the area indicated below and mail to Director of Marketing, A.B. Dick/Scott, South Hadley, MA 01075. Or, if you prefer, call 413-538-7550.

A.B. Dick/Scott is a joint enterprise of A.B. Dick Company and Scott Graphics, Inc., A Subsidiary of Scott Paper Company.

Clip your business card here and send to:  
A.B. Dick/Scott,  
South Hadley, MA 01075

- Please send me more information.
- Have your representative contact me directly.

**A.B. DICK / SCOTT**

# news in perspective

services under the rule since 1972 and in recent years has been issuing retroactive assessments (May 1977, p. 155).

The hearing was scheduled at the request of the state's Sales Tax Action Group (STAG) which, as it had promised (February, p. 183), packed the room for the hearing. There was standing room only when it opened.

What was accomplished remains to be seen. The board did grant a request by Larry Finch, chairman of General Business Systems, Burlingame, Calif. and a STAG director, that its staff be directed to "work with a committee from the industry to do to 1502 what needs to be done." This was seen as "a step in the right direction" by most industry observers present and, as a result of the concession, many who had been scheduled to speak declined to do so.

## Trip to Chicago

A committee had not been named at this writing nor had its size been determined. Ronald Carpenter, president of Intellidata Inc., Sunnyvale, Calif. and a STAG director, went to Chicago after the hearing to meet with the national tax committee of the Assn. of Data Processing Services Organizations (ADAPSO). "We wanted the benefit of their experience," said Stephen Hollman, general counsel for Optimum Systems Inc. and a STAG director. The ADAPSO committee worked with the New York State Tax Commission on rewriting its laws.

STAG also, after the hearing, wrote to Board of Equalization staff member Gary Jugum, asking his schedule of availability.

If STAG members had hoped to impress the California board with actions in other states which have exempted software and services from sales and use taxes, they had to be disappointed.

"I'm unimpressed with the other states, with the judiciary in Tennessee, Florida and Alabama, and an administrative body in New York," said Board Member William M. Bennett.

He did concede later in the hearing, after Frederick A. Richman of O'Melveny & Myers, an attorney for IBM, said a Washington, D. C., Circuit Court of Appeals had held an IBM computer program to be intangible personal property and not subject to property tax, that "that impresses me."

## One year audit

Finch apparently got through to Board Member Reilly when he told how his company had been subjected to a Board of Equalization audit that took one year. "An audit that took a year," said Reilly, "That doesn't add up in my book. It's a mild shock to me."

Finch predicted that the state "will be inundated with lawsuits over the next two years if nothing is done about it (1502).

Board Member Richard Nevins seemed to feel that that's what should happen. "If it's unfair (1502), then the legislature and the courts should dictate that. It's not our problem." He went on to call the New York State sales tax system, "an abortion from the word go. They can rule any way they want, but that doesn't bind us in any way, shape or form."

STAG requested the hearing on grounds that, "there have been numerous inconsistent interpretations of Regulation 1502 by the State Board of Equalization; Regulation 1502 does not reflect current technology; and as a result of the difficulty of responsible businessmen, lawyers, and accountants interpreting Regulation 1502 in the first instance, the inconsistent interpretations of Regulation 1502 by the State Board of Equalization, and the fact that Regulation 1502 does not reflect current technology, there is an overall quandry within the computer services industry as to when sales and use tax is to be charged and when it is not to be charged."

## Would like repeal

Most industry speakers at the board hearing indicated that they really would like to see 1502 repealed but that they didn't hope for any more than a revision.

And while California moves toward a possible revision, New Jersey has effectively exempted software from taxation. As a result of a series of meetings between ADAPSO's New Jersey Tax Committee and New Jersey's Division of Taxa-

tion, proposed rules on sales tax and data processing have been issued which generally provide that software and services are not subject to tax, although data conversion (such as keypunching) is taxable where the product is delivered directly to the customer.

The ADAPSO committee, headed by George Raymond of Automatic Business Center, Inc., met with Sidney Glaser, Director of the Division of Taxation, to work on the rules which represent a reversal of former positions taken by the state. In exempting software, New Jersey has proposed that the programs must be either modified to run in the environment of the customer's particular make and model of computer or the result of analysis by the vendor of the customer's requirement. This is similar to the position taken by New York.

And in Tennessee, where it had been thought that sales tax on computer software had been repealed, it has developed that the exemption applies only to software which is fabricated for "one's own use and consumption." Package or custom software which is sold to another person continues to be taxable.

—Edith Myers

## PCMs

## The Magnuson 80: A Lot of the Others'

The formal announcement in May of Magnuson's IBM-compatible mainframe line brought a sense of déjà vu. Obviously déjà vu in being IBM compatible . . . and paralleling, with the mini and microcomputer markets, Amdahl Corp's 470 series, Tandem's multiple-processor Nonstop series, and the

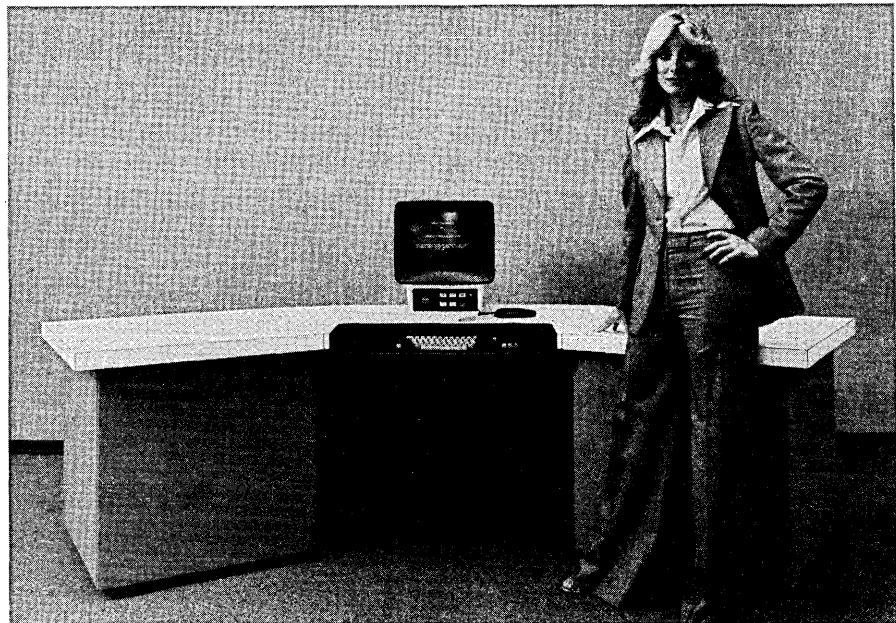

THIS IS IT: The Magnuson M80 contains central processor with up to 4 million bytes of main storage, up to 8 channels and up to 256K bytes of firmware.

rumored E-Series from IBM.

Magnuson's M80 line is built around a standard bus and card cage, much like minis, and perhaps more like micros, as different cpu boards can be plugged in to upgrade the system. The console contains the smarts necessary to support remote diagnostics, similar to the Nova-based console announced with Amdahl's machines in 1975. Multiple processors may be included in an M80 mainframe, with automatic reconfiguration if a processor goes bad—a step in the direction of Tandem's multiprocessor architecture. And it's said the cpu isn't constrained to mimicking a 370—Carl Amdahl, one of the system's architects, said it could as easily become an equivalent for processors from other vendors. He added—paralleling E-Series rumors—that several console-selectable emulators could reside in one M80.

#### In the big city

At a press conference in New York last month, Magnuson Systems Corp. of Santa Clara, Calif., introduced itself, its management and two of three planned mainframes.

Formed in January 1977 by Paul H. Magnuson, Carlton G. Amdahl, Raymond A. Williams, Jr., and Robert B. McCullough, the firm is more than 50% owned by its officers. It has an additional \$1-million in venture capital, and Fairchild has arranged \$4-million in financing in turn for a 1/3 share of the action, according to Magnuson. The firm aims to manufacture the M80 Series—with 1.2 to 2 times the throughput of competing IBM mainframes—and market them to end-users, leasing firms, and oem's.

Magnuson, chairman of the board and president of the new firm, is credited with conceiving the architecture of both the firm's business plan and its product. His professional background includes marketing, r&d, and operations positions at Cincinnati Milacron, Amdahl, RCA, and IBM.

Amdahl, son of Amdahl Corp.'s Gene Amdahl, holds the position of executive v.p. A computer scientist with degrees from the Univ. of Calif. at Berkeley, the 27-year-old Amdahl shares principal engineering responsibilities with McCullough. Amdahl also has worked at Advanced Memory Systems (now Inter-sil), EM&M, Fujitsu, Ltd., and other companies.

McCullough occupies the position of v.p.-operations. He has worked at National Semiconductor, AMS, and Diablo Systems, and holds a PhD from Stanford.

#### Amdahl co-founder

Williams, v.p.-finance, was a co-founder of Amdahl Corp., where he raised that firm's first \$20-million of capital. He is responsible for raising Magnuson's capital. Previously, he managed private investments, and held positions

June, 1978

## Litton Computer Services Introduces

# APL

### operating under TSO

ADRS, an enhancement to APL, helps solve your report production problems. The APL statistical library is comparable to packages such as SAS and SPSS for solving statistical problems, and are offered in these categories:

- Descriptive statistics
- Inferential statistics
- Analysis of variance
- Regression analysis
- Correlation analysis
- Quality control
- Non-Linear least square
- Reliability analysis
- Linear programming

For more information, call or write:



## Litton Computer Services

1831 Michael Faraday Dr.  
Reston, Virginia 22090  
(703) 471-9200



CIRCLE 158 ON READER CARD

# TO SOLVE OPERATIONAL PROBLEMS

# AND...

CIRCLE 138 ON READER CARD

# The Printer Store

Digital Associates Corporation

## IBM Series/1 Users: Look how much more printer you get for \$1 ...

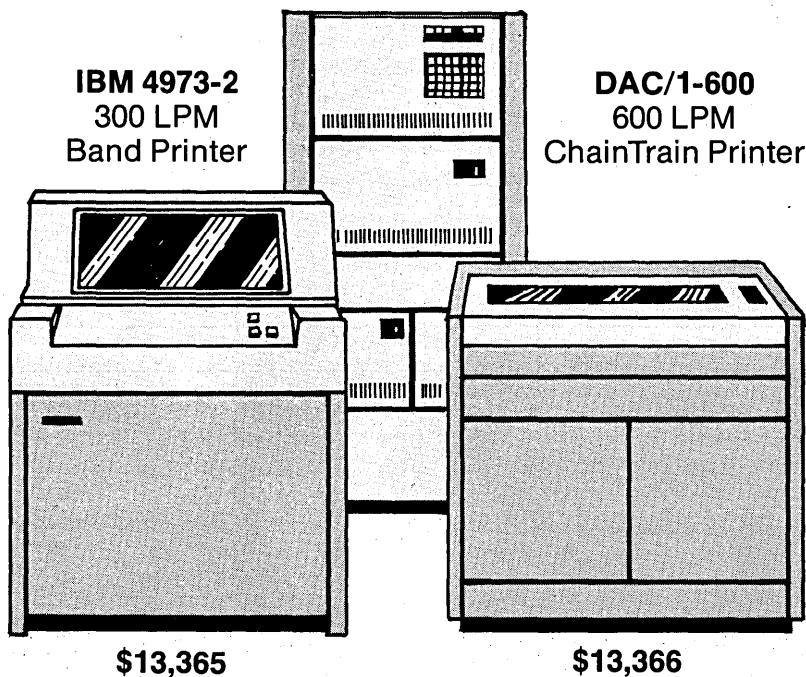

IBM 4973-2  
300 LPM  
Band Printer

DAC/1-600  
600 LPM  
ChainTrain Printer

\$13,365

\$13,366

For just **ONE DOLLAR** more, you can get a 600 LPM heavy duty ChainTrain printer for your Series/1 from The Printer Store instead of an IBM 300 LPM 4973-2 band printer. Our DAC/1-600 offers superior letter quality printing. It comes complete with a DAC S/1 printer controller attachment, a single printed circuit board that plugs directly into an I/O slot of the IBM processor or the IBM input/output expansion unit, and does not require modifications to IBM Operating Systems. And if you choose the higher speed

DAC/1-1000 LPM printer, you improve upon price/performance even more.

The Printer Store is **THE** alternative source for Series/1 line printers with installation and maintenance service available on a nationwide basis. We also offer line printers that are compatible with DEC, Data General, Hewlett-Packard, Interdata, G. A. and most other minicomputer systems. Contact The Printer Store for specific price information on the printer of your choice and get your **DOLLAR'S** worth.

Digital Associates Corporation, 1039 E. Main St., Stamford, CT 06902  
Call Toll Free 800-243-9054

CIRCLE 148 ON READER CARD

## news in perspective

at IBM and the Kaiser Foundation.

The remaining officers are: Joseph L. Hitt, v.p.-marketing; Kevin Anderson, v.p.-software; and S. A. Johnson, controller and assistant secretary.

Describing the M80 series, Amdahl said the machines will compete with IBM mainframes up to and beyond the 370/158. The two processors announced in New York, the M80/3 and M80/4, are said to compete most directly with IBM's 138 and 148, respectively. A third, the M80/5, said to be in the 158 and 3031 market, is slated for formal announcement later this year.

The systems are built with off-the-shelf components, including Schottky TTL MSI chips. Amdahl said memory can be built of either 4K bits or 16K bits chips. He continued that the architecture is sufficiently flexible to allow the adoption of new technologies, such as high-speed LSI logic, and CCD or bubble memory when

The systems are built with off-the-shelf components, including Schottky TTL medium scale integrated chips, but adaptable for new technologies.

they become cost competitive.

Currently the systems are expandable to 16 channels. 16M bytes of main memory, and control storage of 256K bytes. Channels and main memory are currently constrained by the IBM operating systems used with the M80. Control store capacity starts off at 8KB; the large amount of expansion possible is in anticipation of IBM increasing its use of firmware-based operating system features. It also can be used for microcoded software assists.

Channels on the M80 are said to be equivalent to 168 channels. The console is functionally similar to a 158, with additional features. It supports fault diagnosis to the board level, and to the individual chip in memory malfunctions. Remote diagnostics, via a communications link, also are supported by the console.

### Triplex voting

Reliability can be greatly enhanced through the inclusion of multiple cpu's and "triplex voting." Processor boards can compare their results, calling for automatic reconfiguration if the results don't match. With three processors, the odd-man gets switched out. If there are only two, diagnostic routines are invoked



to determine and configure around the culprit. Up to four cpu's may participate in a fail-safe system—the fourth serves as a spare, which is switched in if a board fails.

The firm also has set up a customer support organization, and "will assume responsibility for total problem definition and coordinate the resources necessary to resolve the problem," according to Hitt. A 24-hour center at the firm's headquarters will provide remote on-line problem diagnosis, as well as the resources of a software maintenance group and a hardware group.

Initially, sales offices will be opened in New York, Washington, D.C., Atlanta, Chicago, Dallas, Detroit, Los Angeles, and San Francisco. Deliveries of the \$200,000 to \$800,000 machines are expected to take 60 to 90 days, with the M80/3 and M80/4 becoming available this summer, and the M80/5 later this year.

—Bill Musgrave

### Communications

## Bell's Big Venture Into Fiber Optics

The basement of Illinois Bell's Franklin Central Office houses one of the largest cable vaults in the domestic telephone system. Nearly 280 cables, neatly lashed to racks, run from the vault, interconnecting the Franklin office with other switching offices and subscribers. Older cables are protected by lead casings, newer cables are cased in plastic. In bundles several inches in diameter, each cable contains from 900 to 3,600 pairs of copper wire.

Two cables look radically different from the rest. They're smaller, about an inch in diameter, and they're cased in light gray plastic, instead of lead or the black plastic of the larger cables. Instead of hundreds of wires, each of these two

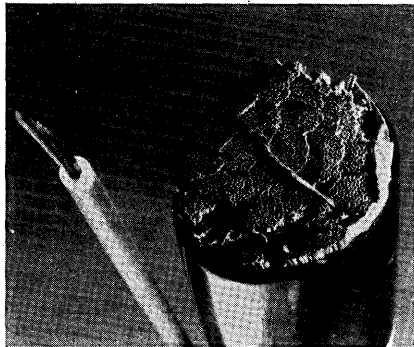

BELL's 144-fiber lightguide cable, only a half inch in diameter, has a capacity of nearly 50,000 simultaneous conversations. That's triple the capacity of 1,200-pair wire cable that typically is used throughout the Bell System.

June, 1978



100% EQUITY

•LEASE •RENT  
•PURCHASE

**NOW! Full  
Ownership  
After 24 mos.**

**\$139.mo.  
or  
\$2695.**

Call or write  
for more  
information...



**NCE TERMINALS & COMMUNICATIONS, INC.**

<p><b>Regional Office East</b> 300 Raratin Ctr. Pkwy. Bldg. 806, Edison, NJ 201-225-0892 Toll free # 800-631-5919</p>	<p><b>Headquarters Office Midwest</b> 945 W. Liberty Dr. Wheaton, Ill. 60187 312-682-0001 Toll free # 800-323-1780</p>	<p><b>Regional Office South</b> 1110 Busch Blvd. Tampa, FL 813-932-2666</p>
---	--	---

CIRCLE 163 ON READER CARD

DECWRITER:  
LA 36 .....\$1495 or \$76 mo.  
LS 120 ..... 2895 or 148 mo.  
LA 180 ..... 2450 or 148 mo.  
VT 52 ..... 1550 or 79 mo.  
ADM 3A ..... 850 or 44 mo.  
DIABLO:  
1620-1 ..... 2695 or 139 mo.  
1641-1 ..... " "  
1660-1 ..... " "  
REGENT 100 ..... 1325 or 60 mo.  
TERMICETTE 3321 . 1895 or 87 mo.  
ACOUSTIC COUPLER 245 or 13 mo.  
WORK STATION ... 295 or 13 mo.

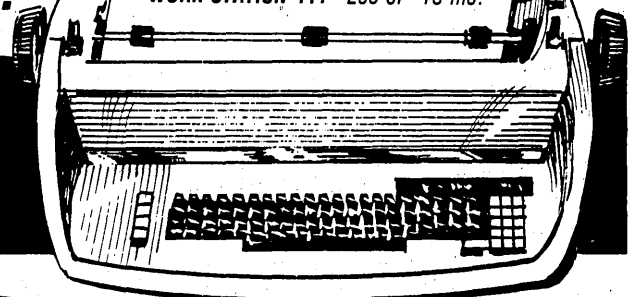

# INCREASE SYSTEM EFFICIENCY AND COMPUTER PRODUCTIVITY...

CIRCLE 139 ON READER CARD

# news in perspective

small cables contains 24 fiber optic light guides.

Chicago is the site of AT&T's most ambitious experiment in fiber optic communications to date. Since May of 1977, Illinois Bell has operated a fiber optic link between the Franklin and Wabash central offices, and between the Franklin office and the Brunswick Bldg., a downtown office building. The links, totaling about 1½ miles, carry data, voice, and video signals. The Franklin to Brunswick

link carries two Dataphone digital lines, one voiceband data line, and 78 telephone lines.

Four fibers provide video service: two give point-to-point Picturephone service to a subscriber in the Brunswick Bldg., and two give an access line to the public video conference room in Illinois Bell's headquarters building. The cable connecting the two central offices has 576 interoffice circuits.

On the eve of the Chicago link's first

anniversary, Ira Jacobs, a director in Bell Laboratories Transmission Systems Div., announced the system performed "far in excess" of the 99.98% availability and 99.6% error-free seconds objectives laid down by the Bell System. While no light-wave components caused a service outage, a standard electrical component failed, disrupting some service for 20 seconds.

During its first eight months of service, the line operated error-free on 79% of the days. Jacobs said system availability rated 99.9999% and error-free seconds came in at 99.9992%. The evaluation system, originally slated for removal after the one year test, will be left in place for at least one more year. Charles El-mendorf, AT&T assistant v.p., said the Bell System is sufficiently encouraged by its Chicago experience to commit itself to making a permanent installation by the end of 1980. He identified eight candidate sites: Chicago, Washington, D.C., New York, Los Angeles, Atlanta, Philadelphia, Pittsburgh, and Rochelle Park/Union City, N.J.

The equipment in use in Chicago belongs to Bell Labs. In addition to the fiber optic link, several bays of equipment terminate each cable. Chicago uses laser transmitters, although LED transmitters could work over the relatively short distances involved. An avalanche photodiode functions as the photodetector in receiving units. Multiple messages are imposed on each fiber using time division multiplexing techniques. A circuit consists of two fibers, one for transmission, the other for receiving. At the standard operating speed of 44.7Mbps, each pair of fibers can carry 672 simultaneous conversations, or a mix of voice and data. Although the cables in Chicago have only 24 fibers apiece, AT&T probably will use 144-fiber cables (with a capacity of nearly 50,000 simultaneous conversations) in the future.

Jacobs cautions that the system availability figures developed in Chicago don't mean system components don't fail. "Outage and equipment failure are not synonymous," he notes, "since we do employ automatic protection switching which avoids service outages from most single equipment failures. For example, we did have one laser failure but this did not result in a service outage." One receiver failed but didn't result in an outage, due to automatic switchover to a backup unit.

Hardware in the system—fiber cables, laser transmitters, photodetector receivers, and multiplexors—were manufactured by Western Electric. In its next installation in 1980, Bell plans to use the higher capacity 144-fiber cables, and combined transmitter/receiver units. While the multiplexors operating in Chicago are standard Western Electric products, the transmitters and receivers are only prototype units.

—Bill Musgrave

## Sola "Ultra-Regulation": Plug it in where you need it most.

Brownouts, transients and line noise can cause electronic office equipment to malfunction; drop digits, lose memory, and suffer inefficient operation. Field service people may tell you to install a dedicated line. Still others will suggest an ultra-isolation transformer. But both of these are expensive and inflexible compared with Sola's Mini and Micro/Minicomputer Regulators with "Ultra-Regulation" — complete protection for your electronics.

Sola's "Ultra-Regulators" do everything a dedicated line or an ultra-isolation transformer does and more. They eliminate transients and provide complete isolation from line surges. The resulting waveshape contains less

than 3% harmonic distortion. What's more, each unit is portable. You can plug it in where it's needed most at any given moment. And it's UL listed.

Sola Micro/Minicomputer Regulators provide better than 120 db common mode noise rejection; 60 db transverse mode noise rejection, as well as reliable brownout protection. Output remains within NEMA voltage specification of  $\pm 5\%$  for input voltages as low as 65% of nominal.

Before you invest in ultra-isolation or a dedicated line, investigate Sola's Mini and Micro/Minicomputer Regulators—in stock for immediate shipment through your local Sola stocking distributor. Call or write for free literature.



1717 BUSSE RD., ELK GROVE VILLAGE, ILLINOIS 60007 (312) 439-2800

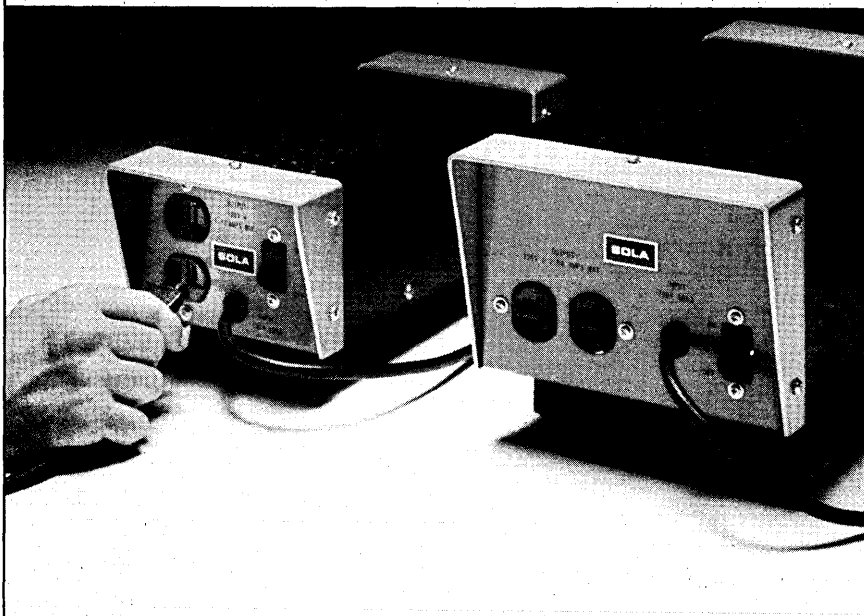

## USPS to Undercut Mailgram Rates

The U.S. Postal Service is developing an "Advanced Communications System" (ACS) that features on-line input of letter-type mail through existing keyboard terminals installed at the mailer's premises, and carrier delivery no more than two days later—all at a price per message "significantly below present Mailgram rates."

A knowledgeable source says the new service could start up by the end of this year, although it's more likely to take considerably longer.

## USPS plans to lease all ACS facilities to stave off complaints.

Essentially, ACS is a carbon copy of Western Union's Mailgram service, with one key difference: Mailgram is a joint WU-USPS venture in which prices and revenue shares are agreed upon mutually; ACS will utilize commercially provided circuits, switching, concentrating, and terminal facilities, but USPS will be the sole owner.

Initially, ACS will transmit mail-type messages among 25 cities. Ultimately, the plan is to interconnect most of the others. The message path will run from the sender's terminal through a concentrator to a computerized switch, and from there via terrestrial or satellite circuits to a terminal at each destination post office. At this point, the bits comprising the message will be converted to hard copy, the message will be automatically inserted into an envelope and given to the mailman for delivery.

USPS plans to lease all ACS communication facilities at least partly to stave off complaints to Congress about unfair government competition with private industry. By the end of this month, the agency expects to decide whether it will solicit competitive bids or negotiate a contract with Western Union. If there is sufficient interest, it will be a competitive procurement, and about two years will be needed to bring the ACS network into operation. The other option—a negotiated contract with the telegraph company—could lead to a startup by the end of this year.

ACS grows out of a need expressed by "a volume mailer" (reportedly Shell Oil Co.) for a quicker, more reliable means of sending messages to its service stations. Exploratory USPS talks with other mass mailers, particularly firms that have to send out large volumes of past-due collection notices to their customers, indicate a potential market amounting to "several hundred million pieces of mail a year," according to one source. By comparison, WU's Mailgram service is handling about 30 million messages a year. \*

June, 1978

## Free 48-page catalog to help you increase computer room efficiency.

The Minicomputer Accessories' new 1978 Summer Catalog is yours for the asking. Our same-day shipment policy means you get your order when you need it. And a full, no-nonsense guarantee on every product assures your satisfaction.

9 pages give you practical, reasonably priced media storage alternatives.

Pages 11-19 give you same-day shipment on guaranteed media while saving you money.

Page 3 introduces you to an all-new software calculator.

Pages 38-44 are full of cables/connectors you can order today and receive tomorrow.

Pages 24-25 show you how to increase keying operator productivity.

Pages 34-35 offer you 9 ways to improve your software designs.

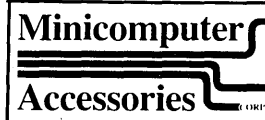

For your free catalog circle No.161 on inquiry card.

130 S. Wolfe Rd. • P.O. Box 9004  
Sunnyvale, CA 94086 • (408)737-7777

CIRCLE 161 ON READER CARD

# RESOLVE™ HELPS YOU MANAGE YOUR MVT, VSI, SVS AND MVS SYSTEM

CIRCLE 140 ON READER CARD

247

## Meetings

### DDP Presumes Local Control

Distributed data processing is a reaction to the 1960s when empire builders wanted to get all the power in one location, says consultant Stephen A. Epner. It was a time, he said, when "if you wanted something, you were told that there was not enough time or capacity."

Epner, the president of his own consulting firm and a founder of the two-year-old Independent Computer Consultants Assn., spoke in Atlanta recently at the 1978 international CUFAM conference, an association of users of a general ledger and financial information and control system offered by Management Science of America, the Atlanta software firm. Some 1,100 turned out.

He said management control is the major argument for distributed data processing. "If a company does trust its remote manager to run his section of the business, ddp gives that person the control he needs to operate successfully. You're not cutting off the central ma-

chine. You are only sending to the central machine that information that the top dogs can use. They don't want to look at how much you spend on your phone calls, but maybe at one location that is important, because you control a certain part of your budget that way. You should be able to see that information."

Epner added that ddp doesn't require a minicomputer, "but we're moving in that direction because a lot of companies can afford to put a mini in a remote location."

#### Local memory, control

Distributed data processing is not remote job entry, nor is it the use of smart terminals because these have only limited memory and limited editing capability. Epner said a user is in a distributed mode when he has his own computer, it has local memory, and local people have control over it as well as the responsibility and authority to make sure the data base is current and up-to-date.

He warned users against thinking that all of their problems would vanish with the use of ddp. Though it provides the end user with control over input processing, report generation, and preventive

maintenance scheduling, the user also inherits such chores as doing reruns for errors, backup and control responsibility, audits for control and security, downtime jitters, and supply inventory.

The reward is flexibility—the user can schedule a second run, he can increase reporting frequency, he can control design, and given that he has a data base locally, he can generate reports more meaningful to him, special reports on a one-time basis to help him run his business.

How does a user decide when there are 300 manufacturers of minicomputers and maxicomputers announcing a new machine almost every day? "As soon as you pick a machine there will be another one announced that is a little faster, a little cheaper, and has new bells and whistles," says Epner. "Those are the types of considerations that got data processing people in trouble before. A machine is current only the day it is announced. By the time it gets in production, it is out of date, and by the time it is delivered, it is old hat. That means something to data processing people who want to play with bits and bytes, but it means nothing to the end user. Buy the machine

---

**A company sometimes bends the rules for its own people, but it can't do that for a consultant.**

---

## NOW AVAILABLE! A 10MB DISC SYSTEM FOR THE LSI-11

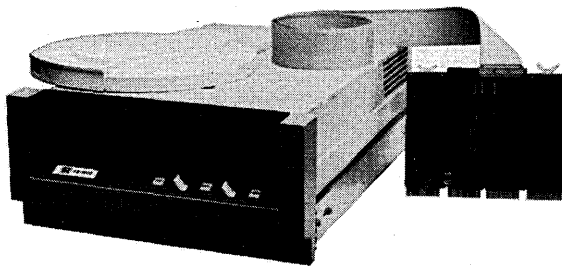

ER1010..... \$6,900

The ER1010 plugs directly into the backplane, is transparent to RT-11 operating systems and carries a full one year warranty.



**EQUIPMENT RESOURCES, INC.**  
1175-4 Fleming Street, Smyrna, GA 30080  
1-800-241-9960, In Georgia call (404) 434-1382  
COMPUTER SYSTEMS AND EQUIPMENT

that will solve a problem for you. It is important to define your requirements, because there are all kinds of systems being set up to make minis easier to use. You can find a machine already built with software available to solve your requirements."

#### Recruiting

If companies are to exploit successfully the capabilities of their hardware and software, then the accountants, the programmers, the systems analysts, the project leaders, to name a few, must be able to work effectively together. At this point executive recruitment becomes important to a user, said J. Houstoun M. Clinch, of Paul Stafford Associates Ltd., in a session on executive search. When a company exhausts its own resources to locate and hire an employee who is desperately needed in one of these areas, someone has to find him.

"This is the void that fostered the executive recruiting industry," says Clinch. Twenty years ago the industry was virtually nonexistent, and though accurate figures are not available, it is estimated that it is a \$300 million annual business and growing. Clinch told users to "resort" to search firms only when it becomes necessary to find a specific individual, not as a matter of course. Typ-

ically, a search will take three to four months and will cost 25% to 30% of the annual salary plus expenses.

"Many people are outraged by this cost, but if you try to put a dollar value on the effort you have saved by using a quality firm, you might not think this is such a bad deal."

How does a company locate a quality firm? Clinch cautions that virtually any person can hold himself out as an executive recruiter. The best type of firm, he maintains, is one that is engaged by and works only for the company and is paid by the company, not the job seeker. This avoids any conflicts of interest between client and candidate. Most of the better firms do not work on a contingency basis, but charge a retainer or submit monthly charges for time spent. This is credited against the total fee.

### Evaluation

He mentions three guidelines to evaluate the firm. First users can check with other companies that have used such firms, and they can check the clients of the search firm to see that they are satisfied. If a search firm refuses to provide a prospective client with a list of its past customers, Clinch recommends finding another firm. Second, the user should meet representatives of the firm, as well as the man who will be conducting the assignment. The quality of the firm's personnel will be a reliable indicator. Third, the user should shy away from firms that are overly aggressive or absolutely guarantee success. "Even the best firms sometimes fail," says Clinch.

During negotiations with leading candidates, the person directing the search should keep himself in a position where he is able to render advice and counsel to both the client company and the candidate, facilitating the entire process. The search person should be a listening post, resolving differences and confusion on anything that would lead to a breakdown or conclusion of negotiations.

Clinch also offers a few tips on how to act if you're called by an executive recruiter. It is unnecessary to jump to the conclusion that he wants to hire you, says Clinch. He may be seeking information about your industry, wanting to learn buzz words and types of skills required, or he may want information on quality companies, operations, and people. Or he may wish to trigger your interest.

"In view of the checkered reputation of the search industry, you will have good reason to be cautious about talking to him. If you choose to hear him out, and I urge you to do so, be sure he proves to your satisfaction that he is ethical."

The \$25,000-\$30,000 salary range is generally the level at which executive recruiting becomes an effective method of locating qualified individuals. The better recruiting firms know a client is looking for high quality people who have

Everything's out here!  
How come you're still operating?

I've got connections, man!

TAURUS™  
UPS

Utility power failures, voltage reductions or fluctuations can never affect your computers or equipment if they are protected by TAURUS™ Series Uninterruptible Power Systems. You are assured a continuous supply of clean, transient-free power no matter what. Our catalog tells more... why Taurus Systems offer higher efficiency... how their modular sub-assemblies simplify maintenance and reduce downtime... how our line, which includes inverters and frequency changers, plus our 24-hour nationwide service provide the kind of power failure insurance your equipment needs. Send for our free catalog today.

**NOVA UNINTERRUPTIBLE POWER SYSTEMS**  
Nova Electric Manufacturing Co., Dept. D-48  
263 Hillside Ave., Nutley, N.J. 07110 (201) 661-3434

CIRCLE 162 ON READER CARD

# GET RESOLVE™



**Boole & Babbage**

510 Oakmead Parkway  
Sunnyvale, CA. 94086

In California:  
408/735-9550

Outside California, Dial Toll Free:  
800/538-1872



CIRCLE 141 ON READER CARD



# news in perspective

specific skills and track records. These people may or may not be available in the job market at any given time. That is not an important criteria when a company is looking for a specific someone, says Clinch.

## Consultants

As an alternative to hiring, a company may consider consultants. Though the short-term cost will be greater than for a full-time employee, the cost will come to an end. Epner says the one thing expected from consultants is results.

When a company is selecting a consultant, its representative wants to be assured that the company is associated with someone who will follow through. For the big eight accounting firms this is no problem, but it has been a serious drawback for the one-man shop. Epner said that with the formation of the Inde-

pendent Computer Consultants Assn., that problem has diminished. Members have the contacts to provide reliable backup should they encounter unexpected problems. Businessmen must realize that there is risk involved with working with a smaller shop, but smaller firms charge much less.

A businessman can expect a consultant, small or large, to provide written proposals which should be well organized, should define problems, the scope of the project and the plan of action, and should specify scheduling as well as fees and billing procedures.

"A lot of consultants forget to talk about fees and billing, and that causes more misunderstandings and problems later on," says Epner.

The consultant's professionalism is also an issue. He should be self-managed and self-motivated. A company some-

times bends the rules for its own people, but it can't do that for a consultant. He should be present during regular working hours so as not to create resentment among the employees. And the client should be totally informed of progress toward the objective.

In turn, the client should be willing to define the project or a fixed cost should be suggested to develop that definition. And the client should be willing to define completion and what constitutes acceptance. "At the beginning define completion; otherwise, the project goes on and on. This is the biggest problem we have and the source of bad reputations," says Epner.

Finally, there should be a written contract or letter of understanding. It should encompass both the previous points and spell out terms and conditions. "Both sides must know where they are going and work together to get there," says Epner.

—Lynn Ridlehuber

## News in Perspective

### BENCHMARKS . . .

**Still No Announcement:** Although IBM Japan salesmen were accused of violating Japan's trade laws by "preselling" their company's unannounced E Series of computers, the company a month later still had not announced the new series. IBM did reprimand close to 40 salesmen; some received salary cuts and several were suspended, but its only comment was that some employees "in violation of company regulations" had engaged in "sample surveying" at seven sites in Osaka and six in Nagoya. Japan's Ministry of Trade and Industry, however, said its own investigation had uncovered about several dozen instances where the E Series machines had been touted. The E Series is believed to consist of six small- and medium-sized computers with twice the cost performance of equivalent machines in the 370 series. IBM had told MITI it had no plans to announce the systems within the year or even in the spring of 1979.

**"George" Goes:** Cincinnati Milacron, Inc. agreed to sell its line of small business computers, called "George," to a group of employees who formed a company called CSP International Corp. The employees from the company's Electronic Systems Div., Lebanon, Ohio, also acquired world manufacturing and marketing rights to the George line. Wayne Sennett, manager of Milacron's small business systems operation at the Lebanon plant, is president of CSP International Corp. Details of the transaction were not disclosed, but Milacron said it will continue to produce minicomputers for its numerical controlled machine tools.

**Execunet Lives:** AT&T lost another big regulatory decision. For nearly four years, the telephone company—with an assist from the Federal Communications Commission—has been trying to kill Execunet, a service provided to business telephone customers by MCI Communications Corp., as a direct competitor to Bell's monopoly message toll services (MTS) offerings. Last year, the U.S. Circuit Court of Appeals in Washington, D. C. ruled that MCI was legally entitled to market the service. But the phone company prevented MCI from doing so by refusing to provide local loops to new Execunet customers. Last April a three-judge panel of the appeals court, in a strongly worded order that accused both the FCC and the phone company of trying to circumvent the earlier decision, said the access lines would have to be provided. But Bell then asked for a rehearing by the full court, and the panel agreed to delay the effective date of its decision until this new petition was disposed of. The appeals court declined to rehear the case last month and the Supreme Court turned down a request by AT&T to review it. The stay against MCI thereby was lifted and Bell will be required to supply local loops for new customers.

**Out of Paper:** NCR Corp. agreed to sell its Appleton Papers Div. to the diversified British company, B.A.T. Industries, Ltd. for \$280 million in cash. The paper division, which did about \$201 million last year, contributed \$37 million to NCR pretax income of \$268 million. The company will use the money to concentrate its resources entirely on data processing and directly related businesses.

**OCR Marketing Deal:** Control Data Corp. is negotiating a deal with Scan-Data Corp. under which the Minneapolis firm would invest an amount equivalent to about half of Scan-Data's 2 million shares of outstanding stock in return for Scan-Data marketing CDC's ocr products. CDC also would assist the company with certain manufacturing and service support for its fast food order entry and control system, called the Positran, as well as providing joint planning and research in these markets.

**Time-Sharing Ratings:** Control Data Corp.'s time-sharing services received top rating in a recent poll of 458 users of remote computing services, but most other major offerings were ranked very closely in the study. Users were asked to rate the services on a scale of 4. Control Data, the industry's largest supplier of computing services, received a 3.5 rating to edge out United Computing Systems, which had a 3.4 rating, along with Comshare and Cyphernetics, now part of ADP Network Services; National CSS, On-Line Systems, and University Computing Co., all tied at 3.3. Other rankings: Compu-Serv Network, Data Resources, General Electric, Informatics, and Systems Dimensions, all tied at 3.2; Service Bureau Corp., 3.1; Computer Sciences, First Data, McDonnell Douglas Automation, and Tymshare, tied at 3.0; Boeing Computer Services, 2.9; Rapidata, 2.9; Grumman (Call Data Systems), 2.6; and Honeywell Information Systems, 2.6. The study, conducted by Datapro Research Corp., 1805 Underwood Blvd., Delran, NJ 08075, has been turned into a 41-page report, "All About Time-Sharing and Remote Computing Services," which is being sold for \$12. \*

# SOLUTION NUMBERS

## Two Terminal Rentals

Leasametric offers two terminal rental plans to help you manage your equipment. The first plan is for customers who want to rent terminals for a short period of time.

The second plan is for customers who want to rent terminals for a longer period of time. This plan includes a maintenance program.

Leasametric offers two terminal rental plans to help you manage your equipment. The first plan is for customers who want to rent terminals for a short period of time.

The second plan is for customers who want to rent terminals for a longer period of time. This plan includes a maintenance program.

Leasametric offers two terminal rental plans to help you manage your equipment. The first plan is for customers who want to rent terminals for a short period of time.

The second plan is for customers who want to rent terminals for a longer period of time. This plan includes a maintenance program.

Leasametric offers two terminal rental plans to help you manage your equipment. The first plan is for customers who want to rent terminals for a short period of time.

The second plan is for customers who want to rent terminals for a longer period of time. This plan includes a maintenance program.

Leasametric offers two terminal rental plans to help you manage your equipment. The first plan is for customers who want to rent terminals for a short period of time.

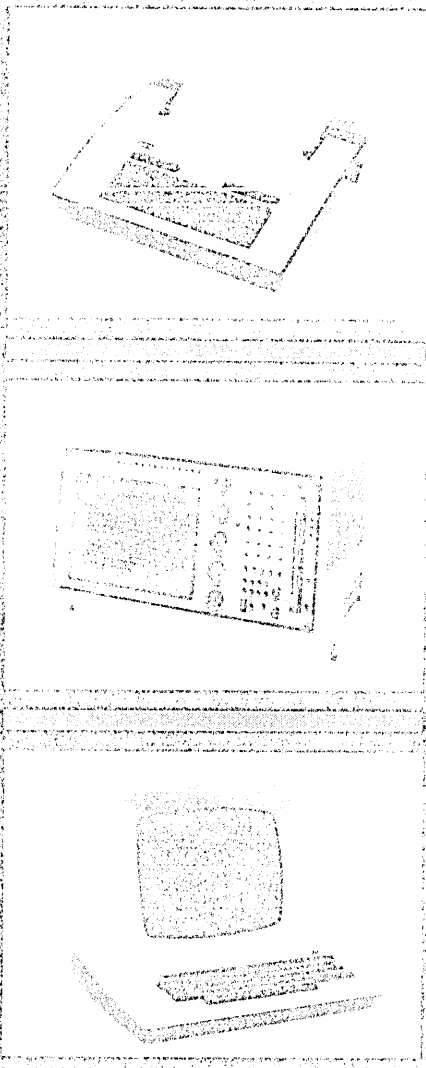

Leasametric offers two terminal rental plans to help you manage your equipment. The first plan is for customers who want to rent terminals for a short period of time.

The second plan is for customers who want to rent terminals for a longer period of time. This plan includes a maintenance program.

Leasametric offers two terminal rental plans to help you manage your equipment. The first plan is for customers who want to rent terminals for a short period of time.

The second plan is for customers who want to rent terminals for a longer period of time. This plan includes a maintenance program.

Leasametric offers two terminal rental plans to help you manage your equipment. The first plan is for customers who want to rent terminals for a short period of time.

The second plan is for customers who want to rent terminals for a longer period of time. This plan includes a maintenance program.

Leasametric offers two terminal rental plans to help you manage your equipment. The first plan is for customers who want to rent terminals for a short period of time.

The second plan is for customers who want to rent terminals for a longer period of time. This plan includes a maintenance program.

Leasametric offers two terminal rental plans to help you manage your equipment. The first plan is for customers who want to rent terminals for a short period of time.

## Leasametric

Division of Metric Resources Corporation, 222 Airport Blvd., Burlingame, CA 94010

**NEW YORK OFFICES:** San Francisco, CA (415) 329-4000; Los Angeles, CA (310) 499-7000; Anaheim, CA (714) 995-9975; San Diego, CA (619) 542-1000; Boston, MA (617) 451-2000; Chicago, IL (312) 399-2700; Boston, MA (617) 451-2000; Dallas, TX (214) 343-2000; Atlanta, GA (404) 252-2000; Houston, TX (713) 467-1000; Denver, CO (303) 751-2000; Minneapolis, MN (612) 555-2000; Dallas, TX (214) 343-2000; Phoenix, AZ (602) 246-2000; Portland, OR (503) 252-2000; Salt Lake City, UT (801) 487-2000; Seattle, WA (206) 452-2000; Toronto, Ontario, Canada (416) 754-2000.  
**FOR OFFICIAL USE ONLY:** Ft. Belvoir, Colorado (303) 262-2000; Ft. Belvoir, Colorado (303) 262-2000; Ft. Belvoir, Colorado (303) 262-2000.

# LOOK AHEAD

(Continued from page 18)

Wellesley, Mass. The multiple computer system would use Cullinane's IDMS and proprietary communications software to permit multiple 370s to share a single data base. The system should see the light of day by fall.

## BANK TERMINALS COMPETITION WINDING DOWN

Lincoln First Banks Inc., Rochester, N.Y. holding company for five multi-branch banks, is nearing the end of a six month test of on-line teller terminals in three branches. Each test branch was completely equipped with terminals from IBM, NCR and Datatrol Inc. "They're all doing exactly what we wanted and doing it equally well," said Bruce Snyder, Lincoln senior vp, "so it seems to boil down to price and the ability to attach to other equipment." Snyder last month said Datatrol seemed to have the edge in both these areas but a final cost analysis won't be complete until July 31. It'll mean a big order for whoever wins. Lincoln has 120 terminals installed in the three test branches. In the end it will opt for one vendor for 34 branches.

## ADD-ON MEMORIES FOR THE 303X LINE

Electronic Memories & Magnetics, which plunged into the add-on memory market for the IBM 303X line this month, continues to sell core memories although it no longer manufactures core add-ons for users. "Every year there's a demand," says Ed Farris, vice president in charge of the Computer Products Div. "We sell what comes back and we have a waiting list. In Europe alone we have eleven 360/40 users waiting for more capacity."

The company will begin delivering add-on devices for the 303X line in the fourth quarter of this year, as will Intel and Control Data, the latter using Intersil memory. "We think the software IBM will announce will be a large consumer of memory," says Trude Taylor, EM&M's chairman and president. EM&M and Intel will offer a 4K static device while Control Data's offering, to be announced next month, probably will be a 16K dynamic memory device.

## RUMORS AND RAW RANDOM DATA

Michigan's computer based lottery is bringing in \$3 million a week in bets of which 50% goes back to bettors, 10% goes to running the operation and 40% goes to the state, said Datatrol Inc. which is running the lottery on a facilities management basis. Based on two Burroughs computers and including 700 Datatrol terminals soon to be increased to 900, the system is endearing itself to Michigan taxpayers and, of course to winners...While Insac the British software exporting consortium is trying to find a likely buyer of Viewdata software and systems for the U.S. market, Telenet, the value added carrier, is expected to sign a deal with the British Post Office to bring Viewdata data bases into the U.S...Israel will try to buy the U.S. Arpanet software for its experimental computer network.

- - -

IBM hasn't been taking orders in Iran for more than a year, reportedly because of tax squabbles with government officials. A behind the scenes examination of the situation, as well as analyses of recent IBM pricing changes in Europe, International plug compatible liaisons, the Fujitsu-Siemens lashup, and other events and new product offerings around the world are presented in the June International edition of Datamation. Reprints are available for \$3.00 from Datamation, 1801 S. La Cienega Blvd., Los Angeles, CA 90035.



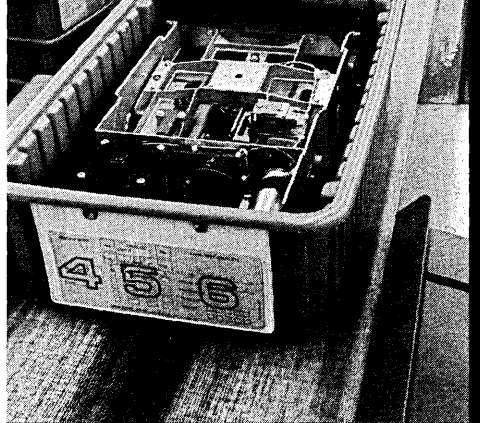
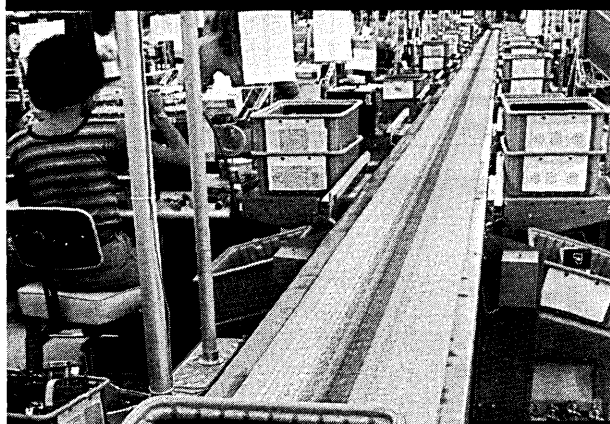
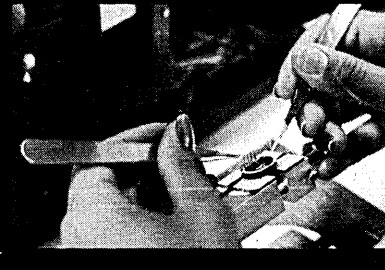
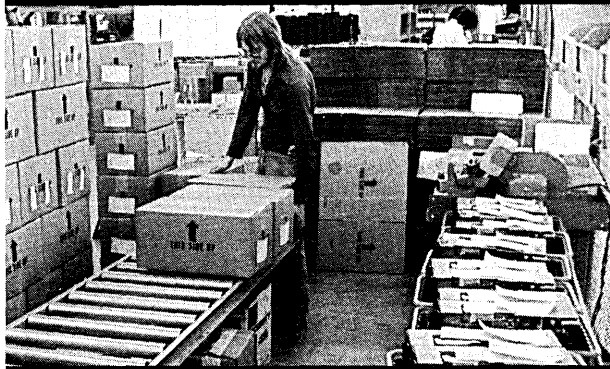
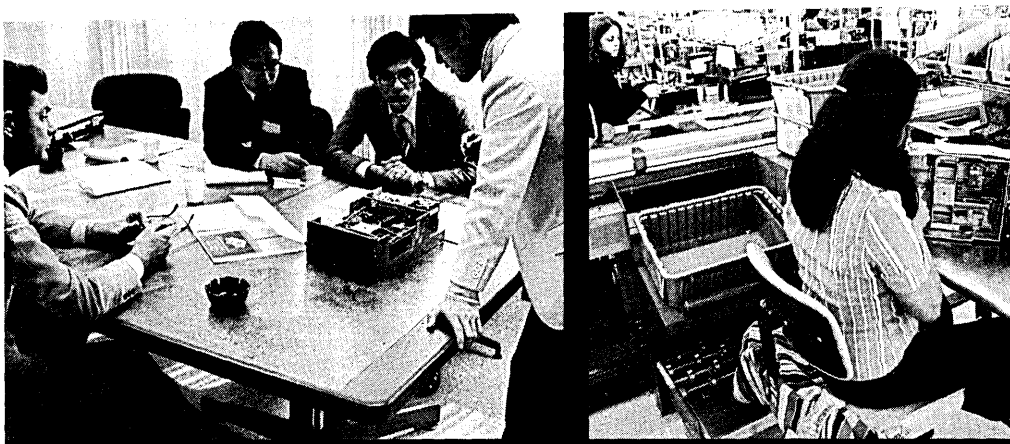

# They work for Shugart.

## That's why Shugart works for you.

**Concentration.** We do one thing well. Our corporate charter is to make high quality, low cost disk storage devices. We concentrate all of our human and material resources on achieving this goal. This specialization is the key to our success in becoming the recognized leader in floppy disk technology and delivery.

**Capacity.** Success as a supplier of peripherals to the OEM equates with delivery of large numbers of cost-effective products at high quality levels. At Shugart, we have been fortunate in attracting highly dedicated people with the expertise to build our manufacturing capacity into the largest in the industry. In 1973 (our first year) we delivered 1,000 floppy drives. This year deliveries will exceed 200,000 units. To successfully handle this dramatic growth, we have built more than 150,000 square feet of production facilities with the most modern high speed conveyerized assembly systems. But it is our people who really make it all happen.

**Leadership.** More dedicated people. More concentration. More technology. More products. More capacity. That's why more OEM's select and trust Shugart.

**Shugart. The leader in low cost disk storage.**

 **Shugart Associates**

415 Oakmead Parkway, Sunnyvale, California 94086  
Telephone: (408) 733-0100  
Europe Sales/Service: 3, Place Gustave Eiffel, Silic 311  
94588 Rungis, France Telephone: (1) 686-00-85

CIRCLE 89 ON READER CARD

# hardware

## Off-line

Memorex has come up with an interesting enhancement to its large-scale disc subsystems: the 3770 Disc Cache provides a high speed buffer between mainframes and the vendor's 367X disc subsystems. Initial deliveries are expected early next year, although pricing has yet to be firmed up. The 3770 consists of 1MB of charge coupled device (CCD) storage, a microprocessor controller, full track buffer, control storage, microcode loader and performance monitor controller, floppy disc, power supply, operation control panel, and field engineer's panel. Options include an integrated performance monitor, the ability to lock active data into memory, and memory expansion to 18MB.

A computerized medical diagnostician, known as INTERNIST, is under development at the Univ. of Pittsburgh. With funding from the National Institutes of Health, and the Bureau of Health Manpower, Dr. Jack Myers, a physician, and Dr. Harry Pople, a PhD in the Univ.'s Graduate School of Business, are developing the system which includes roughly 350 diseases cross-matched with 2,800 manifestations.

If Fujitsu decides to market its Facom M-200 on these shores, it would most likely force IBM's hand, and put a dent into Amdahl's sales. (Since Fujitsu owns a piece of Amdahl's action, don't be surprised if the M-200 is a long time coming.) Fujitsu says the M-200 is the fastest machine in existence. We've heard that it's four times as fast as the biggest Amdahl processor. The M-200 uses 100 gate-per-chip emitter-coupled logic (ECL) and 16Kbit RAMs. Up to four processors may be interconnected in a multiprocessing configuration. The price? Monthly rental fees start at 35 million yen (\$140,000).

We'd like to leave you with a quick reminder to those vendors who have not yet responded to our mini/microcomputer survey. Please send your completed questionnaire to Nancy Knottek, Surveys Editor, 1801 South La Cienega Blvd., Los Angeles, CA 90035. Deadlines draw near, so please do it NOW.

## Voice Data Entry

At one point, not all that many years ago, crt's were both exotic and expensive. Today, price erosion has made the crt one of the, if not the, most common terminal device. Perhaps in 10 or so years, price erosion will make devices such as this vendor's Voice Terminal as common as crt's are today.

As its name implies, the Voice Terminal allows a user to communicate verbally with a computer. A single operator can use a vocabulary of as many as 900 words; in a four-user configuration, the processor can let each user have a vocabulary of roughly 250 words. The vendor claims recognition accuracy in excess of 99%; with an optional vocal response unit, the user should be able to ensure that all input is correct before it's passed on to the host computer.

In addition to accepting spoken input from locally connected microphones,



the terminal can accept input from remote sources, such as a telephone caller. Audio response, generated on a Votrax speech synthesizer, can acknowledge inputs. The Voice Terminal's controller, itself a Data General Nova mini, can be programmed to take any of a variety of actions in response to an input. It could output an ASCII character, or string, over its 20mA current loop or RS232 interface. Or, it could execute or initiate an applications program.

A basic Voice Terminal, consisting of controller, one work station, one asynchronous output interface, and support software, sells for \$18,750. A larger, four user Voice Terminal, with visual feedback, is priced in the \$45,000 neighborhood. Audio response adds \$4,275 per channel. INTERSTATE ELECTRONICS CORP., Anaheim, Calif.

FOR COPY CIRCLE 434 ON READER CARD

## Miniature Winchester Disc

Last month saw the introduction of several Winchester discs directed at oem's currently using floppies. The IMI-7710

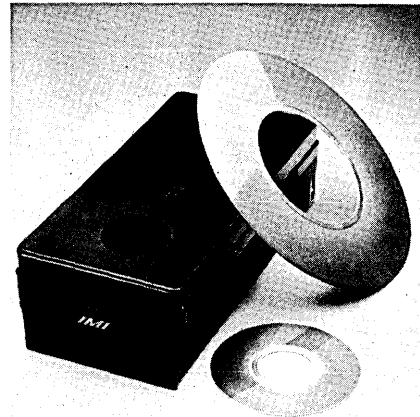

mini-Winchester Storage System goes the floppy replacement market one better by packaging a Winchester disc drive in a 5x8 1/2-inch package said to fit in the same space required for standard floppy drives. Initial offerings will be 11MB and 24MB units, with 43MB and 75MB units expected next year.

A pair of 200mm (a shade under eight inches) diameter discs provide the storage medium in both units. Three surfaces store data, while the fourth, bottommost surface contains servo tracks. The 11MB version uses 350 tracks per surface, spaced at 300tpi. Its 3600rpm rotational speed yields an average latency of 8.3msec. Average access time is quoted at 50msec, with track-to-track movements speeded at 10msec. Data transfer occurs at 648Kbps.

The 1,000 unit price for the 11MB unit is \$1,470. The vendor offers a controller which interfaces to the IEEE-488 bus for \$735, in the same quantities. Oem's will also need to add a 100-watt power supply. Evaluation units should be available now, with formal production scheduled to commence October 1. INTERNATIONAL MEMORIES, INC., Cupertino, Calif.

FOR COPY CIRCLE 436 ON READER CARD

## Packet Switched Communications

As a remote computing service, this vendor felt the need for a more effective way for its customers to access its computers. To that end, the vendor developed a pair of X.25 packet switched communications processors; after development, the vendor found it had a marketable set of products on its hands. The LSI-X.25 Front End Processor provides packet switching support to DEC's PDP-11 family. It interfaces to the communications network via synchronous channels operating at speeds of up to 9600bps. The Front End, itself



# SAS can't give you a bigger staff...

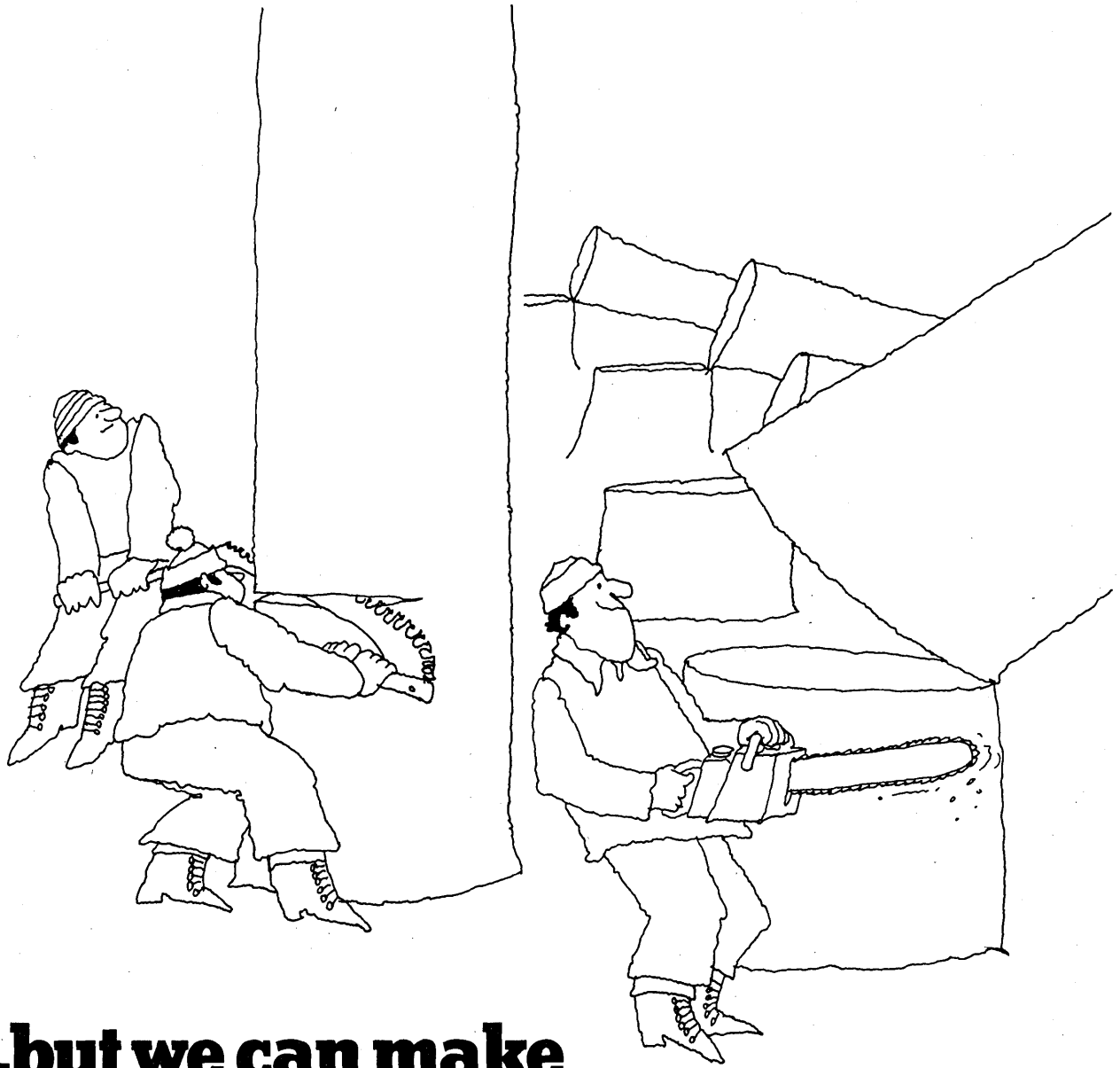

## ..but we can make the one you have more productive.

It would be nice if you had two DP staffs. One for the regular work, and one for the special requests. But chances are you don't. So you need SAS.

SAS puts all the data analysis tools you need for most jobs into one software system. And your staff won't have to master a complicated language to use it. With a few simple commands SAS handles

retrieval, data management, statistical analysis and report writing.

That means one person with SAS can handle those special requests in hours or minutes ... even jobs that might take days using conventional methods.

Users are now proving that it works at more than 500 IBM 360/370 OS computer sites. Those users have named SAS

to the Datapro Honor Roll for the second consecutive year. And SAS costs less than you might think.

Write or call for a free booklet. We can't give you more people ... but we can help you get the most out of the ones you have.

**SAS** SAS Institute Inc.  
P.O. Box 10066  
Raleigh, NC 27605  
919/834-4381

So you want  
a visual  
medium—  
but not the  
high cost of  
reading it!



Introducing  
**CODE 39**,  
an alphanumeric  
bar code with  
exceptional  
data integrity.

To track, trace or count, why opt for OCR when bar code has so many more advantages? Inherent advantages like higher accuracy and faster, easier reading. And lower cost! Bar code readers cost significantly less than OCR readers.

Because Code 39 is alphanumeric, it easily conforms to existing systems or data bases. Bar code data is inexpensively produced by letterpress, offset printing, and a variety of computer controlled terminals, including Intermec printers.

#### Typical Applications

- Inventory Control
- Wholesale Distribution
- Manufacturing
- Hospital Systems
- Libraries

Write or call for more information.  
Interface Mechanisms, Inc.,  
P.O. Box N, Lynnwood, WA 98036  
Phone (206) 743-7036

**INTERMEC**®

CIRCLE 154 ON READER CARD

## hardware

### product spotlight

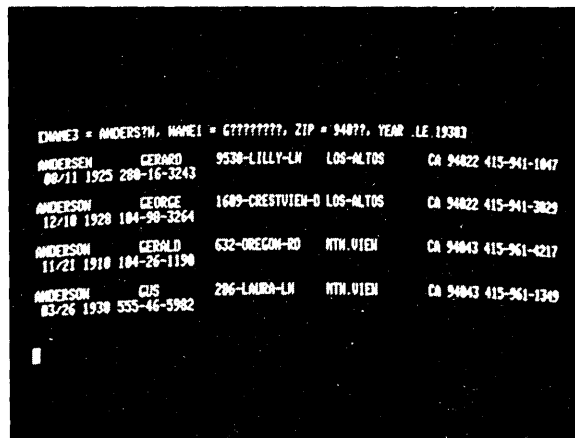

#### Associative Memory

Semionics Associates, subject of a news story in March (p. 206), has indeed entered the market with an associative (or content addressable) memory. Apparently plans have changed some since March; the \$11,000 system described in the news story has been shoved to a back burner, and the firm has introduced bare 8KB S-100-compatible boards.

The associative memory, or Recognition Memory (REM), can access data by content, tagging each location containing the specified value. The tagged locations then may be read out or modified. The REM can perform multiwrite operations on different locations in parallel. In addition to these somewhat exotic capabilities, the static board can be accessed by address, as conventional memory.

Organized as eight-bit words, and

256-word REM records, a random access (by address) takes 200nsec, while 4msec are required for either a recognize or multiwrite operation for all REM records. Since the boards operate in parallel, access time does not increase as REM capacity increases; it remains fixed.

The S-100 bus microcomputer accesses REM's content addressing functions through the micro's standard write instruction. The REM can be told to recognize three relationships: equal, greater than or equal, and less than or equal. It can then be told to perform a multiwrite or to read the responders (those records meeting the selection criteria). The photograph shows the result of a search on several fields; the question marks "don't care" characters. REM boards (8KB) sell for \$525. SEMIONICS ASSOCIATES, Berkeley, Calif.

FOR COPY CIRCLE 438 ON READER CARD

an LSI-11/03, transfers messages to and from the host PDP-11 by direct memory access. X.25 network software and the Interactive Terminal Interface (ITI) for DEC's RSTS and RSX operating systems are included in the Front End Processor. A 32KB Front End sells for \$15,800, a 64KB unit goes for \$16,800.

The vendor's second offering in its X.25 product line is an Intelligent Concentrator. In its largest configuration it can handle 32 asynchronous terminals, concentrating traffic onto synchronous lines. In addition to X.25 conversion, the concentrator can perform other functions, including local editing, screen formatting, and character code conversions. Pricing on the user-programmable concentrator is not firm at this time, although a four-port model is expected to be priced in the \$7,500 range, and an eight-port version around \$10,000. Deliveries on both the Front End Processor and Intelligent Concentrator are quoted at 90 days; all prices are given in Canadian dollars. CABLESHARE LTD., London, Ontario, Canada. FOR COPY CIRCLE 435 ON READER CARD

#### Color Personal Computer

This manufacturer has decided to enter the burgeoning personal computer marketplace. Its CompuColor II family consists of five machines, each with a 13-inch color crt screen, keyboard,

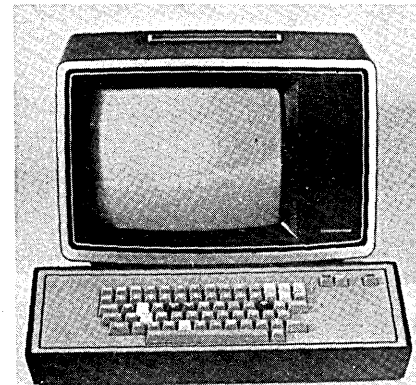

minifloppy drive, and 8080A-based microcomputer. The units differ in read/write memory (ranging from 4KB to 16KB), screen formatting (either 16 or 32 lines of 64 characters), and graphics support. An optional RS232 port pro-

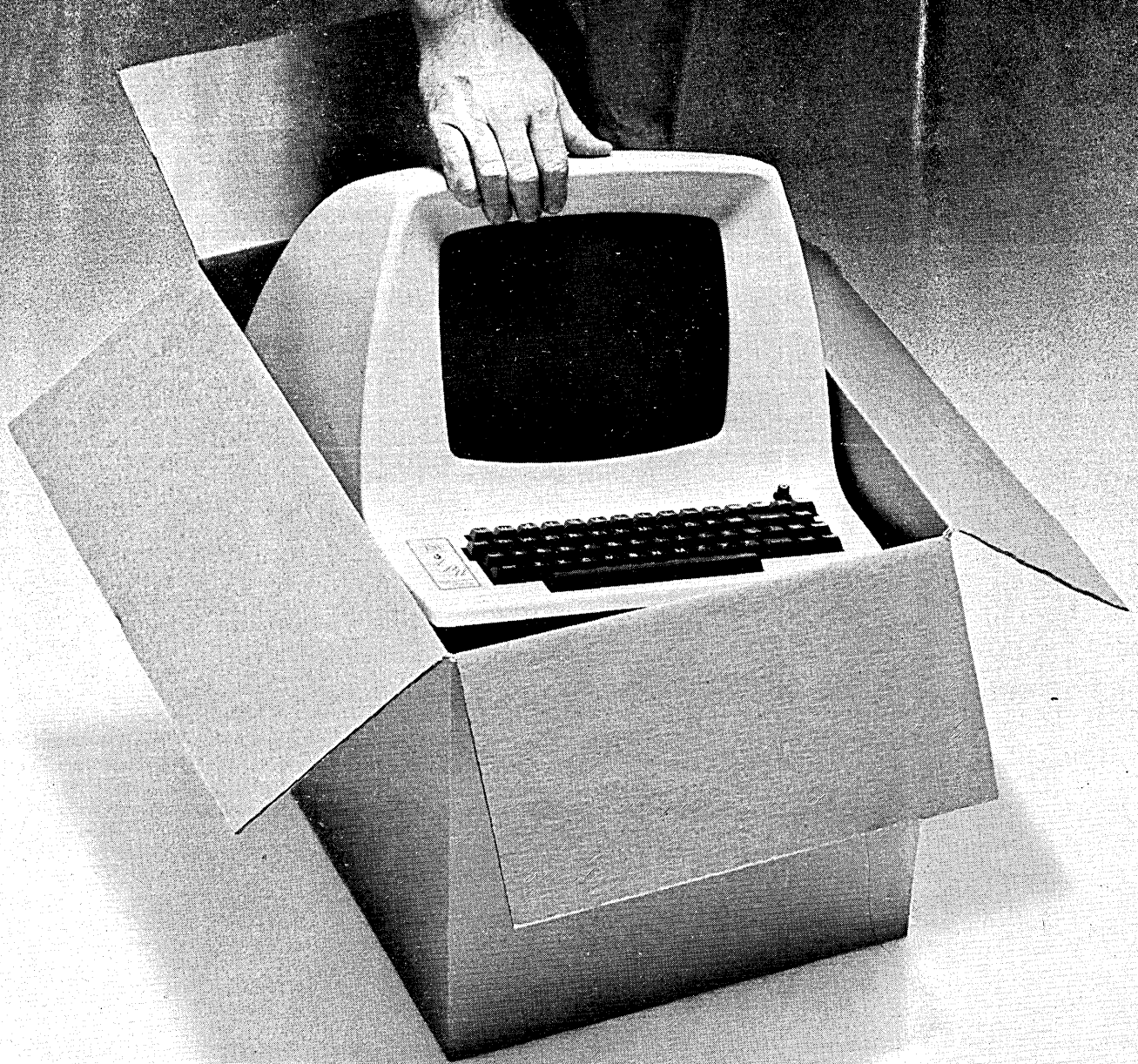

## Every 5½ minutes, the world gets a little Dumber.

That's how often we get another Dumb Terminal™ customer for our world famous Dumb Terminal. We've sold over 30,000 of them in three short years.

No wonder.

For just \$895, you get a 12-inch diagonal screen. Full or half duplex operation at 11 selectable data rates.

1920 easy-to-read characters in 24 rows of 80 letters. A typewriter-style keyboard with 59 entry keys. RS232C interface extension port. Direct cursor addressing. Plus options galore.

So when you consider those features and that price, it's easy to see why our Dumb sales have gone bananas.

**DUMB TERMINAL.  
SMART BUY.**



LEAR SIEGLER, INC.  
ELECTRONIC INSTRUMENTATION DIVISION  
DATA PRODUCTS

Lear Siegler, Inc./E.I.D., Data Products, 714 Brookhurst Street, Anaheim, CA 92803; (800) 854-3805. In California (714) 774-1010.

CIRCLE 53 ON READER CARD

# hardware

vides communications capabilities or the attachment of a printer. The units are programmable in an extended BASIC, which includes PEEK and POKE operations, string manipulation, and file support. Both the BASIC interpreter and proprietary operating system are kept in ROM. The vendor also offers applications packages on diskettes. These include biorhythms, blackjack, checkers, chess, math tutor, Othello, and payroll for 100 employees. At the low end of the line, a Compucolor II

model 1 with 4KB and a 16-line screen, carries a suggested retail price of \$795. A full-blown model 5, with 16KB, graphics, expanded keyboard, and 32-line screen has a suggested price of \$1,995. The vendor is currently setting up a dealer network. Deliveries are quoted at 90 days. COMPUCOLOR CORP., Norcross, Ga.

FOR COPY CIRCLE 433 ON READER CARD

## Computer Systems

New, faster processors with extended instruction sets including microcoded extended-precision and scientific functions, 350nsec memory, a new operating system, and device-independent graphics software mark the latest addi-

tions to this vendor's 1000 series computer systems. The F-series processor, technically a member of the 21MX family, though the vendor now eschews the 21MX name, is said to be up to 26-times faster than the M-series processor. For instance, its extended instruction set allows it to perform a sine function in 47.6msec compared to roughly 300msec required by a software subroutine. F-series processors support up to 2MB of 350nsec error-correcting memory built of 16Kbit RAM's; the concurrently announced RTE-IV operating system allows FORTRAN programs to manipulate arrays as large as 2MB. The Graphics/1000 package offers one level of support for casual users, and another for sophisticated graphics applications. The package automatically formats (or reformats) output for display on the 2648A raster-scan terminal, 7425A thermal printer-plotter, or 9872A four-color graphics plotter.

The series 1000 model 25, a memory-based system, starts at \$27,500, with an F-series processor, 64KB or 350nsec memory, and a 2645 console terminal. It uses the RTE-M operating system. The models 40 and 45 are disc-based systems which use RTE-IV. The model 40 uses the existing E-series processor. Its pricing starts at \$40,000, and includes 128KB of memory, 20MB disc, and a 2645 terminal. The top-of-the-line model 45 starts at \$46,500, with a 128KB F-series processor, 20MB disc, 2648 graphics terminal, and the Graphics/1000 package. All three can process programs written in FORTRAN IV, BASIC, and assembler, in a multiterminal, multilanguage environment. Graphics/1000, standard on the model 45, can be had for \$500. HEWLETT-PACKARD CO., Palo Alto, Calif.

FOR COPY CIRCLE 428 ON READER CARD

## Terminals

The TermiNet 200 line includes both KSR and RO 1200bps matrix teleprinters. The buffered units can print at up to 200cps. Common features include 1KB of buffer memory, 7x9-dot matrix character formation, impact printing, 136 print positions per line, and the ability to handle paper widths ranging from two inches to 16½ inches. Both ANSI and ECMA keyboards are offered. Data rates are switch-selectable at 10cps, 20cps, 30cps, and 120cps. rs232 and a strap-selectable 20mA or 60mA current loop interfaces are standard. The KSR version sells for \$3,325; the RO version for \$3,100. The RO version can be modified as a bidirectional printer for \$3,325. GENERAL ELECTRIC CO., Waynesboro, Va.

FOR COPY CIRCLE 429 ON READER CARD

## Color Graphics

The model 5217 color graphics display generator provides all the functions of an editing graphics terminal, except dis-

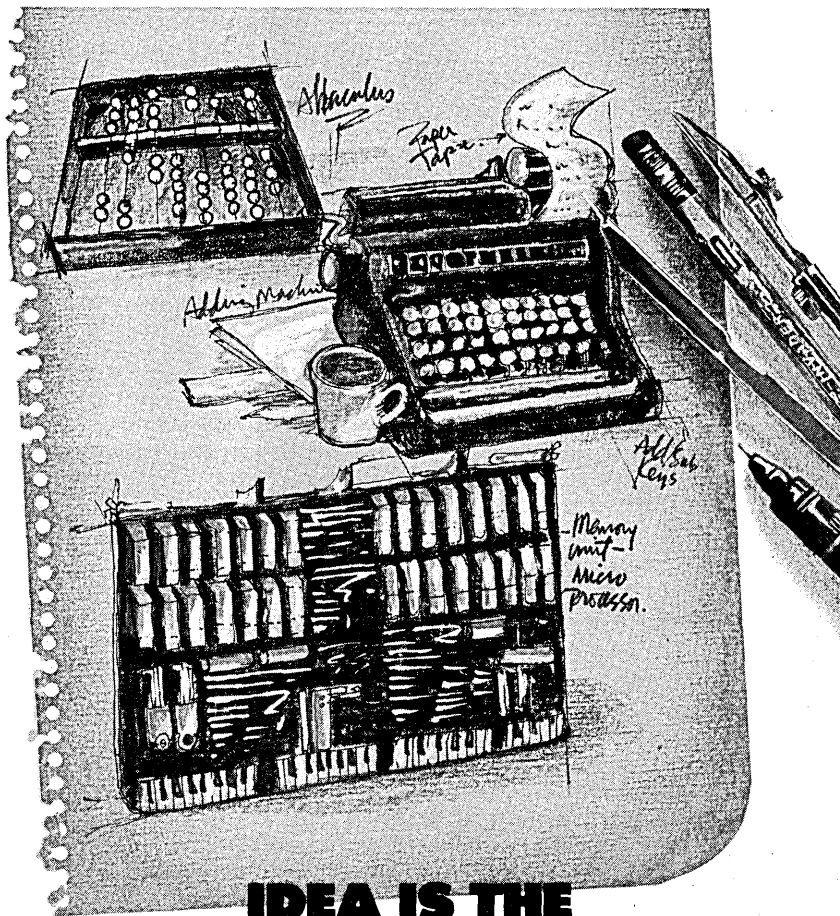

## IDEA IS THE FOUNDATION OF INNOVATION.

And innovation is our client's stock in trade. We're LRK Associates and we represent one of the top 10 employers of creative hardware and software design professionals. If your experience matches the areas below, consider initiating a professional

dialogue with us now. We can introduce you to a multitude of long-range projects and programs that will prove not only financially rewarding and professionally stimulating, but will also afford you a tremendous measure of personal pride.

### IMMEDIATE OPPORTUNITIES EXIST IN THE AREAS OF:

- Documentation Engineers
- Radar Software Development
- Simulation Design Engineers
- Mini-Computer Software Systems Design and Development
- Command & Decision Software Definition & Design
- Proposals Expertise For Large-Scale Systems
- Command and Control Software Development
- Micro-Processor Software Development
- Hardware/Software Integration
- Software Project Management
- Weapons Software Development
- Data Base Design

In The East:  
703-790-8640  
LRK Associates  
Management Consultants  
6845 Elm Street, Rm 5501  
McLean, Virginia 22101

**LRK**  
ASSOCIATES

U.S. Citizenship Required  
representing equal employment opportunity M/F/H

CIRCLE 185 ON READER CARD

In The West:  
714-848-8494  
LRK Associates  
Management Consultants  
16371 Beach Boulevard #141, Rm. 8402  
Huntington Beach, CA 92647



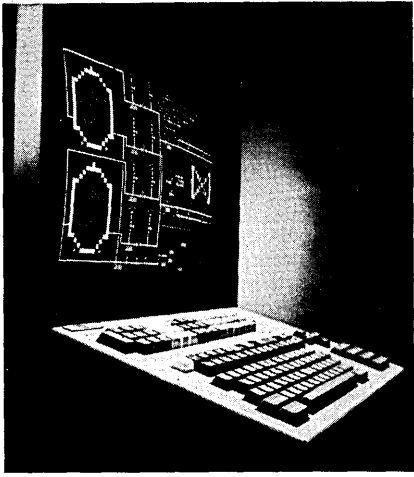

play. The user need only attach a black-and-white or color monitor to the 5217 via its RS170 composite video output jack to come up with a complete terminal. The 5217 accepts asynchronous ASCII data through an RS232 interface at rates ranging from 300bps to 25,000bps. With a display memory of 4,096x16 bits the unit can format the screen as 48 lines of either 72 or 80 characters; display memory can be expanded to four pages of 3,840 characters. Editing capabilities include insert line, character, or column, erase word, cursor control, color and attribute changes, and tabbing, controlled either by computer or operator. A single 5217 sells for \$2,995; quantity discounts are offered. AYDIN CONTROLS, Fort Washington, Penn.

FOR COPY CIRCLE 437 ON READER CARD

#### S-100 to IEEE-488 Interface

Microcomputers using the S-100 bus can interface to a variety of instruments, peripherals, and other computers using the P&T-488 interface board. Complying with the IEEE-488 standard, the interface lets the microcomputer function as talker, listener, or controller. Software, in the form of Intel mnemonic source code, is supplied on a cassette tape; the board includes an audio cassette interface. In kit form, the interface sells for \$250; assembled, it goes for \$325. Oem discounts are offered. PICKLES & TROUT, Goleta, Calif.

FOR COPY CIRCLE 430 ON READER CARD

#### Computer

Beefing up the middle of its series 90 computer family, this vendor has added the 90/40, said to be well suited for use in distributed processing networks. The 90/40 supports bisynchronous, RS232, and 2780 communications over as many as 24 lines. The 90/40, which can have memories ranging from 512KB to 1MB in 128KB increments, has a 500nsec per two-byte access time. Running under OS/3, the 90/40 can handle seven concurrent jobs; OS/3 provides I/O spooling, and job scheduling. COBOL, FORTRAN, RPG II, and assembly lan-

guage processors are included with the system. An interactive BASIC interpreter is priced separately. An entry-level processor complex with 512KB of memory, disc controller (but no drives), and a communications adapter, sells for \$304,272. On a five-year lease, this complex carries a monthly rental charge of \$7,089, including maintenance. SPERRY UNIVAC, Blue Bell, Penn.

FOR COPY CIRCLE 426 ON READER CARD

#### Communications Front End

The Attached Support Processor provides a communications front-end, with spooling, which allows this vendor's computers to communicate with IBM (or plug compatible) mainframes. Occupying three or four addresses on the main-

frame's byte multiplexor channel, the unit can simultaneously handle four phone lines, each at speeds of up to 9600bps. Use of the unit requires no modification to the mainframe's operating system; to the mainframe, the support processor appears to be a card reader/punch, or similar record-oriented device. Since the unit provides spooling, it can operate even when the mainframe is not available. An interesting feature is what the vendor calls "time-stamping." It allows the user to specify, upon job submission, a destination for the output, and how it is to be delivered: autodial, dial-in, or polling. This feature has been generalized to the point that a submitted

# IBM 360/370 USERS!

**interface your  
minicomputer  
to the IBM 360/370**

*without  
software changes*

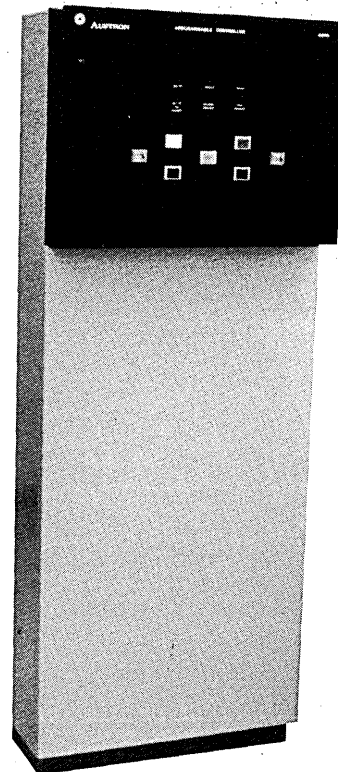

The Austron 8500 is a unique, programmable controller for the IBM 360/370 which lets you directly interface your minicomputer, terminal or other non-standard peripheral. All logic and problems associated with transferring data in and out of the IBM 360/370 are handled within the 8500.

- Allows interfacing directly to the Byte Mux, Block Mux, or Selector Channel
- General purpose, programmable processor with memory capacity up to 65K bytes
- Up to 4 interfaces with standard chassis (12 interfaces with expanded chassis)

SEND TODAY FOR DESCRIPTIVE LITERATURE

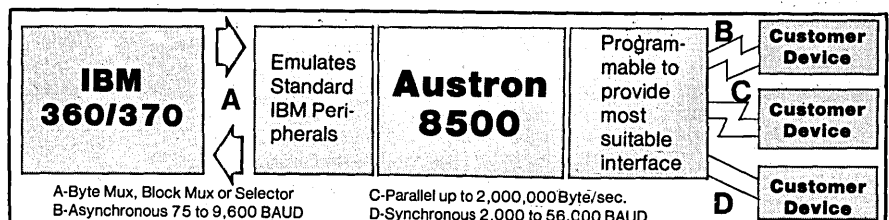

**AUSTRON INC.**  
1915 Kramer Lane, Austin, TX 78758  
Tel. (512) 836-3523

CIRCLE 137 ON READER CARD



# DASH® (DELTA AIRLINES SPECIAL HANDLING) GETS YOUR SMALL PACKAGE THERE IN A BIG HURRY.

Delta handles more over-the-counter shipments of 50 lbs. or less than any other certificated airline. What's more, DASH serves 85 U.S. cities plus San Juan. Any package up to 90 inches, width + length + height, and up to 50 pounds is acceptable. DASH packages accepted at airport ticket counters up to 30 minutes before flight time, up to 60 minutes at cargo terminals. The charge for DASH shipments between any two of Delta's domestic cities is \$30. Rate is \$25 between Dallas/Ft. Worth and Los Angeles or San Diego or San Francisco. There is an extra

charge for pick-up and delivery. For pick-up and delivery, call 800-638-7333, toll free. (In Baltimore, call 269-6393). Special DASH airbill provides speedy documentation. Special DASH bag makes identification easy. DASH shipments are prepaid.

You may pay for your shipment with cash or approved credit or an acceptable major credit card. For full details on rates and shipping information call your nearest Delta air cargo representative.

**DELTA IS READY WHEN YOU ARE®**



## From the MAS-80 family of manufacturing systems...

# MAS II for Materials Management

Building or replacing a manufacturing system? Consider our MAS-80 family. And its newest member, MAS II.

The 20 MAS II systems include functions such as **Master Production Scheduling, Material Requirements Planning, Production Scheduling, and Shop Floor Reporting.** Plus maximum **Data Base** flexibility, and the independence to use the DBMS of your choice: IMS, TOTAL, ADABAS, IDMS and others.

To learn more about all 20 MAS II systems, just return the coupon for your free MAS II brochure.

**Martin Marietta  
Data Systems** We MAS  
Build & Run  
Systems

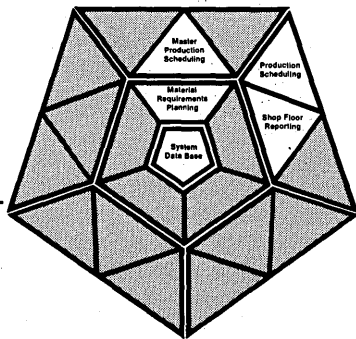

Mr. Dick Nemerson  
Martin Marietta Data Services  
300 East Joppa Road  
Baltimore, Maryland 21204

NAME \_\_\_\_\_  
CO. \_\_\_\_\_  
TITLE \_\_\_\_\_  
PHONE (    ) \_\_\_\_\_  
ADDRESS \_\_\_\_\_  
CITY \_\_\_\_\_  
STATE \_\_\_\_\_ ZIP \_\_\_\_\_

CIRCLE 159 ON READER CARD

## hardware

file need not be processed, it can simply be forwarded to another site. Time stamping also allows the user to specify when the job should run and when the output should be transmitted. An attached support processor, consisting of processor, 5MB disc, channel adapter, and all software sells for \$37,500. The same system leases for \$1,044 per month on a three year contract. DATAPOINT CORP., San Antonio, Tex.

FOR COPY CIRCLE 427 ON READER CARD

### Incremental Plotter

The Hiplot, an incremental plotter, is intended for use with microcomputers and has both an RS232 and six-line parallel TTL interface. It plots in increments of 0.005-inch or 0.01-inch, jumper selectable. Instead of accepting the endpoints of a vector to be plotted, each increment must be specified individually. The Hiplot accepts data at a

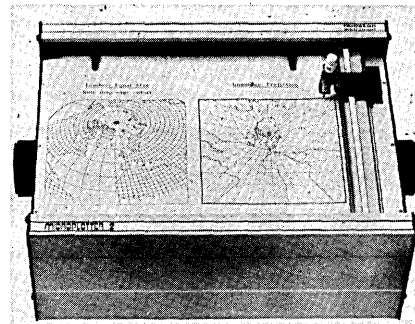

maximum rate of 2400bps. Instead of supplying software packages to drive the Hiplot, the vendor plans to organize a clearing house for user-written programs. The complete Hiplot (which is not available in kit form) sells for \$1,085. HOUSTON INSTRUMENT, Austin, Tex.

FOR COPY CIRCLE 432 ON READER CARD

### Add-on Memory

ARM-20 add-on memory for DECsystems 2040, 2050, and 2060 comes in 128K word increments, and allows memory expansion to 4M words. It's still too soon to say if the ARM-20 works with DEC's recently announced 2020, as neither memory interface specs or an installed unit is available to this vendor. The ARM-20 stores each 36-bit word with dual parity bits. Access time is 10 cpu clock cycles, or 312.5nsec with a 32MHz clock. Interleaving may be 4-, or 2-way, or noninterleaved; each 128K word block automatically configures to the highest interleaving level, unless overridden by the cpu. A 512K word ARM-20 sells for \$120,000. Domestic customer shipments begin this summer; international shipments are slated for the fall. AMPEX MEMORY PRODUCTS, El Segundo, Calif.

FOR COPY CIRCLE 431 ON READER CARD



# The Morning Sickness Bug.

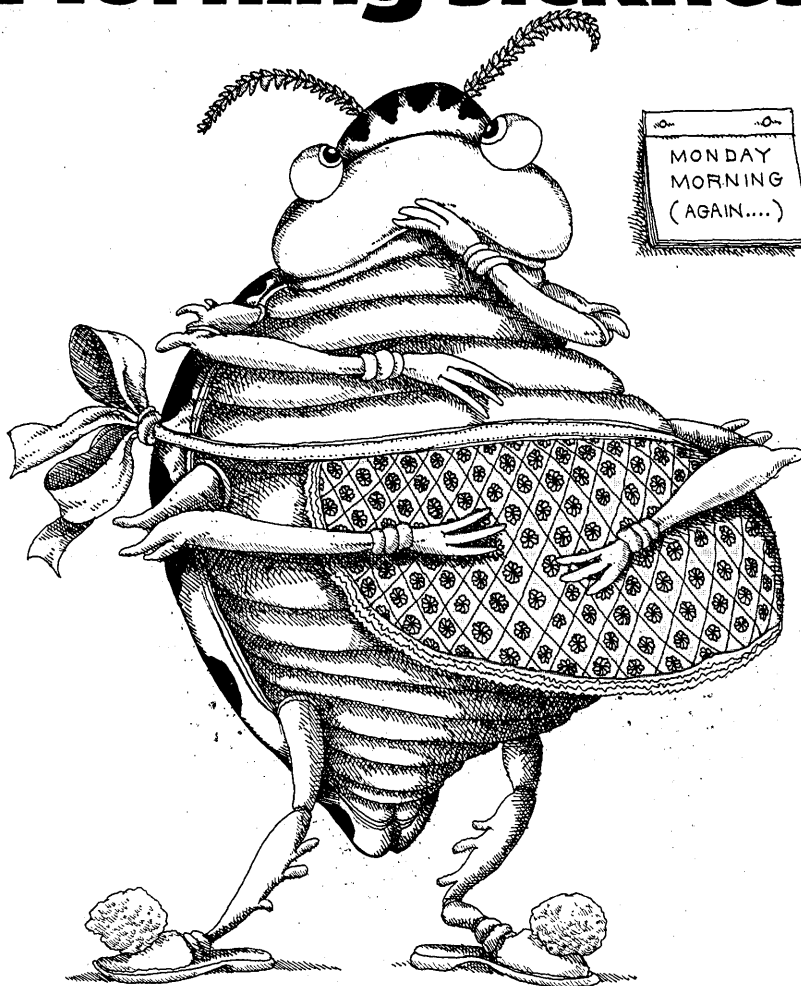

## When your computer gets it, your pocketbook hurts, too.

The Morning Sickness Bug occurs when your air conditioning system is not maintaining a precise, controlled environment. And, whether your computer is a large-scale system, or one of the mini's, it can turn out to be a costly proposition for you.

EDPAC Process Cooling Systems are specially engineered to create an exact, totally regulated environment. And they are designed specifically for

your particular requirements. With full redundancy and alarms. So you can rely on them to protect your computer as no regular air conditioning system can.

Before the Morning Sickness Bug makes you feel worse than your computer, find out what a big difference an EDPAC Process Cooling System can make. And find out today!

**FREE BOOKLET: HOW TO GET THE BUGS OUT.**

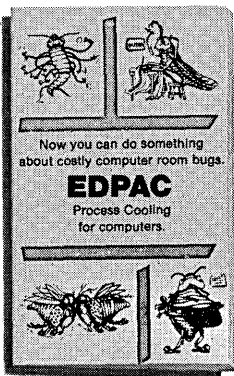

Please rush me your money saving booklet. D68

Name \_\_\_\_\_

Title \_\_\_\_\_

Company \_\_\_\_\_

Address \_\_\_\_\_

City \_\_\_\_\_ State \_\_\_\_\_

Phone \_\_\_\_\_

Mail to: EDPAC, AC Manufacturing Company,  
Cherry Hill, N.J. 08034 • 609/428-9800

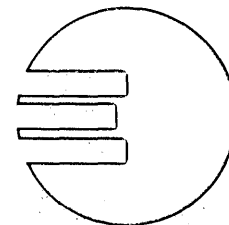

# EDPAC

ENERGY EFFICIENT PROCESS COOLING  
FOR COMPUTERS

EDPAC is a product of AC Manufacturing Company

**Tom, Dick  
and Harriet  
have one thing  
in common.**

# They're all coming to Interface West.

## Tom is a business executive.

The company he founded five years ago had no need for automated business procedures. Manual was fine. Now things are different. Business is growing, and so is the need for controls. Tom knows he can get those controls and lower his costs by using a small computer, word processing, telecommunications, facsimile, micrographic or other "here today" system, software package or service. He has many alternatives, some of which may be better for him than others. That's why he and others within his company are coming to Interface West. To discuss these products with exhibitors. And to learn about their use.

## Dick is an engineer.

While in college, he used his school's timesharing terminal and FORTRAN to design analog control circuits with discrete components. Today he uses his company's microcomputer development system to design digital interface circuits with microprocessors and LSI. Dick realizes that today's designer must be as adept with software as with hardware. That's why he's coming to Interface West, and why he's taking his staff with him. Interface West is where hardware people learn software and software people learn hardware. It's where they find the micro development tools that can save them time and money.

## Harriet is an information systems manager.

She and her staff work for a large corporation with a centralized EDP system. Now the company is moving into data communications. Harriet realizes she needs to know about the latest datacomm concepts. That's why she's coming to Interface West. What she learns there about networking strategies, distributed data processing, terminals, software, and communications services will help her make better decisions. Members of her staff plus the company treasurer will also be coming to Interface West. They may require training in data communications. They, too, need to see, on the exhibit floor, what different datacomm system, equipment and service suppliers offer.

## Everybody's Coming to Interface West

November 14-16, 1978 • Los Angeles Convention Center • Los Angeles, California  
For information, call toll-free (800) 225-4620. In Massachusetts, (617) 879-4502.

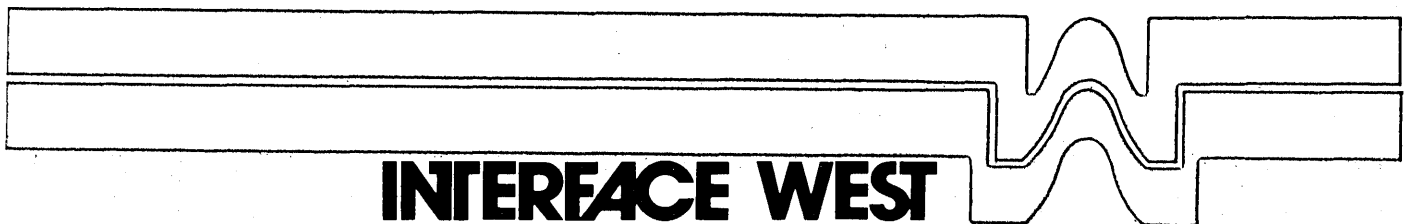

# INTERFACE WEST

Co-Sponsored by **DATAMATION** Magazine

# software & services

## Updates

Protecting authors' rights to software continues to be a hot button. CONTU proposes using copyrights, while others prefer the protection of patents. Those preferring patents should keep their eyes on the case of Parker vs. Flook, currently before the Supreme Court. Lutrelle F. Parker, acting commissioner of patents and trademarks, challenges the system of patenting software. CBEMA, the manufacturers' industry organization, has filed an amicus curiae supporting Parker's challenge, while ADAPSO, the dp services industry group, and several software vendors have filed amicus curiae briefs supporting Flook's right to a patent. Applied Data Research, which holds the first software patent issued, is among the software vendors supporting Flook. ADR states it "is a manufacturer of special-purpose computers created by using ADR software with standard general-purpose computers available from hardware manufacturers such as IBM." Its brief describes specific software machines, and how these could be implemented in hardware were it not for the associated high cost and rigidity of special purpose hardware.

Prophet, a biomedical research information handling system developed by Bolt Beranek and Newman, will undergo a further three years of refinement and development under the auspices of the National Institutes of Health. The system, which NIH initially commissioned in 1968 and became operational in 1972, includes graphics capabilities, and has been used by researchers nationwide to investigate chemical/biological relationships connected with heart and lung diseases, hypertension, kidney failure, alcoholism, and cancer. Dr. Martin A. Apple, who heads a Univ. of California at San Francisco cancer research team that recently announced a new cancer drug, is quoted in an AP story as saying, "An average day of Prophet study is often more useful than a year or two of trial and error in the lab."

Computer Facilities Software Ltd., of West Yorkshire, England, will provide its NEAT/3 to COBOL 74 conversion package, NECOL, to an unnamed Dutch electronics company for the conversion of 110,000 lines of NEAT/3.

## 3800 Printer Software

Two field developed programs provide users of IBM's 3800 printing subsystem with additional capabilities. The Business Graphing on the IBM 3800 Assembler Module interfaces to applications programs written in assembler, COBOL, and PL/1, providing plotting capabilities with 24-point-per-inch (horizontal and vertical) resolution. The module accepts a list of points and formats them for printing on the 3800. "Until now, the printing and integration of business graphs and charts into reports have not been practical." We wonder what the electrostatic printer/plotter people have been doing for the past five or so years. Still, if you're running a 135 or larger under vs1, sv3, or mv3, you can add this module for \$225 per month, with fees waived after 12 consecutive payments.

The IBM 3800 Interactive Character Design field-developed programs come in four varieties, for different environ-

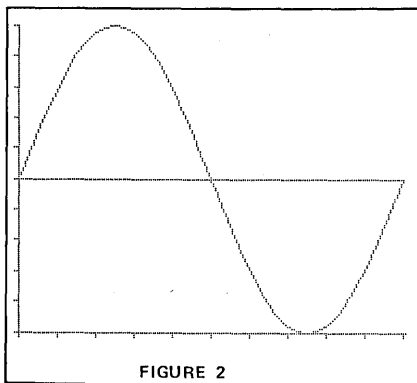

ments: ATMS-II/OS/VS; VM/370/CMS; TSO; and vSPC-OS/VS. The package provides prestructured dot matrices for each of the 3800's four standard character sizes (10, 12, 15, and 15 condensed). At a session, any number of characters may be defined, limited by the IEBIMAGE utility maximums of 64 characters per named Graphic Character Modification Module and 256 characters per Character Arrangement Table. Modules also help test characters in both standard and nonstandard arrangement table locations. Standard editing facilities, provided by the interactive operating environment selected, are used for character design. A 3270 Model 2 and 80KB of memory are needed to make full use of the system. Each of the four field developed programs carries a monthly license of \$165, which is waived after 12 consecutive payments. INTERNATIONAL BUSINESS MACHINES CORP., White Plains, N.Y.

FOR COPY CIRCLE 416 ON READER CARD

## On-Line Program Maintenance

OWL, this vendor's on-line program maintenance system, went through an interesting design cycle: after the initial specs were drawn up, the vendor brought in 21 assorted dp managers to help develop the final specs. After a five-hour presentation on OWL, the vendor spent three days letting the visiting users mold the package to fit their needs.

Currently, OWL runs with CICS in a DOS/VS environment. The vendor is expected to add support for other teleprocessing monitors and OS/VS.

OWL allows users to maintain, manipulate, and edit source programs. The system maintains an audit trail of the previous 15 revisions of any given program, if the user desires. File compression is a standard feature; the vendor claims it's so efficient that keeping a 15-level audit trail adds only 2% or so to the system's disc space requirements.

OWL provides full-screen, direct cursor editing. A moving window allows users to scan through their source files. A toggle-switch feature lets the programmer concurrently display different parts of a program, file, or report in either full- or split-screen format. A feature dubbed dynamic recall lets the user retrieve previous versions of the program, with changes highlighted. And a to-be-continued sign-off lets the user resume his work at the point where he signed off. Until July 1, the OWL package carries a price tag of \$6,450. After July 1, additional charges will be levied for the toggle-switch function, a JCL macro generator, and global scan and replace capability. NATIONAL COMPUTING INDUSTRIES, Atlanta, Ga.

FOR COPY CIRCLE 417 ON READER CARD

## Packet Switched Service

On July 1 this vendor will initiate a packet switched data service between the U.S. and the United Kingdom. The service will support low speed asynchronous terminals operating at rates from 110bps to 1200bps; additionally, it will handle synchronous transmissions at 2400bps, 4800bps, and 9600bps. The service adheres to CCITT recommendation X.25. U.S. customers will be able to gain access to the transatlantic link through the telephone network, on through value added carriers, such as Telenet and Tymnet. Customers also may interconnect directly at the vendor's international data exchange in its New York gateway. The service has yet to receive tariff approval in the U.S., but a look at the British Post Office's rate structure may give some feeling for



# IMS and TOTAL USERS

## YOUR DATA BASE & ASI-ST GO TOGETHER

More IMS and TOTAL installations have chosen the ASI-ST Data Management and Reporting System to implement data base applications than any other product. ASI-ST's dominance in data base environments is easily explained:

- Operates under all IBM 360/370 versions of DOS, DOS/VS, OS and OS/VS.
- Fully supports all TOTAL, IMS and DL/1 features including TOTAL 7 and secondary indexing under IMS/VS.
- Permits creating and updating TOTAL and IMS data bases as well as retrieval.
- Allows concurrent processing of conventional data files with IMS or TOTAL data bases.
- Supported in both batch and on-line environments.

IMS users such as *American Airlines, Dow Chemical, TWA, American Can, The Hartford, Union Carbide;* and TOTAL users like *Combustion Engineering, Northwestern Mutual Life, Anheuser-Busch, Corning Glass Works, Eli Lilly and Holiday Inns* are a few who agree ASI-ST and data base belong together. In addition, ASI-ST provides an unequalled return on investment by maximizing the productivity of both man and machine. Since ASI-ST fully supports conventional data files as well as complex data bases, these benefits are not restricted to IMS and TOTAL users. To obtain more information contact:



The Software Manufacturer

APPLICATIONS SOFTWARE, INC.  
Corporate Offices  
21515 Hawthorne Boulevard  
Torrance, California 90503  
(213) 542-4381

## Software & Services

where the final rates will lie. The BPO charges an annual rate, ranging from £300 for a 300bps operation up to £850 for 9600bps use. Additionally, it charges £6 for each connect hour (rounded to the nearest minute), and £4 for every 1,000 segments (64 bytes, or half a packet). RCA GLOBAL COMMUNICATIONS, INC., New York, N.Y.

FOR COPY CIRCLE 419 ON READER CARD

### Design Methodology

Systemacs is a software design implementation methodology, comprising a written design philosophy, software, checklists, and techniques. The methodology covers an information system's life cycle—requirements, analysis, specifications, programming, and maintenance. In this life cycle, a set of milestones are defined along with what items should physically be deliverable as each milestone passes. Central to the program development phase is a "standard computer job" written in structured ANS COBOL. Actually a skeletal program, the standard computer job can help enforce a dp department's standard practices; it also aids in maintenance by giving all applications programs the same general structure. Systemacs has been brought up on IBM 360s and 370s, as well as Univac's 1100

## software spotlight

### Electronic Mail

COMET (CComputer MESSage Transmission) runs on PDP-11s and provides composing, editing, sending, receiving, forwarding, and message distribution functions. The package can also file messages for later retrieval by subject, date, sender, recipients, or unique message identification code. Sitting at a terminal, the user can compose and edit messages. The completed message can then be sent to an individual or to a group; COMET can handle distribution lists, so the author can easily send the message to the "sales dept." or "exempt personnel." On the receiving end, a user can scan through mail, getting only summary information consisting of author, date, and subject. Any or all

series. The vendor says its software components should run on any machine with an ANS COBOL compiler. The package is available in three phases, with the entire Systemacs package going for \$30,000. MANAGEMENT AND COMPUTER SERVICES INC., Valley Forge, Penn.

FOR COPY CIRCLE 423 ON READER CARD

messages can be called up for reading. And, if a reply is in order, COMET will automatically supply the address and a reference to the original message. COMET will run under RSX-11M on PDP-11/34s and up. Two 14MB RKO6 discs and 80K words of memory are required. COMET sells for \$40,000; maintenance is \$350 per month. An optional software interface is available to link the COMET system to packet switched communications networks conforming to CCITT recommendation X.25. For firms that don't want or need their own in-house systems, COMET is available as a service on the vendor's system (accessible over Telenet). The service is priced at \$50 per individual subscriber, plus \$100 per billable account per month. Usage above seven connect hours per month and storage of 500 messages is priced at \$7 per hour and 2¢ per message per month. COMPUTER CORP. OF AMERICA, Cambridge, Mass.

FOR COPY CIRCLE 422 ON READER CARD

### APL Graphics

An APL graphics package provides users of this vendor's remote computing service with a tool for two- and three-dimensional line drawing on a variety of terminal devices including crt's, teleprinters, and plotters. The package allows an object (picture), text string, or transform to be handled similarly to APL

### Programmer

Sperry Flight Systems is the Phoenix based International leader in automatic Flight Control Systems and Avionics for aircraft and space vehicles.

Currently we need a professional in our Information Systems Division.

### Univac SYSTEMS SOFTWARE Programmer

Senior Systems Programmer responsible for Univac 1100 series executive System "EXEC" using Univac assembler language or "PLUS". We require a degree plus 2 years experience with Univac Systems Software.

Our system is a new large scale Univac 1100-40.

Our Information Systems environment offers an atmosphere for professional development in a growing organization.

Peripherals include medical and dental insurance, tuition refund and a stock plan.

For further information please send a resume including salary information to, Charles E. Melker, Professional Placement at:

**SPERRY**  
FLIGHT SYSTEMS  
P.O. Box 21111  
Phoenix, Arizona 85036  
Equal Opportunity Employer

CIRCLE 190 ON READER CARD

## Even Webster's Knows About QUEST

**QUEST** (kwest). v. 1. To make a search; to go on a quest.

**QUEST SYSTEMS, INC.** n. 1. A corporation founded in 1968. 2. The largest professional recruitment firm in the U.S. functioning solely in the computer sciences; its client companies pay all employment fees, interviewing and relocation expenses. Quest is known for its deep personal commitment to relate to each candidate as an individual with individual goals. 3. Its professional staff averages over 6 years of experience in EDP recruiting (additionally, staff members have direct hands-on experience in programming, systems, hardware sales, etc.) 4. Quest is presently searching for programmers and analysts (commercial, scientific, systems software) for over 3,500 client companies in the U.S. Quest has openings in over 700 U.S. towns and cities. 5. Methodology — see Questsystem.

**QUESTSYSTEM** (kwest sis'tem). n. 1. Discussing with an individual what he would like to be doing in light of what he has been doing. 2. Analyzing the realities of his objectives as they relate to the current job marketplace. 3. Contacting client companies and other Quest staff personnel to identify positions of possible interest. 4. Introducing the job candidate to his prospective employers by providing complete details to each about the other, ensuring the efficacious use of everyone's time. 5. Arranging interviews. 6. If employment offers are extended, Quest assists in evaluating the responsibilities, compensation and opportunities (and relates those to the initially stated objectives). The Questsystem has been working for thousands of professionals at no expense, whatsoever. Ask your friends of their past dealings with Quest. Then, put the Questsystem to work for you. For additional information on this subject, please inquire directly to Quest Systems, Inc. (All inquiries/resumes received will be responded to immediately and in confidence.)

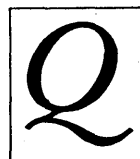

Call Toll Free

(800) 821-7700, Ext. 114

**QUEST SYSTEMS INC.**

6400 Goldsboro Road

Washington, D. C. 20034 (301) 229-4200

Baltimore: (301) 788-3500 • Philadelphia: (215) 667-3322

CIRCLE 186 ON READER CARD

scalars, allowing simultaneous creation or manipulation of entire sets of objects. Excluding terminal drivers and utility functions, the system's capabilities fall into three classes. Transform, object, and string generators build the graphics structures used by the package. Transform applicators provide functions such as scaling, translation, rotation, clipping, and changing pens or type fonts. APL-like functions manipulate graphic data structures analogously to standard APL functions. The

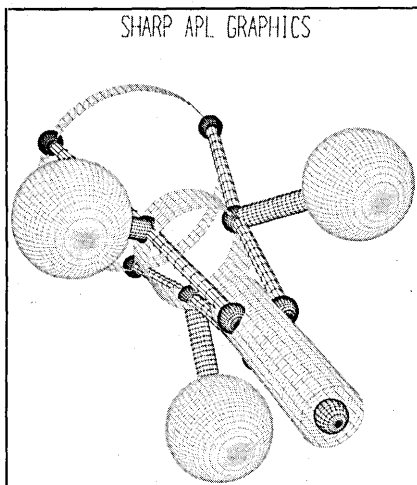

package is accessible on the vendor's time-sharing system, which is connected to Telenet, Tymnet, and the vendor's own communications service, making it available worldwide. The diagram shown, originally in four colors, is said to have incurred charges of roughly \$50, not including the processing needed to calculate and remove hidden lines. I.P. SHARP ASSOCIATES LTD., Toronto, Ontario, Canada.  
**FOR COPY CIRCLE 421 ON READER CARD**

#### Microcomputer Cobol

COBOL-80 continues the trend of bringing well-known big-machine languages to the world of microcomputers. It runs on 8080, 8085, and Z-80 micros under CP/M or ISIS-II. The compiler adheres to the 1974 ANSI standard, supporting all level 1 features and many level 2 options for the nucleus. Sequential, relative, and indexed file handling is supported, as are level 1 table handling, library, and interprogram communications. The level 2 verbs STRING, UNSTRING, COMPUTE, SEARCH, and PERFORM (varying/until) are available to programmers. The compiler conserves floppy disc space by using a packed decimal representation. The COBOL-80 system comprises two packages: the compiler, which generates relocatable object code, and a runtime support package. The system is said to run in less than 32KB of memory, compiling at a rate of 250 statements per minute. The package sells for \$750. MICROSOFT, Albuquerque, N.M.

**FOR COPY CIRCLE 424 ON READER CARD**

## COLORADO

### Computer Science Professionals

The Solar Energy Research Institute, located in Golden, Colorado is a private research institute charged with expediting commercial applications of solar energy.

To meet this responsibility, SERI is seeking programmers and analysts to assist in the development of a comprehensive solar energy information bank. Successful candidates will have designed and/or implemented on-line information data base applications utilizing relational or inverted file DBMS's such as: ADABAS, BASIS, SPIRES, or SYSTEM 2000.

Opportunities also exist for analytical applications programmer/analysts, communication analysts and systems administrators. These positions require an appropriate Bachelors degree and relevant experience in a technical or scientific atmosphere.

SERI offers competitive salaries and excellent benefits, including dental coverage and relocation assistance.

For immediate consideration, send a detailed resume (no phone calls) including salary history and professional references to:

Mr. J. J. Yacovella, Personnel Services  
**THE SOLAR ENERGY RESEARCH INSTITUTE**  
 A Division of Midwest Research Institute  
 1536 Cole Boulevard  
 Golden, Colorado 80401

We are an equal opportunity employer m/f

CIRCLE 188 ON READER CARD

## EDP SPECIALISTS

### career search opportunities \$22,000-\$50,000

**TECH SERVICES MGR. to \$35,000.** Prom int'l corp seeks individ to assist Corp Data Center Mgr in large scale 370/OS/MVS installation. Client in process of installing worldwide tele-communications network. Tremendous benefit package & promotional opportunities. Refer S.B.

**ASST DIR. MIS to \$32,000.** Maj NE mfr client req's MIS pro to assist & soon replace Director in Technical & Administrative support of world-wide installations. 50% int'l travel. Mfg bkgd a plus but not nec. Refer R.M.

**DIRECTOR, DP to \$32,000.** Apparel mfr seeks "self-starter" exp in operations, programming & design to manage staff of 28 for IDMS pro. Refer J.B.

**SOFTWARE DEV. \$25-35,000.** Desirable Fla loc. Design & develop of call process software for digital telephone switch. Excell benefits & progression. Refer R.S.

**EDP to \$30,000+.** Sunbelt. Numerous openings for Programmer, Programmer Analyst, Technical Support, Systems Analyst & all related mgmt. Most operating environments needed. Refer J.S.

**EDP AUDIT SUPERVISOR \$25-27,000.** Fortune "200" mfg corp seeks auditor to estab & manage their internal controls effort. Degree + exp in EDP audit req'd. Suburban location. Refer A.T.

**SYSTEMS ANALYSTS \$22-24,000.** Recruiting for two leading financ inst. Prefer exp in COBOL/ALC in large scale IBM 370 DOS/OS environ. Refer R.N.

**ANALYST SENIOR \$22,000.** Progressive NJ Chemical/Pharmaceutical co. seeks indiv w/Cobol/PLI exp in comm'l applications. IMS expos a +. Refer R.D.

FOR FULL DETAILS ON EACH OF THESE FEE-PAID POSITIONS,  
 CALL OR SEND RESUME TO THE RECRUITMENT SPECIALIST NEAREST YOU:

PHILADELPHIA, PA 19102—S. Burns, 1500 Chestnut St., 215/561-6300  
 ATLANTA, GA 30346—R. Spang, 47 Perimeter Center, 404/393-0933  
 BALTIMORE, MD 21204—R. Nelson, 409 Washington Avenue, 301/296-4500  
 CHARLOTTE, NC 28202—J. Schwab, 1742 Southern Nat'l Ctr., 704/375-0600  
 CLEVELAND, OH 44131—A. Thomas, 5755 Granger Road, 216/749-6030  
 FORT LEE, NJ 07024—R. Mansfield, 2125 Center Avenue, 201/947-6920  
 MCLEAN, VA 22102—G. Nugent, 7921 Jones Branch Dr., 703/790-1335  
 NEW YORK, NY 10016—W. McNichols, 605 Third Avenue, 212/697-1820  
 PITTSBURGH, PA 15222—J. Beck, 4 Gateway Center, 412/232-0410  
 PRINCETON, NJ 08540—R. Davis, 3490 U.S. Rte. 1, 609/452-8135  
 WILMINGTON, DE 19810—G. Whitwell, 3411 Silverside Rd., 302/478-5150

**FOX-MORRIS**  
 personnel consultants  
 CIRCLE 182 ON READER CARD

# The Marketplace...

## advertisers' index

### SOFTWARE MARKETPLACE

Allen Services Corporation.....	268
A.P. Publications Ltd.....	270
Applied Computer Services, Inc.....	270
Beemak Plastics.....	268
Boole & Babbage, Inc.....	269
Computer Products of America, A Division of the Computer Mart.....	269
Cyborg Systems.....	270
DASD Corporation.....	269
Dataware, Inc.....	269
Informatics Inc.....	268
Interactive Information Systems....	268
International Systems Inc.....	270
IPI.....	268
National Technical Information Service.....	270
Olympic Systems Inc.....	270
Plycom Services, Inc.....	268
System Support Software, Inc.....	269
Universal Computing Systems, Inc.....	269

### DP MARKETPLACE

American Terminal Leasing.....	270
American Used Computer Corporation.....	271
DATAMATION.....	271
S/3 Supply Company.....	271
Tone Software Corp.....	270

### BUY, SELL, LEASE

D.V.I. Co., Inc.....	271
----------------------	-----

### JOB MARKETPLACE

E.D.P. Search, Inc.....	271
ITT Rayonier Inc.....	271
National Personnel Consultants, Inc.....	271
Parker Page Associates, Inc.....	271
Systemation Consultants, Inc.....	271

the choice of 

**GENERAL HOST CORPORATION**  
*Leading Conglomerate*

**ACCOUNTING IV<sup>®</sup> GENERAL LEDGER**

Our software products—General Ledger, Accounts Receivable, Accounts Payable, and Standard Cost—are the choice of leaders like General Host...  
*not by chance, but by design.*  
For details, call (213) 887-9121.

**informatics inc**   
*World's Largest in Software Products*  
21050 Vanowen St. Canoga Pk. CA 91304

CIRCLE 212 ON READER CARD

 ALLEN SERVICES CORPORATION

**THE EXECUTOR<sup>™</sup>**  
HIGH SPEED JOB PROCESSOR

- FOR MVT, SVS, and MVS ENVIRONMENTS
- INCREASES THROUGH-PUT BY 10% TO 40%
- IMPROVES TURNAROUND TO USERS
- REDUCES OVERHEAD CPU CYCLES BY 5% TO 20%
- EXTENDS LIFE AND UTILITY OF EXISTING HARDWARE
- NO JCL CONVERSION OR MODIFICATION
- EASILY AND QUICKLY INSTALLED
- OVER 10,000,000 HOURS OF OPERATION IN OVER 150 SITES
- TECHNICAL DETAILS UPON REQUEST

**ALLEN SERVICES CORPORATION**  
212 WEST NATIONAL RD.  
VANDALIA, OHIO 45377  
(513) 890-1200

 CIRCLE 200 ON READER CARD

**BLIS/COBOL**  
MULTIUSER OPERATING SYSTEM

**makes your DG NOVA/ECLIPSE BLISsful**

*For information call today*

 **MINICOMPUTER IPI SOFTWARE**

Phone (305) 647-2200 USA  
TWX/Telex 810-853-5033  
1850 Lee Rd., Winter Park  
(Orlando), Florida 32789

CIRCLE 215 ON READER CARD

**Get Bottom Line Results From Better Manufacturing Control.**

Buy sharper, run smoother and inventory smarter. That's how to improve the bottom line in manufacturing. Management runs on information complete, current, useful data. Have it available with the Interactive Manufacturing Control System that is ready to load on any DEC PDP11 running RSTS/E right now. On-line, interactive means you can have information as you need it and allow this totally integrated system to improve your operation today. Send for our brochure. It tells how you can have the information you need to operate sharper, smoother, smarter.

Call now in Cincinnati at (513) 761-0132 or, if outside Ohio, call toll free 800-543-4613.

 **INTERACTIVE INFORMATION SYSTEMS**

P.O. Box 37403  
Cincinnati, Ohio 45222 • (513) 761-0132

A complete software system that includes MRP, BOM, Inventory Management and Shop Floor Control. If you want your "what if" questions answered, call us, we're on-line and interactive.

CIRCLE 213 ON READER CARD

**Tabcard Holders**  
For 80 col. — 51 col. — System 3 (96 col.)  
RACKS • TRAYS • ACCESSORIES

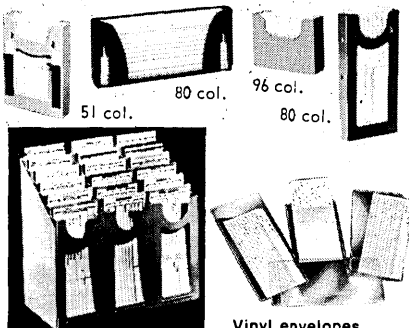

51 col. 80 col. 96 col. 80 col.

Racks made with any holder in any design or size.

Vinyl envelopes available with adhesive back or magnets. Special sizes

**BEEMAK PLASTICS**  
7424 Santa Monica Blvd.  
Los Angeles, Cal. 90046, (213) 876-1770

CIRCLE 204 ON READER CARD

**DEC RSTS/E USERS**

From one of the pioneers in commercial data processing using RSTS. Off the shelf software ready for immediate delivery. Completely interactive. Extensively documented. Fully supported. Ideal for OEM's, service bureaus or end users. Cost effective solutions including:

- ACCOUNTS PAYABLE
- GENERAL LEDGER
- FINANCIAL REPORTING
- ACCOUNTS RECEIVABLE
- PAYROLL

For complete details, contact us at:

**Plycom** services, Inc.  
P.O. Box 160  
Plymouth, IN 46563  
(219) 935-5121

CIRCLE 217 ON READER CARD

### COBOL

for  
DATA GENERAL'S MINI-COMPUTERS  
OPERATING WITH RDOS

Sequential, Random, and ISAM disk files.  
Up to 32 million bytes per disk file.  
Three levels of subscripting.  
Full editing capability.  
Up to 30 characters in data and paragraph names.  
PERFORM statements may be nested to any level.  
Conditional statements may be nested to ten levels.  
Automatic decimal place alignment.  
Automatic sign control.  
14 digit numeric accuracy for display data.  
48 bit accuracy for binary data.  
Assembler subroutines.  
5 key stand alone SORT.

Supports moving and fixed head disks, magnetic tape, cassette tape, paper tape, card readers, line printers, and consoles.

UNIVERSAL COMPUTING SYSTEMS, INC.  
P.O. Box 3597  
Evansville, IN 47734  
(812) 423-1841

CIRCLE 224 ON READER CARD

### Micro Business Software

- Complete interactive, double entry accounting system
- 51 programs with 120 pages of documentation
- Written in Northstar BASIC (other variations available)
- General ledger, accounts receivable, accounts payable, inventory and payroll
- Only 24K of memory
- Single diskette can hold 400 customer listings, 50 vendors, 400 line items of inventory, 25 employees, 60 general ledger accounts
- Only \$200.00

Send check or money order (Calif. residents add 6% sales tax) plus \$2.50 to cover postage and handling to:

Computer Products Of America  
A Division Of The Computer Mart  
633 West Yatella Avenue  
Orange, CA 92667  
(714) 633-1222  
Dealer and OEM prices upon request

CIRCLE 205 ON READER CARD

### "DISKPLAY, IT'S CHEAP AT THREE TIMES THE COST"

Diskplay graphically shows the data set layout of your disk so you know how much space you're actually using.

It shows the unused space in each data set.

It reports defective tracks and the percentage of overflow area being used.

It helps you optimize your present disks and determine when to buy new ones.

And, Diskplay costs only \$695 for DOS or DOS/VS. For a free 21-day trial, call or write us today.

**Boole & Babbage, Inc., 510 Oakmead Parkway, Sunnyvale, Ca. 94086.**  
In California: (408) 735-9550.  
Outside California dial toll free: (800) 538-1872.



**Boole & Babbage**

CIRCLE 203 ON READER CARD

## AUTOCODER/SPS to COBOL

Dataware's software translator automatically converts a high percentage of SPS/1400 Autocoder source code to ANS COBOL (DOS or OS).

The Translator converts from:

- IBM 1401
- IBM 1401 SPS
- IBM 1440
- IBM 1410
- IBM 7010

can be mixed in a single source program.

For more information on this translator, please write or call today.

**Dataware, Inc.**  
495 Delaware Street  
Tonawanda, New York 14150  
(716) 695-1412

CIRCLE 209 ON READER CARD

## PL/1 TO COBOL

Dataware's Software Translator automatically converts from IBM PL/1 to ANS COBOL (DOS or OS). The Translator is capable of handling IBM OS or DOS (48 or 60 character set) source programs as input.

For more information on this translator or the others listed below, please write or call today.

- EASYCODER/TRAN to COBOL
- BAL/ALC to COBOL
- AUTOCODER (7070) to COBOL
- COBOL to COBOL

**Dataware, Inc.**  
495 Delaware Street  
Tonawanda, New York 14150  
(716) 695-1412

CIRCLE 210 ON READER CARD

## Dataware Software Translators

### RPG to COBOL

Converts RPG and RPG II programs to the industry standard ANS COBOL (DOS or OS). The translator achieves an extremely high percentage of automatic conversion (approaching 100%) of the source code.

### RPG to PL/1

Converts RPG and RPG II programs to an optimized PL/1 (DOS or OS). The translator achieves an extremely high percentage of automatic conversion (approaching 100%) of the source code.

For more information on these and our other translators, write or call today.

**Dataware, Inc.**  
495 Delaware Street  
Tonawanda, New York 14150  
(716) 695-1412

CIRCLE 211 ON READER CARD

VSAM LOAD DLI/IMS VSAM UPDATE  
INTERNAL SORT — QUIKSORT

**C C F O O II 62** Report Writer • Database Utility  
Intelligent Utility • Mini-language  
Increase Programmer Productivity  
Reduce Turnaround Time

1977  
datapro  
HONOR  
ROLL

# Quikjob

**THE PERFORMANCE EXPANDER**  
In use by over 400 companies. Four years on "Datapro Honor Roll."

ICP Million Dollar Software Club.  
Call Mac or Bob, (513) 435-9514, send your card with this ad, or write for more details.

**VSAM RANDOM VSAM SEQNTL**  
**ISAM OTHER DATE-BASES DBOMP**  
**SYSTEM SUPPORT SOFTWARE, INC.**  
5230 Springboro Pike • Dayton, Ohio 45439

CIRCLE 219 ON READER CARD

## SOFTWARE YOU SHOULD KNOW ABOUT

**DASD CORPORATION:** I'm interested in:

**TRANSLATING**

- RPG to COBOL (DOS or OS)
- SYSTEM/3 COBOL to OS COBOL
- DOS COBOL to OS COBOL
- GE MAP to OS COBOL
- 360/20 BAL to 360/370 OS ALC
- NEAT/3 to COBOL
- AUTOCODER to OS COBOL

**TSO**

- Increasing my capabilities with TSO with Video Programming Tools. VIP simplifies the creation and modification of data files and will automatically flow-chart JCL procedures.

**CICS**

- Saving 75% of my programming BMS coding time and automatically printing hard copy screen images with MAPGEN.

**DASD CORPORATION**  
National Marketing  
1480 Renaissance Drive,  
Suite 315  
Park Ridge, Illinois 60068  
312/299-5005

**PLEASE SEND DETAILED INFORMATION TO:**

NAME \_\_\_\_\_

COMPANY \_\_\_\_\_ TITLE \_\_\_\_\_

ADDRESS \_\_\_\_\_ PHONE \_\_\_\_\_

CIRCLE 208 ON READER CARD





How do you get **Project** information to the top?

**PAC II**

Project plans and status often have a difficult time getting from front line management up through the chain of command in a timely, consistent manner. Now there is a way not to leave that information hanging in mid-air.

PAC II is an automated project management system for planning, budgeting, and monitoring virtually any work effort.

Easily installed and used, PAC II is equally applicable in research, engineering, construction, marketing, financial and data processing departments.

International System's project management systems are serving hundreds of clients world-wide.

For more details about PAC II contact:

*International Systems Inc.*



890 Valley Forge Plaza, King of Prussia, Pa. 19406  
(215) 265-1550

CIRCLE 214 ON READER CARD

**CONVERSION SOFTWARE**

Proven Software Converters, at a reasonable cost, that automatically convert between 90-100% of the Program Source Lines.

**IBM ASSEMBLER-DOS TO OS**

**ICL 1900 SERIES PLAN TO COBOL**

Please indicate interest by checking appropriate box and write or send to —



**OLYMPIC SYSTEMS INC.**  
530 6th AVENUE  
PITTSBURGH, PA. 15219 (U.S.)  
(412) 391-1538

CIRCLE 217 ON READER CARD  
**DP MARKETPLACE**

**FREE**

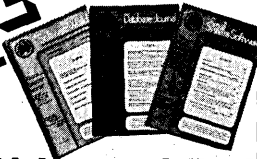

**Data booklet on specialized software information systems covering:**

- \* **GENERAL SOFTWARE**
- \* **DATABASE SOFTWARE**
- \* **MICRO & MINI SOFTWARE**

**A.P. Publications Ltd**  
322 ST. JOHN STREET · LONDON, E.C.1

CIRCLE 201 ON READER CARD

**More Programming Flexibility**  
**Generate programs in most major computer languages and run on your system**

Put the powerful RMAG21 to work for you and see how this independent computer programming device generates source language coding, data, and text for any computer language whose statements can be formed from the standard (EBCDIC) character set.

RMAG21 produces codes for languages like FORTRAN, PL/1, Assembly Language, JCL, COBOL, SNOBOL and even RMAG21's own language. RMAG21 runs on the 360 or 370 computers but it also generates programs for other computers. Now you can make target computer and language independent of the running computer!

Order RMAG21 now—PB-236 811/CPC, \$250. Please specify recording mode in tracks, density, and parity. The package includes a user's guide. Extra copies are available for convenience or for assessment of the program; order User's Guide, PB-236 812/CPC, \$4.50 each. Prices outside North American continent on request.

**NTIS** National Technical Information Service  
U.S. DEPARTMENT OF COMMERCE  
5285 Port Royal Road  
Springfield, VA 22161

For more information on this and other computer products, call the NTIS Computer Products Office (703) 557-4763. Or write NTIS.



CIRCLE 218 ON READER CARD

**SERIES/1 PROGRAMMING**

- BI-SYNC/ASYNCH/SDLC COMMUNICATIONS
- OEM DEVICE HANDLERS
- RPS SUPPORT
- COMPUTER INTERFACING
- ONLINE G/L AVAILABLE NOW
- COMPLETE BUSINESS SYSTEM UNDER DEVELOPMENT

**APPLIED COMPUTER SERVICES, INC.**

12200 SYLVAN STREET  
NORTH HOLLYWOOD, CAL. 91606  
(213) 980-1183

CIRCLE 202 ON READER CARD

**CYBORG PAYROLL SYSTEM**

The CYBORG PAYROLL/PERSONNEL SYSTEM handles multiple companies with hundreds of separate earnings and deductions. The expandable data base design allows each user to add, edit and report on as many new fields as required without any reprogramming. CYBORG provides a complete payroll system with all states, city and county taxes and complete audit and accounting reports. CYBORG has automatic check reconciliation, historical reporting, labor reports, including budget to actual comparisons with dollar and variance differences. The CYBORG REPORT LANGUAGE allows for the creation of special reports or output files (card tape or disk) to meet your unique requirements without reprogramming. The system is written entirely in ANS COBOL and will operate efficiently on IBM, Honeywell, Univac and DEC computers.

**Cyborg Systems**

2 N. Riverside Plaza, Suite 2225  
Chicago, Ill. 60606. (312) 454-1865

CIRCLE 206 ON READER CARD

**RENT IT TODAY—USE IT TOMORROW!**

"BRAND NEW"

**DECWRITER II & III**

LA36 — LS120

- ★ **MONTH-TO-MONTH LEASE**  
3-MONTH MINIMUM
- ★ **ALL OPTIONS**
- ★ **DEC MAINTENANCE**  
UPON REQUEST
- ★ **IMMEDIATE DELIVERY**

**AMERICAN TERMINAL LEASING**  
**617-261-1100**

P.O. BOX 68, KENMORE STA., BOSTON, MASS. 02215

CIRCLE 207 ON READER CARD

**DATAMATION**

**COMPU COVER**  
PAT. PEND.

**PROTECT YOUR SYSTEM FROM FAULTY SPRINKLER AND OTHER WATER LINE HAZARDS :**

**360/370, SYS 3, SYS 32**



**S/3 SUPPLY COMPANY INC.**  
P.O. BOX C  
RUTHERFORD, N.J. 07070

CIRCLE 228 ON READER CARD

**COMPUTER ROOM FLOORING and AIR CONDITIONING**

Sell us your used computer room flooring and air conditioning.

Buy our reconditioned flooring and air conditioning (ED-PAC, LIEBERT, etc.). Completely guaranteed.

**D.V.I. CO., INC.**  
P.O. Box 33  
Paoli, PA 19301  
(215) 647-4916

CIRCLE 219 ON READER CARD

**SYSTEM ANALYST**

Major pulp manufacturer is looking for a self-motivated system analyst interested in developing minicomputer based technical information systems for several U.S. and Canadian mills.

Job responsibilities center on design and installation of both hardware and software configurations to handle remote data collection, file management, and management information systems.

Qualifications include B.S. in engineering or computer science, five years industrial experience with minicomputers, willingness to travel and relocate, and the ability to communicate effectively.

Apply to: Dr. Andrew Beelik, Olympic Research Division, ITT Rayonier Inc., 409 East Harvard Avenue, Shelton, VA 98584.

ITT Rayonier is an affirmative action employer and does not discriminate because of race, religion, color, age, sex, national origin, marital status, or handicap. Minority and Female applicants are encouraged to apply.

CIRCLE 221 ON READER CARD

**DEC UPGRADE**

**PDP11 MEMORY**  
New Low Prices!

MM11L . . . . . 8K (11/05-11/10) . . . . .	\$ 750
MMR11E . . . . . 4K (Rugged 11/20) . . . . .	750
MM11K . . . . . 4K (11-Series) . . . . .	150
M F11UR . . . . . 16K & Backplane (11-Series)	2300
MM11UP . . . . . 16K (MF11UP) . . . . .	1700
M F11UR . . . . . 32K (Parity) . . . . .	4000

**VT50HA DECSCOPE . . . \$995**

**"NEW" DECWRITER II & III**  
LA36 . . . \$1495 — LS120 . . . \$2695

SEND FOR **FREE DEC LIST.** DEPT. DM  
**AMERICAN USED COMPUTER**  
**617-261-1100**  
P.O. BOX 68, KENMORE STA., BOSTON, MASS. 02215

CIRCLE 226 ON READER CARD

**JOB MARKETPLACE**

**EDP SPECIALISTS**

**SYS. ANALYSTS & PROGRAMMERS \$15,000-\$30,000.** Immed Penna & nat'l openings. Commercial & scient applic'ns. Contact WEIR PERSONNEL, (emp agcy), 535 Court, Reading, PA 19603 (215/376-8486).

**SYSTEMS ANALYSTS \$20K to \$26K.** Central Penna & nat'l openings. User interface, analyze & design mfg & financial applications. MECK ASSOC. (emp agcy) 1517 Cedar Cliff, Camp Hill, PA 17011 (717/761-4777).

**SR. PROGRAMMER ANALYSTS to \$24K.** Min of 3-4 yrs ANSI COBOL to work with team in development of on-line systems. Future plans incl CICS & VSAM. E. P. REARDON ASSOC. 888 Washington, Dedham, MA 02026 (617/329-2660).

**SYSTEMS PROGRAMMER \$18K.** San Francisco locale. 2+ yrs exp in 16-bit mini systems w/real-time. Support eng. development group. Resume to: SAN FRANCISCO PLACEMENT AGENCY, INC., 625 Market, San Francisco, CA 94105 (415/543-8600).

*all positions listed are fee-paid*

**npc** NATIONAL PERSONNEL CONSULTANTS

CIRCLE 222 ON READER CARD

**POSITIONS AVAILABLE NATIONWIDE**

**CALL TOLL FREE 800-426-0342**

**APPLICATION PROGRAMMERS . . . . . To 25K**  
IBM, CDC, Honeywell, PDP II with all types of industry experience.

**DATA BASE ADMINISTRATORS . . . . . To 28K**  
IMS, DL/1, Total experience.

**SYSTEMS PROGRAMMERS . . . . . To 30K**  
370 OS, CDC, H6000 Internals.

**SYSTEMS ENGINEERS . . . . . To 30K**  
BS or MS in Eng. Discipline.

**CAD/CAM SYSTEMS PROGRAMMERS To 30K**  
Interactive graphics, advanced NC and PDP II System Prog.

Call Bill Isgrig or forward resume to:  
**PARKER PAGE ASSOCIATES**  
P.O. Box 12308  
Seattle, WA 98111  
Offices in Washington, D.C., Chicago  
Atlanta & Portland, OR

CIRCLE 225 ON READER CARD

**"1978 MAINFRAME USER SURVEY" AVAILABLE NOW.**

A new 300 page report providing the most comprehensive analysis of the mainframe systems market has just been published by DATAMATION magazine.

This in-depth survey is a major study of EDP user buying plans and attitudes for the next two years . . . all essential data for industry analysts, planning and marketing executives as well as computer users.

Available immediately the survey is priced at \$950., \$925. if payment is enclosed with the order. Additional reports are \$200 each. For complete information contact Deborah Dweiloh (203) 661-5400.

**DATAMATION.**  
magazine

**TECHNICAL PUBLISHING COMPANY**  
A DUN & BRADSTREET COMPANY  
35 Mason St., Greenwich, Conn. 06830

CIRCLE 227 ON READER CARD

**PROGRAMMERS AND ANALYSTS**

If you are a programmer, programmer/analyst or systems analyst and would like the most individualized job search offered in the data processing field today, either on a local or national level, send your resume in confidence to:

**E.D.P. SEARCH, INC.**  
P.O. BOX 331  
HARTFORD, CONN. 06101

CIRCLE 220 ON READER CARD

**PROGRAMMERS ENGINEERS**

having systems programming/software dev exp with large 360/370 OS systems or assembly language with minicomputers are sought by major energy, mfg, systems, consulting & other quality cos having attractive software, hardware and real time applications optys. \$17-29,000. SW, SE & W.

Other client cos seek sharp business applications programmer analysts & systems analysts with financial, mfg, or energy co applications exp using Cobol, PL1, RPG. \$18-27,000. SW & SE.

Confidential contacts controlled by you. Resume to J. L. Gresham, BChE, MBA will contact you at home first. Est 1966, member AIChE. Fees paid. (713) 622-1370.

**SYSTEMATION CONSULTANTS, INC.**  
employment service  
1410 Post Oak Tower Houston, Texas 77056

CIRCLE 223 ON READER CARD

# DATACORP 72X. 690 PAGES PER FICHE. SO EFFICIENCY GOES UP, COSTS DOWN.

With Computer Output Microfilm, the fewer the fiche, the bigger the savings. And with Datacorp's 72X reduction, you can pack 690 computer printout pages per fiche—three times more than 42X can handle.

Which means lower costs, in paper or film. In storage. And labor. Also, more efficient retrieval—up to 60 percent faster than before. With less fiche changing. Less viewer platen movement. And less handling from the holder.

For one of our major clients,

using 72X saves thousands in paper. Hundreds of manhours, filing. And untold storage space, with 8,000 daily sales invoices neatly contained on just 12 fiche.

All with 72X, from Datacorp. Another innovation from the world's largest COM service network. And the world's leader, putting it to work for you.

Call us, or write. We'll prove why we're #1.

**REMEMBER DATACORP.  
WE'RE #1.**

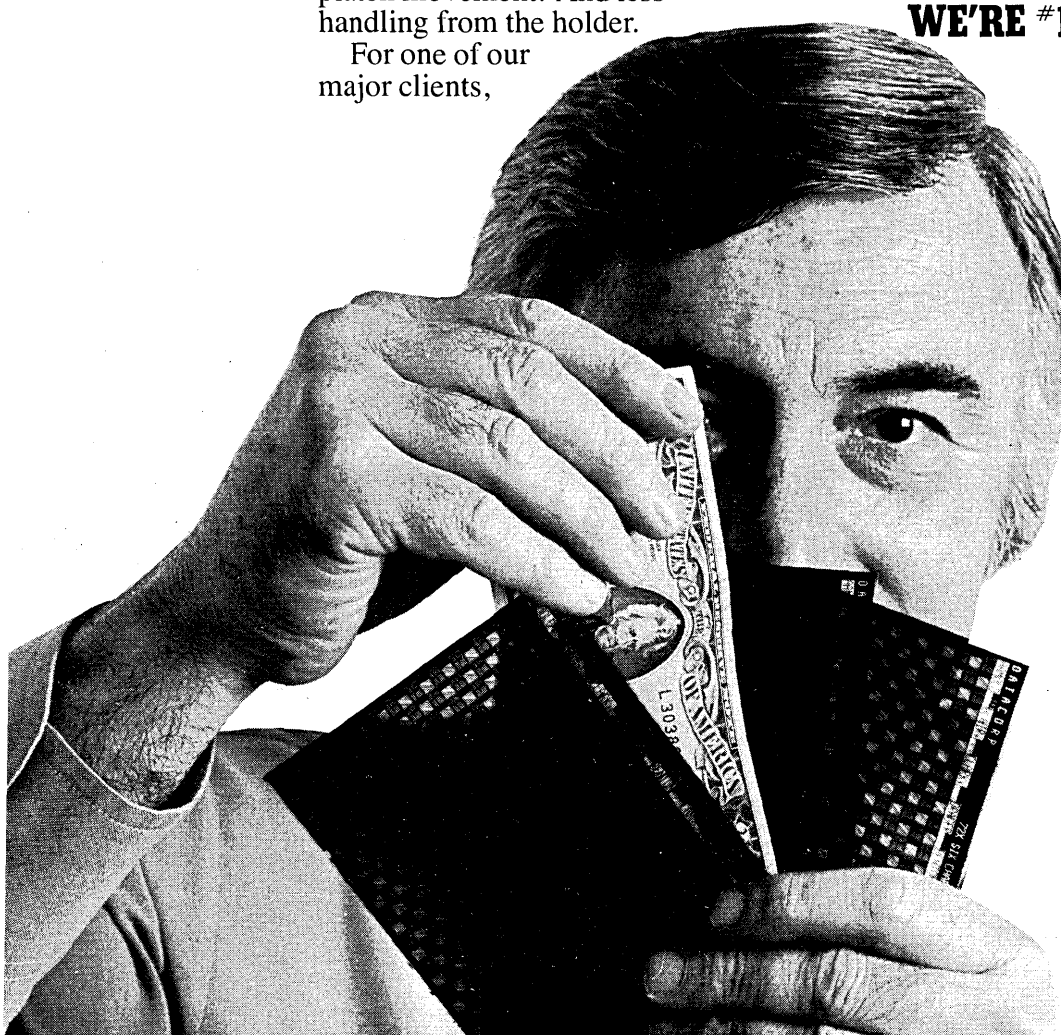

## DATACORP

P.O. Box 3460  
Portland, Oregon 97208  
(503) 225-5100

CIRCLE 64 ON READER CARD

# personal computing

Portia Isaacson, Contributing Editor

Portia Isaacson, our contributing editor who usually pens this column, is on a whirlwind, worldwide tour persuasively proselytizing for personal processors. This month's column presents the predictions of Robert Wickham, president and founder of Vantage Research.

The personal computer is just beginning to impact business data processing applications. Because of this growing technology, the way we handle record keeping, accounting, forecasting, decision making, and problem solving will undergo substantial changes.

Here we examine the type of products we can expect in the early 1980s. We also intend (hopefully) to place the present chaotic state of the market in better perspective.

Changes in the performance, price, and design of personal computers will allow their use in practically every aspect of business activities in small and large organizations. Although the term "personal computer" presently encompasses a wide variety of small systems, these products are evolving toward a range of stand-alone, single-operator-oriented computers in a desk top unit containing keyboard, display, processor, memory, file storage, printer, and power supply.

Products currently available from suppliers such as IBM, Tektronix, Hewlett-Packard, Wang, Datapoint, Logical Machines, IMSAI, The Digital Group, Qantel, Texas Instruments, and DEC point the way toward the powerful, fully integrated personal computer systems of the early 1980s. And we expect the current rapid pace of product introduction and performance improvement to increase. Existing suppliers of mainframes, small business computers, terminals, and programmable calculators will take advantage of developments in microprocessors, displays, memories, and small system architectures to stake their claim in this new market.

Driving the rapid development of the business oriented personal computer is the sheer size of the potential market. A \$50,000 small business computer system has a potential U.S. market of approximately 500,000 installations. The existing small business computer market, with an installed base of

approximately 100,000 units, has achieved less than 20% of this potential and represents a major market opportunity. The "Very Small Business Computer" market, with complete systems priced under \$10,000, opens up a potential market of over 3 million small busi-

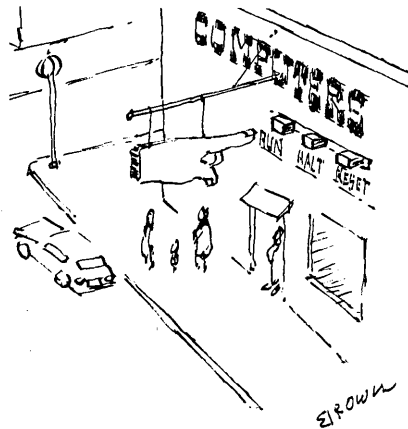

ness establishments in the United States alone. In addition, most small businesses are candidates for more than one system.

## Looking at the 1980s

The converging influence of small business computers, intelligent terminals, programmable calculators, and time-sharing will create a variety of personal computing systems, ranging from small portable units derived from the upward growth of programmable calculators, to full blown business systems with 20MB of file storage, high resolution graphics, multiple emulation modes, printers, plotters, and data communications. Researchers, financial analysts, chemists, accountants, lawyers, and business managers will find these systems increasingly easy to use thanks to the powerful LSI devices available to systems designers.

## System evolution

Fully integrated desk top systems will evolve to automate record keeping, provide personal problem solving tools, aid in the analysis of business data, and improve business decision making. As production volumes increase and prices fall, the personal computer will become more of a universal business information appliance which is assigned to a particular task by program cartridges. The system would have a highly modu-

lar architecture for system flexibility and expansion. And, to increase its use in the business environment, the systems will become increasingly transparent to the user, with highly structured interactive programs for many applications.

We expect that these desk top computers will be able to run applications programs written for much larger machines, taking advantage of the large investments made in existing applications programs. By the mid-1980s some personal computers can be expected to have multiple switch-selectable emulation modes. When combined with plug-in cartridges for high level languages, this capability will permit the machines to use a wide variety of existing software, creating a thriving new business in "republishing" software in cartridges. The current crop of personal computer products look rather frail and primitive in comparison to what is to come.

## Processing power

During 1978 we will see the introduction of the next generation of high end microprocessor chips including such products as the 16-bit Intel 8086 and Zilog Z-8000. These devices will bring a number of large machine features to the microcomputer world including direct addressing of large amounts of main memory, hardware multiply/divide, and multiprocessor architectures. Well suited to the type of small business systems discussed here, they will rapidly find their way into designs for intelligent terminals, personal computers, and other business oriented systems. These new 16 bit processor chips have fixed instruction sets; however products to be introduced in the 1980s will have variable instruction sets and emulate popular large computers. More powerful processors will simplify user accessibility and reduce the cost of software development or modification.

## Memory

Systems introduced during the early 1980s will make extensive use of low cost semiconductor RAM with initial increments of main store in the 32KB to 64KB range for upper end machines. Remember that by 1980 a 64KB memory will require only eight chips! Personal computers represent an excellent

## PERSONAL COMPUTING

high volume system application for bubble memory and by 1980 the availability of 1Mb bubble chips will permit new memory implementation taking advantage of the best features of RAM, bubble, tape cassettes, and floppy disc.

Disc memory modules now under development will permit highly reliable 20Mb fixed disc subsystems for personal computers with oem prices of \$500 to \$700. These modules will be the same physical size as an 8 inch floppy disc drive.

### Displays

We expect the ubiquitous crt to remain the primary display device for future personal computer systems because of its flexibility, resolution, and low cost. At the low end of the product range newer technologies such as plasma and liquid crystal will be incorporated into small inexpensive systems. Portability and low power consumption will become an important selling point.

### Software

As has been often stated, the lack of quality applications software is a major limitation on the growth of the business personal computers market. Market forces will supply a number of solu-

tions. One is the influx of entrepreneurial programmers and system analysts who see a business opportunity writing new software and installing systems. Another significant resource to be tapped is the vast number of existing programs in both the proprietary and public domains which could be modified for use on personal computers either by emulation or the use of high level language interpreters or compilers.

Another innovation will be the distribution of applications programs in ROM cartridges. For programs written in a specific high level language, a companion language cartridge would allow the program to be run on a variety of personal computer products. ROM will also become the standard system software storage medium. The entry of the semiconductor suppliers into the "solid state software" (thank you, Texas Instruments) market is sure to produce a standardization of sorts in high level language interpreters, disc operating systems, and multiprocessor control programs. It is interesting to note that by 1980 a single ROM chip will be capable of storing 32K bytes of program, enough for a language interpreter, disc operating system, and assorted system utilities!

This availability of modular system software in ROM should permit the high volume manufacture of general pur-

pose computer systems which can be configured by the distributor or retailer to the user's requirements for specific features and peripherals.

### Graphics

We expect the use of graphics to enhance the manipulation of business data to increase dramatically in the next three years. It will be offered as an option on almost all levels of personal systems and will be standard on top-of-the-line models. Here again the availability of low cost processing and memory will enhance the user interface and extend the number of potential system users.

### Communications

Some form of data communications will become a common option on business oriented personal computers. Communications will serve a number of purposes depending upon the specific application. In addition to remote data base access and electronic mail uses, we expect new types of services to supplant more conventional methods of publishing and distribution. Falling communications costs and the use of batch- and burst-mode communications will permit users to make extensive use of the system's communications mode. In applications requiring access to remote files which are periodically updated, the transfer of the cur-

## REMOTE BATCH PROCESSING ON IBM'S FASTEST CPU 360/195



# TIME FOR SALE



## UNITED AIRLINES

Computer and Communications Services Division  
Denver Technological Center  
5350 South Valentia Way  
Englewood, Colorado 80110  
Call Collect (303) 779-2000 — Ask for Jon Burley

**GUARANTEED  
TURNAROUND  
only  
50¢ a second**

OS/MVT, HASP/RJE, 2 Meg, 3330's and 2314's — United Airlines operates a **Cost Efficient** service featuring **High Speed Processing** and **Quick Turnaround**. Through **Auto Answer WATS** or leased lines (at speeds of 2000 to 9600 BAUD) you gain access to one of the most complete data centers in the United States.

Dial our number and execute your own programs or utilize a wide range of software — ICES, MARKIV, OSIRIS, BMD, PANVALET, GPSS, HEC1, HEC2, SWMM, all standard compilers and more.

If you are using an outside computer service, United can offer you a substantial savings and an unbeatable service.

**COMPARE** — call or write today to request a benchmark or additional information.



rent files to the local system will be transparent to the user with the computer initiating the access under applications program control.

#### Distribution and marketing

A number of marketing and distribution channels will be required for the business personal computer market. For the large number of small, first time users retail computer stores are an effective method of sales, support, and service. But the expected sales of large quantities of personal computers to large companies for distribution to their professional and technical employees can be effectively handled by the existing major account marketing approach currently used by most computer vendors. Other outlets will include specialized systems houses and distributors which will provide software and support for specific applications. The computer services companies with large investments in software for large cpu's will find the personal computer a new vehicle for deriving additional revenue from their investment in business and scientific programs and services.

#### The business information appliance

The probability of most of these changes happening over the next three years is quite high. It will, of course, take more than three years for these innovations to become absorbed into the everyday functioning of the business community, but the products and services will be available.

We are moving into the era of the business information appliance. In large business organizations the personal computer will supplement the highly structured distributed processing system, allowing individuals access to unstructured computing power and enhancing their creativity and productivity. In small businesses, these low cost systems can be deployed like chess pieces against specific business problem areas without incurring the expense and risk of conversion to a multi-application system. A business can then utilize a number of personal computers, each dedicated to a specific record keeping, operations, or decision making task with media or communications transfer of data between systems.

Looking at the state of the personal computing industry in 1978, it is apparent that we have a long way to go. But the personal computing movement is only a little over three years old, and its growth and development have been phenomenal. This year the business oriented personal computer market in the U.S. is expected to be over \$150 million; the 1980 forecast is \$700 million in system sales. Personal computers have achieved a high degree of market acceptance and are well on their way to becoming a major segment of the computer industry. ❁

June, 1978

- ELECTRICAL DESIGN ENGINEERS
- PROGRAMMERS/SYSTEMS ANALYSTS

*Work with the people who have revolutionized the banking business: NCR-Dayton.*

## **EDP Terminals for Financial Institutions**



NCR business computer systems have changed the financial picture so radically that yesterday's bankers and financiers wouldn't recognize their businesses today. At NCR-Dayton, our part in that transformation is a lineup of financial terminals of such versatility and performance, they have made possible new banking and financial services which have motivated new marketing concepts

for financial institutions. That, of course, opens up larger marketing potentials for us. And greater career potentials for you.

We're now designing new advances in EDP terminals with greater computing and communications power, to maintain NCR's leadership position in business and financial systems. To accomplish our objectives, we're enlisting the best of the field of electrical design engineers and programmer/analysts. If you'd like to join one of the computer industry's Big Three, the one that has revolutionized the banking and retail businesses, we invite you to investigate these openings. We have opportunities at all levels . . . from trainees to project leaders in the areas listed below. BS in EE, CS, or related field is required, with or without experience. We'd like to hear from recent graduates.

#### Electrical Design Engineers

- Microprocessor Applications
  - Digital and Analog Circuits
  - Electrical Control Circuitry
  - Terminal Peripherals
- Familiarity with microprocessor programming helpful for all positions.

#### Programmers/Systems Analysts

- Microcomputers
  - Minicomputers
  - Operating Systems
  - Distributed Processing Systems
  - Communications Software
- Requires background with 8080 Assembly and COBOL language.

We offer an outstanding compensation and benefits package with a fine environment in which to work and live. Please forward your resume, indicating salary requirements, to:

Mrs. Judith E. Chorazewitz  
Engineering & Manufacturing-Dayton  
Employment Dept. D-6  
NCR Corporation, Dayton, Ohio 45479

The big move is to NCR

**NCR**

An Equal Opportunity Employer

# COMPUTER ENGINEERS

## Power Plant Process Control

GPU Service Corporation, part of the General Public Utilities System, is expanding its in-house capability to develop real-time process computer systems for use in both new and operating power plants. This involves determination of computer functions for these plants and the development of hardware and software systems to satisfy these requirements. Both nuclear and fossil plants are involved. We're looking for experienced, innovative engineers who are able to roll up their sleeves and help us in this task. If you are looking for a stimulating challenge and an opportunity for growth and advancement based on your ability to achieve, we'd like to hear from you.

The following specific positions are typical of our present needs:

### HARDWARE DEVELOPMENT

Engineers and Senior Engineers required for plant computer system development. These positions will involve the development of design criteria, design coordination and review, evaluation of vendor bids and technical follow through startup and operations of real time systems for both fossil and nuclear power plants. These positions are located in the home office for new plants and at the power plant in the case of modifications activities.

### SOFTWARE DEVELOPMENT

Engineers and Senior Engineers for the development of overall approaches for software package development, preparation of overall software packages or parts thereof, and their application to both new and existing power plant process computers. Assignments related to new plants will be in the home office, while those related to existing computers will be at the power plant itself.

We offer excellent starting salaries, fully commensurate with the depth of your experience, plus fine company benefits which include relocation assistance. For prompt, confidential consideration, forward your resume, including salary history and requirement, to: Mr. Paul Gomez



**GPU SERVICE CORPORATION**  
260 Cherry Hill Road  
Parsippany, New Jersey 07054

MEMBER COMPANY OF THE GENERAL PUBLIC UTILITIES SYSTEM

In principle and practice  
an equal opportunity employer M/F



**Technical  
Publishing Company**  
A Dun & Bradstreet Company

**James B. Tafel**, Chairman  
**John K. Abely**, President  
**Robert L. Dickson**, Exec. Vice President  
**Calverd F. Jacobson**, Vice President-Finance  
**Walter Harrington**, Vice President  
and Controller

### Advertising Offices

Eastern District Managers

**A. Treat Walker**,

**Warren A. Tibbetts**: Greenwich, Ct. 06830  
35 Mason St. (203)661-5400

New England District Manager & Vice President

**Warren A. Tibbetts**: Manchester, N.H. 03104  
112 W. Haven Rd.  
(603) 625-9498

Midwest District Manager

**John M. Gleason**: Chicago, Ill. 60611  
444 No. Michigan Ave.  
(312) 644-3970

Western District Managers

**Alan Bolte, Jr.**: Los Angeles, Calif. 90035  
1801 S. La Cienega Blvd.  
(213) 559-5111

**James E. Filiatrault**: Mountain View, CA 94043  
2680 Bayshore Frontage Rd.  
Suite 401  
(415) 965-8222

U.K., Scandinavia, Benelux

**Intergroup Communications, Inc.**  
**Wallace K. Ponder**, European Director  
**Paul D. Dimmock**, Regional Manager  
31 Lyncroft Avenue  
Pinner, Middx, HA5 1JU  
England  
Tel: (01) 868 9289  
Cables: PACOM, Pinner

Germany, Austria, Eastern Europe

**Fritz Taeuber**  
Soltauer Strasse 85  
D-314 Lueneburg  
Germany  
Tel: (0 41 31) 4 38 49

France, Switzerland, Italy, Spain

**Gerard Lasfargues**  
32 rue Desbordes Valmore  
75016 Paris  
France  
Tel: (1) 288 90 22

Japan

**Shigeru Kobayashi**  
Japan Advertising Communications, Inc.  
New Ginza Building  
3-13 Ginza 7-chome  
Chuo-ku, Tokyo 104, Japan  
Tel: (03) 571-8748

Technical Publishing Company  
A Dun & Bradstreet Company



Business Magazines  
Consumer Books  
Training Systems

# Get a Different Perspective on Computing...

Second only to Americans in the use of computers, the Japanese bring to their applications a different sense of priorities. A preference for custom software over purchased packages. A liking for transaction processing and real-time control.

Come and meet them in San Francisco. See if some of their ideas don't make sense in your shop, and show them how things are done here.

Technical presentations in English by both Japanese and Americans are only a part of the upcoming USA-Japan Computer Conference.

There will be an all-day tutorial program on the Monday before the conference convenes.

Also an exhibit of catalogs from vendors on both sides of the Pacific — hardware, software, and services.

Join us for this third meeting of East and West; the first time this conference is held on American soil. Share common professional and avocational interests with your counterparts from Japan. It's a rare opportunity, one you shouldn't miss.

**3RD USA-JAPAN COMPUTER CONFERENCE  
SAN FRANCISCO**

**OCT. 10, 11, 12, 1978**

Sponsored by  
The American Federation of Information Processing Societies  
and the Information Processing Society of Japan

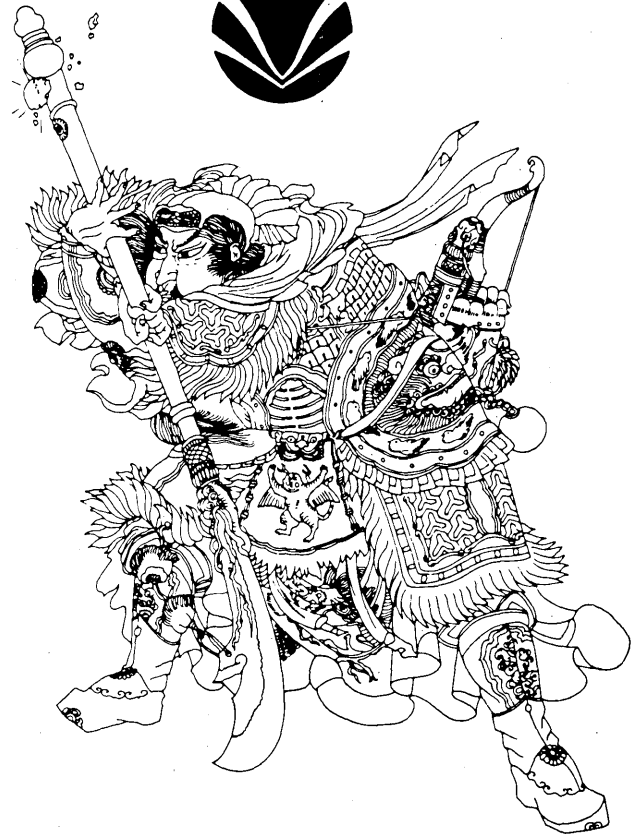

**3RD USA-JAPAN COMPUTER CONFERENCE  
SAN FRANCISCO**

**OCT. 10, 11, 12, 1978**

Name \_\_\_\_\_

Address \_\_\_\_\_

\_\_\_\_\_ ZIP \_\_\_\_\_

FOR MORE INFORMATION ABOUT THE CONFERENCE,  
PLEASE COMPLETE AND MAIL TO AFIPS,  
210 SUMMIT AVENUE  
MONTVALE, NEW JERSEY 07645

EDP Account Representatives • Technical Representatives  
Marketing Specialists • Programmers • Programmer Analysts

# Because we're GENERAL ELECTRIC INFORMATION SERVICES



You know you can be more creative, more productive, more successful in every way if you're doing a job that fits you to a "T." That's how we see it, too, at GE.

And because we're so broadly involved in EDP, because we have so many varied openings in so many functions and fields, we can match your abilities and interests with a high level of precision.

### For example, are you turned on by:

- selling to top management?
- developing and promoting DP services?
- DP problem solving?
- technical consultation and planning?
- business operations analysis?
- customer contact?
- directing technical support?
- installing effective programs?

### Which areas are you strong in?

- management methods (MIS)?
- financial (banking, brokerage)?
- corporate finance?
- production methods and systems?
- inventory management?
- administrative operations (payroll, personnel)?
- engineering and technical processes?
- you name it.

### Why is GE able to tailor a job to your measurements?

■ We are in a stage of widespread expansion of what has become one of GE's major market activities—DP services—so we have plenty (hundreds) of jobs to fill.

■ The scope of GE data processing services to the widest spectrum of commercial users poses needs for people who know their way around one or more of the many areas of business activity. All that we really want is your previous involvement in a major DP systems installation.

### Time to reroute your career?

Not only do you get a position that fits, the options remain open after you're in. Again, the large-scale expansion makes on-the-job changes possible—for example, from Technical Representative to Account Representative, from Programmer to Technical Representative, and so on. If you're now on the wrong track, GE offers an opportunity to re-route your career onto paths that lead to greater rewards.

Of course, we need only point to the other advantages of a GE assignment: a distinguished name that opens doors at the highest levels, a reputation for quality and effectiveness in all GE products, and matchless technical support resources.



### OPENINGS NATIONWIDE

We have opportunities for experienced **Sales Representatives and Programmer/Analysts** (with emphasis on FORTRAN) in major cities coast-to-coast.

In Maryland, at our Headquarters center, we have opportunities for IBM and Honeywell large-systems **Programmers, Application Programmers and Programmer/Analysts** with FORTRAN and other hi-level language backgrounds; **Senior Marketing Specialists** who know how to develop a product and get it to the customer; and many other DP opportunities for ambitious people who want to match their own rapid growth rate with ours.

\* \* \*

Send your resume and salary history to Manager-Employment, General Electric, Information Services Business Division, 401 N. Washington Street, Room 65F, Rockville, Maryland 20850.

GENERAL  ELECTRIC

An equal opportunity employer, m/f

# advertisers' index

AC Manufacturing Company .....	261
•Anristu Electric Co., Ltd. ....	220-K
AFIPS .....	277
American Telephone and Telegraph Company .....	100, 101
Anderson Jacobson, Inc. ....	178
Applications Software, Inc. ....	265
Applied Data Research .....	5
Applied Digital Data Systems Inc. ....	99, 111
Applied Technology Division, Computer Sciences Corporation .....	284
Athana Corporation .....	52
Austron Inc. ....	259
Aydin Controls .....	63
Basic Timesharing Inc. ....	16
•Benson .....	220-V
Boeing Computer Services .....	283
Boole & Babbage .....	243, 245, 247, 249
Broomall Industries, Inc. ....	66
Centronics Data Computer Corp. ....	24, 219
Cincom Systems, Inc. ....	129
•Cincom Systems International S.A. ....	200-Y—220-BB
Clapp & Poliak, Inc. ....	67, 68, 69
•Codex Corporation .....	220-HH
Computer Corporation of America .....	77
•Computer System-und Zubehor .....	220-W
Consolidated Computer International Inc. ....	97
Control Data Corporation .....	30, 31, 105, 133, 171
C.S.D. International Corporation .....	20
Cullinane Corporation .....	35
DASD Corporation .....	216, 217
Data General Corporation .....	112, 113
Data 100 Corporation .....	94, 95
Data Processing Security Incorporated .....	216
Datacorp .....	272
Dataproducts .....	210, 211
Dataram Corporation .....	199
•Datasaab AB (Datasaab Division) .....	220-DD, 220-EE
•Datasaab AB, (Stansaab Division) .....	220-NN
Datum, Peripheral Products Division .....	Cover 3
Dayco Corporation, Printing Products Division .....	182
Decision Strategy Corporation .....	56
Delta Airlines .....	260
Delta Data Systems Corporation .....	213
Diablo Systems Division of Xerox Corporation .....	57
A.B. Dick/Scott .....	240, 241
Digital Associates Corporation .....	244
Digital Equipment Corporation .....	143, 158, 159
•Digitronics Div. of Comtec Information Systems, Inc. ....	220-H
Documation Incorporated .....	40, 41
Dranetz Engineering Labs, Inc. ....	8
Dynatech Laboratories, Inc. ....	219
Electronic Memories & Magnetics Corporation .....	43
Epic Data .....	172
Equipment Resources Inc. ....	248
Evans & Sutherland Computer Corporation .....	181
Ex-Cell-O Corporation, Remex Division .....	166
Fox-Morris Personnel Consultants .....	267, 282
•Fujitsu Limited .....	220-GG
Funding Systems Corporation .....	209

June, 1978

## Intelligent Voice Terminal can slash data-entry costs ...its' user programmable and operator compatible

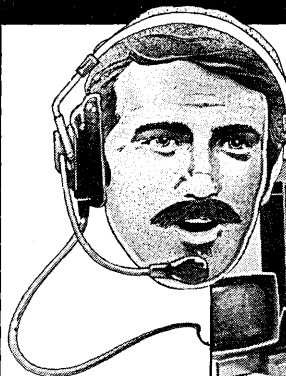

See it at NCC Booth 1444.



It's direct source data entry by voice, no coding or keypunch. Interstate's Intelligent Voice Terminal adapts to your present information system without expensive modification to the host CPU. Better yet, this terminal adapts to the source-user in natural terminology, normal format. The Intelligent Voice Terminal does the rest. And it's available with a full line of hardware options and peripherals:

- **Expansion**—Additional voice channels, telephone-only station, industrial remote user subsystem.
- **Input**—Microphone, telephone, wireless microphone.
- **Feedback**—16 or 32 character display, large 40-character remote display, asynchronous serial device, audio response.
- **Mass Storage**—Cassette tape, linc tape with random access files, application control processor with disc, host computer.
- **I/O Peripherals**—CRT display, plasma display, serial printers, modem, keyboard printer.

Where do you use it? Any place you are considering using an intelligent keyboard terminal but where "hands free" or spoken language data input is an advantage. The cost-reduction benefits can be highly significant. Call or write Daniel F. Fink, Marketing Manager, Voice Products, Interstate Electronics Corp., 1001 East Ball Road, P.O. Box 3117, Anaheim, CA 92803, (714) 635-7210.

### INTERSTATE ELECTRONICS CORPORATION

SUBSIDIARY OF **ATO**

Information Processing and Display.  
Systems. Products. Services.

CIRCLE 155 ON READER CARD



# Our Service Gets A Perfect Score In Datapro Study

DMS/OS is the data management system with satisfied users

All our DMS/OS users responding to a recent Datapro study gave our company a perfect 4.0 rating for our vendor technical support. DMS/OS was the only software product in the current Datapro study, with five or more responding users, that scored a perfect 4.0 in vendor technical support. In addition, DMS/OS users rated it at 3.6 in overall satisfaction.

DMS/OS users are satisfied. They are enjoying the benefits of having the most complete data management system available. Let us show you how they are controlling their DASD resources with DMS/OS.

DMS/OS is an established product with an excellent track record for vendor technical support. Just call or write and we will be glad to send a brochure, functional overview, Auerbach and Datapro reports. Find out why DMS/OS is the wave of the future in data management and give us the opportunity to show you, that at Software Module Marketing, service and software come together.

## SOFTWARE MODULE MARKETING

Where Service and Software Come Together™



Crocker Bank Building/Penthouse • 1007 7th Street • Sacramento, CA 95814 • Telex SMMMSAC 377-314 • (916) 441-7234



Are Your DASD's Drowning . . . in a Sea of Data?

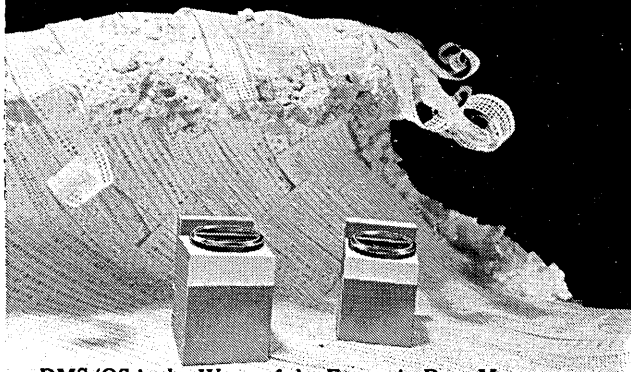

DMS/OS is the Wave of the Future in Data Management

CIRCLE 168 ON READER CARD

## advertisers' index

General Automation .....	6, 7
General Electric Company .....	278
General Electric Company, Communications Equipment Services .....	152
Gould, Instruments Division .....	201
GPU Service Corporation .....	276
Graham Magnetics .....	164
Graphic Controls Corporation .....	49
Hands On Terminals, Inc. ....	208
Harris Computer Systems .....	138, 139
Harris Corporation, Data Communications Division .....	80, 81
Hazeltine Corporation .....	236, 237
Hewlett-Packard .....	38, 179
Human Designed Systems, Inc. ....	230
IBM Data Processing Division .....	27, 28, 29
ICC/Milgo .....	169
IMSAI Manufacturing Corporation .....	161
Incoterm Corporation .....	148
Informatics Inc., Software Products .....	19
Infoton .....	48
Integrated Software Systems Corporation .....	162
Interface Mechanisms, Inc. ....	256
Interface West Inc. ....	262, 263
International Data Sciences, Inc. ....	218
Interstate Electronics Corporation .....	174, 279
Intel Corporation, Data Products Group .....	2, 79
Kato Engineering Company .....	51
Kennedy Co. ....	Cover 2
Kybe Corporation .....	26
Lear Siegler, Inc. ....	207, 257
Lesametric, Division of Metric Resources Corporation .....	251
Litton Computer Services .....	243
LRK Associates .....	258
Martin Marietta Data Systems .....	260
Megatek Corporation .....	47
Memorex .....	220
Micom Systems, Inc. ....	170
•Microtecnica .....	220-T
Minicomputer Accessories .....	247
Modular Computer Systems Inc. ....	144
Mohawk Data Sciences .....	109
MRI Systems Corporation .....	9
MSI Data Corporation .....	125
Motorola Inc., Data Products .....	34
National CSS .....	74, 75
National Semiconductor Corporation .....	36, 37, 64, 65
NCE Terminals & Communications, Inc. ....	245
NCR Corporation .....	173, 275, 284
NEC Information Systems, Inc. ....	141
Norand Corporation .....	58, 59
•Norsk Data Electronics A.S. ....	220-G, 220-P
Nova Electric Manufacturing Co. ....	249
Ohio Scientific .....	60
Okidata Corporation .....	4
Ontel Corporation .....	62

Pansophic .....	203
PCC Pertec, A Division of Pertec Computer Corporation .....	54, 55
Perkin-Elmer Data Systems .....	10, 11, 12, 13, 14, 15
Pertec Computer Corporation, CMC Division .....	1
Printronic, Inc. ....	242
Q1 Corporation .....	212
Quest Systems Inc. ....	266
Racal-Milgo, Inc. ....	169
•Racal-Milgo Limited .....	220-KK
Racal-Vadic .....	83
Radgo .....	218
Raytheon Computer .....	232, 233
Realist, Inc. ....	76
Rental Electronics, Inc. ....	177
RSVP Services .....	282
•R2E .....	220-O
SAS Institute Inc. ....	255
•SE Labs (EMI) Limited .....	220-LL, 220-MM
Schlage Electronics .....	154, 155
Shugart Associates .....	253
•SICOB .....	220-SS, 220-TT
Siemens Corporation .....	126, 127
Software Module Marketing .....	280
Sola, A Unit of General Signal .....	246
Software International .....	281
The Solar Energy Research Institute .....	267
Source EDP .....	282
Sperry Flight Systems .....	266
Sperry Univac Mini-computer Operations .....	130, 131
Summagraphics Corporation .....	50
Sycor .....	214, 215
Systems Engineering Laboratories .....	70, 71
Systonetics, Inc. ....	114
Tally Corporation .....	115
•Tandberg Data .....	220-S
Tandem Computers, Inc. ....	32, 33
T-Bar Incorporated, Computer Switch Division .....	180
TEAC Corporation of America .....	168
Techtran Industries Inc. ....	195
Tektronix, Inc., Information Display Group .....	44, 45
Telenet .....	21
Teletype Corporation .....	Cover 4
Telex Computer Products, Inc. ....	84
Texas Instruments Incorporated .....	122, 123
TransNet Corporation .....	61
United Airlines Cargo .....	106, 107
United Airlines, Computer and Communications Services .....	274
Universal Data Systems .....	22, 23
University Computing Company .....	150, 151
USA-Japan Computer Conference .....	277
Vadic .....	83
Varian Graphics .....	72, 73
Versatec, A Xerox Company .....	192, 193
•Wabash Computer Corporation, Equipment Division .....	220-PP, 220-QQ
Xerox Data Systems Division .....	116
•European Insert Advertisers	

Because net results count, we designed our LEDGER, RECEIVABLES, PAYABLES and our new ace FIXED ASSET SYSTEM for your users — the financial decision-makers. Our NET CHANGE MANUFACTURING system is the No. 1 star in material and capacity planning and control, too.

We serve flexible systems that remove informational blind-folds, yet are easy to install and live with due to our maintenance-free concepts and comprehensive warranty. It adds up to a definite point advantage for you, the EDP manager. In fact, at more than 1,400 worldwide locations, Software International's systems are the choice of the top-seeded data processing pro's.

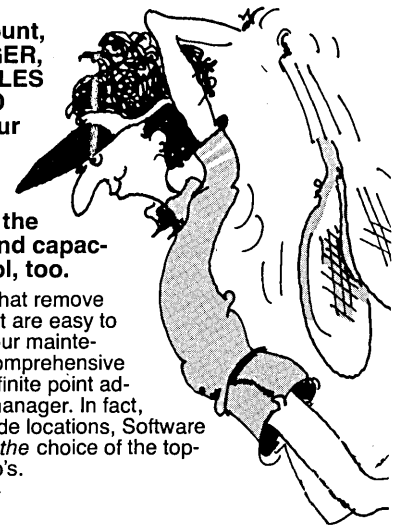

Fast on their feet, our systems move smoothly in any operating environment, on all popular hardware, with all of the common data-base managers, even on-line under CICS.

Get a firm grip on Software International's systems and see how you and your users can have a love match — with everyone a winner!

## Get smashing net results.

I'm ready to receive, Software International. Please send me more information about:

### SMALL COMPUTER SYSTEMS —

for users of System/3 and other IBM, Burroughs, Univac 9030, Honeywell 62, HP 3000, DEC, Interdata and most popular business minicomputers.

- General Ledger and Financial Reporting
- Accounts Payable
- Accounts Receivable
- Fixed Asset Accounting

### LARGE COMPUTER SYSTEMS —

for users of IBM, BURROUGHS, DEC, HONEYWELL, UNIVAC and ICL computers.

#### Financial

- General Ledger and Financial Reporting
- Accounts Payable
- Accounts Receivable
- Fixed Asset Accounting

#### Manufacturing

- Material Requirements Planning
- Master Production Scheduling
- Capacity Planning
- Shop Floor Control
- Purchasing

#### Comprehensive Report Generator

- FILETAB DA678

NAME	TITLE	
COMPANY		
ADDRESS	PHONE	
CITY	STATE	ZIP
COMPUTER SYSTEM		

## SOFTWARE INTERNATIONAL®

2 Elm Square Andover, MA 01810 (617)475-5040

Atlanta • New York • Washington, D.C. • Philadelphia • Chicago • San Diego  
Toronto • Houston • Columbus, OH • San Francisco

CIRCLE 169 ON READER CARD

## PROGRAMMERS AND ANALYSTS

Free Employment Service

Serving Northeast, Southeast and Midwest U.S.

- Scientific and commercial applications
- Software development and systems programming
- Telecommunications
- Control systems
- Computer engineering
- Computer marketing and support

Call or send résumé or rough notes of objectives, salary, location restrictions, education and experience (including computers, models, operating systems and languages) to either one of our locations. Or check the reader service card for a free sample resume. We will answer all correspondence from U.S. citizens and permanent residents and will guarantee our best efforts in a professional and ethical manner to all qualified applicants that we think we can help. Our client companies pay all of our fees.

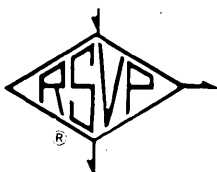

RSVP SERVICES, Dept. M  
Suite 700, One Cherry Hill Mall  
Cherry Hill, New Jersey 08002  
(609) 667-4488

RSVP SERVICES, Dept. M  
Suite 300, Dublin Hall  
1777 Walton Road  
Blue Bell, Penna. 19422  
(215) 629-0595

**RSVP SERVICES**

Employment Agency for Computer Professionals

CIRCLE 187 ON READER CARD

## WORD PROCESSING SOFTWARE

MANAGEMENT to \$45,000  
ENGINEERING to \$30,000

**Immediate Opportunities  
New Division/"Fortune 50"**

Our client, a multi-billion dollar company and the leader in the design of "the office of the future," seeks engineering and management professionals to staff an exciting new division.

The initial product has been introduced to the multi-billion dollar marketplace and has received overwhelming acceptance—clearly superior to anything on the market.

Our client provides exciting new career opportunities in exciting new technologies, and seeks any experience in word processing software for state-of-the-art product applications and product development.

Very desirable suburban mid-Atlantic location. Starting salaries to \$45,000 plus maximum career benefits. All relocation costs including real estate fees, plus our search fees, paid by client. Confidential interviews will be scheduled at your convenience.

In addition, if you recommend other qualified candidates, you will receive a \$1,000 finder's fee for each individual hired.

Reply in strictest confidence to G.H. Evans by resume, or call 215/561-6300

**FOX-MORRIS**  
personnel consultants

1500 Chestnut Street • Philadelphia, Pa. 19102  
New York • Fort Lee • Princeton • Pittsburgh • Cleveland  
Wilmington • Baltimore • McLean • Charlotte • Atlanta

CIRCLE 192 ON READER CARD

# New! 1978 Computer Salary Survey

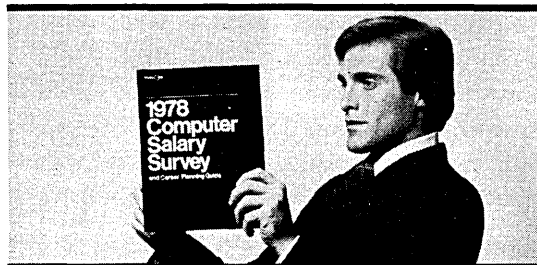

**Call for your Free copy today!**

Are you making the kind of money you should be making? Inflation and record demand have pushed salaries in the computer field to all time highs. Source Edp's 1978 Computer Salary Survey and Career Planning Guide lets you know whether you're keeping pace.

This comprehensive free report also gives you expert advice on a variety of important career topics such as: when you should consider a job change; what you need to do to break into management; how to make sure you're getting the proper exposure; why timing is so crucial in your long range career development; how you can avoid stagnation — and much more.

The 1978 Computer Salary Survey has been compiled by Source Edp, the largest recruiting firm devoted exclusively to the computer profession in North America. It's must reading if you're concerned about your career. But call now, it could be one of the most important career decisions you've ever made.

**For your Free copy, call the  
Source Edp office nearest you.**

<b>East:</b>	<b>Kansas City</b>	<b>Houston</b>
<b>Boston</b>	816/474-3393	713/626-8705
617/482-7613	<b>Minneapolis</b>	<b>New Orleans</b>
<b>Hartford</b>	612/544-3600	504/561-6000
203/522-6590	<b>Northfield IL</b>	<b>West Coast:</b>
<b>New York City</b>	312/446-8395	<b>Encino CA</b>
212/736-7445	<b>Oak Brook IL</b>	213/995-8866
<b>Philadelphia</b>	312/986-0422	<b>Irvine CA</b>
215/665-1717	<b>Rolling Meadows IL</b>	714/833-1730
<b>Stamford CT</b>	312/392-0244	<b>Los Angeles</b>
203/329-8411	<b>Southfield MI</b>	213/386-5500
<b>Union NJ</b>	313/352-6520	<b>Oakland</b>
201/687-8700	<b>St. Louis</b>	415/444-5955
<b>Washington DC</b>	314/862-3800	<b>Palo Alto</b>
703/790-5610	<b>St. Paul</b>	415/328-7155
<b>Wellesley MA</b>	612/771-0544	<b>San Francisco</b>
617/237-3120	<b>South/Southwest:</b>	415/434-2410
<b>Midwest:</b>	<b>Atlanta</b>	<b>Seattle</b>
<b>Chicago</b>	404/325-8370	206/454-6400
312/782-0857	<b>Dallas</b>	<b>Torrance CA</b>
<b>Cleveland</b>	214/387-1600	213/540-7500
216/771-2070	<b>Denver</b>	<b>Canada:</b>
<b>Detroit</b>	303/773-3700	<b>Toronto</b>
313/963-0510	<b>Fort Worth</b>	416/364-2919
	817/338-9300	

source edp

If unable to call, write: Source Edp, Department D6  
721 Enterprise Drive, Oak Brook, Illinois 60521

(When writing, please be sure to use home address and indicate position title.)

CIRCLE 189 ON READER CARD

**DATAMATION**

# If you're good, Boeing wants you to work on advanced business and scientific computing systems. Now.

If you're looking for career growth opportunities with a strong company, Boeing Computer Services could be the place for you.

BCS provides local and remote computing, custom programming, application packages, training and consulting services to The Boeing Company and

a variety of commercial and government customers.

We're on the move with new ideas from innovative people, and if you're good, we'd like to hear from you. Mail your résumé to

Boeing Computer Services, P.O. Box 3707-JQR, Seattle WA 98124.

An equal opportunity employer.

120  
21

LYST  
RAN and  
del 15 S.  
ics. Cal-  
ules will  
sment  
Model  
writing  
FOR  
quire  
re able  
del re-  
based  
class  
stors  
sons.  
sc-  
stra-  
ce in  
Adm-  
steps  
dillas  
Ruler  
1-1-2  
ance  
off de  
exper-  
and de-  
s n s #  
in full  
through  
spect.

met. Cal-  
s. Room  
953/AF  
UY/AF  
ON EM

MER  
encod  
stipe  
stion.  
offers  
e ad-  
te low  
80 sr  
stblatt,  
A. 1907  
603, Mi-

R  
sion of  
lication  
program  
in May

Segre  
of level  
e plus a  
C

resume  
outhern  
Network  
Rouge,  
Oak Co

onwide

42  
city  
hed.  
\$16-20K  
insurance  
on both  
\$16-21K  
Compu-

Seattle, WA 98115  
Offices in Wash. D.C.  
Chicago, Atlanta, Portland, Or.

## WE NEED GOOD PEOPLE

### COMPUTER PROFESSIONALS

Boeing Computer Services has immediate openings for experienced people.

We'd like to hear from you now, if you have a background in any of the following areas:

- COMPUTER AIDED DESIGN
- COMPUTER AIDED MANUFACTURING
- COMMUNICATIONS SUBSYSTEMS
- DATA BASE SYSTEMS
- MINI-COMPUTER SYSTEMS
- CDC PROGRAMMING
- SYSTEMS/APPLICATIONS PROGRAMMING
- ON-LINE SYSTEMS

BCS

BOEING COMPUTER SERVICES COMPANY

A Division of The Boeing Company

COMPUTER SALES

Career

DATA PROCESSORS

We Present You  
With Opportunity

PR  
Challeng-  
able for  
South Fl  
center. J  
one year  
grammic  
experience  
excellen  
compreh  
plus an  
and prof  
tified res  
tory and  
confidence  
mean. E

JACK

10  
y  
An  
Educ

CO  
PRI  
The  
oppo  
prof  
disci  
leve  
prog  
exp  
are:  
■ TL  
■ FI  
■ NL  
■ CA  
■ MK  
■ OPL  
■ COP  
■ ASS  
Assign  
davel  
vario  
custo  
of futu  
requir

DATA PR  
Asst/Asst  
systems  
strong  
for 400  
years  
experie  
SQL, m  
and DP,  
interest  
1978,  
BA-17A,  
72701.  
The Univ  
Equal Op  
tion Emp

PR  
Challeng  
For

# EDP Professionals!



**Expand your horizons in San Diego**  
**Immediate openings—software and hardware**

■ **SOFTWARE DESIGN SPECIALIST**  
 —Distributive Processing

■ **SYSTEMS ARCHITECTS**  
 —Future EDP Systems

■ **FIRMWARE**  
 —Project Lead/Analysts

■ **DIAGNOSTIC PROGRAMMING**  
 Design, develop programs to support software testing release and repair

■ **SOFTWARE DEVELOPMENT**  
 Design/Implementation of multi-program, interactive O/S in a high-level language. Experience desired in data base or telecommunications, distributive processing, virtual machine, time-sharing, compilers

■ **MIS APPLICATIONS**  
 ■ **SOFTWARE QUALITY ASSURANCE**

■ **OPERATING SYSTEMS (HIGH-LEVEL LANGUAGES)**  
 —File Management Project Lead  
 —Data Communications

■ **DATA BASE**  
 —Project Lead  
 —COBOL

■ **TRANSACTION PROCESSING**  
 —Project Lead

■ **SYSTEMS MEASUREMENT**  
 —Systems Performance Analysis

■ **MICR PROOF OF DEPOSIT SOFTWARE**

■ **CONFIGURATION MANAGEMENT**  
 —Design, Test, Integration

■ **TEST SYSTEMS DEVELOPMENT**

■ **MICR/OCR/OMR ENGINEERS**

■ **DESIGN AUTOMATION ENGINEER**

■ **MEMORY DEVICE ENGINEERS**

■ **LOGIC DESIGN ENGINEERS**  
 —CPU  
 —Peripheral controllers (microcoding for I/O subsystems)

■ **FUNCTIONAL SPECIFICATIONS**  
 —I/O subsystems  
 —System integration

■ **COMPONENTS ENGINEER**  
 —Evaluate, analyze semiconductors and digital integrated circuits

■ **I/O SUBSYSTEM CONFIGURATION**  
 —Technical Lead

■ **SYSTEMS INTEGRATION TEST**

Employees will enjoy excellent salary and top working conditions with a commercial employer. Fully paid life, hospital and medical plan for employee and dependents.

Please send resume, including salary history and experience to the Professional Placement Office at the address below.



**ENGINEERING AND MANUFACTURING**  
 16575 W. Bernardo Drive, San Diego, Calif., 92127  
 An Equal Opportunity Employer

CSC

**Computer Professionals**

**TELL THE TRUTH.**

**ARE YOU GROWING FAST ENOUGH?**

The Applied Technology Division of Computer Sciences Corporation can offer you the room you need to grow. As a major part of CSC, we provide information systems technology to many government agencies. Our opportunities are many and the challenges great—if your abilities match the requirements listed below, investigate immediately . . .

**WALLOPS ISLAND, VA.**

—Real-Time Programmers with Assembly language experience with the PDP 11 or LST 11 real-time operating systems.

**KENNEDY SPACE CENTER, FLA.**

—Applications Programmers with degree preferred; Scientific & Real-Time Programmers with degree in related area desired; Systems Analysts & Programmers in support of Space Shuttle Launch Processor System with experience in real-time systems, minicomputer network or operating systems, degree helpful; Systems Programmers with experience on PDP-11, background in RSX-11D operating system and/or satellite image processing.

**WASHINGTON, D.C.**

—Programmer/Analysts with COBOL or Fortran experience on the U-1100 or IBM 360/370 series, IMS helpful.

**NORFOLK/HAMPTON, VA.**

—Scientific Applications Analysts systems software on large scale computer, familiarity with CDC STAR desired; COBOL applications on 3rd generation systems, Univac 1100 series desirable.

**GREENBELT, MD.**

Programmer/Analysts with IBM 360/370 experience in COBOL, ALC, JCL, or PL/1 on OS, MVS, MVT, VS-1 or VS-2.

**MOUNTAIN VIEW, CALIF.**

—Scientific Programmer with Fortran experience on the CDC STAR 100 or Illiac IV desired.

**RIDGECREST, CALIF.**

—Scientific & Systems Programmers with U-1100 Fortran, Assembly, or EXEC 8.

**BAY ST. LOUIS, MISS.**

—Scientific Programmers with communications software, Fortran and Assembly language, numerical modeling, data base management, and graphics applications on microprocessors, minicomputers, and large scale computers.

These are just a few of our many openings. So if you're a Programmer/Analyst and CSC sounds like your kind of company, please send your resume to:

Gus Siekierka  
 Director, Industrial Relations

Applied Technology Division  
 P.O. Box 21127  
 Kennedy Space Center,  
 FL 32815  
**COMPUTER SCIENCES CORPORATION**  
 Major Offices and Facilities  
 throughout the World  
 Equal Opportunity Employer M/F

CIRCLE 181 ON READER CARD

**DATAMATION**



# Datum the Intelligent Alternative for PDP-11 Disk Users

## Price

- Significant cost savings for OEMS and End users.
- Dollar for dollar Datum offers you the lowest possible cost per byte without sacrificing performance or dependability.

## Dependability

- More than 9 years of designing and selling peripheral systems. Over 10,000 peripheral products installed has made Datum the leading independent supplier of peripheral systems.
- With major service centers in the United States and Europe, Datum is prepared to service its products worldwide with direct factory trained personnel.
- Utilizes the same microprocessor technology used in our larger capacity disk systems.

## Performance

- Complete Software & Media transparency to the DEC RK11
  - Mix or Match Drive capacities at speeds of 1500 or 2400 RPM
  - Single board design, occupying 1 SPC slot of a DD11-A (or equivalent) System Unit
  - 34 byte data buffer
  - Controls up to four 2.5, 5 or 10 megabyte disk drives
  - Interfaces to drives manufactured by Diablo, Pertec, Western Dynex, Wangco, Caelus & DRI
- 11 reasons we want you to look at our disk products for your PDP11 computer.

**Datum inc**

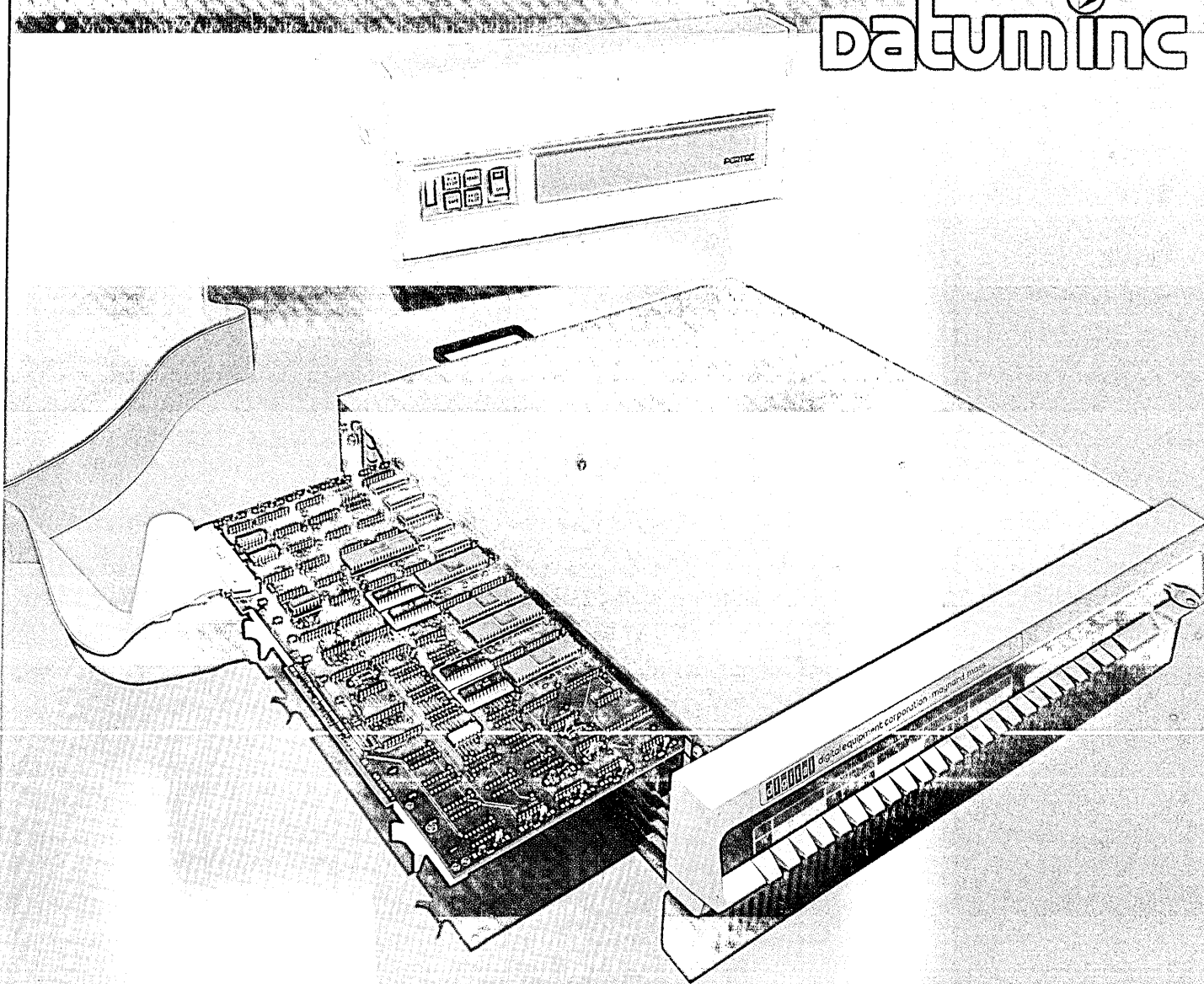

Peripheral Products Division, 1363 South State College Boulevard, Anaheim, California 92806, Telephone: 714/533-6333, TWX: 910/592-1289, Telex: 68-5579  
Richard Horowitz (Mid West Sales Manager), Des Plaines, Ill., (312) 296-1064 • Don Stearns, (East Coast Sales Manager), Mountainside, N.J., (201) 654-5590  
Dick Thompson (District Sales Manager), San Jose, Ca., (408) 249-5370 • EUROPEAN HEADQUARTERS, DATUM ELECTRONICS, LTD.,  
DATUM House, Cranford Lane, Harlington, Middlesex, England, Tel: 01-897-0456, TELEX: 935-398

CIRCLE 2 ON READER CARD

# WE'D LIKE TO REMIND YOU ABOUT THE DATA COMMUNICATIONS TERMINAL OUR COMPETITORS WOULD LIKE TO FORGET.

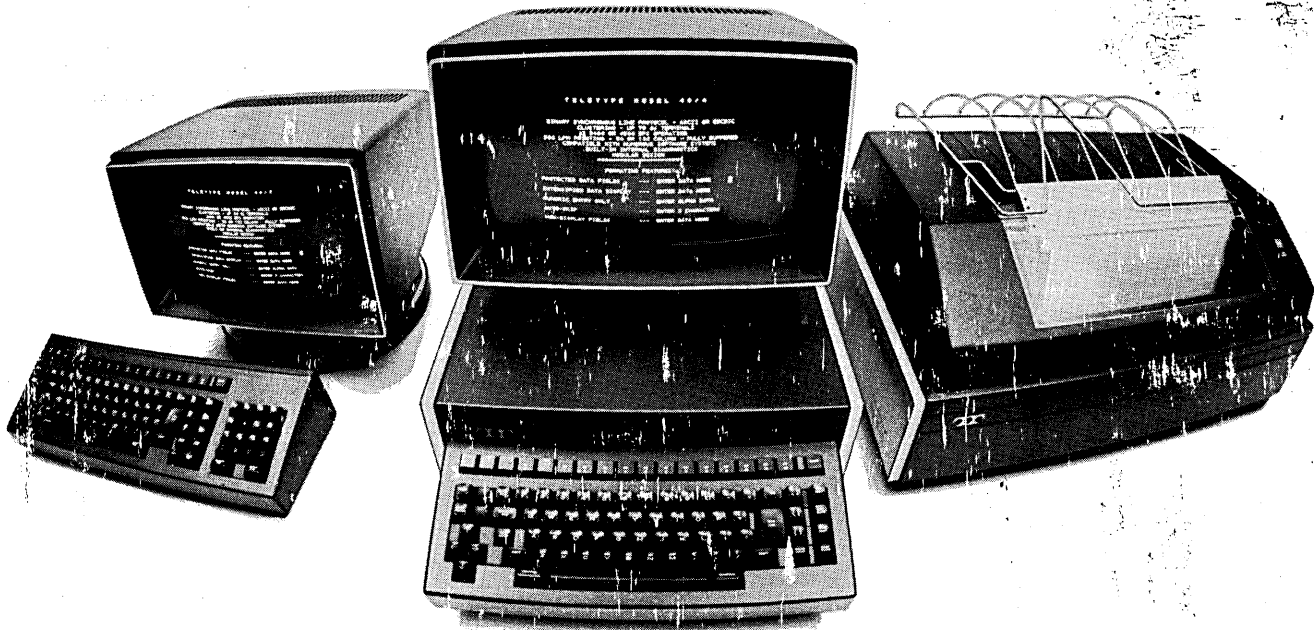

What the bottom line is telling banks, brokerage houses, pharmaceutical chains, railroads and steel companies is that for all-around value, there's no way the Teletype\* model 40/4 synchronous data terminal can be beaten.

And no wonder. Over the years, Teletype data terminals have built up an outstanding reputation for quality, dependability and proven performance. Add to that the model 40/4's system flexibility and human engineering features and you'll see why it consistently comes out on top in competitive analyses.

There's even icing on the cake. Delivery is only 30 to 90 days. And model 40/4 systems are installed and maintained by Teletype's nationwide service network.

So if you're looking for stand-alone or clustered displays and printers that are hardware and software compatible with remote bisynchronous communications protocol, command code structures and addressing sequences, we'd like you to look at the

model 40/4. And to make that easy, we're offering a free, on-site evaluation program. In other words, we're putting our money where our mouth is.

Just give us a call at 312/982-2000, or send in the coupon below. But do it quickly, please. Because with something as hot as the 40/4, we don't have many just sitting around.

\*Teletype is a trademark and service mark of the Teletype Corporation.

Teletype Corporation  
5555 Touhy Avenue  
Dept. 3185  
Skokie, IL 60076



Your free, on-site evaluation program sounds intriguing, and I'd like to know more about it.

Name \_\_\_\_\_

Position \_\_\_\_\_

Company \_\_\_\_\_

Address \_\_\_\_\_

State \_\_\_\_\_ Zip \_\_\_\_\_

Phone \_\_\_\_\_