

AMP

ENGINEERING AND PURCHASING GUIDE

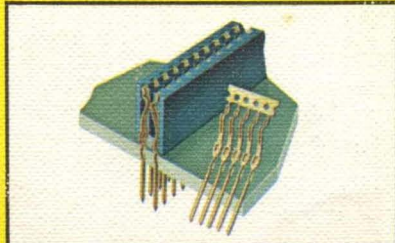
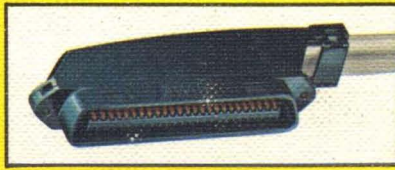
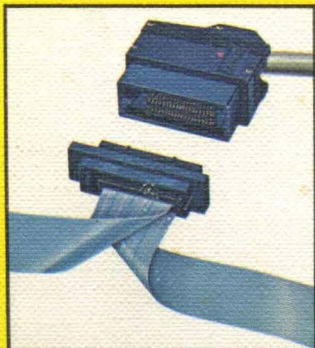
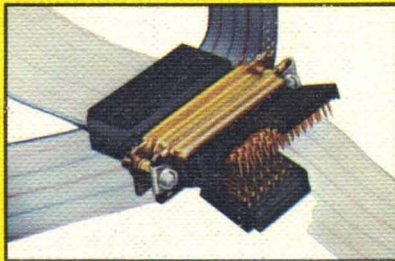
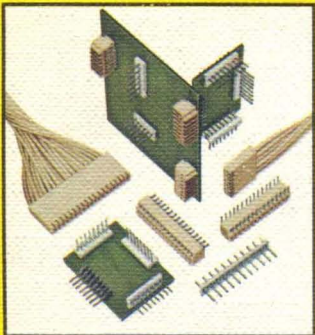
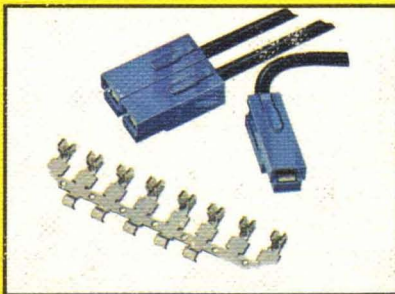
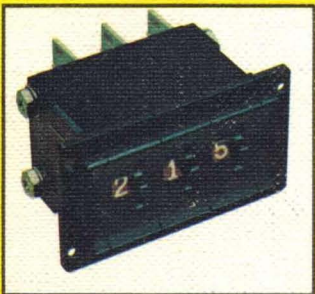
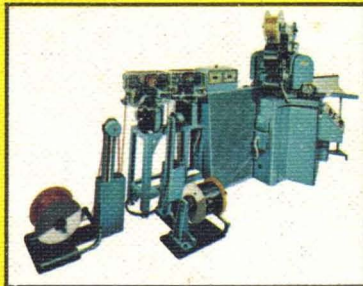
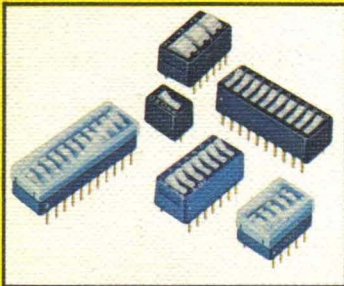
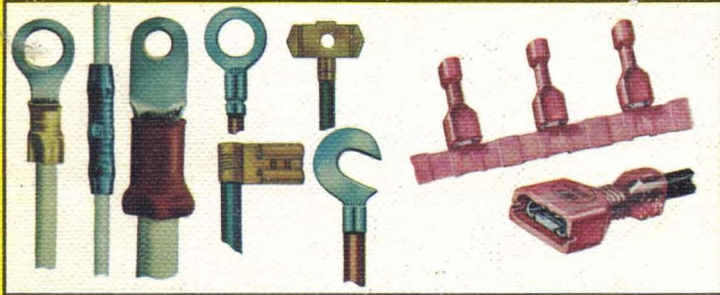
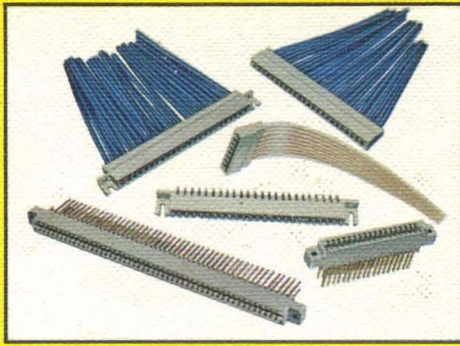

AMP INCORPORATED
WORLDWIDE

AMP ENGINEERING & PURCHASING GUIDE

Complete Specification and Application Data on Over 45,000 Items for Terminating, Connecting, Splicing and Programming Electrical, Electronic and Micro-Electronic Circuitry

If you are involved in wiring or interconnecting electrical/electronic devices and circuits, you are concerned with the availability of reliable products that will meet your exacting requirements and contribute to total production economies.

We believe you will find this book a useful and comprehensive reference in the selection and specification of terminals, splices, connectors and other items you use in your work.

Your AMP Sales Engineer welcomes the opportunity to discuss your particular application needs at any time, and to make available to you AMP's worldwide research, engineering and marketing services which will help you make the most of AMP products and termination techniques.

How to use your AMP Engineering and Purchasing Guide

This guide is designed to facilitate referencing specific AMP Products. Every effort has been made to assure the accuracy of the information contained in this guide. However, AMP Incorporated makes constant improvements to products through specification changes, additions to product lines and the introduction of new product lines. **We recommend that you consider this volume as a guide only — for the latest, exact design specifications contact AMP Incorporated.**

The AMP Engineering and Purchasing Guide is divided into 28 Sections (See Table of Contents beginning on page 1). Each section is titled according to its basic content. The various product lines within a section are identified by a brief general description and, where applicable, the appropriate AMP Trademark. The sections carry their section number throughout the guide on the upper corner of each page, and individual pages within a section are keyed to that specific section. For example, Page 42 in Section 9 is identified as Page Number 9-42.

For your convenience we have included a numerical index of AMP Part Numbers at the end of the guide (Section 28). You will find this numerical index extremely helpful in those cases where the AMP Part Number is already known.

AMP Incorporated is pleased to present you with this Engineering and Purchasing Guide. We trust it will prove to be a valuable reference to our extensive and diversified line of products and tooling.

Metric Dimensions

A large percentage of the products contained in this publication will have both customary and metric dimensions. AMP Incorporated is presently in the process of "dual" dimensioning all cataloged product for easy reference. Until this process is completed we have included a metric conversion chart on pages 10 and 11 of the introductory section.

CONDENSED TABLE OF CONTENTS

1	Terminals and Splices.....	1-1	15	Printed Circuit Panels and Components	15-1
2	Terminals and Splices for High Temperature Applications....	2-1	16	Multiple Position Coaxial Connectors.....	16-1
3	Terminals and Splices for Special Applications.....	3-1	17	RF Connectors.....	17-1
4	Terminals and Splices for Automatic Machine Application ...	4-1	18	Patchcord Programming Systems and Panels	18-1
5	Special Terminals and Splices for Automatic Machine Application.	5-1	19	CAPITRON Products.....	19-1
6	General Purpose Connectors.....	6-1	20	Switches and Relays.....	20-1
7	Insulation Displacement Connectors.....	7-1	21	Pinboard Programming.....	21-1
8	Special Application Connectors ...	8-1	22	Point-to-Point Wiring.....	22-1
9	Pin and Socket Connectors	9-1	23	Taper Technique Products	23-1
10	Modular Connectors	10-1	24	Products for Microelectronics.....	24-1
11	Hermaphroditic Contact Connectors.....	11-1	25	Heat Shrinkable Products.....	25-1
12	Flexible Flat Cable Products	12-1	26	Indicator Lights	26-1
13	Printed Circuit Connectors.....	13-1	27	Cable Ties and Bundling.....	27-1
14	Interconnection Packaging Devices and Accessories	14-1	28	Miscellaneous Products, Application Tooling & Numerical Index ..	28-1

TRADEMARK NOTE — Various trademarks of AMP INCORPORATED are used throughout this book. Below is a listing of these trademarks. AMP, A-MP, AMP BLADE, AMP EDGE, AMPEEZ, AMP FAS-N-FAST, AMP-FIT, AMPILLUME, AMP-IN, AMP-INCERT, AMPIP, AMP-LEAF, AMPLI-BOND, AMPLIMATE, AMPLIMITE, AMPLI-PRESS, AMPLIVAR, AMP-LOK, AMPMODU, AMP-O-LECTRIC, AMP-O-MATIC, AMPOMATOR, AMPPOWER, AMPSULATION, AMP-TAB, AMP-TAPEMATIC, AMP-TAPETRONIC, AMP-TY, AMP UNYT, BOMB-TAIL, CAPITRON, CERTI-CRIMP, CHAMP, CIRCUITIP, COAXICLAMP, COAXICON, COMBO LINE, COPALUM, DIAMOND GRIP, DUALATCH, DUO-TYNE, DYNA-CRIMP, ECONOMATE, ELECTRO-TAP, FASTIN-FASTON, FASTON, LANCELOK, MATE-N-LOK, PIDG, PLASTI-GRIP, SHUR-PLUG, SOLISTRAND, SPADE-LOK, SPIRAP, STRATO-THERM, T-HEAD, TAYP-AIR, TERMASHIELD, TERMI-BLOK, TERMI-FOIL, TERMI-GRID, TERMINYL, TERMI-PLATE, TERMI-POINT, TERMI-TWIST, ULTRAPOD.

COMPREHENSIVE TABLE OF CONTENTS

1	Terminals and Splices	1-1	Large size open barrel terminals for aluminum and copper wire 8 through 2 AWG	3-22
	Pre-insulated terminals with insulation restriction sleeve	1-2	Terminals and splices for use with aluminum foil	3-24
	PIDG (Pre-Insulated DIAMOND GRIP) Terminals		TERMI-FOIL Terminals and Splices	
	Terminals with various tongue configurations — ring, rectangular, spade, flanged spade, slotted ring, long spring spade, short spring spade — for wire size ranges 26-10, CMA 202-13,100 [.103-6.638 mm ²]	1-6	Self-stripping splice	3-32
	PIDG (Pre-Insulated DIAMOND GRIP), PLASTI-GRIP, DIAMOND GRIP, SOLISTRAND and Budget Terminals		AMP ELECTRO-TAP Splice	
	Ring tongue terminals for large wire size ranges 8-4/0, CMA 13,100-231,000 [6.638-117.057 mm ²]	1-56	4	Terminals and Splices for Automatic Machine Application
	AMPLIBOND, PLASTI-GRIP, TERMINYL and SOLISTRAND Terminals			4-1
	Ring tongue terminals for heavy-duty wire size ranges 8-1/0, CMA 13,100-119,500 [6.638-60.555 mm ²] ..	1-74	Closed barrel rings and spades	4-3
	Pre-Insulated Nylon and SOLISTRAND Terminals		Open barrel rings and spades	4-19
	Terminals with special tongue configurations for special wire sizes	1-77	Pins, plugs, posts, and receptacles	4-57
	PIDG (Pre-Insulated DIAMOND GRIP), PLASTI-GRIP, DIAMOND GRIP and SOLISTRAND Terminals		Splices, contacts, bobbin terminals and other special items	4-77
	Butt and parallel splices	1-86	Quick connect-disconnect splices, tab-type terminals, receptacles, connectors, fully pre-insulated receptacles, post-insulation pods, commoning blocks and in-line splices	
	PIDG (Pre-Insulated DIAMOND GRIP), PLASTI-GRIP, DIAMOND GRIP, SOLISTRAND and TERMINYL Splices		FASTON Terminal Line	4-103
	Splices for special wire sizes and spare wire caps	1-93	AMPIP Post Insulation Pods	4-136
	ECN, EC, VS, ECV, PIDG (Pre-Insulated DIAMOND GRIP), DIAMOND GRIP Splices and PIDG (Pre-Insulated DIAMOND GRIP) Spare Wire Caps		Insulation Sleeves	4-137
	Tooling	1-96	FASTIN-FASTON Connectors	4-138
			Ultra-fast Fully Insulated FASTON Receptacles	4-142
			ULTRAPOD Post Insulation Pods	4-144
			FASTON 187 Series Commoning Blocks and In-Line Splices	4-146
			Cross-reference	4-148
2	Terminals and Splices for High Temperature Applications	2-1	5	Special Terminals and Splices for Automatic Machine Application
	Terminals and splices for high temperature applications to 1200°F	2-3		5-1
	STRATO-THERM Terminals and Splices		Terminals and splices for coated copper and aluminum wire applications	5-3
			AMPLIVAR Splices and Terminals	
3	Terminals and Splices for Special Applications	3-1	6	General Purpose Connectors
	Terminals and Splices resistant to radiation and solvents	3-3		6-1
	Radiation Resistant/150°C Pre-Insulated Terminals and Splices		Connectors with self-cleaning contacts	6-3
	Terminals and splices for solid and stranded aluminum or copper wire	3-9	AMP-LOK Connectors	
	COPALUM Terminals and Splices		Tab-and-receptacle-type connectors	6-6
	Sealed terminals and splices for stranded aluminum wire	3-17	AMPEEZ Connectors	
	COPALUM Sealed Terminals and Splices		Connectors with hermaphroditic contacts	6-8
	Disconnect terminal for fine stranded aluminum wire	3-20	AMP-UNYT Connectors	
	COPALUM Welding Cable Disconnect		Connectors with hermaphroditic housings and contact design	6-10
			Power Lock Connectors	
			Non-circuit breaking connectors	6-16
			AMP High Current Connectors	
			Cross-reference	6-18
			7	Insulation Displacement Connectors
				7-1
			CHAMP Cable Connectors	7-3
			Lace-n-lok Wire to Post Connectors	7-21
			8	Special Application Connectors
				8-1
			Relay sockets with crimp-type receptacles	8-3
			Cluster Blocks	8-7

Test connectors and fixtures	8-10
Vending machine coin changer connector	8-14
Fluorescent tube socket	8-16
Fiber optic bundle connector	8-18
Power cord receptacle	8-20
TERMI-BLOK Connectors	8-22
Top and side entry and vertical mount types	
Cross-reference	8-28

9 Pin and Socket Connectors 9-1

Rectangular self-locking connectors for mounted and free hanging applications	9-3
Universal MATE-N-LOK Connectors	
Self-locking connectors for mounted and free hanging applications	9-13
Commercial MATE-N-LOK Connectors include single and dual lance types, European style and 25 ampere versions with .140 dia. contacts	
Self-locking connectors for mounted and free hanging automotive applications	9-38
MATE-N-LOK Connectors for Automotive Industry	
Circular self-locking connectors for mounted and free hanging applications	9-45
COMBO LINE Connectors	
Miniature rectangular connectors	9-49
MR Series Connectors	
Program of contact interchangeability within various AMP connector families	9-63
Multi-Mate Contact-Connector Assemblies	
Multiple-position connectors for general purpose applications	9-69
“M” Series Pin and Socket Connectors	
Circular plastic connectors	9-149
CPC Series Connectors	
True metric specification connectors for rack and panel applications	9-179
MI Series Connectors	
D, DD, W & WW Series pin and socket connectors	9-185
Rack and panel connectors per ARINC Spec. 404 and MIL-C-81659	9-211
Rack and panel connectors with EMI filtering	9-245
High-density rectangular connectors	9-249
HDR Series Connectors	
High-density metal shell connectors for special applications	9-265
AMPLIMITE HD-20 & HD-22 Series Connectors	
High-density right angle all-plastic connectors for printed circuit applications	9-287
AMPLIMITE HDP-20 Series Connectors	
High-density metal shell connector for flexible flat cable applications	9-291
AMPLIMITE HDF-20 Series Connector	
Subminiature rectangular and circular connectors for Type VII pin and socket contacts	9-295
Pin and socket breakaway splices	9-298

10 Modular Connectors 10-1

Connector assemblies for 1, 2 or 3 multiple-position modules	10-3
“G” Series Pin and Socket Connectors	
Zero Insertion Force connectors for crimp snap-in, insulation displacement and posted contact modules	10-15
CR Series Connectors	
Cross-reference	10-26

11 Hermaphroditic Contact Connectors 11-1

Connectors with standard or miniature hermaphroditic contacts	11-3
DUALATCH Connectors	
Cross-reference	11-33

12 Flexible Flat Cable Products 12-1

Connectors for flexible flat cable termination include single and double-row connectors, PC edge connectors and flexible flat cable jumper assemblies	12-3
AMP Latch connectors including card edge, receptacle (female), paddle board plug, right-angle pin header and plug (male) connectors	12-23
Design capabilities for flexible etched circuitry, flexible flat transmission cable and high current flat cable	12-37
Cross-reference	12-42

13 Printed Circuit Connectors 13-1

Two-piece printed circuit edge connectors, blade type contacts	13-3
AMP-BLADE Connectors	
Two-piece board to board box contact connectors	13-9
Box Contact Connectors	
Two-piece board to board or wire to board rib and beam type contact connectors	13-31
AMP-MECA Subminiature Connectors	
One-piece dual and quad position edge connectors, tab type contacts	13-36
AMP-TAB Connectors	
Two-piece connector system, bayonet-type contacts	13-42
TERMI-GRID Connectors	
One-piece printed circuit edge connectors, leaf type contacts	13-47
AMP-LEAF Connectors	
One-piece edge connectors, bifurcated leaf type contacts	13-59
Twin Leaf Connectors	
One-piece board to board connectors, bifurcated leaf type contacts	13-66
Twin Leaf Mother Board Connectors	
One-piece card entry edge connector, bifurcated contacts for point-to-point wiring applications	13-76
TERMI-TWIST Connectors	
One-piece card entry connectors, bifurcated contacts with .025” sq. termination technology for point-to-point wiring	13-83
Wrap-Type Printed Circuit Connectors	
One-piece card entry connectors for aluminum panel mounting	13-90
TERMI-PLATE Connectors	

Modified fork connectors	13-92
Bifurcated Leaf-Type Contact Connectors	13-95
Flag type one-piece edge connectors	13-100
DUO-TYNE Connectors	
Multiple Tap edge connectors	13-102
AMP Wrap Connectors with .025" sq. posts	13-105
Economy Wrap Connectors with .025" sq. posts	13-109
Low Profile one-piece board to board or wire to board connectors	13-115
Commercial printed circuit board connector, leaf type contacts	13-126
High current edge connector	13-128
Printed circuit connector hood assemblies	13-130
Laminar board to board interconnect system	13-133
Resistance Soldered Bus Strips	13-138
Cross-reference	13-140

14 Interconnection Packaging Devices and Accessories 14-1

Modular systems for electrical/electronic circuit interconnection	14-3
AMPMODU Interconnection System	
Locking Clip Connector	14-89
AMPMODU Locking Clip Connector	
Commercial Interconnection System	14-97
Dual in-line Package (DIP) Sockets, Strip Receptacles and Substrate Sockets	14-104
Low Profile, 42 position, leaded substrate connector	14-120
Integrated circuit receptacles	14-122
Dual In-Line Package (DIP) and transistor receptacles	14-126
Miniature spring sockets for component mounting	14-128
Reusable Component Test Receptacles for solderless component insertion	14-135
Chevron-shaped contact connectors for maximum packaging density	14-137
Printed circuit board disconnects	14-143
Printed circuit board receptacle	14-146
Printed circuit board fillets	14-148
Special terminals for component-to-board mounting	14-150
CIRCUITIP Terminals	
Single lead terminals for lead-to-board soldering and single lead connect/disconnect terminals for slotted board edges	14-152
AMP-IN and AMP EDGE Single Lead Printed Circuit Terminals	
Test Probe receptacles	14-155
Component module clip	14-157
Miniature single lead terminals for lead-to-board soldering	14-159
Miniature AMP-IN Terminals	

15 Printed Circuit Panels and Components 15-1

Standard IC Panels	15-3
Panels and components featuring action pin	15-9
AMP ECONOMATE Panels and Components	

16 Multiple Position Coaxial Connectors 16-1

Multiple COAXICON Connectors	16-3
Multiple coaxial connectors general information	16-4
Coaxial contact specifications	16-19
Standard housing specifications	16-23
Twin standard housing specifications	16-26
Miniature housing specifications	16-29
Subminiature housing specifications	16-34
Coaxial connector hardware specifications	16-36
Typical housing assemblies	16-48
Latching connector	16-52
Miniature and subminiature sockets for printed circuit boards	16-56
Coaxial ribbon cable assemblies and printed circuit board connectors	16-59

17 RF Connectors 17-1

BNC Series — Dual and single crimp types with bayonet-lock coupling for quick connect and disconnect	17-3
TNC Series — Dual and single crimp types with threaded coupling	17-12
N Series per MIL-C-39012, Class II, Category B	17-18
C Series 50 ohm connector	17-22
SMA Series — Semi-rigid cable	17-25
SMA Series — Flexible cable	17-29
SMC Series Connectors	17-33
SHV Series	17-35
UHF plug connectors for use at up to 500 MHz, 500 volts	17-37
Threaded Series coaxial connectors — Standard and miniature contacts	17-40
RF twin conductor types — Twin threaded, twin BNC and twin connector plug	17-42
TERMASHIELD Ferrules and Splices for shielded and coaxial wire	17-44
Braid-Pic Contacts and Receptacles for coaxial cable to printed circuit board terminations	17-51

18 Patchcord Programming Systems and Panels 18-1

Universal patchcord programming systems	18-3
Standard patchcord programming systems	18-43
Coaxial patchcord systems for critical low-level applications	18-69
Hybrid patchcord programming systems — one system permits complete signal, power & coaxial circuits, plus special low profile version which fits a standard 19" rack	18-73

Low capacitance shielded patchcord programming systems	18-79
RF patch panels and patchcords	18-84

19 CAPITRON Products

Tabulating card readers, Model 2980A and 2981A	19-3
Reader-Scanner assembly for serial output	19-7
Tabulating card readers, Model 2900A and 2901A	19-9
Credit card and badge readers, manually operated and solenoid powered	
Model 360,361 and all weather	19-13
Model 61, 161 and 261	19-17
Model 130	19-20
Hand card punch and cards	19-22
Magnetic card readers	
Model 210	19-24
Model 75	19-26
High voltage lead assemblies, receptacles and connectors	19-28
LGH High Voltage Lead Assemblies and Receptacles	
High voltage power supplies	
20 KV Multiple-Output CRT	19-77
5 VDC, 65 Ampere Multiple-Output	19-79
Hermetically Sealed Driver TWT	19-81
Miniature Hermetically Sealed CRT	19-83
Fast Switching, 8 KV to 16 KV	19-85
35 KV Multiple Output CRT	19-87
Hermetically Sealed Miniature CRT	19-89

20 Switches and Relays

Dual In-Line Package Switches	20-3
7000, 7010, 7020, 7030 and 7040 Series	20-7
7100 and 7130 Series	20-12
7200, 7240 and 7250 Series	20-14
7400 Series	20-17
7600 Series	20-19
Rotary Printed Circuit Board Switches	20-21
Accessories	20-23
Recommended soldering and cleaning processes	20-24
Printed Circuit Board Rotary Switches	
6000 Series	20-25
Thumbwheel Switches	
5000 Series	20-29
Multi-Layer Rotary Switch	
3000 Series	20-52
Pull-to-set switch	20-54
Coded and Decimal Slide Switches	20-57
Matrix Slide Switches	20-61
Mini-Matrix Slide Switch	20-65
Electromechanical Relay, two DPDT	20-67

21 Pinboard Programming

Components for matrix pinboard applications	21-3
Matrix and Universal Pinboards	

22 Point-to-Point Wiring

Automatic machine, hand tools and clips	22-3
TERMI-POINT System II Automatic Machine, Hand Tools and Clips	

23 Taper Technique Products

Taper Technique products general information	23-3
Formed taper pins and receptacles	23-8
Solid taper pins	23-13
Taper pin blocks, nylon housings, 10, 20, 30, 40, 50, 60, and 101 cavities	23-18
Insertion and extraction tools, reamer and gauges	23-29
Taper tab receptacles, 78 and 98 Series	23-30

24 Products for Microelectronics

Stamped lead frames for IC configurations, LED displays, power and signal transistors	24-3
AMP lead frames	24-6
Substrate clips for thick film hybrid circuits	24-10
AMP Elastomate Connector	24-12
Micrometallization-photochemical processes for micro-miniaturized flexible circuitry	24-14

25 Heat Shrinkable Products

Thick wall heat shrinkable products	25-3
Heat shrinkable plastic insulation tubing	25-9
AMPSULATION Tubing	

26 Indicator Lights

Self-mounting neon and incandescent lights	26-3
250V, 125V, 6.3V, 12V and 24V AC/DC neon and incandescent	
515 Series AMPILLUME Indicator Lights	26-5
125V and 250V neon	
312 Series AMPILLUME Indicator Lights	26-6

27 Cable Ties and Bundling

Self-locking cable ties for indoor and outdoor use and available with mounting clamps	
AMP-TY Cable Ties	27-3
AMP-TY All-Plastic Cable Ties	27-5
AMP-TY Stainless Steel Cable Ties	27-7
Plastic cable wrap for individual bundling, color-coded for easy identification	27-9
SPIRAP Plastic Cable Wrap	

28 Miscellaneous Products, Application Tooling and Numerical Index

AMP-FIT Tube Fittings	28-3
Duplex Receptacles	28-7
Circuit Analyzer	28-15
Fas-N-Fast Plastic Panel Nut	28-16
Timer Connector	28-17
Tooling	28-20
Numerical Index	28-42

FROM THE FIRST ENGINEERED SOLDERLESS TERMINAL ...TO AMPECONOMATION

Just 35 years ago, AMP Incorporated pioneered a dependable means for connecting the wires used in electrical circuits. From the start, the AMP patented solderless terminal and controlled-pressure crimping tool offered a degree of connecting speed, efficiency and uniformity not possible with existing methods of wire wrapping, twisting or soldering. For the first time, wire connections engineered to precise tolerances for specific applications were available to promote overall circuit integrity.

Today, AMP Incorporated is the largest worldwide producer of more than 45,000 different solderless

terminals, splices and other inter-connection devices. AMP also produces patchboards, pinboards, card readers, and similar electrical and electronic components. Together with precision tooling and high-speed automatic application machines, these engineered devices are backed by over 6,600 patents, issued or pending, in the U. S. and throughout the world. Wherever electricity serves business, industry and the home — in aerospace and military electronics, in computers and business machines, appliances and consumer goods, in transportation and communications — AMP products and techniques are establishing new standards in per-

formance reliability and production economies for original equipment manufacturers.

In addition to serving OEM markets, AMP also provides products and services for specialized industries such as the gas, electric and telephone utilities, and for replacement and repair markets. Sales and service to special industries and the after-market are made available to customers anywhere in the world through AMP Special Industries Division, in the U.S.A. and the AMPLIVERSAL Divisions of AMP's worldwide subsidiary companies.

WORLDWIDE MANUFACTURING FACILITIES

The AMP products listed throughout this Engineering and Buying Guide are available from AMP's headquarters plant in Harrisburg, Pennsylvania, the hub of a 30-plant manufacturing network in Central Pennsylvania plus other facilities in Virginia, North Carolina and Florida. To assure a ready supply of product wherever dependable connections are required, AMP subsidiary plants and distribution centers are strategically located throughout the world. Identical facilities and manufacturing techniques are employed at every AMP plant, to assure consistent production quality and performance reliability of end product wherever it is used.

These facilities include the latest equipment for automated production, and for product testing and quality control at every stage of manufacture. AMP's capabilities for plastics molding, precision plating, and stamping and forming are known throughout the industry. Stamping and forming facilities and methods permit precision production of the most intricate parts to exacting tolerances. Advanced plating techniques make it possible to maintain close tolerances in the widest range of metals, including gold and platinum — or to selectively plate at specified points to substantially reduce plating costs.

At AMP, every step in production — from quality checks on raw materials, through successive manufacturing operations, to final preshipping inspections — is designed to ensure that products will perform to the most demanding specifications. Consistently. The AMP trademark, clearly stamped or printed on every AMP product, is your guarantee of unquestioned product quality and reliability.

RESEARCH, DEVELOPMENT & ENGINEERING

At AMP, research begins with the customer. AMP Sales Engineers in the field keep constantly alert to new customer needs, gathering facts to relay to company headquarters for analysis and initial experimental development. Here, AMP personnel, using advanced methods and equipment, develop solutions in prototype. From each prototype AMP's Product Engineers apply their specialized skills to produce a practical and realistic product solution to meet the most exacting criteria. The result is a new product or technique "pre-engineered" to the application, a cost-saving solution to a specific customer's problem and a significant innovation in termination technology to benefit industry in general.

A typical example is the AMP Magnet Wire Interconnect System which brings Insulation Displacement Technology to magnet wire termination. The 1970's brought about the need for more reliable and more economical interconnections — the insulation displacement termination answered that need by introducing industry's first mass termination application. This technique eliminates the need for prestripping the conductors. Insulated wire is simply positioned into the uppermost portion of the terminating slot. The application tooling pushes the wire deeper into position. Now, the "funnel-shaped" area of the slot displaces the insulation and constricts the bare conductor. Additional downward movement of the tooling forces the conductor into the confines of the narrow parallel portion of the slot. This action provides a "wipe-clean" surface for positive electrical contact free of oxides and other contaminants.

By utilizing the same concept **in reverse**, that is, by driving the terminal over a prepositioned wire instead of driving the wire into a terminal, a terminating system is achieved that can automate magnet wire interconnections and be compatible with today's automatic assembly equipment.

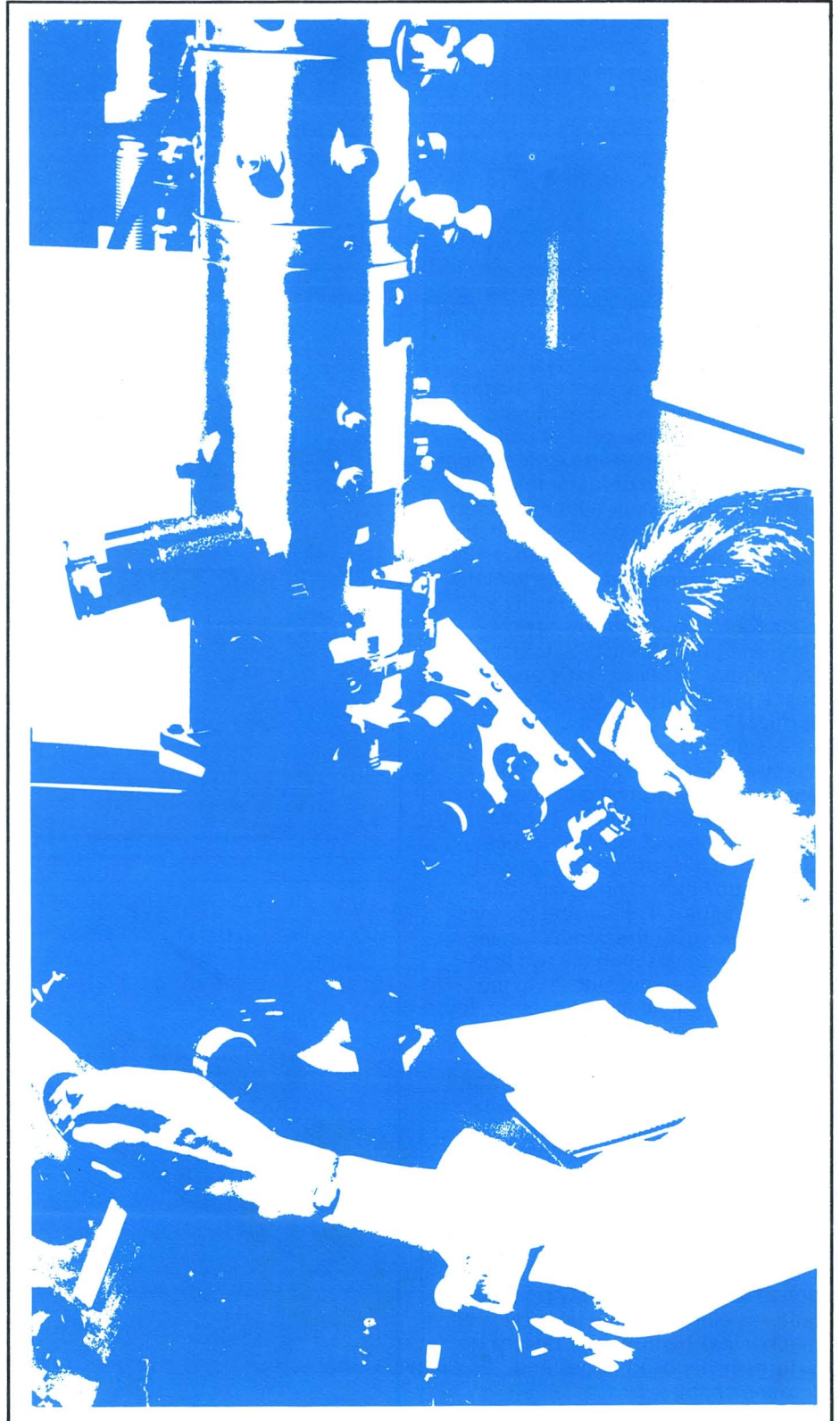

How the system operates

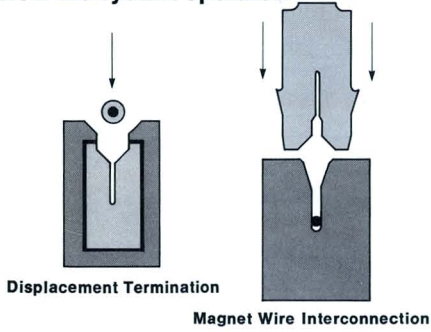

In conjunction with AMP Incorporated, the manufacturer designs plastic cavities to accept the magnet wires and interconnect terminals. For example, in the case of coil windings the cavities are molded right on the coil bobbin or for motor stator applications they are attached to the lamination stack in the vicinity of the magnet wire coil. Each plastic cavity that the manufacturer molds to fit his specific application is basically a rectangular hole with two narrow slots on opposed walls. Within the rectangular cavity a plastic anvil or post extends upward from the bottom surface. To terminate, the magnet wire is placed across the plastic cavity and into the opposing slots. The magnet wire is held in position by a low force, friction fit. The magnet wire interconnect terminal is then positioned over the conductor and the plastic cavity. The terminating process begins by inserting the terminal down over the conductor. In one continuous action the two insulation displacement slots strip the magnet wire insulation, constrict the conductor and provide the necessary "wipe-clean" action for excellent electrical continuity. While this operation is taking place the molded-in plastic anvil extending from the bottom of the cavity is holding the magnet wire in the proper position to assure a positive termination. Additional stability of the terminal is maintained by built-in locking lances on the terminal. This overall combination of terminal and cavity retention features eliminates the possibility of mechanical disturbance due to externally imposed forces and torques on the wire.

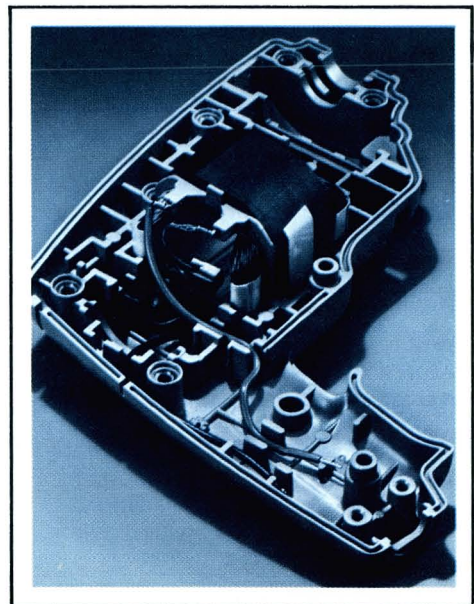
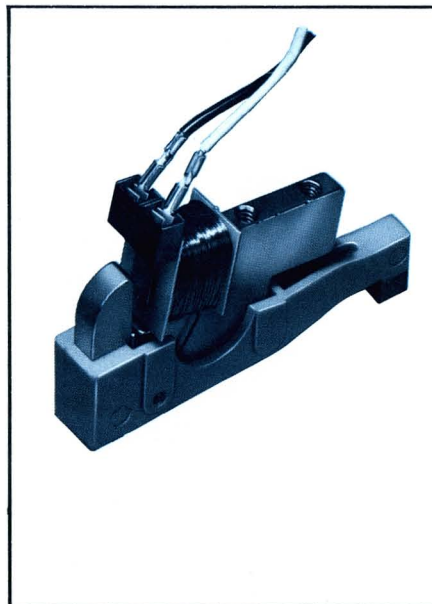
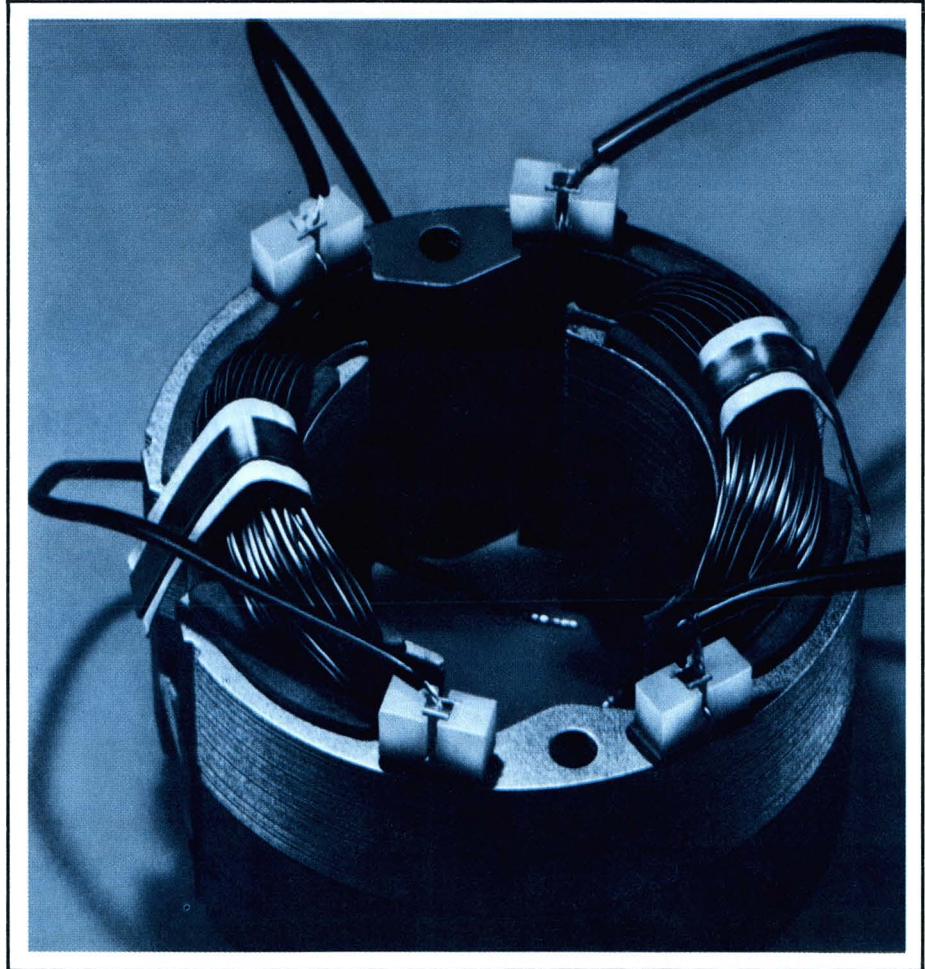

DECIMAL-INCH TO MILLIMETRE CONVERSION

Typical Application
 10.847" = ? MM
 10.000" = 254 MM
 .847" = 21.5138 MM
 10.847" = 275.5138 MM

Inches	Whole Inches									
	0	1.0	2.0	3.0	4.0	5.0	6.0	7.0	8.0	9.0
	Millimetres									
0	0	25.4	50.8	76.2	101.6	127	152.4	177.8	203.2	228.6
10.0	254	279.4	304.8	330.2	355.6	381	406.4	431.8	457.2	482.6
20.0	508	533.4	558.8	584.2	609.6	635	660.4	685.8	711.2	736.6
30.0	762	787.4	812.8	838.2	863.6	889	914.4	939.8	965.2	990.6
40.0	1016	1041.4	1066.8	1092.2	1117.6	1143	1168.4	1193.8	1219.2	1244.6
50.0	1270	1295.4	1320.8	1346.2	1371.6	1397	1422.4	1447.8	1473.2	1498.6
60.0	1524	1549.4	1574.8	1600.2	1625.6	1651	1676.4	1701.8	1727.2	1752.6
70.0	1778	1803.4	1828.8	1854.2	1879.6	1905	1930.4	1955.8	1981.2	2006.6
80.0	2032	2057.4	2082.8	2108.2	2133.6	2159	2184.4	2209.8	2235.2	2260.6
90.0	2286	2311.4	2336.8	2362.2	2387.6	2413	2438.4	2463.8	2489.2	2514.6
100.0	2540									
	Inches									
Inches	0	.001	.002	.003	.004	.005	.006	.007	.008	.009
	Millimetres									
0	0	0.0254	0.0508	0.0762	0.1016	0.127	0.1524	0.1778	0.2032	0.2286
.01	0.254	0.2794	0.3048	0.3302	0.3556	0.381	0.4064	0.4318	0.4572	0.4826
.02	0.508	0.5334	0.5588	0.5842	0.6096	0.635	0.6604	0.6858	0.7112	0.7366
.03	0.762	0.7874	0.8128	0.8382	0.8636	0.889	0.9144	0.9398	0.9652	0.9906
.04	1.016	1.0414	1.0668	1.0922	1.1176	1.143	1.1684	1.1938	1.2192	1.2446
.05	1.27	1.2954	1.3208	1.3462	1.3716	1.397	1.4224	1.4478	1.4732	1.4986
.06	1.524	1.5494	1.5748	1.6002	1.6256	1.651	1.6764	1.7018	1.7272	1.7526
.07	1.778	1.8034	1.8288	1.8542	1.8796	1.905	1.9304	1.9558	1.9812	2.0066
.08	2.032	2.0574	2.0828	2.1082	2.1336	2.159	2.1844	2.2098	2.2352	2.2606
.09	2.286	2.3114	2.3368	2.3622	2.3876	2.413	2.4384	2.4638	2.4892	2.5146
.10	2.54	2.5654	2.5908	2.6162	2.6416	2.667	2.6924	2.7178	2.7432	2.7686
.11	2.794	2.8194	2.8448	2.8702	2.8956	2.921	2.9464	2.9718	2.9972	3.0226
.12	3.048	3.0734	3.0988	3.1242	3.1496	3.175	3.2004	3.2258	3.2512	3.2766
.13	3.302	3.3274	3.3528	3.3782	3.4036	3.429	3.4544	3.4798	3.5052	3.5306
.14	3.556	3.5814	3.6068	3.6322	3.6576	3.683	3.7084	3.7338	3.7592	3.7846
.15	3.81	3.8354	3.8608	3.8862	3.9116	3.937	3.9624	3.9878	4.0132	4.0386
.16	4.064	4.0894	4.1148	4.1402	4.1656	4.191	4.2164	4.2418	4.2672	4.2926
.17	4.318	4.3434	4.3688	4.3942	4.4196	4.445	4.4704	4.4958	4.5212	4.5466
.18	4.572	4.5974	4.6228	4.6482	4.6736	4.699	4.7244	4.7498	4.7752	4.8006
.19	4.826	4.8514	4.8768	4.9022	4.9276	4.953	4.9784	5.0038	5.0292	5.0546
.20	5.08	5.1054	5.1308	5.1562	5.1816	5.207	5.2324	5.2578	5.2832	5.3086
.21	5.334	5.3594	5.3848	5.4102	5.4356	5.461	5.4864	5.5118	5.5372	5.5626
.22	5.588	5.6134	5.6388	5.6642	5.6896	5.715	5.7404	5.7658	5.7912	5.8166
.23	5.842	5.8674	5.8928	5.9182	5.9436	5.969	5.9944	6.0198	6.0452	6.0706
.24	6.096	6.1214	6.1468	6.1722	6.1976	6.223	6.2484	6.2738	6.2992	6.3246
.25	6.35	6.3754	6.4008	6.4262	6.4516	6.477	6.5024	6.5278	6.5532	6.5786
.26	6.604	6.6294	6.6548	6.6802	6.7056	6.731	6.7564	6.7818	6.8072	6.8326
.27	6.858	6.8834	6.9088	6.9342	6.9596	6.985	7.0104	7.0358	7.0612	7.0866
.28	7.112	7.1374	7.1628	7.1882	7.2136	7.239	7.2644	7.2898	7.3152	7.3406
.29	7.366	7.3914	7.4168	7.4422	7.4676	7.493	7.5184	7.5438	7.5692	7.5946
.30	7.62	7.6454	7.6708	7.6962	7.7216	7.747	7.7724	7.7978	7.8232	7.8486
.31	7.874	7.8994	7.9248	7.9502	7.9756	8.001	8.0264	8.0518	8.0772	8.1026
.32	8.128	8.1534	8.1788	8.2042	8.2296	8.255	8.2804	8.3058	8.3312	8.3566
.33	8.382	8.4074	8.4328	8.4582	8.4836	8.509	8.5344	8.5598	8.5852	8.6106
.34	8.636	8.6614	8.6868	8.7122	8.7376	8.763	8.7884	8.8138	8.8392	8.8646
.35	8.89	8.9154	8.9408	8.9662	8.9916	9.017	9.0424	9.0678	9.0932	9.1186
.36	9.144	9.1694	9.1948	9.2202	9.2456	9.271	9.2964	9.3218	9.3472	9.3726
.37	9.398	9.4234	9.4488	9.4742	9.4996	9.525	9.5504	9.5758	9.6012	9.6266
.38	9.652	9.6774	9.7028	9.7282	9.7536	9.779	9.8044	9.8298	9.8552	9.8806
.39	9.906	9.9314	9.9568	9.9822	10.0076	10.033	10.0584	10.0838	10.1092	10.1346
.40	10.16	10.1854	10.2108	10.2362	10.2616	10.287	10.3124	10.3378	10.3632	10.3886
.41	10.414	10.4394	10.4648	10.4902	10.5156	10.541	10.5664	10.5918	10.6172	10.6426
.42	10.668	10.6934	10.7188	10.7442	10.7696	10.795	10.8204	10.8458	10.8712	10.8966
.43	10.922	10.9474	10.9728	10.9982	11.0236	11.049	11.0744	11.0998	11.1252	11.1506
.44	11.176	11.2014	11.2268	11.2522	11.2776	11.303	11.3284	11.3538	11.3792	11.4046
.45	11.43	11.4554	11.4808	11.5062	11.5316	11.557	11.5824	11.6078	11.6332	11.6586
.46	11.684	11.7094	11.7348	11.7602	11.7856	11.811	11.8364	11.8618	11.8872	11.9126
.47	11.938	11.9634	11.9888	12.0142	12.0396	12.065	12.0904	12.1158	12.1412	12.1666
.48	12.192	12.2174	12.2428	12.2682	12.2936	12.319	12.3444	12.3698	12.3952	12.4206
.49	12.446	12.4714	12.4968	12.5222	12.5476	12.573	12.5984	12.6238	12.6492	12.6746

DECIMAL-INCH TO MILLIMETRE CONVERSION

Inches	Inches									
	0	.001	.002	.003	.004	.005	.006	.007	.008	.009
	Millimetres									
.50	12.7	12.7254	12.7508	12.7762	12.8016	12.827	12.8524	12.8778	12.9032	12.9286
.51	12.954	12.9794	13.0048	13.0302	13.0556	13.081	13.1064	13.1318	13.1572	13.1826
.52	13.208	13.2334	13.2588	13.2842	13.3096	13.335	13.3604	13.3858	13.4112	13.4366
.53	13.462	13.4874	13.5128	13.5382	13.5636	13.589	13.6144	13.6398	13.6652	13.6906
.54	13.716	13.7414	13.7668	13.7922	13.8176	13.843	13.8684	13.8938	13.9192	13.9446
.55	13.97	13.9954	14.0208	14.0462	14.0716	14.097	14.1224	14.1478	14.1732	14.1986
.56	14.224	14.2494	14.2748	14.3002	14.3256	14.351	14.3764	14.4018	14.4272	14.4526
.57	14.478	14.5034	14.5288	14.5542	14.5796	14.605	14.6304	14.6558	14.6812	14.7066
.58	14.732	14.7574	14.7828	14.8082	14.8336	14.859	14.8844	14.9098	14.9352	14.9606
.59	14.986	15.0114	15.0368	15.0622	15.0876	15.113	15.1384	15.1638	15.1892	15.2146
.60	15.24	15.2654	15.2908	15.3162	15.3416	15.367	15.3924	15.4178	15.4432	15.4686
.61	15.494	15.5194	15.5448	15.5702	15.5956	15.621	15.6464	15.6718	15.6972	15.7226
.62	15.748	15.7734	15.7988	15.8242	15.8496	15.875	15.9004	15.9258	15.9512	15.9766
.63	16.002	16.0274	16.0528	16.0782	16.1036	16.129	16.1544	16.1798	16.2052	16.2306
.64	16.256	16.2814	16.3068	16.3322	16.3576	16.383	16.4084	16.4338	16.4592	16.4846
.65	16.51	16.5354	16.5608	16.5862	16.6116	16.637	16.6624	16.6878	16.7132	16.7386
.66	16.764	16.7894	16.8148	16.8402	16.8656	16.891	16.9164	16.9418	16.9672	16.9926
.67	17.018	17.0434	17.0688	17.0942	17.1196	17.145	17.1704	17.1958	17.2212	17.2466
.68	17.272	17.2974	17.3228	17.3482	17.3736	17.399	17.4244	17.4498	17.4752	17.5006
.69	17.526	17.5514	17.5768	17.6022	17.6276	17.653	17.6784	17.7038	17.7292	17.7546
.70	17.78	17.8054	17.8308	17.8562	17.8816	17.907	17.9324	17.9578	17.9832	18.0086
.71	18.034	18.0594	18.0848	18.1102	18.1356	18.161	18.1864	18.2118	18.2372	18.2626
.72	18.288	18.3134	18.3388	18.3642	18.3896	18.415	18.4404	18.4658	18.4912	18.5166
.73	18.542	18.5674	18.5928	18.6182	18.6436	18.669	18.6944	18.7198	18.7452	18.7706
.74	18.796	18.8214	18.8468	18.8722	18.8976	18.923	18.9484	18.9738	18.9992	19.0246
.75	19.05	19.0754	19.1008	19.1262	19.1516	19.177	19.2024	19.2278	19.2532	19.2786
.76	19.304	19.3294	19.3548	19.3802	19.4056	19.431	19.4564	19.4818	19.5072	19.5326
.77	19.558	19.5834	19.6088	19.6342	19.6596	19.685	19.7104	19.7358	19.7612	19.7866
.78	19.812	19.8374	19.8628	19.8882	19.9136	19.939	19.9644	19.9898	20.0152	20.0406
.79	20.066	20.0914	20.1168	20.1422	20.1676	20.193	20.2184	20.2438	20.2692	20.2946
.80	20.32	20.3454	20.3708	20.3962	20.4216	20.447	20.4724	20.4978	20.5232	20.5486
.81	20.574	20.5994	20.6248	20.6502	20.6756	20.701	20.7264	20.7518	20.7772	20.8026
.82	20.828	20.8534	20.8788	20.9042	20.9296	20.955	20.9804	21.0058	21.0312	21.0566
.83	21.082	21.1074	21.1328	21.1582	21.1836	21.209	21.2344	21.2598	21.2852	21.3106
.84	21.336	21.3614	21.3868	21.4122	21.4376	21.463	21.4884	21.5138	21.5392	21.5646
.85	21.59	21.6154	21.6408	21.6662	21.6916	21.717	21.7424	21.7678	21.7932	21.8186
.86	21.844	21.8694	21.8948	21.9202	21.9456	21.971	21.9964	22.0218	22.0472	22.0726
.87	22.098	22.1234	22.1488	22.1742	22.1996	22.225	22.2504	22.2758	22.3012	22.3266
.88	22.352	22.3774	22.4028	22.4282	22.4536	22.479	22.5044	22.5298	22.5552	22.5806
.89	22.606	22.6314	22.6568	22.6822	22.7076	22.733	22.7584	22.7838	22.8092	22.8346
.90	22.86	22.8854	22.9108	22.9362	22.9616	22.987	23.0124	23.0378	23.0632	23.0886
.91	23.114	23.1394	23.1648	23.1902	23.2156	23.241	23.2664	23.2918	23.3172	23.3426
.92	23.368	23.3934	23.4188	23.4442	23.4696	23.495	23.5204	23.5458	23.5712	23.5966
.93	23.622	23.6474	23.6728	23.6982	23.7236	23.749	23.7744	23.7998	23.8252	23.8506
.94	23.876	23.9014	23.9268	23.9522	23.9776	24.003	24.0284	24.0538	24.0792	24.1046
.95	24.13	24.1554	24.1808	24.2062	24.2316	24.257	24.2824	24.3078	24.3332	24.3586
.96	24.384	24.4094	24.4348	24.4602	24.4856	24.511	24.5364	24.5618	24.5872	24.6126
.97	24.638	24.6634	24.6888	24.7142	24.7396	24.765	24.7904	24.8158	24.8412	24.8666
.98	24.892	24.9174	24.9428	24.9682	24.9936	25.019	25.0444	25.0698	25.0952	25.1206
.99	25.146	25.1714	25.1968	25.2222	25.2476	25.273	25.2984	25.3238	25.3492	25.3746
1.00	25.4									

Wire Range AWG	Range mm ²	Common Size
26-22	0.1-0.4	0.14, 0.20, 0.25, 0.135
22-16	0.25-1.6	0.25, 0.35, 0.50, 0.75, 1.0, 1.5
16-14	1.0-2.6	1.0, 1.5, 2.5
16-14 HD*	1.0-2.6	1.0, 1.5, 2.5
12-10	2.7-6.6	4.0, 6.0
8	6.7-10.5	10
6	10.6-16.7	16
4	16.8-26.6	25
2	26.7-42.4	35

Wire Range AWG	Range mm ²	Common Size
1/0	43-60	50
2/0	61-76	70
3/0	77-96	95
4/0	97-120	120
250-300 MCM	121-151	150
300-350 MCM	152-192	185
400 MCM	193-242	240
500-600 MCM	243-304	300

* For 16-14 HD use 12-10 tooling

AMP DISTRICT SALES OFFICES

APPROVALS

To ensure that AMP products and tooling meet approved standards for both commercial and military applications, specifications specialists at AMP work closely with licensing agencies to keep abreast of new requirements, as well as anticipated changes.

Where a product is approved or listed by a specific licensing agency, appropriate approvals are noted in the particular product section.

BOSTON

Riverside Park - Suite 107
Weston, Ma. 02193
(617) 891-7500

ROCHESTER

57 Monroe Ave.
Pittsford, N.Y. 14534
(716) 385-2860

NEW YORK

1280 Rt. 46
Parsippany, N.J. 07054
(201) 334-6662

PHILADELPHIA

400 W. Swedesford Rd.
Berwyn, Pa. 19312
(215) 647-6060

WASHINGTON

421 King St.
Suite 222
Alexandria, Va. 22314

ATLANTA

2220 Parklake Dr., N.E.
Suite 485
Atlanta, Ga. 30345
(404) 934-6363

COLUMBUS

Landings Office Bldg.
Suite 207
3040 Riverside Dr.
Columbus, Oh. 43221
(614) 486-0276

DETROIT

30555 Southfield Rd.
Suite 440
Southfield, Mi. 48075
(313) 645-5590

CHICAGO

1050 Morse Ave.
Centex Industrial Park
Elk Grove Village, Il. 60007
(312) 439-5800

MINNEAPOLIS

4600 W. 77th St.
Room 312
Minneapolis, Mn. 55435
(612) 831-8242

DALLAS

P.O. Box 45168
(Frito Lay Tower - Suite 1439)
Exchange Park
Dallas, Tx. 75245
(214) 357-9151

LOS ANGELES

1840 S. Wilmington Ave.
Compton, Ca. 90220
(213) 537-4490

SAN FRANCISCO

10080 N. Wolfe Rd.
Bldg. S.W. 3
Cupertino, Ca. 95014
(408) 255-3830

AMP INCORPORATED
HARRISBURG, PA. 17105
Telephone: 717-564-0100
TWX: 510-657-4110

ENGINEERING NOTES

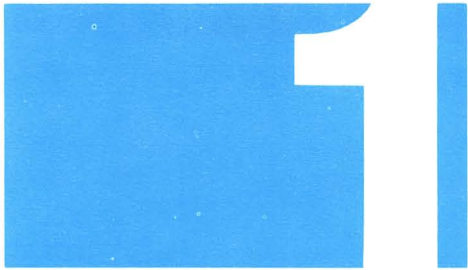

UNINSULATED TERMINALS & SPLICES

A comprehensive line of insulated and uninsulated crimp-on terminals and splices for solid and stranded wire. They are designed to accommodate a wide range of wire sizes and types for general and heavy-duty applications. Terminals are available with numerous tongue configurations for diversified use. Both terminals and splices are furnished on tape for machine termination and in loose piece for hand tool crimping.

Pre-insulated terminals with insulation restriction sleeve 1-2
 PIDG (Pre-Insulated DIAMOND GRIP) Terminals

Terminals with various tongue configurations — ring, rectangular, spade, flanged spade, slotted ring, long spring spade, short spring spade — for wire size ranges 26-10, CMA 202-13,100 [.103-6.638 mm²]. 1-6
 PIDG (Pre-Insulated DIAMOND GRIP), PLASTI-GRIP, DIAMOND GRIP, SOLISTRAND and Budget Terminals

Ring tongue terminals for large wire size ranges 8-4/0, CMA 13,100-231,000 [6.638-117.057 mm²]. 1-56
 AMPLIBOND, PLASTI-GRIP, TERMINYL and SOLISTRAND Terminals

Ring tongue terminals for heavy-duty wire size ranges 8-1/0, CMA 13,100-119,500 [6.638-60.555 mm²]. . . 1-74
 Pre-Insulated Nylon and SOLISTRAND Terminals

Terminals with special tongue configurations for special wire sizes 1-77
 PIDG (Pre-Insulated DIAMOND GRIP), PLASTI-GRIP, DIAMOND GRIP and SOLISTRAND Terminals

Butt and parallel splices 1-86
 PIDG (Pre-Insulated DIAMOND GRIP), PLASTI-GRIP, DIAMOND GRIP, SOLISTRAND and TERMINYL Splices

Splices for special wire sizes and spare wire caps 1-93
 ECN, EC, VS, ECV, PIDG (Pre-Insulated DIAMOND GRIP), DIAMOND GRIP Splices and PIDG (Pre-Insulated DIAMOND GRIP) Spare Wire Caps

Tooling 1-96

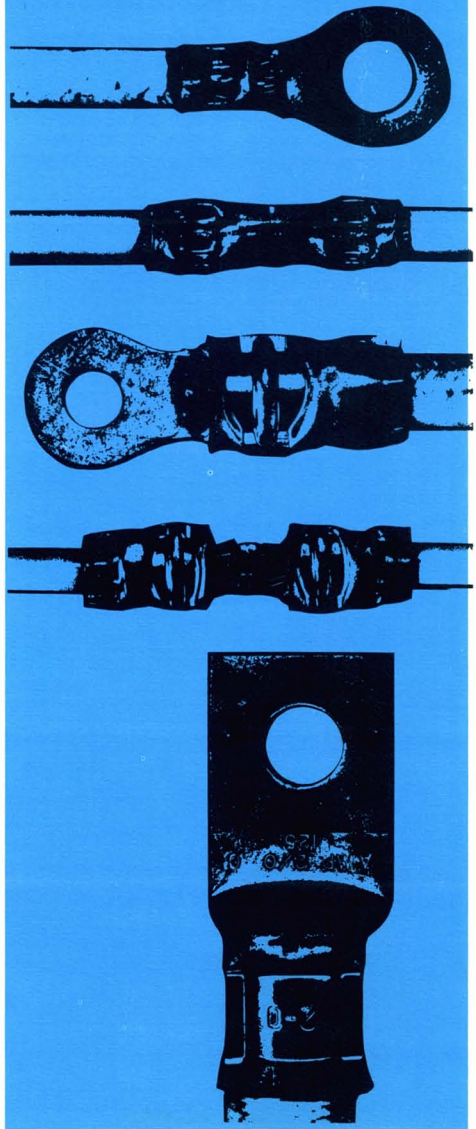

1 AMP

AMP Terminals and Splices

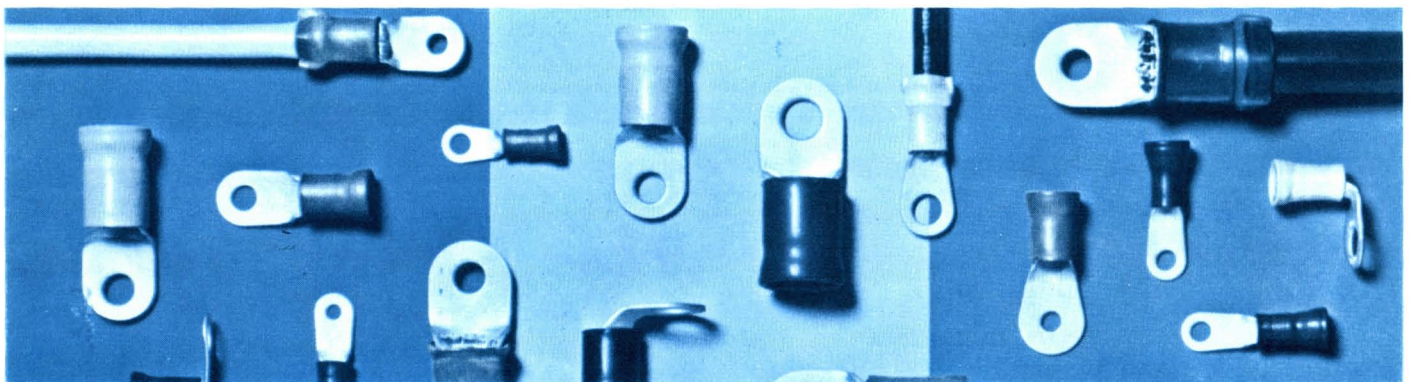
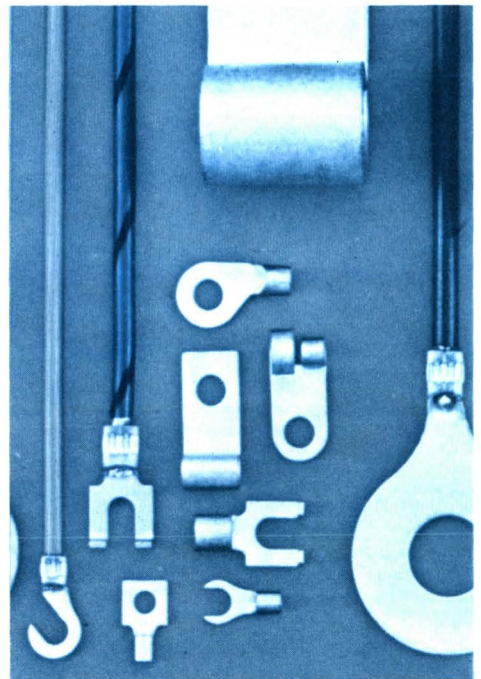
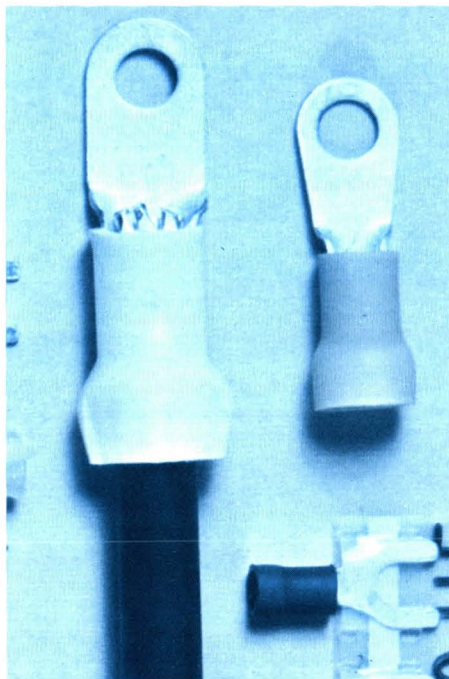
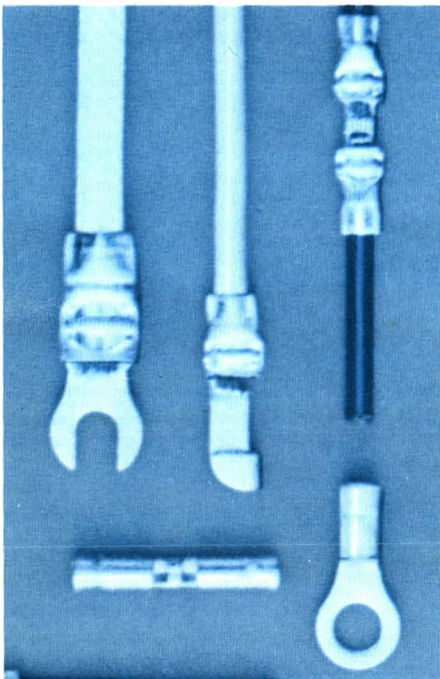
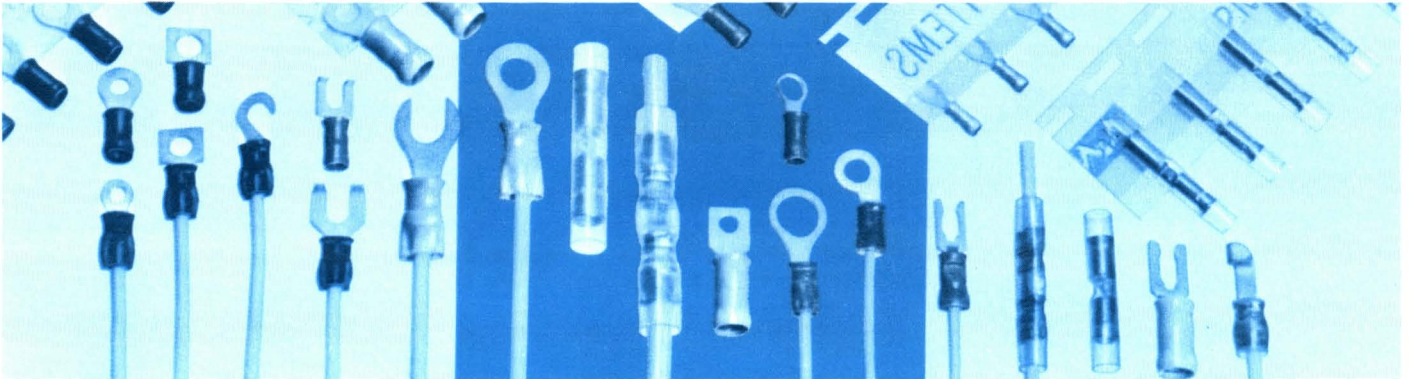

For all applications

AMP's solderless terminals and splices meet and exceed today's requirements for reliable terminations in applications ranging from control circuits to heavy duty power wiring. This catalog describes terminals and splices accommodating wire sizes 26 AWG through 600 MCM.

Specifications subject to change.
Consult AMP Incorporated for latest design specifications.

How to use this catalog

This catalog is designed for easy selection of terminal type to meet your requirement. All terminals and splices are cataloged by wire size by tongue type. In addition, each wire size and tongue type listed shows the complete family of pre-insulated and un-insulated terminals on easy to read full page spreads.

Insulation Color Code

Y	#26-22	Yellow
T	#24-20	Transparent
R	#22-16	Red
BL	#20-16 Heavy Duty	Blue
BL	#16-14	Blue
Y/K	#16-14 Heavy Duty	Yellow/ Black Stripe
BL	#14-12	Blue
Y	#12-10	Yellow
R	#8	Red
R	#8 Heavy Duty	Red
BL	#6	Blue
BL	#6 Heavy Duty	Blue
Y	#4	Yellow
Y	#4 Heavy Duty	Yellow
R	#2	Red
R	#2 Heavy Duty	Red
BL	#1/0	Blue
BL	#1/0 Heavy Duty	Blue
Y	#2/0	Yellow
R	#3/0	Red
BL	#4/0	Blue

For insulation color code on Special Terminals and Splices see individual product tabular data.

Ordering Information

All terminals and splices are listed according to wire size and type of terminal or splice. If the part number of the terminal or splice is known refer to the Numerical Index in the back of the catalog for page location of tabular data.

In the Tabular Data Section all parts which are available either individually or in tape-mounted form are identified by a dagger (†) following the part number. When ordering tape-mounted parts, specify the terminal or splice part number, the total quantity of parts required, the number of the tooling to be used and the type of packaging desired (if applicable). The table below lists by wire size the types of packaging available and the quantity per package for each AMP-TAPEMATIC tool.

Tool No.	Wire Size	Quantity and Type Package
69359-2 69370	#26-14 or #20-16 HD	1,000-box
	#12-10 or #16-14 HD	500-box
69118-1	#26-14	100-box
69875*	#26-22	10,000-reel 24" dia. 1,000-box
	#22-14 or #20-16 HD	5,000-reel 24" dia. 1,000-box
	#12-10 or #16-14 HD	2,500-reel 24" dia. 500-box
	#8 (Long Tongue)	1,000-reel 24" dia. 250-box
68075*	#26-14 or #20-16 HD	2,500-reel 17" dia.
	#12-10 or #16-14 HD	1,500-reel 17" dia.
	#26-14	1,000-box
68250-1	#12-10 or #16-14 HD	500-box
	#8	
	#6	500-reel 24" dia.
	#4	

*If box packaging is desired, a box holder, part number 305671, is required and must be purchased separately.

Note: Other items can be supplied in tape-mounted form. Consult AMP for information on special orders.

The PIDG Terminal

Here is a pre-insulated terminal designed for complete and uniform reliability in the most difficult circuit environments. Each PIDG Terminal consists of a basic copper plated body or phosphor bronze for the spring spade terminal, an extra wire support sleeve and an insulation sleeve. The design of the tool dies and the construction of the terminal insures uniform insulation thickness under crimping pressure, transmitting this pressure evenly to the center of the crimp area.

AMP PIDG Vinyl Terminals (Use type PIDG Tooling)

AMP Wire Range	424C Listed	Certified
22-16	22-16 Stranded	300 V Max., 105 C. Max.
16-14	16-14 Stranded	
12-10	12-10 Stranded	

Note: 22-16 terminals are stamped 22-18 in accordance with MIL-T-7928.

AMP PIDG Nylon Window Splice (Use type PIDG Tooling)

AMP Wire Range	424C Listed	Certified
22-16	22-18 Stranded	300 V Max., 105 C. Max.
16-14	16-14 Stranded	300 V Max., 105 C. Max.
12-10	12-10 Stranded	300 V Max., 105 C. Max.

Note: 22-16 terminals are stamped 22-18 in accordance with MIL-T-7928.

The PLASTI-GRIP Terminal

AMP's pre-insulated PLASTI-GRIP solderless terminals and splices have been designed specifically to answer the need for inexpensive but fully insulated electrical terminations. They can be used in almost every type of commercial application. The PLASTI-GRIP products described in this catalog accommodate wire sizes from 22 through 4/0. The appeal of PLASTI-GRIP products lies in their broad range of wire sizes, built-in pre-insulation, ease and speed of application, uniform reliability, and low installed cost.

AMP PLASTI-GRIP Terminals and Splices (Use type PLASTI-GRIP or PIDG tooling)

AMP Wire Range	424C Listed	Certified
22-16	Terminals & Butt Splices 22-16 Solid or Stranded	600 V Max. (1000 V Fixture or Sign) 90°C Max.
16-14	Terminals, Butt & Parallel Splices 16-14 Solid or Stranded	
12-10	Terminals, Butt & Parallel Splices 12-10 Solid or Stranded	

Note: 22-16 splices are stamped 22-18 in accordance with MIL-T-7928.

The DIAMOND-GRIP Terminal

The DIAMOND GRIP product line of terminals and splices is designed for completely uniform reliability under the most critical conditions of vibration, thermal shock, corrosion, tension, and current overload. AMP's mated tool/terminal concept represents a *total approach* to wire termination and takes into account all the factors of circuit termination.

The uniformity of appearance of AMP terminations is repeated by their uniformity in performance — made possible by designing the terminal and the tooling to match precisely. This promotes fast and easy crimping and assures precise crimping pressure for every wire size, regardless of the skill of the operator. The result is the best circuit termination at the lowest applied cost. And this is true for all terminations from first to last, week after week, month after month.

AMP DIAMOND GRIP Terminals and Splices (Use type DG Tooling)

AMP Wire Range	424C Listed	Certified
26-22		26-22 Stranded
22-16	22-16 Stranded	22-16 Stranded
16-14	16-14 Stranded	16-14 Stranded
16-14 HD	16-14 HD Stranded or Solid	
12-10	12-10 Stranded	12-10 Stranded

Note: 22-16 terminals and splices are stamped 22-18 in accordance with MIL-T-7928.

The AMPLI-BOND Terminal

Designed to accommodate wire gauges 8 through 4/0, AMPLI-BOND terminals were the first large wire terminals to feature vinyl insulation bonded to the terminal sleeve. Terminals for wire sizes #8 thru 4/0 meet the requirements of MIL-T-7928, Class II.

This is a precision-engineered terminal offering the heavy-duty wire user uniformly high quality connections with permanent insulation support and complete protection against flash over. AMPLI-BOND

The SOLISTRAND Terminal

Especially designed to terminate irregularly shaped, multiple-wire conductors, SOLISTRAND terminals and splices retain the superior performance characteristics of single-purpose terminals and splices. Because AMP's recommended matching tooling method is an integral part of production, each termination is uniformly perfect. Corrosion resistance, vibration resistance and tensile strength of these terminals and splices are well within the limits of commercial and military specifications. The SOLISTRAND line includes parallel, and butt splices, and flag, ring, spade, hooked, and flanged tongue terminals in sizes from 26 AWG through 600 MCM.

AMP SOLISTRAND Terminals and Splices (Use type "W" tooling)

AMP Wire Range	424C Listed	Certified
22-16 Solid or Stranded	22-16 Solid or Stranded	22-16 Solid or Stranded
16-14 Solid or Stranded	16-14 Solid or Stranded	16-14 Solid or Stranded
12-10 Solid or Stranded	12-10 Stranded	12-10 Solid or Stranded
8 thru 600 MCM Solid or Stranded	8 thru 600 MCM Stranded	8 thru 4/0 Solid or Stranded

Note: 22-16 terminals and splices are stamped 22-18 in accordance with MIL-T-7928.

terminals can be applied in a single effortless operation with the AMP DYNA-CRIMP tool.

Terminal insulators must withstand intense crimping pressures necessary for today's high wire-to-terminal contact requirements. Bonded insulation transmits this pressure evenly to the center of the crimp area. A positive bond assures uniform insulation thickness, maintains proper dielectric and tensile values and controls the extrusion of plastic under the crimping dies in the finished connection.

PRE-INSULATED TERMINALS WITH INSULATION RESTRICTION SLEEVE

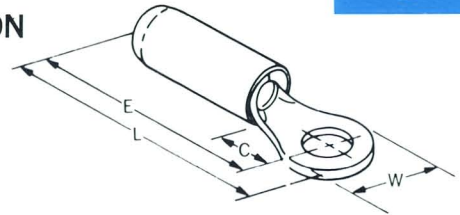

WIRE SIZE (AWG)	MAX. CONDUCTOR DIA.	INSUL. DIA. RANGE	INSUL. SLEEVE COLOR	INSUL. BAND COLOR	STUD SIZE	STUD CLEARANCE C MIN.	TONGUE WIDTH W	E MAX.	L MAX.	CATALOG NUMBER	
Y	#26	.021	.026-.055	Yellow	Black	#4	.211	.203	.587	.691	2-323914-3†
						#6	.281	.250	.657	.785	2-326875-2†°
						#8	.281	.250	.657	.785	2-323916-2†°
						#10	.281	.250	.657	.785	2-326875-3†°
						#10	.281	.300	.657	.810	52279†
Y	#24	.026	.031-.055	Yellow	Blue	#2	.281	.250	.657	.785	52270†°
						#4	.211	.203	.587	.691	2-323914-2†°
						#6	.281	.250	.657	.785	2-326875-4†°
						#8	.281	.250	.657	.785	2-323916-3†°
						#10	.281	.250	.657	.785	2-326875-5†°
						#10	.281	.300	.657	.810	52279-1†
R	#22	.033	.038-.110	Red	Green	#2	.172	.182	.638	.731	52307
						#4	.156	.218	.622	.734	52273†°
						#6	.156	.218	.622	.734	2-36149-3†°
						#6	.250	.250	.716	.844	51863-2†°
						#8	.281	.312	.747	.906	1-320551-2†°
						#10	.281	.312	.747	.906	2-36153-3†°
						1/4	.437	.469	.903	1.140	2-320571-3†°
						5/16	.437	.469	.903	1.140	2-320572-2†°
						3/8	.546	.531	1.012	1.280	2-320573-1†°
						1/2	.530	.713	.996	1.355	2-328975-1†°
R	#20	.041	.046-.110	Red	Red	#2	.172	.182	.638	.731	52307-1
						#4	.156	.218	.622	.734	52273-1†°
						#6	.156	.218	.622	.734	2-36149-4†°
						#6	.250	.250	.716	.844	51863-3†°
						#8	.281	.312	.747	.906	1-320551-3†°
						#10	.281	.312	.747	.906	2-36153-4†°
						1/4	.437	.469	.903	1.140	2-320571-4†°
						5/16	.437	.469	.903	1.140	2-320572-3†°
						3/8	.546	.531	1.012	1.280	2-320573-2†°
						1/2	.530	.713	.996	1.355	2-328975-2†°
R	#18	.051	.056-.110	Red	White	#4	.156	.218	.622	.734	52273-2†°
						#6	.156	.218	.622	.734	2-36149-5†°
						#6	.250	.250	.716	.844	51863-4†°
						#8	.281	.312	.747	.906	1-320551-4†°
						#10	.281	.312	.747	.906	2-36153-5†°
						1/4	.437	.469	.903	1.140	2-320571-5†°
						5/16	.437	.469	.903	1.140	2-320572-4†°
						3/8	.546	.531	1.012	1.280	2-320573-3†°
						1/2	.530	.713	.996	1.355	2-328975-3†°
						BL	#16	.058	.063-.130	Blue	Blue
#6	.171	.250	.637	.765	2-320561-3†°						
#6	.281	.312	.747	.906	51864-6†°						
#8	.281	.312	.747	.906	1-51864-0†°						
#10	.281	.312	.747	.906	51864-7†°						
1/4	.437	.469	.903	1.140	2-320563-3†°						
5/16	.437	.469	.903	1.140	2-320575-2†°						
3/8	.546	.531	1.012	1.280	2-320564-1†°						
1/2	.530	.713	.996	1.355	2-328976-1†°						
BL	#14	.073	.078-.130	Blue	Green						
						#6	.281	.312	.747	.906	51864-8†°
						#6	.171	.250	.637	.765	2-320561-4†°
						#8	.281	.312	.747	.906	1-51864-1†°
						#10	.281	.312	.747	.906	51864-9†°
						1/4	.437	.469	.903	1.140	2-320563-4†°
						5/16	.437	.469	.903	1.140	2-320575-3†°
						3/8	.546	.531	1.012	1.280	2-320564-2†°
						1/2	.530	.713	.996	1.355	2-328976-2†°
						Y	#12	.090	.095-.200	Yellow	Yellow
#8	.302	.375	.958	1.148	2-320568-2†°						
#10	.302	.375	.958	1.148	2-36161-3†°						
1/4	.468	.531	1.124	1.392	2-320569-5†°						
5/16	.468	.531	1.124	1.392	2-320576-2†°						
3/8	.531	.593	1.187	1.486	2-320577-1†°						
1/2	.474	.715	1.130	1.490	52077-1†°						
Y	#10	.114	.119-.200	Yellow	Brown	#6	.302	.375	.958	1.148	2-36161-6†°
						#8	.302	.375	.958	1.148	2-320568-3†°
						#10	.302	.375	.958	1.148	2-36161-4†°
						1/4	.468	.531	1.124	1.392	2-320569-6†°
						5/16	.468	.531	1.124	1.392	2-320576-3†°
						3/8	.531	.593	1.187	1.486	2-320577-2†°
						1/2	.474	.715	1.130	1.490	52077-2†°

NOTE: † Indicates Terminal is available in tape mounted form. ° Indicates MIL-T-7928/1 (See page 2-26).

Y Ring Tongue Terminals
Wire Range 26-22
CMA 202-810 [.103-.410 mm²]

Dimensioning:

1. All dimensions in inches and millimetres. Values in brackets are metric equivalents.
2. Charts contain dimensions in inches over millimetres.

Terminal Tongue Material Thickness .020 [0.51] Max.
Barrel I.D. .029 [0.73] Min.

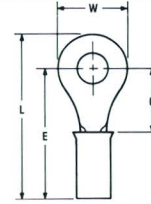

PIDG (PRE-INSULATED DIAMOND GRIP)

Stud Size	Tongue Dimensions				E Max.	L Max.	Vinyl	Nylon
	C Min.	W	H	X			Maximum Insulation Diameter	Maximum Insulation Diameter
							.082 [2.09]	.082 [2.09]
0	.121 3.07	.140 3.56			.452 11.49	.525 13.34	321013†	
	.121 3.07	.140 3.56			.452 11.49	.525 13.34	320733†	323912†
2 M2	.211 5.35	.203 5.16			.542 13.77	.646 16.41	321015†	323913†
	.211 5.35	.140 3.56			.542 13.77	.615 15.63	322433†	329951†
4	.211 5.35	.203 5.16			.542 13.77	.646 16.41	321017†	323914†
	.211 5.35	.203 5.16			.542 13.77	.646 16.41	321019†	323915†
6 M3.5	.281 7.13	.250 6.35			.612 15.55	.740 18.8	321020†	326875†
	.308 7.82	.198 5.03			.643 16.34	.745 18.93	321617†	
8 M4	.281 7.13	.250 6.35			.612 15.55	.740 18.8	321021†	323916†
	.281 7.13	.300 7.62			.612 15.55	.765 19.44		52124
10	.281 7.13	.250 6.35			.612 15.55	.740 18.8	321022†	324075†
	.281 7.13	.300 7.62			.612 15.55	.765 19.44	53999-1†	52124-1†

Note: †Indicates terminal is available in tape mounted form.

Y Rectangular Tongue Terminals
Wire Range 26-22
CMA 202-810 [.103-.410 mm²]

Terminal Tongue Material Thickness .020 [0.51] Max.
Barrel I.D. .029 [0.73] Min.

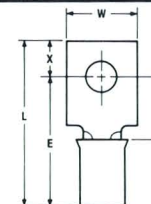

PIDG (PRE-INSULATED DIAMOND GRIP)

Stud Size	Tongue Dimensions				E Max.	L Max.	Vinyl	Nylon
	C Min.	W	H	X			Maximum Insulation Diameter	Maximum Insulation Diameter
							.082 [2.09]	.082 [2.09]
2 M2	.203 5.15	.165 4.19		.100 2.54	.534 13.57	.639 16.24	321620†	
	.203 5.15	.182 4.62		.100 2.54				

Note: †Indicates terminal is available in tape mounted form.

Y Ring Tongue Terminals
 Wire Range 26-22
 CMA 202-810 [.103-.410 mm²]

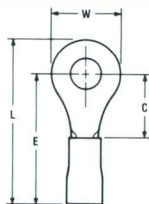

PLASTI-GRIP

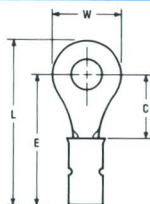

DIAMOND GRIP

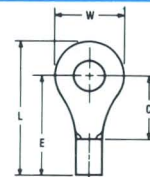

SOLISTRAND & BUDGET

E Max.	L Max.	Maximum Insulation Diameter	E Max.	L Max.	Maximum Insulation Diameter .082 [2.09]	E Max.	L Max.	Non Insulation Support		Stud Size
								SOLISTRAND	BUDGET	
			.391 9.94	.464 11.79	31516†	.256 6.51	.329 8.36		31423†	0
			.391 9.94	.464 11.79	31518†	.256 6.51	.329 8.36		31425†	
			.481 12.22	.585 14.86	33702†	.346 8.79	.450 11.43		33695†	2 M2
			.481 12.22	.585 14.86	31679†	.346 8.79	.450 11.43		31428†	4
			.481 12.22	.585 14.86	31681†	.346 8.79	.450 11.43		31430†	
			.551 14.	.679 17.25	32861†	.416 10.57	.544 13.82		331401† 32858†	6 M3.5
			.582 14.79	.684 17.38	321616†	.443 11.26	.549 13.95		321818†	
			.551 14.	.679 17.25	32862†	.416 10.57	.544 13.82		32859†	8 M4
						.416 10.57	.569 14.46		52188-2	
			.551 14.	.679 17.25	32863†	.416 10.57	.544 13.82		32860†	10
						.416 10.57	.569 14.46		52188-3†	

Y Rectangular Tongue Terminals
 Wire Range 26-22
 CMA 202-810 [.103-.410 mm²]

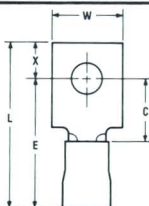

PLASTI-GRIP

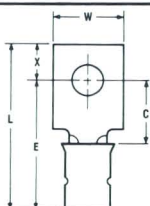

DIAMOND GRIP

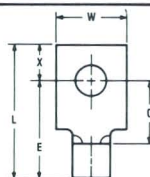

SOLISTRAND & BUDGET

E Max.	L Max.	Maximum Insulation Diameter	E Max.	L Max.	Maximum Insulation Diameter .082 [2.09]	E Max.	L Max.	Non Insulation Support		Stud Size
								SOLISTRAND	BUDGET	
			.473 12.02	.578 14.69	321621†	.346 8.79	.450 11.43		321841†	2 M2
			.473 12.02	.578 14.69	321824	.346 8.79	.450 11.43		321613	

Rectangular Tongue Terminals (Cont'd.)

Y

Wire Range 26-22

CMA 202-810 [.103-.410 mm²]

Dimensioning:

- 1. All dimensions in inches and millimetres. Values in brackets are metric equivalents.
- 2. Charts contain dimensions in inches over millimetres.

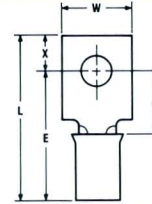

**Terminal Tongue Material Thickness .020 [0.51] Max.
Barrel I.D. .029 [0.73] Min.**

PIDG (PRE-INSULATED DIAMOND GRIP)

Stud Size	Tongue Dimensions				E Max.	L Max.	Vinyl	Nylon
	C Min.	W	H	X			Maximum Insulation Diameter	
							.082 [2.09]	
6 M3.5	.308 7.82	.312 7.92	.187 4.75	.187 4.75	.643 16.34	.835 21.21	321023	326876
	.308 7.82	.277 7.04	.187 4.75	.187 4.75	.643 16.34	.835 21.21	329825†	
	.308 7.82	.277 7.04	.130 3.30	.130 3.30	.643 16.34	.783 19.89	330250†	
	.308 7.82	.250 6.35	.187 4.75	.187 4.75				
	.308 7.82	.245 6.22	.125 3.18	.125 3.18				
8 M4	.308 7.82	.312 7.92	.187 4.75	.187 4.75	.643 16.34	.835 21.21	322791	
10	.308 7.82	.312 7.92	.187 4.75	.187 4.75	.643 16.34	.835 21.21	322792	326874

Note: †Indicates terminal is available in tape mounted form.

Spade Tongue Terminals

Y

Wire Range 26-22

CMA 202-810 [.103-.410 mm²]

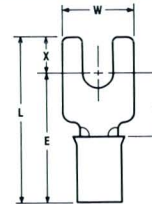

**Terminal Tongue Material Thickness .020 [0.51] Max.
Barrel I.D. .029 [0.73] Min.**

PIDG (PRE-INSULATED DIAMOND GRIP)

Stud Size	Tongue Dimensions				E Max.	L Max.	Vinyl	Nylon
	C Min.	W	H	X			Maximum Insulation Diameter	
							.082 [2.09]	
0	.078 1.98	.125 3.18	.062 1.57	.062 1.57	.409 10.39	.476 12.1	322001	
	.125 3.17	.135 3.43	.062 1.57	.062 1.57				
4	.211 5.35	.203 5.16	.080 2.03	.080 2.03	.542 13.77	.627 15.93	321035†	
	.211 5.35	.203 5.16	.072 1.83	.072 1.83				

Note: †Indicates terminal is available in tape mounted form.

Y Rectangular Tongue Terminals (Cont'd.)
Wire Range 26-22
CMA 202-810 [.103-.410 mm²]

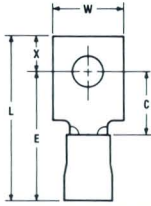

PLASTI-GRIP

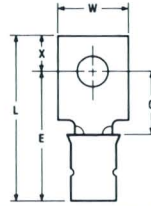

DIAMOND GRIP

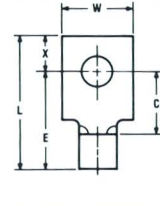

SOLISTRAND & BUDGET

E Max.	L Max.	Maximum Insulation Diameter	E Max.	L Max.	Maximum Insulation Diameter	E Max.	L Max.	Non Insulation Support		Stud Size
								SOLISTRAND	BUDGET	
			.582 14.79	.774 19.66	.082 [2.09] 31851	.447 11.36	.639 16.24		31850	6 M3.5
						.447 11.36	.639 16.24		329824†	
						.447 11.36	.587 14.91		330251†	
			.582 14.79	.774 19.66	327215†	.447 11.36	.639 16.24		327214†	
			.582 14.79	.712 18.09	330453	.447 11.36	.577 14.66		330456	
			.582 14.79	.774 19.66	324524	.447 11.36	.639 16.24		322789	
			.582 14.79	.774 19.66	324613	.447 11.36	.639 16.24		322790	10

Y Spade Tongue Terminals
Wire Range 26-22
CMA 202-810 [.103-.410 mm²]

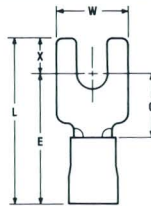

PLASTI-GRIP

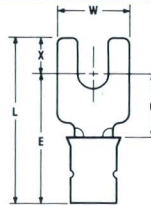

DIAMOND GRIP

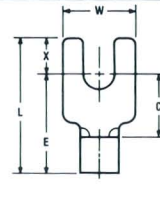

SOLISTRAND & BUDGET

E Max.	L Max.	Maximum Insulation Diameter	E Max.	L Max.	Maximum Insulation Diameter	E Max.	L Max.	Non Insulation Support		Stud Size
								SOLISTRAND	BUDGET	
			.348 8.84	.415 10.55	.082 [2.09] 32502					0
			.395 10.04	.462 11.74	322696					
			.481 12.22	.558 14.18	34248					4

Y Flanged Spade Tongue Terminals
 Wire Range 26-22
 CMA 202-810 [.103-.410 mm²]

Dimensioning:

1. All dimensions in inches and millimetres. Values in brackets are metric equivalents.
2. Charts contain dimensions in inches over millimetres.

Terminal Tongue Material Thickness .020 [0.51] Max.
 Barrel I.D. .029 [0.73] Min.

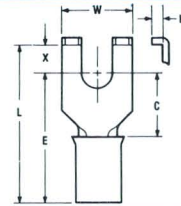

PIDG (PRE-INSULATED DIAMOND GRIP)

Stud Size	Tongue Dimensions				E Max.	L Max.	Vinyl	Nylon
	C Min.	W	H	X			Maximum Insulation Diameter	Maximum Insulation Diameter
2 M2	.203	.182	.031	.110	.534	.649	.082 [2.09]	
	5.15	4.62	0.78	2.79	13.57	16.49	324597†	
4	.203	.196	.031	.110	.534	.649	52369†	
	5.15	4.98	0.78	2.79	13.57	16.49		
	.203	.250	.031	.110	.534	.649	51874	
	5.15	6.35	0.78	2.79	13.57	16.49		

Note: †Indicates terminal is available in tape mounted form.

Y Slotted Ring Tongue Terminals
 Wire Range 26-22
 CMA 202-810 [.103-.410 mm²]

Terminal Tongue Material Thickness .020 [0.51] Max.
 Barrel I.D. .029 [0.73] Min.

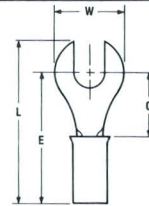

PIDG (PRE-INSULATED DIAMOND GRIP)

Stud Size	Tongue Dimensions				E Max.	L Max.	Vinyl	Nylon
	C Min.	W	H	X			Maximum Insulation Diameter	Maximum Insulation Diameter
4	.281	.250			.612	.719	.082 [2.09]	
	7.13	6.35			15.55	18.27	323011†	
	.211	.203						
	5.35	5.16						

Note: †Indicates terminal is available in tape mounted form.

Y Flanged Spade Tongue Terminals
 Wire Range 26-22
 CMA 202-810 [.103-.410 mm²]

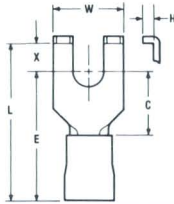

PLASTI-GRIP

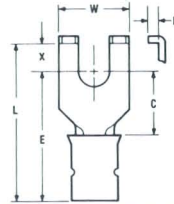

DIAMOND GRIP

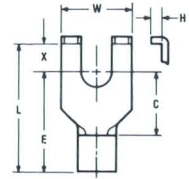

SOLISTRAND & BUDGET

E Max.	L Max.	Maximum Insulation Diameter	E Max.	L Max.	Maximum Insulation Diameter	E Max.	L Max.	Non Insulation Support		Size Stud
								SOLISTRAND	BUDGET	
			.473	.588	.082 [2.09]					2
			12.02	14.94	324598†					M2
										4

Y Slotted Ring Tongue Terminals
 Wire Range 26-22
 CMA 202-810 [.103-.410 mm²]

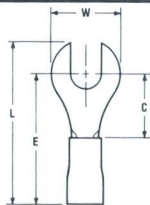

PLASTI-GRIP

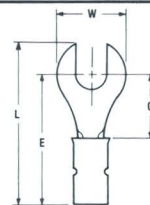

DIAMOND GRIP

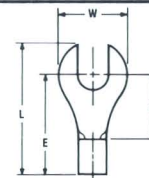

SOLISTRAND & BUDGET

E Max.	L Max.	Maximum Insulation Diameter	E Max.	L Max.	Maximum Insulation Diameter	E Max.	L Max.	Non Insulation Support		Stud Size
								SOLISTRAND	BUDGET	
			.551	.658						4
			14.	16.72	322210†					
			.481	.557	322212†					
			12.22	14.15						

Y Long Spring Spade Tongue Terminals
Wire Range 26-22
CMA 202-810 [.103-.410 mm²]

Dimensioning:

1. All dimensions in inches and millimetres. Values in brackets are metric equivalents.
2. Charts contain dimensions in inches over millimetres.

Terminal Tongue Material Thickness .020 [0.51] Max.
Barrel I.D. .029 [0.73] Min.

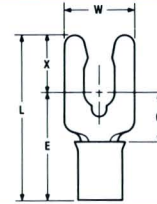

PIDG (PRE-INSULATED DIAMOND GRIP)

Stud Size	Tongue Dimensions				E Max.	L Max.	Vinyl	Nylon
	C Min.	W	H	X			Maximum Insulation Diameter	Maximum Insulation Diameter
							.082 [2.09]	
2 M2	.206 5.23	.182 4.62		.276 7.01	.537 13.64	.818 20.78	52401	
4	.206 5.23	.203 5.16		.276 7.01	.537 13.64	.818 20.78	52402	
6 M3.5	.235 5.96	.250 6.35		.276 7.01	.566 14.38	.847 21.52	52403	
8 M4	.265 6.73	.281 7.14		.290 7.37	.596 15.14	.891 22.64	52404	

Note: †Indicates terminal is available in tape mounted form.

Y Short Spring Spade Tongue Terminals
Wire Range 26-22
CMA 202-810 [.103-.410 mm²]

Terminal Tongue Material Thickness .020 [0.51] Max.
Barrel I.D. .029 [0.73] Min.

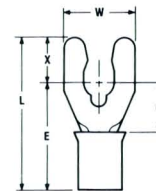

PIDG (PRE-INSULATED DIAMOND GRIP)

Stud Size	Tongue Dimensions				E Max.	L Max.	Vinyl	Nylon
	C Min.	W	H	X			Maximum Insulation Diameter	Maximum Insulation Diameter
							.082 [2.09]	
2 M2	.206 5.23	.171 4.34		.109 2.77	.537 13.64	.651 16.54	52921	
4	.219 5.56	.203 5.16		.140 3.56	.550 13.97	.695 17.66	52922	
5 M3	.203 5.15	.250 6.35		.140 3.56	.534 13.57	.679 17.25	52923	
6 M3.5	.203 5.15	.250 6.35		.140 3.56	.534 13.57	.679 17.25	52924	
8 M4	.281 7.13	.375 9.52		.170 4.32	.612 15.55	.787 19.99	52925	

Note: †Indicates terminal is available in tape mounted form.

Y Long Spring Spade Tongue Terminals
 Wire Range 26-22
 CMA 202-810 [.103-.410 mm²]

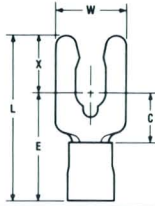

PLASTI-GRIP

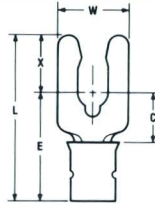

DIAMOND GRIP

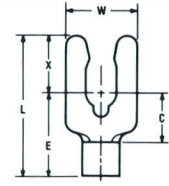

SOLISTRAND & BUDGET

E Max.	L Max.	Maximum Insulation Diameter	E Max.	L Max.	Maximum Insulation Diameter	Non Insulation Support		Stud Size	
						SOLISTRAND	BUDGET		
						.356 9.05	.637 16.18	52732-1	2 M2
						.356 9.05	.637 16.18	52733-1	4
						.385 9.78	.666 16.92	52734-1	6 M3.5
						.415 10.55	.696 17.68	52735-1	8 M4

Y Short Spring Spade Tongue Terminals
 Wire Range 26-22
 CMA 202-810 [.103-.410 mm²]

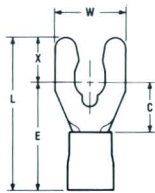

PLASTI-GRIP

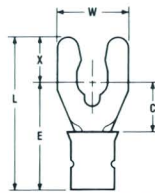

DIAMOND GRIP

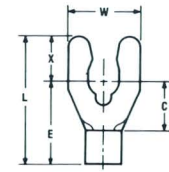

SOLISTRAND & BUDGET

E Max.	L Max.	Maximum Insulation Diameter	E Max.	L Max.	Maximum Insulation Diameter	Non Insulation Support		Stud Size	
						SOLISTRAND	BUDGET		
						.341 8.67	.455 11.56	53000-1	2 M2
						.354 9.	.499 12.68	53001-1	4
						.338 8.59	.483 12.27	53002-1	5 M3
						.338 8.59	.483 12.27	53003-1	6 M3.5
						.416 10.57	.591 15.02	53004-1	8 M4

R Ring Tongue Terminals Wire Range 22-16 CMA 509-3,260 [.258-1.936 mm²]

Dimensioning:

- All dimensions in inches and millimetres. Values in brackets are metric equivalents.
- Chart contains dimensions in inches over millimetres.

**Terminal Tongue Material Thickness .033 [0.84] Max.
Barrel I.D. .061 [1.54] Min.**

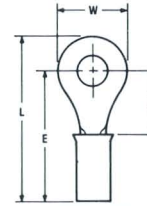

PIDG (PRE-INSULATED DIAMOND GRIP)

Stud Size	Tongue Dimensions				E Max.	L Max.	Vinyl		Nylon	
	C Min.	W	H	X			Maximum Insulation Diameter		Maximum Insulation Diameter	
							.125 [3.18]	.140 [3.56]	.125 [3.18]	.140 [3.56]
1	.156 3.96	.160 4.06			.560 14.23	.643 16.34	327174†			
	.156 3.96	.218 5.54			.560 14.23	.672 17.07	34232†			
2 M2	.156 3.96	.218 5.54			.560 14.23	.672 17.07	320135†		328657†	
	.172 4.36	.182 4.62			.576 14.64	.669 17.	320440†	320773†	324158†	
4	.156 3.96	.218 5.54			.560 14.23	.672 17.07	31878†	31880†	320553†	
	.172 4.36	.182 4.62			.576 14.64	.669 17.		320882†	328878†	
	.172 4.36	.182 4.62			.576 14.64	.669 17.			327654†	
	.312 7.92	.250 6.35			.716 18.19	.844 21.44	322410†	322411†	323758† 330648†	
	.250 6.35	.281 7.14			.654 16.62	.797 20.25	323926†	323927†		
	.172 4.36	.182 4.62			.576 14.64	.669 17.			331440†	
5 M3	.250 6.35	.281 7.14								
	.156 3.96	.218 5.54								
6 M3.5	.156 3.96	.218 5.54			.560 14.23	.672 17.07	31879†	31881†	36149† 36150†	
	.250 6.35	.250 6.35			.654 16.62	.782 19.87	51862†		51863†	
	.250 6.35	.281 7.14			.654 16.62	.797 20.25	31882†	31885†	36151† 36152†	
	.281 7.13	.312 7.92			.685 17.4	.844 21.44	323008†	324526†	50763† 326878†	
8 M4	.297 7.54	.344 8.74			.701 17.81	.876 22.26		324525†		
	.281 7.13	.312 7.92			.685 17.4	.844 21.44	31888†	31890†	320551†	
	.250 6.35	.281 7.14			.654 16.62	.797 20.25	31883†	31886†	320554†	
10	.297 7.54	.344 8.74			.701 17.81	.876 22.26	32834†	32835†		
	.281 7.13	.312 7.92			.685 17.4	.844 21.44	31889†	31891†	36153† 36154†	
	.250 6.35	.281 7.14			.654 16.62	.797 20.25	31884†	31887†	320552†	
	.297 7.54	.344 8.74			.701 17.81	.876 22.26	32836†	32837†	326873†	
	.437 11.09	.469 11.91			.841 21.37	1.078 27.39		324531†		
12	.281 7.13	.312 7.92			.685 17.4	.844 21.44	32410†			
	.297 7.54	.344 8.74								
¼ M6	.437 11.09	.469 11.91			.841 21.37	1.078 27.39	31892†	31894†	320571†	

Note: †Indicates terminal is available in tape mounted form.

R Ring Tongue Terminals
 Wire Range 22-16
 CMA 509-3,260 [.258-1.936 mm²]

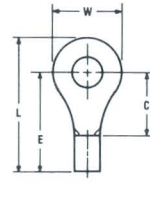
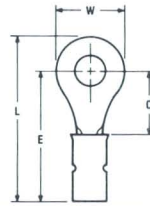
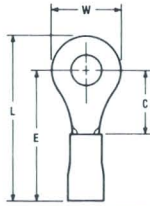

PLASTI-GRIP

DIAMOND GRIP

SOLISTRAND & BUDGET

E Max.	L Max.	Maximum Insulation Diameter		E Max.	L Max.	Maximum Insulation Diameter		E Max.	L Max.	Non Insulation Support		Stud Size	
		.125 [3.18]	.140 [3.56]			.125 [3.18]	.140 [3.56]			SOLISTRAND	BUDGET		
								.337 8.56	.420 10.67		327247†		
				.491 12.48	.603 15.32		31092†	31389†	.337 8.56	.449 11.41	34383†	31087†	1
.572 14.53	.684 17.38			.491 12.48	.603 15.32		31093†	31390†	.337 8.56	.449 11.41	34103†	31088†	2
		32943†	34140†										M2
				.507 12.88	.600 15.24		320678†	327899†	.353 8.97	.446 11.33	322927†	320677†	
.572 14.53	.684 17.38			.491 12.48	.603 15.32		31094†	31391†	.337 8.56	.449 11.41	34104†	31089†	
		32944†	34141†										
									.353 8.97	.446 11.33	36467†	36189†	
				.507 12.88	.600 15.24		2-327891-1†	327891†	.353 8.97	.446 11.33	326851†	326850†	
				.647 16.44	.775 19.69		322414†	322415†	.493 12.53	.621 15.78	323096†	322418†	4
.666 16.92	.809 20.55			.585 14.86	.728 18.5		31267†	31394†	.431 10.95	.574 14.58	34106†	31262†	
		32946†	34143†										
				.507 12.88	.600 15.24		331441†	1-331441-0†	.353 8.97	.446 11.33		331438†	
				.585 14.86	.728 18.5			31395†	.431 10.95	.574 14.58		31263†	
				.491 12.48	.603 15.32		31095†	31392†	.337 8.56	.449 11.41		31090†	5
.572 14.53	.684 17.38			.491 12.48	.603 15.32		31096†	31393†	.337 8.56	.449 11.41	34105†	31091†	M3
		32945†	34142†						.431 10.95	.559 14.20		51873-1†	
				.585 14.86	.728 18.5		31269†	31396†	.431 10.95	.574 14.58	34107†	31264†	6
.666 16.92	.809 20.55			.616 15.65	.775 19.69		30995†	31159†	.462 11.74	.621 15.78	34110†	30691†	M3.5
.697 17.71	.856 21.75			.632 16.06	.807 20.5		32826†	32827†	.478 12.15	.653 16.59	323085†	32822†	
		32947†	34144†										
				.616 15.65	.775 19.69		30996†	31160†	.462 11.74	.625 15.88	34111†	30692†	
.697 17.71	.856 21.75			.585 14.86	.728 18.5		31270†	31397†	.431 10.95	.574 14.58	34108†	31265†	8
.666 16.92	.809 20.55												M4
.713 18.12	.888 22.56			.632 16.06	.807 20.5		32828†	32829†	.478 12.15	.653 16.59	323086†	32823†	
.697 17.71	.856 21.75			.616 15.65	.775 19.69		30997†	31161†	.462 11.74	.625 15.88	34112†	30693†	
		32948†	34145†										
				.585 14.86	.728 18.5		31271†	31398†	.431 10.95	.574 14.58	34109†	31266†	
.666 16.92	.809 20.55												10
		32949†	34146†										
				.632 16.06	.807 20.5		32830†	32831†	.470 12.15	.653 16.59	323087†	32824†	
				.616 15.65	.775 19.69		30998†		.462 11.74	.621 15.78		30694†	
													12
				.632 16.06	.807 20.5		32832	32833	.478 12.15	.653 16.59		32825	
.853 21.67	1.090 27.69			.772 19.61	1.009 25.63		31251†	31176†	.618 15.7	.855 21.72	34113†	31172†	¼ M6

R Ring Tongue Terminals (Cont'd.) Wire Range 22-16 CMA 509-3,260 [.258-1.936 mm²]

Dimensioning:

1. All dimensions in inches and millimetres. Values in brackets are metric equivalents.
2. Charts contain dimensions in inches over millimetres.

**Terminal Tongue Material Thickness .033 [0.84] Max.
Barrel I.D. .061 [1.54] Min.**

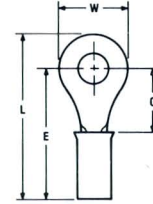

PIDG (PRE-INSULATED DIAMOND GRIP)

Stud Size	Tongue Dimensions				E Max.	L Max.	Vinyl		Nylon
	C Min.	W	H	X			Maximum Insulation Diameter		Maximum Insulation Diameter
							.125 [3.18]	.140 [3.56]	.125 [3.18]
5/16 M8	.437 11.09	.469 11.91			.841 21.37	1.078 27.39	31893†	31895†	320572†
	.546 13.86	.531 13.49			.950 24.13	1.218 30.94	324123		
3/8	.546 13.86	.531 13.49			.950 24.13	1.218 30.94	31896†	31897†	320573†
	.437 11.09	.656 16.66			.841 21.37	1.171 29.75	321522	321523	
	.437 11.09	.469 11.91							
1/2 M12	.530 13.46	.713 18.11			.934 23.73	1.293 32.85	328948		328975

Note: †Indicates terminal is available in tape mounted form.

R Rectangular Tongue Terminals Wire Range 22-16 CMA 509-3,260 [.258-1.936 mm²]

**Terminal Tongue Material Thickness .033 [0.84] Max.
Barrel I.D. .061 [1.54] Min.**

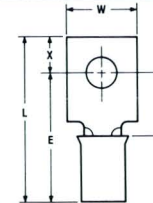

PIDG (PRE-INSULATED DIAMOND GRIP)

Stud Size	Tongue Dimensions				E Max.	L Max.	Vinyl		Nylon	
	C Min.	W	H	X			Maximum Insulation Diameter		Maximum Insulation Diameter	
							.125 [3.18]	.140 [3.56]	.125 [3.18]	.140 [3.56]
2 M2	.250 6.35	.182 4.62		.115 2.92	.654 16.62	.774 19.66		324176†		
	.250 6.35	.182 4.62		.093 2.36	.654 16.62	.747 18.98	323846			
	.203 5.15	.182 4.62		.115 2.92	.607 15.42	.727 18.47	325148†	324572†		

Note: †Indicates terminal is available in tape mounted form.

R Ring Tongue Terminals (Cont'd.)
Wire Range 22-16
CMA 509-3,260 [.258-1.936 mm²]

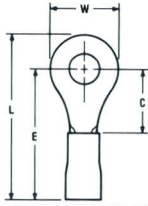

PLASTI-GRIP

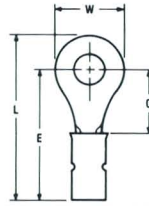

DIAMOND GRIP

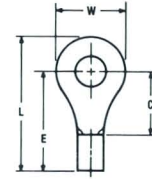

SOLISTRAND & BUDGET

E Max.	L Max.	Maximum Insulation Diameter		E Max.	L Max.	Maximum Insulation Diameter		E Max.	L Max.	Non Insulation Support		Stud Size
		.125 [3.18]	.140 [3.56]			.125 [3.18]	.140 [3.56]			SOLISTRAND	BUDGET	
.853 21.67	1.090 27.69	32954†	34151†	.772 19.61	1.009 25.63	31252†	31177†	.618 15.7	.855 21.72	34114†	31173†	5/16 M8
								.727 18.47	.955 24.26	324124		
.962 24.44	1.230 31.25	32955†	34152†	.881 22.38	1.149 29.19	31469†	31500†	.727 18.47	.955 24.26	34115†	31498†	3/8
								.618 15.7	.949 24.11	321521		
								.618 15.7	.855 21.72	323080†	31174†	1/2 M12
								.711 18.06	1.070 27.18	329966	328970	

R Rectangular Tongue Terminals
Wire Range 22-16
CMA 509-3,260 [.258-1.936 mm²]

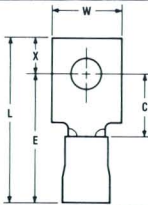

PLASTI-GRIP

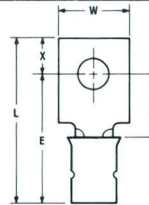

DIAMOND GRIP

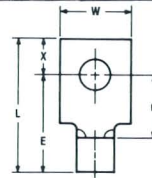

SOLISTRAND & BUDGET

E Max.	L Max.	Maximum Insulation Diameter		E Max.	L Max.	Maximum Insulation Diameter		E Max.	L Max.	Non Insulation Support		Stud Size
		.140 [3.56]				.125 [3.18]	.140 [3.56]			SOLISTRAND	BUDGET	
				.585 14.86	.705 17.91	327255†	320871†	.431 10.95	.551 14.	323118†	320870†	2 M2
								.431 10.95	.524 13.31	323848		
				.438 13.67	.658 16.72	2-324574-1†	324574†	.384 9.76	.504 12.81	324576†	324573†	

R Rectangular Tongue Terminals (Cont'd.)
Wire Range 22-16
CMA 509-3,260 [.258-1.936 mm²]

Dimensioning:

1. All dimensions in inches and millimetres.
 Values in brackets are metric equivalents.
2. Chart contains dimensions in inches over millimetres.

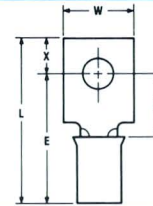

Terminal Tongue Material Thickness .033 [0.84] Max.
Barrel I.D. .061 [1.54] Min.

PIDG (PRE-INSULATED DIAMOND GRIP)

Stud Size	Tongue Dimensions				E Max.	L Max.	Vinyl		Nylon	
	C Min.	W	H	X			Maximum Insulation Diameter		Maximum Insulation Diameter	
							.125 [3.18]	.140 [3.56]	.125 [3.18]	.140 [3.56]
4	.203 5.15	.218 5.54	.122 3.1	.140 3.56	.607 15.42	.729 18.52		324946†		
	.203 5.15	.296 7.52	.140 3.56	.140 3.56	.607 15.42	.752 19.11	34841†			
	.203 5.15	.218 5.54	.140 3.56	.140 3.56	.607 15.42	.752 19.11		322297†		
	.404 10.26	.237 6.02	.195 4.95	.195 4.95	.810 20.58	1.015 25.79		327962†		2-327962-1†
	.237 6.01	.237 6.02	.143 3.63	.143 3.63	.643 16.34	.796 20.22		327968†		2-327968-1†
	.250 6.35	.182 4.62	.115 2.92	.115 2.92						
	.281 7.13	.234 5.94	.187 4.75	.187 4.75						
5 M.3	.277 7.03	.277 7.04	.143 3.63	.143 3.63	.702 17.84	.855 21.72		327950†		2-327950-1†
	.404 10.26	.237 6.02	.195 4.95	.195 4.95	.810 20.58	1.015 25.79		327956†		2-327956-1†
6 M3.5	.281 7.13	.359 9.12	.140 3.56	.140 3.56	.685 17.40	.830 21.09		324878		
	.187 4.74	.234 5.94	.140 3.56	.140 3.56	.591 15.02	.736 18.7		324944		
	.203 5.15	.296 7.52	.218 5.54	.218 5.54	.607 15.42	.830 21.09		324938		
	.218 5.53	.290 7.37	.156 3.96	.156 3.96	.622 15.8	.783 19.89		324805		
	.375 9.52	.234 5.94	.141 3.58	.141 3.58	.779 19.79	.925 23.5		324813		
	.375 9.52	.296 7.52	.140 3.56	.140 3.56	.779 19.79	.924 23.47		324829		
	.218 5.53	.328 8.33	.156 3.96	.156 3.96	.622 15.8	.783 19.89		324552		
	.375 9.52	.312 7.92	.187 4.75	.187 4.75	.779 19.79	.971 24.67		327880		
	.465 11.81	.302 7.67	.227 5.77	.227 5.77	.872 22.15	1.109 28.17		327938†		2-327938-1†
	.312 7.92	.250 6.35	.125 3.18	.125 3.18	.716 18.19	.846 21.49	33475†	33476†	320629†	328885†
	.203 5.15	.296 7.52	.140 3.56	.140 3.56	.607 15.42	.752 19.11	32453†	32454†		328941†
	.218 5.53	.344 8.74	.142 3.61	.142 3.61	.622 15.8	.769 19.54	32465†			
	.218 5.53	.312 7.92	.156 3.96	.156 3.96	.622 15.8	.783 19.89	33178†	33179†		
	.281 7.13	.312 7.92	.203 5.16	.203 5.16	.685 17.4	.893 22.69		321689		
.218 5.53	.328 8.33	.156 3.96	.156 3.96							
.437 11.09	.296 7.52	.187 4.75	.187 4.75							
.218 5.53	.312 7.92	.218 5.54	.218 5.54							
.237 6.01	.237 6.02	.143 3.63	.143 3.63							
.218 5.53	.277 7.04	.156 3.96	.156 3.96	.622 15.8	.783 19.89		329827			

Note: †Indicates terminal is available in tape mounted form.

R Rectangular Tongue Terminals (Cont'd.)
Wire Range 22-16
CMA 509-3,260 [.258-1.936 mm²]

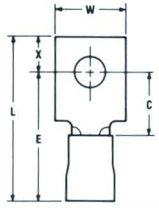

PLASTI-GRIP

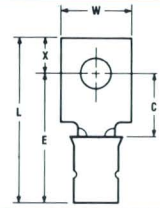

DIAMOND GRIP

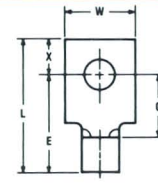

SOLISTRAND & BUDGET

E Max.	L Max.	Maximum Insulation Diameter	E Max.	L Max.	Maximum Insulation Diameter	E Max.	L Max.	Non Insulation Support		Stud Size
								SOLISTRAND	BUDGET	
		.140 [3.56]			.125 [3.18] .140 [3.56]					
						.384 9.76	.506 12.86		324945	
			.538 13.67	.683 17.35	32590† 32591†	.384 9.76	.529 13.44		32548†	
						.384 9.76	.529 13.44		32579†	
			.760 19.31	.965 24.52	328506†	.606 15.4	.811 20.6		327961†	4
.674 17.12	.827 21.01	52123†	.593 15.07	.746 18.95	328509†	.517 13.14	.670 17.02	328363†	327967†	
			.585 14.86	.705 17.91	322409†	.431 10.95	.551 14	323119-1	322408†	
			.616 15.65	.808 20.53	324889†	.462 11.74	.654 16.62		324888†	
			.633 16.08	.786 19.97	328500†	.557 14.15	.710 18.04	328357†	328343†	5 M3
						.684 17.38	.889 22.59	328359†	327955†	
			.533 13.54	.698 17.73	324877	.462 11.74	.607 15.42		324876	
						.368 9.35	.513 13.03		324943	
						.384 9.76	.607 15.42		324937	
			.553 14.05	.714 18.14	324804	.399 10.14	.560 14.23		324803	
			.710 18.04	.856 21.75	324812	.556 14.13	.702 17.83		324811	
			.710 18.04	.855 21.72	324828	.556 14.13	.701 17.81		324827	
			.553 14.05	.714 18.14	2-324554-1 324554	.399 10.14	.560 14.23		324553	
						.556 14.13	.748 19		327881	
						.745 18.93	.982 24.95	328353†	327937†	6 M3.5
			.647 16.44	.777 19.74	32529† 32530†	.493 12.53	.623 15.83	34262†	32528†	
			.538 13.67	.683 17.35	31666† 31667†	.384 9.76	.529 13.44	34263†	31665†	
			.553 14.05	.700 17.8	31659† 31660†	.399 10.14	.546 13.87	34264†	31658†	
			.553 14.05	.714 18.14	32406† 32407†	.399 10.14	.560 14.23		32405†	
			.616 15.65	.824 20.93	321444	.462 11.74	.670 17.02	323112	321691	
.634 16.11	.795 20.2	324555				.618 15.7	.810 20.58	322942	322941	
						.399 10.14	.622 15.8	321538†	321537†	
						.517 13.14	.670 17.02	329637†	328363†	

R Rectangular Tongue Terminals (Cont'd.) Wire Range 22-16 CMA 509-3,260 [.258-1.936 mm²]

Dimensioning:

1. All dimensions in inches and millimetres.
Values in brackets are metric equivalents.
2. Chart contains dimensions in inches over millimetres.

**Terminal Tongue Material Thickness .033 [0.84] Max.
Barrel I.D. .061 [1.54] Min.**

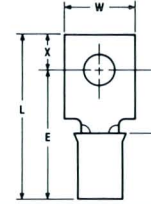

PIDG (PRE-INSULATED DIAMOND GRIP)

Stud Size	Tongue Dimensions				E Max.	L Max.	Vinyl		Nylon	
	C Min.	W	H	X			Maximum Insulation Diameter		Maximum Insulation Diameter	
							.125 [3.18]	.140 [3.56]	.125 [3.18]	.140 [3.56]
8 M4	.465 11.81	.302 7.67	.227 5.77	.277 7.04	.872 22.15	1.109 28.17				
	.621 15.77	.390 9.91	.310 7.87	.335 8.54	1.039 26.4	1.359 34.52				2-327944-†
	.375 9.52	.312 7.92	.250 6.35	.279 7.09	.779 19.79	1.034 26.27				2-327932-†
	.593 15.06	.375 9.53	.286 7.26	.312 7.92	.997 25.33	1.283 32.59				
	.187 4.74	.250 6.35	.140 3.56	.165 4.19	.591 15.02	.736 18.7				
	.437 11.09	.296 7.52	.187 4.75	.212 5.38	.841 21.37	1.033 26.24				
	.682 17.32	.312 7.92	.187 4.75	.212 5.38	.779 19.79	.971 24.67				
	.281 7.13	.416 10.57	.187 4.75	.212 5.38	.669 17.0	.861 21.87	2-320776-1	320776		
	.203 5.15	.296 7.52	.140 3.56	.165 4.19	.607 15.42	.752 19.11				329258†
	.281 7.13	.312 7.92	.203 5.16	.228 5.80	.685 17.4	.893 22.69				
	.375 9.52	.375 9.53	.312 7.92	.337 8.56	.779 19.79	1.096 27.84	2-321450-2†	321450†		
	.621 15.77	.390 9.91	.321 8.15	.346 8.79						
	.218 5.53	.312 7.92	.203 5.16	.228 5.80						
	.218 5.53	.344 8.74	.142 3.61	.167 4.24						
10	.687 17.44	.312 7.92	.187 4.75	.212 5.38	1.091 27.72	1.283 32.59		323211		
	.682 17.33	.375 9.53	.187 4.75	.212 5.38	1.086 27.59	1.278 32.47		320653		
	.281 7.13	.468 11.89	.203 5.16	.228 5.80	.685 17.4	.893 22.69	33166	33167		
	.281 7.13	.312 7.92	.203 5.16	.228 5.80	.685 17.4	.893 22.69		320209		
	.281 7.13	.375 9.53	.203 5.16	.228 5.80	.685 17.4	.893 22.69		320654†		326872†
	.218 5.53	.344 8.74	.142 3.61	.167 4.24						
	.687 17.44	.375 9.53	.187 4.75	.212 5.38						
12	.437 11.09	.375 9.53	.328 8.33	.353 8.97	.841 21.37	1.174 29.82		324951		

Note: †Indicates terminal is available in tape mounted form.

R Rectangular Tongue Terminals (Cont'd.)
Wire Range 22-16
CMA 509-3,260 [,.258-1.936 mm²]

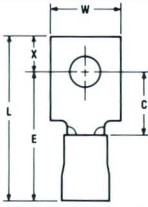

PLASTI-GRIP

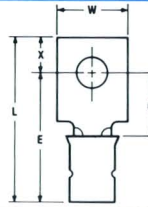

DIAMOND GRIP

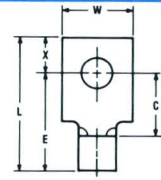

SOLISTRAND & BUDGET

E Max.	L Max.	Maximum Insulation Diameter .140 [3.56]	E Max.	L Max.	Maximum Insulation Diameter		E Max.	L Max.	Non Insulation Support		Stud Size
					.125 [3.18]	.140 [3.56]			SOLISTRAND	BUDGET	
			.821 20.86	1.058 26.88			.669 17.	.904 22.97			327943†
						328497†	.833 20.91	1.143 29.04			327931†
			.710 18.04	.965 24.52		324836	.556 14.13	.811 20.6			324835
							.774 19.66	1.060 26.93			324930
			.772 19.69	.964 24.49		320753	.618 15.7	.810 20.58			320752
							.556 14.13	.748 19.			323839
			.616 15.65	.808 20.53	2-320844-1	320844	.462 11.74	.654 16.62	323115	320777	
			.538 13.67	.683 17.35	31759†	31760†	.384 9.76	.529 13.44			31761†
			.616 15.65	.824 20.93		321444	.462 11.74	.670 17.02	321492	321442	
			.710 18.04	1.027 26.09	2-321451-1†	321451†	.556 14.13	.873 22.18			321449†
			.977 24.82	1.308 33.23		328491					
							.540 13.72	.748 19.	330536		
							.399 10.14	.546 13.87	34505†	34504	
							.868 22.05	1.060 26.43			323903
							.868 22.05	1.055 26.8			320223
			.616 15.65	.824 20.93	33164	33165	.462 11.74	.670 17.02			33163
							.462 11.74	.670 17.02			320208
							.462 11.74	.670 17.02	323106†	34525†	
			.553 14.05	.700 17.79	31822†	31823†	.399 10.14	.546 13.87	34459†	31821†	
			1.022 25.96	1.214 30.84		320224					
							.618 15.7	.951 24.16			324950

8
M4

10

12

R Spade Tongue Terminals Wire Range 22-16 CMA 509-3,260 [.258-1.936 mm²]

Dimensioning:

1. All dimensions in inches and millimetres. Values in brackets are metric equivalents.
2. Chart contains dimensions in inches over millimetres.

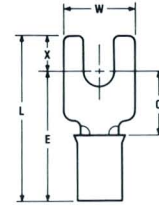

**Terminal Tongue Material Thickness .033 [0.84] Max.
Barrel I.D. .061 [1.54] Min.**

PIDG (PRE-INSULATED DIAMOND GRIP)

Stud Size	Tongue Dimensions				E Max.	L Max.	Vinyl		Nylon	
	C Min.	W	H	X			Maximum Insulation Diameter		Maximum Insulation Diameter	
2 M2	.203	.182		.115	.607	.727				
	5.15	4.62		2.92	15.42	18.47				
4	.156	.218		.109	.560	.674	1-327717-0†	327717		
	3.96	5.54		2.77	14.23	17.12				
6 M3.5	.312	.375		.187	.716	.908	32049†	32052†		50686
	7.92	9.53		4.75	18.19	23.07				
	2.18	.344		.156	.622	.783	32403†	32404†		
	5.53	8.74		3.96	15.8	19.89				
6 M3.5	.203	.297		.141	.607	.753	34080†	326861†		326880†
	5.15	7.54		3.58	15.42	19.13				
	.312	.250		.125	.716	.846		34541†		
	7.92	6.35		3.18	18.19	21.49				
8 M4	.203	.281		.468	.670	1.080	321628			
	5.15	7.14		11.89	15.42	27.44				
	.203	.343		.156						
	5.15	8.71		3.96						
10	.312	.375		.187	.716	.908	32050†	32053†		
	7.92	9.53		4.75	18.19	23.07				
	.296	.343		.171						
	7.51	8.71		4.34						
10	.203	.343		.156						
	5.15	8.71		3.96						
	.312	.375		.187	.716	.908	32051†	32054†		326871†
	7.92	9.53		4.75	18.19	23.07				

Note: †Indicates terminal is available in tape mounted form.

R Spade Tongue Terminals
Wire Range 22-16
CMA 509-3,260 [.258-1.936 mm²]

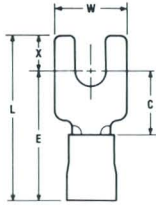

PLASTI-GRIP

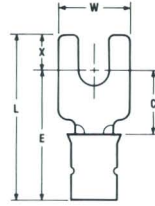

DIAMOND GRIP

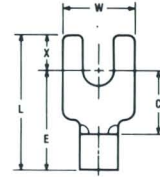

SOLISTRAND & BUDGET

E Max.	L Max.	Maximum Insulation Diameter		E Max.	L Max.	Maximum Insulation Diameter		E Max.	L Max.	Non Insulation Support		Stud Size
		.125 [3.18]	.140 [3.56]			.125 [3.18]	.140 [3.56]			SOLISTRAND	BUDGET	
								.384 9.76	.504 12.81	53555-1†	328395	2 M2
				.491 12.48	.605 15.37	321462†		.337 8.56	.451 11.46	321463†	323834	4
.728 18.5	.920 23.37	32980†	34154†	.647 16.44	.839 21.32	31637†	31640†	.493 12.53	.685 17.4	34116†	31634	
.634 16.11	.795 20.2	32979†	34153	.553 14.05	.724 18.39	31656†	31657†	.399 10.14	.560 14.23	33713†	31655	
.619 15.73	.765 19.44	327735†	320665†	.538 13.67	.684 17.38	33766†	33799†	.384 9.76	.530 13.47	36195†	33765	6 M3.5
.728 18.5	.858 21.8		327043†	.647 16.44	.777 19.74	324183†	34519†	.493 12.53	.623 15.83	323127†	34518	
								.384 9.76	.857 21.77		321627	
								.463 11.77	.624 15.85	32897†	32900	
.728 18.5	.920 23.37	32981†	34155†	.647 16.44	.839 21.32	31638†	31641†	.493 12.53	.685 17.4	34117†	31635	
				.631 16.03	.807 20.5	31381	31436				323823	8 M4
								.463 11.77	.624 15.85	32898†	32901	
.728 18.5	.920 23.37	32982†	34156†	.647 16.44	.839 21.32	31639†	31642†	.493 12.53	.685 17.4	34118†	31636	
				.631 16.03	.807 20.5	320379					323820	10
								.463 11.77	.624 15.85	32899†	32902	

R Flanged Spade Tongue Terminals
Wire Range 22-16
CMA 509-3,260 [.258-1.936 mm²]

Dimensioning:

1. All dimensions in inches and millimetres.
 Values in brackets are metric equivalents.
2. Charts contain dimensions in inches over millimetres.

Terminal Tongue Material Thickness .033 [0.84] Max.
Barrel I.D. .061 [1.54] Min.

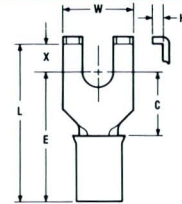

PIDG (PRE-INSULATED DIAMOND GRIP)

Stud Size	Tongue Dimensions				E Max.	L Max.	Vinyl		Nylon
	C Min.	W	H	X			Maximum Insulation Diameter		Maximum Insulation Diameter
2 M2	.203	.182	.046	.115	.607	.727	2-324608-2	324608†	
	5.15	4.62	1.17	2.92	15.42	18.47			
6 M3.5	.203	.328	.046	.125	.607	.737	325147†	324557†	
	5.15	8.33	1.17	3.18	15.42	18.72			
	.203	.296	.046	.125	.607	.737	32561†	32562†	326881†
	5.15	7.52	1.17	3.18	15.42	18.72			
	.203	.250	.046	.125	.607	.737	322777†		
	5.15	6.35	1.17	3.18	15.42	18.72			
.203	.265	.046	.125	.607	.737		322426		
5.15	6.73	1.17	3.18	15.42	18.72				
8 M4	.250	.416	.062	.171	.654	.830	32497†	32498†	
	6.35	10.57	1.57	4.34	16.62	21.09			
10	.203	.296	.046	.125	.607	.737	331366		
	5.15	7.52	1.17	3.18	15.42	18.72			

Note: †Indicates terminal is available in tape mounted form.

R Hook Tongue Terminals
Wire Range 22-16
CMA 509-3,260 [.258-1.936 mm²]

Terminal Tongue Material Thickness .033 [0.84] Max.
Barrel I.D. .061 [1.54] Min.

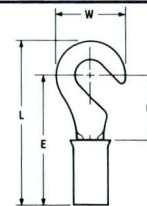

PIDG (PRE-INSULATED DIAMOND GRIP)

Stud Size	Tongue Dimensions				E Max.	L Max.	Vinyl		Nylon
	C Min.	W	H	X			Maximum Insulation Diameter		Maximum Insulation Diameter
6 M3.5	.203	.281			.607	.750	34312†	34313†	324842
	5.15	7.14			15.42	19.05			
8 M4	.156	.218			.705	.879	32455†	32456†	
	3.96	5.54			17.91	22.33			

Note: †Indicates terminal is available in tape mounted form.

R Flanged Spade Tongue Terminals
Wire Range 22-16
CMA 509-3,260 [,.258-1.936 mm²]

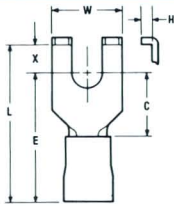

PLASTI-GRIP

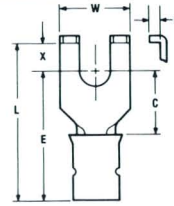

DIAMOND GRIP

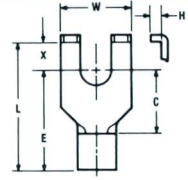

SOLISTRAND & BUDGET

E Max.	L Max.	Maximum Insulation Diameter	E Max.	L Max.	Maximum Insulation Diameter		E Max.	L Max.	Non Insulation Support		Stud Size
					.125 [3.18]	.140 [3.56]			SOLISTRAND	BUDGET	
		.140 [3.56]									
			.538 13.67	.658 16.72	2-324607-1†	324607†	.384 9.76	.504 12.81	324605†	324604	2 M2
.619 15.73	.749 19.03	324560†	.538 13.67	.668 16.97	2-324559-1†	324559†	.384 9.76	.514 13.06		324558	
.619 15.73	.749 19.03	322249†	.538 13.67	.668 16.97	32419†	32420†	.384 9.76	.514 13.06	320749†	32418	6 M3.5
							.384 9.76	.514 13.06	323136†	322776	
							.384 9.76	.514 13.06		322427	
							.384 9.76	.514 13.06	324561†	324558	
.666 16.92	.842 21.39	324169†	.585 14.86	.761 19.33	32495†	32496†	.431 10.95	.607 15.42	323124†	32494	8 M4
							.384 9.76	.514 13.06	52730	1-32418-2	
.619 15.73	.749 19.03	328516†					.384 9.76	.514 13.06	52729	328522	10

R Hook Tongue Terminals
Wire Range 22-16
CMA 509-3,260 [,.258-1.936 mm²]

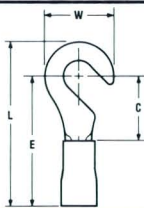

PLASTI-GRIP

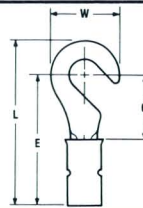

DIAMOND GRIP

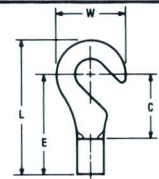

SOLISTRAND & BUDGET

E Max.	L Max.	Maximum Insulation Diameter	E Max.	L Max.	Maximum Insulation Diameter		E Max.	L Max.	Non Insulation Support		Stud Size
					.125 [3.18]	.140 [3.56]			SOLISTRAND	BUDGET	
		.140 [3.56]									
.619 15.73	.762 19.36	34501†					.366 9.3	.530 13.47	323126†	34261	6 M3.5
							.337 8.56	.449 11.41	322633	323836	
.717 18.22	.891 22.64	321669†	.636 16.16	.810 20.58	31630†		.482 12.25	.656 16.67		31628	8 M.4

R **Slotted Ring Tongue Terminals**
Wire Range 22-16
CMA 509-3,260 [.258-1.936 mm²]

Dimensioning:

1. All dimensions in inches and millimetres.
Values in brackets are metric equivalents.
2. Charts contain dimensions in inches over millimetres.

Terminal Tongue Material Thickness .033 [0.84] Max.
Barrel I.D. .061 [1.54] Min.

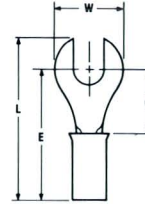

PIDG (PRE-INSULATED DIAMOND GRIP)

Stud Size	Tongue Dimensions				E Max.	L Max.	Vinyl		Nylon
	C Min.	W	H	X			Maximum Insulation Diameter		Maximum Insulation Diameter
							.125 [3.18]	.140 [3.56]	
4	.172 4.36	.182 4.62							
	.281 7.13	.312 7.92			.685 17.4	.828 21.04		35216	
6 M3.5	.250 6.35	.281 7.14			.654 15.62	.777 19.74		322212†	
	.156 3.96	.218 5.54							
8 M4	.250 6.35	.281 7.14			.654 16.62	.770 19.56		36954†	
	.281 7.13	.312 7.92			.685 17.4	.812 20.63		331453†	
12	.281 7.13	.312 7.92							
¼ M6	.437 11.09	.469 11.91			.841 21.37	1.039 26.4		321808	

Note: †Indicates terminal is available in tape mounted form.

R **Long Spring Spade Tongue Terminals**
Wire Range 22-16
CMA 509-3,260 [.258-1.936 mm²]

Terminal Tongue Material Thickness .033 [0.84] Max.
Barrel I.D. .061 [1.54] Min.

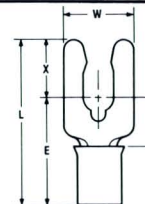

PIDG (PRE-INSULATED DIAMOND GRIP)

Stud Size	Tongue Dimensions				E Max.	L Max.	Vinyl		Nylon
	C Min.	W	H	X			Maximum Insulation Diameter		Maximum Insulation Diameter
							.125 [3.18]		.125 [3.18]
4	.201 5.1	.203 5.16		.276 7.01	.615 15.63	.896 22.76		52408†	
	.238 6.04	.250 6.35		.276 7.01	.652 16.57	.938 23.83		52409†	
6 M3.5	.270 6.85	.281 7.14		.290 7.37	.684 17.38	.979 24.87		52410†	
	.283 7.18	.343 8.71		.303 7.70	.697 17.71	1.005 25.53		52411†	
¼-28 M6	.340 8.63	.437 11.1		.338 8.59	.759 19.28	1.102 28		52412†	

Note: †Indicates terminal is available in tape mounted form.

R **Slotted Ring Tongue Terminals**
Wire Range 22-16
CMA 509-3,260 [.258-1.936 mm²]

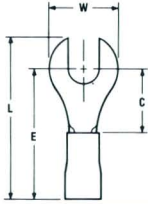

PLASTI-GRIP

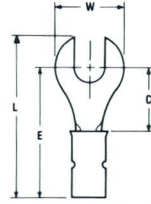

DIAMOND GRIP

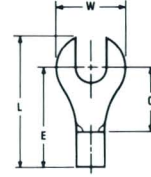

SOLISTRAND & BUDGET

E Max.	L Max.	Maximum Insulation Diameter		E Max.	L Max.	Maximum Insulation Diameter		E Max.	L Max.	Non Insulation Support		Stud Size
		.125 [3.18]	.140 [3.56]			.125 [3.18]	.140 [3.56]			SOLISTRAND	BUDGET	
								.353 8.97	.425 10.8	321288†	323838	4
				.616 15.65	.759 19.28	31380†	324527†	.462 11.74	.605 15.37		35215	
				.585 14.86	.710 18.04	34101†	34102†	.431 10.95	.562 14.28	323125†	34100	6 M3.5
.572 14.53	.658 16.72	34090†						.337 8.56	.423 10.75	321289†	323835	
.666 16.92	.782 19.87	324184†		.585 14.86	.701 17.81		321543	.431 10.95	.545 13.85	323129†	36953	8 M4
				.616 15.65	.740 18.8	31382		.462 11.74	.588 14.94	323091†	323832	10
				.616 15.65	.740 18.8	31383†		.462 11.74	.577 14.66		323833	12
				.772 19.61	.957 24.31		323217†	.618 15.7	.816 20.73	321809†	323837	1/4 M6

R **Long Spring Spade Tongue Terminals**
Wire Range 22-16
CMA 509-3,260 [.258-1.936 mm²]

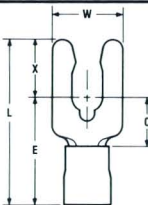

PLASTI-GRIP

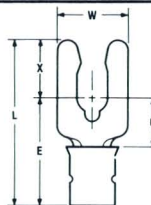

DIAMOND GRIP

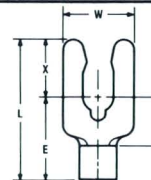

SOLISTRAND & BUDGET

E Max.	L Max.	Maximum Insulation Diameter		E Max.	L Max.	Maximum Insulation Diameter		E Max.	L Max.	Non Insulation Support		Stud Size
		.140 [3.56]								SOLISTRAND	BUDGET	
.627 15.93	.908 23.07	52452†						.392 9.96	.673 17.1	53172-1†	53047†	4
.664 16.87	.945 24.01	52453†						.429 10.9	.709 18.01	52709-1†	52700-1†	6 M3.5
.696 17.68	.991 25.18	52454†						.461 11.71	.756 19.21	52710-1†	52701-1†	8 M4
.709 18.01	1.017 25.84	52455†						.474 12.04	.782 19.87	52711-1†	52702-1†	10
.771 19.59	1.114 28.3	52456†						.536 13.62	.879 22.33	53173-1†	53111-2†	1/4-28 M6

R Short Spring Spade Tongue Terminals Wire Range 22-16 CMA 509-3,260 [1.258-1.936 mm²]

Dimensioning:

- All dimensions in inches and millimetres. Values in brackets are metric equivalents.
- Charts contain dimensions in inches over millimetres.

Terminal Tongue Material Thickness .033 [0.84] Max.
Barrel I.D. .061 [1.54] Min.

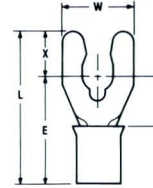

PIDG (PRE-INSULATED DIAMOND GRIP)

Stud Size	Tongue Dimensions				E Max.	L Max.	Vinyl		Nylon	
	C Min.	W	H	X			Maximum Insulation Diameter		Maximum Insulation Diameter	
4	.250	.203		.140	.654	.799	.125 [3.18]		52927†	
	6.35	5.16		3.56	16.62	20.3				
5 M3	.250	.250		.140	.654	.799	.125 [3.18]		52928†	
	6.35	6.35		3.56	16.62	20.3				
6 M3.5	.250	.250		.140	.654	.799	.125 [3.18]		52929†	
	6.35	6.35		3.56	16.62	20.3				
8 M4	.281	.375		.170	.685	.860	.125 [3.18]		52930†	
	7.13	9.53		4.32	17.4	21.85				
10	.281	.406		.218	.685	.908	.125 [3.18]		52931†	
	7.13	10.31		5.54	17.4	23.07				
¼-28 M6	.343	.625		.281	.747	1.033	.125 [3.18]		52933†	
	8.71	15.88		7.14	18.98	26.24				

Note: †Indicates terminal is available in tape mounted form.

BL Ring Tongue Terminals Wire Range 16-14 CMA 2,050-5,180 [1.038-2.625 mm²]

Terminal Tongue Material Thickness .033 [0.84] Max.
Barrel I.D. .085 [2.15] Min.

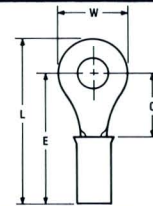

PIDG (PRE-INSULATED DIAMOND GRIP)

Stud Size	Tongue Dimensions				E Max.	L Max.	Vinyl		Nylon	
	C Min.	W	H	X			Maximum Insulation Diameter		Maximum Insulation Diameter	
2 M2	.171	.250			.575	.703	.150 [3.81] ,170 [4.32]		.150 [3.81] ,170 [4.32]	
	4.34	6.35			14.61	17.86				
4	.171	.180			.575	.668	.150 [3.81] ,170 [4.32]		.150 [3.81] ,170 [4.32]	
	4.34	4.57			14.61	16.97				
4	.171	.250			.575	.703	.150 [3.81] ,170 [4.32]		.150 [3.81] ,170 [4.32]	
	4.34	6.35			14.61	17.86				
4	.281	.250			.685	.813	.150 [3.81] ,170 [4.32]		.150 [3.81] ,170 [4.32]	
	7.13	6.35			17.4	20.66				

Note: †Indicates terminal is available in tape mounted form.

R Short Spring Spade Tongue Terminals
Wire Range 22-16
CMA 509-3,260 [.258-1.936 mm²]

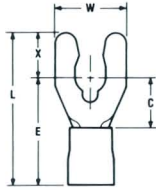

PLASTI-GRIP

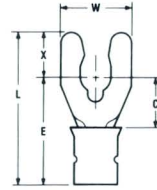

DIAMOND GRIP

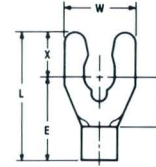

SOLISTRAND & BUDGET

E Max.	L Max.	Maximum Insulation Diameter		E Max.	L Max.	Maximum Insulation Diameter		E Max.	L Max.	Non Insulation Support		Stud Size
		.140 [3.56]	.200 [5.08]			SOLISTRAND	BUDGET					
.666 16.92	.811 20.6	52947†						.431 10.95	.576 14.64	53175-1†	53150-2†	4
.666 16.92	.811 20.6	52948†						.431 10.95	.576 14.64	53174-1†	53005-1†	5 M3
.666 16.92	.811 20.6	52949†	52949-2†					.431 10.95	.576 14.64	53120-1†	53006-1†	6 M3,5
.666 16.92	.811 20.6	53240-1†						.431 10.95	.576 14.64		53266-2†	
.697 17.71	.872 22.15	52950†	52950-2†					.462 11.74	.637 16.18		53007-1†	8 M4
.697 17.71	.872 22.15	53241-1†	53241-3†					.462 11.74	.637 16.18	53831-1†	53267-2†	
.697 17.71	.920 23.37	52951†	52951-2†					.462 11.74	.685 17.4		53008-1†	10
.697 17.71	.920 23.37	53242-1†	53242-5†					.462 11.74	.685 17.4	53832-1†	53268-2†	
								.524 13.31	.810 20.58		53235-2†	1/4-28 M6

BL Ring Tongue Terminals
Wire Range 16-14
CMA 2,050-5,180 [1.038-2.625 mm²]

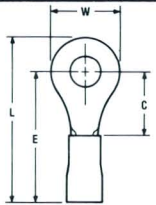

PLASTI-GRIP

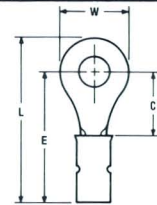

DIAMOND GRIP

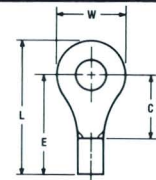

SOLISTRAND & BUDGET

E Max.	L Max.	Maximum Insulation Diameter			E Max.	L Max.	Maximum Insulation Diameter		E Max.	L Max.	Non Insulation Support		Stud Size
		.140 [3.56]	.170 [4.32]	.250 [6.35]			.150 [3.81]	.170 [4.32]			SOLISTRAND	BUDGET	
.587 14.91	.680 17.28	53249-1†							.352 8.95	.480 12.2	321626†	321007†	2 M2
.587 14.91	.715 18.17	32956†	34157†		.506 12.86	.634 16.11	32187†	32189†	.352 8.95	.445 11.31	328377†	326854†	
					.616 15.65	.744 18.9	322416†	322417†	.462 11.74	.590 14.99		32185†	4
												322419†	

BL Ring Tongue Terminals (Cont'd.) Wire Range 16-14 CMA 2,050-5,180 [1.038-2.625 mm²]

Dimensioning:

- All dimensions in inches and millimetres. Values in brackets are metric equivalents.
- Chart contains dimensions in inches over millimetres.

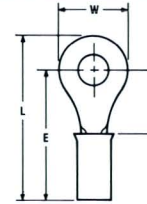

**Terminal Tongue Material Thickness .033 [0.84] Max.
Barrel I.D. .085 [2.15] Min.**

PIDG (PRE-INSULATED DIAMOND GRIP)

Stud Size	Tongue Dimensions				E Max.	L Max.	Vinyl		Nylon	
	C Min.	W	H	X			Maximum Insulation Diameter		Maximum Insulation Diameter	
							.150 [3.81]	.170 [4.32]	.150 [3.81]	.170 [4.32]
6 M3.5	.281 7.13	.312 7.92			.685 17.4	.844 21.44	51861†		51864†	
	.281 7.13	.250 6.35			.685 17.4	.813 20.66		50881		
	.281 7.13	.343 8.71			.685 17.4	.859 21.82	31898†	31901†	36157†	36158†
	.171 4.34	.250 6.35			.575 14.61	.703 17.86	32440†	32442†	320561†	320619†
	.250 6.35	.312 7.92			.654 16.62	.813 20.66	327871†	322234†	50764†	326882†
8 M4	.281 7.13	.312 7.92			.685 17.4	.844 21.44	51861-1†		51864-1†	
	.281 7.13	.343 8.71			.685 17.4	.859 21.82	31899†	31902†	320560†	320565†
	.250 6.35	.312 7.92			.654 16.62	.813 20.66		322236†		53941-1†
10	.281 7.13	.312 7.92			.685 17.4	.844 21.44	51861-2†		51864-2†	
	.281 7.13	.343 8.71			.685 17.4	.859 21.82	31900†	31903†	320574†	36160†
	.281 7.13	.375 9.53								
	.250 6.35	.312 7.92			.654 16.62	.813 20.66	327900†	322238†		53942-1†
	.296 7.51	.343 8.71			.700 17.78	.874 22.2	32854	32855		
12	.312 7.92	.468 11.89			.716 18.19	.953 24.21	324551†			
	.437 11.09	.469 11.91			.841 21.37	1.078 27.39		324533†		
	.437 11.09	.469 11.91			.841 21.37	1.078 27.39		324086†		
14	.312 7.92	.468 11.89			.716 18.19	.953 24.21		35274†		
	.437 11.09	.469 11.91			.841 21.37	1.078 27.39	31904†	31906†	320563†	321045†
5/16 M8	.312 7.92	.468 11.89								
	.437 11.09	.469 11.91			.841 21.37	1.078 27.39	31905†	31907†	320575†	328998†
¾	.437 11.09	.469 11.91								
	.531 13.48	.656 16.66			.935 23.75	1.266 32.16	322467	322468		
	.546 13.86	.531 13.49			.950 24.13	1.218 30.94	31908†	31909†	320564†	328999†
½ M12	.530 13.46	.713 18.11			.934 23.73	1.293 32.85	328949	328850	328976	328849
	.625 15.87	.750 19.05								

Note: †Indicates terminal is available in tape mounted form.

BL Ring Tongue Terminals (Cont'd.)
Wire Range 16-14
CMA 2,050-5,180 [1.038-2.625 mm²]

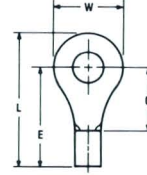
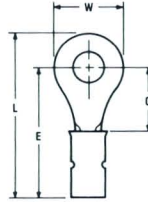
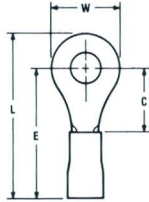

PLASTI-GRIP

DIAMOND GRIP

SOLISTRAND & BUDGET

E Max.	L Max.	Maximum Insulation Diameter			E Max.	L Max.	Maximum Insulation Diameter		E Max.	L Max.	Non Insulation Support		Stud Size
		.140 [3.56]	.170 [4.32]	.250 [6.35]			.150 [3.81]	.170 [4.32]			SOLISTRAND	BUDGET	
									.462 11.74	.640 16.26		51872-1†	
									.462 11.74	.590 14.99		1-322419-2	
.697 17.71	.871 22.13	32958†	34159†		.616 15.65	.790 20.07	30991†	30926†	.462 11.74	.636 16.16	34121†	30695†	6 M3.5
.587 14.91	.715 18.17	32957†	34158†		.506 12.86	.634 16.11	32188†	32190†	.352 8.95	.480 12.2	34120†	32186†	
					.585 14.86	.744 18.9		324528	.431 10.95	.590 14.99	321684†	321683†	
									.432 10.98	.560 14.23	34197	1-31152-0	
									.462 11.74	.640 16.26		51872-3†	
.697 17.71	.871 22.13	32959†	34160†		.616 15.65	.790 20.07	30992†	30927†	.462 11.74	.636 16.16	34122†	30696†	8 M4
.666 16.92	.825 20.96		328527†						.431 10.95	.590 14.99	324955†	322235†	
									.462 11.74	.640 16.26		51872-5†	
.697 17.71	.871 22.13	32960†	34161†	2-34161-2	.616 15.65	.790 20.07	30993†	30928†	.462 11.74	.636 16.16	34123†	30697†	
									.462 11.74	.654 16.62	35590	35589	
									.431 10.95	.590 14.99	324956†	322237†	10
									.477 12.12	.651 16.54		32840	
.728 18.5	.965 24.52		34954†						.493 12.53	.730 18.55		34895†	
									.618 15.7	.855 21.72		31247†	
					.772 19.61	1.009 25.63		31167†	.618 15.7	.855 21.72		31163†	12
.728 18.5	.965 24.52		34955†		.647 16.44	.884 22.46	320267†	320268†	.493 12.53	.730 18.55		34896†	14
.853 21.67	1.090 27.69	32961†	34162†		.772 19.61	1.009 25.63	31256†	31168†	.618 15.7	.855 21.72	34124†	31164†	1/4 M6
.728 18.5	.965 24.52		34956†						.493 12.53	.730 18.55		34897†	5/16 M8
.853 21.67	1.090 27.69	32962†	34163†		.772 19.61	1.009 25.63	31257†	31169†	.618 15.7	.855 21.72	34125†	31165†	
					.772 19.61	1.009 25.63		31170	.618 15.7	.855 21.72		31166	
					.866 22.	1.197 30.41		322466	.712 18.09	1.043 26.5		322464	3/8
.962 24.44	1.230 31.25	32963†	34164†		.881 22.38	1.149 29.19	31470†	31501†	.727 18.47	.995 25.28	34126†	31499†	
									.711 18.06	1.070 27.18		328971	1/2 M12
									.806 20.48	1.184 30.08	50981	50982	

Rectangular Tongue Terminals Wire Range 16-14 CMA 2,050-5,180 [1.038-2.625 mm²]

Dimensioning:

- All dimensions in inches and millimetres.
Values in brackets are metric equivalents.
- Chart contains dimensions in inches over millimetres.

Terminal Tongue Material Thickness .033 [0.84] Max.
Barrel I.D. .085 [2.15] Min.

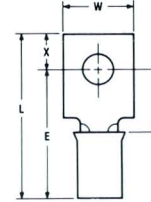

PIDG (PRE-INSULATED DIAMOND GRIP)

Stud Size	Tongue Dimensions				E Max.	L Max.	Vinyl		Nylon
	C Min.	W	H	X			Maximum Insulation Diameter		Maximum Insulation Diameter
							.150 [3.81]	.170 [4.32]	.170 [4.32]
4	.281 7.13	.234 5.94	.187 4.75	.187 4.75	.685 17.40	.877 22.28			
	.172 4.36	.219 5.56	.117 2.97	.117 2.97	.576 14.64	.698 17.73			
	.266 6.75	.215 5.46	.109 2.77	.109 2.77	.690 17.53	.814 20.68	2-33177-1	33177	
	.203 5.15	.344 8.74	.156 3.96	.156 3.96	.607 15.42	.768 19.51	36235		
	.404 10.26	.237 6.02	.195 4.95	.195 4.95	.810 20.58	1.015 25.79			2-327964-1†
	.237 6.01	.237 6.02	.143 3.63	.143 3.63	.643 16.34	.796 20.22		327970†	2-327970-1†
	.404 10.26	.237 6.02	.195 4.95	.195 4.95					
5 M3	.277 7.03	.277 7.04	.143 3.63	.143 3.63	.702 17.84	.855 21.72		327952†	2-327952-1†
	.277 7.03	.277 7.04	.143 3.63	.143 3.63					
6 M3.5	.343 8.71	.244 6.2	.141 3.58	.141 3.58	.747 18.98	.893 22.69		324817	
	.250 6.35	.359 9.12	.140 3.56	.140 3.56	.654 16.62	.799 20.3		324874	
	.203 5.15	.290 7.37	.156 3.96	.156 3.96	.607 15.42	.768 19.51		324809	
	.187 4.74	.250 6.35	.187 4.75	.187 4.75	.591 15.02	.783 19.89		324602	
	.203 5.15	.323 8.2	.140 3.56	.140 3.56	.607 15.42	.752 19.11		324562	
	.203 5.15	.296 7.52	.140 3.56	.140 3.56	.607 15.42	.752 19.11	33168†	33169†	
	.312 7.92	.244 6.2	.125 3.18	.125 3.18	.716 18.19	.856 21.75	33172†	33173†	
	.203 5.15	.344 8.74	.156 3.96	.156 3.96	.607 15.42	.768 19.51		36238	
	.465 11.81	.302 7.67	.227 5.77	.227 5.77	.872 22.15	1.109 28.17		327940†	2-327940-1†
	.404 10.26	.237 6.02	.195 4.96	.195 4.96	.810 20.58	1.015 25.79		327958†	2-327958-1†
	.437 11.09	.296 7.52	.140 3.56	.140 3.56					
	.281 7.13	.312 7.92	.250 6.35	.250 6.35					
	.203 5.15	.297 7.54	.219 5.56	.219 5.56					
.203 5.15	.297 7.54	.219 5.56	.219 5.56						

Note: †Indicates terminal is available in tape mounted form.

BL Rectangular Tongue Terminals
 Wire Range 16-14
 CMA 2,050-5,180 [1.038-2.625 mm²]

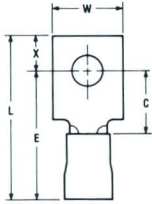

PLASTI-GRIP

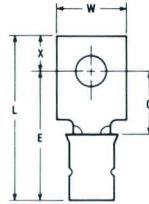

DIAMOND GRIP

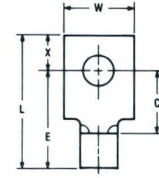

SOLISTRAND & BUDGET

E Max.	L Max.	Maximum Insulation Diameter		E Max.	L Max.	Maximum Insulation Diameter		E Max.	L Max.	Non Insulation Support		Stud Size
		.140 [3.56]	.170 [4.32]			.150 [3.81]	.170 [4.32]			SOLISTRAND	BUDGET	
				.616 15.65	.803 20.4		324885†	.462 11.74	.654 11.62		324884†	
								.353 8.97	.475 12.07	320813	320812	
.697 17.71	.811 20.6		34392	.621 15.78	.745 18.93	31692	31693	.462 11.74	.576 14.64	324634	31691	
				.538 13.67	.699 17.76	36227		.348 8.84	.545 13.85		35748	4
				.760 19.31	.965 24.52		328507†	.606 15.4	.811 20.6		327963†	
				.593 15.07	.746 18.95		328510†	.439 11.16	.592 15.04		327969†	
								.684 17.38	.889 22.59	328362†	328348	
				.593 15.07	.746 18.95		328501†	.470 12.15	.632 16.06		327951†	5 M3
								.557 14.15	.710 18.04	328358†	328344†	
				.678 17.23	.824 20.93		324816	.524 13.31	.670 17.02		324815	
				.585 14.86	.730 18.55		324873	.431 10.94	.576 14.64		324872	
				.538 13.67	.699 17.76		324808	.384 9.76	.545 13.85		324807	
								.368 9.35	.506 12.86	320815	320814	
.619 15.73	.764 19.41		324565	.538 13.67	.683 17.35		324564	.384 9.76	.529 13.44		324563	
				.538 13.67	.683 17.35	31814†	34815†	.384 9.76	.529 13.44	34266†	31813†	
.728 18.5	.868 20.05		34898†	.647 16.44	.787 19.99	31683†	31684†	.493 12.53	.633 16.08	34267†	31682†	6 M3.5
								.348 8.84	.545 13.85		35749	
				.821 20.86	1.058 26.88		328495†	.667 16.95	.904 22.97		327939†	
				.760 19.31	.965 24.52		328504†	.606 15.4	.811 20.6		327957†	
				.772 19.61	.917 23.3		324832	.618 15.7	.763 19.39		324831	
				.616 15.65	.871 22.13		326923	.462 11.74	.717 18.22		321692	
								.384 9.76	.608 15.45	320809	320808	
								.478 12.15	.702 17.84	330527		

BL Rectangular Tongue Terminals (Cont'd.)
Wire Range 16-14
CMA 2,050-5,180 [1.038-2.625 mm²]

Dimensioning:

1. All dimensions in inches and millimetres.
Values in brackets are metric equivalents.
2. Chart contains dimensions in inches over millimetres.

Terminal Tongue Material Thickness .033 [0.84] Max.
Barrel I.D. .085 [2.15] Min.

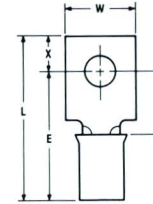

PIDG (PRE-INSULATED DIAMOND GRIP)

Stud Size	Tongue Dimensions				E Max.	L Max.	Vinyl		Nylon
	C Min.	W	H	X			Maximum Insulation Diameter		Maximum Insulation Diameter
							.150 [3.81]	.170 [4.32]	.170 [4.32]
8 M4	.437 11.09	.390 9.91	.312 7.92	.281 7.14	.846 21.49	1.158 29.42			
	.375 9.52	.312 7.92	.250 6.35	.281 7.14	.779 19.79	1.034 26.27			
	.593 15.06	.375 9.53	.281 7.14	.281 7.14	.997 25.33	1.283 32.59			
	.687 17.44	.312 7.92	.187 4.75	.281 7.14	1.091 27.72	1.283 32.59			
	.343 8.71	.375 9.53	.187 4.75	.281 7.14	.747 18.98	.939 23.86		33174	
	.312 7.92	.244 6.2	.125 3.18	.281 7.14	.716 18.19	.856 21.75			35279†
	.203 5.15	.344 8.74	.156 3.96	.281 7.14	.607 15.42	.768 19.51		36239	36240
	.281 7.13	.416 10.57	.187 4.75	.281 7.14	.685 17.4	.877 22.28			320774
	.343 8.71	.296 7.52	.187 4.75	.281 7.14	.747 18.98	.939 23.86			321283
	.281 7.13	.312 7.92	.250 6.35	.281 7.14	.685 17.4	.940 23.88		2-321445-1	321445
	.437 11.09	.375 9.53	.328 8.33	.281 7.14	.841 21.37	1.174 29.82			321456
	.621 15.77	.390 9.91	.310 7.87	.281 7.14	1.039 26.4	1.359 34.52			327934
	.465 11.81	.302 7.67	.227 5.77	.281 7.14	.827 21.01	1.109 28.17			327946†
	.312 7.92	.375 9.53	.271 6.88	.281 7.14					
	.281 7.13	.312 7.92	.250 6.35	.281 7.14					
	10	.203 5.15	.344 8.74	.156 3.96	.281 7.14	.607 15.42	.768 19.51		2-36242-1
.281 7.13		.312 7.92	.250 6.35	.281 7.14	.685 17.4	.940 23.88			324603
.281 7.13		.468 11.89	.203 5.16	.281 7.14					
.312 7.92		.375 9.53	.271 6.88	.281 7.14					
12	.437 11.09	.375 9.53	.328 8.33	.281 7.14	.841 21.37	1.174 29.82			324614
	.343 8.71	.375 9.53	.187 4.75	.281 7.14					
¼ M6	.437 11.09	.469 11.91	.469 11.91	.281 7.14					
	.437 11.09	.469 11.91	.469 11.91	.281 7.14					

Note: †Indicates terminal is available in tape mounted form.

BL Rectangular Tongue Terminals (Cont'd.)
Wire Range 16-14
CMA 2,050-5,180 [1.038-2.625 mm²]

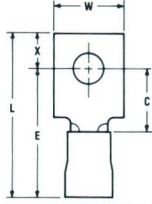

PLASTI-GRIP

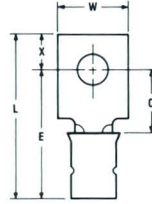

DIAMOND GRIP

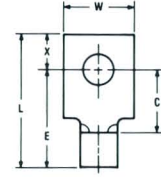

SOLISTRAND & BUDGET

E Max.	L Max.	Maximum Insulation Diameter		E Max.	L Max.	Maximum Insulation Diameter		E Max.	L Max.	Non Insulation Support		Stud Size
		.150 [3.81]	.170 [4.32]			SOLISTRAND	BUDGET					
		.772 19.61	1.089 27.67			324824		.618 15.7	.935 23.75	324823		
		.710 18.04	.965 24.52			324840		.556 14.13	.811 20.6	324839		
								.774 19.66	1.060 26.93	324932		
								.868 22.05	1.060 26.93	323902		
		.678 17.23	.870 22.1	31686	31687			.524 13.31	.716 18.19	321495	31685	
								4.93 12.53	.633 16.08		35278†	
		.538 13.67	.699 17.76	36231	36232			.348 8.84	.545 13.85		35750	
		.616 15.65	.808 20.53			320845		.362 9.2	.654 16.62		320775	8 M4
		.678 17.23	.870 22.1	35472	35377			.524 13.31	.716 18.19		35376	
		.616 15.65	.871 22.13			321446		.462 11.74	.717 18.22	320817	320816	
		.772 19.61	1.105 28.07			321457		.618 15.7	.951 24.16		321455	
		.997 25.33	1.297 32.95			328492		.823 20.91	1.143 29.06		327933	
		.821 20.86	1.058 26.88			328498†		.667 16.85	.904 22.97		327945†	
								.493 12.53	.769 19.54	321147	321145	
								.540 13.72	.795 20.2	328653	321483	
		.538 13.67	.699 17.76	36233	36234			.348 8.84	.545 13.85		35751	
								.462 11.74	.717 18.22	320819	320818	
		.616 15.65	.824 20.93	31846	31847			.462 11.74	.670 17.02	34268	31845	10
		.647 16.44	.923 23.45			324534		.493 12.53	.769 19.54		321146	
								.702 17.84	1.092 27.74	321833	31745	
								.618 15.7	.951 24.16	320821	320820	12
								.524 13.31	.716 18.19	35243†	35242	
								.618 15.7	.951 24.16	320807	320806	¼ M6
								.696 17.68	1.029 26.14	53554-1†		

BL Spade Tongue Terminals
Wire Range 16-14
CMA 2,050-5,180 [1.038-2.625 mm²]

Dimensioning:

1. All dimensions in inches and millimetres. Values in brackets are metric equivalents.
2. Charts contain dimensions in inches over millimetres.

Terminal Tongue Material Thickness .033 [0.84] Max.
Barrel I.D. .085 [2.15] Min.

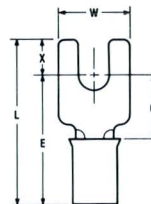

PIDG (PRE-INSULATED DIAMOND GRIP)

Stud Size	Tongue Dimensions				E Max.	L Max.	Vinyl		Nylon
	C Min.	W	H	X			Maximum Insulation Diameter		Maximum Insulation Diameter
6 M3.5	.312 7.92	.375 9.53	.187 4.75	.187 4.75	.716 18.19	.908 23.07	.150 [3.81]	.170 [4.32]	.170 [4.32]
	.203 5.15	.297 7.54	.141 3.58	.141 3.58	.607 15.42	.753 19.13		32055†	32058†
	.312 7.92	.244 6.2	.125 3.18	.125 3.18	.716 18.19	.846 21.49		35559†	326884†
	.203 5.15	.343 8.71	.156 3.96	.156 3.96			1-328281-0†	328281†	
	.203 5.15	.343 8.71	.155 3.94	.155 3.94					
	.312 7.92	.375 9.53	.187 4.75	.187 4.75	.716 18.19	.908 23.07		32056†	32059†
	.203 5.15	.297 7.54	.141 3.58	.141 3.58	.607 15.42	.753 19.13		321233†	
	.375 9.52	.312 7.92	.250 6.35	.250 6.35	.779 19.79	1.034 26.27		325199	
10	.203 5.15	.343 8.71	.155 3.94	.155 3.94					
	.312 7.92	.375 9.53	.187 4.75	.187 4.75	.716 18.19	.908 23.07	32057†	32060†	326869†

Note: †Indicates terminal is available in tape mounted form.

BL Flanged Spade Tongue Terminals
Wire Range 16-14
CMA 2,050-5,180 [1.038-2.625 mm²]

Terminal Tongue Material Thickness .033 [0.84] Max.
Barrel I.D. .085 [2.15] Min.

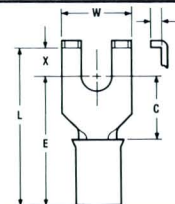

PIDG (PRE-INSULATED DIAMOND GRIP)

Stud Size	Tongue Dimensions				E Max.	L Max.	Vinyl		Nylon
	C Min.	W	H	X			Maximum Insulation Diameter		Maximum Insulation Diameter
6 M3.5	.203 5.15	.294 7.47	.052 1.32	.125 3.18	.607 15.42	.737 18.72	.150 [3.81]	.170 [4.32]	
	.203 5.15	.328 8.33	.047 1.19	.125 3.18	.607 15.42	.737 18.72	2-320861-2†	320861†	
8 M4	.250 6.35	.416 10.57	.062 1.57	.171 4.34	.654 16.62	.830 21.09			
	.203 5.15	.294 7.47	.052 1.32	.125 3.18	.607 15.42	.737 18.72	2-324567-2†	324567†	
10	.203 5.15	.294 7.47	.052 1.32	.125 3.18	.607 15.42	.737 18.72			
	.203 5.15	.294 7.47	.052 1.32	.125 3.18	.607 15.42	.737 18.72	33155†	33156†	
									320862†
							2-320863-3†	320863†	

Note: †Indicates terminal is available in tape mounted form.

BL Spade Tongue Terminals
Wire Range 16-14
CMA 2,050-5,180 [1.038-2.625 mm²]

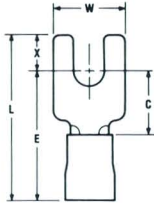

PLASTI-GRIP

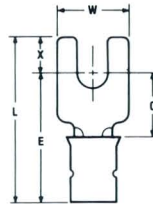

DIAMOND GRIP

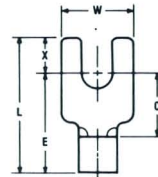

SOLISTRAND & BUDGET

E Max.	L Max.	Maximum Insulation Diameter			E Max.	L Max.	Maximum Insulation Diameter		E Max.	L Max.	Non Insulation Support		Stud Size
		.140 [3.56]	.170 [4.32]	.190 [4.83]			.150 [3.81]	.170 [4.32]			SOLISTRAND	BUDGET	
.728 18.5	.920 23.37	32964†	34165†		.647 16.44	.839 21.32	31707†	31710†	.493 12.53	.685 17.4	34127†	31704†	6 M3.5
.619 15.73	.765 19.44	322994†		36455	.538 13.67	.684 17.38	33650†	33204†	.384 9.76	.530 13.47	322996†	33202†	
					.647 16.44	.777 19.74	33222†		.493 12.53	.623 15.83	330827†	33221†	
					.538 13.67	.699 17.76		322294	.384 9.75	.545 13.85	321686	321685	
.728 18.5	.920 23.37	32965†	34166†	2-34166-2	.647 16.44	.839 21.32	31708†	31711†	.493 12.53	.685 17.4	34128†	31705†	8 M4
									.384 9.76	.530 13.47	36880†	35116†	
									.463 11.77	.623 15.83		325198	
.728 18.5	.920 23.37	32966†	34167†	324017	.647 16.44	.839 21.32	31709†	31712†	.493 12.53	.685 17.4	34129†	31706†	10
									.463 11.77	.623 15.83	32904†	32907†	
											32905	32908	

BL Flanged Spade Tongue Terminals
Wire Range 16-14
CMA 2,050-5,180 [1.038-2.625 mm²]

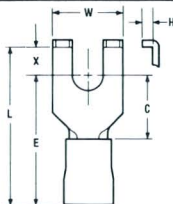

PLASTI-GRIP

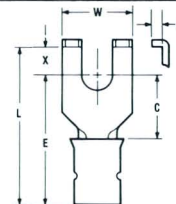

DIAMOND GRIP

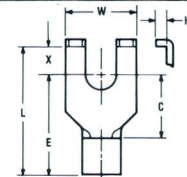

SOLISTRAND & BUDGET

E Max.	L Max.	Maximum Insulation Diameter	E Max.	L Max.	Maximum Insulation Diameter		E Max.	L Max.	Non Insulation Support		Stud Size		
		.170 [4.32]			.150 [3.81]	.170 [4.32]			SOLISTRAND	BUDGET			
.619 15.73	.749 19.03	324165†	.538 13.67	.685 17.4					320855†	320852†	6 M3.5		
.619 15.73	.749 19.03	324570†	.538 13.67	.668 16.97					324571†	324568†			
.666 16.92	.842 21.39	324170†							.431 10.95	.607 15.42	324171†	32413†	8 M4
.538 13.67	.685 17.4	320859†							.384 9.76	.514 13.06	320856†	320853†	
			.538 13.67	.685 17.4	320860†				.384 9.76	.514 13.06	320857†	320854†	10

BL Hook Tongue Terminals Wire Range 16-14 CMA 2,050-5,180 [1.038-2.625 mm²]

Dimensioning:

1. All dimensions in inches and millimetres. Values in brackets are metric equivalents.
2. Charts contain dimensions in inches over millimetres.

Terminal Tongue Material Thickness .033 [0.84] Max.
Barrel I.D. .085 [2.15] Min.

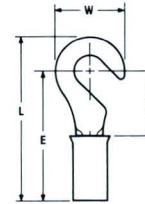

PIDG (PRE-INSULATED DIAMOND GRIP)

Stud Size	Tongue Dimensions				E Max.	L Max.	Vinyl		Nylon
	C Min.	W	H	X			Maximum Insulation Diameter		Maximum Insulation Diameter
6 M3.5	.281 7.13	.343 8.71			.685 17.4	.859 21.82	.150 [3.81]	.170 [4.32]	
8 M4	.281 7.13	.343 8.71			.685 17.4	.859 21.82			320306†
10	.281 7.13	.343 8.71			.685 17.4	.859 21.81			35481†

Note: †Indicates terminal is available in tape mounted form.

BL Slotted Ring Tongue Terminals Wire Range 16-14 CMA 2,050-5,180 [1.038-2.625 mm²]

Terminal Tongue Material Thickness .033 [0.84] Max.
Barrel I.D. .085 [2.15] Min.

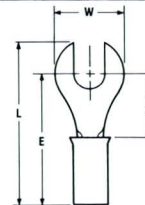

PIDG (PRE-INSULATED DIAMOND GRIP)

Stud Size	Tongue Dimensions				E Max.	L Max.	Vinyl		Nylon
	C Min.	W	H	X			Maximum Insulation Diameter		Maximum Insulation Diameter
6 M3.5	.281 7.13	.343 8.71			.685 17.4	.844 21.44	.150 [3.81]	.170 [4.32]	
	.171 4.34	.250 6.35							34406†
8 M4	.281 7.13	.343 8.71			.685 17.4	.837 21.26			35440†
10	.281 7.13	.343 8.71			.685 17.4	.830 21.09			328871†
¼ M6	.437 11.09	.469 11.91			.841 21.37	1.039 26.4			36217†

Note: †Indicates terminal is available in tape mounted form.

BL Hook Tongue Terminals
 Wire Range 16-14
 CMA 2,050-5,180 [1.038-2.625 mm²]

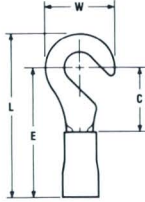

PLASTI-GRIP

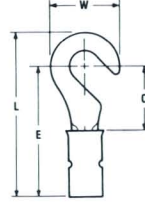

DIAMOND GRIP

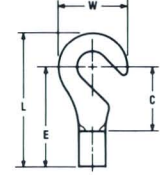

SOLISTRAND & BUDGET

E Max.	L Max.	Maximum Insulation Diameter	E Max.	L Max.	Maximum Insulation Diameter	E Max.	L Max.	Non Insulation Support		Stud Size
								SOLISTRAND	BUDGET	
		.170 [4.32]			.170 [4.32]					
								35212†		6 M3.5
.697 17.71	.871 22.13	320363†	.616 15.65	.790 20.07	32515†	.462 11.74	.636 16.16	320257†	32503†	8 M4
.665 16.9	.839 21.32	324134†				.541 13.75	.716 18.19	36371†	33437†	10

BL Slotted Ring Tongue Terminals
 Wire Range 16-14
 CMA 2,050-5,180 [1.038-2.625 mm²]

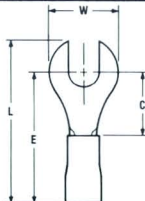

PLASTI-GRIP

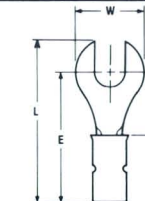

DIAMOND GRIP

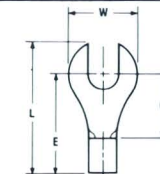

SOLISTRAND & BUDGET

E Max.	L Max.	Maximum Insulation Diameter	E Max.	L Max.	Maximum Insulation Diameter	E Max.	L Max.	Non Insulation Support		Stud Size
								SOLISTRAND	BUDGET	
					.170 [4.32]					
			.506 12.86	.622 15.8	35556	.352 8.95	.459 11.66	322514	32186	6 M3.5
			.616 15.65	.770 19.56	34521†	.462 11.74	.614 15.6	36445†	34520†	8 M4
						.462 11.74	.607 15.42	321266†	34123†	10
						.618 15.7	.816 20.73	321087†	36216†	1/4 M6

BL Long Spring Spade Tongue
 Wire Range 16-14
 CMA 2,050-5,180 [1.038-2.625 mm²]

Dimensioning:

1. All dimensions in inches and millimetres. Values in brackets are metric equivalents.
2. Charts contain dimensions in inches over millimetres.

Terminal Tongue Material Thickness .033 [0.84] Max.
 Barrel I.D. .085 [2.15] Min.

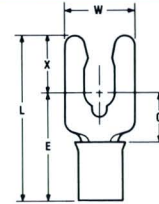

PIDG (PRE-INSULATED DIAMOND GRIP)

Stud Size	Tongue Dimensions				E Max.	L Max.	Vinyl		Nylon
	C Min.	W	H	X			Maximum Insulation Diameter		Maximum Insulation Diameter
6 M3.5	.243	.250		.276	.647	.928	.150 [3.81]	.170 [4.32]	.170 [4.32]
	6.17	6.35		7.01					
8 M4	.275	.281		.290	.679	.974	.150 [3.81]	.170 [4.32]	.170 [4.32]
	6.98	7.14		7.37					
10	.288	.343		.303	.692	1.000	.150 [3.81]	.170 [4.32]	.170 [4.32]
	7.31	8.71		7.70					
¼-28 M6	.345	.437		.338	.692	1.000	.150 [3.81]	.170 [4.32]	.170 [4.32]
	8.76	11.1		8.59					

Note: †Indicates terminal is available in tape mounted form.

BL Short Spring Spade Tongue
 Wire Range 16-14
 CMA 2,050-5,180 [1.038-2.625 mm²]

Terminal Tongue Material Thickness .033 [0.84] Max.
 Barrel I.D. .085 [2.15] Min.

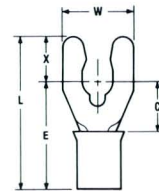

PIDG (PRE-INSULATED DIAMOND GRIP)

Stud Size	Tongue Dimensions				E Max.	L Max.	Vinyl		Nylon			
	C Min.	W	H	X			Maximum Insulation Diameter		Maximum Insulation Diameter			
5 M3	.218	.250		.140	.622	.767	.170 [4.32]	.182 [4.63]				
	5.53	6.35		3.56						52934†	52934-2	
6 M3.5	.218	.250		.140	.622	.767	.170 [4.32]	.182 [4.63]				
	5.53	6.35		3.56						52935†	52935-2†	
	.218	.234		.140						5.53	5.94	
8 M4	.281	.375		.170	.685	.860	.170 [4.32]	.182 [4.63]				
	7.13	9.53		4.32						17.4	21.85	52936†
10	.281	.244		.170	.685	.908	.170 [4.32]	.182 [4.63]				
	7.13	6.2		4.32						17.4	23.07	52937†
¼-28 M6	.281	.406		.218	.685	.908	.170 [4.32]	.182 [4.63]				
	7.13	10.31		5.54						17.4	23.07	52939†
¼-28 M6	.343	.625		.281	.685	.908	.170 [4.32]	.182 [4.63]				
	8.71	15.88		7.14						17.4	23.07	52939†

Note: †Indicates terminal is available in tape mounted form.

BL Long Spring Spade Tongue
Wire Range 16-14
CMA 2,050-5,180 [1.038-2.625 mm²]

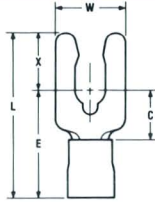

PLASTI-GRIP

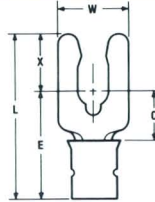

DIAMOND GRIP

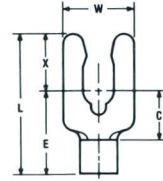

SOLISTRAND & BUDGET

E Max.	L Max.	Maximum Insulation Diameter		E Max.	L Max.	Maximum Insulation Diameter		Non Insulation Support		Stud Size		
		.170 [4.32]						SOLISTRAND	BUDGET			
.664 16.87	.945 24.01	52463†						.429 10.9	.709 18.01	52712-1†	52703-1†	6 M3.5
.696 17.68	.991 25.18	52464†						.461 11.71	.756 19.21	52713-1†	52704-1†	8 M4
.709 18.01	1.017 25.84	52465†						.474 12.04	.782 19.87	52714-1†	52705-1†	10
.771 19.59	1.114 28.3	52466†						.546 13.87	.879 22.33	53176-1†	53033-1†	1/4-28 M6

BL Short Spring Spade Tongue
Wire Range 16-14
CMA 2,050-5,180 [1.038-2.625 mm²]

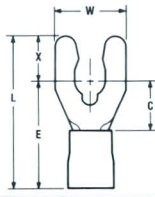

PLASTI-GRIP

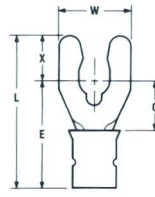

DIAMOND GRIP

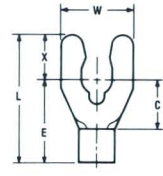

SOLISTRAND & BUDGET

E Max.	L Max.	Maximum Insulation Diameter		E Max.	L Max.	Maximum Insulation Diameter		Non Insulation Support		Stud Size		
		.170 [4.32] .190 [4.83]						SOLISTRAND	BUDGET			
.634 16.11	.779 19.79	52954†						.399 10.14	.544 13.82	53177-1†	53009-1†	5 M3
.634 16.11	.779 19.79	52955†	52955-2†					.399 10.14	.544 13.82	53123-1†	53010-1†	6 M3.5
.634 16.11	.779 19.79	53243-1†	53243-3†					.441 11.21	.576 14.64		53267-2†	
.697 17.71	.872 22.15	52956†	52956-2†					.462 11.74	.637 16.18	53124-1†	53011-1†	8 M4
.697 17.71	.872 22.15	53244-1†	53244-3†					.462 11.74	.687 17.45	53833-1†	53270-2†	
.697 17.71	.920 23.37	52957†	52957-2†					.462 11.74	.685 17.4	53125-1†	53012-1†	
.697 17.71	.920 23.37	53245-1†						.462 11.74	.685 17.4		53271-2†	
.759 19.28	1.045 26.55	52959†						.534 13.57	.810 20.58	53139-1	53032-1†	1/4-28 M6



Heavy Duty Ring Tongue Terminals Wire Range 16-14 CMA 2,050-5,180 [1.038-2.625 mm²]

Dimensioning:

- All dimensions in inches and millimetres. Values in brackets are metric equivalents.
- Chart contains dimensions in inches over millimetres.

**Terminal Tongue Material Thickness .050 [1.3] Max.
Barrel I.D. .105 [2.67] Min.**

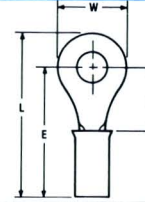

PIDG (PRE-INSULATED DIAMOND GRIP)

Stud Size	Tongue Dimensions				E Max.	L Max.	Vinyl			Nylon
	C Min.	W	H	X			Maximum Insulation Diameter			Maximum Insulation Diameter
							.230 [5.85]	.250 [6.4]	.300 [7.7]*	.230 [5.85]
2 M2	.219 5.56	.281 7.14			.810 20.58	.953 24.21	33733†			
4	.219 5.56	.281 7.14			.810 20.58	.953 24.21	33734†			35602†
6 M3.5	.219 5.56	.281 7.14			.810 20.58	.953 24.21	33735†	35634†	35536†	320631†
	.281 7.13	.343 8.71			.872 22.15	1.046 26.57	33724†	34592†	36280†	
8 M4	.437 11.09	.281 7.14			1.028 26.12	1.171 29.75	323956			332318
	.281 7.13	.343 8.71			.872 22.15	1.046 26.57	33725†	35106†	35603†	320627†
	.281 7.13	.343 8.71			.872 22.15	1.046 26.57	33726†	34805†	35363†	320630†
10	.344 8.73	.500 12.7			.935 23.75	1.188 30.18	35682†			324642†
	.437 11.09	.531 13.49			1.028 26.12	1.296 32.92	33643			2-33643-1
	.437 11.09	.375 9.53			1.028 26.12	1.218 30.94				322201
¼ M6	.344 8.73	.500 12.7			.935 23.75	1.188 30.18	34974†	323682†	35414†	
	.437 11.09	.531 13.49			1.028 26.12	1.296 32.92	33196†	34806†	35362†	327743†
5/16 M8	.344 8.73	.500 12.7								
	.437 11.09	.531 13.49			1.028 26.12	1.296 32.92	34810			35538
¾	.437 11.09	.531 13.49			1.028 26.12	1.296 32.92	33645			34811
	.625 15.87	.750 19.05								35537
½ M12	.625 15.87	.750 19.05			1.216 30.89	1.594 40.49	35316			321919
	1.000 25.4	1.250 31.75			1.591 40.42	2.219 56.37	36203			36485
5/8 M16	1.000 25.4	1.250 31.75								
¾	1.000 25.4	1.250 31.75			1.591 40.42	2.219 56.37	322724			

Notes: †Indicates terminal is available in tape mounted form. Use 12-10 Tooling.
*Add .089 [2.27] to E Max. and L Max.
**Add .062 [1.58] to E Max. and L Max.

Y/k Heavy Duty Ring Tongue Terminals
 Wire Range 16-14
 CMA 2,050-5,180 [1.038-2.625 mm²]

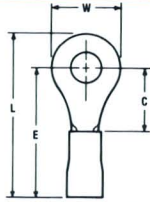

PLASTI-GRIP

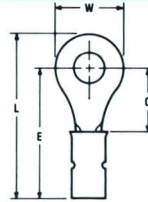

DIAMOND GRIP

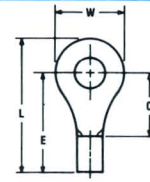

SOLISTRAND & BUDGET

E Max.	L Max.	Maximum Insulation Diameter			E Max.	L Max.	Maximum Insulation Diameter		E Max.	L Max.	Non Insulation Support		Stud Size
		.200 [5.1]	.230 [5.85]	.250 [6.4]			.230 [5.85]	.300 [7.7]**			SOLISTRAND	BUDGET	
									.487	.630			2 M2
									12.37	16.01		33727†	
.810	.953	34820†			.734	.877	33731†		.487	.630		33728†	4
20.58	24.21				18.65	22.28			12.37	16.01			
.810	.953	34821†		324182†	.734	.877	33732†		.487	.630		33729†	
20.58	24.21				18.65	22.28			12.37	16.01			
.872	1.046	52234-3†			.796	.970	33720†	330394†	.549	.723	322833†	33716†	6 M3.5
22.15	26.57				20.22	24.64			13.95	18.37			
									.705	.848		323955	
									17.91	21.54			
.872	1.046	34822†			.796	.970	33721†		.549	.723	35432†	33717†	8 M4
22.15	26.57				20.22	24.64			13.95	18.37			
.872	1.046	34823†	320388†	321518†	.796	.970	33722†	328222†	.549	.723	34567†	33718†	
22.15	26.57				20.22	24.64			13.95	18.37			
									.612	.865	35774†	34967†	
									15.55	21.98			
1.028	1.296		324059		.952	1.220	33640		.705	.973		33646	10
26.12	32.92				24.19	30.99			17.91	24.72			
									.705	.895		322200	
									17.91	22.74			
.935	1.188		35349†						.612	.865	35775†	34968†	¼ M6
23.75	30.17								15.55	21.98			
1.028	1.296	34824†			.952	1.220	33639†	322296†	.705	.973	52728†	33195†	
26.12	32.92				24.19	30.99			17.91	24.72			
									.612	.865	35776†	34969†	
									15.55	21.98			
1.028	1.296	34825			.952	1.220	33641		.705	.973	52727	33647	5/16 M8
26.12	32.92				24.19	30.99			17.91	24.72			
									.705	.973	322832	33648	
					.952	1.220	33642	328223	.705	.973			
					24.19	30.99			17.91	24.72			
1.216	1.594	34826							.893	1.271	327732	34829	¾
30.89	40.49								22.69	32.29			
1.216	1.594	34827			1.140	1.518	328287		.893	1.271	321165	34830	½ M12
30.89	40.49				28.96	38.56			22.69	32.29			
									1.268	1.896	320757	36199	
									32.21	48.16			
									1.268	1.896	320578	36200	¾ M16
									32.21	48.16			
									1.268	1.896	320759	36201	¾
									32.21	48.16			

Y Ring Tongue Terminals
 Wire Range 12-10
 CMA 5,180-13,100 [2.625-6.638 mm²]

Dimensioning:

- All dimensions in inches and millimetres. Values in brackets are metric equivalents.
- Chart contains dimensions in inches over millimetres.

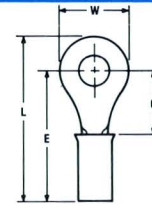

Terminal Tongue Material Thickness .042 [1.07] Max.
 Barrel I.D. .129 [3.27] Min.

PIDG (PRE-INSULATED DIAMOND GRIP)

Stud Size	Tongue Dimensions				E Max.	L Max.	Vinyl			Nylon
	C Min.	W	H	X			Maximum Insulation Diameter			Maximum Insulation Diameter
							.230 [5.85]	.250 [6.35]	.300 [7.62]*	.230 [5.85]
4	.219 5.56	.281 7.14			.810 20.58	.953 24.21	1-35148-0†	35148†	326820†	
	.219 5.56	.281 7.14			.810 20.58	.953 24.21	321500†	35149†	324985†	320634†
6 M3.5	.302 7.67	.312 7.92			.893 22.69	1.052 26.73	324912†			326886†
	.302 7.67	.375 9.53			.893 22.69	1.083 27.51	32542†	35107†	35604†	320567†
8 M4	.281 7.13	.312 7.92			.872 22.15	1.031 26.19	35787†**			
	.281 7.13	.343 8.71			.872 22.15	1.046 26.57	33443**			
	.302 7.67	.312 7.92			.893 22.69	1.052 26.73	324915			
	.302 7.67	.375 9.53			.893 22.69	1.083 27.51	32543†	35108†	35605†	320568†
10	.281 7.13	.343 8.71			.872 22.15	1.046 26.57	32883**			
	.302 7.67	.312 7.92			.893 22.69	1.052 26.73	324918			
	.302 7.67	.375 9.53			.893 22.69	1.083 27.51	32544†	35109†	35364†	36161†
	.343 8.71	.375 9.53								
1/4 M6	.344 8.73	.500 12.7			.935 23.75	1.188 30.18			323762†	2-323762-1†
	.468 11.88	.531 13.49			.935 23.75	1.188 30.18	35273†		323763†	
	.468 11.88	.531 13.49			1.054 26.78	1.322 33.58	32545†	35110†	35345†	320569†
5/16 M8	.344 8.73	.500 12.7			.935 23.75	1.188 30.18	324952			
	.468 11.88	.531 13.49			1.054 26.78	1.322 33.58	32546†	35111†	35346†	320576†
	.531 13.48	.593 15.06								
3/8	.468 11.88	.531 13.49								
	.531 13.48	.593 15.06			1.115 28.33	1.414 35.92	32547	35112	35478	320577
	.625 15.87	.750 19.05			1.216 30.89	1.594 40.49		35150		

Notes: †Indicates terminal is available in tape mounted form.
 *Add .089 [2.27] to E Max. and L Max.
 **Narrow throat.

Y Ring Tongue Terminals
 Wire Range 12-10
 CMA 5,180-13,100 [2.625-6.638 mm²]

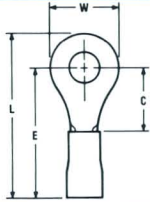

PLASTI-GRIP

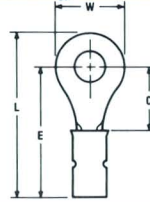

DIAMOND GRIP

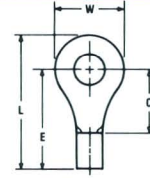

SOLISTRAND & BUDGET

E Max.	L Max.	Maximum Insulation Diameter			E Max.	L Max.	Maximum Insulation Diameter	E Max.	L Max.	Non Insulation Support		Stud Size	
		.200 [5.08]	.230 [5.85]	.250 [6.35]						SOLISTRAND	BUDGET		
.810 20.58	.953 24.21			34835†						322447†	34891†	4	
.810 20.58	.953 24.21			34852†						.487 12.37	.630 16.01	35476†	34891†
					.817 20.76	.976 24.8	326889†			.570 14.48	.729 18.52	324911†	324910†
.893 22.69	1.083 27.51	32967†		34168†						.570 14.48	.760 19.31	33456†	31112†
					.796 20.22	.955 24.26	324523†**			.549 13.95	.708 17.99	322454†**	34404†**
					.796 20.22	.970 24.64	33442**			.549 13.95	.723 18.37		32519
										.570 14.48	.729 18.52	324914	324913
.893 22.69	1.083 27.51	32968†		34169†	.817 20.76	1.007 25.58	31826†			.570 14.48	.760 19.31	32994†	31113†
										.549 13.95	.732 18.37	322455	32882
.893 22.69	1.052 26.73			330518						.570 14.48	.729 18.52	324917	324916
.893 22.69	1.083 27.51	32969†		34170†	.817 20.76	1.007 25.58	31771†			.570 14.48	.760 19.31	33457†	31114†
										.611 15.52	.808 20.53	31805†	321829†
										.612 15.55	.865 21.98	35771†	34964†
					.983 24.97	1.251 31.78	32181†			.736 18.7	1.004 25.51	36451†	31120†
										.612 15.55	.865 21.98	35772†	34965†
1.059 26.9	1.327 33.71	32970†		34171†	.983 24.97	1.251 31.78	31772†			.736 18.7	1.004 25.51	33458†	31122†
										.612 15.55	.865 21.98	35773	34966
1.059 26.9	1.327 33.71	32971†		34172†	.983 24.97	1.251 31.78	31827†			.736 18.7	1.004 25.51	33459†	31123†
										.799 20.3	1.098 27.89	322457	30971
										.736 18.7	1.004 25.51	322458	31124
1.122 28.5	1.421 36.1	32972		34173	1.046 26.57	1.345 34.17	31828			.799 20.3	1.098 27.89	33220	30972
1.216 30.89	1.594 40.49			34846						.893 22.69	1.273 32.34	322242	34833

Y Ring Tongue Terminals (Cont'd.)
Wire Range 12-10
CMA 5,180-13,100 [2.625-6.638 mm²]

Dimensioning:

1. All dimensions in inches and millimetres. Values in brackets are metric equivalents.
2. Charts contain dimensions in inches over millimetres.

Terminal Tongue Material Thickness .042 [1.07] Max.
Barrel I.D. .129 [3.27] Min.

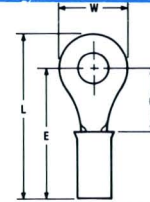

PIDG (PRE-INSULATED DIAMOND GRIP)

Stud Size	Tongue Dimensions				E Max.	L Max.	Vinyl		Nylon
	C Min.	W	H	X			Maximum Insulation Diameter		Maximum Insulation Diameter
							.230 [5.85]	.250 [6.35]	.300 [7.62]*
1/2 M12	.474 12.03	.715 18.16			1.054 26.78	1.414 35.92			52076 52077
	.560 14.22	.715 18.16			1.151 29.24	1.511 38.38			331468 331467
	.625 15.87	7.50 19.05			1.216 30.89	1.594 40.49	35151	35479	323784
	1.000 25.4	1.250 31.75			1.591 40.42	2.219 56.37	322438		
5/8 M16	1.000 25.4	1.250 31.75			1.591 40.42	2.219 56.37	324615		
3/4	1.000 25.4	1.250 31.75			1.591 40.42	2.219 56.37	322437		
7/8 M22	1.000 25.4	1.250 31.75							
1	1.000 25.4	1.250 31.75							
1-1/16	1.000 25.4	1.250 31.75							

Note: *Add .089 [2.27] to E Max. and L Max.

Y Rectangular Tongue Terminals
Wire Range 12-10
CMA 5,180-13,100 [2.625-6.638 mm²]

Terminal Tongue Material Thickness .042 [1.07] Max.
Barrel I.D. .129 [3.27] Min.

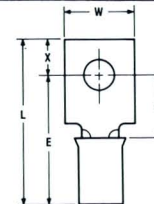

PIDG (PRE-INSULATED DIAMOND GRIP)

Stud Size	Tongue Dimensions				E Max.	L Max.	Vinyl		Nylon
	C Min.	W	H	X			Maximum Insulation Diameter		Maximum Insulation Diameter
							.230 [5.85]		.230 [5.85]
4	.281 7.13	.324 8.24		.187 4.75	.872 22.15	1.064 27.03	324882†		
	.404 10.26	.237 6.02		.195 4.95	.998 25.35	1.203 30.56	327966†		2-327966-1†
	.237 6.01	.237 6.02		.143 3.63	.831 21.11	.984 25.0	327972†		2-327972-1†
5 M3	.277 7.03	.277 7.04		.143 3.63	.889 22.59	1.042 26.47	327954†		2-327954-1†

Note: †Indicates terminal is available in tape mounted form.

Y Ring Tongue Terminals (Cont'd.)
Wire Range 12-10
CMA 5,180-13,100 [2.625-6.638 mm²]

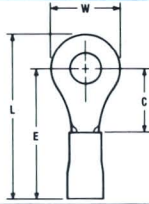

PLASTI-GRIP

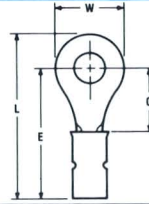

DIAMOND GRIP

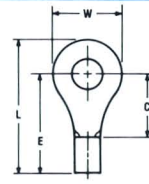

SOLISTRAND & BUDGET

E Max.	L Max.	Maximum Insulation Diameter	E Max.	L Max.	Maximum Insulation Diameter	E Max.	L Max.	Non Insulation Support		Stud Size
								SOLISTRAND	BUDGET	
		.250 [6.35]			.230 [5.85]					
						.742 18.85	1.102 28		52269	
						.828 21.04	1.188 30.18		331437	
1.216 30.89	1.594 40.49	34837	1.140 28.96	1.518 38.56	329968	.893 22.69	1.273 32.34	35135	34834	1/2 M12
						1.268 32.21	1.896 48.16	320763	320760	
						1.268 32.21	1.896 48.16	320764	320761	5/8 M16
						1.268 32.21	1.896 48.16	320765	320762	3/4
						1.268 32.21	1.896 48.16	1-320765-1		7/8 M22
						1.268 32.21	1.896 48.16	1-320765-0	2-320762-0	1
						1.268 32.21	1.896 48.16	2-320765-2		1-1/16

Y Rectangular Tongue Terminals
Wire Range 12-10
CMA 5,180-13,100 [2.625-6.638 mm²]

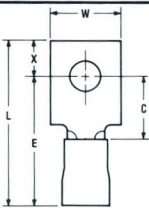

PLASTI-GRIP

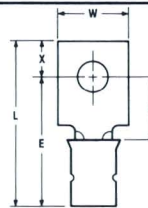

DIAMOND GRIP

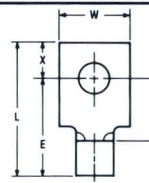

SOLISTRAND & BUDGET

E Max.	L Max.	Maximum Insulation Diameter	E Max.	L Max.	Maximum Insulation Diameter	E Max.	L Max.	Non Insulation Support		Stud Size
								SOLISTRAND	BUDGET	
					.230 [5.85]					
			.796 20.22	.988 25.10	324881†	.549 13.95	.741 18.83	324879†	324880†	
			.940 23.88	1.145 29.09	328508†	.693 17.61	.898 22.81	327965†		4
			.773 19.64	.926 23.53	328511†	.526 13.37	.679 17.25	328050†	327971†	
			.813 20.66	.966 24.54	328502†	.566 14.38	.719 18.27	327953†		5 M3

Y Rectangular Tongue Terminals (Cont'd.)
Wire Range 12-10
CMA 5,180-13,100 [2.625-6.638 mm²]

Dimensioning:

1. All dimensions in inches and millimetres.
 Values in brackets are metric equivalents.
2. Chart contains dimensions in inches over millimetres.

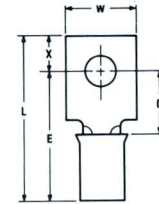

Terminal Tongue Material Thickness .042 [1.07] Max.
Barrel I.D. .129 [3.27] Min.

PIDG (PRE-INSULATED DIAMOND GRIP)

Stud Size	Tongue Dimensions				E Max.	L Max.	Vinyl	Nylon
	C Min.	W	H	X			Maximum Insulation Diameter	
							.230 [5.85]	
6 M3.5	.468 11.88	.290 7.37	.140 3.56	.140 3.56	1.059 26.90	1.204 30.59	324862	
	.281 7.13	.359 9.12	.140 3.56	.140 3.56	.872 22.15	1.017 25.84	324870	
	.218 5.53	.290 7.37	.140 3.56	.140 3.56	.809 20.55	.954 24.24	34512	
	.320 8.12	.292 7.42	.141 3.58	.141 3.58	.911 23.14	1.057 26.85	324180	
	.343 8.71	.323 8.2	.140 3.56	.140 3.56	.934 23.73	1.079 27.41	324582	
	.468 11.88	2.34 5.94	.141 3.58	.141 3.58	1.059 26.9	1.205 30.61	324854	
	.218 5.53	.290 7.37	.187 4.75	.218 5.54	.809 20.55	1.032 26.22	324942	
	.465 11.81	.302 7.67	.227 5.77	.227 5.77	1.044 26.52	1.281 32.54	327942†	2-327942-1†
	.404 10.26	.237 6.02	.195 4.95	.195 4.95	.998 25.35	1.203 30.56	327960†	2-327960-1†
	.302 7.67	.250 6.35	.187 4.75	.187 4.75	.893 22.69	1.085 27.56	329697†	
	.281 7.13	.277 7.04	.140 3.56	.140 3.56	.872 22.15	1.017 25.84	329831	
	.468 11.88	.296 7.52	.265 6.73	.265 6.73				
	.302 7.67	.250 6.35	.187 4.74	.187 4.74				
	8 M4	.468 11.88	.390 9.91	.312 7.92	.312 7.92	1.059 26.90	1.376 34.96	324858
.468 11.88		.312 7.92	.250 6.35	.250 6.35	1.059 26.90	1.314 33.38	324866	
.465 11.81		.302 7.67	.160 4.06	.160 4.06	1.077 27.36	1.247 31.68	331268†	
.320 8.12		.312 7.92	.250 6.35	.250 6.35	.911 23.14	1.166 29.62	321447	
.625 15.87		.312 7.92	.312 7.92	.312 7.92	1.216 30.89	1.533 38.93	323210	
.320 8.12		.416 10.57	.250 6.35	.250 6.35	.911 23.14	1.166 29.62	324592	
.593 15.06		.375 9.58	.281 7.14	.281 7.14	1.184 30.08	1.470 37.34	324936	
.621 15.77		.390 9.91	.310 7.87	.310 7.87	1.211 30.76	1.531 38.89	327936	2-327936-1
.465 11.81		.302 7.67	.227 5.77	.227 5.77	1.044 26.52	1.281 32.54	327948†	2-327948-1†
.672 17.06		.375 9.53	.187 4.75	.187 4.75				
10	.468 11.88	.375 9.53	.268 6.81	.268 6.81	1.059 26.9	1.327 33.71	321453	
	.320 8.12	.312 7.92	.250 6.35	.250 6.35				
	.302 7.67	.296 7.52	.192 4.88	.192 4.88				
¼ M6	.468 11.88	.469 11.91	.328 8.33	.328 8.33				
12 M12	.437 11.09	.375 9.53	.328 8.33	.328 8.33	1.028 26.12	1.361 34.57	324972	

Note: †Indicates terminal is available in tape mounted form.

Y Rectangular Tongue Terminals (Cont'd.)
Wire Range 12-10
CMA 5,180-13,100 [2.625-6.638 mm²]

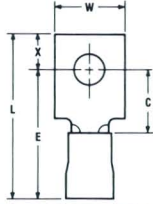

PLASTI-GRIP

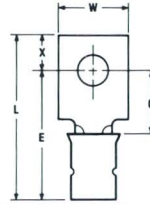

DIAMOND GRIP

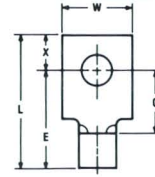

SOLISTRAND & BUDGET

E Max.	L Max.	Maximum Insulation Diameter	E Max.	L Max.	Maximum Insulation Diameter	E Max.	L Max.	Non Insulation Support		Stud Size
								SOLISTRAND	BUDGET	
		.230 [5.85]			.230 [5.85]					
			.983 24.97	1.128 28.66	324861	.736 18.7	.881 22.38		324860	
			.791 20.10	.936 23.78	324869	.549 13.95	.694 17.63		324868	
			.733 18.62	.878 22.31	33427	.486 12.35	.631 16.03	321499	33462	
			.835 21.21	.981 24.92	320869	.588 14.94	.734 18.65	323142	320868	
			.858 21.80	1.003 25.48	324585	.611 15.52	.756 19.21	324583	324584	
			.983 24.97	1.129 28.68	324853	.736 18.7	.882 22.41		324852	
						.486 12.35	.709 18.01		324940	6 M3.5
			1.001 25.43	1.238 31.45	328496†	.754 19.16	.991 25.18		327941†	
1.016 25.81	1.221 31.02	331388†				.693 17.61	.898 22.81		327959†	
			.817 20.76	1.009 25.63	33161†	.570 14.48	.762 19.36		325079†	
						.549 13.95	.694 17.63		329830	
						.736 18.7	1.006 25.56	322946	322945	
						.635 16.13	.827 21.01	330535	331435	
			.983 24.97	1.300 33.03	324857	.736 18.7	1.053 26.75		324856	
			.983 24.97	1.238 31.45	324865	.736 18.7	.991 25.18		324864	
						.754 19.16	.924 23.47		331269†	
			.835 21.21	1.090 27.69	321448	.588 14.94	.843 21.42	320825	320824	
						.893 22.69	1.210 30.74		323900	8 M4
.911 23.14	1.166 29.62	324596	.835 21.21	1.090 27.69	324595	.588 14.94	.843 21.42		324594	
						.861 21.87	1.147 29.14	324935	324934	
			1.157 29.39	1.477 37.52	328493	.910 23.12	1.230 31.25		327935	
						.754 19.16	.991 25.18		327947†	
			1.187 30.15	1.379 35.03	324793	.955 24.26	1.124 28.55		327908	
			.983 24.97	1.251 31.78	321454	.736 18.7	.995 25.28		327906	
.911 23.14	1.166 29.62	329509†	.835 21.21	1.090 27.69	322231†	.588 14.94	.843 21.42	321558†	321557†	10
						.570 14.48	.762 19.36	33149	323907	
						.736 18.7	1.069 27.16	320823	320822	¼ M6
						.705 17.91	1.038 26.37	324976	342973	12 M12

Spade Tongue Terminals Wire Range 12-10 CMA 5,180-13,100 [2.625-6.638 mm²]

Y

Dimensioning:

- All dimensions in inches and millimetres. Values in brackets are metric equivalents.
- Charts contain dimensions in inches over millimetres.

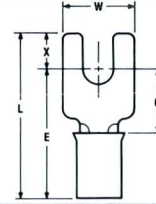

**Terminal Tongue Material Thickness .042 [1.07] Max.
Barrel I.D. .129 [3.27] Min.**

PIDG (PRE-INSULATED DIAMOND GRIP)

Stud Size	Tongue Dimensions				E Max.	L Max.	Vinyl			Nylon	
	C Min.	W	H	X			Maximum Insulation Diameter			Maximum Insulation Diameter	
							.230 [5.85]	.250 [6.35]	.300 [7.62]*	.230 [5.85]	
6 M3.5	.296 7.51	.296 7.52	.562 14.27								
	.296 7.51	.406 10.31	.203 5.16		.887 22.53	1.095 27.82			32587†	327716†	
	.218 5.53	.290 7.37	.140 3.56		.809 20.55	.954 24.24			322985		
8 M4	.296 7.51	.312 7.92	.203 5.16		.887 22.53	1.095 27.82			326858	326859	
	.468 11.88	.312 7.92	.250 6.35		1.059 26.9	1.314 33.38			325197		
	.625 15.87	.312 7.92	.312 7.92		1.216 30.89	1.533 38.94			330419		
10	.296 7.51	.406 10.31	.203 5.16		.887 22.53	1.095 27.82			32588†	35152†	35539†
	.296 7.51	.375 9.53	.203 5.16								
	.296 7.51	.406 10.31	.203 5.16		.887 22.53	1.095 27.82			32589†	321466†	326867†

Notes: †Indicates terminal is available in tape mounted form.
*Special Sleeve—Add .089 [2.27] to E Max. and L Max.

Flanged Spade Tongue Terminals Wire Range 12-10 CMA 5,180-13,100 [2.625-6.638 mm²]

Y

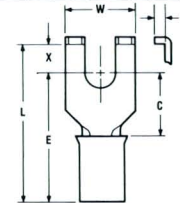

**Terminal Tongue Material Thickness .042 [1.07] Max.
Barrel I.D. .129 [3.27] Min.**

PIDG (PRE-INSULATED DIAMOND GRIP)

Stud Size	Tongue Dimensions				E Max.	L Max.	Vinyl			Nylon
	C Min.	W	H	X			Maximum Insulation Diameter			Maximum Insulation Diameter
							.230 [5.85]	.250 [6.35]	.300 [7.62]*	
6 M3.5	.250 6.35	.296 7.52	.062 1.57	.171 4.34	.841 21.37	1.017 25.84			324577†	325150†
	.250 6.35	.312 7.92	.062 1.57	.171 4.34	.841 21.37	1.017 25.84			324016†	
	.250 6.35	.328 8.33	.062 1.57	.171 4.34	.841 21.37	1.017 25.84			324587	325149
8 M4	.250 6.35	.416 10.57	.062 1.57	.171 4.34	.841 21.37	1.017 25.84			32510†	323849†
	.250 6.35	.416 10.57	.062 1.57	.171 4.34	.841 21.37	1.017 25.84			326865†	324015†

Notes: †Indicates terminal is available in tape mounted form.
*Special Sleeve—Add .089 [2.27] to E Max. and L Max.

Y Spade Tongue Terminals
Wire Range 12-10
CMA 5,180-13,100 [2.625-6.638 mm²]

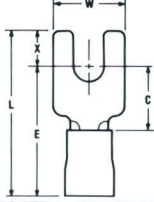
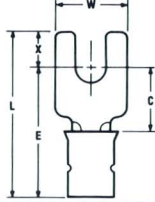
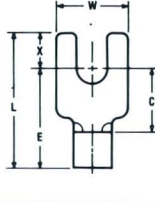
 PLASTI-GRIP					 DIAMOND GRIP					 SOLISTRAND & BUDGET				
E Max.	L Max.	Maximum Insulation Diameter			E Max.	L Max.	Maximum Insulation Diameter	E Max.	L Max.	Non Insulation Support		Stud Size		
		.200 [5.08]	.230 [5.85]	.250 [6.35]						SOLISTRAND	BUDGET			
.887 22.53	1.095 27.82				.811 20.6	1.019 25.89	.230 [5.85]	.564 14.33	1.131 28.73	322449	321862	6 M3.5		
		32973†	34174†				31829†	.564 14.33	.772 19.61	33478†	31587†			
							326860	.486 12.35	.631 16.03	322451	34384			
					.811 20.6	1.019 25.89		.564 14.33	.772 19.61		35493	8 M4		
								.736 18.7	.991 25.18	325196	325195			
								.893 22.69	1.210 30.74		330420			
.887 22.53	1.095 27.82				.811 20.6	1.019 25.89	.230 [5.85]	.564 14.33	.772 19.61	32995†	31588†	10		
		32974†	34175†	34857†			31830†	.564 14.33	.772 19.61	35495†	35494†			
							31831†	.564 14.33	.772 19.61	33479†	31589†			

Y Flanged Spade Tongue Terminals
Wire Range 12-10
CMA 5,180-13,100 [2.625-6.638 mm²]

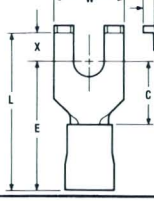
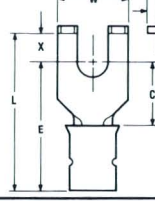
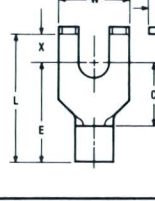
 PLASTI-GRIP					 DIAMOND GRIP					 SOLISTRAND & BUDGET				
E Max.	L Max.	Maximum Insulation Diameter		E Max.	L Max.	Maximum Insulation Diameter	E Max.	L Max.	Non Insulation Support		Stud Size			
		.230 [5.85]	.250 [6.35]						SOLISTRAND	BUDGET				
.841 21.37	1.017 25.84			.765 19.44	.941 23.91	.230 [5.85]	.518 13.16	.694 17.63	324578†	324579†	6 M3.5			
		324581†	1-324581-2†			324580†	.518 13.16	.694 17.63	324064†	324063†				
						324590	.518 13.16	.694 17.63		324589				
.841 21.37	1.017 25.84			.765 19.44	.941 23.91	.230 [5.85]	.518 13.16	.694 17.63	323143†	32416†	8 M4			
		324172†				32417†	.518 13.16	.694 17.63	323144†	322725†				
						322715†	.518 13.16	.694 17.63						

Y Hook Tongue Terminals Wire Range 12-10 CMA 5,180-13,100 [2.625-6.638 mm²]

Dimensioning:

1. All dimensions in inches and millimetres. Values in brackets are metric equivalents.
2. Charts contain dimensions in inches over millimetres.

Terminal Tongue Material Thickness .042 [1.07] Max.
Barrel I.D. .129 [3.27] Min.

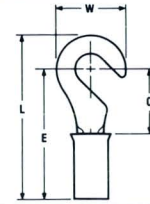

PIDG (PRE-INSULATED DIAMOND GRIP)

Stud Size	Tongue Dimensions				E Max.	L Max.	Vinyl	Nylon
	C Min.	W	H	X			Maximum Insulation Diameter	Maximum Insulation Diameter
8 M4	.302 7.67	.375 9.53						.230 [5.85]
10	.302 7.67	.375 9.53						
1/4 M6	.468 11.88	.531 13.49			1.059 26.9	1.327 33.71		321633†
5/16 M8	.468 11.88	.531 13.49			1.059 26.9	1.327 33.71		52374†
3/8	.531 13.48	.593 15.06						

Note: †Indicates terminal is available in tape mounted form.

Y Slotted Ring Tongue Terminals Wire Range 12-10 CMA 5,180-13,100 [2.625-6.638 mm²]

Terminal Tongue Material Thickness .042 [1.07] Max.
Barrel I.D. .129 [3.27] Min.

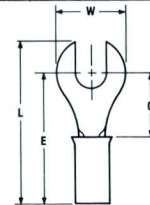

PIDG (PRE-INSULATED DIAMOND GRIP)

Stud Size	Tongue Dimensions				E Max.	L Max.	Vinyl	Nylon
	C Min.	W	H	X			Maximum Insulation Diameter	Maximum Insulation Diameter
6 M3.5	.281 7.14	.375 9.53			.911 23.14	1.087 27.61	.230 [5.85]	.300 [7.62]* 321569
8 M4	.281 7.13	.375 9.53			.872 22.15	1.041 26.45		321571
10	.281 7.13	.375 9.53			.872 22.15	1.035 26.29	322736	321610
1/4 M6	.468 11.88	.531 13.49			1.059 26.9	1.294 32.87	322218†	321611†
3/8	.531 13.48	.593 15.06						

Notes: †Indicates terminal is available in tape mounted form.
*Special Sleeve—Add .089 [2.27] to E Max. and L Max.

Y Hook Tongue Terminals
Wire Range 12-10
CMA 5,180-13,100 [2.625-6.638 mm²]

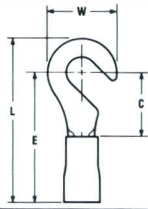

PLASTI-GRIP

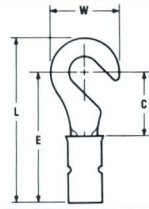

DIAMOND GRIP

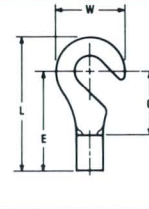

SOLISTRAND & BUDGET

E Max.	L Max.	Maximum Insulation Diameter	E Max.	L Max.	Maximum Insulation Diameter	E Max.	L Max.	Non Insulation Support		Stud Size
								SOLISTRAND	BUDGET	
		.250 [6.35]								
						.570 14.48	.760 19.31	321468†		8 M4
.893 22.69	1.083 27.51	324210†				.570 14.48	.760 19.31	324209†	327902†	10
						.736 18.7	1.004 25.51	321632†	327905†	1/4 M6
						.736 18.7	1.004 25.51	323670†	330798†	5/16 M8
						.799 20.3	1.091 27.72	51843	51844	3/8

Y Slotted Ring Tongue Terminals
Wire Range 12-10
CMA 5,180-13,100 [2.625-6.638 mm²]

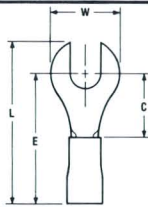

PLASTI-GRIP

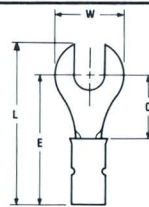

DIAMOND GRIP

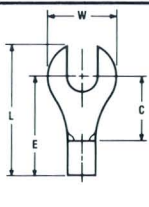

SOLISTRAND & BUDGET

E Max.	L Max.	Maximum Insulation Diameter	E Max.	L Max.	Maximum Insulation Diameter	E Max.	L Max.	Non Insulation Support		Stud Size
								SOLISTRAND	BUDGET	
		.230 [5.85]			.230 [5.85]					
						.549 13.95	.725 18.42	322448	321568	6 M3.5
.872 22.15	1.041 26.45	324791	.796 20.22	.966 24.54	324790	.549 13.95	.719 18.27	322453	321570	8 M4
						.549 13.95	.712 18.09	322456	321609	10
						.736 18.7	.970 24.64	35680†	33186†	1/4 M6
						.799 20.3	1.027 26.09	320222		3/8

Y Long Spring Spade Tongue Terminals
Wire Range 12-10
CMA 5,180-13,100 [2.625-6.638 mm²]

Dimensioning:

1. All dimensions in inches and millimetres. Values in brackets are metric equivalents.
2. Charts contain dimensions in inches over millimetres.

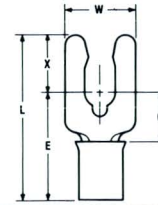

Terminal Tongue Material Thickness .042 [1.07] Max.
Barrel I.D. .129 [3.27] Min.

PIDG (PRE-INSULATED DIAMOND GRIP)

Stud Size	Tongue Dimensions				E Max.	L Max.	Vinyl		Nylon
	C Min.	W	H	X			Maximum Insulation Diameter		Maximum Insulation Diameter
							.230 [5.85]	.250 [6.35]	
6 M3.5	.242 6.15	.312 7.92		.283 7.19	.843 21.42	1.131 28.73	52430†	52430-1†	
8 M4	.273 6.93	.375 9.53		.295 7.49	.874 22.2	1.174 29.82	52431†	52431-1†	
10	.305 7.48	.375 9.53		.308 7.82	.906 23.02	1.219 30.97	52432†	52432-1†	
1/4 M6	.345 8.76	.437 11.10		.338 8.59	9.46 24.03	1.289 32.75	52433†	52433-1†	

Note: †Indicates terminal is available in tape mounted form.

Y Short Spring Spade Tongue Terminals
Wire Range 12-10
CMA 5,180-13,100 [2.625-6.638 mm²]

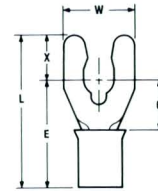

Terminal Tongue Material Thickness .042 [1.07] Max.
Barrel I.D. .129 [3.27] Min.

PIDG (PRE-INSULATED DIAMOND GRIP)

Stud Size	Tongue Dimensions				E Max.	L Max.	Vinyl		Nylon
	C Min.	W	H	X			Maximum Insulation Diameter		Maximum Insulation Diameter
							.250 [6.35]		
5 M3	.169 4.29	.250 6.35		.184 4.67	.770 19.56	.959 24.36	52940†		
6 M3.5	.174 4.42	.250 6.35		.179 4.55	.775 19.69	.959 24.36	52041†		
8 M4	.276 7.01	.375 9.53		.170 4.32	.877 22.28	1.052 26.73	52942†		
	.276 7.01	.312 7.92		.170 4.32					
10	.276 7.01	.406 10.31		.218 5.54	.877 22.28	1.100 27.95	52943†		
	.276 7.01	.312 7.92		.218 5.54					
12	.276 7.01	.531 13.49		.250 6.35	.877 22.28	1.132 28.76	52944†		
1/4 M6	.338 8.58	.625 15.88		.281 7.14	.939 23.86	1.225 31.12	52945†		
	.338 8.58	.375 9.53		.281 7.14					

Note: †Indicates terminal is available in tape mounted form.

Y Long Spring Spade Tongue Terminals
Wire Range 12-10
CMA 5,180-13,100 [2.625-6.638 mm²]

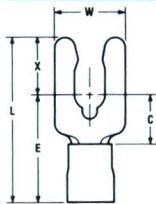

PLASTI-GRIP

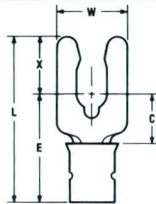

DIAMOND GRIP

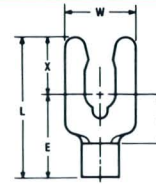

SOLISTRAND & BUDGET

E Max.	L Max.	Maximum Insulation Diameter			E Max.	L Max.	Maximum Insulation Diameter		E Max.	L Max.	Non Insulation Support		Stud Size
		.200 [5.08]	.300 [7.62]					SOLISTRAND			BUDGET		
.843 21.42	1.131 28.73	52473†							.520 13.21	.808 20.53	52715-1†	52706-1†	6 M3.5
.874 22.2	1.174 29.82	52474†							.551 14.	.851 21.62	52716-1†	52707-1†	8 M4
.906 23.02	1.219 30.97	52475†	52475-2†						.583 14.81	.896 22.76	52717-1†	52708-1†	10
.946 24.03	1.289 32.75	52476†							.623 15.83	.966 24.54	52772-1†		1/4 M6

Y Short Spring Spade Tongue Terminals
Wire Range 12-10
CMA 5,180-13,100 [2.625-6.638 mm²]

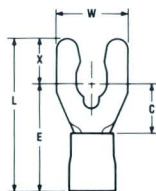

PLASTI-GRIP

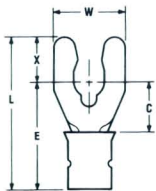

DIAMOND GRIP

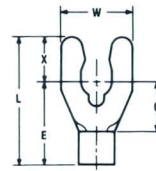

SOLISTRAND & BUDGET

E Max.	L Max.	Maximum Insulation Diameter			E Max.	L Max.	Maximum Insulation Diameter		E Max.	L Max.	Non Insulation Support		Stud Size
		.200 [5.08]	.250 [6.35]	.300 [7.62]							SOLISTRAND	BUDGET	
.770 19.56	.959 24.36	52960†							.447 11.36	.636 16.16	53013-1†		5 M3
.775 19.69	.959 24.36	52961†	53246-1†	52961-2†					.491 12.48	.636 16.16	53126-1†	53014-1†	6 M3.5
.877 22.28	1.052 26.73	52962†		52962-2†					.554 14.08	.729 18.52	53127-1†	53015-1†	8 M4
.877 22.28	1.052 26.73	53247-1†							.554 14.08	.729 18.52	53835-1†	53273-2†	
.877 22.28	1.100 27.95	52963†	52963-2†	52963-4†					.554 14.08	.777 19.74	53128-1†	53016-1†	10
.877 22.28	1.100 27.95	53248-1†							.554 14.08	.729 18.52	53836-1†	53274-2†	
.877 22.28	1.132 28.76	52964†							.554 14.08	.809 20.55	53178-1†	53132-2†	12
.939 23.86	1.225 31.12	52965†	52965-1†						.616 15.65	.902 22.92	53138-1†	53017-1†	1/4 M6
.939 23.86	1.225 31.12	53225-1							.616 15.65	.902 22.92	53837-1	53226-2	

R Ring Tongue Terminals Wire Range 8 CMA 13,100-20,800 [6.638-10.54 mm²]

Dimensioning:

1. All dimensions in inches and millimetres. Values in brackets are metric equivalents.
2. Chart contains dimensions in inches over millimetres.

**Terminal Tongue Material Thickness .043 [1.10] Max.
.051 [1.3] Max. SOLISTRAND only**

**Barrel I.D. .172 [4.36] Min.
.180 [4.57] Min. SOLISTRAND only**

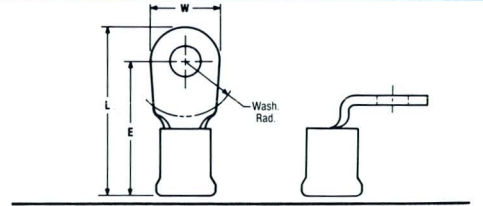

AMPLI-BOND

Stud Size	Style	Tongue Dimensions			E Max.	L Max.	Maximum Insulation Dia.			
		Max. Wash. Rad.	C Min.	W			.298 [7.57]	.377 [9.58]	C Min.	90° Bent Tongue .298 [7.57]
8 M4	I	.437 11.1		.375 9.53	1.344 34.14	1.586 40.29	322047	2-322047-1		
		.437 11.1		.478 12.14	1.344 34.14	1.586 40.29	330600			
			.359 9.11	.406 10.31						
			.359 9.11	.469 11.91						
10	I	.218 5.54		.406 10.31	1.125 28.58	1.328 33.74	323197			
		.437 11.1		.375 9.53	1.343 34.12	1.578 40.09	323974			
		.437 11.1		.478 12.14	1.344 34.14	1.586 40.29	322048			
		.500 12.7		.587 14.91	1.406 35.71	1.702 43.24	322002			
		.437 11.1		.431 10.95	1.344 34.14	1.562 39.68	322128	322154	.318 8.07	322880
		.250 6.35		.500 12.7						
			.359 9.11	.469 11.91						
			.531 13.48	.594 15.09						
¼ M6	I	.437 11.1		.478 12.14	1.344 34.14	1.586 40.29	322049	327268		
		.500 12.7		.587 14.91	1.406 35.72	1.702 43.24	321669		.381 9.67	323869
		.437 11.1		.431 10.95						
			.359 9.11	.469 11.91						
5/16 M8	I		.531 13.48	.594 15.09						
		.500 12.7		.587 14.91	1.406 35.72	1.702 43.24	322003	328525	.380 9.65	322883
			1.000 25.4	1.250 31.75						
		.406 10.31		.562 14.27						
¾	I	.500 12.7		.587 14.91	1.406 35.72	1.702 43.24	322004	2-322004-2	.474 12.03	322884
			.531 13.48	.594 15.09						
			1.000 25.4	1.250 31.75						
½ M12	I	.500 12.7		.875 22.23	1.406 35.72	1.846 46.89	328463	2-328463-1		
			1.000 25.4	1.250 31.75						

R Ring Tongue Terminals
 Wire Range 8
 CMA 13,100-20,800 [6.638-10.54 mm²]

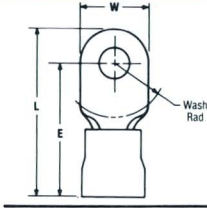

PLASTI-GRIP

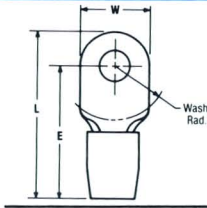

TERMINYL

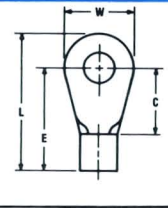

SOLISTRAND

E Max.	L Max.	Maximum Insulation Dia.		E Max.	L Max.	Maximum Insulation Dia.	E Max.	L Max.	Non-Insulation Support	Stud Size
		.280 [7.11]	.360 [9.14]							
1.344 34.14	1.586 40.29	52041-2	52041	1.183 30.05	1.425 36.2	53041				8 M4
							.743 18.88	.949 24.11	324061	
							.696 17.68	.933 23.70	32996	
1.344 34.14	1.562 39.68	52263-1	52263	1.183 30.05	1.402 35.62	324043				10
				1.250 31.75	1.500 38.1	330747				
							.696 17.68	.933 23.70	33460	
							.868 22.05	1.168 29.67	321164	
1.344 34.14	1.586 40.29	52041-3	52041-1	1.183 30.05	1.425 36.2	324082				1/4 M6
				1.183 30.05	1.402 35.62	324177				
							.696 17.68	.938 23.83	33461	
							.868 22.05	1.168 29.67	35247	
1.406 35.71	1.702 43.24	52291-2	52291	1.246 31.65	1.542 39.17	324044				5/16 M8
							.868 22.05	1.168 29.67	33462	
							1.337 33.96	1.965 49.92	36498	
							.790 20.07	1.074 27.28	31808	
1.406 35.72	1.702 43.24	52291-3	52291-1	1.246 31.65	1.542 39.17	324045				3/8
							.868 22.05	1.168 29.67	33463	
							1.337 33.96	1.965 42.92	36499	
1.406 35.72	1.846 46.89	52262-1	52262							1/2 M12
							1.337 33.96	1.965 49.92	35664	

R Ring Tongue Terminals (Cont'd.) Wire Range 8 CMA 13,100-20,800 [6.638-10.54 mm²]

Dimensioning:

- All dimensions in inches and millimetres. Values in brackets are metric equivalents.
- Charts contain dimensions in inches over millimetres.

Terminal Tongue Material Thickness .043 [1.10] Max.
.051 [1.3] Max. SOLISTRAND only
Barrel I.D. .172 [4.36] Min.
.180 [4.57] Min. SOLISTRAND only

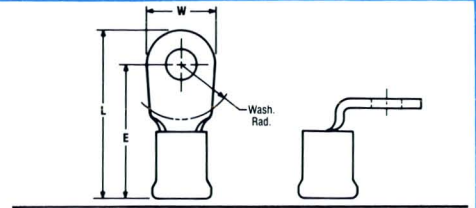

AMPLI-BOND

Stud Size	Style	Tongue Dimensions			E Max.	L Max.	Maximum Insulation Dia.	
		Max. Wash. Rad.	C Min.	W				
5/16 M16	I		1.000 25.4	1.250 31.75				
3/4	I		1.000 25.4	1.250 31.75				

R Ring Tongue Terminals (Cont'd.) Wire Range 8 CMA 13,100-20,800 [6.638-10.54 mm²]

Terminal Tongue Material Thickness .043 [1.10] Max.
Barrel I.D. .172 [4.36] Min.

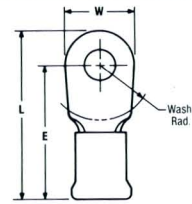

AMPLI-BOND

Stud Size	Style	Tongue Dimensions			E Max.	L Max.	Maximum Insulation Dia.	
		Max. Wash. Rad.	C Min.	W				
6 M3.5	II	.437 11.1		.478 12.14				
8 M4	II	.437 11.1		.478 12.14				
10	II	.437 11.1		.478 12.14				
1/4 M6	II	.437 11.1		.478 12.14				
5/16 M8	II	.437 11.1		.478 12.14				

Note: †Indicates terminal is available in Tape Mounted Form.

R Ring Tongue Terminals (Cont'd.)
Wire Range 8
CMA 13,100-20,800 [6.638-10.54 mm²]

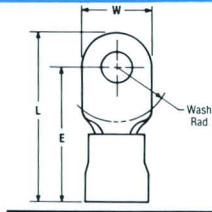

PLASTI-GRIP

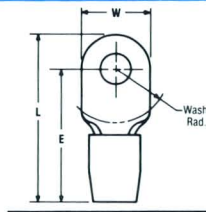

TERMINYL

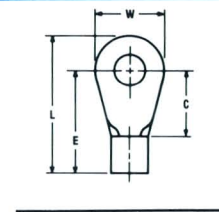

SOLISTRAND

E Max.	L Max.	Maximum Insulation Dia.	E Max.	L Max.	Maximum Insulation Dia.	E Max.	L Max.	Non-Insulation Support	Stud Size
						1.337	1.965	35665	5/8
						33.96	49.92		M16
						1.337	1.965	35666	3/4
						33.96	49.92		

R Ring Tongue Terminals (Cont'd.)
Wire Range 8
CMA 13,100-20,800 [6.638-10.54 mm²]

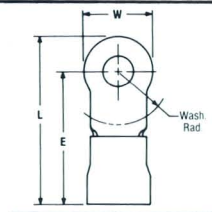

PLASTI-GRIP

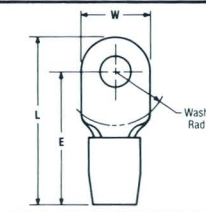

TERMINYL

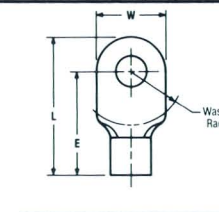

SOLISTRAND

E Max.	L Max.	Maximum Insulation Dia.	E Max.	L Max.	Maximum Insulation Dia.	E Max.	L Max.	Stud Size
		.325 [8.26]						
1.358	1.600							6
34.5	40.64	53179-1†						M3.5
1.358	1.600							8
34.5	40.64	53179-2†						M4
1.358	1.600							10
34.5	40.64	53179-3†						
1.358	1.600							1/4
34.5	40.64	53179-4†						M6
1.358	1.600							5/16
34.5	40.64	53179-5†						M8

Ring Tongue Terminals (Cont'd.)
BL Wire Range 6
CMA 20,800-33,100 [10.54-16.773 mm²]

Dimensioning:

1. All dimensions in inches and millimetres. Values in brackets are metric equivalents.
2. Chart contains dimensions in inches over millimetres.

Terminal Tongue Material Thickness .048 [1.22] Max.
.060 [1.53] Max. SOLISTRAND only

Barrel I.D. .224 [5.68] Min.
.232 [5.89] Min. SOLISTRAND only

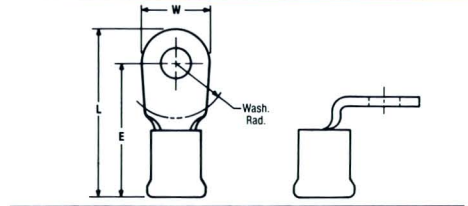

AMPLI-BOND

Stud Size	Tongue Dimensions				E Max.	L Max.	Maximum Insulation Dia.		
	Max. Wash. Rad.	C Min.	W				.377 [9.58]	.436 [11.08]	90° Bent Tongue .377 [9.58]
6 M3.5	.515 13.09		.625 15.88		1.599 40.62	1.914 48.62	2-321670-2		
	.515 13.09		.500 12.7						
8 M4	.421 10.7		.468 11.89		1.490 37.85	1.727 43.87	322153		
	.515 13.09		.500 12.7		1.599 40.62	1.852 47.05	322050	329161	322887
10	.515 13.09		.625 15.88		1.599 40.62	1.914 48.62	322005		
	.515 13.09		.398 10.11						
		.531 13.48	.406 10.31						
		.531 13.48	.625 15.88						
		.531 13.48	.468 11.89						
		.584 14.83	.406 10.31						
¼ M6	.515 13.09		.500 12.7		1.599 40.62	1.852 47.05	322051	322155	322888
	.515 13.09		.625 15.88		1.599 40.62	1.914 48.62	321670		
		.531 13.48	.625 15.88						
		.531 13.48	.468 11.89						
5/16 M8	.515 13.09		.625 15.88		1.599 40.62	1.914 48.62	322006	2-322006-2	322891
		.531 13.48	.625 15.88						
		1.000 25.4	1.250 31.75						
¾	.515 13.09		.625 15.88		1.599 40.62	1.914 48.62	322007	327892	322892
		.531 13.48	.625 15.88						
		1.000 25.4	1.250 31.75						
7/16	.515 13.09		.625 15.88		1.599 40.62	1.914 48.62	322008	2-322008-1	
		.531 13.48	.625 15.88						
½ M12	.515 13.09		.815 20.7						
		1.000 25.4	.875 22.23						
		1.000 25.4	1.250 31.75						
5/8		1.000 25.4	1.250 31.75						
		1.000 25.4	1.250 31.75						
¾		1.000 25.4	1.250 31.75						
		1.000 25.4	1.250 31.75						

Note: †Indicates terminal is available in Tape Mounted Form.

BL Ring Tongue Terminals (Cont'd.)
Wire Range 6
CMA 20,800-33,100 [10.54-16.773 mm²]

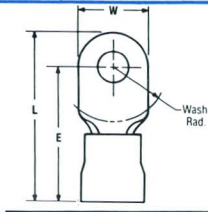

PLASTI-GRIP

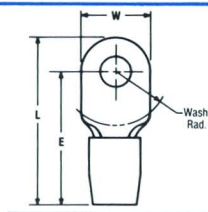

TERMINYL

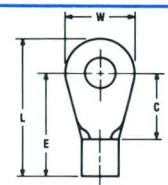

SOLISTRAND

E Max.	L Max.	Maximum Insulation Dia.		E Max.	L Max.	Maximum Insulation Dia.	E Max.	L Max.	Non- Insulation Support	90° Bent Tongue	Stud Size
		.340 [8.64]	.436 [11.08]								
1.591 40.42	1.844 46.84	52042-2†	52042†								6 M3.5
1.482 37.64	1.719 43.66	52265-1	52265	1.388 35.26	1.585 40.26	324046					8 M4
1.591 40.42	1.844 46.84	52042-5†	52042-4†								
				1.447 36.76	1.700 43.18	53119-1					
							.931 23.65	1.181 30.	52197		10
							.931 23.65	1.246 31.64	33464	36405	
							.931 23.65	1.168 29.67	321298		
							.984 25.	1.181 30.	53106		
1.591 40.42	1.844 46.84	52042-3†	52042-1†	1.447 36.76	1.700 43.18	324047					
							.931 23.65	1.246 31.25	33465	35678	1/4 M6
							.931 23.65	1.168 29.67	321598		
1.591 40.42	1.906 48.42	52264-2†	52264	1.447 36.76	1.762 44.76	324048					
							.931 23.65	1.246 31.64	33466		5/16 M8
							1.400 35.56	2.033 51.64	36806		
1.591 40.42	1.906 48.42	52264-3	52264-1	1.447 36.76	1.762 44.76	324049					
							.931 23.65	1.246 31.64	33467	35681	3/8
							1.400 35.56	2.033 51.64	36807		
				1.447 36.76	1.762 44.76	328654					
							.931 23.65	1.246 31.64	320745		7/16
1.441 36.61	1.851 47.02	52350-1	52350								
							1.400 35.56	1.840 46.74	320344		1/2 M12
							1.400 35.56	2.033 51.64	36808		
							1.400 35.56	2.033 51.64	36809		5/8
							1.400 35.56	2.033 51.64	36810		3/4

Y Ring Tongue Terminals (Cont'd.) Wire Range 4 CMA 33,100-52,600 [16.773-26.654 mm²]

Dimensioning:

1. All dimensions in inches and millimetres. Values in brackets are metric equivalents.
2. Chart contains dimensions in inches over millimetres.

**Terminal Tongue Material Thickness .051 [1.3] Max.
.073 [1.86] Max. SOLISTRAND only**

**Barrel I.D. .280 [7.11] Min.
.296 [7.51] Min. SOLISTRAND only**

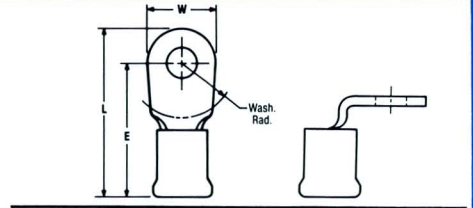

AMPLI-BOND

Stud Size	Tongue Dimensions				E Max.	L Max.	Maximum Insulation Dia.		
	Max. Wash. Rad.	C Min.	W				4.36 [11.08]	.505 [12.83]	90° Bent Tongue .436 [11.08]
8 M4	.265 6.74		.437 11.1						
	.531 13.49		.546 13.86		1.632 41.46	1.908 48.47	322052		
10	.531 13.49		.679 17.25		1.632 41.46	1.974 50.14	322009		
	.265 6.74		.437 11.1						
		.516 13.1	.656 16.66						
		.437 11.09	.500 12.7						
¼ M6	.531 13.49		.546 13.86		1.632 41.46	1.908 48.47	322053	322156	
	.531 13.49		.679 17.25		1.632 41.46	1.974 50.14	321671	322156	
		.516 13.1	.656 16.66						
		.437 11.09	.500 12.7						
5/16 M8	.531 13.49		.679 17.24		1.632 41.46	1.974 50.14	322010	2-322010-3	
		.516 13.1	.656 16.66						
		1.000 25.4	1.250 31.75						
		.500 12.7	.625 15.88						
¾	.531 13.49		.679 17.25		1.632 41.46	1.974 50.14	322011	322171	
		.516 13.1	.656 16.66						
		1.000 25.4	1.250 31.75						
		1.000 25.4	.875 22.23						
		.500 12.7	.625 15.88						
7/16		.516 13.1	.656 16.66						
½ M12	.531 13.49		.679 17.25		1.632 41.46	1.974 50.14	328221		
		1.000 25.4	1.250 31.75						
		1.000 25.4	.875 22.23						
⅝ M16		1.000 25.4	1.250 31.75						
		1.000 25.4	1.250 31.75						

Y Ring Tongue Terminals (Cont'd.)
Wire Range 4
CMA 33,100-52,600 [16.773-26.654 mm²]

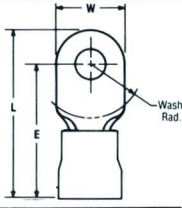

PLASTI-GRIP

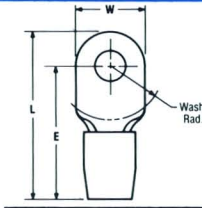

TERMINYL

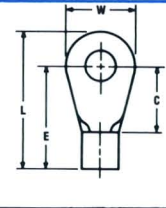

SOLISTRAND

E Max.	L Max.	Maximum Insulation Dia.		E Max.	L Max.	Maximum Insulation Dia.		E Max.	L Max.	Non Insulation Support	Stud Size
		.450 [11.43]	.515 [13.09]			.382 [9.71]	90° Bent Tongue .382 [9.71]				
				1.155 29.34	1.376 34.96						8 M4
1.672 42.47	1.948 49.48	52043-2	52043	1.536 39.02	1.812 46.03						
				1.155 29.34	1.376 34.96	1-331456-0					10
								.978 24.85	1.314 33.38	33468	
								.946 24.03	1.199 30.46	33114	
1.672 42.47	1.948 49.48	52043-3	52043-1	1.536 39.02	1.812 46.03	324050	50403				
								.978 24.85	1.314 33.38	33469	¼ M6
								.946 24.03	1.199 30.46	31811	
1.672 42.47	2.014 51.16	52266-3	52266	1.536 39.02	1.878 47.71	324051					
								.978 24.85	1.314 33.38	33470	5/16 M8
								1.462 37.14	2.090 53.09	36814	
								1.009 25.63	1.324 33.63	33115	
1.672 42.47	2.014 51.16	52266-4	52266-1	1.536 39.02	1.878 47.71	324052	324102				
								.978 24.85	1.314 33.38	33471	
								1.462 37.14	2.090 53.09	36815	¾
								1.462 37.14	1.902 48.32	322704	
								1.009 25.63	1.324 33.63	31812	
								.978 24.85	1.314 33.38	320743	7/16
1.672 42.47	2.014 51.16	52266-5	52266-2	1.536 39.02	1.878 47.71	324114					
								1.462 37.14	2.090 53.09	35668	½ M12
								1.462 37.14	1.902 48.32	327175	
								1.462 37.14	2.090 53.09	35669	5/8 M16
								1.462 37.14	2.090 53.09	35670	¾

R Ring Tongue Terminals (Cont'd.) Wire Range 2 CMA 52,600-83,700 [26.654-42.414 mm²]

Dimensioning:

1. All dimensions in inches and millimetres. Values in brackets are metric equivalents.
2. Chart contains dimensions in inches over millimetres.

**Terminal Tongue Material Thickness .060 [1.53] Max.
.073 [1.86] Max. SOLISTRAND only**

**Barrel I.D. .357 [9.06] Min.
.370 [9.39] Min. SOLISTRAND only**

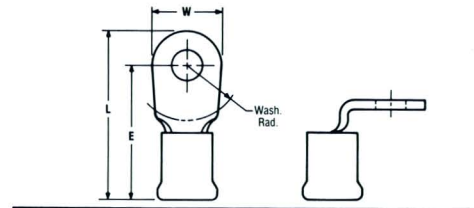

AMPLI-BOND

Stud Size	Tongue Dimensions				Maximum Insulation Dia.			
	Max. Wash. Rad.	C Min.	W	E Max.	L Max.	.505 [12.83]	.632 [16.06]	90° Bent Tongue .505 [12.83]
8 M4	.578 14.69		.855 21.72	1.710 43.44	2.140 54.36	2-321672-1		
10	.578 14.69		.711 18.06	1.710 43.44	2.068 52.53	322122	1-322122-0	
	.531 13.49		.625 15.88					
¼ M6	.578 14.69		.711 18.06	1.710 43.44	2.068 52.53	322054		
	.578 14.69		.855 21.72	1.710 43.44	2.140 54.36	321672		
	.578 14.69		.675 17.15	1.710 43.44	2.050 52.07	322125	322157	322900
	.625 15.88		.610 15.49	1.710 43.44	2.050 52.07	52102		52097
	.531 13.49		.625 15.88					
	.531 13.49		.890 22.61					
5/16 M8	.578 14.69		.711 18.06	1.710 43.44	2.068 52.53	322074	326896	322134
	.578 14.69		.855 21.72	1.710 43.44	2.140 54.36	322013		
	.531 13.49		.625 15.88					
¾	.578 14.69		.711 18.06	1.710 43.44	2.068 52.53	322055	324190	322902
	.578 14.69		.855 21.72	1.710 43.44	2.140 54.36	322014	322172	
	.531 13.49		.625 15.88					
	.531 13.49		.890 22.61					
7/16	.578 14.69		.855 21.72	1.710 43.44	2.140 54.36	322015	2-322015-1	
	.531 13.49		.890 22.61					
½ M12	.578 14.69		.855 21.72	1.710 43.44	2.140 54.36	322016	326897	322904
	.531 13.49		.812 20.62					
	.531 13.49		.890 22.61					
	1.125 28.58		1.250 31.75					
⅝ M16	1.125 28.58		1.250 31.75					
¾	1.125 28.58		1.250 31.75					
7/8 M22	1.125 28.58		1.250 31.75					
9/16	1.125 28.58		1.250 31.75					

R Ring Tongue Terminals (Cont'd.)
Wire Range 2
CMA 52,600-83,700 [26.654-42.414 mm²]

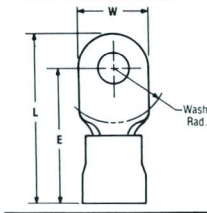

PLASTI-GRIP

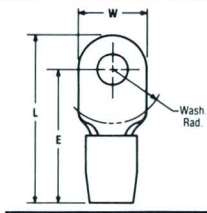

TERMINYL

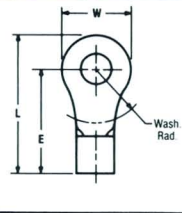

SOLISTRAND

E Max.	L Max.	Maximum Insulation Dia.		E Max.	L Max.	Maximum Insulation Dia.		E Max.	L Max.	Non Insulation Support	90° Bent Tongue	Stud Size
		.560 [14.23]	.632 [16.06]			.473 [11.99]	60° Bent Tongue .473 [11.99]					
1.731 43.97	2.089 53.07	52044-3	52044	1.705 43.31	2.063 52.4	328655		1.212 30.79	1.527 38.79	330301		8 M4
												10
1.731 43.97	2.071 52.61	52267-1	52267	1.705 43.31	2.045 51.95	324053		1.212 30.79	1.527 38.79	320383		1/4 M6
								1.212 30.79	1.657 42.09	320138	324034	
1.731 43.97	2.089 53.07	52044-4	52044-1	1.705 43.31	2.063 52.4	324112						5/16 M8
								1.212 30.79	1.527 38.79	322870		
1.731 43.97	2.089 53.07	52044-5	52044-2	1.705 43.31	2.063 52.4	324054	324103					3/8
								1.212 30.79	1.527 38.79	321600		
								1.212 30.79	1.657 42.09	35184	35249	
								1.212 30.79	1.657 42.09	320741		7/16
1.706 43.34	2.136 54.26	52268-1	52268	1.705 43.31	2.135 54.23	324055		1.212 30.79	1.621 41.18	321602		1/2 M12
								1.212 30.79	1.657 42.09	35185		
								1.888 47.96	2.516 64	323291		
								1.888 47.96	2.516 64	320754		5/8 M16
								1.888 47.96	2.516 64	320755		3/4
								1.888 47.96	2.516 64	320756		7/8 M22
								1.888 47.96	2.516 64	320732		9/16

BL Ring Tongue Terminals (Cont'd.)
Wire Range 1/0
CMA 83,700-119,500 [42.414-60.555 mm²]

- Dimensioning:**
1. All dimensions in inches and millimetres.
Values in brackets are metric equivalents.
2. Charts contain dimensions in inches over millimetres.

Terminal Tongue Material Thickness .083 [2.11] Max.
Barrel I.D. .504 [12.80] Min.

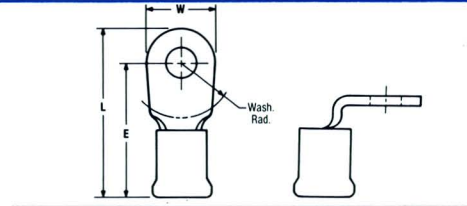

AMPLI-BOND

Size Stud	Tongue Dimensions			E Max.	L Max.	Maximum Insulation Dia.		
	Max. Wash. Rad.	C Min.	W			.632 [16.06]	.684 [17.38]	90° Bent Tongue .632 [16.06]
1/4 M6	.625		.875	2.063	2.501	321673		
	15.88		22.23	52.41	63.53			
	.625		.807	2.063	2.469	322085	322158	322907
	15.88		20.5	52.41	62.72			
5/16 M8	.625		.807	2.063	2.469	322086	328526	
	15.88		20.5	52.41	62.72			
	.625		.875	2.063	2.501	321674		
	15.88		22.23	52.41	63.53			
	.625		.875	2.063	2.501	321675		
	15.88		22.23	52.41	63.53			
3/8	.625		.807	2.063	2.469	322087	322173	322908
	15.88		20.5	52.41	62.72			
	.471		.807					
	11.96		20.5					
	1.125		1.250					
	28.58		31.75					
7/16	.625		.875	2.063	2.501	321676		
	15.88		22.23	52.41	63.53			
1/2 M12	.625		.875	2.063	2.501	321677	324192	322910
	15.88		22.23	52.41	63.53			
	1.125		1.250					
	28.58		31.75					
5/8 M16	1.125		1.250	2.584	3.222	322174		
	28.58		31.75	65.64	81.84			
3/4	1.125		1.250					
	28.58		31.75					
7/8 M22	1.125		1.250					
	28.58		31.75					

Y Ring Tongue Terminals (Cont'd.)
Wire Range 2/0
CMA 119,500-150,500 [60.555-76.264 mm²]

Terminal Tongue Material Thickness .083 [2.11] Max.
Barrel I.D. .504 [12.80] Min.

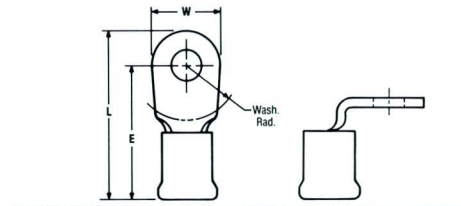

AMPLI-BOND

Stud Size	Tongue Dimensions			E Max.	L Max.	Maximum Insulation Dia.	
	Max. Wash. Rad.	C Min.	W			.684 [17.38]	
1/4 M6	.625		.926	2.084	2.540	322088	
	15.88		23.52	52.94	64.52		

BL Ring Tongue Terminals (Cont'd.)
Wire Range 1/0
CMA 83,700-119,500 [42.414-60.555 mm²]

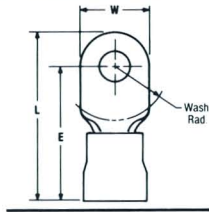

PLASTI-GRIP

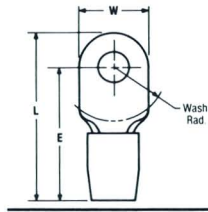

TERMINYL

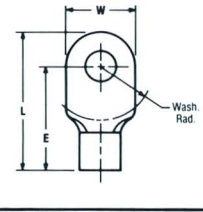

SOLISTRAND

E Max.	L Max.	Maximum Insulation Dia.		E Max.	L Max.	Maximum Insulation Dia.		E Max.	L Max.	Non-Insulation Support	Stud Size
		.665 [16.90]	.684 [17.38]			.580 [14.74]	60° Bent Tongue .580 [14.74]				
								1.529 38.84	1.956 49.69	36915	
2.041 51.85	2.447 62.16	52045-3	52045	2.033 51.64	2.426 61.63	324056		1.532 38.92	1.925 48.9	321866	1/4 M6
2.041 51.85	2.447 62.16	52045-4	52045-1	2.033 51.64	2.426 61.63	324113		1.532 38.92	1.925 48.9	321867	5/16 M8
								1.529 38.84	1.956 49.69	36916	
								1.529 38.84	1.956 49.69	36917	
2.041 51.85	2.447 62.16	52045-5	52045-2	2.033 51.64	2.426 61.63	324057		1.532 38.92	1.925 48.9	321868	
						324104					3/8
								2.063 52.41	2.678 68.03	322829	
								1.529 38.84	1.956 49.69	36918	7/16
2.041 51.85	2.478 62.95		52289	2.017 51.24	2.454 62.34	324058		1.529 38.84	1.956 49.69	36919	1/2 M12
								2.063 52.41	2.678 68.03	322291	
								2.063 52.41	2.678 68.03	320744	5/8 M16
								2.063 52.41	2.678 68.03	320748	3/4
								2.063 52.41	2.678 68.03	320736	7/8 M22

Y Ring Tongue Terminals (Cont'd.)
Wire Range 2/0
CMA 119,500-150,500 [60.555-76.264 mm²]

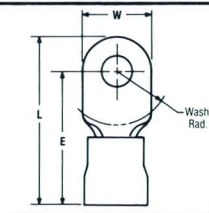

PLASTI-GRIP

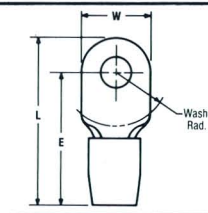

TERMINYL

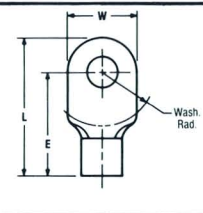

SOLISTRAND

E Max.	L Max.	Maximum Insulation Dia.		E Max.	L Max.	Maximum Insulation Dia.		E Max.	L Max.	Non-Insulation Support	Stud Size
		.775 [19.69]				.610 [15.50]					
2.082 52.89	2.477 62.92	52046		2.026 51.47	2.416 61.37	328656		1.550 39.37	1.930 49.03	321869	1/4 M6

Y Ring Tongue Terminals (Cont'd.)
Wire Range 2/0
CMA 119,500-150,500 [60.555-76.264 mm²]

Dimensioning:

- 1. All dimensions in inches and millimetres. Values in brackets are metric equivalents.
- 2. Charts contain dimensions in inches over millimetres.

Terminal Tongue Material Thickness .083 [2.11] Max.
Barrel I.D. .504 [12.80] Min.

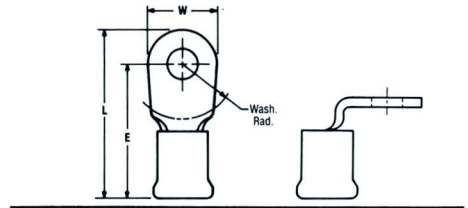

AMPLI-BOND

Stud Size	Tongue Dimensions			E Max.	L Max.	Maximum Insulation Dia.		
	Max. Wash. Rad.	C Min.	W			.684 [17.38]	.737 [18.72]	90° Bent Tongue .684 [17.38]
1/4 M6	.625 15.88		.931 23.65					
5/16 M8	.625 15.88		.926 23.52	2.084 52.94	2.540 64.52	322089	322159	322914
	.625 15.88		.931 23.65	2.084 52.94	2.550 64.77	322056		
3/8	.625 15.88		.926 23.52	2.084 52.94	2.540 64.52	322090		322915
	.625 15.88		.931 23.65	2.084 52.94	2.550 64.77	322057	324193	
7/16	.625 15.88		.926 23.52	2.084 52.94	2.540 64.52	322091		
	.625 15.88		.931 23.65					
1/2 M12	.625 15.88		.926 23.52	2.084 52.94	2.540 64.52	322092		322916
	.625 15.88		.931 23.65	2.084 52.94	2.550 64.77	322058	324194	
5/8 M16	1.125 28.58		1.250 31.75	2.592 65.84	3.220 81.79	324100		
	.625 15.88		.931 23.65					
3/4	1.125 28.58		1.250 31.75					
	1.125 28.58		1.250 31.75					
7/8 M22	1.125 28.58		1.250 31.75					

R Ring Tongue Terminals (Cont'd.)
Wire Range 3/0
CMA 150,500-190,000 [76.264-96.3 mm²]

Terminal Tongue Material Thickness .094 [2.39] Max.
Barrel I.D. .565 [14.36] Min.

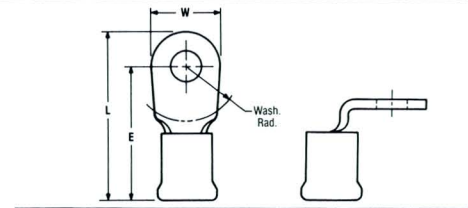

AMPLI-BOND

Stud Size	Tongue Dimensions			E Max.	L Max.	Maximum Insulation Dia.		
	Max. Wash. Rad.	C Min.	W					
1/4 M6	.265 6.74		1.020 25.91					

Y Ring Tongue Terminals (Cont'd.)
Wire Range 2/0
CMA 119,500-150,500 [60.555-76.264 mm²]

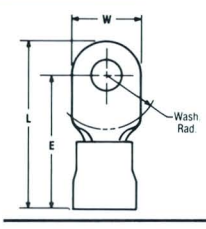

PLASTI-GRIP

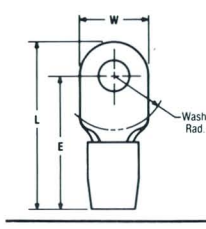

TERMINYL

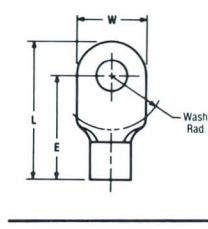

SOLISTRAND

PLASTI-GRIP			TERMINYL			SOLISTRAND			Stud Size
E Max.	L Max.	Maximum Insulation Dia.	E Max.	L Max.	Maximum Insulation Dia.	E Max.	L Max.	Non-Insulation Support	
		.775 [19.69]			.610 [15.50]				
						1.545 39.25	2.000 50.8	36921	1/4 M6
2.082 52.89	2.477 62.92	52046-1	2.026 51.47	2.416 61.37	324083	1.550 39.37	1.930 49.03	321870	5/16 M8
						1.545 39.25	2.000 50.8	36922	
2.082 52.89	2.477 62.92	52046-2	2.026 51.47	2.416 61.37	324084	1.550 39.37	1.930 49.03	321871	3/8
						1.545 39.25	2.000 50.8	36923	
						1.550 39.37	1.930 49.03	321872	7/16
						1.545 39.25	2.000 50.8	36924	
			2.026 51.47	2.416 61.37	324085	1.550 39.37	1.930 49.03	321873	
						1.545 39.25	2.000 50.8	36925	1/2 M12
						2.056 52.23	2.671 67.85	322391	
						2.056 52.23	2.671 67.85	322224	
						1.545 39.25	2.000 50.8	36926	5/8 M16
						2.056 52.23	2.671 67.85	322225	3/4
						2.056 52.23	2.671 67.85	322226	7/8 M22

R Ring Tongue Terminals (Cont'd.)
Wire Range 3/0
CMA 150,500-190,000 [76.264-96.3 mm²]

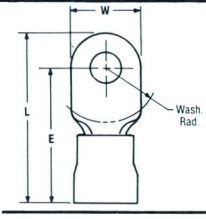

PLASTI-GRIP

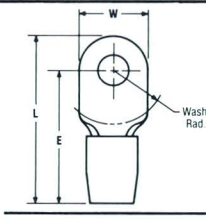

TERMINYL

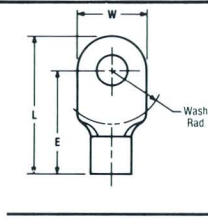

SOLISTRAND

PLASTI-GRIP			TERMINYL			SOLISTRAND			Stud Size
E Max.	L Max.	Maximum Insulation Dia.	E Max.	L Max.	Maximum Insulation Dia.	E Max.	L Max.	Non-Insulation Support	
						1.612 40.95	2.112 53.65	323868	1/4 M6

R Ring Tongue Terminals (Cont'd.) Wire Range 3/0 CMA 150,500-190,000 [76.264-96.3 mm²]

Dimensioning:

1. All dimensions in inches and millimetres. Values in brackets are metric equivalents.
2. Chart contains dimensions in inches over millimetres.

**Terminal Tongue Material Thickness .094 [2.39] Max.
Barrel I.D. .565 [14.36] Min.**

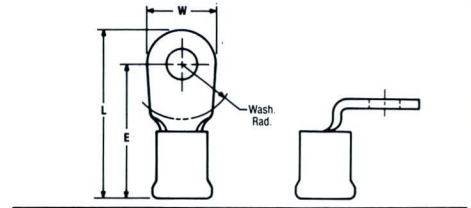

AMPLI-BOND

Stud Size	Tongue Dimensions			E Max.	L Max.	Maximum Insulation Dia.		
	Max. Wash. Rad.	C Min.	W			.737 [18.71]	.799 [20.3]	90° Bent Tongue .737 [18.71]
5/16 M8	.625 15.88		1.000 25.4	2.166 55.02	2.669 67.8	322093	2-322093-2	
	.625 15.88		1.000 25.4					
	.625 15.88		1.062 26.97					
3/8	.625 15.88		1.062 26.97	2.166 55.02	2.697 68.5	322059		
	.625 15.88		1.020 25.91	2.166 55.02	2.669 67.8	322094	322160	322919
	.625 15.88		1.062 26.97					
7/16	.625 15.88		1.020 25.91	2.166 55.02	2.669 67.8	322095		
	.625 15.88		1.000 25.4					
	.625 15.88		1.062 26.97					
1/2 M12	.625 15.88		1.062 26.97	2.166 55.02	2.697 68.5	322060	324195	
	.625 15.88		1.020 25.91	2.166 55.02	2.669 67.8	322096		322920
	.625 15.88		1.075 27.31					
5/8 M16	1.125 28.58		1.250 31.85					
	.625 15.88		1.062 26.97					
	1.125 28.58		1.250 31.85					
3/4	.625 15.88		1.062 26.97					
	1.125 28.58		1.250 31.85					
	.625 15.88		1.062 26.97					
7/8 M22	1.125 28.58		1.250 31.85					
	1.125 28.58		1.250 31.85					
	1.125 28.58		1.250 31.85					

R Ring Tongue Terminals (Cont'd.)
 Wire Range 3/0
 CMA 150,500-190,000 [76.264-96.3 mm²]

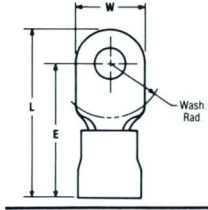

PLASTI-GRIP

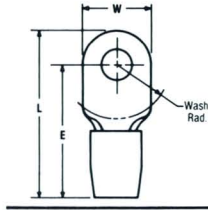

TERMINYL

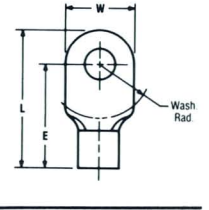

SOLISTRAND

E Max.	L Max.	Maximum Insulation Dia.		E Max.	L Max.	Maximum Insulation Dia.		Non Insulation Support	Stud Size
		.800 [20.4]				.680 [17.28]			
								321874	
2.082 52.89	2.615 66.43		52256						5/16 M8
2.084 52.94	2.615 66.43		52258					320266	
				2.294 58.27	2.794 70.97		324185		
								321875	3/8
								36827	
								321876	
2.084 52.94	2.615 66.43		52256-1						7/16
2.084 52.94	2.615 66.43		52258-1					36928	
								36929	
								321877	
				2.294 58.27	2.794 70.97		324186		
								1-322222-0	1/2 M12
								322222	
								36930	5/8 M16
								322223	
								36931	3/4
								322221	7/8 M22

BL Ring Tongue Terminals (Cont'd.)
Wire Range 4/0
CMA 190,000-231,000 [96.3-117.057 mm²]

Dimensioning:

1. All dimensions in inches and millimetres. Values in brackets are metric equivalents.
2. Chart contains dimensions in inches over millimetres.

Terminal Tongue Material Thickness .105 [2.67] Max.
Barrel I.D. .635 [16.13] Min.

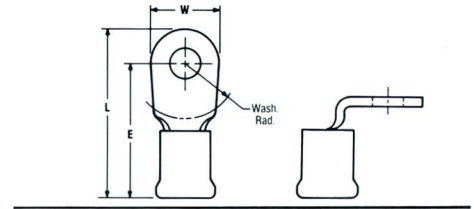

AMPLI-BOND

Stud Size	Tongue Dimensions			E Max.	L Max.	Maximum Insulation Dia.		
	Max. Wash. Rad.	C Min.	W			.799 [20.3]	.950 [24.13]	90° Bent Tongue .799 [20.3]
1/4 M6	.625 15.88		1.020 25.91	2.203 55.96	2.766 70.26	2-322061-2		
	.625 15.88		1.125 28.58					
5/16 M8	1.078 27.39		1.125 28.58					
	.625 15.88		1.140 28.96	2.203 55.96	2.766 70.26	322061	324196	
3/8	.625 15.88		1.062 26.97	2.203 55.96	2.737 69.52	322097	322161	322923
	.625 15.88		.810 20.57					
	1.078 27.39		1.125 28.58					
7/16	.625 15.88		1.062 26.97	2.203 55.96	2.737 69.52	322098		
	.625 15.88		1.062 26.97					
1/2 M12	.625 15.88		1.062 26.97	2.203 55.96	2.737 69.52	322099		
	.625 15.88		1.140 28.96	2.203 55.96	2.766 70.26	322062	324197	
5/8 M16	1.078 27.39		1.125 28.58					
	.625 15.88		1.140 28.95	2.203 55.96	2.766 70.26	327177		
3/4	1.083 27.51		1.250 31.75					
	1.078 27.39		1.250 31.75					
7/8 M22	1.078 27.39		1.250 31.75					
	.625 15.88		1.140 28.95					
	1.083 27.51		1.250 31.75	2.661 67.59	3.289 83.55	322063		322926
	1.078 27.39		1.250 31.75	1.078 27.39	2.618 66.5			

BL Ring Tongue Terminals (Cont'd.)
Wire Range 4/0
CMA 190,000-231,000 [96.3-117.057 mm²]

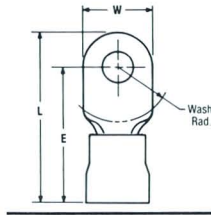

PLASTI-GRIP

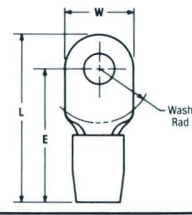

TERMINYL

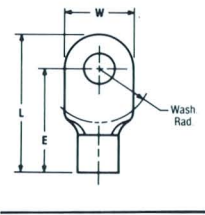

SOLISTRAND

E Max.	L Max.	Maximum Insulation Dia.		E Max.	L Max.	Maximum Insulation Dia.		E Max.	L Max.	Non Insulation Support	Stud Size
		.950 [24.13]				.760 [19.31]					
								1.644 41.76	2.206 56.04	2-36932-2	1/4 M6
								1.985 50.42	2.537 64.44	321271	5/16 M8
2.160 54.87	2.723 69.17	52255		2.295 59.3	2.858 72.6	324187		1.644 41.76	2.206 56.04	36923	
								1.657 42.09	2.178 55.33	321878	
				2.295 59.3	2.700 68.58	329150					3/8
								1.985 50.42	2.537 64.44	321162	
2.160 54.87	2.694 68.43	52259						1.657 42.09	2.178 55.33	321879	
								1.644 41.76	2.206 56.04	36933	7/16
								1.657 42.09	2.178 55.33	321880	
2.160 54.87	2.723 69.17	52255-1		2.295 59.3	2.858 72.6	324188		1.644 41.76	2.206 56.04	36934	1/2 M12
								1.985 50.42	2.537 64.44	321163	
2.160 54.87	2.723 69.17	52255-2						1.644 41.76	2.206 56.04	36935	
				2.768 70.31	3.385 85.98	329151					5/8 M16
								2.117 53.78	2.732 69.4	322227	
								2.117 53.78	2.732 69.4	322228	
								1.644 41.76	2.206 56.04	36936	3/4
				2.768 70.31	3.385 85.98	324189					
2.618 66.5	3.246 82.45	52260						2.117 53.78	2.732 69.4	321625	7/8 M22

Ring Tongue Terminals (Cont'd.)

Dimensioning:

1. All dimensions in inches and millimetres. Values in brackets are metric equivalents.
2. Charts contain dimensions in inches over millimetres.

Wire Range 8 Heavy Duty
CMA 13,100-20,800
[6.638-10.54 mm²]

R

Terminal Tongue Material Thickness .095 [2.42] Max.
Barrel I.D. .177 [4.49] Min.

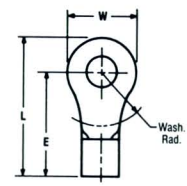
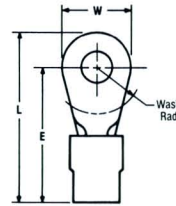

PRE-INSULATED NYLON

SOLISTRAND

Stud Size	Max. Wash. Rad.	W	E Max.	L Max.	Maximum Insulation Diameter .328 [8.34]	E Max.	L Max.	Non Insulation Support
10	.240 6.1	.500 12.7	.983 24.97	1.236 31.4	2-330964-1	.696 17.68	.949 24.11	2-330968-1
	.443 11.26	.587 14.91	1.264 32.11	1.560 39.63	331415	.977 24.82	1.273 32.34	331414
1/4 M6	.250 6.35	.468 11.89	.983 24.97	1.220 30.99	1-332043-0	.696 17.68	.933 23.7	1-332042-0
	.443 11.26	.587 14.91	1.264 32.11	1.560 39.63	1-331415-0	.977 24.82	1.273 32.34	1-331414-0
5/16 M8	.240 6.1	.500 12.7	.983 24.97	1.236 31.4	330964	.696 17.68	.949 24.11	330968
	.250 6.35	.468 11.89	.983 24.97	1.220 30.99	332043	.696 17.68	.933 23.7	332042
3/8	.443 11.26	.587 14.91	1.264 32.11	1.560 39.63	1-331415-1	.977 24.82	1.273 32.34	1-331414-1
	.443 11.26	.587 14.91	1.264 32.11	1.560 39.63	1-331415-2	.977 24.82	1.273 32.34	1-331414-2
1/2 M12	1.000 25.4	1.250 31.75				1.337 33.96	1.970 50.04	331696
	1.000 25.4	1.250 31.75				1.337 33.96	1.970 50.04	1-331696-0
1/2 M12	1.000 25.4	1.250 31.75				1.337 33.96	1.970 50.04	1-331696-1

Wire Range 6 Heavy Duty
CMA 20,800-33,100
[10.54-16.773 mm²]

BL

Terminal Tongue Material Thickness .095 [2.42] Max.
Barrel I.D. .232 [5.89] Min.

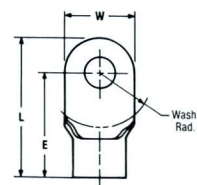
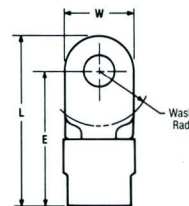

PRE-INSULATED NYLON

SOLISTRAND

Stud Size	Max. Wash. Rad.	W	E Max.	L Max.	Maximum Insulation Diameter .383 [9.73]	E Max.	L Max.	Non Insulation Support
10	.370 9.4	.500 12.7	1.307 33.2	1.560 39.63	2-330965-1	.931 23.65	1.184 30.08	2-330969-1
1/4 M6	.370 9.4	.500 12.7	1.307 33.2	1.560 39.63	330965	.931 23.65	1.184 30.08	330969

Wire Range 4 Heavy Duty
CMA 33,100-52,600
[16.773-26.654 mm²]

Y

Terminal Tongue Material
Thickness .095 [2.42] Max.
Barrel I.D. .296 [7.52] Min.

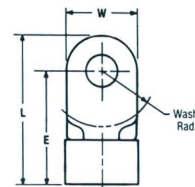
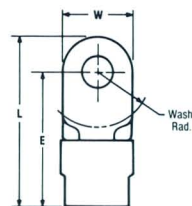

Stud Size	Max. Wash. Rad.	W	PRE-INSULATED NYLON		Maximum Insulation Diameter .383 [9.73]	SOLISTRAND		Non Insulation Support
			E Max.	L Max.		E Max.	L Max.	
5/16 M8	.454 11.54	.625 15.88	1.476 37.5	1.791 46.32	331418	1.100 27.94	1.415 35.95	331417
	.454 11.54	.625 15.88	1.476 37.5	1.791 46.32		1-331418-0	1.100 27.94	1.415 35.95
3/8	.454 11.54	.625 15.88	1.476 37.5	1.791 46.32	1-331418-1	1.100 27.94	1.415 35.95	1-331417-1

PRE-INSULATED NYLON

SOLISTRAND

Stud Size	Max. Wash. Rad.	W	PRE-INSULATED NYLON		Maximum Insulation Diameter .443 [11.26]	SOLISTRAND		Non Insulation Support
			E Max.	L Max.		E Max.	L Max.	
1/4 M6	.437 11.1	.500 12.7	1.349 34.27	1.602 40.7	330966	.977 24.82	1.230 31.25	330970
	.456 11.59	.679 17.25	1.565 39.76	1.907 48.44		331421	1.193 30.31	1.535 38.99
3/8	.456 11.59	.679 17.25	1.565 39.76	1.907 48.44	1-331421-0	1.193 30.31	1.535 38.99	1-331420-0
1/2 M12	.456 11.59	.679 17.25	1.565 39.76	1.907 48.44	1-331421-1	1.193 30.31	1.535 38.99	1-331420-1

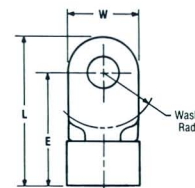
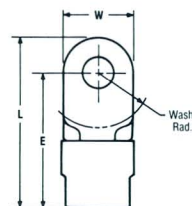

PRE-INSULATED NYLON

SOLISTRAND

Stud Size	Max. Wash. Rad.	W	PRE-INSULATED NYLON		Maximum Insulation Diameter .523 [13.29]	SOLISTRAND		Non Insulation Support
			E Max.	L Max.		E Max.	L Max.	
1/4 M6	.500 12.7	.625 15.88	1.661 42.19	1.976 50.2	330967	1.212 30.79	1.527 38.79	330971
	.639 16.24	.855 21.72	1.764 44.81	2.194 55.73		331424	1.315 33.41	1.745 44.33

Wire Range 2 Heavy Duty
CMA 52,600-83,700
[26.654-42.414 mm²]

R

Terminal Tongue Material
Thickness .095 [2.42] Max.
Barrel I.D. .375 [9.53] Min.

Ring Tongue Terminals (Cont'd.)

Dimensioning:

1. All dimensions in inches and millimetres. Values in brackets are metric equivalents.
2. Charts contain dimensions in inches over millimetres.

Wire Range 2 Heavy Duty
Continued

Wire Range 1/0 Heavy Duty
CMA 83,700-119,500
[42.414-60.555 mm²]



Stud Size	Max. Wash. Rad.	W	PRE-INSULATED NYLON			SOLISTRAND		
			E Max.	L Max.	Maximum Insulation Diameter .523 [13.29]	E Max.	L Max.	Non Insulation Support
3/8	.639 16.24	.855 21.72	1.764 44.81	2.194 55.73	1-331424-0	1.315 33.41	1.745 44.33	1-331423-0
1/2 M12	.639 16.24	.855 21.72	1.764 44.81	2.194 55.73	1-331424-1	1.315 33.41	1.745 44.33	1-331423-1

Terminal Tongue Material Thickness .095 [2.42] Max. Barrel I.D. .439 [11.15] Min.

PRE-INSULATED NYLON

SOLISTRAND

Stud Size	Max. Wash. Rad.	W	PRE-INSULATED NYLON		Maximum Insulation Diameter .625 [15.88]	SOLISTRAND		Non Insulation Support
			E Max.	L Max.		E Max.	L Max.	
1/4 M6	.691 17.56	.807 20.5	2.045 51.95	2.451 62.26	331446	1.519 38.59	1.928 48.98	331880
3/8	.691 17.56	.807 20.5	2.045 51.95	2.451 62.26	1-331446-0	1.519 38.59	1.928 48.98	1-331880-0
1/2 M12	.691 17.56	.807 20.5	2.045 51.95	2.451 62.26	1-331446-1	1.519 38.59	1.928 48.98	1-331880-1

Special Wire Sizes and Tongue Configurations

PIDG Ring Tongue
Wire Range 24-20
CMA 320-1,290
[.162-.654 mm²]



Terminal Tongue Material
Thickness .025 [0.64] Max.
Barrel I.D. .043 [1.09] Min.

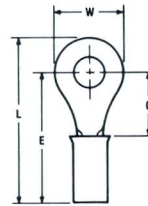

PIDG PRE-INSULATED DIAMOND GRIP TERMINALS

Stud Size	C Min.	W	E Max.	L Max.	Vinyl	Nylon
					Maximum Insulation Dia.	
					.100 [2.54]	.100 [2.54]
0	.125 3.17	.160 4.06	.506 12.86	.589 14.97		328489†
1	.125 3.17	.160 4.06	.506 12.86	.589 14.97		324992†
2 M2	.125 3.17	.160 4.06	.506 12.86	.589 14.97		329636†
4	.250 6.35	.281 7.14	.631 16.03	.774 19.66	330285	323985†
	.250 6.35	.203 5.16	.631 16.03	.735 18.67		50534
6 M3.5	.250 6.35	.281 7.14	.631 16.03	.774 19.66		323986†
8 M4	.281 7.13	.312 7.92	.662 16.82	.821 20.86		323989†
10	.281 7.13	.312 7.92	.662 16.82	.821 20.86		323990†

Note: †Indicates terminal is available in Tape Mounted Form.

PIDG Offset Ring Tongue
Wire Range 22-16
CMA 509-3,260
[.258-1.652 mm²]



Terminal Tongue Material
Thickness .033 [0.84] Max.
Barrel I.D. .061 [1.54] Min.

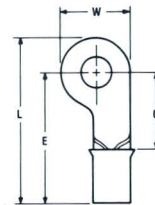

PIDG PRE-INSULATED DIAMOND GRIP TERMINALS

Stud Size	C Min.	W	E Max.	L Max.	Vinyl	Nylon
					Maximum Insulation Dia.	
					.125 [3.18]	.125 [3.18]
6 M3.5	.312 7.92	.375 9.53	.716 18.19	.906 23.12	323040†	323039†
10	.312 7.92	.375 9.53	.716 18.19	.906 23.12	324012†	324011†

Note: †Indicates terminal is available in Tape Mounted Form.

Special Wire Sizes and Tongue Configurations

Dimensioning:

1. All dimensions in inches and millimetres. Values in brackets are metric equivalents.
2. Charts contain dimensions in inches over millimetres.

PLASTI-GRIP Ring Tongue
Heavy Duty
Wire Range 20-16
CMA 810-3,260
[.410-1.652 mm²]

G

PIDG Offset Ring Tongue
Wire Range 16-14
CMA 2,050-5,180
[1.039-2.625 mm²]

BL

PLASTI-GRIP Flag Tongue
Wire Size 22-16
CMA 509-3,260
[.258-1.652 mm²]

Terminal Tongue Material
Thickness .042 [1.07] Max.
Barrel I.D. .069 [1.75] Min.

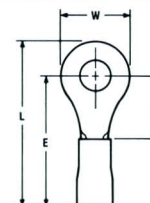

PLASTI-GRIP

Stud Size	C Min.	W	E Max.	L Max.	Maximum Insulation Dia.	
					.210 [5.34]	
8 M4	.312 7.92	.469 11.91	.728 18.5	.967 24.57	53199-1†	

Terminal Tongue Material
Thickness .033 [0.84] Max.
Barrel I.D. .085 [2.15] Min.

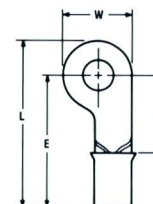

PIDG PRE-INSULATED DIAMOND GRIP TERMINALS

Stud Size	C Min.	W	E Max.	L Max.	Maximum Insulation Dia.	
					Vinyl .170 [4.32]	Nylon .150 [3.81]
6 M3.5	.312 7.92	.375 9.53	.716 18.19	.906 23.12	323768	323817
10	.312 7.92	.375 9.53	.716 18.19	.906 23.12	323769	323818

Terminal Tongue Material
Thickness .033 [0.84] Max.
Barrel I.D. .061 [1.54] Min.

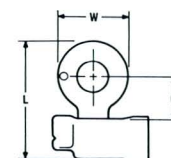

PLASTI-GRIP

Stud Size	C Min.	W	L Max.	Maximum Insulation Dia.	
				.140 [3.56]	
				Translucent Ins.	Stripe Color Code
10				322303	
14	.266 6.75	.500 12.7	.730 18.55	322304	Red
5/16 M16				322305	

Special Wire Sizes and Tongue Configurations

**PLASTI-GRIP Flag Tongue
Heavy Duty
Wire Range 20-16
CMA 810-3,260
[.410-1.652 mm²]**

**PLASTI-GRIP Flag Tongue
Wire Size 16-14
CMA 2,050-5,180
[1.039-2.625 mm²]**

**PLASTI-GRIP Flag Tongue
Heavy Duty
Wire Size 16-14
CMA 2,050-5,180
[1.039-2.625 mm²]**

**Terminal Tongue Material
Thickness .042 [1.07] Max.
Barrel I.D. .069 [1.75] Min.**

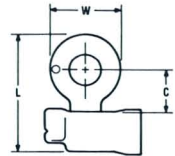

PLASTI-GRIP

Stud Size	C Min.	W	L Max.	Maximum Insulation Dia.	
				Translucent Ins.	Stripe Color Code
10				.170 [4.32]	
14	.266 6.75	.500 12.7	.749 19.03	322306 322307	Green
5/16 M8				322308	

**Terminal Tongue Material
Thickness .033 [0.84] Max.
Barrel I.D. .085 [2.15] Min.**

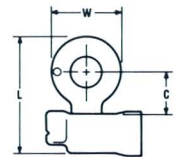

PLASTI-GRIP

Stud Size	C Min.	W	L Max.	Maximum Insulation Dia.	
				Translucent Ins.	Stripe Color Code
10				.170 [4.32]	
14	.266 6.75	.500 12.7	.749 19.03	322309 322310	Blue

**Terminal Tongue Material
Thickness .050 [1.27] Max.
Barrel I.D. .085 [2.15] Min.**

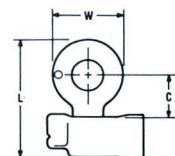

PLASTI-GRIP

Stud Size	C Min.	W	L Max.	Maximum Insulation Dia.	
				Translucent Ins.	Stripe Color Code
10				.230 [5.85]	
14	.266 6.75	.500 12.7	.810 20.58	322312 322313	Black
14				1-322313-0 *	

*Maximum insulation dia. — .320 [8.13]

Special Wire Sizes and Tongue Configurations

Dimensioning:

1. All dimensions in inches and millimetres. Values in brackets are metric equivalents.
2. Charts contain dimensions in inches over millimetres.

PLASTI-GRIP Flag Tongue
Wire Size 12-10
CMA 5,180-13,100
[2.625-6.638 mm²]

DIAMOND GRIP Flag Tongue
Wire Size 22-16
CMA 509-3,260
[.258-1.652 mm²]

SOLISTRAND Ring Tongue
Wire Size 24-20
CMA 320-1,290
[.162-.654 mm²]

Terminal Tongue Material
Thickness .042 [1.07] Max.
Barrel I.D. .131 [3.27] Min.

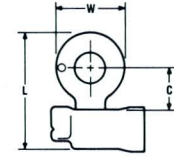

PLASTI-GRIP

Stud Size	C Min.	W	L Max.	Maximum Insulation Dia.	
				Translucent Ins.	Stripe Color Code
10				.230 [5.85]	
14	.266 6.75	.500 12.7	.812 20.63	322315	Yellow
5/16 M8				322316	
				322317	

Terminal Tongue Material
Thickness .033 [0.84] Max.
Barrel I.D. .061 [1.54] Min.

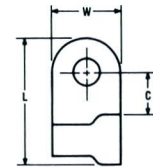

DIAMOND GRIP

Stud Size	C Min.	W	L Max.	Maximum Insulation Dia.	
				Translucent Ins.	Stripe Color Code
6 M3.5				.125 [3.18]	
8 M4	.151 3.83	.328 8.33	.515 13.09	32065	32066
10				32067	

Terminal Tongue Material
Thickness .033 [0.84] Max.
Barrel I.D. .043 [1.09] Min.

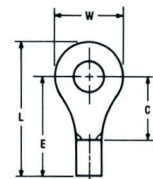

SOLISTRAND

Stud Size	C Min.	W	E Max.	L Max.	Part No.

Note: †Indicates terminal is available in Tape Mounted Form.

SOLISTRAND Slotted Ring Tongue
Wire Size 24-20
CMA 320-1,290
[.162-.654 mm²]

Terminal Tongue Material
Thickness .033 [0.84] Max.
Barrel I.D. .043 [1.09] Min.

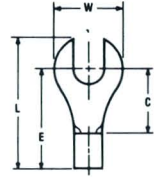

SOLISTRAND

Stud Stud	C Min.	W	E Max.	L Max.	Part No.
1	.125 3.17	.160 4.06	.306 7.78	.389 9.89	330837

SOLISTRAND Flag Ring Tongue
Wire Size 16-14
CMA 2,050-5,180
[1.039-2.625 mm²]

Terminal Tongue Method
Thickness .033 [0.84] Max.
Barrel I.D. .085 [2.15] Min.

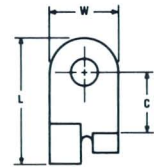

SOLISTRAND

Stud Size	C Min.	W	L Max.	Maximum Insulation Dia.	
				Left	Right
10				36106	36110
1/4 M6	.484	.562	1.031	36107	36111
5/16 M8	12.29	14.27	26.19	36108	36112
3/8				36109	36113

SOLISTRAND Flag Ring Tongue
Wire Size 16-14
CMA 2,050-5,180
[1.039-2.625 mm²]

Terminal Tongue Material
Thickness .033 [0.84] Max.
Barrel I.D. .085 [2.15] Min.

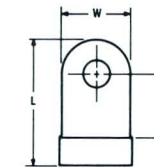

SOLISTRAND

Stud Size	C Min.	W	L Max.	Non Insulation Support
8 M4	.250	.312	.579	325069
10	6.35	7.92	14.71	322819

Special Wire Sizes and Tongue Configurations

Dimensioning:

1. All dimensions in inches and millimetres. Values in brackets are metric equivalents.
2. Charts contain dimensions in inches over millimetres.

SOLISTRAND Rectangular Tongue Wire Size 16-14 CMA 2,050-5,180 [1.039-2.625 mm²]

Terminal Tongue Material
Thickness .033 [0.84] Max.
Barrel I.D. .085 [2.15] Min.

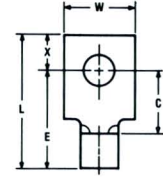

SOLISTRAND

Stud Size	C Min.	W	X	L Max.	Non-Insulation Support
6 M3.5					36174
8 M4	.420 10.66	.375 9.35	.250 6.35	.845 21.47	36175
10					36176
¼ M6					36177

SOLISTRAND Ring Tongue Wire Size 14-12 CMA 3,260-8,230 [1.652-4.17 mm²]

Terminal Tongue Material
Thickness .042 [1.07] Max.
Barrel I.D. .098 [2.48] Min.

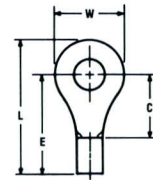

SOLISTRAND

Stud Size	C Min.	W	E Max.	L Max.	Washer Radius Max.	Part No.
2 M2		.250 6.35		.654 16.62		327071
4		.421 10.69		.739 18.78		34949†
6 M3.5		.421 10.69		.739 18.78		34950†
8 M4	.330 8.38	.250 6.35	.526 13.37	.654 16.62	.250 6.35	35684
		.421 10.69		.739 18.78		34951†
		.312 7.92		.685 17.4		321827
10		.421 10.69		.739 18.78		34484†
		.312 7.92		.685 17.4		321828
¼ M6		.421 10.69		.739 18.78		34487†
5/16 M8	.593 15.06	.687 17.45	.774 19.66	1.120 28.45	.437 11.1	34485
¾						35486

Note: †Indicates terminal is available in Tape Mounted Form.

Special Wire Sizes and Tongue Configurations

SOLISTRAND Offset Ring Tongue
 Wire Size 14-12
 CMA 3,260-8,230
 [1.652-4.17 mm²]

Terminal Tongue Material
 Thickness .042 [1.07] Max.
 Barrel I.D. .098 [2.48] Min.

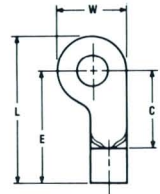

SOLISTRAND

Stud Size	C Min.	W	E Max.	L Max.	Part No.
10	.281	.421	.556	.769	34488
¼ M6	7.13	10.69	14.13	19.54	35686

SOLISTRAND Offset Ring Tongue
 Wire Size 14-12
 CMA 3,260-8,230
 [1.652-4.17 mm²]

Terminal Tongue Material
 Thickness .042 [1.07] Max.
 Barrel I.D. .098 [2.48] Min.

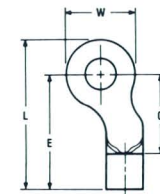

SOLISTRAND

Stud Size	C Min.	W	E Max.	L Max.	Part No.
10	.281	.343	.556	.730	35685
	7.13	8.71	14.13	18.55	

SOLISTRAND Slotted Tongue
 Wire Size 14-12
 CMA 3,260-8,230
 [1.652-4.17 mm²]

Terminal Tongue Material
 Thickness .042 [1.07] Max.
 Barrel I.D. .098 [2.48] Min.

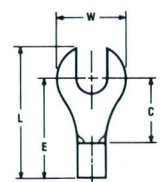

SOLISTRAND

Stud Size	C Min.	W	E Max.	L Max.	Part No.
		.421			34489
10	.330	10.69	.526	.759	
	8.38	.375	13.37	19.28	35540
		9.53			

Special Wire Sizes and Tongue Configurations

Dimensioning:

1. All dimensions in inches and millimetres. Values in brackets are metric equivalents.
2. Charts contain dimensions in inches over millimetres.

SOLISTRAND Flag Tongue
Wire Size 14-12
CMA 3,260-8,230
[1.652-4.17 mm²]

SOLISTRAND Flag Tongue
Wire Size 12-10
CMA 5,180-13,100
[2.625-6.638 mm²]

SOLISTRAND Flag Tongue
Wire Size 12-10
CMA 5,180-13,100
[2.625-6.638 mm²]

Terminal Tongue Material
Thickness .042 [1.07] Max.
Barrel I.D. .098 [2.48] Min.

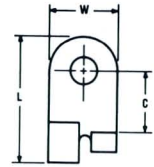

SOLISTRAND

Stud Size	C Min.	W	L Max.	Maximum Insulation Dia.	
				Left	Right
				.215 [5.47]	
6 M3.5					35522
8 M4	.405	.375	.859	35526	35523
10	10.28	9.53	21.82	35527	35524
¼ M6				320060	320059

Terminal Tongue Material
Thickness .042 [1.07] Max.
Barrel I.D. .129 [3.27] Min.

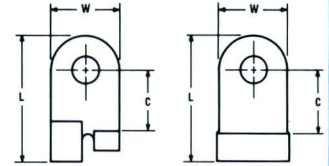

SOLISTRAND

Stud Size	C Min.	W	L Max.	Maximum Insulation Dia.	
				Left	Right
				.300 [7.62]	
10				36114	36118
¼ M6	.491	.562	1.109	36115	36119
5/16 M8	12.47	14.27	28.17	36116	36120
¾				36117	36121

Terminal Tongue Material
Thickness .042 [1.07] Max.
Barrel I.D. .129 [3.27] Min.

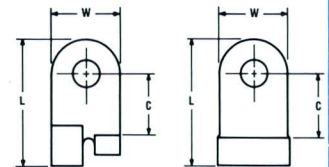

SOLISTRAND

Stud Size	C Min.	W	L Max.	Non Insulation Support Part No.
6 M3.5				36269
8 M4	.281	.375	.702	36270
10	7.14	9.53	17.84	36271
¼ M6				36272

Special Wire Sizes and Tongue Configurations

SOLISTRAND
Flag Rectangular Tongue
Wire Size 12-10
CMA 5,180-13,100
[2.625-6.638 mm²]

Terminal Tongue Material
Thickness .042 [1.07] Max.
Barrel I.D. .129 [3.27] Min.

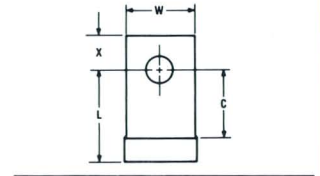

SOLISTRAND

Stud Size	C Min.	W	X	L Max.	Part No.
6 M3.5					36178
8 M4	.390	.375	.250	.875	36179
10	9.91	9.53	6.35	22.23	36180
¼ M6					36181

Butt Splices

Dimensioning:

1. All dimensions in inches and millimetres.
Values in brackets are metric equivalents.
2. Chart contains dimensions in inches over millimetres.



PIDG (PRE-INSULATED DIAMOND GRIP)

Wire Range	Barrel I.D. Min.	CMA Range*	mm ² Range	L Max.	Max. Insulation Dia.	Nylon Insulation Part No.	Plug No.
26-22	.029 0.73	202-810	0.103-0.41	.859 21.82	.082 2.09	323994	
24-20	.043 1.09	320-1,290	0.162-0.654	.968 24.59	.100 2.54	323975†	324005
				12.65 32.14	.125 3.18	320559†	323287
22-16	.061 1.54	509-3,260	0.258-1.936				
				1.265 32.14	.150 3.81	320562†	323288
16-14	.085 2.15	2,050-5,180	1.032-2.625				
14-12	.098 2.48	3,260-8,230	1.936-4.17				
				1.656 42.07	.220 5.59	320570	323289
12-10	.129 3.27	5,180-13,100	2.625-6.638				
8	.172 4.36	13,100-20,800	6.638-10.54				
6	.229 5.82	20,800-33,100	10.54-16.773				
4	.296 7.51	33,100-52,600	16.773-26.654				
2	.370 9.39	52,600-83,700	26.654-42.414				

*When using two or more wires in either end of a butt splice, the combined cross sectional area must be within the (CMA) circular mil range listed.
Note: †Indicates terminal is available in Tape Mounted Form.

Butt Splices

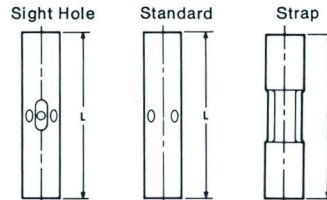
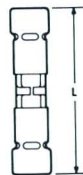

PLASTI-GRIP

DIAMOND GRIP

SOLISTRAND

L Max.	Max. Insulation Dia.	Part No.	L Max.	Max. Insulation Dia.	Part No.	L Max.	Style	Non Insulation Support		Wire Range	
								SOLISTRAND	BUDGET		
.620 15.75	.080 2.04	321026†	.655 16.64	.082 2.09	322949	.385 9.78	Strap	321198	321024	26-22	
							Strap	324001†	323991	24-20	
1.065 27.06	.125 3.18	34067†	.850 21.59	.125 3.18	32477	.591 15.02	Strap	2-321801-3	32463	22-16	
	.140 3.56	34070†		.140 3.56			32478	Standard	31818		34226
	.170 4.32	34243†						Sight Hole	330367		
	.083 x .171 2.11 x 4.35	34203†									
1.065 27.06	.140 3.56	34068†				.591 15.02	Strap	322459	32464		
			.837 21.26	.150 3.81	32479	.572 14.53	Standard	31819†	34227		
1.065 27.06	.170 4.32	34071†	.837 21.26	.170 4.32	32480	.572 14.53	Strap	327025	324201	16-14	
	.215 5.47	35244							Sight Hole	330368	
	.135 x .245 3.43 x 6.23	34204									
						.690 17.53	Sight Hole	321280		14-12	
1.160 29.47	.200 5.08	34069				.703 17.86	Strap	33189	30953		
							Sight Hole	330369			
	.230 5.85	34072†	1.223 31.07	.230 5.85	31834	.567 14.41	Standard	32151	34228	12-10	
	.250 6.35	34945				.765 19.44	Strap	324893	324898		
	.300 7.62	326742†									
	.138 x .281 3.51 x 7.14	34205									
						.827 21.01	Standard	34321		8	
							Sight Hole	36906			
						1.015 25.79	Standard	34322		6	
							Sight Hole	36886			
						1.140 28.96	Standard	34323		4	
							Sight Hole	320238			
						1.265 32.14	Standard	35189		2	
							Sight Hole	322246			

Butt Splices (Cont'd.)

Dimensioning:

1. All dimensions in inches and millimetres. Values in brackets are metric equivalents.
2. Charts contain dimensions in inches over millimetres.



PIDG (PRE-INSULATED DIAMOND GRIP)

Wire Range	Barrel I.D. Min.	CMA Range*	mm ² Range	L Max.	Max. Insulation Dia.	Nylon Insulation Part No.	Plug No.
1/0	.444 11.28	837,000-119,500	42.414-60.555				
2/0	.504 12.8	119,500-150,500	60.555-76.264				
3/0	.565 14.36	150,500-190,000	76.264-96.3				
4/0	.635 16.13	190,000-231,000	96.3-117.057				
250-300		231-300 MCM	117.057-151.731				
300-350		300-380 MCM	151.731-192.561				
400		380-478 MCM	192.561-242.221				
500-600		478-600 MCM	242.221-304.043				

*When using two or more wires in either end of a butt splice, the combined cross sectional area must be within the (CMA) circular mil range listed.
Note: †Indicates terminal is available in Tape Mounted Form.

Step Down Butt Splices



PIDG (PRE-INSULATED DIAMOND GRIP)

Wire Range	Barrel I.D. Min.	CMA Range	mm ² Range	L Max.	Max. Insulation Dia.	Nylon Insulation Part No.	Adapter No.
16-14 to 22-16		2,050-5,180 to 509-3,260	1.032-2.625 to 0.258-1.936	1.265 32.14	.150-.115 3.81-2.93	327583	327635
12-10 to 16-14		5,180-13,100 to 2,050-5,180	2.625-6.638 to 1.032-2.625	1.656 42.07	.220-.170 5.59-4.32	327638	327637
12-10 to 22-16		5,180-13,100 to 509-3,260	2.625-6.638 to 0.258-1.936		.220-.140 5.59-3.56	327639	327636

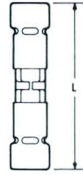

PLASTI-GRIP

DIAMOND GRIP

SOLISTRAND

L Max.	Max. Insulation Dia.	Part No.	L Max.	Max. Insulation Dia.	Part No.	L Max.	Style	Non Insulation Support		Wire Range
								SOLISTRAND	BUDGET	
						1.412 36.1	Sight Hole	36957		1/0
						1.437 36.5		36958		2/0
						1.480 37.6		36959		3/0
						1.484 37.7		36960		4/0
						2.093 53.17		322279		250-300
						2.217 56.32		322280		300-350
						2.467 62.67		322281		400
						2.811 71.4		322282		500-600

**Step Down
Butt Splices**

PLASTI-GRIP

DIAMOND GRIP

SOLISTRAND

L Max.	Max. Insulation Dia.	Part No.	L Max.	Max. Insulation Dia.	Part No.	L Max.	Style	Non Insulation Support		Wire Range
								SOLISTRAND	BUDGET	
										16-14 to 22-16
										12-10 to 16-14
										12-10 to 22-16

Butt Splices

Dimensioning:

1. All dimensions in inches and millimetres. Values in brackets are metric equivalents.
2. Charts contain dimensions in inches over millimetres.



TERMINYL

Single to Single

Wire Size	CMA Range	mm ² Range	L Max.	Barrel I.D. Min.	Maximum Wire Insulation Dia.	Part No.
8	13,100-20,800	6.638-10.54	2.030 51.57	.180 4.57	.255 6.48	324625
6	20,800-33,100	10.54-16.773	2.230 56.65	.224 5.68	.310 7.88	324660
4	33,100-52,600	16.773-26.654	2.759 70.08	.280 7.11	.370 9.4	324622
2	52,600-83,700	26.654-42.414	3.044 77.32	.357 9.06	.445 11.31	324623
1/0	83,700-119,500	42.414-60.555	3.790 96.27	.444 11.27	.545 13.85	324666
2/0	119,500-150,500	60.555-76.264	3.790 96.27	.504 12.8	.605 15.37	2-329111-1

Step-Down Butt Splices



TERMINYL

Single to Single

Wire Size	CMA Range	mm ² Range	L	Barrel I.D. Min.	Maximum Wire Insulation Dia.	Part No.
8 to 16-14	13,100-20,800 to 2,050-5,180	6.638-10.54 to 1.032-2.625	2.030 51.57	.180 to .130 4.57 to 3.3	.255 6.48	328577
8 to 12-10	13,100-20,800 to 5,180-13,100	6.638-10.54 to 2.625-6.638	2.030 51.57	.180 to .150 4.57 to 3.81	.255 6.48	328569
6 to 8	20,800-33,100 to 13,100-20,800	10.54-16.773 to 6.638-10.54	2.250 57.15	.224 to .195 5.68 to 4.95	.310 7.88	328571
4 to 8	33,100-52,600 to 13,100-20,800	16.773-26.654 to 6.638-10.54	2.795 71	.280 to .220 7.11 to 5.58	.370 9.4	328579
4 to 6	33,100-52,600 to 20,800-33,100	16.773-26.654 to 10.54-16.773	2.781 70.63	.280 to .240 7.11 to 6.09	.370 9.4	328573
2 to 4	52,600-83,700 to 33,100-52,600	26.654-42.414 to 16.773-26.654	3.044 77.32	.357 to .310 9.06 to 7.87	.445 11.31	328575
1/0 to 2	83,700-119,500 to 52,600-83,700	42.414-60.555 to 26.654-42.414	3.790 96.27	.444 to .395 11.27 to 10.03	.545 13.85	328581

Note: Use larger wire size tooling for Step-Down Splices.



TERMINYL

TERMINYL

Multiple to Multiple

Single to Multiple

L Max.	Barrel I.D. Min.	Maximum Wire Insulation Dia.	Part No.	L Max.	Barrel I.D. Min.	Single Maximum Wire Insulation Dia.	Barrel I.D. Min.	Multiple Maximum Wire Insulation Dia.	Part No.
2.230 56.65	.180 4.57	.335 8.51	324657	2.130 54.11	.180 4.57	.255 6.48	.180 4.57	.335 8.51	324658
2.430 61.73	.224 5.68	.415 10.55	324659	2.330 59.19	.224 5.68	.310 7.88	.224 5.68	.415 10.55	324621
2.759 70.08	.280 7.11	.495 12.58	324661	2.759 70.08	.280 7.11	.370 9.4	.280 7.11	.495 12.58	324662
3.054 77.58	.357 9.06	.595 15.12	324663	3.054 77.58	.357 9.06	.445 11.31	.357 9.06	.595 15.12	324664
4.040 102.62	.444 11.27	.745 18.93	324665	3.915 99.45	.444 11.27	.545 13.85	.444 11.27	.745 18.93	324624
4.040 102.62	.504 12.8	.845 21.47	2-329111-2	3.915 99.45	.504 12.8	.605 15.37	.504 12.8	.845 21.47	329111

Step-Down Butt Splices



TERMINYL

TERMINYL

Multiple to Multiple

Single to Multiple

L Max.	Barrel I.D. Min.	Maximum Wire Insulation Dia.	Part No.	L Max.	Barrel I.D. Min.	Single Maximum Wire Insulation Dia.	Barrel I.D. Min.	Multiple Maximum Wire Insulation Dia.	Part No.
	.180 to .130 4.57 to 3.3			2.180 55.38	.180 to .130 4.57 to 3.3	.255 6.48	.180 to .130 4.57 to 3.3	.335 8.51	328542
	.180 to .150 4.57 to 3.81			2.180 55.38	.180 to .150 4.57 to 3.81	.255 6.48	.180 to .150 4.57 to 3.81	.335 8.51	328538
2.430 61.72	.224 to .195 5.68 to 4.95	.415 10.55	328572	2.330 59.19	.224 to .195 5.68 to 4.95	.310 7.88	.224 to .195 5.68 to 4.95	.415 10.55	328539
2.795 70.98	.280 to .220 7.11 to 5.58	.495 12.58	328580	2.795 70.08	.280 to .220 7.11 to 5.58	.370 9.4	.280 to .220 7.11 to 5.58	.495 12.58	328537
	.280 to .240 7.11 to 6.09			2.759 70.08	.280 to .240 7.11 to 6.09	.370 9.4	.280 to .240 7.11 to 6.09	.495 12.58	328540
	.357 to .310 9.06 to 7.87			3.044 77.32	.357 to .310 9.06 to 7.87	.445 11.31	.357 to .310 9.06 to 7.87	.595 15.12	328541

Parallel Splices

Dimensioning:

1. All dimensions in inches and millimetres. Values in brackets are metric equivalents.
2. Chart contains dimensions in inches over millimetres.



PLASTI-GRIP

SOLISTRAND

Wire Range	CMA Range*	mm ² Range	L Max.	Max. Insulation Dia.	Part No.	L Max.	Non Insulation Support	
							SOLISTRAND	BUDGET
22-16	509-3,260	0.258-1.936	.760 19.31	.120 3.05	34131	.301 7.65	34130	31579
			.760 19.31	.140 3.56	34132			
			.760 19.31	.083 x .171 2.11 x 4.35	34206 [▲]			
16-14	2,050-5,180	1.032-2.625	.760 19.31	.140 3.56	34133	.301 7.65	34137	34065
			.760 19.31	.170 4.32	34134			
			.760 19.31	.135 x .245 3.43 x 6.23	34207 [▲]			
12-10	5,180-13,100	2.625-1.032	.843 21.42	.200 5.08	34135	.343 8.72	34138	34066
			.870 22.1	.230 5.85	34136			
			.900 22.86	.138 x .281 3.51 x 7.14	34208 [▲]			
8	13,100-20,800	6.638-10.54				.375 9.53	34318	
6	20,800-33,100	10.54-16.773				.437 11.1	34319	
4	33,100-52,600	16.773-26.654				.531 13.49	34320	
2	52,600-83,700	26.654-42.414				.640 16.26	35187	
1/0	83,700-119,500	42.414-60.555				.734 18.65	36946	
2/0	119,500-150,500	60.555-76.264				.734 18.65	36948	
3/0	150,500-190,000	76.264-96.3				.749 19.03	36909	
4/0	190,000-231,000	96.3-117.057				.765 19.44	36951	
250-300	231-300 MCM	117.057-151.731				1.062 26.98	322275	
300-350	300-380 MCM	151.731-192.561				1.124 28.55	322276	
400	380-478 MCM	192.561-242.221				1.249 31.73	322277	
500-600	478-600 MCM	242.221-304.043				1.421 36.1	322278	

*When using two or more wires in a parallel splice, the combined cross sectional area must be within the (CMA) circular mil area listed.

▲Oval expansion.

Closed End Splices



ECN, EC			VS, ECV				
Wire Range	Circular MIL Range§	Color Coding	L Max.	Minimum Opening Dia.	Insulation Material and Type*	Shroud** Style	Part No.
22-14	509-5,180 [0.258-2.625 mm ²]	Translucent	.800 20.32	.265 6.74	Vinyl (ECV)	B-T	330021† •
		Purple	.740 18.8	.187 4.75	Vinyl (VS)		36964†
		Translucent	.680 17.28	.250 6.35	Nylon (ECN)	SS	35115† 330718††
18-16	3,248-4,872 [1.646-2.469 mm ²]	Translucent	1.093 27.77	.255 6.48	Vinyl (ECV)	B-T	50920† •
			1.000 25.4	2.65 6.74			328890† •
18-12	3,248-11,400 [1.646-5.776 mm ²]	Translucent	1.125 28.58	.360 9.15	Vinyl (ECV)	B-T	329251††
			.775 19.69	.375 9.53	Nylon (ECN)	SS	35653† 330905††
18-10	3,248-13,100 [1.646-6.638 mm ²]	Translucent	1.010 25.66	.312 7.93	Vinyl (VS)		36965†
		Purple	1.125 28.58	.360 9.15	Vinyl (ECV)	B-T	321519
			.720 18.29	.375 9.53	Nylon (EC)	SS	324067† •
		Translucent	1.118 28.4	.495 12.58	Nylon (ECN)	LS	324222
			.720 18.29	.370 9.4	Nylon (EC)	SS	328400††
18-8	10,320-20,820 [5.229-10.549 mm ²]	Green	1.575 40.01	.500 12.7	Vinyl (ECV)	B-T	320788
			.750 19.05	.173 4.4			34306†
16-14	3,248-4,872 [1.646-2.469 mm ²]	Blue	.760 19.31	.215 5.47	Vinyl (VS)	B-T	34864†
				.135 x .245 3.43 x 6.23			34349 [▲]
12-10	5,180-13,100 [2.625-6.638 mm ²]	Yellow	.975 24.77	.235 5.97	Vinyl (VS)	B-T	34308
			1.010 25.66	.300 7.62			34865
12-6	19,500-36,900 [9.881-18.697 mm ²]	Blue	1.575 40.01	.500 12.7	Vinyl (ECV)	B-T	53891-1x

*Voltage and temperature rating codes: VS=300 V, 90°C; ECV=600-1000 V, 105°C; ECN=300 V, 105°C; EC=600-1000 V, 105°C.

**Closed end splice: B-T=BOMB-TAIL Splice; SS=Short Shroud; LS=Long Shroud.

†Unplated splice.

•Tin Plated Carbon Steel Splice.

xSubmitted for UL Listing and CSA Certification.

Note: †Indicates splice is available in Tape Mounted Form.

§When using two or more wires in a parallel splice, the combined cross sectional area must be within the circular mil range listed.

▲Oval expansion.

Special Wire Sizes and Splices

Dimensioning:

1. All dimensions in inches and millimetres. Values in brackets are metric equivalents.
2. Charts contain dimensions in inches over millimetres.

PIDG Knife Disconnect Splice



PIDG PRE-INSULATED DIAMOND GRIP

Wire Range	Color Code	L Max.	Maximum Insulation Dia.	Insulation Material	
				Vinyl	Nylon
22-16	Red	.878 22.31	.125 3.18	32445†	320555†
			.140 3.56	32446†	
16-14	Blue		.150 3.81	32447†	320566†
			.170 4.32	32448†	
12-10	Yellow	1.260 32.01	.230 5.85	33197	320620
			.250 6.35	35762	

Note: †Indicates splice is available in Tape Mounted Form.

DIAMOND GRIP Knife Disconnect Splice



DIAMOND GRIP

Wire Range	L Max.	Maximum Insulation Dia.	Part No.
22-16		.125 3.18	31770†
		.140 3.56	31777†
16-14	.794 20.17	.150 3.81	31943†
		.170 4.32	31944†
12-10	1.176 29.87	.230 5.85	31942

Note: †Indicates splice is available in Tape Mounted Form.

Dimensioning:

1. All dimensions in inches and millimetres. Values in brackets are metric equivalents.
2. Charts contain dimensions in inches over millimetres.

For unstripped wire



PRE-INSULATED DIAMOND GRIP

Insulation Dia. Range	Color Code	L Max.	Part No.
.048-.080 1.22-2.03	Transparent	.515 13.08	324484
.080-.120 2.03-3.05	Red		324485
.120-.150 3.05-3.81	Blue		324486
.150-.223 3.81-5.66	Yellow		324487

**For unstripped wire
(Moisture Resistant Type)**



PRE-INSULATED DIAMOND GRIP

Insulation Dia. Range	Color Code	L Max.	Part No.
.048-.080 1.22-2.03	Transparent	.515 13.08	324693
.080-.120 2.03-3.05	Red		324694
.120-.150 3.05-3.81	Blue		324695
.150-.223 3.81-5.66	Yellow		324696

**For stripped wire
(Meets MIL-T-7928 and 25274
Class II requirements)**



PRE-INSULATED DIAMOND GRIP

Wire Range	CMA Range	mm ² Range	Max. Insulation Dia.	Color Code	L Max.	Part No.
22-18	509-3,248	.258-1.646	.124 3.15	Red	.430 10.92	328307†
16-14	2,050-5,180	1.039-2.625	.149 3.78	Blue		328308†
12-10	5,180-13,100	2.625-6.638	.210 5.33	Yellow	.478 12.14	328309†

†Indicates spare wire caps are available in tape mounted form.

Spare wire caps with nylon insulating jackets are available in three types: unstripped, unstripped moisture resistant and stripped. All are attachable with AMP matching hand crimping tools.

Insulated and Un-insulated Terminal and Splice Tooling 30 to 10 AWG Wire Range



Long Handle Tool



Short Handle Tool



T Head Tool



Heavy Head Tool

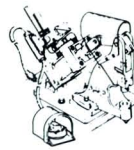

69004 Pneumatic Tool



69005 69010 Pneumatic Tool

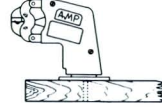

69011 69012 AMPLI-PRESS

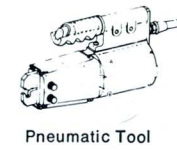













Pneumatic Tool 68068 as shown
68068-1 Side mount handle
68068-3 can be bench mounted — foot pedal actuated



69319-1 Pneumatic Tool



46110 Pneumatic Tool

Description	AMP Wire Size	LOOSE PIECE TOOLING				
		Hand Tools	"T" Head Tools	Dies for 69004	Heads for 69005	Heads for 69010
PIDG Terminals and Splices  Ring Tongue  Window Splice	30-26	69163 * (crimps 26-22 PIDG terms. on 30-26 wire)				
	26-22	47304 * ● 46121 ▲ 48518 *	59275 *	48438 (terms. only)	47469	
	24-20	47907-1 ▲ 47907 *	59275 * 59300 ▲		69957	
PLASTI-GRIP Terminals  Ring Tongue	22-16	47386 ▲ 47386-2 * 69151-1 ▲ ●	69961 ▲, 59300 ▲, 59170 *, 59250 ▲	47451	47516	46282
	16-14 20-16 H.D.	47387 ▲ 47387-2 * 69152-1 ▲ ●	69960 ▲ PIDG only 59170 *, 59250 ▲	47452	47517	46284
	12-10 16-14 H.D.	59239-4 ○ (.230 & .250 exp.) 59287-2 ○ (.275 & .300 exp.) 69150-1 ○ ● (.230 exp.)		47453		47518-1 48237 (lg. exp. for terms. only)
PLASTI-GRIP Splices & Flag Terminals  Butt Splice  Parallel Splice  Flag Tongue	26-22	46121 ▲ (butt splices only) 48518 *				
	22-16	45160 ▲ (butt splices only) 45449 ▲ (parallel splice only) 48045 * (flag only)			45161 (butt splices) 45451 (parallel splices only)	
	16-14	45575-1 ▲ (butt splices only) 45450 ▲ (parallel splice only) 48040 * (flag only)			45162 (butt splices) 45452 (Parallel splices only)	
	16-14 H.D.	48049 * (flag only) 68142-1 ▲ (.285-.320 flag only)				
	12-10	59489 ○ (butt splices only) 59287-1 ○ (lg. exp.) 59270 ○ (parallel splice only) 48049 * (flag only) 68142-1 ▲ (.285-.320 flag only)		68057 (butt splices only)		45163-1 (butt splices only)
DIAMOND GRIP Terminals and Splices  Ring Tongue  Butt Splice	26-22	48070 * 48070-1 * ● 49783 * (flag terms.) & (no ratchet)			49999	
	24-20				46632	
	22-16	49512 ▲ 49915 * 47110 ▲ ● (terms. only) 49885-1 ▲ (flag only)			47640 ● 38084	48494
	16-14	49513 ▲ 49916 *			38083	
	12-10	59054 ○ 59054-2 ○ ● 59173 ○ (lg. exp.)				38675 38675-2 ●
SOLISTRAND Terminals and Splices  Ring Tongue  Flag Tongue  Butt Splice  Parallel Splice	26-22	69363 ▲				68159-1
	24-20	69363 ▲				
	22-16	49935 ▲ 49936 * (no ratchet) 49900 *		49312	300869 300454	300583
	16-14	49935 ▲ 49936 * (no ratchet) 49900 * 49975 ▲ (flag only)		49313	300454 300856 69749 (para. only) 37917 (flag only)	300583
	14-12	49592 ▲ 49769 ▲ (flag only)			38328	
	12-10	49935 ▲ 49936 (no ratchet) 49900 * 49965 ▲ (flag only)		49249	300454 37896 (flag only) 38415	300583 38406 68157-1 (parallel splices only)
BUDGET Terminals  Ring Tongue	22-16	49379 ▲ (no ratchet), 49834				
	16-14	49379 ▲ (no ratchet), 49834 49608 ▲				
	12-10	49656 ▲				

▲ Long Handle ○ Heavy Head ● Tight Insulation Support * Short Handle ■ Terminals Only △ Foot Pedal Operation only

Insulated and Un-insulated Terminal and Splice Tooling 30 to 10 AWG Wire Range



69710 Hand Tool



69365 Pneumatic Tool



69118-1 Pneumatic Hand Tool (Portable)

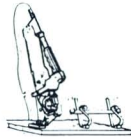

69359-2 Pneumatic Bench Tool

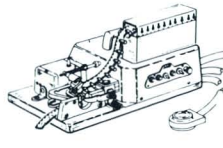

69370 Pneumatic Bench Machine



68075 AMP-TAPEMATIC Electric/Air Bench Machine (Portable)

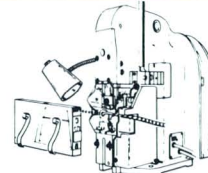

69875 AMP-TAPETRONIC All Electric Machine

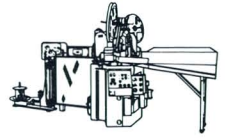

253086 AMPOMATOR Automatic Machine

					TAPE MOUNTED TOOLS					
Heads for 69011	Heads for 69012	Jaws for 68068	Dies for 69319-1	Dies for 69365, 69365-2, 69710 46110 (terms. only)	Dies for 69118-1	Dies for 69359-2	Dies for 69370	Dies for 68075	Dies for 69875	Dies for 253086 AMPOMATOR Machine
45155			69344	69344	69343	69343	69343-1 69724 ● 69343 △	69877	69877	
			69342	69342	69341	69341	69351 69341 △	69878	69878	69878
47498 47498-1 ●	46283		47806-2	47806-2	45185-7	45185-7 45185-8 ● (PIDG only)	45185-6 45185-7 △	69872 68208-1 (lg. exp.)	69872 68208-1 (lg. exp.)	69872 68208-1 (lg. exp.)
47499	46285		47807-1	47807-1	45225-7	45225-7	45225-6 45225-7 △	69873 68207-1 (lg. exp.)	69873 68207-1 (lg. exp.)	69873 68207-1 (lg. exp.)
	47500-1			47808-6 47808-5 (lg. exp.) not used in 46110		45228-5	45228-4 68863 (lg. exp.)	69874 69897 (lg. exp.)	69874 69897 (lg. exp.)	69874
							69343-1			
					45185-7	45185-7	45185-7 △ 45185-6	69872 68208-1 (lg. exp.)	69872 68208-1 (lg. exp.)	69872 68208-1 (lg. exp.)
					45225-7	45225-7	45225-7 △ 45225-6	69873 68207-1 (lg. exp.)	69873 68207-1 (lg. exp.)	69873 68207-1 (lg. exp.)
						45228-5	45228-5 △ 45228-4	69874 69897 (lg. exp.)	69874 69897 (lg. exp.)	69874
					45594-2	45594-2	45594-2 △	69902	69902	
47785 ■										
38790			46250-2	46250-2	45492-3	45492-3	45492-3 △ 45492-2 (for terminals only)	69903 68275-1	69903 68275-1	
			46251-2	46251-2	45595-3	45595-3	45595-3 △ 45595-2 (terms. only)	69904	69904	
				46252-2 (not used in 46110)		45596-3	45596-3 △ 45596-2	69905	69905	
								68108-1		
					69773	69773	69773	68119-1		
38788			47812	47812	45495	45495	45495	68096-1	69906	68240-1
38792		68232-1	47813	47813	45489	45489	45489	68097-1	69907	68241-1
				47815				69867	69867	
38799		68232-1		47814 (Str. wire only in 46110) 69819 (flag only in 69365 & 69710)				68220-1	68095	
						69461	69461	68098-1	69908	68242-1
								68259-1	68259-1	
								68094	68094	
								68260-1	68260-1	

Closed End Splice Tooling



45216, 46866, 45219, 45329
45330, 45324
Long Handle Tool

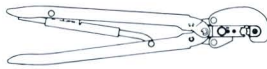

69335, 59499-1
Heavy Head Tool





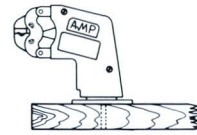







69710
Hand Tool



69011
AMPLI-PRESS



69005, 69010
Pneumatic

22-14	16-14	18-16	18-12	18-10
 Red BOMB-TAIL Vinyl	 Translucent Nylon	 Blue BOMB-TAIL Vinyl	 Translucent BOMB-TAIL Vinyl	 Translucent Nylon
	 Blue BOMB-TAIL Vinyl	 Translucent BOMB-TAIL Vinyl	 Translucent BOMB-TAIL Vinyl	 Purple BOMB-TAIL Vinyl
				 Translucent Nylon

LOOSE PIECE TOOLING

Wire Range	Voltage and Temperature Rating Code††	Hand Tools	Dies for Hand Tool 69710	Head for 69011	Head for 69005	Head for 69010	Dies for 46110	Dies for 69365 69365-2	Jaws for 68068-□
22-14	VS ECN	45216 ▲	45218	300024	45217		45218	45218	
18-16	ECV		69303-2 69303-3* 69820**					690303-2 690303-3* 69820**	
18-12	ECV EC	46866 ▲ 46866 ▲	46702-1 47811	46702-1	69430	46516 46516		46702-1 47811	
18-10	ECN, VS, ECV	45219 ▲	45221		37836†		45221	45221	
18-8	ECV	69335 ○				69244			68245-1
16-14	VS	45329 ▲ 45330 ▲ (Ins. Dia. .173)			45328		68022		
12-10	VS	45324 ▲ 59499-1 ○			45323	45325			
12-6	ECV								68268-1

†† VS — 300V, 90°C
ECV — 600V Max. Building Wiring — 1,000 V Max. Fixtures & Signs, 105°C UL, 90°C CSA
ECN — 300 V, 105°C
EC — 600 V Max. Building Wiring — 1,000 V Max. Fixtures & Signs, 105°C
* Wire loading
** With Insulation Crimp
† Loading for this head is 4,208 CMA
● For 18-12 Wire Range Only
▲ Long Handle
○ Heavy Head

Spare Wire Caps Tooling

Ins. Dia. or Wire Range	Hand Tools	T-Head Tools	Dies for 69118-1 69359-2 69370	Dies for 68075-1	Dies for 69875
.048-.080	46063		69250-1	68171-1	68165-1
.080-.120	46063		69251-1	68172-1	68166-1
.120-.150	46063		69252-1	68173-1	68167-1
.150-.225	46063		69253-1	68174-1	68168-1
22-18	47386	59250	69265-1	68175-1	68170-1
16-14	47387	59250	69259-1	68176-1	68169-1
12-10	59239-4				

Closed End Splice Tooling



46110
Pneumatic

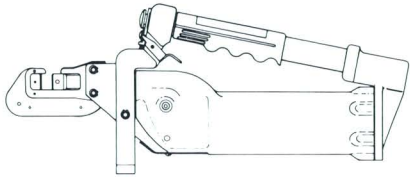

69365, 69365-2
Pneumatic

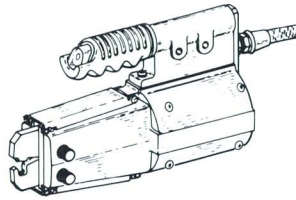

68068 as shown
68068-1 Side mount
handle
68068-3 can be
bench mounted —
foot pedal actuated

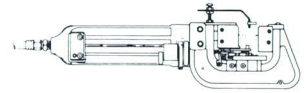

69118-1
Tape Mounted Tool

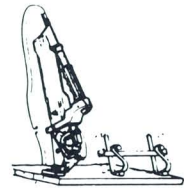

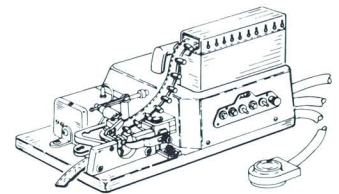

69359-2
Tape Mounted Tool

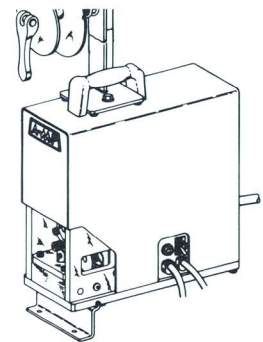

69370
Tape Mounted Tool



68075
Tape Mounted Tool

18-8  Green BOMB-TAIL Vinyl	12-10  Yellow BOMB-TAIL Vinyl	12-6  Blue BOMB-TAIL Vinyl
--	--	---

TAPE MOUNTED TOOLING

Wire Range	Voltage and Temperature Rating Code††	Dies for 69118-1	Dies for 69359-2	Dies for 69370	Dies for 68075-1	Dies for 69875
22-14	VS	69242-1	69242-1	69242-1	68137-1	69951
	ECN					
18-16	ECV		69949** 68052	69949** 68052	68138-1	69973
18-12	ECV				68087-1	69952
	EC		69836▲	69836▲	68087-1	69952
18-10	ECN		69946	69946	68076-1	69950
	VS, ECV		69958	69958	68076-1	69950

†† VS — 300V, 90°C
 ECV — 600V Max. Building Wiring — 1,000 V Max. Fixtures & Signs, 105°C UL, 90°C CSA
 ECN — 300 V, 105°C
 EC — 600 V Max. Building Wiring — 1,000 V Max. Fixtures & Signs, 105°C
 * Wire loading
 ** With Insulation Crimp
 † Loading for this head is 4,208 CMA
 ● For 18-12 Wire Range Only
 ▲ Long Handle
 ○ Heavy Head

Spare Wire Caps Tooling



47386
47387



59239-4



59250



69118-1

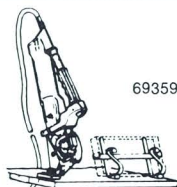

69359-2

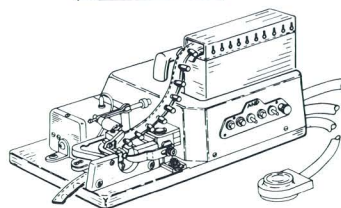

69370

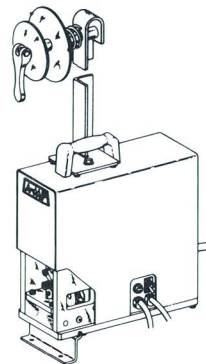



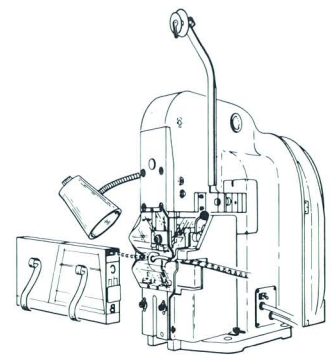

68075-1

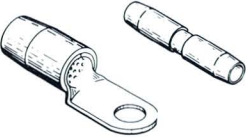

69875

Insulated Terminal and Splice Tooling 8 to 4/0 Wire Range

Description	Wire Size	Hydraulic Tools Use power unit 69120-□ or 69325		Pneumatic Tools		Tape Tools			Heavy Head Hand Tools
		Dies for 69051 69061	Dies for 69066 69998	Jaws for 68068 68068-1 68068-3	Heads for 69010	Dies for 68250-1	Dies for 69875	Dies for 253086-4	
PLASTI-GRIP 	8	48752-1 47820 •	48858-1 47236-1†	68229-1	69870	68247-1 •	68116-1	68116-1	69959
	6	48753-1 47821 •	48859-1 47237-1†	68233-1		68248-1 •			
	4	48754-1 47822 •	48860-1 47238-1†	68254-1		68249-1 •			
	2	48755-1 47823 •	48861-1 47239-1†						
	1/0		48756-1 47824 47378-1†						
	2/0		48757-1 47825 47379-1†						
	3/0		48758-1 47915 47380-1†						
	4/0		48759-1 47918 47668-1†						
AMPLI-BOND 	8	48752-1	48858-1 47236-1†		69870				69959
	6	48753-1	48859-1 47237-1†						
	4	48754-1	48860-1 47238-1†						
	2	48755-1	48861-1 47239-1†						
	1/0		48756-1 47378-1†						
	2/0		48757-1 47379-1†						
	3/0		48758-1 47380-1†						
	4/0		48759-1 47668-1†						
TERMINYL 	8	47820							
	6	47821							
	4	47822							
	2	47823							
	1/0		47824						
	2/0		47825						
	3/0		47915						
	4/0		47918						
Pre-Insulated Nylon H.D. 	8		69465						
	6		69464						
	4		69463						
	2		69462						
	1/0		69603						

• No insulation crimp † Large expansion

Heavy Head Hand Tool

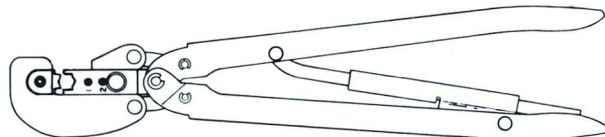

69959

Insulated Terminal and Splice Tooling 8 to 4/0 Wire Range

Pneumatic Tools

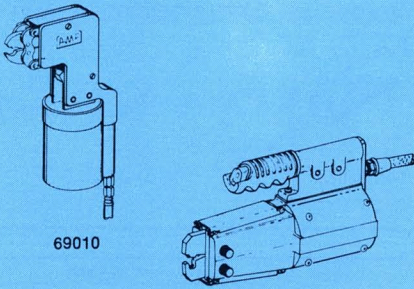

69010

- 68068 — As shown.
- 68068-1 — Handle mounted on side.
- 68068-3 — Foot pedal actuated. Can be bench mounted or suspended from counterbalance.
- 68068-4 — Vertical trigger at back of handle grip. Can be suspended from counterbalance.
- 68068-5 — Jaws normally closed. Time delay foot valve.

Tape Tools

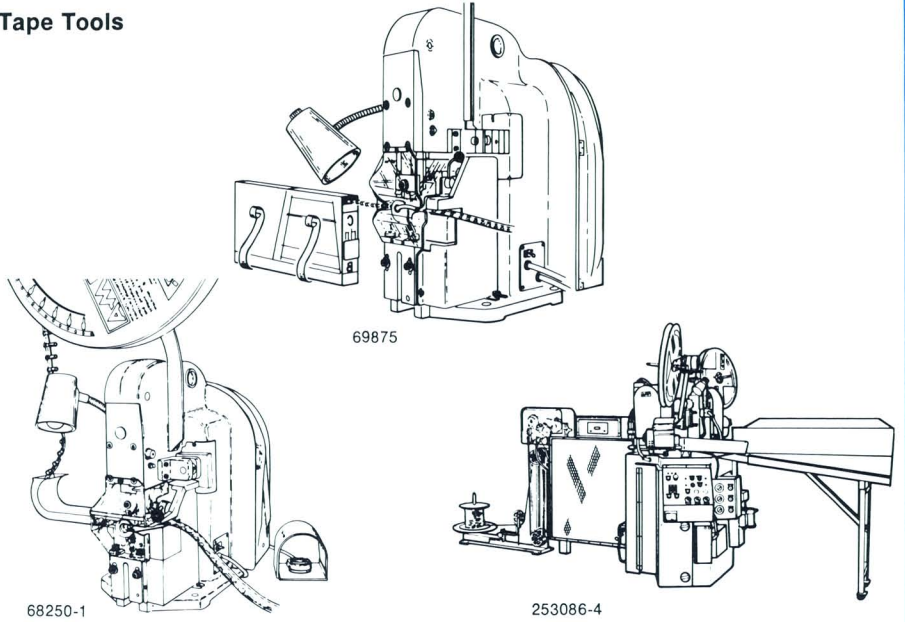

69875

68250-1

253086-4

Hydraulic Tools Power Units

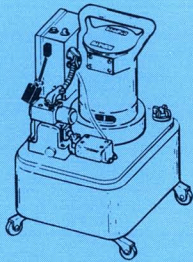

- Power Unit Only (Includes Pressure Release)
- 115 Volts (60 Hz) — 69120-1
 - 230 Volts (60 Hz) — 69120-2
 - 220 Volts (50 Hz) — 1-69120-0
 - 440 Volts (60 Hz) — 69120-4

- Power Unit Only (Includes Pressure Release: Use with Pressure Handle Control Assembly Only)
- 115 Volts (60 Hz) — 69120-9
 - 230 Volts (60 Hz) — 69120-7

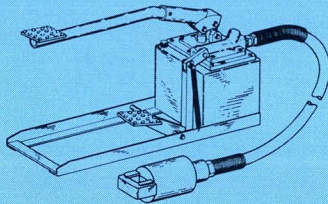

Foot Operated Power Unit
69325 (7' Hose)
69325-1 (15' Hose)

Power Unit Crimping Heads

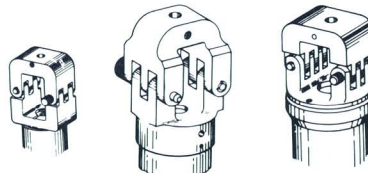

69051

69066

69993

Hand Tool

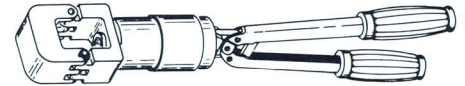

69061

Power Unit Accessories

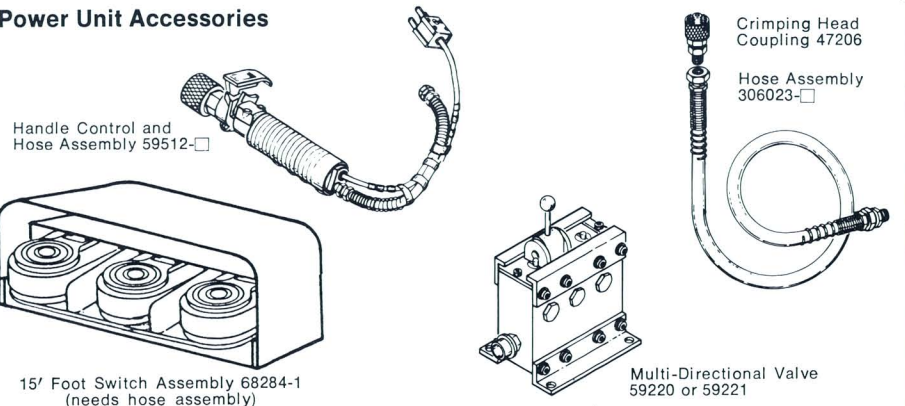

Handle Control and Hose Assembly 59512-□

15' Foot Switch Assembly 68284-1 (needs hose assembly)

Crimping Head Coupling 47206

Hose Assembly 306023-□

Multi-Directional Valve 59220 or 59221

Number	Description	Power Unit
59512-5	7' Handle Control Assembly — Hose and Cord	Pressure Release on Power Unit Only
59512-6	15' Handle Control Assembly — Hose and Cord	
59512-7	21' Handle Control Assembly — Hose and Cord	
59512-9	21' Handle Control Assembly — Cord (Less Hose)	
1-59512-5	28' Handle Control Assembly — Hose and Cord	
1-59512-7	50' Handle Control Assembly — Cord (Less Hose)	
68284-1	15' Foot Switch Assembly (needs hose assembly)	69120-1 69120-2 1-69120-0 69120-4
306023-4	3' Hose Assembly	Crimping Head Coupling 47206 needed with these hose assemblies
306023-1	7' Hose Assembly	
306023-2	15' Hose Assembly	
306023-3	21' Hose Assembly	
59220	3-Way Multi-Directional Valve	For use with Foot Switch only
59220-2	3-Way Multi-Directional Valve (Elec. Control)	
59221	6-Way Multi-Directional Valve	
59221-2	6-Way Multi-Directional Valve (Elec. Control)	
1-59512-3	7' Handle Control Assembly — Hose and Cord	Pressure Release on Handle and on Power Unit
1-59512-2	15' Handle Control Assembly — Hose and Cord	
1-59512-0	15' Handle Control Assembly — Cord (Less Hose)	
1-59512-1	21' Handle Control Assembly — Hose and Cord	
1-59512-6	21' Handle Control Assembly — Cord (Less Hose)	

Un-insulated Terminal and Splice Tooling 8 to 600 MCM Wire Range



Ring Terminal



Flag Terminal



Butt Splice



Parallel Splice

Wire Size	Hand Tool Part Nos.	MANUAL		HYDRAULIC						
		Dies for 69020, 69065		Dies for 69067		69062 69069 w/ Self Contained Dies	Dies for 69097		Dies for 69099	
		Nest	Indentor	Nest	Indentor		Nest	Indentor	Use adaptor No. 69760 for flag terms. only	Use adaptor No. 69834 for flag terms. only
8	69339 ◊ Str. Wire 69355 ◊ 69354-1 ◊ (Flag only) 600850 601075	48126	48355	48126 48506†	48355 48505†	69062 69069	46146	46145	48506-1† 69216	48505-1† 69216
8 H.D.	601260	48128-1	48127-1	48128-1	48127-1					
6	59125 ◊ 59083 ◊ (no ratchet) 600850 601075	48128	48127	48128 48508†	48127 48507†	69062 69069	46134	46133	48508-1† 69217	48507-1† 69217
6 H.D.	601260	48129-1	48127-1	48129-1	48127-1					
4	600850 601075	48129	48127	48129 48509†	48127 48507†	69062 69069	46135	46133	48509-1† 69218 45430	48507-1† 69218 45430
4 H.D.	601260	48130-1	48127-1	48130-1	48127-1					
2	600850 601075	48130	48127	48130 48510†	48127 48507†	69062 69069	46136	46133	48510-1† 45433	48507-1† 45433
2 H.D.	601260	48132-1	48131-1	48132-1	48131-1					
1/0	600850 601075	48132	48131	48132 48652†	48131 48511†		46138	46137	48652-1† 45439	48511-1† 45439
1/0 H.D.	601260	48133-1	48131-1	48133-1	48131-1					
2/0	600850	48133	48131	48133 48805†	48131 48511†				48805-1† 45439	48511-1† 45439
3/0	600850	48134	48131	48134 48806†	48131 48511†				48806-1† 45442	48511-1† 45442
4/0	600850	300430	48131	300430 48807†	48131 48511†				48807-1† 45445	48511-1† 45445

◊ Heavy Head
† For Flag Terminals

HYDRAULIC

Wire Size	Dies for 69060
250-300 MCM	48816
300-350 MCM	48817
400 MCM	48818
500-600 MCM	48819

Manual Hand Tools



Heavy Head
Hand Tools



ROTO-CRIMP
Hand Tools

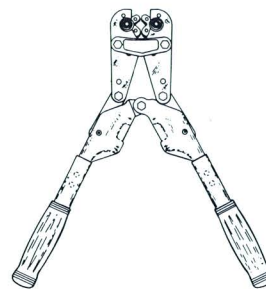

BANTAM ROTO-CRIMP
Hand Tools

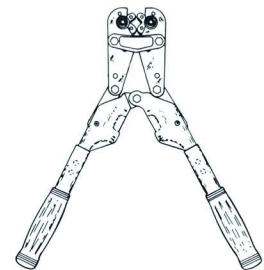

H.D. BANTAM ROTO-CRIMP
Hand Tools

Un-insulated Terminal and Splice Tooling 8 to 600 MCM Wire Range

Pneumatic Tools

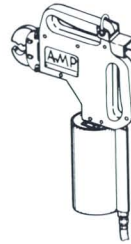
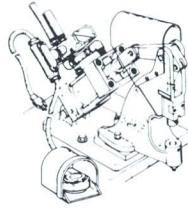
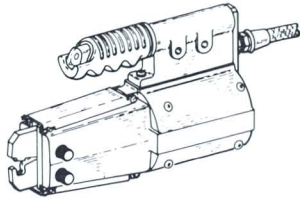

- 68068 — As shown
- 68068-1 — Handle mounted on side
- 68068-3 — Foot pedal actuated. Can be bench mounted or suspended from counterbalance.
- 68068-4 — Vertical trigger at back of handle grip. Can be suspended from counterbalance.
- 68068-5 — Jaws normally closed. Time delay foot valve.

PNEUMATIC

Wire Size	Jaws for 68068 68068-1 68068-3	Dies for 69004	Head for 69010	Head for 69015
8	68135	49346	38394	49596 48412† 47390*
6	68136		38923	48172 48413† 49940*
4				48173 48414† 49898*
2				48174 48415† 49897*
1/0				48183 48416† 48222*

†For Flag Terminals
*For Parallel Splices only

Hydraulic Tools Power Units

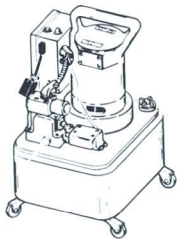

- Power Unit Only (includes Pressure Release)
- 115 Volts (60 Hz) — 69120-1
- 230 Volts (60 Hz) — 69120-2
- 220 Volts (50 Hz) — 1-69120-0
- 440 Volts (60 Hz) — 69120-4
- Power Unit Only (includes Pressure Release:
Use with Pressure Handle Control Assembly only)
- 115 Volts (60 Hz) — 69120-9
- 230 Volts (60 Hz) — 69120-7

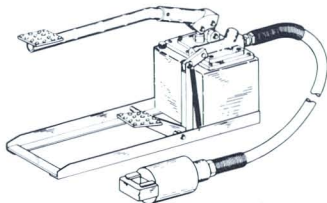

Foot Operated
Power Unit
69325 (7' Hose)
69325-1 (15' Hose)

Hand Tools

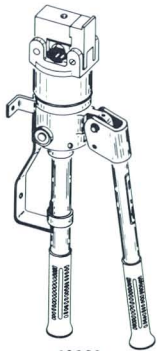

69020
Hydraulic Hand Tool
Requires Dies

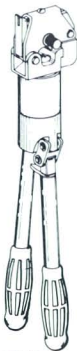

69062
Hydraulic Hand Tool
Self Contained Dies

Power Unit Crimping Heads

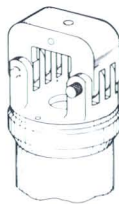

69060

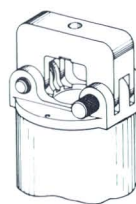

69065

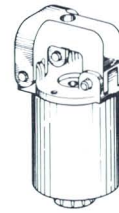

69067



69069



69097



69099

Power Unit Accessories

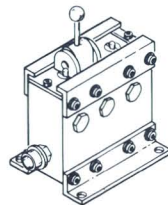

Multi-Directional Valve
59220 or 59221

Handle Control and
Hose Assembly 59512-□

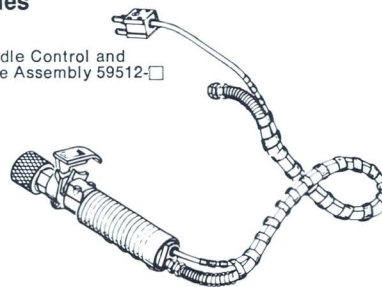

Crimping Head
Coupling 47206

Hose Assembly
306023-□

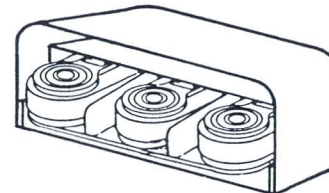
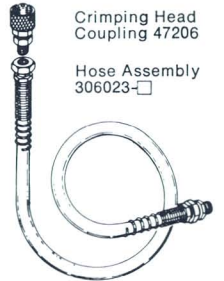

15' Foot Switch Assembly
68284-1
(needs hose assembly)

Number	Description	Power Unit
59512-5	7' Handle Control Assembly — Hose and Cord	
59512-6	15' Handle Control Assembly — Hose and Cord	
59512-7	21' Handle Control Assembly — Hose and Cord	Pressure Release on Power Unit Only
59512-9	21' Handle Control Assembly — Cord (Less Hose)	
1-59512-5	28' Handle Control Assembly — Hose and Cord	
1-59512-7	50' Handle Control Assembly — Cord (Less Hose)	
68284-1	15' Foot Switch Assembly (needs hose assembly)	69120-1 69120-2 1-69120-0 69120-4
306023-4	3' Hose Assembly	47206
306023-1	7' Hose Assembly	
306023-2	15' Hose Assembly	
306023-3	21' Hose Assembly	
Crimping Head Coupling needed with these hose assemblies		
59220	3-Way Multi-Directional Valve	
59220-2	3-Way Multi-Directional Valve (Elec. Control)	For use with Foot Switch only
59221	6-Way Multi-Directional Valve	
59221-2	6-Way Multi-Directional Valve (Elec. Control)	
1-59512-3	7' Handle Control Assembly — Hose and Cord	Pressure Release on Handle and on Power Unit
1-59512-2	15' Handle Control Assembly — Hose and Cord	
1-59512-0	15' Handle Control Assembly — Cord (Less Hose)	69120-9
1-59512-1	21' Handle Control Assembly — Hose and Cord	69120-7
1-59512-6	21' Handle Control Assembly — Cord (Less Hose)	

AMPOWER Terminals and Splices

Introduction

AMP's Formulated AMPOWER Terminal Crimp Method

Stud Size Dimensions

(For selection of proper size terminal)

Terminals and Splices for rectangular, round, solid or stranded copper conductors, or combination in a wire size range from 6 AWG through 1,125 MCM, 1250 Butt Splices.

AMP's line of AMPOWER terminals and splices combine a number of features not found in any other line. Because of these features the AMPOWER product line offers great flexibility and reliability at a consistently lower cost.

The most important features of this line are (1) double-thick tongue; (2) ability to accommodate solid, stranded, rectangular or combinations of conductors; (3) the large wire

AMP's compression crimping method of terminating electrical wires is an exact science. The application technique is purely mechanical and therefore completely controllable. For this reason it is also uniform from first to last crimp. Variables common to other methods such as melting temperature, flux composition, entrapped gases, heat deformation of conductors, oxidation, and the like are eliminated. The termination resulting from this method offers greater tensile strength and a higher conductivity than any other type of termination. AMPOWER terminals and splices (with the exception of #6 and #4 AWG splices) are made of

size range accepted — up to 1,125 MCM, 1250 Butt Splice; and (4) the low installed cost. In addition, all the compression crimp features that have made AMP a byword in terminal design, quality and engineering are present in AMPOWER terminals and splices.

Admirably suited to the power generation and distribution industry and related original electrical equipment manufacturers, AMPOWER products are especially designed for large power cables and leads. Specific applications include generators, motors, transformers, industrial controls, welders, and other electrical equipment subject to continuous operation over long periods of time.

the highest quality seamless tubular copper to assure maximum conductivity. AMP's special tin-plating process inhibits corrosion, assuring long, trouble-free service. AMP's special die-stamping process converts the copper tube into a double-thickness rectangular tongue with a short, strong transfer section. These factors combine with AMP's formulated AMPOWER terminal crimp to produce maximum conductivity and maximum strength.

In short, the AMP crimping technique assures quicker, easier-to-make terminations of uniformly high reliability at low cost.

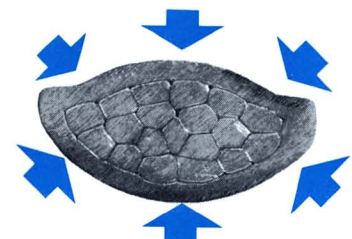
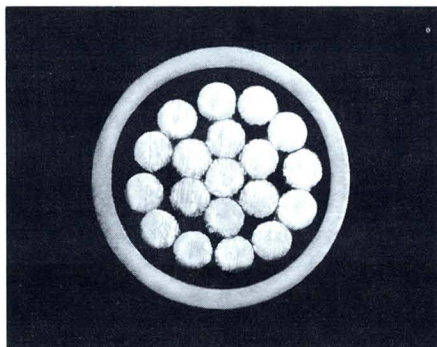

STUD SIZE	STUD DIAMETER	TERMINAL STUD HOLE DIAMETER
10	.190	.197
1/4	.250	.265
5/16	.312	.328
3/8	.375	.390
7/16	.437	.453
1/2	.500	.515

STUD SIZE	STUD DIAMETER	TERMINAL STUD HOLE DIAMETER
5/8	.625	.656
3/4	.750	.781
7/8	.875	.906
1	1.000	1.031
1 1/8	1.125	1.156
1 1/4	1.250	1.281

AMP application tools are designed to produce a carefully controlled, uniform pressure crimp regardless of how they are powered. All tools feature matching dies that fully "bottom" at the completion of the crimp, thereby assuring proper crimp height. All tools shown are specifically designed for AMP Products and are precision machined of hardest tool steel for AMP's exclusive crimp termination of terminals or splices.

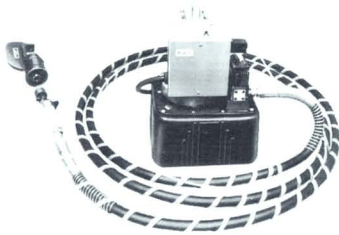

Electro-Hydraulic Tool

Power Unit Only
(Includes Pressure Release)
115 Volts — 69120-1
230 Volts — 69120-2
220 Volts — 1-69120-0

Power Unit Only
(Includes Pressure Release: Use with Pressure Release Handle Control Assembly Only)
115 Volts — 69120-9
230 Volts — 69120-7

The DYNA-CRIMP Power Unit can be equipped with various heads and dies for terminating AMPOWER products in wire ranges from No. 6 to 1250 MCM. A complete line of accessories is also available with the tool permitting its use in portable and stationary applications as well as for multi-head crimping.

Foot Operated Tool

69325 Includes 7' hose
69325-1 Includes 15' hose

These tools are designed for intermittent service on location where outside power sources are not available.



Pneumatic Tool

No. 69015 — Wire Size 2
Head No. 68179-1



69097



69099



69082



68073-1



69060



69065

DYNA-CRIMP Tool Head and Dies

Head No.	Wire Size	Single Position Dies	Dual Position Dies*	
69097	6	—	45254-2	
	4	—	45257-2	
	2	46521-2	46874-2	
	1/0	46522-2	46875-2	
	2/0	46523-2	46876-2	
	6	69133-1	—	
	4	69134-1	—	
	2	46765-2	46883-2	
	1/0	46766-2	46884-2	
	2/0	46767-2	46885-2	
69099	3/0	46749-2	46886-2	
	4/0	46750-2	46887-2	
	250 MCM	46751-2	46888-2	
	300 MCM	46752-2	46889-2	
	350 MCM	46753-2	46890-2	
	350 MCM	69653	—	
	400 MCM	46754-2	45100-2	
	500 MCM	46755-2	45101-2	
	600 MCM	46756-2†	—	
	700 MCM	46757-2†	45103†	
69082	800 MCM	46758-2†	—	
	900 MCM	46759-2†	—	
	1000 MCM	46760-2†	—	
	68073-1	1250 MCM	68114-1†	—
	69060	250 MCM	46326-2	—
		300 MCM	46327-2	—
	69065	2	46321-2	—
		1/0	46322-2	—
		2/0	46323-2	—
		3/0	46324-2	—
	4/0	46325-2	—	

†Dual crimp dies.

*Dual position AMPOWER Dies were developed for stub applications of AMPOWER Parallel Splices. However, with the versatility of positioning they will function properly on AMPOWER Terminals, Parallel and Butt Splices.

Note: Terminals and splices, wire sizes 600 MCM through 1250 MCM, require two crimps for optimum mechanical and electrical performance.

Accessories

Number	Description	
59512-5	7' Handle Control Assembly — Hose and Cord	Pressure Release on Power Unit
59512-6	15' Handle Control Assembly — Hose and Cord	
59512-7	21' Handle Control Assembly — Hose and Cord	
59512-9	21' Handle Control Assembly — Cord (Less Hose)	
1-59512-5	28' Handle Control Assembly — Hose and Cord	
1-59512-3	7' Handle Control Assembly — Hose and Cord	Pressure Release Handle
1-59512-2	15' Handle Control Assembly — Hose and Cord	
1-59512-0	15' Handle Control Assembly — Cord (Less Hose)	
1-59512-1	21' Handle Control Assembly — Hose and Cord	
1-59512-6	21' Handle Control Assembly — Cord (Less Hose)	
303775	7' Foot Switch Assembly (needs hose assembly)	
303776	15' Foot Switch Assembly (needs hose assembly)	
303777	21' Foot Switch Assembly (needs hose assembly)	
306023-4	3' Hose Assembly	47206 Crimping Head Coupling needed with these hose assemblies
306023-1	7' Hose Assembly	
306023-2	15' Hose Assembly	
306023-3	21' Hose Assembly	
59220	3-Way Multi-Directional Valve	For use with Foot Switch only
59220-2	3-Way Multi-Directional Valve (Elec. Control)	
59221	6-Way Multi-Directional Valve	
59221-2	6-Way Multi-Directional Valve (Elec. Control)	

AMPOWER Terminals

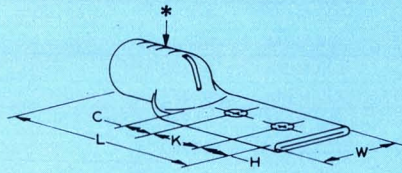
TWO STUD HOLE $\frac{3}{8}$ " Hole, 1" centers
Wire Size: 2 AWG TO 1000 MCM

Part No.	Wire Size	Wire Range	Stud Size	K	Barrel I.D. Min.	L Max.	H Max.	C Min.	W Max.	Tongue Thk. Max.
326799	2	52,600-83,700 CM	$\frac{3}{8}$	1.000	.372	2.60	.34	.50	.69	.09
326800	1/0	83,700-119,500 CM	$\frac{3}{8}$	1.000	.468	2.95	.42	.62	.85	.10
326801	2/0	119,500-150,500 CM	$\frac{3}{8}$	1.000	.523	3.09	.47	.62	.95	.11
326802	3/0	150,500-190,000 CM	$\frac{3}{8}$	1.000	.586	3.24	.52	.62	1.06	.12
326803	4/0	190-231 MCM	$\frac{3}{8}$	1.000	.658	3.41	.59	.62	1.17	.13
326804	250	231-275 MCM	$\frac{3}{8}$	1.000	.700	3.54	.63	.62	1.26	.15
326805	300	275-325 MCM	$\frac{3}{8}$	1.000	.768	3.65	.63	.62	1.38	.16
326806	350	325-375 MCM	$\frac{3}{8}$	1.000	.829	3.74	.63	.62	1.49	.17
326807	400	375-450 MCM	$\frac{3}{8}$	1.000	.886	3.85	.63	.62	1.59	.18
326808	500	450-550 MCM	$\frac{3}{8}$	1.000	.991	4.00	.63	.62	1.78	.20
326809*	600	550-650 MCM	$\frac{3}{8}$	1.000	1.085	4.15	.63	.62	1.95	.22
326810*	700	650-750 MCM	$\frac{3}{8}$	1.000	1.172	4.28	.63	.62	2.10	.23
326811*	800	750-850 MCM	$\frac{3}{8}$	1.000	1.252	4.41	.63	.62	2.24	.25
326812*	900	850-950 MCM	$\frac{3}{8}$	1.000	1.328	4.53	.63	.62	2.37	.27
326813*	1000	950-1125 MCM	$\frac{3}{8}$	1.000	1.400	4.82	.63	.81	2.51	.28

*Two Crimps Necessary.

TWO STUD HOLE (NEMA TYPE) $\frac{1}{2}$ " Hole, $1\frac{1}{4}$ " centers
Wire Size: 1/0 AWG TO 1000 MCM

Part No.	Wire Size	Wire Range	Stud Size	K	Barrel I.D. Min.	L Max.	H Max.	C Min.	W Max.	Tongue Thk. Max.
327281	1/0	83,700-119,500 CM	$\frac{1}{2}$	1.750	.468	3.69	.42	.62	.84	.10
327282	2/0	119,500-150,500 CM	$\frac{1}{2}$	1.750	.523	3.83	.47	.62	.94	.11
327283	3/0	150,500-190,000 CM	$\frac{1}{2}$	1.750	.586	3.99	.52	.62	1.05	.12
327284	4/0	190-231 MCM	$\frac{1}{2}$	1.750	.658	4.15	.58	.62	1.17	.13
327285	250	231-275 MCM	$\frac{1}{2}$	1.750	.700	4.28	.62	.62	1.26	.14
327286	300	275-325 MCM	$\frac{1}{2}$	1.750	.768	4.40	.63	.62	1.38	.15
327287	350	325-375 MCM	$\frac{1}{2}$	1.750	.829	4.49	.63	.62	1.49	.17
327288	400	375-450 MCM	$\frac{1}{2}$	1.750	.886	4.59	.63	.62	1.59	.18
327289	500	450-550 MCM	$\frac{1}{2}$	1.750	.991	4.75	.63	.62	1.78	.20
327290*	600	550-650 MCM	$\frac{1}{2}$	1.750	1.085	4.89	.63	.62	1.94	.22
327291*	700	650-750 MCM	$\frac{1}{2}$	1.750	1.172	5.03	.63	.62	2.10	.23
327292*	800	750-850 MCM	$\frac{1}{2}$	1.750	1.252	5.15	.63	.62	2.24	.25
327293*	900	850-950 MCM	$\frac{1}{2}$	1.750	1.328	5.28	.63	.62	2.37	.26
327294*	1000	950-1125 MCM	$\frac{1}{2}$	1.750	1.400	5.57	.63	.81	2.50	.28

*Two Crimps Necessary.

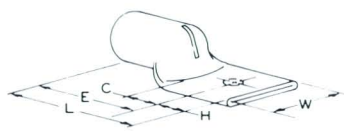

Style A



Style B



Style C

6 AWG Wire Range: 20,800-33,100 CM
Tongue Thickness .07 Max. Barrel I.D. .229 Min.

Part No.	Stud Size	Style	L Max.	W Max.	C Min.	H Max.	F Max.	E Max.
328140	—	B	1.38	.67	—	—	.75	—
328141	10	A	1.38	.67	.42	.32	—	1.06
328142	1/4	A	1.38	.67	.42	.32	—	1.06
328143	3/16	A	1.38	.67	.42	.32	—	1.06
328144	3/8	A	1.38	.67	.42	.32	—	1.06
328158	1/2	C	1.43	.77	.43	.38	—	1.05

4 AWG Wire Range: 33,100-52,600 CM
Tongue Thickness .09 Max. Barrel I.D. .285 Min.

Part No.	Stud Size	Style	L Max.	W Max.	C Min.	H Max.	F Max.	E Max.
328160	—	B	1.38	.67	—	—	.76	—
328161	10	A	1.38	.67	.42	.32	—	1.06
328162	1/4	A	1.38	.67	.42	.32	—	1.06
328163	3/16	A	1.38	.67	.42	.32	—	1.06
328164	3/8	A	1.38	.67	.42	.32	—	1.06
328178	1/2	C	1.43	.77	.43	.38	—	1.05

2 AWG Wire Range: 52,600-83,700 CM
Tongue Thickness .09 Max. Barrel I.D. .372 Min.

Part No.	Stud Size	Style	L Max.	W Max.	C Min.	H Max.	F Max.	E Max.
325200	—	B	1.59	.69	—	—	.87	—
325201	1/4	A	1.59	.69	.50	.34	—	1.25
325202	3/16	A	1.59	.69	.50	.34	—	1.25
325203	3/8	A	1.59	.69	.50	.34	—	1.25
325207	—	B	2.59	.69	—	—	1.87	—
325250	1/2	C	1.70	.78	.55	.41	—	1.29
325251	1/2	C	1.79	.78	.62	.42	—	1.37

1/0 AWG Wire Range: 83,700-119,500 CM
Tongue Thickness .10 Max. Barrel I.D. .468 Min.

Part No.	Stud Size	Style	L Max.	W Max.	C Min.	H Max.	F Max.	E Max.
325300	—	B	1.94	.85	—	—	1.08	—
325301	1/4	A	1.94	.85	.62	.42	—	1.52
325302	3/16	A	1.94	.85	.62	.42	—	1.52
325303	3/8	A	1.94	.85	.62	.42	—	1.52
325304	7/16	A	1.94	.85	.62	.42	—	1.52
325305	1/2	A	1.94	.85	.62	.42	—	1.52
325306	—	B	3.69	.85	—	—	2.83	—
325307	1/2	A	2.01	.85	.70	.42	—	1.59
325308	—	B	2.94	.85	—	—	2.08	—
325350	5/8	C	2.14	.97	.75	.50	—	1.64

2/0 AWG Wire Range: 119,500-150,500 CM
Tongue Thickness .11 Max. Barrel I.D. .523 Min.

Part No.	Stud Size	Style	L Max.	W Max.	C Min.	H Max.	F Max.	E Max.
325400	—	B	2.08	.95	—	—	1.13	—
325401	1/4	A	2.08	.95	.62	.47	—	1.61
325402	3/16	A	2.08	.95	.62	.47	—	1.61
325403	3/8	A	2.08	.95	.62	.47	—	1.61
325404	7/16	A	2.08	.95	.62	.47	—	1.61
325405	1/2	A	2.08	.95	.62	.47	—	1.61
325406	—	B	3.83	.95	—	—	2.88	—
325450	5/8	C	2.28	1.08	.75	.54	—	1.74

AMPOWER Terminals

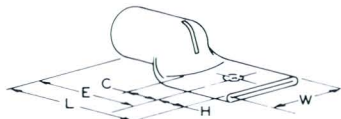

Style A



Style B



Style C

3/0 AWG Wire Range: 150,500-190,000 CM
Tongue Thickness .12 Max. Barrel I.D. .586 Min.

Part No.	Stud Size	Style	L Max.	W Max.	C Min.	H Max.	F Max.	E Max.
325500	—	B	2.23	1.06	—	—	1.18	—
325501	1/4	A	2.23	1.06	.62	.52	—	1.71
325502	5/16	A	2.23	1.06	.62	.52	—	1.71
325503	3/8	A	2.23	1.06	.62	.52	—	1.71
325504	7/16	A	2.23	1.06	.62	.52	—	1.71
325505	1/2	A	2.23	1.06	.62	.52	—	1.71
325506	—	B	2.36	1.06	—	—	1.31	—
325507	5/8	A	2.36	1.06	.75	.52	—	1.84
325508	—	B	3.99	1.06	—	—	2.94	—
325509	—	B	3.24	1.06	—	—	2.19	—

4/0 AWG Wire Range: 190,000-231,000 CM
Tongue Thickness .13 Max. Barrel I.D. .658 Min.

Part No.	Stud Size	Style	L Max.	W Max.	C Min.	H Max.	F Max.	E Max.
325600	—	B	2.40	1.17	—	—	1.24	—
325601	1/4	A	2.40	1.17	.62	.59	—	1.82
325602	5/16	A	2.40	1.17	.62	.59	—	1.82
325603	3/8	A	2.40	1.17	.62	.59	—	1.82
325604	7/16	A	2.40	1.17	.62	.59	—	1.82
325605	1/2	A	2.40	1.17	.62	.59	—	1.82
325606	—	B	2.53	1.17	—	—	1.37	—
325607	5/8	A	2.53	1.17	.75	.59	—	1.94
325608	—	B	2.71	1.17	—	—	1.56	—
325609	3/4	A	2.71	1.17	.93	.59	—	2.13
325610	—	B	4.16	1.17	—	—	3.00	—

250 MCM Wire Range: 231-275 MCM
Tongue Thickness .15 Max. Barrel I.D. .70 Min.

Part No.	Stud Size	Style	L Max.	W Max.	C Min.	H Max.	F Max.	E Max.
325700	—	B	2.53	1.26	—	—	1.28	—
325701	1/4	A	2.53	1.26	.62	.63	—	1.91
325702	5/16	A	2.53	1.26	.62	.63	—	1.91
325703	3/8	A	2.53	1.26	.62	.63	—	1.91
325704	7/16	A	2.53	1.26	.62	.63	—	1.91
325705	1/2	A	2.53	1.26	.62	.63	—	1.91
325706	—	B	2.65	1.26	—	—	1.41	—
325707	5/8	A	2.65	1.26	.75	.63	—	2.03
325708	—	B	2.84	1.26	—	—	1.59	—
325709	3/4	A	2.84	1.26	.93	.63	—	2.22
325712	—	B	4.79	1.26	—	—	3.54	—
325716	—	B	3.57	1.26	—	—	2.29	—
325750	7/8	C	3.10	1.38	1.12	.70	—	2.40

300 MCM. Wire Range: 275-325 CM
Tongue Thickness .16 Max. Barrel I.D. .768 min.

Part No.	Stud Size	Style	L Max.	W Max.	C Min.	H Max.	F Max.	E Max.
325800	—	B	2.64	1.38	—	—	1.29	—
325801	1/4	A	2.64	1.38	.62	.63	—	2.01
325802	5/16	A	2.64	1.38	.62	.63	—	2.01
325803	3/8	A	2.64	1.38	.62	.63	—	2.01
325804	7/16	A	2.64	1.38	.62	.63	—	2.01
325805	1/2	A	2.64	1.38	.62	.63	—	2.01
325806	—	B	2.77	1.38	—	—	1.42	—
325807	5/8	A	2.77	1.38	.75	.63	—	2.14
325808	—	B	2.95	1.38	—	—	1.60	—
325809	3/4	A	2.95	1.38	.93	.63	—	2.32
325810	—	B	3.14	1.38	—	—	1.79	—
325811	7/8	A	3.14	1.38	1.12	.63	—	2.51
325815	—	B	3.39	1.38	—	—	2.04	—
325816	—	B	5.10	1.38	—	—	3.75	—
325850	1"	C	3.41	1.50	1.25	.78	—	2.63

AMPOWER Terminals

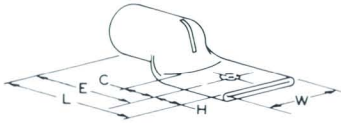

Style A

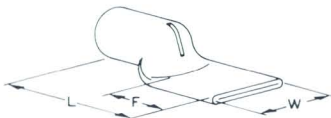

Style B

350 MCM Wire Range: 325-375 MCM
Tongue Thickness .17 Max. Barrel I.D. .829 Min.

Part No.	Stud Size	Style	L Max.	W Max.	C Min.	H Max.	F Max.	E Max.
325900	—	B	2.74	1.49	—	—	1.29	—
325901	1/4	A	2.74	1.49	.62	.63	—	2.11
325902	5/16	A	2.74	1.49	.62	.63	—	2.11
325903	3/8	A	2.74	1.49	.62	.63	—	2.11
325904	7/16	A	2.74	1.49	.62	.63	—	2.11
325905	1/2	A	2.74	1.49	.62	.63	—	2.11
325906	—	B	2.86	1.49	—	—	1.42	—
325907	5/8	A	2.86	1.49	.75	.63	—	2.23
325908	—	B	3.05	1.49	—	—	1.60	—
325809	3/4	A	3.05	1.49	.93	.63	—	2.42
325910	—	B	3.24	1.49	—	—	1.79	—
325911	7/8	A	3.24	1.49	1.12	.63	—	2.61
325912	—	B	3.49	1.49	—	—	2.04	—
325913	1"	A	3.49	1.49	1.25	.76	—	2.73
325917	—	B	4.42	1.49	—	—	3.05	—

400 MCM Wire Range: 375-450 MCM
Tongue Thickness .18 Max. Barrel I.D. .886 Min.

Part No.	Stud Size	Style	L Max.	W Max.	C Min.	H Max.	F Max.	E Max.
326000	—	B	2.84	1.59	—	—	1.29	—
326001	1/4	A	2.84	1.59	.62	.63	—	2.21
326002	5/16	A	2.84	1.59	.62	.63	—	2.21
326003	3/8	A	2.84	1.59	.62	.63	—	2.21
326004	7/16	A	2.84	1.59	.62	.63	—	2.21
326005	1/2	A	2.84	1.59	.62	.63	—	2.21
326006	—	B	2.96	1.59	—	—	1.42	—
326007	5/8	A	2.96	1.59	.75	.63	—	2.33
326008	—	B	3.15	1.59	—	—	1.60	—
326009	3/4	A	3.15	1.59	.93	.63	—	2.52
326010	—	B	3.46	1.59	—	—	1.92	—
326011	7/8	A	3.46	1.59	1.12	.76	—	2.71
326012	—	B	3.59	1.59	—	—	2.04	—
326013	1"	A	3.59	1.59	1.25	.76	—	2.83
326016	—	B	4.83	1.59	—	—	3.29	—

500 MCM Wire Range: 450-550 MCM
Tongue Thickness .20 Max. Barrel I.D. .991 Min.

Part No.	Stud Size	Style	L Max.	W Max.	C Min.	H Max.	F Max.	E Max.
326100	—	B	3.24	1.78	—	—	1.54	—
326101	1/4	A	3.24	1.78	.75	.76	—	2.48
326102	5/16	A	3.24	1.78	.75	.76	—	2.48
326103	3/8	A	3.24	1.78	.75	.76	—	2.48
326104	7/16	A	3.24	1.78	.75	.76	—	2.48
326105	1/2	A	3.24	1.78	.75	.76	—	2.48
326106	5/8	A	3.24	1.78	.75	.76	—	2.48
326107	—	B	3.43	1.78	—	—	1.72	—
326108	3/4	A	3.43	1.78	.93	.76	—	2.67
326109	—	B	3.61	1.78	—	—	1.91	—
326110	7/8	A	3.61	1.78	1.12	.76	—	2.85
326111	—	B	3.74	1.78	—	—	2.04	—
326112	1"	A	3.74	1.78	1.25	.76	—	2.98
326113	—	B	3.99	1.78	—	—	2.29	—
326114	1 1/8	A	3.99	1.78	1.37	.88	—	3.11
326117	—	B	4.95	1.78	—	—	3.25	—

AMPOWER Terminals



Style B

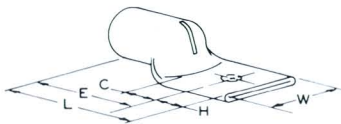

Style A

600 MCM Wire Range: 550-650 MCM
Tongue Thickness .22 Max. Barrel I.D. 1.085 Min.

Part No.	Stud Size	Style	L Max.	W Max.	C Min.	H Max.	F Max.	E Max.
326200	—	B	3.39	1.94	—	—	1.54	—
326201	1/4	A	3.39	1.94	.75	.76	—	2.63
326202	5/16	A	3.39	1.94	.75	.76	—	2.63
326203	3/8	A	3.39	1.94	.75	.76	—	2.63
326204	7/16	A	3.39	1.94	.75	.76	—	2.63
326205	1/2	A	3.39	1.94	.75	.76	—	2.63
326206	5/8	A	3.39	1.94	.75	.76	—	2.63
326207	—	B	3.57	1.94	—	—	1.72	—
326208	3/4	A	3.57	1.94	.93	.76	—	2.81
326209	—	B	3.76	1.94	—	—	1.91	—
326210	7/8	A	3.76	1.94	1.12	.76	—	3.00
326211	—	B	4.01	1.94	—	—	2.16	—
326212	1"	A	4.01	1.94	1.25	.88	—	3.13
326213	—	B	4.14	1.94	—	—	2.29	—
326214	1 1/8	A	4.14	1.94	1.37	.88	—	3.26
326215	—	B	4.39	1.94	—	—	2.54	—
326216	1 1/4	A	4.39	1.94	1.50	1.01	—	3.38
326217	—	B	5.10	1.94	—	—	3.25	—

*Two Crimps Necessary on All Above Items.

700 MCM Wire Range 650-750 MCM
Tongue Thickness .23 Max. Barrel I.D. 1.172 Min.

Part No.	Stud Size	Style	L Max.	W Max.	C Min.	H Max.	F Max.	E Max.
326300	—	B	3.52	2.10	—	—	1.54	—
326301	1/4	A	3.52	2.10	.75	.76	—	2.76
326302	5/16	A	3.52	2.10	.75	.76	—	2.76
326303	3/8	A	3.52	2.10	.75	.76	—	2.76
326304	7/16	A	3.52	2.10	.75	.76	—	2.76
326305	1/2	A	3.52	2.10	.75	.76	—	2.76
326306	5/8	A	3.52	2.10	.75	.76	—	2.76
326307	—	B	3.71	2.10	—	—	1.72	—
326308	3/4	A	3.71	2.10	.93	.76	—	2.95
326309	—	B	3.89	2.10	—	—	1.91	—
326310	7/8	A	3.89	2.10	1.12	.76	—	3.13
326311	—	B	4.14	2.10	—	—	2.16	—
326312	1"	A	4.14	2.10	1.25	.88	—	3.26
326313	—	B	4.27	2.10	—	—	2.29	—
326314	1 1/8	A	4.27	2.10	1.37	.88	—	3.39
326315	—	B	4.52	2.10	—	—	2.54	—
326316	1 1/4	A	4.52	2.10	1.50	1.01	—	3.51
326319	—	B	5.02	2.10	—	3.04	—	—

*Two Crimps Necessary on All Above Items.

800 MCM Wire Range: 750-850 MCM
Tongue Thickness .25 Max. Barrel I.D. 1.252 Min.

Part No.	Stud Size	Style	L Max.	W Max.	C Min.	H Max.	F Max.	E Max.
326400	—	B	3.65	2.24	—	—	1.54	—
326401	1/4	A	3.65	2.24	.75	.76	—	2.89
326402	5/16	A	3.65	2.24	.75	.76	—	2.89
326403	3/8	A	3.65	2.24	.75	.76	—	2.89
326404	7/16	A	3.65	2.24	.75	.76	—	2.89
326405	1/2	A	3.65	2.24	.75	.76	—	2.89
326406	5/8	A	3.65	2.24	.75	.76	—	2.89
326407	—	B	3.83	2.24	—	—	1.72	—
326408	3/4	A	3.83	2.24	.93	.76	—	3.07
326409	—	B	4.15	2.24	—	—	2.04	—
326410	7/8	A	4.15	2.24	1.12	.88	—	3.27
326411	—	B	4.27	2.24	—	—	2.16	—
326412	1"	A	4.27	2.24	1.25	.88	—	3.39
326413	—	B	4.40	2.24	—	—	2.29	—
326414	1 1/8	A	4.40	2.24	1.37	.88	—	3.52
326415	—	B	4.65	2.24	—	—	2.54	—
326416	1 1/4	A	4.65	2.24	1.50	1.01	—	3.64

*Two Crimps Necessary on All Above Items.

AMPOWER Terminals

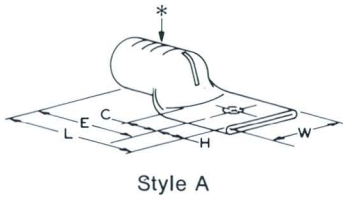

Style A

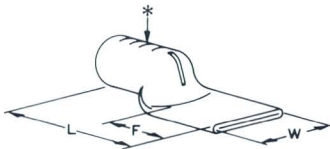

Style B

900 MCM Wire Range: 850-950 MCM Tongue Thickness .26 Max. Barrel I.D. 1.328 Min.

Part No.	Stud Size	Style	L Max.	W Max.	C Min.	H Max.	F Max.	E Max.
326500	—	B	3.77	2.37	—	—	1.54	—
326501	1/4	A	3.77	2.37	.75	.76	—	3.01
326502	3/16	A	3.77	2.37	.75	.76	—	3.01
326503	3/8	A	3.77	2.37	.75	.76	—	3.01
326504	7/16	A	3.77	2.37	.75	.76	—	3.01
326505	1/2	A	3.77	2.37	.75	.76	—	3.01
326506	5/8	A	3.77	2.37	.75	.76	—	3.01
326507	—	B	3.96	2.37	—	—	1.72	—
326508	3/4	A	3.96	2.37	.93	.76	—	3.20
326509	—	B	4.27	2.37	—	—	2.04	—
326510	7/8	A	4.27	2.37	1.12	.88	—	3.39
326511	—	B	4.39	2.37	—	—	2.16	—
326512	1"	A	4.39	2.37	1.25	.88	—	3.51
326513	—	B	4.64	2.37	—	—	2.41	—
326514	1 1/8	A	4.64	2.37	1.37	1.01	—	3.63
326515	—	B	4.77	2.37	—	—	2.54	—
326516	1 1/4	A	4.77	2.37	1.50	1.01	—	3.76

*Two Crimps Necessary on All Above Items.

1000 MCM Wire Range: 950-1125 MCM Tongue Thickness .28 Max. Barrel I.D. 1.400 Min.

Part No.	Stud Size	Style	L Max.	W Max.	C Min.	H Max.	F Max.	E Max.
326600	—	B	4.25	2.50	—	—	1.91	—
326601	1/4	A	4.25	2.50	.93	.94	—	3.31
326602	3/16	A	4.25	2.50	.93	.94	—	3.31
326603	3/8	A	4.25	2.50	.93	.94	—	3.31
326604	7/16	A	4.25	2.50	.93	.94	—	3.31
326605	1/2	A	4.25	2.50	.93	.94	—	3.31
326606	5/8	A	4.25	2.50	.93	.94	—	3.31
326607	3/4	A	4.25	2.50	.93	.94	—	3.31
326608	—	B	4.43	2.50	—	—	2.10	—
326609	7/8	A	4.43	2.50	1.12	.94	—	3.49
326610	—	B	4.56	2.50	—	—	2.22	—
326611	1"	A	4.56	2.50	1.25	.94	—	3.62
326612	—	B	4.68	2.50	—	—	2.35	—
326613	1 1/8	A	4.68	2.50	1.37	.94	—	3.74
326614	—	B	4.93	2.50	—	—	2.60	—
326615	1 1/4	A	4.93	2.50	1.50	1.07	—	3.86

*Two Crimps Necessary on All Above Items.

AMPOWER Splices

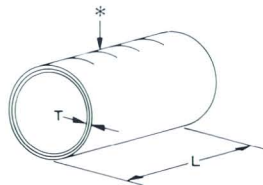

PARALLEL SPLICE Wire Size 6 to 1000 MCM

Part No.	Wire Size	Wire Range	T	Barrel I.D. Min.	L Max.
328184	6	20,800-33,100 CM	.034	.213	.320
328186	4	33,100-52,600 CM	.034	.277	.406
324442	2	52,600-83,700 CM	.040	.372	.48
324443	1/0	83,700-119,500 CM	.043	.468	.57
324444	2/0	119,500-150,500 CM	.048	.523	.64
324445	3/0	150,500-190,000 CM	.054	.586	.70
324446	4/0	190-231 MCM	.060	.658	.76
324447	250 MCM	231-275 MCM	.066	.700	.82
324448	300 MCM	275-325 MCM	.072	.768	.89
324449	350 MCM	325-375 MCM	.078	.829	.95
324450	400 MCM	375-450 MCM	.084	.886	1.01
324451	500 MCM	450-550 MCM	.093	.991	1.10
324452*	600 MCM	550-650 MCM	.102	1.085	1.20
324453*	700 MCM	650-750 MCM	.110	1.172	1.28
324454*	800 MCM	750-850 MCM	.119	1.252	1.35
324455*	900 MCM	850-950 MCM	.126	1.400	1.43
324456*	1000 MCM	950-1125 MCM	.132	1.328	1.50

*Two Crimps Necessary.

AMPOWER Splices

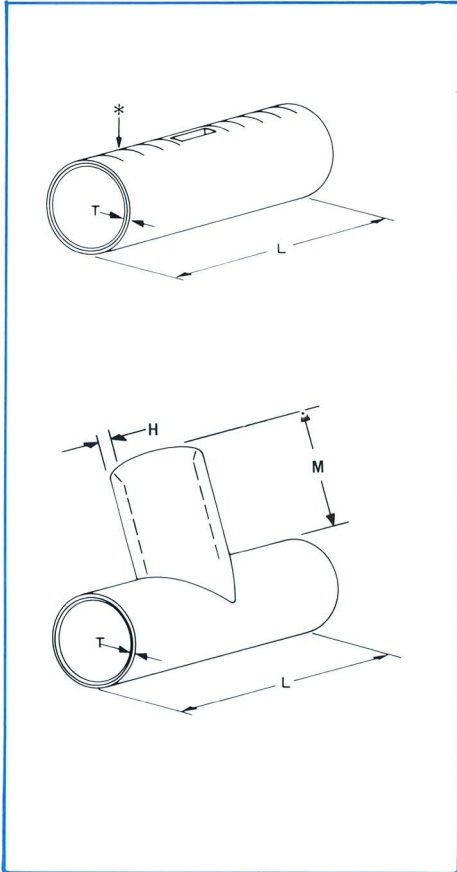

BUTT SPLICE Wire Size 6 to 1250 MCM

Part No.	Wire Size	Wire Range	T	Barrel I.D. Min.	L Max.
328180	6	20,800-33,100 CM	.034	.213	.687
328182	4	33,100-52,600 CM	.034	.277	.820
324457	2	52,600-83,700 CM	.040	.372	1.04
324458	1/0	83,700-119,500 CM	.043	.468	1.25
324459	2/0	119,500-150,500 CM	.048	.523	1.37
324460	3/0	150,500-190,000 CM	.054	.586	1.51
324461	4/0	190-231 MCM	.060	.658	1.65
324462	250 MCM	231-275 MCM	.066	.700	1.79
324463	300 MCM	275-325 MCM	.072	.768	1.92
324464	350 MCM	325-375 MCM	.078	.829	2.06
324465	400 MCM	375-450 MCM	.084	.886	2.20
324466	500 MCM	450-550 MCM	.093	.991	2.40
324467*	600 MCM	550-650 MCM	.102	1.085	2.60
324468*	700 MCM	650-750 MCM	.110	1.172	2.78
324469*	800 MCM	750-850 MCM	.119	1.252	2.95
324470*	900 MCM	850-950 MCM	.126	1.328	3.12
324471*	1000 MCM	950-1125 MCM	.132	1.400	3.26
53182-1*	1250 MCM	1125-1300 MCM	.140	1.812	4.17

*Two Crimps Necessary on Each End.

"T" SPLICE Wire Range 300 to 800 MCM

Part No.	Wire Size	Wire Range	T	H	Barrel I.D. Min.	L Max.	M Max. Typ.
52789	350 MCM	325-375 MCM	.077	.077	.829	4.280	1.630
53531-1	300 MCM	275-325 MCM	.071	—	.768	5.346	2.250
	600 MCM*	550-650 MCM	—	.101	1.085		
53534-1	800 MCM*	750-850 MCM	.118	.118	1.252	6.548	2.500

*Two Crimps Necessary on Each End.

AMPOWER Terminals and Splices

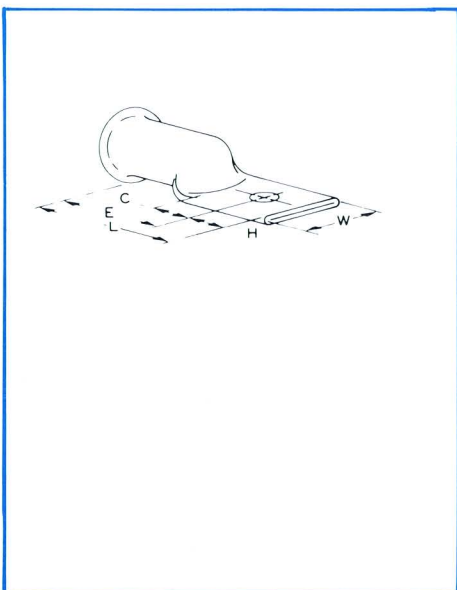

LONG BARREL TERMINAL With Hole Wire Size: 2 to 1000 MCM

Part No.	Wire Size	Wire Range	Stud Size	Barrel I.D. Min.	L Max.	H Max.	C Min.	W Max.	E Max.	Tongue Thk. Max.
325211	2	52,600-83,700 CM	3/16	.372	2.04	.34	.50	.69	1.70	.09
325317	1/0	83,700-119,500 CM	3/8	.468	2.48	.42	.62	.85	2.07	.10
325410	2/0	119,500-150,500 CM	3/8	.523	2.69	.47	.62	.95	2.22	.11
325513	3/0	15,500-190,000 CM	3/8	.586	2.94	.52	.62	1.06	2.39	.12
325613	4/0	190-231 MCM	1/2	.658	3.14	.59	.62	1.17	2.55	.13
325718	250 MCM	231-275 MCM	1/2	.700	3.33	.63	.62	1.26	2.69	.15
325820	300 MCM	275-325 MCM	1/2	.768	3.50	.63	.62	1.38	2.87	.16
325918	350 MCM	325-375 MCM	1/2	.829	3.66	.63	.62	1.49	3.03	.17
326020	400 MCM	375-450 MCM	5/8	.886	3.95	.63	.75	1.59	3.32	.18
326122	500 MCM	450-550 MCM	1/2	.991	4.32	.76	.75	1.78	3.57	.20
326221*	600 MCM	550-650 MCM	3/4	1.085	4.75	.76	.94	1.95	3.99	.22
326322*	700 MCM	650-750 MCM	5/8	1.172	4.77	.76	.75	2.10	4.02	.24
326420*	800 MCM	750-850 MCM	5/8	1.252	4.98	.76	.75	2.24	4.22	.25
326520*	900 MCM	850-950 MCM	5/8	1.328	5.18	.76	.75	2.37	4.42	.27
326618*	1000 MCM	950-1125 MCM	3/4	1.400	5.72	.95	.93	2.51	4.78	.28

*Two Crimps Necessary.

AMPOWER Special Terminals (cont.)

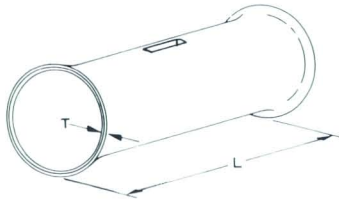
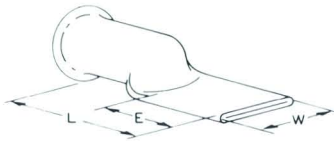

LONG BARREL TERMINAL Without Hole Wire Size: 2 to 1000 MCM

Part No.	Wire Size	Wire Range	Barrel I.D. Min.	L Max.	F Max.	W Max.	Tongue Thk. Max.
325212	2	52,600-83,700 CM	.372	3.05	1.88	.69	.09
325318	1/0	83,700-119,500 CM	.468	4.24	2.83	.85	.10
325411	2/0	119,500-150,500 CM	.523	4.44	2.88	.95	.11
325514	3/0	150,500-190,000 CM	.586	4.66	2.94	1.06	.12
325614	4/0	190-231 MCM	.658	4.89	3.00	1.17	.13
325719	250 MCM	231-275 MCM	.700	5.58	3.54	1.26	.15
325821	300 MCM	275-325 MCM	.768	5.96	3.75	1.38	.16
325919	350 MCM	325-375 MCM	.829	5.42	3.05	1.49	.17
326021	400 MCM	375-450 MCM	.886	5.82	3.29	1.59	.18
326123	500 MCM	450-550 MCM	.991	6.03	3.25	1.78	.20
326222*	600 MCM	550-650 MCM	1.085	6.28	3.25	1.95	.22
326323*	700 MCM	650-750 MCM	1.172	6.28	3.05	2.10	.24
326421*	800 MCM	750-850 MCM	1.252	6.48	3.05	2.24	.25
326521*	900 MCM	850-950 MCM	1.328	6.68	3.05	2.37	.27
326619*	1000 MCM	950-1125 MCM	1.400	7.04	3.23	2.51	.28

*Two Crimps Necessary.

Note: Long barrel terminals do not have an inspection slot. These terminals may be crimped two times, except where noted.

LONG BARREL BUTT SPLICE Wire Size: 2 to 1000 MCM

Part No.	Wire Size	Wire Range	T	Barrel I.D. Min.	L Max.
53080	2	52,600-83,700 CM	.039	.372	2.04
53081	1/0	83,700-119,500 CM	.042	.468	2.42
53082	2/0	119,500-150,500 CM	.047	.523	2.69
53083	3/0	150,500-190,000 CM	.053	.586	2.97
53084	4/0	190-231 MCM	.059	.658	3.24
53085	250 MCM	231-275 MCM	.065	.700	3.51
53086	300 MCM	275-325 MCM	.071	.768	3.79
53087	350 MCM	325-375 MCM	.077	.829	4.06
53088	400 MCM	375-450 MCM	.083	.886	4.34
53089	500 MCM	450-550 MCM	.092	.991	4.75
53090*	600 MCM	550-650 MCM	.101	1.085	5.16
53091*	700 MCM	650-750 MCM	.109	1.172	5.51
53092*	800 MCM	750-850 MCM	.118	1.252	5.85
53093*	900 MCM	850-950 MCM	.125	1.328	6.19
53094*	1000 MCM	950-1125 MCM	.131	1.400	6.47

*Two Crimps Necessary on Each End.

AMPOWER Special Terminals

AMPOWER Quick Disconnect Terminals

Material: Body and Pins — Brass per QQ-B-626

Finish: Silver plated per QQ-S-365

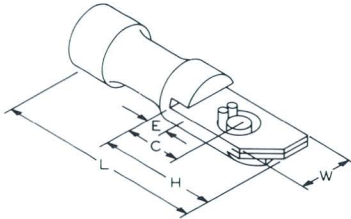

STYLE A (Dual-Pin)

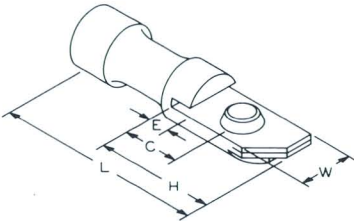

STYLE B1 (Single-Pin)

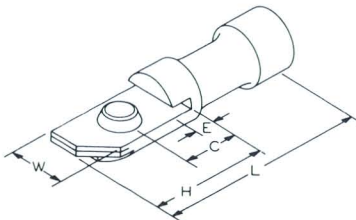

STYLE B2 (Single-Pin)

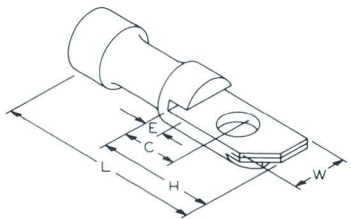

STYLE C1 (No-Pin)

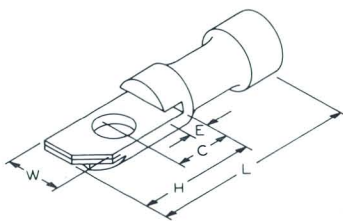

STYLE C2 (No-Pin)

Especially designed for use in the Rapid Transit Railroad System, AMPOWER quick disconnect terminals provide a highly reliable and economic means of terminating large power cables and leads. They are ideally suited for a variety of applications such as motors, generators, transformers plus numerous other electrical equipment subjected to shock and vibration as well as long, continuous periods of operation.

These AMP terminals combine a number of features to offer maximum flexibility and reliability at a consistently lower installed cost. Included are: a unique pin and groove design for fast, positive terminal engagement with complete detachability; heavy-duty brass construction with silver plating for high strength and excellent resistance against vibration . . . without sacrificing any current-carrying capacity; wide selection of available sizes for accommodating a wire range from #1/0 AWG to 350 MCM; ability

to accept conductors of stranded cable type — and an extended bell-mouth cable entry that permits easy insertion of leads and also gives added support for the terminated lead. In addition, the quick disconnect terminals can be supplied with an inspection hole to facilitate checking whether the conductors have been fully and properly inserted into the wire barrel. This inspection can be performed prior to or after crimping.

For ease and speed of application at the lowest installed cost, all AMPOWER quick disconnect terminals are terminated in the electrohydraulic DYNA-CRIMP tool. This power unit employs crimping heads with precision single-position dies that produce uniform, top quality terminations time after time. A complete line of accessories is also available with the tool making it ideal for portable applications and for use as a bench-mounted unit.

Style	Wire Size	Wire Range	Part No.	Max. Insul. Dia.	L Max.	W	C	E	H ±.010	Head and Die Insert Nos. for Power Unit 69120	
										Head No.	Die Insert No.
A	1/0	83,700-119,500 CM	52594-1	.656	3.750	1.000	.875	.340	1.725	69099	68200-1
			52594-2*								
			53443-1	.800							
			53444-1	.850							
B1	2/0	119,500-150,500 CM	52595-1*	.750	3.750	1.187	.875	.260	1.725	69099	68201-1
			52595-2*	.688							
B2			52313								
			52334	.718							
A	3/0	150,500-190,000 CM	52596-1*	.812	3.750	1.000	.875	.340	1.725	69082	68202-1
			52596-2*	.688							
			53445-1	.875							
C2	250 MCM	231-275 MCM	53446-1	1.060	5.343	1.375	1.312	.469	2.599	69082	68203-1
			52335	.968							
C1	350 MCM	325-375 MCM	52336	1.078	4.500	1.187	.875	.260	1.725	69082	68204-1
			52597-1*	1.093							
A	400 MCM	375-450 MCM	52597-2*	1.156	5.343	1.375	1.312	.469	2.599	69082	68205-1
			53447-1	1.240							
			53434-1	—							
C1	500 MCM	450-550 MCM	53435-1	—	4.500	1.187	.875	.260	1.725	69082	68206-1

*These terminals are equipped with an inspection hole.

NOTE: Terminal mateability is as follows:

- Dual-pin engages with dual-pin (Style A/Style A), any size with same W dim.
- Single-pin engages with no-pin (Style B1/Style C1), Style B2/Style C2)