



ELECTRONICS
NASHVILLE 10, TENNESSEE

PULSE TRANSFORMER
ENCYCLOPEDIA

~~LONG & ASSOCIATES~~
Mfgers. Reps. ~~FAHREN 9-3324~~
BREWSTER-WARREN (STS.) BLDG. REDWOOD CITY, CALIF.

ND

Chuck Freel in Pasadena
Green St.

~~LONG & ASSOCIATES~~

Mfgers. Reps. EMerson 9-3324
~~BREWSTER-WARREN (STS.) BLDG. REDWOOD CITY, CALIF.~~

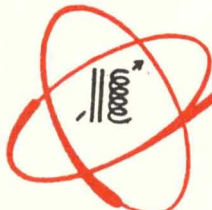

Aladdin

ELECTRONICS

A DIVISION OF ALADDIN INDUSTRIES, INCORPORATED

NASHVILLE 10, TENNESSEE

PHONE CHAPEL 2-3411

No. 55-2

JULY 1958

ENGINEERING BULLETIN









PULSE TRANSFORMER ENCYCLOPEDIA

This revised edition of the Pulse Transformer Encyclopedia contains all the original data plus considerable new material. Like the original Encyclopedia, this revised edition is intended as a design tool for low-power pulse circuitry.

TABLE OF CONTENTS

	Page
TABLE OF CONSTRUCTION STYLES	2
PULSE TRANSFORMER THEORY AND APPLICATIONS	4
1.0 COUPLING TRANSFORMERS	5
1.1 Performance Specifications	5
1.2 Pulse Parameters	7
1.3 Mismatching	10
1.4 Measurements	11
1.5 Typical Coupling Circuits	12
2.0 BLOCKING OSCILLATOR TRANSFORMERS	13
2.1 Blocking Oscillator Transformer Specifications	14
2.2 Theory of Blocking Oscillator Operation	14
2.3 Temperature Range	16
2.4 Power Ratings	17
3.0 MICROMINIATURE PULSE TRANSFORMERS	20
3.1 Use of Data Tables	20
3.2 Transistor Blocking Oscillators	20
3.3 Other Transistors	22
3.4 Input Trigger Pulse	22
3.5 Repetition Rate	23
3.6 Other Considerations	24
3.7 Environmental Requirements	24
INDEX FOR DATA TABLES AND PHASE INVERSION	25
TABLES OF PERFORMANCE DATA	28

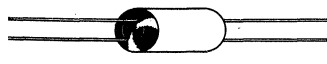
TABLE I

	SERIES	CASE	DIA. (MAX.)	OPERATING TEMPERATURE RANGE	TERMINALS	CONSTRUCTION
	02-	Metal with Epoxy End Seals	.525	-55°C to +105°C	#20 TCW	Hermetically sealed MIL-T-27A construction
	20-	Metal with Epoxy End Seal	.285	-55°C to +105°C	#24 TCW	Hermetically sealed Micro-miniature MIL-T-27A construction +
	23-	Metal with Epoxy End Seal	.700	-55°C to +105°C	Either 7-pin Miniature or Printed Board Spacing	Hermetically sealed MIL-T-27A construction
	* 25-	Metal with Epoxy End Seals	.285	-55°C to +130°C	#24 TCW	Hermetically sealed Micro-miniature MIL-T-27A construction +
	* 29-	Ferrite with Epoxy End Seals	.266	-20°C to +85°C	#24 TCW	Commercial grade equivalent to 94-series
	* 31-	Metal with Glass End Seals	.525	-55°C to +105°C	#20 TCW	Hermetically sealed MIL-T-27A construction
	* 32-	Metal with Epoxy End Seals	.525	-55°C to +200°C	#20 TCW	Hermetically sealed MIL-T-27A construction
	90-	Ferrite with Epoxy End Seals	.480	-20°C to +85°C	#20 TCW	Commercial grade equivalent to 02-series
	92-	Ferrite with Epoxy End Seal	.625	-20°C to +85°C	Either 7-pin Miniature or Printed Board Spacing	Commercial grade equivalent to 23-series
	94-	Metal with Epoxy End Seals	.285	-55°C to +105°C	#24 TCW	Hermetically sealed Micro-miniature MIL-T-27A construction +

* Not stock item; built to order only.

+ Due to small mass and volume, flammability test is inapplicable.

02, 90, 31 and 32 SERIES

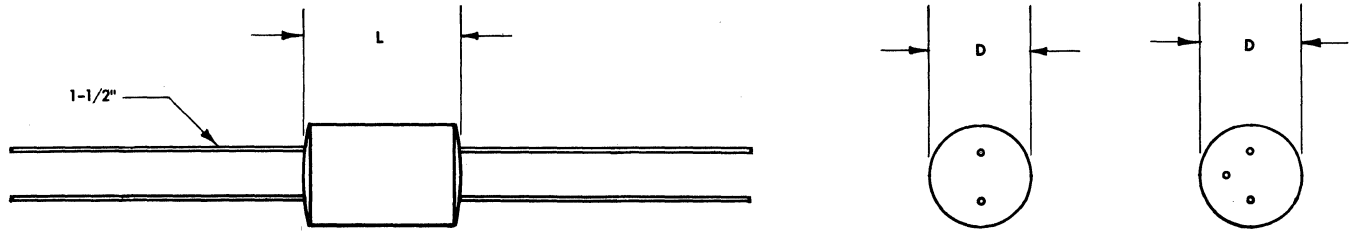

For Length (L), see applicable data page.

23 and 92 SERIES

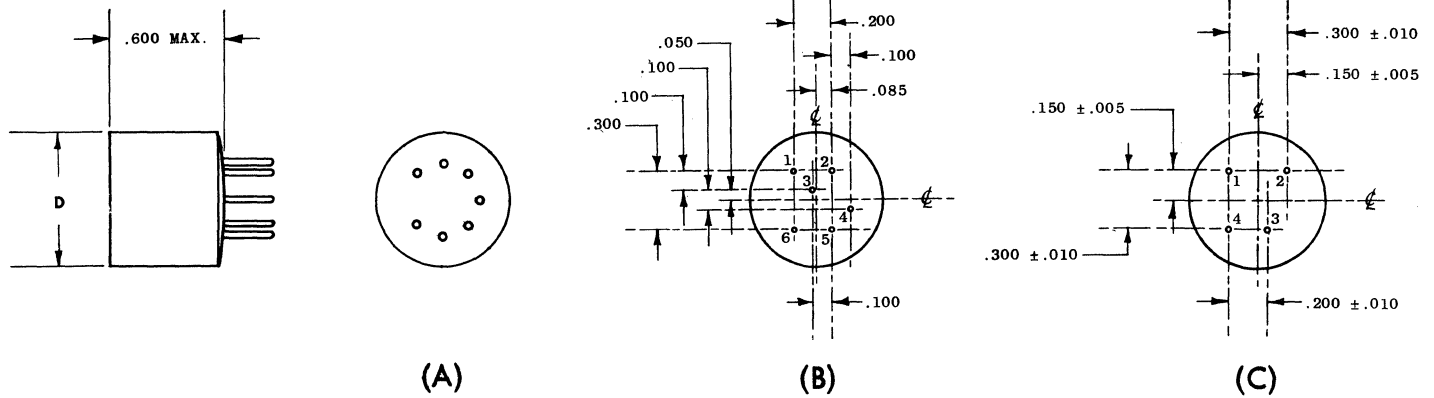

Unless otherwise specified, all single ended units will be furnished with the standard 7-pin miniature tube base as shown in figure A.

94, 20, 25 and 29 SERIES

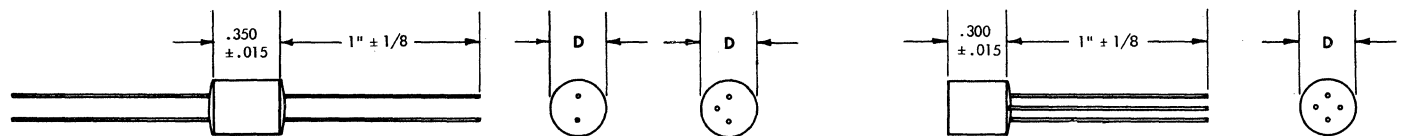

INTRODUCTORY NOTES

Aladdin Electronics provides the most comprehensive line of low-power pulse transformers available today. The variety of styles and types is shown in Table 1.

This encyclopedia contains complete data on all the series listed in Table 1 except the 25-, 31-, and 32-series units which are built to special order only. In most cases, the performance of any encyclopedia unit can be closely approximated by a transformer in one of these special series.

More than 1000 different transformers are listed in this encyclopedia of standard units. If none of these meets your needs, we shall be glad to work with you in the development of a special unit.

PERFORMANCE DATA

The tables in this encyclopedia describe the performance of each standard transformer under a variety of operating conditions. Precise answers to many circuit design problems may be found in these tables. Any transformer selected from this encyclopedia is a standard production item and is readily available.

PULSE TRANSFORMER THEORY AND APPLICATIONS

All low-power pulse transformer applications fall into two classes:

- (a) Those which may be characterized as coupling or impedance matching applications; and
- (b) Those in which the transformer acts in conjunction with some non-linear element, such as a vacuum tube or transistor, to form a pulse generating circuit. Most class (b) applications are in blocking oscillator circuits.

Into class (a) fall all applications which can be discussed in terms of generator constants, load impedances and desired pulse responses. Into class (b) fall all other applications.

The reason for emphasizing this distinction between class (a) and class (b) is this: in a pulse generating circuit, the dynamic characteristics of other circuit elements have just as much to do with the pulse shape as do the parameters of the transformer itself.

Most pulse transformers may be useful as either coupling transformers or blocking oscillator transformers. However, the two classes of applications require entirely different sets of performance specifications to define a satisfactory transformer.

Therefore, the tables in this bulletin are divided into separate sections. One section is devoted to coupling applications and another to blocking oscillators.

USE OF DATA TABLES

The data tables have been set up in such a manner as to simplify the problem of locating the right unit for either a coupling or blocking oscillator application. For coupling applications, a table of performance data is provided for each standard turns ratio. In each table, the data are arranged in order of increasing pulse width. A particular transformer may appear several times in the tables since its performance will vary with the impedance levels used. In each table, the part numbers for both military and commercial grade transformers are listed so that the type appropriate for your application may be selected.

The blocking oscillator data are arranged in order of pulse width and load impedance for the circuit indicated.

1.0 COUPLING TRANSFORMERS

When a transformer is used to couple two circuits together, the principal considerations are (a) the power loss permissible and (b) the degree of distortion permissible.

In order to get maximum efficiency of power from one circuit to the other, the turns ratio of the transformer must be selected so as to match the impedance levels of the two circuits to each other. This is simply a question of selecting proper turns ratio. For low distortion, the transformer must have low leakage inductance and low distributed capacity. If the input pulse is fairly wide, then the pulse transformer must have a relatively large primary inductance. Zero distortion requires no leakage inductance, no distributed capacity and an infinite primary inductance.

1.1 PERFORMANCE SPECIFICATIONS

The most satisfactory way of specifying what is required of a coupling transformer is to state the source and load impedances and to describe the input pulse and the desired output pulse.

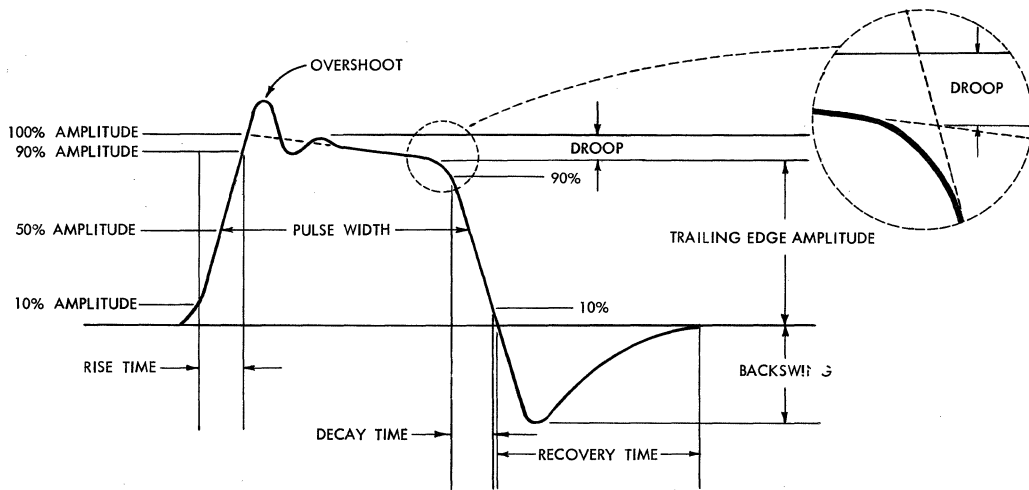

PULSE WAVEFORM

FIG. 1

Figure 1 shows a pulse waveform. Assuming that this is a transformer output pulse corresponding to an ideal rectangular input pulse, it is to be noted that the transformer has introduced various kinds of distortion . . . overshoot, droop, backswing, etc. The influence of each transformer parameter on the wave shape can best be understood by considering the complete equivalent circuit of a transformer depicted in Figure 2.

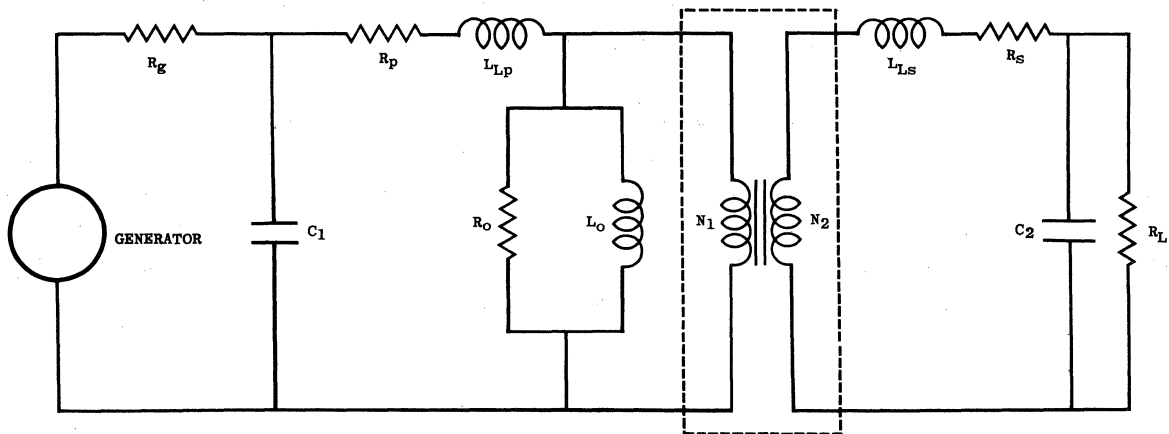

EQUIVALENT TRANSFORMER CIRCUIT

FIG. 2

1.2 PULSE PARAMETERS

In this figure the parameters are defined as follows:

- R_g = Generator Resistance
- R_p = Resistance of the Primary Winding
- R_o = Core Loss (Negligible for Ferrite)
- R_s = Resistance of the Secondary Winding
- R_L = Load Resistance
- C_1, C_2 = Primary and Secondary Equivalent Lumped Capacitances
- L_{Lp}, L_{Ls} = Leakage Inductance of Primary and Secondary Respectively
- L_o = Primary Inductance
- $N_1:N_2 = 1:n$ = Turns Ratio of an Ideal Transformer

A pulse such as that described in Figure 1 has many frequency components. The high frequency components are responsible for the leading edge, or rise time, while the degree of flatness of the top and the pulse width are functions of lower frequencies.

It is possible to clarify the understanding of pulse transformer operations by considering the response of the circuit during the build-up time, the pulse duration and the decay period.

1.21 Rise Time

Since rise time is a function of the high frequency response, we shall first evolve the high frequency circuit which is shown in Figure 3.

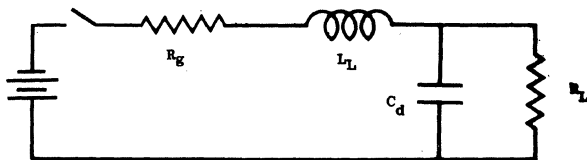

RISE TIME PARAMETERS

FIG. 3

This circuit was obtained by first transferring all the elements on the right side of the ideal transformer to the left side by multiplying each impedance on the right by $1/n^2$. Since the ideal transformer provides perfect coupling, it can be ignored. R_o and L_o are both negligible for ferrite core transformers. If a step-up transformer is considered, C_1 is small compared to $n^2 C_2$. (If the transformer is step-down, the equivalent circuit is altered in form but the results are not changed appreciably.) The leakage inductances are

then combined to give a single value, L_L . C_d represents the total distributed capacitance. From Figure 3, it is readily seen that the important factors in considering rise time are the leakage inductance and the distributed capacitance.

$$\text{Rise Time} = K \sqrt{L_L C_d}$$

The value of R_L must be such that the value of the time constant $\frac{L_L}{R_g + R_L}$ is short.

Too small a value of R_L , with respect to the leakage inductance, will cause poor rise time; higher values will improve rise time, within limits.

1.22 Overshoot

The first cycle of the oscillation which occurs at the top of the output pulse, in response to a square input pulse, is called overshoot. Its amplitude is expressed in percent. The figure given for it in a specification is a measure of the amount by which overshoot will exceed the 100% pulse amplitude value. (See Figure 1.) Overshoot may be reduced by introducing losses in the transformer itself, to damp the oscillation. These losses have a tendency to increase the rise time, however. For good high frequency response, and therefore fast rise time, pulse transformers are generally designed to have about 5 to 10% overshoot.

1.23 Pulse Width

The data tables in this encyclopedia list pulse widths measured between the 50% pulse amplitude points (see Figure 1), in accordance with generally accepted practice.

The widest pulse a transformer can handle, without introducing more than 10% droop, is listed in the "maximum" pulse width column.

1.24 Droop

Figure 1 defines droop graphically. It shows the point where the extension of the top of the pulse intersects the extension of the trailing edge. Droop is measured at this point. It is expressed, in percent, as the difference between 100% pulse amplitude and the amplitude of the pulse top (extended) at this intersection point.

1.25 Considerations Affecting Pulse Duration

Pulse duration is determined by the low frequency response of the transformer. Referring again to Figure 2, all capacitances in the circuit may be considered negligible. The leakage inductance is small compared to L_0 and may be eliminated. If the primary and secondary resistances are again lumped into R_L , the equivalent circuit will be that of Figure 4.

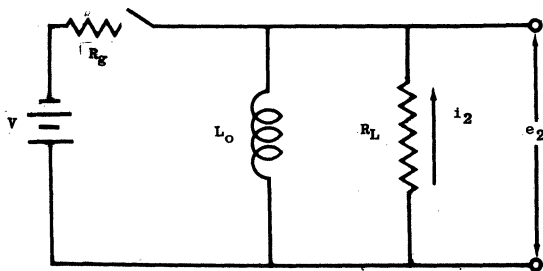

LOW FREQUENCY
EQUIVALENT CIRCUIT

FIG. 4

During this phase of the pulse, we should consider that the switch has been thrown, and the rise time portion of the pulse is complete. Were the voltage across R_L to remain constant, the top of the output pulse would have no slope associated with it. The top would have the same degree of flatness as that of the ideal square wave which produced it. If it could be shown that the rate of change of current through the primary inductance were a constant (thus inducing a constant voltage), this condition would be satisfied. The response of this current to a step voltage can be determined mathematically. It can be shown that the current i_2 flowing through the resistance R_L as a function of time is given by

$$i_2(t) = \frac{V}{R_g + R_L} e^{-Rt/L_o}$$

where $R = \frac{R_g R_L}{R_g + R_L}$ and $e_2(t)$, the voltage across R_L , as a function of time is given by

$$e_2(t) = \frac{V R_L}{R_g + R_L} e^{-Rt/L_o}$$

The voltage $e_2(t)$ is also the voltage across the primary inductance. This is related to the primary inductance by the expression

$$e_2(t) = L_o \frac{d(i_{L_o})}{dt}$$

$$\text{Then } \frac{d(i_{L_o})}{dt} = \frac{Ke^{-Rt/L_o}}{L_o} \quad \text{where } e_2(t) = Ke^{-Rt/L_o}$$

Thus, when t equals zero (at the beginning of the pulse duration period), the slope, or droop of the pulse will be zero. However, it is apparent from the equations that the rate of change of current will not remain constant after $t = 0$, and that the pulse amplitude will decrease with time.

Ideal square input pulses of different pulse widths, fed into the same coupling transformer at one impedance level, will appear as output pulses with varying degrees of droop. The greater the input pulse width, the greater will be the output pulse droop, for any pulse transformer.

1.26 Decay-Time and Backswing

During the fall time of the pulse the equivalent circuit is shown in Figure 5.

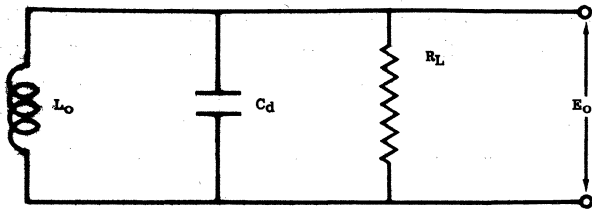

PARAMETERS IMPORTANT DURING
PULSE TRAILING EDGE

FIG. 5

As indicated in Figure 5, the decay-time response depends upon the open circuit inductance, the distributed capacitance and the load resistance. C_d represents the entire shunt capacitance referred to the primary. Since there is no independent source of voltage in this circuit, its behavior must be contained in the initial conditions. Assume that during the pulse duration part of the cycle, just prior to the time when the input pulse returns to zero, there is some energy stored in the inductor L_o . When the input pulse returns to zero, the inductance must discharge this energy into the load. Since the discharge path through C_d and R_L is not a short circuit, the discharge takes a finite time. This is the decay time (see Figure 1).

During the decay time, C_d must discharge through L_o and R_L , causing the voltage E_o to swing negative. If the value of R_L is relatively high while other circuit losses are relatively low, it is possible for L_o and C_d to continue to interchange energies and produce a damped ringing effect about the zero line. An example of this effect is shown in Figure 6. The transformers listed in the data tables have a maximum backswing of 15% under the load conditions described.

DAMPED RINGING ON
TRAILING EDGE OF PULSE

FIG. 6

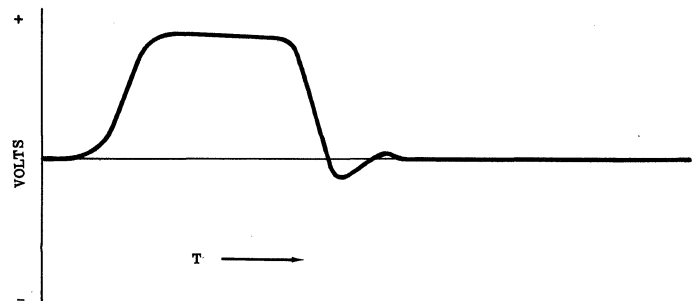

1.3 MISMATCHING

The tables contained in this encyclopedia describe transformer operation at several impedance levels. Care has been taken to indicate the proper matched impedance ratios. For example, a transformer with a turns ratio of 2:1 is always described as having an impedance ratio of 4:1. This gives maximum transfer of power from one circuit to another. It is perfectly feasible to use the same transformer mismatched.

When a higher impedance than that stipulated for matched conditions is placed across the secondary of a transformer, the rise time characteristic will generally improve for reasons stated under section 1.21 Rise Time. The backswing will increase because the damping of L_o and C_d is less, and somewhat more droop is realized for the same pulse width. Of course, maximum power would no longer be transferred under these conditions. Generally, it is difficult to detect a change in pulse characteristics for a mismatch as great as 10% in impedance ratio.

1.4 MEASUREMENTS

For coupling transformers of any turns ratio, the pulse characteristics can be observed and measured with good accuracy by testing the transformer at the specified impedance level and the prescribed input pulse. Figure 7 indicates the proper test arrangement.

CIRCUIT FOR TESTING
PULSE TRANSFORMERS

FIG. 7

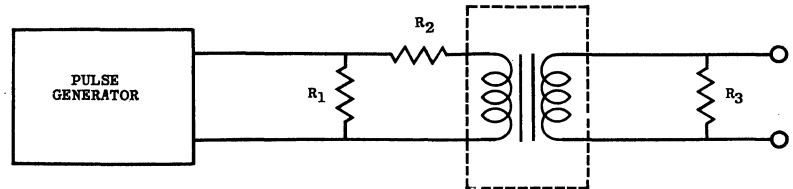

The resistor R_3 is the load impedance. The internal impedance R_g of the generator is not shown. R_1 is the terminating impedance for the generator suggested by the manufacturer of the instrument, usually 50 ohms. R_2 is used to match the pulse generator and its termination to the loaded transformer.

The impedance which the primary of the pulse transformer "sees" looking toward the pulse generator is R_G :

$$R_G = R_2 + \frac{R_1 R_g}{R_1 + R_g}$$

Figure 8 shows a typical test circuit for a transformer with a 1:1 turns ratio designed to operate at an impedance level of 100 ohms. R_g is 50 ohms. Calculations will show that, in this case, R_G equals 100 ohms.

In the case of multi-winding transformers, for matched conditions, the generator impedance should equal the impedance "seen" looking into the transformer primary when the secondary windings are loaded for matched conditions.

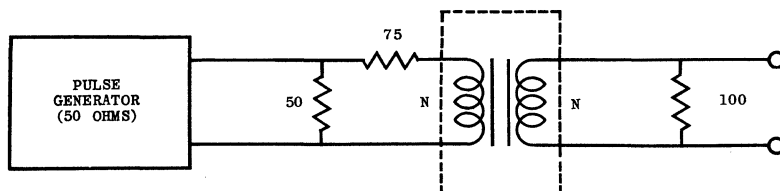

RESISTANCE NETWORK FOR
100 OHM IMPEDANCE LEVEL

FIG. 8

It is possible to "match" the generator to a multi-winding transformer with unequal loading on the secondaries. If this is done, results different from those tabulated in the tables may be observed.

All measurements made in compiling the performance data tables for coupling transformers in this encyclopedia were performed using a Rutherford B3 pulse generator as the source.

1.5 TYPICAL COUPLING CIRCUITS

Frequently, it is desirable to couple from an extremely high impedance source to a low impedance load requiring a high current pulse. The cathode follower circuit shown in Figure 9 is a practical solution to this problem.

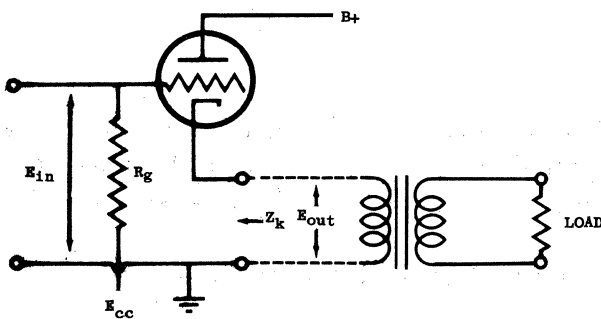

CATHODE FOLLOWER
WITH PULSE TRANSFORMER

FIG. 9

In order to use such a circuit with the transformers listed in this encyclopedia, it becomes necessary only to evaluate Z_k which may then be used as the figure listed under "Source Impedance (Ohms)" in the tables. For triodes

$$Z_k = r_p / (\mu + 1)$$

which is approximately equal to $1/g_m$ where μ is greater than 10. For pentodes, $1/g_m$ is used. A list of the cathode output impedances of typical tubes is given in Table 1.

TABLE 1

<u>Tube Type</u>	<u>Effective Output Impedance (Z_k) Between Cathode and Ground</u>	<u>Approximate Gain A</u>
6BQ7A	150 Ohms	.47
6BZ7	150 "	.49
12AT7	200 "	.48
12AU7	370 "	.49
5687	250 "	.56
5703	200 "	.50
5814	350 "	.48

In this type of application, we are supplying the load through the pulse transformer from a low impedance source. The voltage amplification from the grid of the cathode follower to the primary side of the transformer is given for several cases in Table 1. For the general case it may be found by applying the well known equation for the cathode follower:

$$A = \frac{E_o}{E_i} = \frac{g_m Z_k}{1 + \frac{Z_k}{r_p} + g_m Z_k}$$

For most tubes the value of Z_k/r_p is small and can be ignored. The value of the bias voltage E_{CC} is chosen to give class A operation for the vacuum tube stage. If the application is one in which shaping is permissible, it is possible to adjust the value of bias voltage to improve the top of the input pulse and shorten the rise time.

2. BLOCKING OSCILLATOR TRANSFORMERS

Pulse transformers can be used in oscillator circuits to generate pulses of very fast rise times over a wide range of repetition rates. These circuits, which are called blocking oscillators, can be made to "free-run" or can be externally pulsed. Most often, they are externally pulsed from a high impedance, low power, source. The blocking oscillator can then deliver a rectangular pulse for high voltage or current amplitude, at a low impedance level.

The characteristic of the output is determined in part by the transformer used, but is influenced greatly by the tube and associated circuitry. Aladdin has developed and collected from published literature several standard blocking oscillator circuits which utilize the best available tubes and transistors to generate pulses of desirable width, rise time and amplitude.

Figure 10 and Figures 12 through 20 show several of these circuits.

Using the circuit shown in Figure 10, and choosing various transformers from the tables, a wide range of rise times, pulse widths and repetition rates is possible.

The versatility of these circuits is the reason for their inclusion in this encyclopedia. Aladdin has developed or experimented with many other blocking oscillator circuits, also. They cover a wide range of input and output characteristics. If the performance you require is not obtainable from data in this PULSE TRANSFORMER ENCYCLOPEDIA, it is quite possible that what you need is in our files. Our applications engineers will be glad to study your problem and give any assistance they can.

2.1 BLOCKING OSCILLATOR TRANSFORMER SPECIFICATIONS

The most practical specification is the simplest possible complete definition of what is required. It omits nothing important; it includes nothing irrelevant. In an application where the transformer acts in conjunction with some nonlinear element (as is always the case in a blocking oscillator), the most satisfactory way to specify what is required is to state the performance required in the pulse circuit. This means defining and describing the following:

- (a) The circuit arrangement, specifying the tube or transistor type, values of resistances, capacitances and voltage available.
- (b) The characteristics of the output pulse desired, and
- (c) The characteristics of the input, or trigger, pulse.

2.2 THEORY OF BLOCKING OSCILLATOR OPERATION

Considering the circuit in Figure 10, the bias E_{CC} is adjusted so that no plate current flows in tube V_2 . The transformer windings are phased to make the plate-to-grid feedback positive. Since the tube V_2 is cut off, the plate voltage is equal to the supply voltage and there is no output from the circuit.

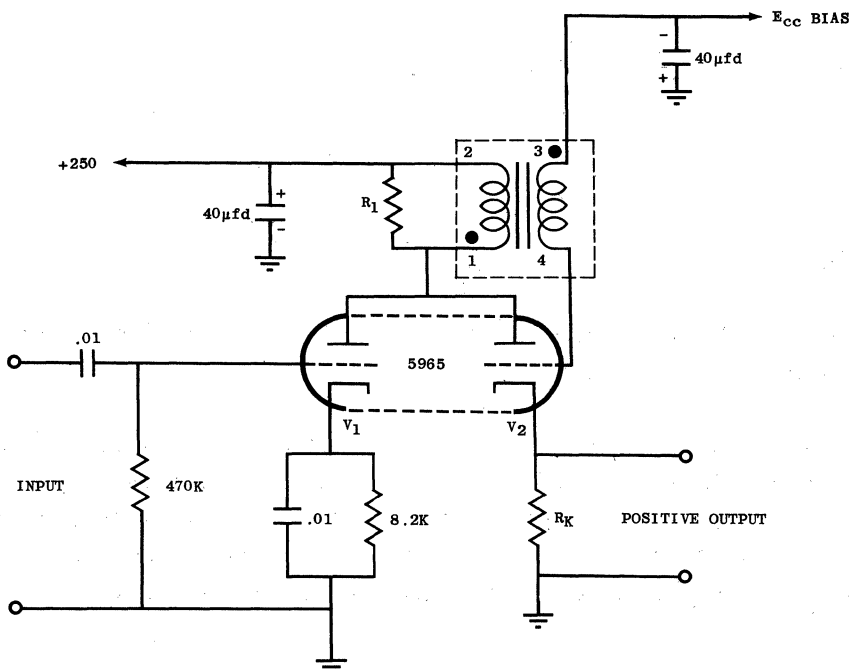

STANDARD VACUUM TUBE
BLOCKING OSCILLATOR
CIRCUIT

FIG. 10

Figure 11 will be helpful in following the description of the events which take place each time a trigger pulse is applied.

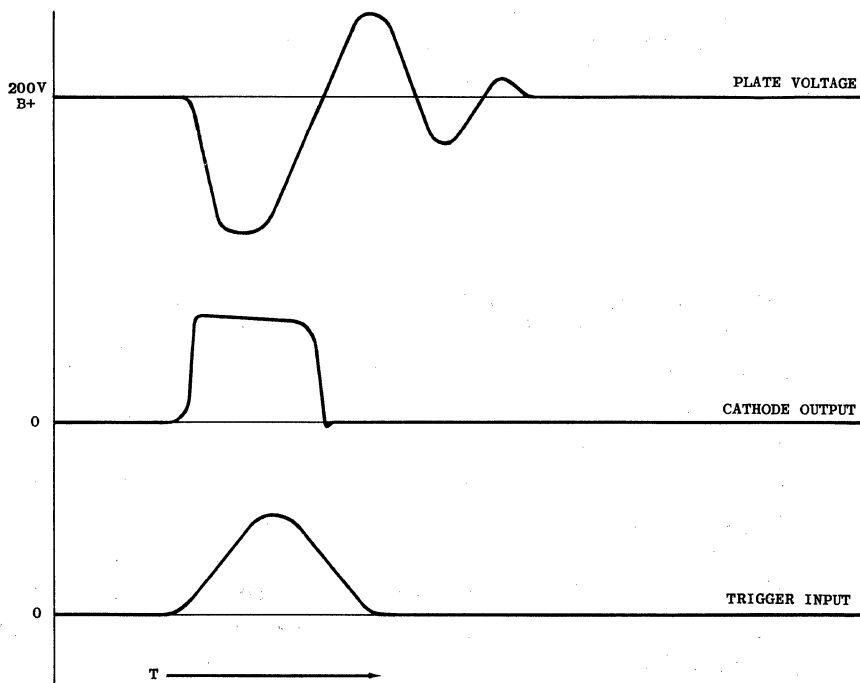

WAVEFORMS IN VARIOUS PARTS OF BLOCKING OSCILLATOR CIRCUIT

FIG. 11

A positive input to V_1 causes current to flow in the primary of the transformer. The plate circuit end of the primary becomes negative and a voltage is induced in the secondary. The phasing of the transformer causes a positive going waveform to appear on the grid of V_2 . As the grid of V_2 becomes less negative, the g_m of V_2 increases until the gain around the feedback loop is unity. The current through the primary then increases rapidly and an input is no longer required. The voltage at the plate of V_2 drops to a very low value.

The grid of V_2 becomes slightly positive and begins to draw current. This effectively puts an extremely low impedance across the secondary of the transformer --- approximately 200 ohms. Since the g_m of the tube is a function of the plate voltage, the g_m is very low during this phase. Tube V_2 must supply all the power consumed in the grid circuit. A state of equilibrium will exist temporarily.

If the rate of change of plate current decreases, the system will be unable to supply sufficient power to the grid circuit and the plate voltage will increase. Ideally, if the g_m of the tube were a linear function of plate voltage, the g_m would increase proportionately, allowing more current to flow. This would bring the rate of change of current back to its original value and create a state of equilibrium. However, the g_m of a tube is not a linear function of plate voltage and perfect compensation is not realized. Gradually, the induced voltage decreases and the grid of V_2 drops out of the positive region. As the grid becomes more negative, it tends to decrease the plate current still further and cutoff occurs.

2.21 Input Pulse Considerations

The blocking oscillator action can be started with any positive going waveform of sufficient amplitude to trigger the system. The rise time of the input pulse can affect the output pulse rise time, particularly for very fast input rise times. Very long input rise times, however, do not influence the output pulse rise time very much. In general, increasing the input rise time from 0.02 μsec to 1.0 μsec will result in an increase of about 50% in the output rise time.

2.22 Resistive Loading

Figure 11 describes the plate voltage waveform during the generation of a pulse. Notice that, at the trailing edge of the pulse, the plate potential actually goes higher than the supply voltage and oscillates about the supply voltage. It is quite possible for the return swing to retrigger the oscillator if the bias value is insufficiently negative. This condition is particularly likely to occur when the pulse transformer core material is made of ferrite. The low loss in ferrite material does not introduce sufficient damping to minimize the return swing and, to overcome this, an external resistor R_1 is generally used. Aladdin suggests in the tables a particular value for R_1 , as well as the necessary bias for proper operation. For any two-winding transformer, the value given in the table for R_1 can be used directly. Quite often it is desirable to add a third winding to a transformer to take another output from the system. For three-winding transformers, where an additional output is taken from the system, the value of R_1 is as follows:

$$R_1 = \frac{R_A R_L}{R_L - n^2 R_A}$$

where

- R_A = Total effective damping given in tables.
- R_L = Estimated load on third winding.
- n = Turns ratio of load winding to plate winding.
- R_1 = Value of resistance to be placed across the plate winding.

Too large a value of R_L and R_1 may enable the system to self-oscillate. However, much smaller resistances for R_1 and R_L can be used, causing some degradation of pulse characteristics. Extremely low values may stop the system from oscillating altogether.

2.3 TEMPERATURE RANGE

In general, the performance data listed in the coupling transformer tables will hold true over the operating temperature range of the unit. As the temperature decreases to -55°C , an increase to about 30% in droop and backswing may occur, but no other noticeable effects will result. A temperature rise to the maximum operating temperature will increase the droop and backswing approximately 5%.

2.4 POWER RATINGS

It is not possible to give a single figure for the power rating of the transformers listed in this encyclopedia. There are too many variables involved. However, as a general guide, the following rule is accurate. In each table of performance data (i.e., for each listing of transformers for a given turns ratio), the transformer at the top of the page (narrowest pulse width) will have a maximum peak power rating of 200 watts.

This rating will decrease almost linearly, going down the page. The last unit in the table (i.e., widest pulse width) will handle approximately 10 watts peak power. This limitation is imposed by the saturation effects, rather than any temperature rise in the unit.

FIG. 12

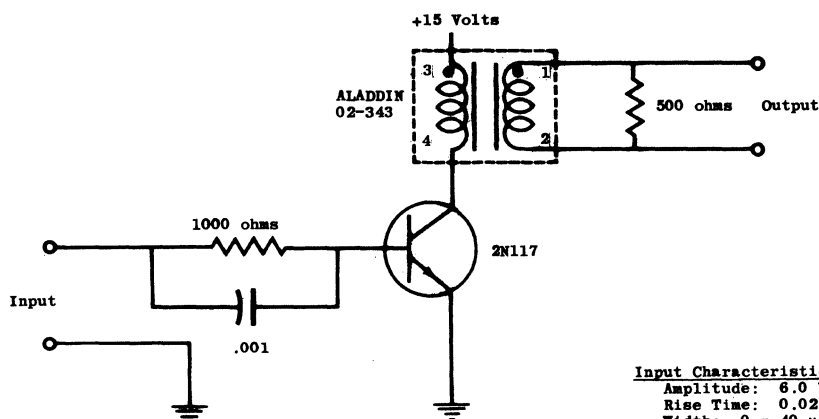

Input Characteristics

Amplitude: 6.0 Volts
 Rise Time: 0.02 - 1 μ sec.
 Width: 0 - 40 μ sec.
 Repetition Rate: 0 - 10 Kc.

Output Characteristics

Amplitude: 5 Volts ± 1
 Rise Time: 0.04 - 0.2 μ sec.
 Droop: 10% Max. at 40 μ sec. width
 Width: Same as input width

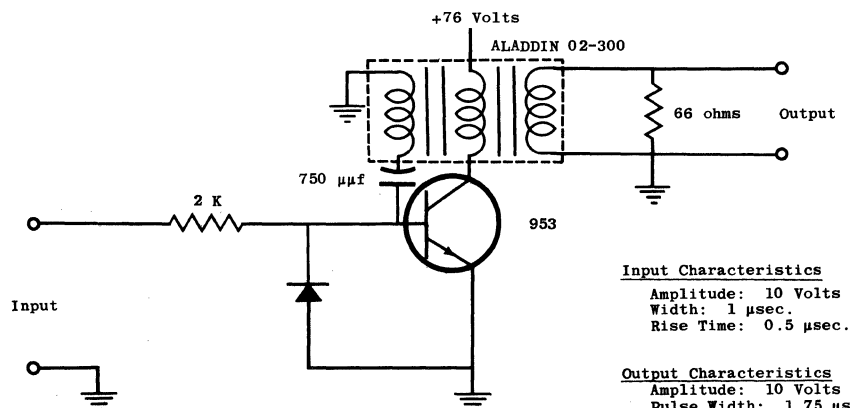

Input Characteristics

Amplitude: 10 Volts
 Width: 1 μ sec.
 Rise Time: 0.5 μ sec.

Output Characteristics

Amplitude: 10 Volts ± 1
 Pulse Width: 1.75 μ sec. ± 0.25
 Measured at 10% amplitude
 Rise Time: 0.35 μ sec. Max.
 Repetition Rate: 0 to 50 Kc.
 Droop: 0
 Backswing: 15% Max.
 Overshoot: 5% Max.

FIG. 13

FIG. 14

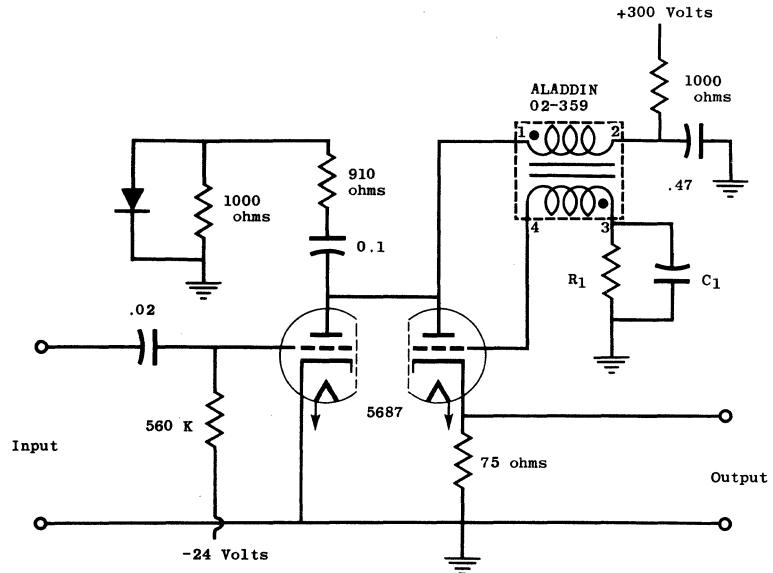

**TRIGGERED OR FREE RUNNING
BLOCKING OSCILLATOR**

Input Requirements If Triggered

Operation Is Desired
Amplitude: 35 Volts
Width: Spike
Rise Time: 0.02 μ sec.
Repetition Rate: Anything greater than free running rate up to 10 Kc.

Output Characteristics

Width: 2.0 μ sec. \pm 20%
Rise Time: 0.05 μ sec. Max.
Amplitude: 75 Volts Min.
Repetition Rate: Can be varied over wide range. Controlled by C1 and R1.

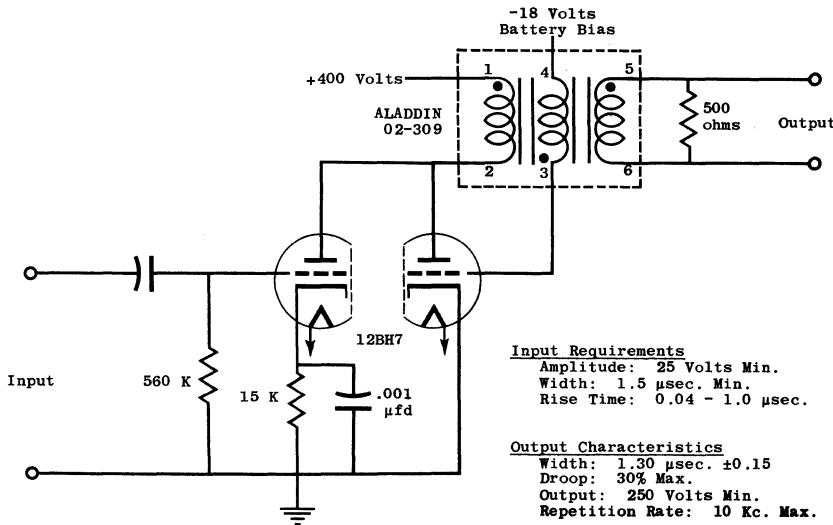

FIG. 15

Input Requirements

Amplitude: 25 Volts Min.
Width: 1.5 μ sec. Min.
Rise Time: 0.04 - 1.0 μ sec.

Output Characteristics

Width: 1.30 μ sec. \pm 0.15
Droop: 30% Max.
Output: 250 Volts Min.
Repetition Rate: 10 Kc. Max.

FIG. 16

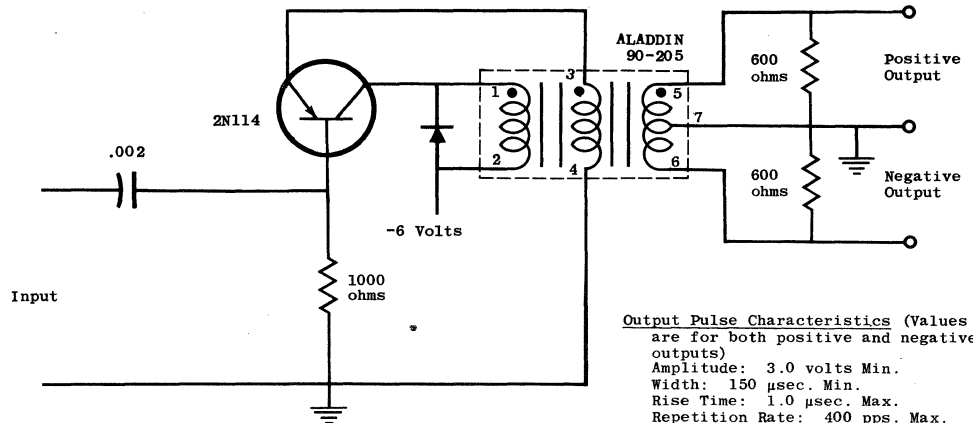

Input Characteristics

Amplitude: 3 volts
Width: spike
Rise Time: 0.02 to 0.5 μ sec.
Polarity: Negative

Output Pulse Characteristics (Values are for both positive and negative outputs)

Amplitude: 3.0 volts Min.
Width: 150 μ sec. Min.
Rise Time: 1.0 μ sec. Max.
Repetition Rate: 400 pps. Max.

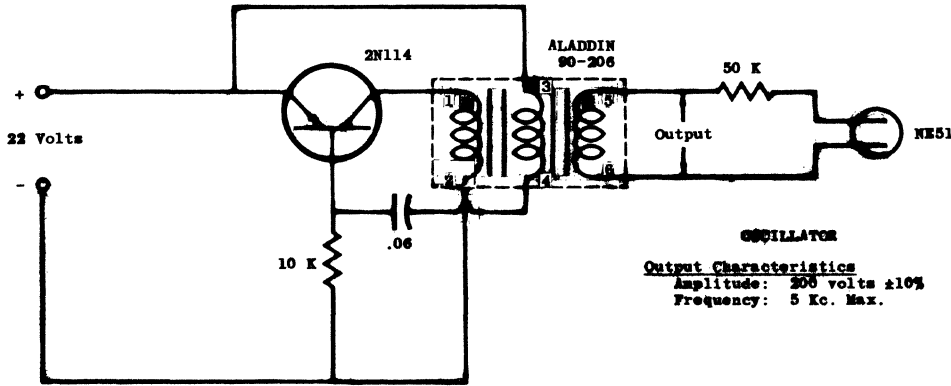
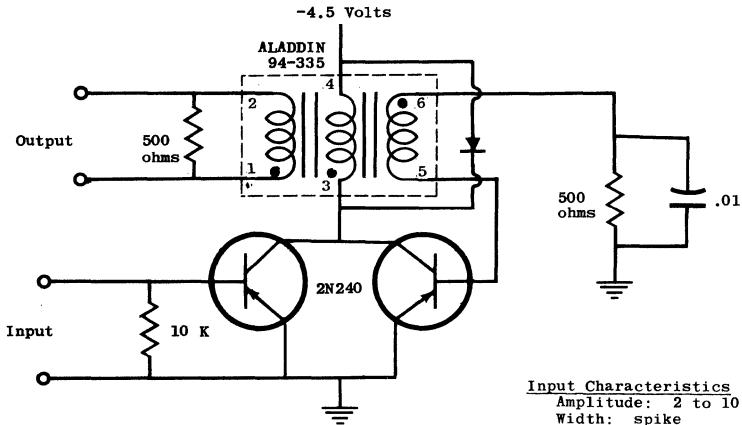

FIG. 17

OSCILLATOR
Output Characteristics
 Amplitude: 300 volts $\pm 10\%$
 Frequency: 5 Kc. Max.

FIG. 18



Input Characteristics
 Amplitude: 2 to 10 volts
 Width: spike
 Rise Time: 0.02 to 1.0 μ sec.
 Repetition Rate: 100 Kc. Max.
 Source Impedance: 200 ohms
 Polarity: negative

Output Characteristics
 Amplitude: 4.0 volts ± 0.5
 Width: 1.0 μ sec. $\pm 20\%$
 Droop: 20% Max.
 Rise Time: 0.02 μ sec. Max. for
 0.02 μ sec. trigger
 0.04 μ sec. Max. for
 1.0 μ sec. trigger

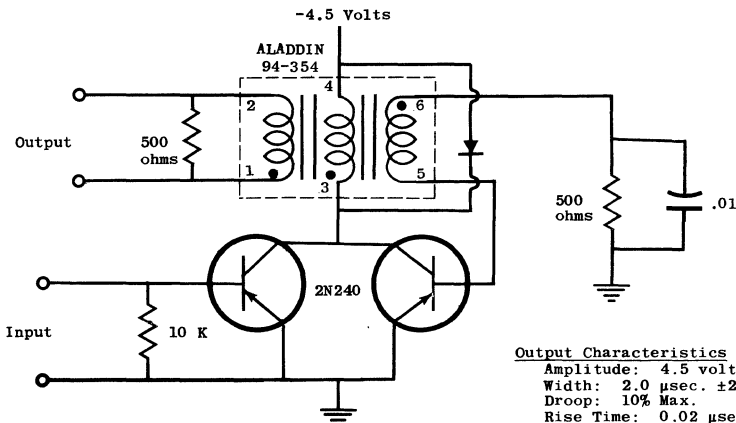
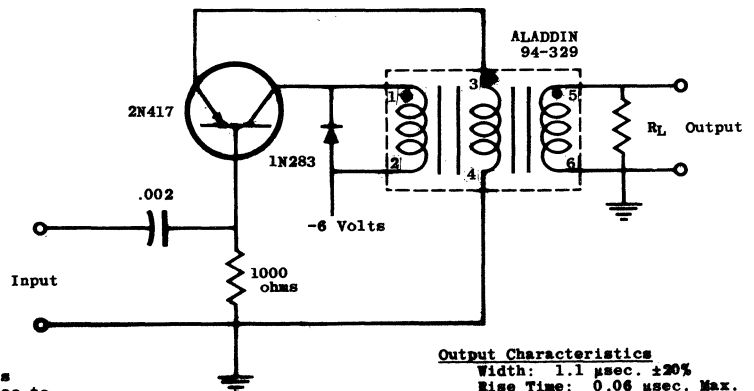

FIG. 19

Input Characteristics
 Amplitude: 2 to 10 volts
 Width: spike
 Rise Time: 0.02 to 1.0 μ sec.
 Repetition Rate: 100 Kc. Max.
 Source Impedance: 200 ohms
 Polarity: negative

Output Characteristics
 Amplitude: 4.5 volts ± 0.5
 Width: 2.0 μ sec. $\pm 20\%$
 Droop: 10% Max.
 Rise Time: 0.02 μ sec. Max. for
 0.02 μ sec. trigger
 0.05 μ sec. Max. for
 1.0 μ sec. trigger

FIG. 20



Input Requirements
 Amplitude: .5 volts
 Rise Time: 0.02 μ sec. to
 1.0 μ sec.
 Source Impedance: 50 ohms
 Repetition Rate: 5000 pps.

Output Characteristics
 Width: 1.1 μ sec. $\pm 20\%$
 Rise Time: 0.06 μ sec. Max.
 for 0.02 μ sec.
 input rise time
 Amplitude: 25 volts $\pm 10\%$
 RL: 1200 ohms

3. MICRO-MINIATURE PULSE TRANSFORMERS

Aladdin's micro-miniature units are particularly well suited to transistor circuitry and other relatively low current applications. In physical size, they are comparable with transistors themselves. They are applicable either as coupling transformers or in blocking oscillator circuits. Tables of performance data on them will be found towards the back of the encyclopedia.

Enough inductance can be built into a micro-miniature unit to support a pulse at least 13 μ sec wide in a 1:1 or 1:1:1 coupling application. As a consequence of miniaturization, moreover, some highly desirable electrical performance characteristics are obtained. For example, the amount of wire required to provide any given inductance value is less than in conventional sized low-power pulse transformer. The distributed capacitance and the leakage inductance are low. This means that very short rise times are feasible.

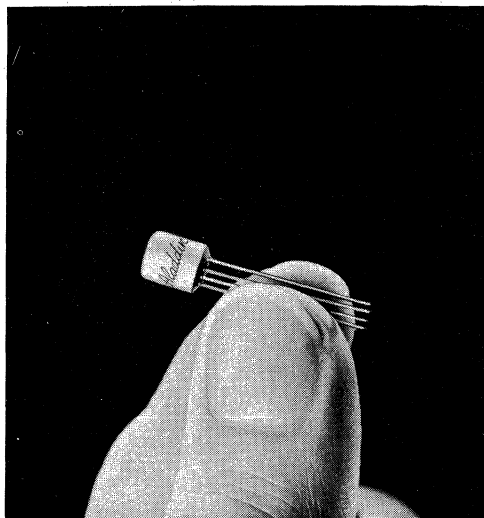

3.1 USE OF DATA TABLES

As stated on page 3, the data tables are set up in such a manner as to simplify the problem of locating the right unit for either a coupling or a blocking oscillator application. Each table of coupling transformer data is arranged in order of maximum pulse width. The blocking oscillator transformer data are also arranged in order of pulse width. Our pulse transformer applications engineers will be happy to help you with the selection of units to be used in other applications.

3.2 TRANSISTOR BLOCKING OSCILLATORS

Aladdin engineers have experimented with a large number of transistor blocking oscillator circuits, including most of those described in recent literature. The circuits of Figures 21, 22 and 23 were selected for inclusion in this encyclopedia from among several developed by Aladdin. It was found that no one circuit or transistor was suitable for all conditions and that a minimum of three circuits would be needed to adequately cover the range of pulse widths and rise times desired. The three circuits have the following general characteristics.

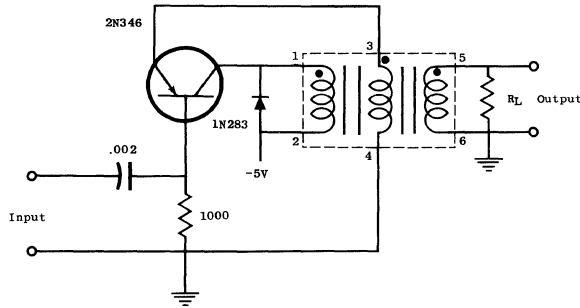

FIG. 21

This circuit is similar in performance to that described above. Except for the fact that it is used for longer pulse widths, the same conditions apply.

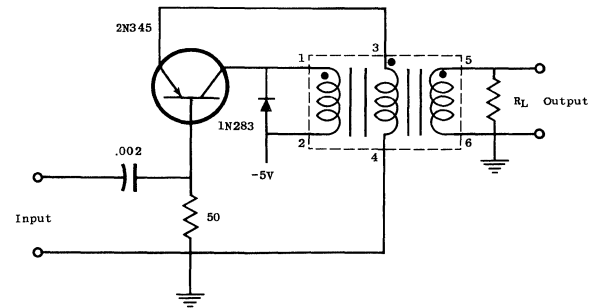

FIG. 22

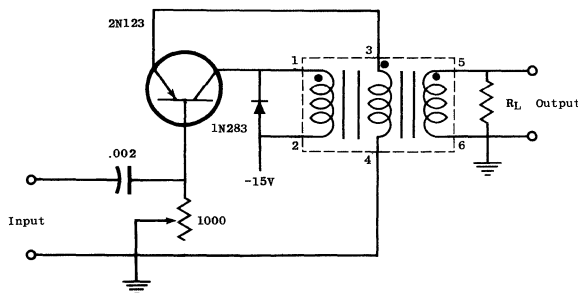

FIG. 23

When used in conjunction with the Aladdin transformer specified, this circuit will produce excellent pulses over a wide range of pulse widths. The chief advantage of this circuit over the other two are:

- (1) Higher output amplitudes.
- (2) Smaller variations in pulse width from transistor to transistor.

The variations that do exist can be compensated for by changing the value of the base resistor.

Rise times produced by this circuit, though fast, are not as fast as for the other two.

3.21 Theory of Transistor Blocking Oscillator Operations

Qualitatively, the operation of the transistor blocking oscillator circuit is nearly identical to that of a circuit employing a vacuum tube. To describe the operation, it is assumed that initially the emitter is biased at zero volts with respect to the base and the transistor is cut off. A negative trigger pulse applied to the base causes the emitter to be biased in the forward, low resistance direction and emitter current flows. Current will then flow in the collector winding of the transformer and a voltage is induced in the emitter winding in such a direction as to increase the forward bias of the emitter. When the current gain around this feedback loop reaches unity, the action becomes regenerative. The trigger pulse is no longer required, and the transistor switches into its saturated region. At this instant, the transformer magnetizing inductance is charging at a nearly constant rate and a nearly constant voltage is induced. This forms the flat top of the output pulse waveform.

Eventually, the collector is not able to sustain the sum of the reflected load current plus the constantly increasing magnetizing current. When magnetizing current can no longer increase, the induced voltage drops to zero and the transistor is forced out of its saturated region.

The energy stored in the transformer primary must now be dissipated in the load. As the magnetizing current decreases, there is a reversal in the polarity of the induced voltage. A diode can be shunted across the collector winding as a precaution against damage to the transistor. For the circuit shown in Figures 21-23, a type 1N283 high conductance diode is satisfactory.

3.3 OTHER TRANSISTORS

The Aladdin transformers shown may be used with other transistors and in other circuit configurations. In most cases, however, IF THE SUPPLY VOLTAGE, TRANSISTOR OR ANY COMPONENT PART IS CHANGED, SUBSTANTIALLY DIFFERENT RESULTS WILL BE OBTAINED.

All transformers designed for transistor blocking oscillator operation have a 4:1 turns ratio between the collector (terminals 1-2) and the emitter (terminals 3-4) windings. The ratio on the output winding is variable, depending on the output voltage and the load specified. Ratios vary from 4:1:4 to 4:1:0.45.

3.4 INPUT TRIGGER PULSE

The output shape is dependent upon the trigger pulse characteristics. There are two types of input pulses which are satisfactory. The first type is a negative spike of short duration similar to that which might be obtained by R-C differentiation of a pulse with a fast rise time. The second type of trigger is a pulse as wide as or wider than the output pulse, with a rather slow rise time. Although other triggers may be used, the above-mentioned have proved to be the most satisfactory. In all cases, the trigger pulse should have a width less than 5% or greater than 100% of the output pulse width. Otherwise, the positive going fall time of the trigger pulse may cause the emitter to turn off, resulting in premature termination of the output pulse.

When fast triggers are used, the rise time of the output pulse is a function of both the input trigger rise time and amplitude. In general, the greater the trigger amplitude, the faster will be the output rise time. Too high a triggering voltage causes excessive overshoot. Trigger pulse amplitudes from five to ten times the minimum requirement will cause overshoot of about 10%.

The characteristics of the pulse used to achieve the rise times listed in the tables were a pulse width of 0.05 microseconds, a rise time of 0.02 microseconds, an amplitude of 2 volts and a source impedance of 50 ohms.

It should also be noted that:

- (1) The minimum trigger amplitude needed is approximately 0.5 volts.
- (2) If, for example, a trigger with a rise time of 1.0 microseconds is used, output rise time approximately double that shown in the tables will result.
- (3) The circuits shown will operate over a wide range of trigger source impedances, provided sufficient amplitude is available. A source impedance as low as 10 or as high as 10,000 ohms will have little effect on the output characteristics. Aladdin can supply impedance matching input transformers, if needed.

3.5 REPETITION RATE

The figure given in the tables for maximum repetition rate represents a safe upper limit and is based on the recovery time of the circuit.

The recovery time limits the maximum repetition rate inasmuch as another pulse may not occur until the end of the recovery time. If the repetition rate of the trigger is increased beyond this point, the oscillator will either trigger on every other pulse or severe narrowing of the pulse will occur.

It is possible to get faster recovery times permitting faster repetition rates. However, since the area under the recovery time curve must remain constant, this is done at the expense of more backswing. A table is given showing values of backswing and maximum repetition rate obtained using a typical transformer and various diodes.

<u>DIODE</u>	<u>BACKSWING</u>	<u>MAX. PRF</u> <u>In KC</u>
1N283	10%	22
1N160	30%	40
1N126	60%	50
1N64	85%	55
1N625	70%	83

3.6 OTHER CONSIDERATIONS

Change of pulse width with transistors:

Aladdin engineers have experimented with many types of transistors for use in blocking oscillator circuits, but have not found one which is ideal in all respects. By far the biggest problem is transistor reproducibility. When used with one particular transistor, Aladdin transformers can be expected to exhibit a pulse width variation of $\pm 20\%$. Transistor variations will frequently change the pulse width variations to $\pm 50\%$.

Pulse widths will vary with operating temperature to some degree in transistor blocking oscillator circuits. At -55°C , pulse widths may be down 4 to 8% from room temperature measurements. At 100°C , pulse widths may be down as much as 30%.

3.7 ENVIRONMENTAL REQUIREMENT

The Aladdin micro-miniature pulse transformers are designed and built to meet the specification of MIL-T-27A. The extremely small size of these units permits the windings to fuse during the 30-second flame test. By placing the transformer in a metal mounting clip, sufficient heat will be dissipated to prevent destruction of the unit.

The transformers will pass all other environmental requirements of MIL-T-27A satisfactorily.

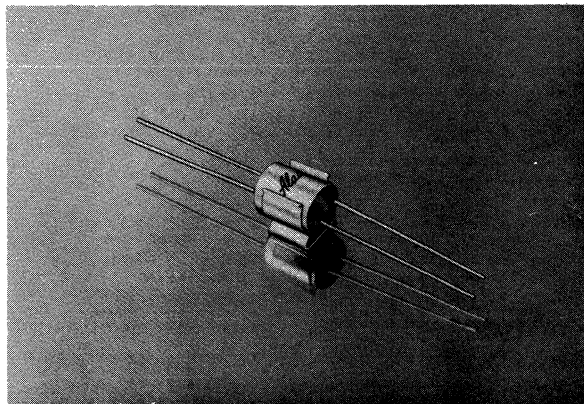

HOME OF
ALADDIN QUALITY COMPONENTS
NASHVILLE, TENN.

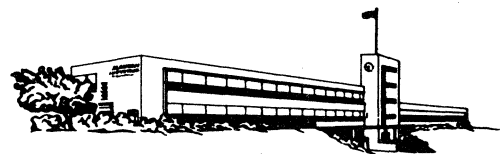

PHASE INVERSION TABLE AND INDEX TO DATA PAGES

Part Number		Turns Ratio	Ground Connection For Phase Inversion	Page No. Miniature Units	Page No. Micro Miniature Units	Part Number		Turns Ratio	Ground Connection For Phase Inversion	Page No. Miniature Units	Page No. Micro Miniature Units
Military Construction Style	Commercial Construction Style					Military Construction Style	Commercial Construction Style				
*-110	**-610	1:1	2 & 3+	28	53	*-151	**-651	1:7	2 & 3	32	56
*-111	**-611	1:1	2 & 3+	28	53	*-151	**-651	7:1	2 & 3	38	62
*-112	**-612	1:1	2 & 3	28	53	*-152	**-652	7:1	2 & 3	38	62
*-113	**-613	1:1	2 & 3	28	53	*-153	**-653	8:1	2 & 3	38	62
*-114	**-614	1:1	2 & 3	28	53	*-154	**-654	1:8	2 & 3	32	57
*-115	**-615	1:1	2 & 3	28	53	*-154	**-654	8:1	2 & 3	38	62
*-116	**-616	1:1	2 & 3	28	53	*-155	**-655	1:8	2 & 3	32	57
*-117	**-617	1:1	2 & 3	28	53	*-155	**-655	8:1	2 & 3	38	62
*-118	**-618	1:1	2 & 3	28	53	*-156	**-656	1:8	2 & 3	32	57
*-119	**-619	1:1	2 & 3	28	53	*-156	**-656	8:1	2 & 3	38	62
*-120	**-620	1:1	2 & 3	28	53	*-157	**-657	9:1	2 & 3	39	63
*-121	**-621	1:2	2 & 3+	29	54	*-158	**-658	1:9	2 & 3	32	57
*-121	**-621	2:1	2 & 3+	34	58	*-158	**-658	9:1	2 & 3	39	63
*-122	**-622	1:2	2 & 3+	29	54	*-159	**-659	1:9	2 & 3	32	57
*-122	**-622	2:1	2 & 3+	34	58	*-159	**-659	9:1	2 & 3	39	63
*-123	**-623	1:2	2 & 3+	29	54	*-160	**-660	1:9	2 & 3	32	57
*-123	**-623	2:1	2 & 3+	34	58	*-160	**-660	9:1	2 & 3	39	63
*-124	**-624	1:2	2 & 3+	29	54	*-161	**-661	10:1	2 & 3	39	63
*-124	**-624	2:1	2 & 3+	34	58	*-162	**-662	1:10	2 & 3	33	57
*-125	**-625	1:2	2 & 3	29	54	*-162	**-662	10:1	2 & 3	39	63
*-125	**-625	2:1	2 & 3	34	58	*-163	**-663	1:10	2 & 3	33	57
*-126	**-626	1:2	2 & 3	29	54	*-163	**-663	10:1	2 & 3	39	63
*-126	**-626	2:1	2 & 3	34	58	*-164	**-664	1:10	2 & 3	33	57
*-127	**-627	1:3	2 & 3+	30	55	*-164	**-664	10:1	2 & 3	39	63
*-127	**-627	3:1	2 & 3+	35	59	*-165	**-665	15:1	2 & 3	40	64
*-128	**-628	1:3	2 & 3+	30	55	*-166	**-666	15:1	2 & 3	40	64
*-128	**-628	3:1	2 & 3+	35	59	*-167	**-667	15:1	2 & 3	40	64
*-129	**-629	1:3	2 & 3+	30	55	*-168	**-668	15:1	2 & 3	40	64
*-129	**-629	3:1	2 & 3+	35	59	*-170	**-670	20:1	2 & 3	40	64
*-130	**-630	1:3	2 & 3+	30	55	*-171	**-671	20:1	2 & 3	40	64
*-130	**-630	3:1	2 & 3+	35	59	*-172	**-672	1:1:1	2, 3 & 5+	41	65
*-131	**-631	1:3	2 & 3	30	55	*-173	**-673	1:1:1	2, 3 & 5+	41	65
*-131	**-631	3:1	2 & 3	35	59	*-174	**-674	1:1:1	2, 3 & 5+	41	65
*-132	**-632	1:3	2 & 3	30	55	*-175	**-675	1:1:1	1, 4 & 6*	41	65
*-132	**-632	3:1	2 & 3	35	59	*-176	**-676	1:1:1	1, 4 & 6*	41	65
*-133	**-633	1:4	2 & 3+	31	55	*-177	**-677	1:1:1	1, 4 & 6*	41	65
*-133	**-633	4:1	2 & 3+	36	60	*-178	**-678	1:1:1	1, 4 & 6*	41	65
*-134	**-634	4:1	2 & 3+	36	60	*-179	**-679	1:1:1	1, 4 & 6*	41	65
*-135	**-635	1:4	2 & 3+	31	55	*-180	**-680	1:1:1	3, 2 & 6*	41	65
*-135	**-635	4:1	2 & 3+	36	60	*-181	**-681	1:1:1	3, 2 & 6*	41	65
*-136	**-636	1:4	2 & 3	31	55	*-183	**-683	1:2:2	2, 3 & 5+	42	66
*-136	**-636	4:1	2 & 3	36	60	*-184	**-684	1:2:2	2, 3 & 5+	42	66
*-137	**-637	1:4	2 & 3	31	55	*-185	**-685	1:2:2	2, 3 & 5	42	66
*-137	**-637	4:1	2 & 3	36	60	*-186	**-686	1:2:2	NR	42	66
*-138	**-638	5:1	2 & 3+	37	61	*-187	**-687	1:2:2	NR	42	66
*-139	**-639	5:1	2 & 3+	37	61	*-188	**-688	1:3:3	2, 3 & 5	42	66
*-140	**-640	1:5	2 & 3+	31	56	*-189	**-689	1:3:3	2, 3 & 5	42	66
*-140	**-640	5:1	2 & 3+	37	61	*-190	**-690	1:3:3	NR	42	66
*-141	**-641	1:5	2 & 3+	31	56	*-191	**-691	1:3:3	NR	42	66
*-141	**-641	5:1	2 & 3+	37	61	*-192	**-692	1:3:3	2, 3 & 5	42	66
*-142	**-642	1:5	2 & 3	31	56	*-193	**-693	1:4:4	NR	43	67
*-142	**-642	5:1	2 & 3	37	61	*-194	**-694	1:4:4	2, 3 & 5	43	67
*-143	**-643	6:1	2 & 3	37	61	*-195	**-695	1:4:4	NR	43	67
*-144	**-644	6:1	2 & 3	37	61	*-196	**-696	1:4:4	NR	43	67
*-145	**-645	6:1	2 & 3	37	61	*-197	**-697	1:5:5	2, 3 & 5	43	67
*-146	**-646	1:6	2 & 3	31	56	*-198	**-698	1:5:5	NR	43	67
*-146	**-646	6:1	2 & 3	37	61	*-199	**-699	1:5:5	NR	43	67
*-147	**-647	1:6	2 & 3	31	56	*-200	**-700	1:5:5	NR	43	67
*-147	**-647	6:1	2 & 3	37	61	*-204	**-704	2:1:1	1, 4 & 6+	44	68
*-148	**-648	1:7	2 & 3	32	56	*-205	**-705	2:1:1	1, 4 & 6+	44	68
*-148	**-648	7:1	2 & 3	38	62	*-206	**-706	2:1:1	1, 4 & 6+	44	68
*-149	**-649	1:7	2 & 3	32	56	*-207	**-707	2:1:1	2, 3 & 5	44	68
*-149	**-649	7:1	2 & 3	38	62	*-208	**-708	2:1:1	2, 3 & 5	44	68
*-150	**-650	1:7	2 & 3	32	56	*-209	**-709	2:1:1	NR	44	68
*-150	**-650	7:1	2 & 3	38	62	*-210	**-710	2:1:1	NR	44	68

Explanation of Symbols:

- * Includes 23, 02, 94 and 20 series. See appropriate data table for list of styles available.
- ** Includes 90 and 92 series.
- + Units will operate satisfactorily but rise time may slightly exceed that specified in tables.
- NR Not recommended for phase inversion use.
- NA Not available.
- * Ground 2, 3 and 5 in micro-miniature units.

Micro-Miniature Section

PHASE INVERSION TABLE AND INDEX TO DATA PAGES

Part Number Military Construction Style	Commercial Construction Style	Turns Ratio	Ground Connection For Phase Inversion	Page No. Miniature Units	Page No. Micro Miniature Units	Part Number Military Construction Style	Commercial Construction Style	Turns Ratio	Ground Connection For Phase Inversion	Page No. Miniature Units	Page No. Micro Miniature Units
*-211	**711	3:1:1	1, 4 & 6 ⁺	45	69	*-338	**838	3:1	1 & 4	NA	59
*-212	**712	3:1:1	1, 4 & 6 ⁺	45	69	*-345	**845	1:1	2 & 3	28	NA
*-213	**713	3:1:1	1, 4 & 6 ⁺	45	69	*-347	**847	1:5	1 & 4	NA	56
*-214	**714	3:1:1	1, 4 & 6	45	69	*-347	**847	5:1	1 & 4	NA	61
*-215	**715	3:1:1	1, 4 & 6	45	69	94-357		3:3:2	1, 4 & 5	NA	69
*-216	**716	3:1:1	1, 4 & 6	45	69	*-358	**858	2:1	2 & 3 ⁺	34	NA
*-217	**717	4:1:1	1, 4 & 6 ⁺	46	70	*-389	**889	30:1	2 & 3	40	NA
*-218	**718	4:1:1	1, 4 & 6 ⁺	46	70	*-390	**890	3:3:1	2 & 3 ⁺	35	NA
*-219	**719	4:1:1	1, 4 & 6 ⁺	46	70	*-391	**891	3:1:1	NR	45	NA
*-220	**720	4:1:1	1, 4 & 6	46	70	*-392	**892	1:1	2 & 3 ⁺	28	NA
*-221	**721	4:1:1	1, 4 & 6	46	70	*-393	**893	1:1	NR	28	NA
*-222	**722	5:1:1	1, 4 & 6 ⁺	46	70	*-394	**894	1:9	2 & 3	32	NA
*-223	**723	5:1:1	1, 4 & 6 ⁺	46	70	*-394	**894	9:1	2 & 3	39	NA
*-224	**724	5:1:1	1, 4 & 6 ⁺	46	70	*-395	**895	1:1	2 & 3	28	NA
*-225	**725	5:1:1	1, 4 & 6	46	70	*-396	**896	10:1	1 & 4	39	NA
*-226	**726	5:1:1	1, 4 & 6	46	70	*-397	**897	1:8	2 & 3	32	NA
*-227	**727	6:1:1	1, 4 & 6 ⁺	47	71	*-397	**897	8:1	2 & 3	38	NA
*-228	**728	6:1:1	1, 4 & 6 ⁺	47	71	*-398	**898	1.67:1	1 & 4	34	NA
*-229	**729	6:1:1	1, 4 & 6	47	71	*-399	**899	1:2.5	2 & 3	30	NA
*-230	**730	6:1:1	1, 4 & 6	47	71	*-399	**899	2.5:1	2 & 3	35	NA
*-231	**731	6:1:1	1, 4 & 6	47	71	*-401	**901	1:4	1 & 4	31	NA
*-232	**732	7:1:1	1, 4 & 6 ⁺	47	71	*-401	**901	4:1	1 & 4	36	NA
*-233	**733	7:1:1	1, 4 & 6 ⁺	47	71	*-484	**984	1:1	B/O	51	NA
*-234	**734	7:1:1	1, 4 & 6 ⁺	47	71	*-485	**985	1:1	B/O	51	NA
*-235	**735	7:1:1	1, 4 & 6	47	71	*-486	**986	1:1	B/O	51	NA
*-236	**736	7:1:1	1, 4 & 6 ⁺	47	71	*-487	**987	1:1	B/O	51	NA
*-237	**737	8:1:1	1, 4 & 6 ⁺	48	72	*-488	**988	1:1	B/O	51	NA
*-238	**738	8:1:1	1, 4 & 6 ⁺	48	72	*-489	**989	1:1	B/O	51	NA
*-239	**739	8:1:1	1, 4 & 6 ⁺	48	72	*-490	**990	1:1	B/O	51	NA
*-240	**740	8:1:1	1, 4 & 6	48	72	*-491	**991	1:1	B/O	51	NA
*-241	**741	8:1:1	1, 4 & 6 ⁺	48	72	*-492	**992	1:1	B/O	51	NA
*-242	**742	9:1:1	1, 4 & 6	48	72	*-493	**993	1:1:1	B/O	52	NA
*-243	**743	9:1:1	1, 4 & 6	48	72	*-494	**994	1:1:1	B/O	52	NA
*-244	**744	9:1:1	1, 4 & 6	48	72	*-495	**995	1:1:1	B/O	52	NA
*-245	**745	9:1:1	1, 4 & 6	48	72	*-496	**996	1:1:1	B/O	52	NA
*-246	**746	9:1:1	1, 4 & 6	48	72	*-497	**997	1:1:1	B/O	52	NA
*-247	**747	10:1:1	1, 4 & 6	49	73	*-498	**998	1:1:1	B/O	52	NA
*-248	**748	10:1:1	1, 4 & 6	49	73	*-499	**999	1:1:1	B/O	52	NA
*-249	**749	10:1:1	1, 4 & 6	49	73	*-500	**1000	1:1:1	B/O	52	NA
*-250	**750	10:1:1	1, 4 & 6	49	73	*-501	**1001	1:1:1	B/O	52	NA
*-251	**751	10:1:1	1, 4 & 6	49	73	94-672		4:1:4	B/O	NA	75
*-252	**752	15:1:1	1, 4 & 6	49	74	94-673		4:1:3	B/O	NA	75
*-253	**753	15:1:1	1, 4 & 6	49	74	94-674		4:1:2	B/O	NA	75
*-254	**754	15:1:1	1, 4 & 6	49	74	94-675		4:1:1.3	B/O	NA	75
*-255	**755	15:1:1	1, 4 & 6	49	74	94-676		4:1:1.7	B/O	NA	75
*-256	**756	20:1:1	1, 4 & 6	50	74	94-677		4:1:4	B/O	NA	75
*-257	**757	20:1:1	1, 4 & 6	50	74	94-678		4:1:3	B/O	NA	75
*-258	**758	20:1:1	1, 4 & 6	50	74	94-679		4:1:2.3	B/O	NA	75
*-263	**763	1:4	1 & 4	NA	55	94-680		4:1:1.3	B/O	NA	75
*-263	**763	4:1	1 & 4	NA	60	94-681		4:1:6	B/O	NA	75
*-263	**763	4:1	1 & 4	NA	60	94-681		4:1:6	B/O	NA	75
*-283	**783	1:1:1	1, 5 & 3	41	NA	94-682		4.2:1:4.4	B/O	NA	75
*-293	**793	10:1	1 & 4	39	NA	94-683		4.2:1:3.4	B/O	NA	75
*-296	**796	5:1	1 & 4 ⁺	37	NA	94-684		4.2:1:2.1	B/O	NA	75
*-299	**799	4:1	1 & 4	36	NA	94-685		4.2:1:1.4	B/O	NA	75
*-302	**802	10:5:1	NR	50	73	94-686		4.2:1:6	B/O	NA	75
*-303	**803	1:1	1 & 4 ⁺	28	NA	94-687		4.3:1:4.3	B/O	NA	75
*-304	**804	1:2.5	NR	30	NA	94-688		4.3:1:3.3	B/O	NA	75
*-313	**813	1:2:2	NR	42	NA	94-689		4.3:1:2.3	B/O	NA	75
*-314	**814	1.7:1:1	NR	43	NA	94-690		4.3:1:1.3	B/O	NA	75
*-318	**818	1:2	1 & 4	29	NA	94-691		4.3:1:6	B/O	NA	75
*-318	**818	2:1	1 & 4	34	NA	94-692		4:1:4	B/O	NA	76
*-324	**824	1:1:1	NR	41	NA	94-693		4:1:3.1	B/O	NA	76
*-325	**825	1:1:1	NR	41	NA	94-694		4:1:2.1	B/O	NA	76
*-327	**827	4:2:1	1, 3 & 6	50	NA	94-695		4:1:1.3	B/O	NA	76
*-338	**838	1:3	1 & 4	NA	55	94-696		4:1:6	B/O	NA	76

Explanation of Symbols:

* Includes 23, 02, 94 and 20 series. See appropriate data table for list of styles available.

** Includes 90 and 92 series.

+ Units will operate satisfactorily but rise time may slightly exceed that specified in tables.

NR Not recommended for phase inversion use.

NA Not available.

* Ground 2, 3 and 5 in micro-miniature units.

B/O Blocking oscillator pulse transformer.

Micro-Miniature Section

PHASE INVERSION TABLE AND INDEX TO DATA PAGES

Part Number		Turns Ratio	Ground Connection For Phase Inversion	Page No. Miniature Units	Page No. Micro Miniature Units	Part Number		Turns Ratio	Ground Connection For Phase Inversion	Page No. Miniature Units	Page No. Micro Miniature Units
Military Construction Style	Commercial Construction Style					Military Construction Style	Commercial Construction Style				
94-697		4:1:4	B/O	NA	76	94-737		4:1:4	B/O	NA	77
94-698		4:1:3.1	B/O	NA	76	94-738		4:1:2.6	B/O	NA	77
94-699		4:1:2.1	B/O	NA	76	94-739		4:1:1.8	B/O	NA	77
94-700		4:1:1.2	B/O	NA	76	94-740		4:1:1.1	B/O	NA	77
94-701		4:1:1.6	B/O	NA	76	94-741		4:1:1.4	B/O	NA	77
94-702		4:1:4	B/O	NA	76	94-742		4:1:1:4.1	B/O	NA	77
94-703		4:1:3.1	B/O	NA	76	94-743		4:1:1:2.8	B/O	NA	77
94-704		4:1:2.2	B/O	NA	76	94-744		4:1:1:1.9	B/O	NA	77
94-705		4:1:1.3	B/O	NA	76	94-745		4:1:1:1.1	B/O	NA	77
94-706		4:1:1.6	B/O	NA	76	94-746		4:1:1:1.4	B/O	NA	77
94-707		4:1:4	B/O	NA	76	94-747		3.8:1:3.8	B/O	NA	77
94-708		4:1:3.1	B/O	NA	76	94-748		3.8:1:2.6	B/O	NA	77
94-709		4:1:2.1	B/O	NA	76	94-749		3.8:1:1.7	B/O	NA	77
94-710		4:1:1.2	B/O	NA	76	94-750		3.8:1:1.1	B/O	NA	77
94-711		4:1:1.6	B/O	NA	76	94-751		3.8:1:1.4	B/O	NA	77
94-712		3.9:1:3.9	B/O	NA	76	94-752		3.9:1:3.9	B/O	NA	77
94-713		3.9:1:3.1	B/O	NA	76	94-753		3.9:1:2.6	B/O	NA	77
94-714		3.9:1:2.1	B/O	NA	76	94-754		3.9:1:1.7	B/O	NA	77
94-715		3.9:1:1.2	B/O	NA	76	94-755		3.9:1:1.1	B/O	NA	77
94-716		3.9:1:1.6	B/O	NA	76	94-756		3.9:1:1.4	B/O	NA	77
94-717		4:1:4	B/O	NA	76	94-757		4:1:4	B/O	NA	77
94-718		4:1:3.1	B/O	NA	76	94-758		4:1:2.7	B/O	NA	77
94-719		4:1:2.2	B/O	NA	76	94-759		4:1:1.8	B/O	NA	77
94-720		4:1:1.2	B/O	NA	76	94-760		4:1:1.1	B/O	NA	77
94-721		4:1:1.6	B/O	NA	76	94-761		4:1:1.5	B/O	NA	77
94-722		4:1:4	B/O	NA	76	94-762		4:1:4	B/O	NA	77
94-723		4:1:3.1	B/O	NA	76	94-763		4:1:2.7	B/O	NA	77
94-724		4:1:2.2	B/O	NA	76	94-764		4:1:1.8	B/O	NA	77
94-725		4:1:1.2	B/O	NA	76	94-765		4:1:1.1	B/O	NA	77
94-726		4:1:1.6	B/O	NA	76	94-766		4:1:1.4	B/O	NA	77
94-727		4:1:4	B/O	NA	76	94-767		4:1:4	B/O	NA	77
94-728		4:1:3.1	B/O	NA	76	94-768		4:1:2.7	B/O	NA	77
94-729		4:1:2.2	B/O	NA	76	94-769		4:1:1.8	B/O	NA	77
94-730		4:1:1.2	B/O	NA	76	94-770		4:1:1.1	B/O	NA	77
94-731		4:1:1.6	B/O	NA	76	94-771		4:1:1.4	B/O	NA	77
94-732		4:1:4	B/O	NA	76						
94-733		4:1:3.1	B/O	NA	76						
94-734		4:1:2.1	B/O	NA	76						
94-735		4:1:1.2	B/O	NA	76						
94-736		4:1:1.6	B/O	NA	76						

Explanation of Symbols:

* Includes 23, 02, 94 and 20 series. See appropriate data table for list of styles available.

** Includes 90 and 92 series.

+ Units will operate satisfactorily but rise time may slightly exceed that specified in tables.



NR Not recommended for phase inversion use.

NA Not available.

Ground 2, 3 and 5 in micro-miniature units.



B/O Blocking oscillator pulse transformer.

1:1 TURNS RATIO



Pulse Width Range in Microseconds		Source** Impedance (Ohms)	Load** Impedance (Ohms)	Maximum Rise Time Microseconds	Length (02 & 90 Series)	Aladdin Part Numbers			
Maximum*	Minimum					Double End Units		Single End Units	
									
						Construction		Construction	
						Military	Commercial	Military	Commercial
0.10 to 0.06		56	56	0.030	11/16	02-110	90-610	23-110	92-610
0.20 to 0.03		110	110	0.015	11/16	02-111	90-611	23-111	92-611
0.20 to 0.04		180	180	0.02	11/16	02-112	90-612	23-112	92-612
0.20 to 0.10		120	120	0.05	11/16	02-303	90-803	23-303	92-803
0.25 to 0.10		470	470	0.05	11/16	02-392	90-892	23-392	92-892
0.3 to 0.03		220	220	0.016	11/16	02-114	90-614	23-114	92-614
0.3 to 0.04		82	82	0.02	11/16	02-111	90-611	23-111	92-611
0.3 to 0.04		150	150	0.02	11/16	02-113	90-613	23-113	92-613
0.3 to 0.08		390	390	0.04	13/16	02-395	90-895	23-395	92-895
0.3 to 0.16		15	15	0.08	11/16	02-110	90-610	23-110	92-610
0.35 to 0.10		270	270	0.05	11/16	02-392	90-892	23-392	92-892
0.40 to 0.05		68	68	0.025	11/16	02-111	90-611	23-111	92-611
0.50 to 0.04		110	110	0.02	11/16	02-112	90-612	23-112	92-612
0.50 to 0.05		110	110	0.025	11/16	02-113	90-613	23-113	92-613
0.50 to 0.08		270	270	0.04	13/16	02-395	90-895	23-395	92-895
0.5 to 0.09		51	51	0.045	11/16	02-111	90-611	23-111	92-611
0.5 to 0.10		150	150	0.05	11/16	02-392	90-892	23-392	92-892
0.5 to 0.10		560	560	0.05	11/16	02-393	90-893	23-393	92-893
0.5 to 0.12		39	39	0.06	11/16	02-303	90-803	23-303	92-803
0.6 to 0.10		180	180	0.05	13/16	02-395	90-895	23-395	92-895
0.6 to 0.24		7.5	7.5	0.12	11/16	02-110	90-610	23-110	92-610
0.7 to 0.04		220	220	0.02	11/16	02-115	90-615	23-115	92-615
0.7 to 0.05		82	82	0.025	11/16	02-112	90-612	23-112	92-612
0.7 to 0.08		330	330	0.04	11/16	02-393	90-893	23-393	92-893
0.7 to 0.14		22	22	0.07	11/16	02-303	90-803	23-303	92-803
0.7 to 0.14		100	100	0.07	11/16	02-392	90-892	23-392	92-892
0.8 to 0.03		150	150	0.016	11/16	02-114	90-614	23-114	92-614
0.8 to 0.12		270	270	0.06	11/16	02-345	90-845	23-345	92-845
0.8 to 0.16		100	100	0.08	13/16	02-395	90-895	23-395	92-895
0.9 to 0.16		68	68	0.08	11/16	02-392	90-892	23-392	92-892
1.0 to 0.05		82	82	0.025	11/16	02-113	90-613	23-113	92-613
1.0 to 0.05		150	150	0.025	11/16	02-115	90-615	23-115	92-615
1.0 to 0.07		220	220	0.035	11/16	02-393	90-893	23-393	92-893
1.0 to 0.10		51	51	0.05	11/16	02-112	90-612	23-112	92-612
1.0 to 0.12		560	560	0.06	11/16	02-116	90-616	23-116	92-616
1.0 to 0.48		5	5	0.24	11/16	02-110	90-610	23-110	92-610
1.2 to 0.05		110	110	0.025	11/16	02-114	90-614	23-114	92-614
1.4 to 0.20		47	47	0.10	11/16	02-392	90-892	23-392	92-892
1.4 to 0.14		150	150	0.07	11/16	02-345	90-845	23-345	92-845
1.5 to 0.06		110	110	0.03	11/16	02-114	90-614	23-114	92-614
1.5 to 0.07		82	82	0.035	11/16	02-114	90-614	23-114	92-614
1.5 to 0.10		51	51	0.05	11/16	02-113	90-613	23-113	92-613
1.5 to 0.18	1000	1000	1000	0.09	11/16	02-117	90-617	23-117	92-617
1.8 to 0.14	300	300	300	0.07	11/16	02-116	90-616	23-116	92-616
2.0 to 0.10	82	82	82	0.05	11/16	02-115	90-615	23-115	92-615
2.0 to 0.10	100	100	100	0.05	11/16	02-393	90-893	23-393	92-893
2.0 to 0.32	2000	2000	2000	0.16	11/16	02-118	90-618	23-118	92-618
2.0 to 0.44	2200	2200	2200	0.22	11/16	02-119	90-619	23-119	92-619
2.0 to 0.56	4700	4700	4700	0.28	11/16	02-120	90-620	23-120	92-620
2.2 to 0.14	51	51	51	0.07	11/16	02-114	90-614	23-114	92-614
2.5 to 0.14	100	100	100	0.07	11/16	02-345	90-845	23-345	92-845
2.5 to 0.20	560	560	560	0.10	11/16	02-117	90-617	23-117	92-617
3.0 to 0.30	22	22	22	0.15	11/16	02-392	90-892	23-392	92-892
3.0 to 0.36	1600	1600	1600	0.22	11/16	02-119	90-619	23-119	92-619
3.5 to 0.18	51	51	51	0.09	11/16	02-115	90-615	23-115	92-615
3.5 to 0.19	68	68	68	0.096	11/16	02-345	90-845	23-345	92-845
3.5 to 0.26	180	180	180	0.13	11/16	02-116	90-616	23-116	92-616
4.0 to 0.34	820	820	820	0.17	11/16	02-118	90-618	23-118	92-618
4.0 to 0.46	2700	2700	2700	0.23	11/16	02-120	90-620	23-120	92-620
5.0 to 0.36	33	33	33	0.18	11/16	02-345	90-845	23-345	92-845

* For a 10% droop; transformer may be used for greater pulse widths if more droop can be tolerated.
 ** The generator impedance may be decreased 5%; and the load impedance increased 5%, without changing the specified performance characteristics.

1:1 TURNS RATIO
(Continued)

Pulse Width Range in Microseconds		Source** Impedance (Ohms)	Load** Impedance (Ohms)	Maximum Rise Time Microseconds	Length (02 & 90 Series)	Aladdin Part Numbers			
Maximum*	Minimum					Double End Units		Single End Units	
									
						Construction		Construction	
						Military	Commercial	Military	Commercial
5.0	to 0.38	750	750	0.19	11/16	02-118	90-618	23-118	92-618
5.0	to 0.40	820	820	0.35	11/16	02-119	90-619	23-119	92-619
5.0	to 0.46	2000	2000	0.23	11/16	02-120	90-620	23-120	92-620
5.5	to 0.40	110	110	0.20	11/16	02-116	90-616	23-116	92-616
6.0	to 0.40	220	220	0.20	11/16	02-117	90-617	23-117	92-617
7.0	to 0.54	510	510	0.27	11/16	02-118	90-618	23-118	92-618
7.1	to 0.50	22	22	0.25	11/16	02-345	90-845	23-345	92-845
7.5	to 0.50	82	82	0.25	11/16	02-116	90-616	23-116	92-616
8.0	to 0.54	510	510	0.54	11/16	02-119	90-619	23-119	92-619
8.5	to 0.50	1100	1100	0.25	11/16	02-120	90-620	23-120	92-620
13.0	to 0.52	150	150	0.26	11/16	02-117	90-617	23-117	92-617

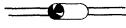

1:2 TURNS RATIO

Pulse Width Range in Microseconds		Source** Impedance (Ohms)	Load** Impedance (Ohms)	Maximum Rise Time Microseconds	Length (02 & 90 Series)	Aladdin Part Numbers			
Maximum*	Minimum					Double End Units		Single End Units	
									
						Construction		Construction	
						Military	Commercial	Military	Commercial
0.1	to 0.10	200	820	0.05	11/16	02-122	90-622	23-122	92-622
0.2	to 0.20	68	270	0.10	11/16	02-121	90-621	23-121	92-621
0.2	to 0.08	130	560	0.04	11/16	02-122	90-622	23-122	92-622
0.3	to 0.06	100	390	0.03	11/16	02-122	90-622	23-122	92-622
0.3	to 0.08	51	220	0.04	11/16	02-121	90-621	23-121	92-621
0.4	to 0.07	150	560	0.035	11/16	02-123	90-623	23-123	92-623
0.4	to 0.08	51	220	0.040	11/16	02-122	90-622	23-122	92-622
0.5	to 0.07	100	390	0.035	11/16	02-123	90-623	23-123	92-623
0.5	to 0.11	200	820	0.055	11/16	02-124	90-624	23-124	92-624
0.8	to 0.28	360	1500	0.140	11/16	02-318	90-818	23-318	92-818
1.0	to 0.14	180	680	0.070	11/16	02-124	90-624	23-124	92-624
1.0	to 0.26	820	3300	0.130	11/16	02-125	90-625	23-125	92-625
1.1	to 0.08	75	330	0.040	11/16	02-123	90-623	23-123	92-623
1.2	to 0.26	300	1200	0.130	11/16	02-318	90-818	23-318	92-818
1.5	to 0.11	68	270	0.055	11/16	02-123	90-623	23-123	92-623
1.9	to 0.32	180	680	0.16	11/16	02-318	90-818	23-318	92-818
2.0	to 0.16	110	470	0.08	11/16	02-124	90-624	23-124	92-624
2.0	to 0.26	430	1800	0.13	11/16	02-125	90-625	23-125	92-625
2.0	to 0.40	1200	4700	0.20	11/16	02-126	90-626	23-126	92-626
3.0	to 0.14	82	330	0.07	11/16	02-124	90-624	23-124	92-624
3.0	to 0.26	300	1100	0.13	11/16	02-125	90-625	23-125	92-625
3.0	to 0.50	120	470	0.25	11/16	02-318	90-818	23-318	92-818
4.0	to 0.40	820	3300	0.20	11/16	02-126	90-626	23-126	92-626
4.0	to 0.50	150	560	0.25	11/16	02-125	90-625	23-125	92-625
4.0	to 0.60	91	360	0.30	11/16	02-318	90-818	23-318	92-818
5.0	to 0.40	390	1500	0.20	11/16	02-126	90-626	23-126	92-626
6.0	to 0.70	68	270	0.35	11/16	02-318	90-818	23-318	92-818
8.0	to 0.46	200	820	0.23	11/16	02-126	90-626	23-126	92-626
8.0	to 1.00	47	180	0.50	11/16	02-318	90-818	23-318	92-818
14.0	to 1.80	22	82	0.90	11/16	02-318	90-818	23-318	92-818



* For a 10% droop; transformer may be used for greater pulse widths if more droop can be tolerated.

** The generator impedance may be decreased 5%, and the load impedance increased 5%, without changing the specified performance characteristics.

1:2.5 TURNS RATIO

Pulse Width Range in Microseconds		Source** Impedance (Ohms)	Load** Impedance (Ohms)	Maximum Rise Time Microseconds	Length (02 & 90 Series)	Aladdin Part Numbers			
Maximum*	Minimum					Double End Units		Single End Units	
									
						Construction Military Commercial		Construction Military Commercial	
0.30	to 0.10	122	762	0.050	11/16	02-399	90-899	23-399	92-899
0.65	to 0.09	44	270	0.045	11/16	02-399	90-899	23-399	92-899
1.10	to 0.14	22	139	0.070	11/16	02-399	90-899	23-399	92-899
5.00	to 0.28	242	1500	0.140	13/16	02-304	90-804	23-304	92-804
7.00	to 0.26	142	888	0.130	13/16	02-304	90-804	23-304	92-804
9.0	to 0.28	90	560	0.14	13/16	02-304	90-804	23-304	92-804
12.5	to 0.40	44	270	0.20	13/16	02-304	90-804	23-304	92-804
17.0	to 0.80	22	138	0.40	13/16	02-304	90-804	23-304	92-804



1:3 TURNS RATIO

Pulse Width Range in Microseconds		Source** Impedance (Ohms)	Load** Impedance (Ohms)	Maximum Rise Time Microseconds	Length (02 & 90 Series)	Aladdin Part Numbers			
Maximum*	Minimum					Double End Units		Single End Units	
									
						Construction Military Commercial		Construction Military Commercial	
0.1	to 0.10	110	1000	0.06	11/16	02-127	90-627	23-127	92-627
0.2	to 0.12	75	680	0.06	11/16	02-127	90-627	23-127	92-627
0.2	to 0.12	130	1200	0.06	11/16	02-128	90-628	23-128	92-628
0.3	to 0.12	68	680	0.06	11/16	02-127	90-627	23-127	92-627
0.3	to 0.10	100	820	0.05	11/16	02-128	90-628	23-128	92-628
0.4	to 0.12	51	470	0.06	11/16	02-127	90-627	23-127	92-627
0.5	to 0.10	68	560	0.05	11/16	02-128	90-628	23-128	92-628
0.5	to 0.14	130	1200	0.07	11/16	02-129	90-629	23-129	92-629
0.5	to 0.24	220	1800	0.12	11/16	02-130	90-630	23-130	92-630
0.7	to 0.10	51	470	0.05	11/16	02-128	90-628	23-128	92-628
1.0	to 0.14	100	820	0.07	11/16	02-129	90-629	23-129	92-629
1.0	to 0.18	150	1200	0.09	11/16	02-130	90-630	23-130	92-630
2.0	to 0.14	68	680	0.07	11/16	02-129	90-629	23-129	92-629
2.0	to 0.18	100	820	0.09	11/16	02-130	90-630	23-130	92-630
2.0	to 0.42	430	3900	0.21	13/16	02-131	90-631	23-131	92-631
2.0	to 1.00	820	8200	0.50	13/16	02-132	90-632	23-132	92-632
3.0	to 0.14	51	470	0.07	11/16	02-129	90-629	23-129	92-629
3.0	to 0.46	300	2700	0.23	13/16	02-131	90-631	23-131	92-631
4.0	to 0.18	75	680	0.09	11/16	02-130	90-630	23-130	92-630
4.0	to 0.46	240	2200	0.23	13/16	02-131	90-631	23-131	92-631
4.0	to 0.7	510	4700	0.35	13/16	02-132	90-632	23-132	92-632
5.0	to 0.5	220	1800	0.25	13/16	02-131	90-631	23-131	92-631
8.0	to 0.7	360	3300	0.35	13/16	02-132	90-632	23-132	92-632
8.0	to 0.7	360	3300	0.35	13/16	02-132	90-632	23-132	92-632



* For a 10% droop; transformer may be used for greater pulse widths if more droop can be tolerated.

** The generator impedance may be decreased 5%, and the load impedance increased 5%, without changing the specified performance characteristics.

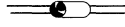

1:4 TURNS RATIO

Pulse Width Range in Microseconds		Source** Impedance (Ohms)	Load** Impedance (Ohms)	Maximum Rise Time Microseconds	Length (02 & 90 Series)	Aladdin Part Numbers			
Maximum*	Minimum					Double End Units		Single End Units	
									
						Construction Military Commercial		Construction Military Commercial	
0.2	to 0.12	68	1200	0.06	11/16	02-133	90-633	23-133	92-633
0.3	to 0.12	56	1000	0.06	11/16	02-133	90-633	23-133	92-633
0.4	to 0.12	51	820	0.06	11/16	02-133	90-633	23-133	92-633
0.5	to 0.28	82	1500	0.14	11/16	02-135	90-635	23-135	92-635
0.6	to 0.14	75	1200	0.07	11/16	02-401	90-901	23-401	92-901
1.0	to 0.14	47	680	0.070	11/16	02-401	90-901	23-401	92-901
1.0	to 0.28	68	1000	0.140	11/16	02-135	90-635	23-135	92-635
1.5	to 0.24	150	2200	0.120	11/16	02-136	90-636	23-136	92-636
1.5	to 0.28	51	820	0.140	11/16	02-135	90-635	23-135	92-635
2.0	to 0.17	22	330	0.085	11/16	02-401	90-901	23-401	92-901
2.5	to 0.22	100	1600	0.11	11/16	02-136	90-636	23-136	92-636
2.5	to 0.64	510	8200	0.32	13/16	02-137	90-637	23-137	92-637
3.0	to 0.24	68	1100	0.12	11/16	02-136	90-636	23-136	92-636
4.0	to 0.50	300	4700	0.25	13/16	02-137	90-637	23-137	92-637
3.0	to 0.28	51	820	0.14	11/16	02-136	90-636	23-136	92-636
5.0	to 0.56	240	3900	0.28	13/16	02-137	90-637	23-137	92-637
6.0	to 0.56	220	3300	0.28	13/16	02-137	90-637	23-137	92-637

1:5 TURNS RATIO

Pulse Width Range in Microseconds		Source** Impedance (Ohms)	Load** Impedance (Ohms)	Maximum Rise Time Microseconds	Length (02 & 90 Series)	Aladdin Part Numbers			
Maximum*	Minimum					Double End Units		Single End Units	
									
						Construction Military Commercial		Construction Military Commercial	
0.5	to 0.46	180	4700	0.23	11/16	02-141	90-641	23-141	92-641
1.0	to 0.18	150	3900	0.09	11/16	02-140	90-640	23-140	92-640
1.0	to 0.34	130	3300	0.17	11/16	02-141	90-641	23-141	92-641
1.5	to 0.22	75	1800	0.11	11/16	02-140	90-640	23-140	92-640
2.0	to 0.22	68	1600	0.11	11/16	02-140	90-640	23-140	92-640
2.5	to 0.24	51	1100	0.12	11/16	02-140	90-640	23-140	92-640
3.0	to 0.28	75	1800	0.14	11/16	02-141	90-641	23-141	92-641
3.0	to 0.80	300	8200	0.40	13/16	02-142	90-642	23-142	92-642
4.0	to 0.56	220	5600	0.28	13/16	02-142	90-642	23-142	92-642
5.0	to 0.28	51	1200	0.14	11/16	02-141	90-641	23-141	92-641
5.0	to 0.62	150	3900	0.31	13/16	02-142	90-642	23-142	92-642
6.0	to 0.66	100	2400	0.33	13/16	02-142	90-642	23-142	92-642



1:6 TURNS RATIO

Pulse Width Range in Microseconds		Source** Impedance (Ohms)	Load** Impedance (Ohms)	Maximum Rise Time Microseconds	Length (02 & 90 Series)	Aladdin Part Numbers			
Maximum*	Minimum					Double End Units		Single End Units	
									
						Construction Military Commercial		Construction Military Commercial	
2.0	to 0.34	110	3900	0.17	11/16	02-146	90-646	23-146	92-646
3.0	to 0.32	82	2700	0.16	11/16	02-146	90-646	23-146	92-646
4.0	to 0.32	75	2700	0.16	11/16	02-146	90-646	23-146	92-646
5.0	to 0.32	68	2200	0.16	11/16	02-146	90-646	23-146	92-646
5.0	to 0.74	240	8200	0.37	13/16	02-147	90-647	23-147	92-647
5.5	to 0.62	150	5600	0.31	13/16	02-147	90-647	23-147	92-647



* For a 10% droop; transformer may be used for greater pulse widths if more droop can be tolerated.

** The generator impedance may be decreased 5%, and the load impedance increased 5%, without changing the specified performance characteristics.



1:7 TURNS RATIO

Pulse Width Range in Microseconds		Source** Impedance (Ohms)	Load** Impedance (Ohms)	Maximum Rise Time Microseconds	Length (02 & 90 Series)	Aladdin Part Numbers			
Maximum*	Minimum					Double End Units		Single End Units	
						 Construction Military Commercial		 Construction Military Commercial	
0.2	to 0.20	62	3300	0.11	11/16	02-148	90-648	23-148	92-648
0.3	to 0.20	51	2200	0.10	11/16	02-148	90-648	23-148	92-648
0.3	to 0.30	100	4700	0.15	11/16	02-149	90-649	23-149	92-649
0.4	to 0.20	51	2200	0.10	11/16	02-149	90-649	23-149	92-649
1.0	to 0.36	68	4700	0.18	11/16	02-150	90-650	23-150	92-650
1.8	to 0.34	62	3300	0.17	11/16	02-150	90-650	23-150	92-650
2.0	to 0.34	51	2700	0.17	11/16	02-150	90-650	23-150	92-650
2.0	to 0.36	82	5600	0.18	13/16	02-151	90-651	23-151	92-651
3.0	to 0.32	68	3900	0.16	13/16	02-151	90-651	23-151	92-651
5.0	to 1.60	430	24000	0.80	13/16	02-152	90-652	23-152	92-652
4.0	to 0.3	62	3300	0.15	13/16	02-151	90-651	23-151	92-651
5.0	to 0.3	51	2700	0.15	13/16	02-151	90-651	23-151	92-651
5.0	to 1.4	360	18000	0.70	13/16	02-152	90-652	23-152	92-652
7.0	to 1.0	240	12000	0.50	13/16	02-152	90-652	23-152	92-652
10.0	to 0.8	180	8200	0.40	13/16	02-152	90-652	23-152	92-652

1:8 TURNS RATIO

Pulse Width Range in Microseconds		Source** Impedance (Ohms)	Load** Impedance (Ohms)	Maximum Rise Time Microseconds	Length (02 & 90 Series)	Aladdin Part Numbers			
Maximum*	Minimum					Double End Units		Single End Units	
						 Construction Military Commercial		 Construction Military Commercial	
0.2	to 0.20	47	2700	0.11	11/16	02-397	90-897	23-397	92-897
0.3	to 0.20	22	1500	0.10	11/16	02-397	90-897	23-397	92-897
0.3	to 0.28	51	3300	0.14	11/16	02-153	90-653	23-153	92-653
0.3	to 0.30	82	5600	0.17	11/16	02-154	90-654	23-154	92-654
0.4	to 0.28	51	3300	0.14	11/16	02-154	90-654	23-154	92-654
1.0	to 0.50	100	6800	0.25	11/16	02-155	90-655	23-155	92-655
1.5	to 0.46	75	4700	0.23	11/16	02-155	90-655	23-155	92-655
2.0	to 0.44	51	3300	0.22	11/16	02-155	90-655	23-155	92-655
2.0	to 0.64	130	8200	0.32	13/16	02-156	90-656	23-156	92-656
2.5	to 0.50	100	5600	0.25	13/16	02-156	90-656	23-156	92-656
3.0	to 0.44	75	4700	0.22	13/16	02-156	90-656	23-156	92-656
4.0	to 0.38	56	3000	0.19	13/16	02-156	90-656	23-156	92-656



1:9 TURNS RATIO

Pulse Width Range in Microseconds		Source** Impedance (Ohms)	Load** Impedance (Ohms)	Maximum Rise Time Microseconds	Length (02 & 90 Series)	Aladdin Part Numbers			
Maximum*	Minimum					Double End Units		Single End Units	
						 Construction Military Commercial		 Construction Military Commercial	
0.3	to 0.28	51	4700	0.14	11/16	02-157	90-657	23-157	92-657
0.8	to 0.28	51	3900	0.14	11/16	02-158	90-658	23-158	92-658
0.8	to 0.60	47	3300	0.30	11/16	02-394	90-894	23-394	92-894
1.0	to 0.48	100	8200	0.24	11/16	02-159	90-659	23-159	92-659
2.0	to 0.38	51	3900	0.19	11/16	02-159	90-659	23-159	92-659
2.5	to 0.70	62	4700	0.35	13/16	02-160	90-660	23-160	92-660
3.0	to 0.70	51	3900	0.35	13/16	02-160	90-660	23-160	92-660
1.0	to 0.50	22	1800	0.25	11/16	02-394	90-894	23-394	92-894



* For a 10% droop; transformer may be used for greater pulse widths if more droop can be tolerated.

** The generator impedance may be decreased 5%, and the load impedance increased 5%, without changing the specified performance characteristics.

1:10 TURNS RATIO

Pulse Width Range in Microseconds		Source** Impedance (Ohms)	Load** Impedance (Ohms)	Maximum Rise Time Microseconds	Length (02 & 90 Series)	Aladdin Part Numbers			
Maximum*	Minimum					Double End Units		Single End Units	
									
						Construction		Construction	
						Military Commercial		Military Commercial	
0.2	to 0.20	51	4700	0.13	11/16	02-161	90-661	23-161	92-661
0.4	to 0.34	51	5600	0.17	11/16	02-162	90-662	23-162	92-662
1.0	to 0.60	82	8200	0.30	13/16	02-163	90-663	23-163	92-663
2.0	to 0.44	51	5600	0.22	13/16	02-163	90-663	23-163	92-663
2.5	to 0.62	82	8200	0.31	13/16	02-164	90-664	23-164	92-664
4.0	to 0.50	51	5600	0.25	13/16	02-164	90-664	23-164	92-664



1:15 TURNS RATIO

Pulse Width Range in Microseconds		Source** Impedance (Ohms)	Load** Impedance (Ohms)	Maximum Rise Time Microseconds	Length (02 & 90 Series)	Aladdin Part Numbers			
Maximum*	Minimum					Double End Units		Single End Units	
									
						Construction		Construction	
						Military Commercial		Military Commercial	
0.8	to 0.6	51	11000	0.30	11/16	02-167	90-667	23-167	92-667
1.5	to 1.1	75	18000	0.55	13/16	02-168	90-668	23-168	92-668
2.5	to 0.8	51	12000	0.40	13/16	02-168	90-668	23-168	92-668

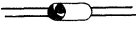

* For a 10% droop; transformer may be used for greater pulse widths if more droop can be tolerated.

** The generator impedance may be decreased 5%, and the load impedance increased 5%, without changing the specified performance characteristics.

1.67:1 TURNS RATIO

Pulse Width Range in Microseconds		Source** Impedance (Ohms)	Load** Impedance (Ohms)	Maximum Rise Time Microseconds	Length (02 & 90 Series)	Aladdin Part Numbers			
Maximum*	Minimum					Double End Units		Single End Units	
									
						Construction Military Commercial		Construction Military Commercial	
0.25	to 0.06	300	100	0.032	11/16	02-398	90-898	23-398	92-898
0.40	to 0.07	240	82	0.036	11/16	02-398	90-898	23-398	92-898
0.50	to 0.08	200	68	0.040	11/16	02-398	90-898	23-398	92-898
0.60	to 0.12	150	56	0.060	11/16	02-398	90-898	23-398	92-898

2:1 TURNS RATIO

Pulse Width Range in Microseconds		Source** Impedance (Ohms)	Load** Impedance (Ohms)	Maximum Rise Time Microseconds	Length (02 & 90 Series)	Aladdin Part Numbers			
Maximum*	Minimum					Double End Units		Single End Units	
									
						Construction Military Commercial		Construction Military Commercial	
0.10	to 0.10	430	100	0.060	11/16	02-121	90-621	23-121	92-621
0.18	to 0.16	300	75	0.080	11/16	02-121	90-621	23-121	92-621
0.20	to 0.05	300	75	0.025	11/16	02-122	90-622	23-122	92-622
0.20	to 0.07	130	33	0.035	11/16	02-358	90-858	23-358	92-858
0.30	to 0.09	100	27	0.045	11/16	02-358	90-858	23-358	92-858
0.3	to 0.18	150	39	0.09	11/16	02-121	90-621	23-121	92-621
0.4	to 0.10	130	33	0.05	11/16	02-122	90-622	23-122	92-622
0.5	to 0.06	620	150	0.03	11/16	02-123	90-623	23-123	92-623
0.5	to 0.20	110	27	0.10	11/16	02-121	90-621	23-121	92-621
0.5	to 0.12	62	15	0.06	11/16	02-358	90-858	23-358	92-858
0.5	to 0.14	39	10	0.070	11/16	02-358	90-858	23-358	92-858
0.5	to 0.20	3300	680	0.100	11/16	02-124	90-624	23-124	92-624
0.7	to 0.20	2200	560	0.100	11/16	02-318	90-818	23-318	92-818
0.9	to 0.28	4700	1100	0.140	11/16	02-125	90-625	23-125	92-625
1.0	to 0.07	300	68	0.035	11/16	02-123	90-623	23-123	92-623
1.0	to 0.16	1000	220	0.08	11/16	02-124	90-624	23-124	92-624
1.0	to 0.18	91	22	0.09	11/16	02-122	90-622	23-122	92-622
1.0	to 0.18	1300	330	0.09	11/16	02-318	90-818	23-318	92-818
1.0	to 0.26	56	15	0.13	11/16	02-121	90-621	23-121	92-621
1.4	to 0.20	1000	270	0.10	11/16	02-318	90-818	23-318	92-818
1.5	to 0.36	4700	1200	0.180	13/16	02-126	90-626	23-126	92-626
1.5	to 0.12	430	100	0.060	11/16	02-124	90-624	23-124	92-624
2.0	to 0.10	220	56	0.050	11/16	02-123	90-623	23-123	92-623
2.0	to 0.11	750	180	0.055	11/16	02-124	90-624	23-124	92-624
2.0	to 0.22	2000	470	0.110	11/16	02-125	90-625	23-125	92-625
2.0	to 0.26	68	15	0.130	11/16	02-122	90-622	23-122	92-622
3.0	to 0.11	130	33	0.055	11/16	02-123	90-623	23-123	92-623
3.0	to 0.26	51	12	0.130	11/16	02-122	90-622	23-122	92-622
3.0	to 0.26	910	220	0.130	11/16	02-125	90-625	23-125	92-625
4.0	to 0.34	470	120	0.170	11/16	02-318	90-818	23-318	92-818
4.0	to 0.36	1800	470	0.18	13/16	02-126	90-626	23-126	92-626
5.0	to 0.38	390	100	0.19	11/16	02-318	90-818	23-318	92-818
5.0	to 0.38	620	150	0.19	11/16	02-125	90-625	23-125	92-625
6.0	to 0.36	1000	270	0.18	13/16	02-126	90-626	23-126	92-626
6.0	to 0.50	330	82	0.25	11/16	02-318	90-818	23-318	92-818
8.0	to 0.36	820	220	0.18	13/16	02-126	90-626	23-126	92-626

* For a 10% droop; transformer may be used for greater pulse widths if more droop can be tolerated.

** The generator impedance may be decreased 5%, and the load impedance increased 5%, without changing the specified performance characteristics.

2.5:1 TURNS RATIO

Pulse Width Range in Microseconds			Source** Impedance (Ohms)	Load** Impedance (Ohms)	Maximum Rise Time Microseconds	Length (02 & 90 Series)	Aladdin Part Numbers			
Maximum*	Minimum	Double End Units					Single End Units		Construction Military Commercial	Construction Military Commercial
0.30	to	0.12	620	100	0.06	11/16	02-399	90-899	23-399	92-899
0.60	to	0.10	360	56	0.05	11/16	02-399	90-899	23-399	92-899
1.35	to	0.16	140	22	0.08	11/16	02-399	90-899	23-399	92-899
5.00	to	0.24	1000	150	0.12	13/16	02-304	90-804	23-304	92-804
8.00	to	0.28	620	100	0.14	13/16	02-304	90-804	23-304	92-804

3:1 TURNS RATIO

Pulse Width Range in Microseconds			Source** Impedance (Ohms)	Load** Impedance (Ohms)	Maximum Rise Time Microseconds	Length (02 & 90 Series)	Aladdin Part Numbers			
Maximum*	Minimum	Double End Units					Single End Units		Construction Military Commercial	Construction Military Commercial
0.2	to	0.12	680	82	0.06	11/16	02-127	90-627	23-127	92-627
0.3	to	0.12	510	56	0.06	11/16	02-127	90-627	23-127	92-627
0.4	to	0.12	360	39	0.06	11/16	02-127	90-627	23-127	92-627
0.5	to	0.12	300	33	0.06	11/16	02-127	90-627	23-127	92-627
0.5	to	0.12	1200	150	0.06	11/16	02-130	90-630	23-130	92-630
0.5	to	0.14	300	27	0.07	11/16	02-128	90-628	23-128	92-628
0.5	to	0.16	820	82	0.08	11/16	02-129	90-629	23-129	92-629
1.0	to	0.14	680	68	0.07	11/16	02-129	90-629	23-129	92-629
1.0	to	0.16	750	82	0.08	11/16	02-130	90-630	23-130	92-630
1.0	to	0.18	180	20	0.09	11/16	02-128	90-628	23-128	92-628
1.5	to	0.40	5600	680	0.20	13/16	02-131	90-631	23-131	92-631
2.0	to	0.14	510	47	0.07	11/16	02-129	90-629	23-129	92-629
2.0	to	0.26	130	15	0.13	11/16	02-128	90-628	23-128	92-628
2.0	to	0.40	3900	470	0.20	13/16	02-131	90-631	23-131	92-631
3.0	to	0.16	300	27	0.08	11/16	02-129	90-629	23-129	92-629
3.0	to	0.42	2200	270	0.21	13/16	02-131	90-631	23-131	92-631
3.0	to	0.70	6800	680	0.35	13/16	02-132	90-632	23-132	92-632
4.0	to	0.20	510	56	0.10	11/16	02-130	90-630	23-130	92-630
5.0	to	0.40	91	10	0.20	11/16	02-128	90-628	23-128	92-628
4.0	to	0.60	4700	560	0.30	13/16	02-132	90-632	23-132	92-632
5.0	to	0.56	1500	150	0.28	13/16	02-131	90-631	23-131	92-631
6.0	to	0.22	300	33	0.11	11/16	02-130	90-630	23-130	92-630
7.0	to	0.60	3300	390	0.30	13/16	02-132	90-632	23-132	92-632
10.0	to	0.70	1800	220	0.35	13/16	02-132	90-632	23-132	92-632



3.3:1 TURNS RATIO

Pulse Width Range in Microseconds			Source** Impedance (Ohms)	Load** Impedance (Ohms)	Maximum Rise Time Microseconds	Length (02 & 90 Series)	Aladdin Part Numbers			
Maximum*	Minimum	Double End Units					Single End Units		Construction Military Commercial	Construction Military Commercial
0.3	to	0.22	620	56	0.11	11/16	02-390	90-890	23-390	92-890
0.5	to	0.26	200	18	0.13	11/16	02-390	90-890	23-390	92-890
0.6	to	0.24	240	22	0.12	11/16	02-390	90-890	23-390	92-890

* For a 10% droop; transformer may be used for greater pulse widths if more droop can be tolerated.

** The generator impedance may be decreased 5%, and the load impedance increased 5%, without changing the specified performance characteristics.



4:1 TURNS RATIO

Pulse Width Range in Microseconds		Source** Impedance (Ohms)	Load** Impedance (Ohms)	Maximum Rise Time Microseconds	Length (02 & 90 Series)	Aladdin Part Numbers			
Maximum*	Minimum					Double End Units		Single End Units	
						 Construction Military		 Construction Commercial	
						Military	Commercial	Military	Commercial
0.09	to 0.09	430	33	0.045	11/16	02-299	90-799	23-299	92-799
0.14	to 0.09	360	22	0.045	11/16	02-299	90-799	23-299	92-799
0.17	to 0.10	300	18	0.050	11/16	02-299	90-799	23-299	92-799
0.30	to 0.16	620	39	0.080	11/16	02-133	90-633	23-133	92-633
0.43	to 0.18	2400	150	0.090	11/16	02-401	90-901	23-401	92-901
0.50	to 0.16	430	27	0.08	11/16	02-134	90-634	23-134	92-634
0.50	to 0.16	1500	100	0.08	11/16	02-135	90-635	23-135	92-635
0.50	to 0.20	360	22	0.10	11/16	02-133	90-633	23-133	92-633
0.67	to 0.14	1300	82	0.07	11/16	02-401	90-901	23-401	92-901
0.80	to 0.18	2400	150	0.09	11/16	02-136	90-636	23-136	92-636
0.9	to 0.14	750	47	0.07	11/16	02-401	90-901	23-401	92-901
1.0	to 0.20	300	22	0.10	11/16	02-134	90-634	23-134	92-634
1.0	to 0.28	1200	68	0.14	11/16	02-135	90-635	23-135	92-635
1.0	to 0.30	240	15	0.15	11/16	02-133	90-633	23-133	92-633
1.3	to 0.16	510	33	0.08	11/16	02-401	90-901	23-401	92-901
1.3	to 0.20	1600	100	0.10	11/16	02-136	90-636	23-136	92-636
1.5	to 0.28	680	39	0.14	11/16	02-135	90-635	23-135	92-635
2.0	to 0.24	360	22	0.12	11/16	02-401	90-901	23-401	92-901
2.0	to 0.26	150	10	0.13	11/16	02-134	90-634	23-134	92-634
2.0	to 0.32	430	22	0.16	11/16	02-135	90-635	23-135	92-635
2.0	to 0.40	150	10	0.20	11/16	02-133	90-633	23-133	92-633
2.0	to 0.50	5600	330	0.25	13/16	02-137	90-637	23-137	92-637
2.5	to 0.20	1100	68	0.10	11/16	02-136	90-636	23-136	92-636
3.0	to 0.24	910	56	0.12	11/16	02-136	90-636	23-136	92-636
3.0	to 0.50	4700	270	0.25	13/16	02-137	90-637	23-137	92-637
4.0	to 0.56	3300	220	0.28	13/13	02-137	90-637	23-137	92-637
5.0	to 0.56	2700	180	0.28	13/16	02-137	90-637	23-137	92-637



* For a 10% droop; transformer may be used for greater pulse widths if more droop can be tolerated.

** The generator impedance may be decreased 5%, and the load impedance increased 5%, without changing the specified performance characteristics.

5:1 TURNS RATIO

Pulse Width Range in Microseconds		Source** Impedance (Ohms)	Load** Impedance (Ohms)	Maximum Rise Time Microseconds	Length (02 & 90 Series)	Aladdin Part Numbers			
Maximum*	Minimum					Double End Units		Single End Units	
									
						Construction		Construction	
						Military	Commercial	Military	Commercial
0.10	to 0.10	560	22	0.07	11/16	02-139	90-639	23-139	92-639
0.10	to 0.10	1200	47	0.06	11/16	02-138	90-638	23-138	92-638
0.30	to 0.14	680	27	0.07	11/16	02-138	90-638	23-138	92-638
0.45	to 0.20	2200	82	0.10	11/16	02-296	90-796	23-296	92-796
0.50	to 0.12	820	33	0.06	11/16	02-139	90-639	23-139	92-639
0.5	to 0.16	430	15	0.08	11/16	02-138	90-638	23-138	92-638
0.5	to 0.46	8200	330	0.23	11/16	02-141	90-641	23-141	92-641
0.8	to 0.22	1400	56	0.11	11/16	02-296	90-796	23-296	92-796
1.0	to 0.16	1800	68	0.08	11/16	02-140	90-640	23-140	92-640
1.0	to 0.22	240	10	0.11	11/16	02-138	90-638	23-138	92-638
1.0	to 0.24	2700	120	0.12	11/16	02-141	90-641	23-141	92-641
1.2	to 0.22	1000	39	0.11	11/16	02-296	90-796	23-296	92-796
1.5	to 0.16	470	18	0.08	11/16	02-139	90-639	23-139	92-639
1.5	to 0.16	2200	82	0.08	11/16	02-140	90-640	23-140	92-640
1.5	to 0.22	2400	100	0.11	11/16	02-141	90-641	23-141	92-641
2.0	to 0.22	2200	82	0.11	11/16	02-141	90-641	23-141	92-641
2.0	to 0.24	240	10	0.12	11/16	02-139	90-639	23-139	92-639
2.0	to 0.36	560	22	0.18	11/16	02-296	90-796	23-296	92-796
3.0	to 0.16	1000	39	0.08	11/16	02-140	90-640	23-140	92-640
3.5	to 0.50	360	15	0.25	11/16	02-296	90-796	23-296	92-796
4.0	to 0.60	5600	240	0.30	13/16	02-142	90-642	23-142	92-642
5.0	to 0.42	510	18	0.21	11/16	02-140	90-640	23-140	92-640
5.0	to 0.56	3900	150	0.28	13/16	02-142	90-642	23-142	92-642
6.0	to 0.56	3300	120	0.28	13/16	02-142	90-642	23-142	92-642
9.0	to 0.70	2000	82	0.35	13/16	02-142	90-642	23-142	92-642

6:1 TURNS RATIO

Pulse Width Range in Microseconds		Source** Impedance (Ohms)	Load** Impedance (Ohms)	Maximum Rise Time Microseconds	Length (02 & 90 Series)	Aladdin Part Numbers			
Maximum*	Minimum					Double End Units		Single End Units	
									
						Construction		Construction	
						Military	Commercial	Military	Commercial
0.5	to 0.18	820	22	0.09	11/16	02-143	90-643	23-143	92-643
0.5	to 0.16	1000	27	0.08	11/16	02-144	90-644	23-144	92-644
1.0	to 0.20	680	18	0.10	11/16	02-144	90-644	23-144	92-644
1.0	to 0.20	2200	56	0.10	11/16	02-145	90-645	23-145	92-645
1.0	to 0.24	360	10	0.12	11/16	02-143	90-643	23-143	92-643
1.0	to 0.32	6800	180	0.16	11/16	02-146	90-646	23-146	92-646
2.0	to 0.20	1800	47	0.10	11/16	02-145	90-645	23-145	92-645
2.0	to 0.24	300	8.2	0.12	11/16	02-143	90-643	23-143	92-643
2.0	to 0.24	430	10	0.12	11/16	02-144	90-644	23-144	92-644
2.0	to 0.32	3300	100	0.16	11/16	02-146	90-646	23-146	92-646
3.0	to 0.26	1000	27	0.13	11/16	02-145	90-645	23-145	92-645
3.0	to 0.32	1800	47	0.16	11/16	02-146	90-646	23-146	92-646
3.0	to 0.40	180	4.7	0.20	11/16	02-143	90-643	23-143	92-643
3.0	to 0.70	16000	470	0.35	13/16	02-147	90-647	23-147	92-647
4.0	to 0.50	180	4.7	0.25	11/16	02-144	90-644	23-144	92-644
4.0	to 0.60	8200	300	0.26	13/16	02-147	90-647	23-147	92-647
5.0	to 0.32	1500	39	0.16	11/16	02-146	90-646	23-146	92-646
5.0	to 0.34	680	18	0.17	11/16	02-145	90-645	23-145	92-645
6.0	to 0.52	11000	220	0.30	13/16	02-147	90-647	23-147	92-647
8.0	to 0.58	3900	110	0.29	13/16	02-147	90-647	23-147	92-647

* For a 10% droop; transformer may be used for greater pulse widths if more droop can be tolerated.

** The generator impedance may be decreased 5%, and the load impedance increased 5%, without changing the specified performance characteristics.

7:1 TURNS RATIO

Pulse Width Range in Microseconds		Source** Impedance (Ohms)	Load** Impedance (Ohms)	Maximum Rise Time Microseconds	Length (02 & 90 Series)	Aladdin Part Numbers			
Maximum*	Minimum					Double End Units	Single End Units		
						Construction		Construction	
						Military	Commercial	Military	Commercial
0.3	to 0.15	1600	36	0.075	11/16	02-148	90-648	23-148	92-648
0.5	to 0.12	1000	22	0.060	11/16	02-148	90-648	23-148	92-648
0.5	to 0.20	1800	39	0.100	11/16	02-149	90-649	23-149	92-649
0.6	to 0.38	8200	150	0.190	11/16	02-150	90-650	23-150	92-650
1.0	to 0.14	750	15	0.070	11/16	02-148	90-648	23-148	92-648
1.0	to 0.20	1000	22	0.10	11/16	02-149	90-649	23-149	92-649
1.0	to 0.32	4700	110	0.16	11/16	02-150	90-650	23-150	92-650
1.0	to 0.32	5600	120	0.16	13/16	02-151	90-651	23-151	92-651
1.5	to 0.20	510	11	0.10	11/16	02-148	90-648	23-148	92-648
1.5	to 0.32	4700	100	0.16	13/16	02-151	90-651	23-151	92-651
2.0	to 0.26	470	10	0.13	11/16	02-149	90-649	23-149	92-649
2.0	to 0.30	3900	82	0.15	13/16	02-151	90-651	23-151	92-651
2.0	to 0.80	18000	390	0.40	13/16	02-152	90-652	23-152	92-652
2.5	to 0.30	2400	47	0.15	11/16	02-150	90-650	23-150	92-650
3.0	to 0.30	2700	56	0.15	13/16	02-151	90-651	23-151	92-651
3.0	to 0.36	1100	22	0.18	11/16	02-150	90-650	23-150	92-650
3.0	to 0.40	270	4.7	0.20	11/16	02-149	90-649	23-149	92-649
4.0	to 0.70	12000	220	0.35	13/16	02-152	90-652	23-152	92-652
6.0	to 0.70	10000	180	0.35	13/16	02-152	90-652	23-152	92-652
10.0	to 0.60	5600	120	0.30	13/16	02-152	90-652	23-152	92-652



8:1 TURNS RATIO

Pulse Width Range in Microseconds		Source** Impedance (Ohms)	Load** Impedance (Ohms)	Maximum Rise Time Microseconds	Length (02 & 90 Series)	Aladdin Part Numbers			
Maximum*	Minimum					Double End Units	Single End Units		
						Construction		Construction	
						Military	Commercial	Military	Commercial
0.20	to 0.20	2200	33	0.10	11/16	02-397	90-897	23-397	92-897
0.25	to 0.20	1400	22	0.10	11/16	02-397	90-897	23-397	92-897
0.30	to 0.18	1800	27	0.09	11/16	02-153	90-653	23-153	92-653
0.50	to 0.20	1000	18	0.10	11/16	02-153	90-653	23-153	92-653
0.50	to 0.24	2200	39	0.12	11/16	02-154	90-654	23-154	92-654
0.5	to 0.50	10000	150	0.25	11/16	02-155	90-655	23-155	92-655
0.5	to 0.30	620	10	0.18	11/16	02-397	90-897	23-397	92-897
0.7	to 0.20	1500	22	0.10	11/16	02-154	90-654	23-154	92-654
1.0	to 0.24	750	12	0.12	11/16	02-153	90-653	23-153	92-653
1.0	to 0.24	1000	15	0.12	11/16	02-154	90-654	23-154	92-654
1.0	to 0.46	6800	100	0.23	11/16	02-155	90-655	23-155	92-655
2.0	to 0.26	620	10	0.13	11/16	02-153	90-653	23-153	92-653
2.0	to 0.34	620	10	0.17	11/16	02-154	90-654	23-154	92-654
2.0	to 0.36	2700	39	0.18	11/16	02-155	90-655	23-155	92-655
2.0	to 0.60	9100	150	0.30	13/16	02-156	90-656	23-156	92-656
2.5	to 0.36	4700	75	0.18	13/16	02-156	90-656	23-156	92-656
3.5	to 0.34	3300	51	0.17	13/16	02-156	90-656	23-156	92-656
5.0	to 0.40	1800	22	0.20	11/16	02-155	90-655	23-155	92-655



* For a 10% droop; transformer may be used for greater pulse widths if more droop can be tolerated.

** The generator impedance may be decreased 5%, and the load impedance increased 5%, without changing the specified performance characteristics.

9:1 TURNS RATIO

Pulse Width Range in Microseconds		Source** Impedance (Ohms)	Load** Impedance (Ohms)	Maximum Rise Time Microseconds	Length (02 & 90 Series)	Aladdin Part Numbers			
Maximum*	Minimum					Double End Units		Single End Units	
									
						Construction		Construction	
						Military	Commercial	Military	Commercial
0.4	to 0.26	4700	56	0.13	11/16	02-158	90-658	23-158	92-658
0.7	to 0.10	1500	18	0.05	11/16	02-157	90-657	23-157	92-657
1.0	to 0.20	820	10	0.10	11/16	02-157	90-657	23-157	92-657
1.0	to 0.26	910	11	0.13	11/16	02-158	90-658	23-158	92-658
1.3	to 0.36	6800	82	0.18	11/16	02-159	90-659	23-159	92-659
1.35	to 0.44	3300	39	0.22	11/16	02-394	90-894	23-394	92-894
1.45	to 0.38	2200	27	0.19	11/16	02-394	90-894	23-394	92-894
1.50	to 0.30	620	8.2	0.15	11/16	02-157	90-657	23-157	92-657
1.70	to 0.38	1800	22	0.19	11/16	02-394	90-894	23-394	92-894
2.00	to 0.32	4700	56	0.16	11/16	02-159	90-659	23-159	92-659
2.0	to 0.44	620	8.2	0.22	11/16	02-158	90-658	23-158	92-658
2.0	to 0.46	430	4.7	0.23	11/16	02-157	90-657	23-157	92-657
2.0	to 0.60	6800	82	0.30	13/16	02-160	90-660	23-160	92-660
2.8	to 0.38	1200	15	0.19	11/16	02-394	90-894	23-394	92-894
3.0	to 0.34	2700	30	0.17	11/16	02-159	90-659	23-159	92-659
3.0	to 0.60	4700	56	0.30	13/16	02-160	90-660	23-160	92-660
4.0	to 0.38	2000	22	0.19	11/16	02-159	90-659	23-159	92-659
4.0	to 0.60	2700	36	0.30	13/16	02-160	90-660	23-160	92-660
6.0	to 0.90	1600	22	0.45	13/16	02-160	90-660	23-160	92-660



10:1 TURNS RATIO

Pulse Width Range in Microseconds		Source** Impedance (Ohms)	Load** Impedance (Ohms)	Maximum Rise Time Microseconds	Length (02 & 90 Series)	Aladdin Part Numbers			
Maximum*	Minimum					Double End Units		Single End Units	
									
						Construction		Construction	
						Military	Commercial	Military	Commercial
0.25	to 0.24	1800	18	0.12	11/16	02-293	90-793	23-293	92-793
0.25	to 0.20	3300	33	0.10	11/16	02-396	90-896	23-396	92-896
0.35	to 0.17	2200	22	0.08	11/16	02-396	90-896	23-396	92-896
0.45	to 0.26	1200	12	0.13	11/16	02-293	90-793	23-293	92-793
0.50	to 0.16	1600	16	0.08	11/16	02-396	90-896	23-396	92-896
0.5	to 0.28	4700	47	0.14	11/16	02-162	90-662	23-162	92-662
0.5	to 0.36	2700	27	0.18	11/16	02-161	90-661	23-161	92-661
0.7	to 0.32	1000	10	0.16	11/16	02-293	90-793	23-293	92-793
1.0	to 0.28	2200	22	0.14	11/16	02-162	90-662	23-162	92-662
1.0	to 0.36	1500	15	0.18	11/16	02-161	90-661	23-161	92-661
1.0	to 0.40	6800	68	0.20	13/16	02-163	90-663	23-163	92-663
1.5	to 0.30	1600	16	0.15	11/16	02-162	90-662	23-162	92-662
1.5	to 0.36	1000	10	0.18	11/16	02-161	90-661	23-161	92-661
1.5	to 0.40	4700	47	0.20	13/16	02-163	90-663	23-163	92-663
2.0	to 0.50	3300	33	0.25	13/16	02-163	90-663	23-163	92-663
2.0	to 0.60	470	4.7	0.30	11/16	02-161	90-661	23-161	92-661
2.5	to 0.44	1000	10	0.22	11/16	02-162	90-662	23-162	92-662
3.0	to 0.50	6800	68	0.25	13/16	02-164	90-664	23-164	92-664
5.0	to 0.50	1500	15	0.25	13/16	02-163	90-663	23-163	92-663
5.0	to 0.44	4700	47	0.22	13/16	02-164	90-664	23-164	92-664
7.0	to 0.46	2700	27	0.23	13/16	02-164	90-664	23-164	92-664
9.0	to 0.50	2200	22	0.25	13/16	02-164	90-664	23-164	92-664

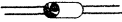

* For a 10% droop; transformer may be used for greater pulse widths if more droop can be tolerated.

** The generator impedance may be decreased 5%, and the load impedance increased 5%, without changing the specified performance characteristics.

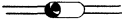

15:1 TURNS RATIO

Pulse Width Range in Microseconds		Source** Impedance (Ohms)	Load** Impedance (Ohms)	Maximum Rise Time Microseconds	Length (02 & 90 Series)	Aladdin Part Numbers			
Maximum*	Minimum					Double End Units		Single End Units	
									
						Construction Military Commercial		Construction Military Commercial	
0.3	to 0.30	2200	10	0.17	11/16	02-165	90-665	23-165	92-665
0.5	to 0.46	4700	20	0.23	11/16	02-166	90-666	23-166	92-666
0.8	to 0.40	1100	5	0.20	11/16	02-165	90-665	23-165	92-665
1.0	to 0.44	4700	20	0.22	11/16	02-167	90-667	23-167	92-667
1.0	to 0.46	2200	10	0.23	11/16	02-166	90-666	23-166	92-666
1.5	to 0.46	2200	10	0.23	11/16	02-167	90-667	23-167	92-667
2.0	to 0.60	1200	5	0.30	11/16	02-166	90-666	23-166	92-666
2.0	to 0.66	8200	39	0.33	13/16	02-168	90-668	23-168	92-668
3.0	to 0.50	1800	8	0.25	11/16	02-167	90-667	23-167	92-667
3.0	to 0.60	5600	27	0.30	13/16	02-168	90-668	23-168	92-668
4.0	to 0.60	4700	22	0.3	13/16	02-168	90-668	23-168	92-668
5.0	to 0.60	1200	5	0.3	11/16	02-167	90-667	23-167	92-667
5.0	to 0.60	3900	18	0.3	13/16	02-168	90-668	23-168	92-668

20:1 TURNS RATIO

Pulse Width Range in Microseconds		Source** Impedance (Ohms)	Load** Impedance (Ohms)	Maximum Rise Time Microseconds	Length (02 & 90 Series)	Aladdin Part Numbers			
Maximum*	Minimum					Double End Units		Single End Units	
									
						Construction Military Commercial		Construction Military Commercial	
0.4	to 0.34	3900	10	0.17	11/16	02-169	90-669	23-169	92-669
0.5	to 0.36	3300	8	0.18	11/16	02-169	90-669	23-169	92-669
0.5	to 0.40	5600	15	0.20	11/16	02-170	90-670	23-170	92-670
1.0	to 0.40	2000	5	0.20	11/16	02-169	90-669	23-169	92-669
1.0	to 0.40	3900	10	0.20	11/16	02-170	90-670	23-170	92-670
1.0	to 0.48	8200	22	0.24	11/16	02-171	90-671	23-171	92-671
1.5	to 0.44	3300	8	0.22	11/16	02-170	90-670	23-170	92-670
1.5	to 0.50	1600	4	0.25	11/16	02-169	90-669	23-169	92-669
1.8	to 0.44	5600	15	0.22	11/16	02-171	90-671	23-171	92-671
2.0	to 0.50	2000	5	0.25	11/16	02-170	90-670	23-170	92-670
2.0	to 0.80	1100	3	0.40	11/16	02-169	90-669	23-169	92-669
2.5	to 0.48	3900	10	0.24	11/16	02-171	90-671	23-171	92-671
3.0	to 0.52	3300	8	0.26	11/16	02-171	90-671	23-171	92-671



30:1 TURNS RATIO

Pulse Width Range in Microseconds		Source** Impedance (Ohms)	Load** Impedance (Ohms)	Maximum Rise Time Microseconds	Length (02 & 90 Series)	Aladdin Part Numbers			
Maximum*	Minimum					Double End Units		Single End Units	
									
						Construction Military Commercial		Construction Military Commercial	
2.0	to 1.80	24000	27	0.90	13/16	02-389	90-889	23-389	92-889
2.7	to 1.38	16000	18	0.69	13/16	02-389	90-889	23-389	92-889
4.3	to 1.30	9100	10	0.65	13/16	02-389	90-889	23-389	92-889
8.7	to 1.56	4700	5	0.78	13/16	02-389	90-889	23-389	92-889

* For a 10% droop; transformer may be used for greater pulse widths if more droop can be tolerated.

** The generator impedance may be decreased 5%, and the load impedance increased 5%, without changing the specified performance characteristics.

1:1:1 TURNS RATIO

Pulse Width Range in Microseconds		Source** Impedance (Ohms)	Load# Impedance (Ohms)	Maximum## Rise Time Microseconds	Length (02 & 90 Series)	Aladdin Part Numbers			
Maximum*	Minimum					Double End Units	End Units	Single End Units	
									
						Construction Military Commercial	Construction Military Commercial	Construction Military Commercial	Construction Military Commercial
0.10	to 0.06	75	150	0.03	11/16	02-172	90-672	23-172	92-672
0.12	to 0.12	180	390	0.06	11/16	02-173	90-673	23-173	92-673
0.20	to 0.08	51	100	0.04	11/16	02-172	90-672	23-172	92-672
0.20	to 0.08	200	390	0.04	11/16	02-325	90-825	23-325	92-825
0.20	to 0.12	110	220	0.06	11/16	02-173	90-673	23-173	92-673
0.3	to 0.07	150	270	0.035	11/16	02-324	90-824	23-324	92-824
0.3	to 0.08	120	240	0.040	11/16	02-325	90-825	23-325	92-825
0.3	to 0.12	75	150	0.060	11/16	02-173	90-673	23-173	92-673
0.3	to 0.22	680	1500	0.110	11/16	02-283	90-783	23-283	92-783
0.3	to 0.04	240	470	0.020	11/16	02-175	90-675	23-175	92-675
0.40	to 0.04	110	220	0.02	11/16	02-174	90-674	23-174	92-674
0.40	to 0.08	510	1000	0.04	11/16	02-177	90-677	23-177	92-677
0.40	to 0.18	51	100	0.09	11/16	02-173	90-673	23-173	92-673
0.45	to 0.14	340	680	0.07	11/16	02-283	90-783	23-283	92-783
0.50	to 0.04	240	470	0.02	11/16	02-176	90-676	23-176	92-676
0.6	to 0.09	56	100	0.045	11/16	02-324	90-824	23-324	92-824
0.6	to 0.04	110	240	0.020	11/16	02-175	90-675	23-175	92-675
0.7	to 0.04	75	160	0.020	11/16	02-174	90-674	23-174	92-674
0.8	to 0.06	240	470	0.030	11/16	02-177	90-677	23-177	92-677
0.8	to 0.12	150	270	0.060	11/16	02-283	90-783	23-283	92-783
0.9	to 0.10	91	180	0.050	11/16	02-325	90-825	23-325	92-825
1.0	to 0.04	150	300	0.020	11/16	02-176	90-676	23-176	92-676
1.0	to 0.05	56	100	0.025	11/16	02-174	90-674	23-174	92-674
1.0	to 0.07	75	160	0.035	11/16	02-175	90-675	23-175	92-675
1.3	to 0.07	51	100	0.035	11/16	02-174	90-674	23-174	92-674
1.3	to 0.12	75	150	0.060	11/16	02-283	90-783	23-283	92-783
1.5	to 0.10	110	220	0.050	11/16	02-177	90-677	23-177	92-677
1.5	to 0.14	330	680	0.070	11/16	02-178	90-678	23-178	92-678
1.5	to 0.14	51	100	0.070	11/16	02-175	90-675	23-175	92-675
1.8	to 0.06	75	160	0.030	11/16	02-176	90-676	23-176	92-676
1.8	to 0.14	56	110	0.070	11/16	02-325	90-825	23-325	92-825
1.8	to 0.16	820	1600	0.080	13/16	02-179	90-679	23-179	92-679
1.8	to 0.30	1600	3300	0.150	11/16	02-180	90-680	23-180	92-680
2.0	to 0.16	220	430	0.080	11/16	02-178	90-678	23-178	92-678
2.0	to 0.18	43	82	0.090	11/16	02-283	90-783	23-283	92-783
2.5	to 0.22	36	68	0.11	11/16	02-325	90-825	23-325	92-825
2.5	to 0.34	1600	3300	0.17	13/16	02-181	90-681	23-181	92-681
3.0	to 0.10	51	100	0.05	11/16	02-176	90-676	23-176	92-676
3.0	to 0.30	1000	2000	0.15	13/16	02-180	90-680	23-180	92-680
3.0	to 0.34	100	220	0.17	11/16	02-178	90-678	23-178	92-678
3.5	to 0.26	22	43	0.13	11/16	02-283	90-783	23-283	92-783
4.0	to 0.12	510	1000	0.06	11/16	02-179	90-679	23-179	92-679
4.0	to 0.30	51	100	0.15	11/16	02-177	90-677	23-177	92-677
4.0	to 0.32	22	43	0.16	11/16	02-325	90-825	23-325	92-825
5.0	to 0.08	330	680	0.04	11/16	02-179	90-679	23-179	92-679
5.5	to 0.36	1000	1800	0.18	13/16	02-181	90-681	23-181	92-681
6.0	to 0.26	620	1100	0.13	13/16	02-180	90-680	23-180	92-680
6.0	to 0.80	68	120	0.40	11/16	02-178	90-678	23-178	92-678
7.0	to 0.08	240	470	0.04	11/16	02-179	90-679	23-179	92-679
8.0	to 0.38	560	1100	0.19	13/16	02-181	90-681	23-181	92-681
11.0	to 0.40	330	680	0.20	13/16	02-180	90-680	23-180	92-680
13.0	to 0.52	330	680	0.26	13/16	02-181	90-681	23-181	92-681



* For a 10% droop; transformer may be used for greater pulse widths if more droop can be tolerated.

** The generator impedance may be decreased 5%, and the load impedance increased 5%, without changing the specified performance characteristics.



The tabulated load impedance is the load across each secondary.

The tabulated maximum rise time is the maximum rise time at each secondary.

1:2:2 TURNS RATIO

Pulse Width Range in Microseconds		Source** Impedance (Ohms)	Load# Impedance (Ohms)	Maximum## Rise Time Microseconds	Length (02 & 90 Series)	Aladdin Part Numbers			
Maximum*	Minimum					Double End Units		Single End Units	
									
						Construction Military Commercial		Construction Military Commercial	
0.10	to 0.06	130	1000	0.03	11/16	02-184	90-684	23-184	92-684
0.10	to 0.08	150	1100	0.04	11/16	02-183	90-683	23-183	92-683
0.15	to 0.08	100	820	0.04	11/16	02-183	90-683	23-183	92-683
0.20	to 0.06	82	680	0.03	11/16	02-184	90-684	23-184	92-684
0.20	to 0.08	51	390	0.04	11/16	02-183	90-683	23-183	92-683
0.3	to 0.06	68	560	0.030	11/16	02-184	90-684	23-184	92-684
0.5	to 0.07	51	390	0.035	11/16	02-184	90-684	23-184	92-684
1.0	to 0.10	150	1100	0.050	11/16	02-185	90-685	23-185	92-685
1.0	to 0.16	180	1600	0.080	11/16	02-186	90-686	23-186	92-686
1.4	to 0.26	240	1800	0.130	11/16	02-313	90-813	23-313	92-813
1.5	to 0.09	82	680	0.045	11/16	02-185	90-685	23-185	92-685
1.5	to 0.16	150	1100	0.080	11/16	02-186	90-686	23-186	92-686
2.0	to 0.12	68	560	0.060	11/16	02-185	90-685	23-185	92-685
2.0	to 0.16	110	910	0.080	11/16	02-186	90-686	23-186	92-686
2.5	to 0.16	51	390	0.080	11/16	02-185	90-685	23-185	92-685
2.5	to 0.20	100	820	0.10	11/16	02-313	90-813	23-313	92-813
4.5	to 0.24	62	470	0.12	11/16	02-313	90-813	23-313	92-813
6.0	to 0.30	43	360	0.15	11/16	02-313	90-813	23-313	92-813
6.0	to 0.34	270	2200	0.17	13/16	02-187	90-687	23-187	92-687
7.0	to 0.30	150	1100	0.15	13/16	02-187	90-687	23-187	92-687
8.0	to 0.3	180	1600	0.15	13/16	02-187	90-687	23-187	92-687
10.0	to 0.5	27	200	0.25	11/16	02-313	90-813	23-313	92-813

1:3:3 TURNS RATIO

Pulse Width Range in Microseconds		Source** Impedance (Ohms)	Load# Impedance (Ohms)	Maximum## Rise Time Microseconds	Length (02 & 90 Series)	Aladdin Part Numbers			
Maximum*	Minimum					Double End Units		Single End Units	
									
						Construction Military Commercial		Construction Military Commercial	
0.10	to 0.10	100	1800	0.065	11/16	02-188	90-688	23-188	92-688
0.15	to 0.10	82	1500	0.050	11/16	02-188	90-688	23-188	92-688
0.20	to 0.10	68	1200	0.050	11/16	02-188	90-688	23-188	92-688
0.20	to 0.15	91	1500	0.075	11/16	02-189	90-689	23-189	92-689
0.25	to 0.12	51	1000	0.060	11/16	02-188	90-688	23-188	92-688
0.3	to 0.12	51	1000	0.06	11/16	02-189	90-689	23-189	92-689
0.3	to 0.20	68	1200	0.10	11/16	02-190	90-690	23-190	92-690
0.5	to 0.20	56	1000	0.10	11/16	02-190	90-690	23-190	92-690
1.5	to 0.24	110	2000	0.12	11/16	02-191	90-691	23-191	92-691
2.5	to 0.24	68	1100	0.12	11/16	02-191	90-691	23-191	92-691
3.0	to 0.22	51	1000	0.11	11/16	02-191	90-691	23-191	92-691
4.0	to 0.46	300	5600	0.23	13/16	02-192	90-692	23-192	92-692
4.5	to 0.40	240	4700	0.20	13/16	02-192	90-692	23-192	92-692
5.5	to 0.40	150	3000	0.20	13/16	02-192	90-692	23-192	92-692
7.0	to 0.44	100	1800	0.22	13/16	02-192	90-692	23-192	92-692



* For a 10% droop; transformer may be used for greater pulse widths if more droop can be tolerated.

** The generator impedance may be decreased 5%, and the load impedance increased 5%, without changing the specified performance characteristics.



The tabulated load impedance is the load across each secondary.

The tabulated maximum rise time is the maximum rise time at each secondary.



1:4:4 TURNS RATIO

Pulse Width Range in Microseconds Maximum* Minimum	Source** Impedance (Ohms)	Load# Impedance (Ohms)	Maximum## Rise Time Microseconds	Length (02 & 90 Series)	Aladdin Part Numbers			
					Double End Units		Single End Units	
								
					Construction		Construction	
					Military	Commercial	Military	Commercial
0.20 to 0.14	51	1800	0.07	11/16	02-193	90-693	23-193	92-693
0.30 to 0.20	82	2700	0.10	11/16	02-194	90-694	23-194	92-694
0.35 to 0.20	51	1800	0.10	11/16	02-194	90-694	23-194	92-694
1.00 to 0.28	75	2700	0.14	11/16	02-195	90-695	23-195	92-695
1.00 to 0.54	100	3300	0.27	13/16	02-196	90-696	23-196	92-696
1.5 to 0.24	51	1800	0.12	11/16	02-195	90-695	23-195	92-695
1.5 to 0.40	82	2700	0.20	13/16	02-196	90-696	23-196	92-696
2.0 to 0.32	68	2200	0.16	13/16	02-196	90-696	23-196	92-696
3.0 to 0.34	51	1800	0.17	13/16	02-196	90-696	23-196	92-696

1:5:5 TURNS RATIO



Pulse Width Range in Microseconds Maximum* Minimum	Source** Impedance (Ohms)	Load# Impedance (Ohms)	Maximum## Rise Time Microseconds	Length (02 & 90 Series)	Aladdin Part Numbers			
					Double End Units		Single End Units	
								
					Construction		Construction	
					Military	Commercial	Military	Commercial
0.2 to 0.16	51	2400	0.08	11/16	02-197	90-697	23-197	92-697
0.4 to 0.28	68	3300	0.14	11/16	02-198	90-698	23-198	92-698
0.6 to 0.26	51	2700	0.13	11/16	02-198	90-698	23-198	92-698
1.0 to 0.40	100	4700	0.20	11/16	02-199	90-699	23-199	92-699
1.5 to 0.30	51	2400	0.15	11/16	02-199	90-699	23-199	92-699
3.0 to 0.60	100	4700	0.30	13/16	02-200	90-700	23-200	92-700
4.0 to 0.50	56	2700	0.25	13/16	02-200	90-700	23-200	92-700

1.7:1:1 TURNS RATIO

Pulse Width Range in Microseconds Maximum* Minimum	Source** Impedance (Ohms)	Load# Impedance (Ohms)	Maximum## Rise Time Microseconds	Length (02 & 90 Series)	Aladdin Part Numbers			
					Double End Units		Single End Units	
								
					Construction		Construction	
					Military	Commercial	Military	Commercial
3.0 to 0.14	56	39	0.07	11/16	02-314	90-814	23-314	92-814
4.5 to 0.20	39	27	0.10	11/16	02-314	90-814	23-314	92-814
7.0 to 0.38	22	15	0.19	11/16	02-314	90-814	23-314	92-814

- * For a 10% droop; transformer may be used for greater pulse widths if more droop can be tolerated.
 ** The generator impedance may be decreased 5%, and the load impedance increased 5%, without changing the specified performance characteristics.
 # The tabulated load impedance is the load across each secondary.
 ## The tabulated maximum rise time is the maximum rise time at each secondary.

2:1:1 TURNS RATIO

Pulse Width Range in Microseconds		Source** Impedance (Ohms)	Load# Impedance (Ohms)	Maximum## Rise Time Microseconds	Length (02 & 90 Series)	Aladdin Part Numbers			
Maximum*	Minimum					Double End Units		Single End Units	
						 Construction Military Commercial		 Construction Military Commercial	
0.10	to 0.08	200	100	0.04	11/16	02-204	90-704	23-204	92-704
0.15	to 0.10	110	56	0.05	11/16	02-204	90-704	23-204	92-704
0.25	to 0.16	51	27	0.08	11/16	02-204	90-704	23-204	92-704
0.30	to 0.06	130	68	0.03	11/16	02-205	90-705	23-205	92-705
0.40	to 0.06	200	100	0.03	11/16	02-206	90-706	23-206	92-706
0.5	to 0.09	110	56	0.045	11/16	02-205	90-705	23-205	92-705
0.6	to 0.08	130	68	0.040	11/16	02-206	90-706	23-206	92-706
0.7	to 0.10	62	33	0.050	11/16	02-205	90-705	23-205	92-705
0.8	to 0.10	51	27	0.050	11/16	02-205	90-705	23-205	92-705
1.0	to 0.08	100	47	0.040	11/16	02-206	90-706	23-206	92-706
1.0	to 0.09	300	150	0.045	11/16	02-207	90-707	23-207	92-707
1.0	to 0.26	39	18	0.130	11/16	02-205	90-705	23-205	92-705
1.3	to 0.12	62	30	0.060	11/16	02-206	90-706	23-206	92-706
1.5	to 0.16	510	270	0.080	11/16	02-208	90-708	23-208	92-708
1.8	to 0.14	51	27	0.070	11/16	02-206	90-706	23-206	92-706
2.0	to 0.16	180	82	0.08	11/16	02-207	90-707	23-207	92-707
2.0	to 0.22	430	220	0.11	11/16	02-208	90-708	23-208	92-708
2.0	to 0.30	1500	680	0.15	13/16	02-209	90-709	23-209	92-709
3.0	to 0.22	1000	470	0.11	13/16	02-209	90-709	23-209	92-709
3.0	to 0.24	110	68	0.12	11/16	02-207	90-707	23-207	92-707
3.0	to 0.28	240	120	0.14	11/16	02-208	90-708	23-208	92-708
4.0	to 0.22	560	270	0.11	13/16	02-209	90-709	23-209	92-709
4.0	to 0.30	100	47	0.15	11/16	02-207	90-707	23-207	92-707
5.0	to 0.22	560	270	0.11	13/16	02-209	90-709	23-209	92-709
5.0	to 0.32	1600	680	0.16	13/16	02-210	90-710	23-210	92-710
6.0	to 0.28	1100	560	0.14	13/16	02-210	90-710	23-210	92-710
8.0	to 0.26	910	470	0.13	13/16	02-210	90-710	23-210	92-710
10.0	to 0.28	620	300	0.14	13/16	02-210	90-710	23-210	92-710



* For a 10% droop; transformer may be used for greater pulse widths if more droop can be tolerated.

** The generator impedance may be decreased 5%, and the load impedance increased 5%, without changing the specified performance characteristics.

The tabulated load impedance is the load across each secondary.

The tabulated maximum rise time is the maximum rise time at each secondary.

3:1:1 TURNS RATIO

Pulse Width Range in Microseconds Maximum* Minimum	Source** Impedance (Ohms)	Load# Impedance (Ohms)	Maximum## Rise Time Microseconds	Length (02 & 90 Series)	Aladdin Part Numbers			
					Double End Units		Single End Units	
								
					Construction		Construction	
					Military	Commercial	Military	Commercial
0.20 to 0.07	150	36	0.035	11/16	02-211	90-711	23-211	92-711
0.35 to 0.12	180	39	0.060	11/16	02-212	90-712	23-212	92-712
0.50 to 0.09	220	47	0.045	11/16	02-213	90-713	23-213	92-713
0.50 to 0.14	100	22	0.070	11/16	02-211	90-711	23-211	92-711
0.60 to 0.10	150	33	0.050	11/16	02-212	90-712	23-212	92-712
0.7 to 0.16	75	15	0.080	11/16	02-211	90-711	23-211	92-711
0.8 to 0.24	51	10	0.120	11/16	02-211	90-711	23-211	92-711
0.9 to 0.38	2700	820	0.190	11/16	02-391	90-891	23-391	92-891
1.0 to 0.11	150	36	0.055	11/16	02-213	90-713	23-213	92-713
1.0 to 0.12	680	150	0.060	11/16	02-214	90-714	23-214	92-714
1.1 to 0.24	2000	470	0.12	11/16	02-391	90-891	23-391	92-891
1.2 to 0.18	1500	330	0.09	11/16	02-391	90-891	23-391	92-891
1.3 to 0.16	2200	470	0.08	11/16	02-215	90-715	23-215	92-715
1.3 to 0.18	91	22	0.09	11/16	02-212	90-712	23-212	92-712
1.5 to 0.14	510	120	0.07	11/16	02-214	90-714	23-214	92-714
1.5 to 0.18	100	22	0.09	11/16	02-213	90-713	23-213	92-713
1.5 to 0.34	1700	1100	0.17	13/16	02-216	90-716	23-216	92-716
2.0 to 0.14	1000	180	0.07	11/16	02-215	90-715	23-215	92-715
2.0 to 0.24	360	82	0.12	11/16	02-214	90-714	23-214	92-714
2.0 to 0.24	68	15	0.12	11/16	02-213	90-713	23-213	92-713
2.3 to 0.30	3300	680	0.15	13/16	02-216	90-716	23-216	92-716
3.0 to 0.10	430	100	0.05	11/16	02-391	90-891	23-391	92-891
3.0 to 0.24	300	68	0.12	11/16	02-214	90-714	23-214	92-714
3.0 to 0.36	2200	430	0.18	13/16	02-216	90-716	23-216	92-716
3.5 to 0.34	51	13	0.17	11/16	02-213	90-713	23-213	92-713
4.0 to 0.26	470	100	0.13	11/16	02-215	90-715	23-215	92-715
4.0 to 0.70	1600	330	0.35	13/16	02-216	90-716	23-216	92-716
5.0 to 0.14	270	56	0.07	11/16	02-391	90-891	23-391	92-891
8.0 to 0.52	220	47	0.26	11/16	02-215	90-715	23-215	92-715



* For a 10% droop; transformer may be used for greater pulse widths if more droop can be tolerated.

** The generator impedance may be decreased 5%, and the load impedance increased 5%, without changing the specified performance characteristics.



The tabulated load impedance is the load across each secondary.

The tabulated maximum rise time is the maximum rise time at each secondary.

4:1:1 TURNS RATIO

Pulse Width Range in Microseconds		Source** Impedance (Ohms)	Load# Impedance (Ohms)	Maximum## Rise Time Microseconds	Length (02 & 90 Series)	Aladdin Part Numbers			
Maximum*	Minimum					Double End Units		Single End Units	
									
						Construction Military Commercial		Construction Military Commercial	
0.4	to 0.12	180	22	0.06	11/16	02-217	90-717	23-217	92-717
0.5	to 0.20	2400	300	0.10	11/16	02-220	90-720	23-220	92-720
0.5	to 0.20	130	15	0.10	11/16	02-217	90-717	23-217	92-717
0.6	to 0.08	200	39	0.04	11/16	02-218	90-718	23-218	92-718
0.8	to 0.26	75	10	0.13	11/16	02-217	90-717	23-217	92-717
1.0	to 0.09	300	39	0.045	11/16	02-219	90-719	23-219	92-719
1.0	to 0.16	1100	150	0.080	11/16	02-220	90-720	23-220	92-720
1.0	to 0.16	180	22	0.080	11/16	02-218	90-718	23-218	92-718
1.0	to 0.24	3300	430	0.120	11/16	02-221	90-721	23-221	92-721
1.2	to 0.36	56	7	0.180	11/16	02-217	90-717	23-217	92-717
1.5	to 0.20	2200	270	0.10	11/16	02-221	90-721	23-221	92-721
1.5	to 0.24	130	15	0.12	11/16	02-218	90-718	23-218	92-718
2.0	to 0.16	750	100	0.08	11/16	02-220	90-720	23-220	92-720
2.0	to 0.16	180	22	0.08	11/16	02-219	90-719	23-219	92-719
2.0	to 0.20	1600	180	0.10	11/16	02-221	90-721	23-221	92-721
2.0	to 0.42	75	10	0.21	11/16	02-218	90-718	23-218	92-718
3.0	to 0.22	470	56	0.11	11/16	02-220	90-720	23-220	92-720
3.0	to 0.24	1000	120	0.12	11/16	02-221	90-721	23-221	92-721
3.0	to 0.26	110	15	0.13	11/16	02-219	90-719	23-219	92-719
4.0	to 0.38	82	10	0.19	11/16	02-219	90-719	23-219	92-719

5:1:1 TURNS RATIO

Pulse Width Range in Microseconds		Source** Impedance (Ohms)	Load# Impedance (Ohms)	Maximum## Rise Time Microseconds	Length (02 & 90 Series)	Aladdin Part Numbers			
Maximum*	Minimum					Double End Units		Single End Units	
									
						Construction Military Commercial		Construction Military Commercial	
0.5	to 0.12	1300	100	0.06	11/16	02-224	90-724	23-224	92-724
0.5	to 0.20	180	15	0.10	11/16	02-222	90-722	23-222	92-722
0.5	to 0.26	3900	300	0.13	11/16	02-225	90-725	23-225	92-725
0.8	to 0.10	750	56	0.05	11/16	02-224	90-724	23-224	92-724
0.8	to 0.20	2200	180	0.10	11/16	02-225	90-725	23-225	92-725
1.0	to 0.18	330	27	0.09	11/16	02-223	90-723	23-223	92-723
1.0	to 0.32	110	10	0.16	11/16	02-222	90-722	23-222	92-722
1.5	to 0.10	510	39	0.05	11/16	02-224	90-724	23-224	92-724
1.5	to 0.28	3900	300	0.14	11/16	02-226	90-726	23-226	92-726
1.5	to 0.32	180	15	0.16	11/16	02-223	90-723	23-223	92-723
1.5	to 0.46	91	7	0.23	11/16	02-222	90-722	23-222	92-722
1.7	to 0.18	1100	100	0.09	11/16	02-225	90-725	23-225	92-725
2.0	to 0.26	2400	180	0.13	11/16	02-226	90-726	23-226	92-726
2.0	to 0.36	150	13	0.18	11/16	02-223	90-723	23-223	92-723
2.0	to 0.70	62	5	0.35	11/16	02-222	90-722	23-222	92-722
2.5	to 0.30	2000	150	0.15	11/16	02-226	90-726	23-226	92-726
2.5	to 0.32	220	18	0.16	11/16	02-224	90-724	23-224	92-724
3.0	to 0.22	620	51	0.11	11/16	02-225	90-725	23-225	92-725
3.0	to 0.56	110	10	0.28	11/16	02-223	90-723	23-223	92-723
4.0	to 0.44	1100	82	0.22	11/16	02-226	90-726	23-226	92-726



* For a 10% droop; transformer may be used for greater pulse widths if more droop can be tolerated.

** The generator impedance may be decreased 5%, and the load impedance increased 5%, without changing the specified performance characteristics.



The tabulated load impedance is the load across each secondary.

The tabulated maximum rise time is the maximum rise time at each secondary.

6:1:1 TURNS RATIO

Pulse Width Range in Microseconds		Source** Impedance (Ohms)	Load# Impedance (Ohms)	Maximum## Rise Time Microseconds	Length (02 & 90 Series)	Aladdin Part Numbers			
Maximum*	Minimum					Double End Units		Single End Units	
									
						Construction		Construction	
						Military	Commercial	Military	Commercial
0.2	to 0.10	620	33	0.05	11/16	02-227	90-727	23-227	92-727
0.3	to 0.12	500	27	0.06	11/16	02-227	90-727	23-227	92-727
0.4	to 0.12	1200	68	0.06	11/16	02-228	90-728	23-228	92-728
0.4	to 0.16	300	18	0.08	11/16	02-227	90-727	23-227	92-727
0.5	to 0.26	180	10	0.13	11/16	02-227	90-727	23-227	92-727
1.0	to 0.16	360	22	0.08	11/16	02-228	90-728	23-228	92-728
1.0	to 0.10	820	47	0.05	11/16	02-229	90-729	23-229	92-729
1.5	to 0.14	620	33	0.07	11/16	02-229	90-729	23-229	92-729
1.5	to 0.16	300	18	0.08	11/16	02-228	90-728	23-228	92-728
1.5	to 0.24	1600	100	0.12	11/16	02-230	90-730	23-230	92-730
1.5	to 0.36	3900	220	0.18	13/16	02-231	90-731	23-231	92-731
2.0	to 0.20	510	27	0.10	11/16	02-229	90-729	23-229	92-729
2.0	to 0.26	1100	68	0.13	11/16	02-230	90-730	23-230	92-730
2.0	to 0.36	180	10	0.18	11/16	02-228	90-728	23-228	92-728
2.5	to 0.24	360	22	0.12	11/16	02-229	90-729	23-229	92-729
2.5	to 0.3	910	56	0.15	11/16	02-230	90-730	23-230	92-730
2.5	to 0.3	2700	150	0.15	13/16	02-231	90-731	23-231	92-731
3.0	to 0.3	750	47	0.15	11/16	02-230	90-730	23-230	92-730
3.5	to 0.3	2000	100	0.15	13/16	02-231	90-731	23-231	92-731
4.5	to 0.4	1100	68	0.20	13/16	02-231	90-731	23-231	92-731
7.0	to 0.58	820	47	0.29	13/16	02-231	90-731	23-231	92-731

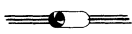
7:1:1 TURNS RATIO

Pulse Width Range in Microseconds		Source** Impedance (Ohms)	Load# Impedance (Ohms)	Maximum## Rise Time Microseconds	Length (02 & 90 Series)	Aladdin Part Numbers			
Maximum*	Minimum					Double End Units		Single End Units	
									
						Construction		Construction	
						Military	Commercial	Military	Commercial
0.3	to 0.12	750	27	0.06	11/16	02-232	90-732	23-232	92-732
0.3	to 0.12	1800	68	0.06	11/16	02-233	90-733	23-233	92-733
0.4	to 0.12	1200	47	0.06	11/16	02-233	90-733	23-233	92-733
0.6	to 0.12	750	27	0.06	11/16	02-233	90-733	23-233	92-733
0.6	to 0.14	510	22	0.07	11/16	02-232	90-732	23-232	92-732
0.8	to 0.18	330	15	0.09	11/16	02-232	90-732	23-232	92-732
0.6	to 0.18	2000	68	0.09	11/16	02-234	90-734	23-234	92-734
1.0	to 0.16	430	18	0.08	11/16	02-233	90-733	23-233	92-733
1.0	to 0.28	5600	220	0.14	13/16	02-235	90-735	23-235	92-735
1.0	to 0.30	240	10	0.15	11/16	02-232	90-732	23-232	92-732
1.5	to 0.18	1000	39	0.09	11/16	02-234	90-734	23-234	92-734
2.0	to 0.24	2700	100	0.12	13/16	02-235	90-735	23-235	92-735
2.0	to 0.32	5600	220	0.16	13/16	02-236	90-736	23-236	92-736
2.0	to 0.66	110	5	0.33	11/16	02-232	90-732	23-232	92-732
2.5	to 0.28	470	22	0.14	11/16	02-234	90-734	23-234	92-734
3.0	to 0.32	3900	160	0.16	13/16	02-236	90-736	23-236	92-736
4.0	to 0.60	270	10	0.30	11/16	02-234	90-734	23-234	92-734
5.0	to 0.26	1100	47	0.13	13/16	02-235	90-735	23-235	92-735
5.0	to 0.32	2700	100	0.16	13/16	02-236	90-736	23-236	92-736
8.0	to 0.38	1100	47	0.19	13/16	02-236	90-736	23-236	92-736
12.0	to 0.54	510	22	0.27	13/16	02-235	90-735	23-235	92-735



* For a 10% droop; transformer may be used for greater pulse widths if more droop can be tolerated.

** The generator impedance may be decreased 5%, and the load impedance increased 5%, without changing the specified performance characteristics.



The tabulated load impedance is the load across each secondary.

The tabulated maximum rise time is the maximum rise time at each secondary.

8:1:1 TURNS RATIO

Pulse Width Range in Microseconds		Source** Impedance (Ohms)	Load# Impedance (Ohms)	Maximum## Rise Time Microseconds	Length (02 & 90 Series)	Aladdin Part Numbers			
Maximum*	Minimum					Double End Units		Single End Units	
									
						Construction Military Commercial		Construction Military Commercial	
0.2	to 0.10	1100	39	0.05	11/16	02-237	90-737	23-237	92-737
0.4	to 0.10	750	22	0.05	11/16	02-237	90-737	23-237	92-737
0.5	to 0.16	470	15	0.08	11/16	02-237	90-737	23-237	92-737
0.5	to 0.16	1500	47	0.08	11/16	02-238	90-738	23-238	92-738
0.7	to 0.26	300	10	0.13	11/16	02-237	90-737	23-237	92-737
1.0	to 0.16	1000	33	0.08	11/16	02-238	90-738	23-238	92-738
1.0	to 0.24	750	22	0.12	11/16	02-239	90-739	23-239	92-739
1.3	to 0.46	7500	220	0.23	13/16	02-240	90-740	23-240	92-740
1.4	to 0.24	560	18	0.12	11/16	02-239	90-739	23-239	92-739
1.7	to 0.36	4700	150	0.18	13/16	02-240	90-740	23-240	92-740
2.0	to 0.28	470	15	0.14	11/16	02-239	90-739	23-239	92-739
2.0	to 0.28	3300	100	0.14	13/16	02-240	90-740	23-240	92-740
2.0	to 0.30	510	15	0.15	11/16	02-238	90-738	23-238	92-738
2.0	to 0.46	7500	220	0.23	13/16	02-241	90-741	23-241	92-741
2.5	to 0.28	2400	75	0.14	13/16	02-240	90-740	23-240	92-740
2.5	to 0.42	4700	150	0.21	13/16	02-241	90-741	23-241	92-741
3.0	to 0.52	300	10	0.26	11/16	02-238	90-738	23-238	92-738
4.0	to 0.28	1600	51	0.14	13/16	02-240	90-740	23-240	92-740
4.0	to 0.40	3300	100	0.20	13/16	02-241	90-741	23-241	92-741
4.0	to 0.38	330	10	0.19	11/16	02-239	90-739	23-239	92-739
5.0	to 0.48	2400	75	0.24	13/16	02-241	90-741	23-241	92-741

9:1:1 TURNS RATIO

Pulse Width Range in Microseconds		Source** Impedance (Ohms)	Load# Impedance (Ohms)	Maximum## Rise Time Microseconds	Length (02 & 90 Series)	Aladdin Part Numbers			
Maximum*	Minimum					Double End Units		Single End Units	
									
						Construction Military Commercial		Construction Military Commercial	
0.25	to 0.16	1100	27	0.08	11/16	02-242	90-742	23-242	92-742
0.30	to 0.20	820	22	0.10	11/16	02-242	90-742	23-242	92-742
0.45	to 0.24	620	15	0.12	11/16	02-242	90-742	23-242	92-742
0.50	to 0.24	3300	75	0.12	11/16	02-244	90-744	23-244	92-744
0.60	to 0.14	1100	39	0.07	11/16	02-243	90-743	23-243	92-743
0.6	to 0.30	430	10	0.150	11/16	02-242	90-742	23-242	92-742
0.8	to 0.15	820	22	0.075	11/16	02-243	90-743	23-243	92-743
0.8	to 0.18	2000	51	0.090	11/16	02-244	90-744	23-244	92-744
1.4	to 0.26	620	15	0.130	11/16	02-243	90-743	23-243	92-743
1.8	to 0.24	820	22	0.120	11/16	02-244	90-744	23-244	92-744
1.8	to 0.34	3900	100	0.17	13/16	02-245	90-745	23-245	92-745
2.0	to 0.32	430	10	0.16	11/16	02-243	90-743	23-243	92-743
2.5	to 0.28	2700	68	0.14	13/16	02-245	90-745	23-245	92-745
3.0	to 0.32	2400	75	0.16	13/16	02-245	90-745	23-245	92-745
3.0	to 0.48	6800	150	0.24	13/16	02-246	90-746	23-246	92-746
3.5	to 0.32	2000	51	0.16	13/16	02-245	90-745	23-245	92-745
4.0	to 0.40	3900	100	0.20	13/16	02-246	90-746	23-246	92-746
4.0	to 0.50	430	10	0.25	11/16	02-244	90-744	23-244	92-744
4.5	to 0.32	1600	39	0.16	13/16	02-245	90-745	23-245	92-745
5.0	to 0.40	2700	68	0.20	13/16	02-246	90-746	23-246	92-746
7.0	to 0.40	1800	47	0.20	13/16	02-246	90-746	23-246	92-746



* For a 10% droop; transformer may be used for greater pulse widths if more droop can be tolerated.

** The generator impedance may be decreased 5%, and the load impedance increased 5%, without changing the specified performance characteristics.



The tabulated load impedance is the load across each secondary.

The tabulated maximum rise time is the maximum rise time at each secondary.

10:1:1 TURNS RATIO

Pulse Width Range in Microseconds		Source** Impedance (Ohms)	Load# Impedance (Ohms)	Maximum## Rise Time Microseconds	Length (02 & 90 Series)	Aladdin Part Numbers				
Maximum*	Minimum					Double End Units	Single End Units			
										
						Construction		Construction		
						Military	Commercial	Military	Commercial	
0.3	to	0.16	1600	33	0.08	11/16	02-247	90-747	23-247	92-747
0.6	to	0.16	2000	39	0.08	11/16	02-248	90-748	23-248	92-748
0.6	to	0.20	750	15	0.10	11/16	02-247	90-747	23-247	92-747
0.8	to	0.28	510	10	0.14	11/16	02-247	90-747	23-247	92-747
1.0	to	0.16	1000	22	0.08	11/16	02-248	90-748	23-248	92-748
1.0	to	0.22	1600	27	0.11	11/16	02-249	90-749	23-249	92-749
1.5	to	0.24	1000	22	0.12	11/16	02-249	90-749	23-249	92-749
1.5	to	0.70	330	7	0.35	11/16	02-247	90-747	23-247	92-747
1.8	to	0.90	15000	300	0.45	13/16	02-250	90-750	23-250	92-750
2.5	to	0.30	750	15	0.15	11/16	02-249	90-749	23-249	92-749
2.5	to	0.36	3900	75	0.18	13/16	02-250	90-750	23-250	92-750
2.5	to	0.38	510	10	0.19	11/16	02-248	90-748	23-248	92-748
3.0	to	0.34	3300	68	0.17	13/16	02-250	90-750	23-250	92-750
3.0	to	0.56	9100	180	0.28	13/16	02-250	90-750	23-250	92-750
4.0	to	0.34	2000	39	0.17	13/16	02-250	90-750	23-250	92-750
4.5	to	0.40	510	10	0.20	11/16	02-249	90-749	23-249	92-749
4.5	to	0.90	240	5	0.45	11/16	02-248	90-748	23-248	92-748
5.0	to	0.50	4700	100	0.25	13/16	02-251	90-751	23-251	92-751
7.0	to	0.40	1200	27	0.20	13/16	02-250	90-750	23-250	92-750
10.0	to	0.54	2400	47	0.27	13/16	02-251	90-751	23-251	92-751

15:1:1 TURNS RATIO

Pulse Width Range in Microseconds		Source** Impedance (Ohms)	Load# Impedance (Ohms)	Maximum## Rise Time Microseconds	Length (02 & 90 Series)	Aladdin Part Numbers				
Maximum*	Minimum					Double End Units	Single End Units			
										
						Construction		Construction		
						Military	Commercial	Military	Commercial	
0.4	to	0.24	2200	22	0.12	11/16	02-252	90-752	23-252	92-752
0.6	to	0.22	1600	15	0.11	11/16	02-252	90-752	23-252	92-752
0.7	to	0.28	3300	27	0.14	11/16	02-253	90-753	23-253	92-753
0.7	to	0.40	6800	56	0.20	11/16	02-254	90-754	23-254	92-754
0.8	to	0.28	1100	10	0.14	11/16	02-252	90-752	23-252	92-752
1.0	to	0.28	2200	22	0.14	11/16	02-253	90-753	23-253	92-753
1.3	to	0.34	3300	27	0.17	11/16	02-254	90-754	23-254	92-754
1.5	to	0.30	1600	15	0.15	11/16	02-253	90-753	23-253	92-753
1.5	to	0.46	560	5	0.23	11/16	02-252	90-752	23-252	92-752
1.8	to	0.34	2200	22	0.17	11/16	02-254	90-754	23-254	92-754
2.5	to	0.44	1100	10	0.22	11/16	02-253	90-753	23-253	92-753
3.0	to	0.60	9100	75	0.30	13/16	02-255	90-755	23-255	92-755
3.5	to	0.52	5600	47	0.26	13/16	02-255	90-755	23-255	92-755
3.5	to	0.60	1100	10	0.30	11/16	02-254	90-754	23-254	92-754
4.5	to	0.48	4700	39	0.24	13/16	02-255	90-755	23-255	92-755
8.0	to	0.54	2200	22	0.27	13/16	02-255	90-755	23-255	92-755



* For a 10% droop; transformer may be used for greater pulse widths if more droop can be tolerated.

** The generator impedance may be decreased 5%, and the load impedance increased 5%, without changing the specified performance characteristics.



The tabulated load impedance is the load across each secondary.

The tabulated maximum rise time is the maximum rise time at each secondary.



20:1:1 TURNS RATIO

Pulse Width Range in Microseconds		Source** Impedance (Ohms)	Load# Impedance (Ohms)	Maximum## Rise Time Microseconds	Length (02 & 90 Series)	Aladdin Part Numbers			
Maximum*	Minimum					Double End Units		Single End Units	
									
						Construction Military Commercial		Construction Military Commercial	
0.40	to 0.34	3900	22	0.17	11/16	02-256	90-756	23-256	92-756
0.55	to 0.30	3300	15	0.15	11/16	02-256	90-756	23-256	92-756
0.80	to 0.44	4700	22	0.22	11/16	02-257	90-757	23-257	92-757
1.10	to 0.36	2000	10	0.18	11/16	02-256	90-756	23-256	92-756
1.50	to 0.42	3300	15	0.21	11/16	02-257	90-757	23-257	92-757
1.5	to 0.42	7500	39	0.21	11/16	02-258	90-758	23-258	92-758
2.2	to 0.54	1000	5	0.27	11/16	02-256	90-756	23-256	92-756
2.5	to 0.38	3900	22	0.19	11/16	02-258	90-758	23-258	92-758
2.5	to 0.50	2000	10	0.25	11/16	02-257	90-757	23-257	92-757
4.0	to 0.50	2000	10	0.25	11/16	02-258	90-758	23-258	92-758
8.0	to 1.0	1000	5	0.5	11/16	02-258	90-758	23-258	92-758

4:2:1 TURNS RATIO

Pulse Width Range in Microseconds		Source** Impedance (Ohms)	Load# Impedance (Ohms)	Maximum## Rise Time Microseconds	Length (02 & 90 Series)	Aladdin Part Numbers			
Maximum*	Minimum					Double End Units		Single End Units	
									
						Construction Military Commercial		Construction Military Commercial	
0.10	to 0.08	560	330	0.030	11/16	02-327	90-827	23-327	92-827
0.16	to 0.09	430	220	0.027	11/16	02-327	90-827	23-327	92-827
0.33	to 0.15	180	91	0.033	11/16	02-327	90-827	23-327	92-827

10:5:1 TURNS RATIO

Pulse Width Range in Microseconds		Source** Impedance (Ohms)	Load# Impedance (Ohms)	Maximum## Rise Time Microseconds	Length (02 & 90 Series)	Aladdin Part Numbers			
Maximum*	Minimum					Double End Units		Single End Units	
									
						Construction Military Commercial		Construction Military Commercial	
0.4	to 0.3	2000	1000	0.07	11/16	02-302	90-802	23-302	92-802
0.5	to 0.3	1100	560	0.05	11/16	02-302	90-802	23-302	92-802
1.1	to 0.5	510	240	0.05	11/16	02-302	90-802	23-302	92-802

* For a 10% droop; transformer may be used for greater pulse widths if more droop can be tolerated.

** The generator impedance may be decreased 5%, and the load impedance increased 5%, without changing the specified performance characteristics.

The tabulated load impedance is the load across each secondary.

The tabulated maximum rise time is the maximum rise time at each secondary.

BLOCKING OSCILLATOR PERFORMANCE DATA FOR PULSE TRANSFORMERS WITH A 1:1 TURNS RATIO

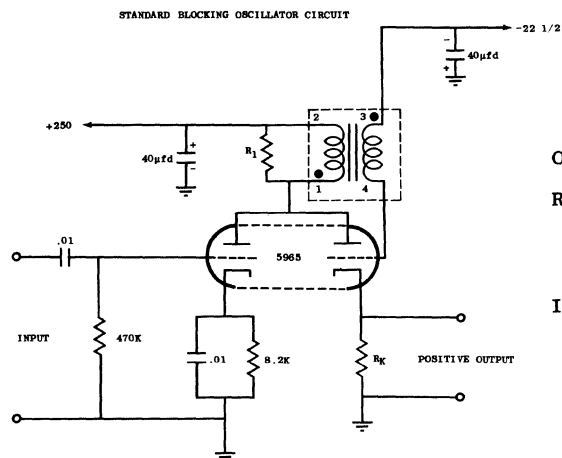

Overshoot: 10% Maximum

Backswing: 10% Maximum

Range of Repetition Rate: 0-10KC with no change in performance units will operate up to 100KC with slightly poorer rise times and somewhat narrower pulses.

Input Pulse Characteristics: Pulse Width - 0.5 μ sec
 Rise Time - 0.02 μ sec
 Amplitude - 25 volts
 (5 volts minimum required)

Pulse Width $\pm 20\%$ (μ sec)	Maximum Rise Time (μ sec)	Output $\pm 10\%$ (Volts)	Maximum Droop (%)	R ₁ $\pm 10\%$ (Ohms)	R _K $\pm 10\%$ (Ohms)	Aladdin Part Numbers			
						Double End Units		Single End Units	
						Construction		Construction	
						Military	Commercial	Military	Commercial
0.1	0.03	110	SPIKE	3900	220	02-484	90-984	23-484	92-984
0.2	0.03	105	25	3900	150	02-485	90-985	23-485	92-985
0.4	0.04	95	25	3900	100	02-486	90-986	23-486	92-986
0.6	0.05	70	20	1800	47	02-487	90-987	23-487	92-987
0.8	0.05	70	20	1800	47	02-488	90-988	23-488	92-988
1.0	0.05	70	15	1800	47	02-489	90-989	23-489	92-989
2.0	0.09	100	10	4700	150	02-490	90-990	23-490	92-990
4.0	0.16	100	5	8200	270	02-491	90-991	23-491	92-991
6.0	0.30	110	5	27000	470	02-492	90-992	23-492	92-992

BLOCKING OSCILLATOR PERFORMANCE DATA FOR PULSE TRANSFORMERS WITH A 1:1:1 TURNS RATIO

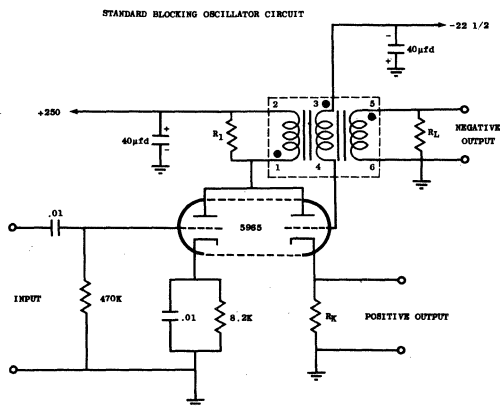

Overshoot: 10% Maximum

Backswing: Positive Output - 10% Maximum
Negative Output - 100% to 200%, depending on width.

Range of Repetition Rate: 0-10KC with no change in performance
units will operate up to 100KC with slightly poorer rise times and somewhat narrower pulses.

Input Pulse Characteristics: Pulse Width - 0.5 µsec
Rise Time - 0.02 µsec
Amplitude - 25 volts (5 volts minimum required)

Pulse Width ± 20% (µsec)	Maximum Rise Time Of Both Outputs (µsec)	Output Volts ± 10%		Maximum Droop (%)	R_L ± 10% (Ohms)	R_K ± 10% (Ohms)	Aladdin Part Numbers			
		Positive Output	Negative Output				Double End Units		Single End Units	
							Construction Military	Commercial	Construction Military	Commercial
0.1	0.06	60	125	NA	820	47	02-493	90-993	23-493	92-993
0.2	0.06	64	135	45	1200	47	02-494	90-994	23-494	92-994
0.4	0.07	65	135	35	1200	47	02-495	90-995	23-495	92-995
0.6	0.07	65	135	30	1200	47	02-496	90-996	23-496	92-996
0.8	0.08	68	140	25	1200	47	02-497	90-997	23-497	92-997
1.0	0.08	68	140	20	1200	47	02-498	90-998	23-498	92-998
2.0	0.15	65	135	10	1800	47	02-499	90-999	23-499	92-999
4.0	0.26	95	140	10	3900	150	02-500	90-1000	23-500	92-1000
6.0	0.30	95	135	10	3900	150	02-501	90-1001	23-501	92-1001

1:1 TURNS RATIO

Pulse Width Range in Microseconds		Source** Impedance (Ohms)	Load** Impedance (Ohms)	Maximum Rise Time Microseconds	Aladdin Part Numbers Single End Transformers	Double End Transformers
Maximum*	Minimum					
0.1	to 0.05	68	68	0.03	20-110	94-110
0.2	to 0.04	110	110	0.02	20-111	94-111
0.2	to 0.04	180	180	0.02	20-112	94-112
0.3	to 0.04	82	82	0.02	20-111	94-111
0.3	to 0.04	150	150	0.02	20-113	94-113
0.3	to 0.05	220	220	0.025	20-114	94-114
0.3	to 0.06	27	27	0.060	20-110	94-110
0.4	to 0.04	68	68	0.020	20-111	94-111
0.5	to 0.04	51	51	0.020	20-111	94-111
0.5	to 0.04	110	110	0.020	20-113	94-113
0.5	to 0.05	110	110	0.025	20-112	94-112
0.7	to 0.10	82	82	0.050	20-112	94-112
0.7	to 0.04	220	220	0.020	20-115	94-115
0.8	to 0.07	150	150	0.035	20-114	94-114
1.0	to 0.06	82	82	0.025	20-113	94-113
1.0	to 0.06	150	150	0.030	20-115	94-115
1.0	to 0.13	51	51	0.065	20-112	94-112
1.0	to 0.16	560	560	0.080	20-116	94-116
1.2	to 0.11	110	110	0.055	20-114	94-114
1.5	to 0.10	51	51	0.050	20-113	94-113
1.5	to 0.11	110	110	0.055	20-115	94-115
1.5	to 0.14	82	82	0.070	20-114	94-114
1.5	to 0.20	1000	1000	0.100	20-117	94-117
1.8	to 0.18	300	300	0.090	20-116	94-116
2.0	to 0.14	82	82	0.070	20-115	94-115
2.0	to 0.34	2000	2000	0.21	20-118	94-118
2.0	to 0.54	2200	2200	0.27	20-119	94-119
2.0	to 0.60	4700	4700	0.30	20-120	94-120
2.2	to 0.18	51	51	0.09	20-114	94-114
2.3	to 0.26	560	560	0.13	20-117	94-117
3.0	to 0.46	1600	1600	0.23	20-119	94-119
3.5	to 0.18	51	51	0.09	20-115	94-115
3.5	to 0.32	180	180	0.16	20-116	94-116
4.0	to 0.34	820	820	0.27	20-118	94-118
4.0	to 0.56	2400	2400	0.28	20-120	94-120
5.0	to 0.38	750	750	0.30	20-118	94-118
5.0	to 0.50	820	820	0.25	20-119	94-119
5.0	to 0.56	2000	2000	0.28	20-120	94-120
5.5	to 0.60	110	110	0.30	20-116	94-116
6.0	to 0.60	220	220	0.30	20-117	94-117
7.0	to 0.44	510	510	0.42	20-118	94-118
7.5	to 0.70	82	82	0.35	20-116	94-116
8.0	to 0.60	510	510	0.30	20-119	94-119
8.5	to 0.70	1100	1100	0.35	20-120	94-120
13.0	to 0.90	150	150	0.45	20-117	94-117

* For a 10% droop; transformer may be used for greater pulse widths if more droop can be tolerated.

** The generator impedance may be decreased 5%, and the load impedance increased 5%, without changing the specified performance characteristics.

1:2 TURNS RATIO

Pulse Width Range in Microseconds		Source** Impedance (Ohms)	Load** Impedance (Ohms)	Maximum Rise Time Microseconds	Aladdin Part Numbers	
Maximum*	Minimum				Single End Transformers	Double End Transformers
0.1	to 0.06	100	390	0.030	20-121	94-121
0.1	to 0.06	130	560	0.030	20-121	94-121
0.1	to 0.07	200	820	0.035	20-122	94-122
0.2	to 0.06	130	560	0.030	20-122	94-122
0.2	to 0.07	68	270	0.035	20-121	94-121
0.3	to 0.06	100	390	0.030	20-122	94-122
0.3	to 0.07	51	220	0.035	20-121	94-121
0.4	to 0.06	51	220	0.030	20-122	94-122
0.4	to 0.06	150	560	0.030	20-123	94-123
0.5	to 0.06	100	390	0.030	20-123	94-123
0.5	to 0.14	200	820	0.070	20-124	94-124
1.0	to 0.14	180	680	0.070	20-124	94-124
1.0	to 0.24	820	3300	0.160	20-125	94-125
1.1	to 0.07	75	330	0.035	20-123	94-123
1.5	to 0.09	68	270	0.045	20-123	94-123
2.0	to 0.16	110	470	0.08	20-124	94-124
2.0	to 0.24	430	1800	0.16	20-125	94-125
2.0	to 0.40	1200	4700	0.20	20-126	94-126
3.0	to 0.20	82	330	0.10	20-124	94-124
3.0	to 0.24	300	1100	0.12	20-125	94-125
4.0	to 0.32	150	560	0.34	20-125	94-125
4.0	to 0.40	820	3300	0.20	20-126	94-126
5.0	to 0.44	390	1500	0.22	20-126	94-126
8.0	to 0.30	200	820	0.35	20-126	94-126

* For a 10% droop; transformer may be used for greater pulse widths if more droop can be tolerated.
 ** The generator impedance may be decreased 5%, and the load impedance increased 5%, without changing the specified performance characteristics.

1:3 TURNS RATIO

Pulse Width Range in Microseconds		Source** Impedance (Ohms)	Load** Impedance (Ohms)	Maximum Rise Time Microseconds	Aladdin Part Numbers	
Maximum*	Minimum				Single End Transformers	Double End Transformers
0.1	to 0.10	110	1000	0.05	20-127	94-127
0.2	to 0.10	75	680	0.05	20-127	94-127
0.2	to 0.12	130	1200	0.06	20-128	94-128
0.3	to 0.10	68	680	0.05	20-127	94-127
0.3	to 0.10	100	820	0.05	20-128	94-128
0.4	to 0.08	51	470	0.04	20-127	94-127
0.5	to 0.10	68	560	0.05	20-128	94-128
0.5	to 0.14	130	1200	0.07	20-129	94-129
0.5	to 0.18	220	1800	0.09	20-130	94-130
0.6	to 0.26	360	3300	0.13	20-338	94-338
0.7	to 0.10	51	470	0.05	20-128	94-128
1.0	to 0.14	100	820	0.07	20-129	94-129
1.0	to 0.18	150	1200	0.09	20-130	94-130
1.2	to 0.22	91	820	0.11	20-338	94-338
2.0	to 0.14	68	680	0.07	20-129	94-129
2.0	to 0.18	100	820	0.09	20-130	94-130
2.0	to 0.36	430	3900	0.18	20-131	94-131
2.0	to 0.66	820	8200	0.33	20-132	94-132
2.5	to 0.30	43	390	0.15	20-338	94-338
3.0	to 0.14	51	470	0.07	20-129	94-129
3.0	to 0.36	300	2700	0.18	20-131	94-131
4.0	to 0.18	75	680	0.09	20-130	94-130
4.0	to 0.36	240	2200	0.18	20-131	94-131
4.0	to 0.60	510	4700	0.30	20-132	94-132
5.0	to 0.36	220	1800	0.18	20-131	94-131
7.0	to 0.50	22	200	0.25	20-338	94-338
8.0	to 0.62	360	3300	0.31	20-132	94-132

1:4 TURNS RATIO

Pulse Width Range in Microseconds		Source** Impedance (Ohms)	Load** Impedance (Ohms)	Maximum Rise Time Microseconds	Aladdin Part Numbers	
Maximum*	Minimum				Single End Transformers	Double End Transformers
0.2	to 0.10	68	1200	0.05	20-133	94-133
0.3	to 0.10	56	1000	0.05	20-133	94-133
0.4	to 0.30	200	3300	0.15	20-263	94-263
0.4	to 0.10	51	820	0.05	20-133	94-133
0.5	to 0.16	82	1500	0.09	20-135	94-135
0.6	to 0.24	75	1200	0.12	20-263	94-263
0.9	to 0.30	47	680	0.15	20-263	94-263
1.0	to 0.10	68	1000	0.10	20-135	94-135
1.2	to 0.30	150	2200	0.15	20-136	94-136
1.5	to 0.10	51	820	0.10	20-135	94-135
2.0	to 0.24	100	1600	0.12	20-136	94-136
2.0	to 0.54	510	8200	0.27	20-137	94-137
2.5	to 0.38	22	330	0.19	20-263	94-263
3.0	to 0.26	68	1100	0.13	20-136	94-136
3.0	to 0.46	300	4700	0.23	20-137	94-137
3.8	to 0.28	51	820	0.14	20-136	94-136
4.0	to 0.46	240	3900	0.23	20-137	94-137
5.0	to 0.48	220	3300	0.24	20-137	94-137

* For a 10% droop; transformer may be used for greater pulse widths if more droop can be tolerated.

** The generator impedance may be decreased 5%, and the load impedance increased 5%, without changing the specified performance characteristics.

1:5 TURNS RATIO

Pulse Width Range in Microseconds		Source** Impedance (Ohms)	Load** Impedance (Ohms)	Maximum Rise Time Microseconds	Aladdin Part Numbers	
Maximum*	Minimum				Single End Transformers	Double End Transformers
1.0	to 0.34	180	4700	0.20	20-141	94-141
0.9	to 0.40	180	4300	0.20	20-347	94-347
1.5	to 0.28	130	3300	0.21	20-141	94-141
1.4	to 0.36	91	2400	0.18	20-347	94-347
1.5	to 0.18	75	1800	0.09	20-140	94-140
2.0	to 0.18	68	1600	0.10	20-140	94-140
2.5	to 0.18	51	1100	0.09	20-140	94-140
2.5	to 0.24	47	1200	0.25	20-347	94-347
2.5	to 0.50	75	1800	0.25	20-141	94-141
3.0	to 0.28	300	8200	0.32	20-142	94-142
3.0	to 0.64	27	680	0.35	20-347	94-347
4.0	to 0.70	220	5600	0.48	20-142	94-142
4.0	to 0.96	51	1200	0.30	20-141	94-141
5.0	to 0.94	150	3900	0.47	20-142	94-142
6.0	to 0.80	100	2400	0.45	20-142	94-142

1:6 TURNS RATIO

Pulse Width Range in Microseconds		Source** Impedance (Ohms)	Load** Impedance (Ohms)	Maximum Rise Time Microseconds	Aladdin Part Numbers	
Maximum*	Minimum				Single End Transformer	Double End Transformers
1.7	to 0.40	110	3900	0.20	20-146	94-146
2.5	to 0.34	75	2700	0.17	20-146	94-146
3.0	to 0.34	68	2200	0.17	20-146	94-146
5.0	to 0.76	240	8200	0.38	20-147	94-147
5.5	to 0.72	150	5600	0.36	20-147	94-147

1:7 TURNS RATIO

Pulse Width Range in Microseconds		Source** Impedance (Ohms)	Load** Impedance (Ohms)	Maximum Rise Time Microseconds	Aladdin Part Numbers	
Maximum*	Minimum				Single End Transformer	Double End Transformers
0.2	to 0.18	62	3300	0.09	20-148	94-148
0.3	to 0.20	51	2200	0.10	20-148	94-148
0.3	to 0.30	100	4700	0.20	20-149	94-149
0.4	to 0.30	51	2200	0.15	20-149	94-149
1.0	to 0.40	68	4700	0.20	20-150	94-150
1.8	to 0.38	62	3300	0.19	20-150	94-150
2.0	to 0.36	51	2700	0.18	20-150	94-150
2.0	to 0.50	82	5600	0.25	20-151	94-151
3.0	to 0.50	68	3900	0.25	20-151	94-151
3.3	to 0.50	62	3300	0.25	20-151	94-151
4.0	to 0.5	51	2700	0.25	20-151	94-151

* For a 10% droop; transformer may be used for greater pulse widths if more droop can be tolerated.

** The generator impedance may be decreased 5%, and the load impedance increased 5%, without changing the specified performance characteristics.

1:8 TURNS RATIO

Pulse Width Range in Microseconds Maximum* Minimum	Source** Impedance (Ohms)	Load** Impedance (Ohms)	Maximum Rise Time Microseconds	Aladdin Part Numbers	
				Single End Transformers	Double End Transformers
0.3 to 0.30	82	5600	0.22	20-154	94-154
0.4 to 0.36	51	3300	0.18	20-154	94-154
1.0 to 0.54	100	6800	0.27	20-155	94-155
1.5 to 0.48	75	4700	0.24	20-155	94-155
2.0 to 0.44	51	3300	0.22	20-155	94-155
2.0 to 0.70	130	8200	0.35	20-156	94-156
2.5 to 0.64	100	5600	0.32	20-156	94-156
3.0 to 0.58	75	4700	0.29	20-156	94-156
4.0 to 0.56	56	3000	0.28	20-156	94-156

1:9 TURNS RATIO

Pulse Width Range in Microseconds Maximum* Minimum	Source** Impedance (Ohms)	Load** Impedance (Ohms)	Maximum Rise Time Microseconds	Aladdin Part Numbers	
				Single End Transformers	Double End Transformers
0.4 to 0.34	51	3900	0.17	20-158	94-158
1.0 to 0.68	100	8200	0.34	20-159	94-159
2.0 to 0.46	51	3900	0.23	20-159	94-159
2.5 to 0.60	62	4700	0.30	20-160	94-160
3.0 to 0.60	51	3900	0.30	20-160	94-160

1:10 TURNS RATIO

Pulse Width Range in Microseconds Maximum* Minimum	Source** Impedance (Ohms)	Load** Impedance (Ohms)	Maximum Rise Time Microseconds	Aladdin Part Numbers	
				Single End Transformers	Double End Transformers
0.4 to 0.40	51	5600	0.24	20-162	94-162
1.0 to 0.60	82	8200	0.30	20-163	94-163
2.0 to 0.54	51	5600	0.27	20-163	94-163
2.5 to 0.66	82	8200	0.33	20-164	94-164
4.0 to 0.60	51	5600	0.30	20-164	94-164

* For a 10% droop; transformer may be used for greater pulse widths if more droop can be tolerated.

** The generator impedance may be decreased 5%, and the load impedance increased 5%, without changing the specified performance characteristics.

2:1 TURNS RATIO

Pulse Width Range in Microseconds		Source** Impedance (Ohms)	Load** Impedance (Ohms)	Maximum Rise Time Microseconds	Aladdin Part Numbers	
Maximum*	Minimum				Single End Transformers	Double End Transformers
0.10	to 0.06	430	100	0.030	20-121	94-121
0.18	to 0.06	300	75	0.030	20-121	94-121
0.20	to 0.06	300	75	0.030	20-122	94-122
0.30	to 0.07	150	39	0.035	20-121	94-121
0.40	to 0.07	130	33	0.035	20-122	94-122
0.5	to 0.06	620	150	0.030	20-123	94-123
0.5	to 0.10	110	27	0.050	20-121	94-121
0.5	to 0.14	3300	680	0.070	20-124	94-124
0.9	to 0.24	4700	1100	0.130	20-125	94-125
1.0	to 0.07	91	22	0.035	20-122	94-122
1.0	to 0.07	300	68	0.035	20-123	94-123
1.0	to 0.14	1000	220	0.070	20-124	94-124
1.0	to 0.16	56	15	0.080	20-121	94-121
1.5	to 0.16	430	100	0.080	20-124	94-124
1.5	to 0.38	4700	1200	0.190	20-126	94-126
2.0	to 0.10	68	15	0.050	20-122	94-122
2.0	to 0.10	220	56	0.050	20-123	94-123
2.0	to 0.13	750	180	0.065	20-124	94-124
2.0	to 0.24	2000	470	0.260	20-125	94-125
3.0	to 0.12	51	12	0.060	20-122	94-122
3.0	to 0.14	130	33	0.07	20-123	94-123
3.0	to 0.24	910	220	0.30	20-125	94-125
4.0	to 0.40	1800	470	0.20	20-126	94-126
5.5	to 0.32	620	150	0.36	20-125	94-125
6.0	to 0.54	1000	270	0.27	20-126	94-126
8.0	to 0.60	820	220	0.30	20-126	94-126

* For a 10% droop; transformer may be used for greater pulse widths if more droop can be tolerated.
 ** The generator impedance may be decreased 5%, and the load impedance increased 5%, without changing the specified performance characteristics.

3:1 TURNS RATIO

Pulse Width Range in Microseconds		Source** Impedance (Ohms)	Load** Impedance (Ohms)	Maximum Rise Time Microseconds	Aladdin Part Numbers	
Maximum*	Minimum				Single End Transformers	Double End Transformers
0.2	to 0.08	680	82	0.04	20-127	94-127
0.3	to 0.08	510	56	0.04	20-127	94-127
0.4	to 0.08	360	39	0.04	20-127	94-127
0.5	to 0.08	300	33	0.04	20-127	94-127
0.5	to 0.12	820	82	0.06	20-129	94-129
0.5	to 0.14	300	27	0.07	20-128	94-128
0.5	to 0.14	1200	150	0.07	20-130	94-130
0.6	to 0.17	3000	330	0.08	20-338	94-338
0.8	to 0.16	2000	220	0.08	20-338	94-338
1.0	to 0.12	680	68	0.06	20-129	94-129
1.0	to 0.18	180	20	0.09	20-128	94-128
1.0	to 0.18	750	82	0.09	20-130	94-130
1.5	to 0.36	5600	680	0.18	20-131	94-131
2.0	to 0.14	510	47	0.07	20-129	94-129
2.0	to 0.26	130	15	0.13	20-128	94-128
2.0	to 0.32	3900	470	0.16	20-131	94-131
2.4	to 0.26	620	68	0.13	20-338	94-338
3.0	to 0.16	300	27	0.08	20-129	94-129
3.0	to 0.34	2200	270	0.17	20-131	94-131
3.0	to 0.54	6800	680	0.27	20-132	94-132
4.0	to 0.20	510	56	0.10	20-130	94-130
4.0	to 0.66	4700	560	0.33	20-132	94-132
5.0	to 0.40	91	10	0.20	20-128	94-128
5.0	to 0.42	1500	150	0.21	20-131	94-131
6.0	to 0.26	300	33	0.13	20-130	94-130
7.0	to 0.60	3300	390	0.30	20-132	94-132
10.0	to 0.72	1800	220	0.36	20-132	94-132

* For a 10% droop; transformer may be used for greater pulse widths if more droop can be tolerated.

** The generator impedance may be decreased 5%, and the load impedance increased 5%, without changing the specified performance characteristics.

4:1 TURNS RATIO

Pulse Width Range in Microseconds		Source** Impedance (Ohms)	Load** Impedance (Ohms)	Maximum Rise Time Microseconds	Aladdin Part Numbers	
Maximum*	Minimum				Single End Transformers	Double End Transformers
0.3	to 0.06	620	39	0.03	20-133	94-133
0.5	to 0.08	360	22	0.04	20-133	94-133
0.5	to 0.10	1500	100	0.08	20-135	94-135
0.5	to 0.12	430	27	0.06	20-134	94-134
0.6	to 0.19	3000	180	0.09	20-263	94-263
0.7	to 0.19	2400	150	0.09	20-263	94-263
0.8	to 0.20	2400	150	0.10	20-136	94-136
0.9	to 0.18	1600	100	0.09	20-263	94-263
1.0	to 0.10	1200	68	0.09	20-135	94-135
1.0	to 0.14	300	22	0.07	20-134	94-134
1.0	to 0.14	240	15	0.07	20-133	94-133
1.3	to 0.20	1600	100	0.10	20-136	94-136
1.5	to 0.12	680	39	0.12	20-135	94-135
2.0	to 0.12	430	22	0.16	20-135	94-135
2.0	to 0.18	150	10	0.09	20-133	94-133
2.0	to 0.32	150	10	0.16	20-134	94-134
2.0	to 0.42	5600	330	0.21	20-137	94-137
2.5	to 0.24	1100	68	0.12	20-136	94-136
2.5	to 0.34	510	33	0.17	20-263	94-263
3.0	to 0.32	910	56	0.16	20-136	94-136
3.0	to 0.42	4700	270	0.21	20-137	94-137
4.0	to 0.46	3300	220	0.23	20-137	94-137
5.0	to 0.40	360	22	0.20	20-263	94-263
5.0	to 0.46	2700	180	0.20	20-137	94-137
7.5	to 0.62	240	15	0.23	20-263	94-263
				0.31		

* For a 10% droop; transformer may be used for greater pulse widths if more droop can be tolerated.

** The generator impedance may be decreased 5%, and the load impedance increased 5%, without changing the specified performance characteristics.

5:1 TURNS RATIO

Pulse Width Range in Microseconds		Source** Impedance (Ohms)	Load** Impedance (Ohms)	Maximum Rise Time Microseconds	Aladdin Part Numbers	
Maximum*	Minimum				Single End Transformers	Double End Transformers
0.1	to 0.06	1200	47	0.030	20-138	94-138
0.1	to 0.10	560	22	0.050	20-139	94-139
0.3	to 0.05	680	27	0.025	20-138	94-138
0.5	to 0.05	430	15	0.025	20-138	94-138
0.5	to 0.12	820	33	0.060	20-139	94-139
0.5	to 0.36	8200	330	0.15	20-141	94-141
1.0	to 0.10	240	10	0.05	20-138	94-138
1.0	to 0.16	1800	68	0.08	20-140	94-140
1.0	to 0.24	2700	120	0.16	20-141	94-141
1.0	to 0.44	10000	390	0.22	20-347	94-347
1.3	to 0.28	3900	150	0.14	20-347	94-347
1.5	to 0.10	470	18	0.05	20-139	94-139
1.5	to 0.16	2200	82	0.08	20-140	94-140
1.5	to 0.20	2400	100	0.18	20-141	94-141
1.9	to 0.34	2700	100	0.17	20-347	94-347
2.0	to 0.14	240	10	0.07	20-139	94-139
2.0	to 0.20	2200	82	0.20	20-141	94-141
3.0	to 0.20	1000	39	0.10	20-140	94-140
3.2	to 0.46	1500	56	0.23	20-347	94-347
4.0	to 0.48	5600	240	0.24	20-142	94-142
4.2	to 0.58	1000	39	0.29	20-347	94-347
5.0	to 0.36	510	18	0.18	20-140	94-140
5.0	to 0.52	3900	150	0.26	20-142	94-142
5.3	to 0.78	680	27	0.39	20-347	94-347
6.0	to 0.56	3300	120	0.28	20-142	94-142
7.0	to 1.28	360	15	0.64	20-347	94-347
9.0	to 0.76	2000	82	0.38	20-142	94-142

6:1 TURNS RATIO

Pulse Width Range in Microseconds		Source** Impedance (Ohms)	Load** Impedance (Ohms)	Maximum Rise Time Microseconds	Aladdin Part Numbers	
Maximum*	Minimum				Single End Transformers	Double End Transformers
0.35	to 0.20	820	22	0.10	20-143	94-143
0.50	to 0.22	1000	27	0.11	20-144	94-144
0.70	to 0.24	360	10	0.12	20-143	94-143
1.00	to 0.24	680	18	0.12	20-144	94-144
1.00	to 0.28	2200	56	0.14	20-145	94-145
1.0	to 0.42	6800	180	0.21	20-146	94-146
1.4	to 0.26	300	8.2	0.13	20-143	94-143
2.0	to 0.30	430	10	0.15	20-144	94-144
2.0	to 0.28	1800	47	0.14	20-145	94-145
2.0	to 0.32	3300	100	0.16	20-146	94-146
2.0	to 0.32	180	4.7	0.16	20-143	94-143
3.0	to 0.32	1000	27	0.16	20-145	94-145
3.0	to 0.34	1800	47	0.17	20-146	94-146
4.0	to 0.36	11000	300	0.18	20-147	94-147
5.0	to 0.44	680	18	0.22	20-145	94-145
5.0	to 0.36	1500	39	0.18	20-146	94-146
6.0	to 0.36	8200	220	0.18	20-147	94-147
8.0	to 0.64	3900	110	0.32	20-147	94-147

* For a 10% droop; transformer may be used for greater pulse widths if more droop can be tolerated.

** The generator impedance may be decreased 5%, and the load impedance increased 5%, without changing the specified performance characteristics.

7:1 TURNS RATIO

Pulse Width Range in Microseconds		Source** Impedance (Ohms)	Load** Impedance (Ohms)	Maximum Rise Time Microseconds	Aladdin Part Numbers	
Maximum*	Minimum				Single End Transformers	Double End Transformers
0.3	to 0.24	1600	36	0.12	20-148	94-148
0.5	to 0.24	1000	22	0.12	20-148	94-148
0.5	to 0.26	1800	39	0.13	20-149	94-149
0.6	to 0.52	8200	150	0.26	20-150	94-150
1.0	to 0.24	750	15	0.12	20-148	94-148
1.0	to 0.26	1000	22	0.13	20-149	94-149
1.0	to 0.36	4700	110	0.18	20-150	94-150
1.0	to 0.46	5600	120	0.23	20-151	94-151
1.5	to 0.26	510	11	0.13	20-148	94-148
1.5	to 0.46	4700	100	0.23	20-151	94-151
2.0	to 0.36	470	10	0.18	20-149	94-149
2.0	to 0.44	3900	82	0.22	20-151	94-151
2.0	to 1.10	18000	390	0.55	20-152	94-152
2.5	to 0.34	2400	47	0.17	20-150	94-150
3.0	to 0.54	270	4.7	0.27	20-149	94-149
3.0	to 0.44	1100	22	0.22	20-150	94-150
3.0	to 0.46	2700	56	0.23	20-151	94-151
4.0	to 0.80	12000	220	0.40	20-152	94-152
6.0	to 0.76	10000	180	0.38	20-152	94-152
10.0	to 0.76	5600	120	0.38	20-152	94-152

8:1 TURNS RATIO

Pulse Width Range in Microseconds		Source** Impedance (Ohms)	Load** Impedance (Ohms)	Maximum Rise Time Microseconds	Aladdin Part Numbers	
Maximum*	Minimum				Single End Transformers	Double End Transformers
0.3	to 0.22	1800	27	0.11	20-153	94-153
0.5	to 0.22	1000	18	0.11	20-153	94-153
0.5	to 0.28	2200	39	0.14	20-154	94-154
0.5	to 0.50	10000	150	0.26	20-155	94-155
0.7	to 0.30	1500	22	0.15	20-154	94-154
1.0	to 0.40	6800	100	0.20	20-155	94-155
1.0	to 0.32	1000	15	0.16	20-154	94-154
1.0	to 0.22	750	12	0.11	20-153	94-153
1.3	to 0.24	620	10	0.12	20-153	94-153
2.0	to 0.36	620	10	0.18	20-154	94-154
2.0	to 0.38	2700	39	0.19	20-155	94-155
2.0	to 0.56	9100	150	0.28	20-156	94-156
2.5	to 0.50	4700	75	0.25	20-156	94-156
3.0	to 0.40	1800	22	0.20	20-155	94-155
3.5	to 0.54	3300	51	0.27	20-156	94-156

* For a 10% droop; transformer may be used for greater pulse widths if more droop can be tolerated.
 ** The generator impedance may be decreased 5%, and the load impedance increased 5%, without changing the specified performance characteristics.

9:1 TURNS RATIO

Pulse Width Range in Microseconds		Source** Impedance (Ohms)	Load** Impedance (Ohms)	Maximum Rise Time Microseconds	Aladdin Part Numbers	
Maximum*	Minimum				Single End Transformers	Double End Transformers
0.4	to 0.28	4700	56	0.14	20-158	94-158
0.5	to 0.26	1600	22	0.13	20-158	94-158
0.7	to 0.24	1500	18	0.12	20-157	94-157
1.0	to 0.28	820	10	0.14	20-157	94-157
1.0	to 0.30	910	11	0.15	20-158	94-158
1.3	to 0.40	6800	82	0.20	20-159	94-159
2.0	to 0.36	430	4.7	0.18	20-157	94-157
2.0	to 0.26	620	8.2	0.13	20-158	94-158
2.0	to 0.36	4700	56	0.18	20-159	94-159
2.0	to 0.50	6800	82	0.25	20-160	94-160
3.0	to 0.36	2700	30	0.18	20-159	94-159
3.0	to 0.50	4700	56	0.25	20-160	94-160
4.0	to 0.40	2000	22	0.20	20-159	94-159
4.0	to 0.52	2700	36	0.26	20-160	94-160
6.0	to 0.64	1600	22	0.32	20-160	94-160

10:1 TURNS RATIO

Pulse Width Range in Microseconds		Source** Impedance (Ohms)	Load** Impedance (Ohms)	Maximum Rise Time Microseconds	Aladdin Part Numbers	
Maximum*	Minimum				Single End Transformers	Double End Transformers
0.5	to 0.34	4700	47	0.17	20-162	94-162
0.5	to 0.26	2700	27	0.13	20-161	94-161
1.0	to 0.34	2200	22	0.17	20-162	94-162
1.0	to 0.28	1500	15	0.14	20-161	94-161
1.0	to 0.46	6800	68	0.23	20-163	94-163
1.5	to 0.38	1600	16	0.19	20-162	94-162
1.5	to 0.30	1000	10	0.15	20-161	94-161
1.5	to 0.42	4700	47	0.21	20-163	94-163
2.0	to 0.44	3300	33	0.22	20-163	94-163
2.0	to 0.44	470	4.7	0.22	20-161	94-161
2.5	to 0.50	1000	10	0.25	20-162	94-162
3.0	to 0.52	6800	68	0.26	20-164	94-164
5.0	to 0.64	1500	15	0.32	20-163	94-163
5.0	to 0.48	4700	47	0.24	20-164	94-164
7.0	to 0.48	2700	27	0.24	20-164	94-164
8.0	to 0.54	2200	22	0.27	20-164	94-164

* For a 10% droop; transformer may be used for greater pulse widths if more droop can be tolerated.
 ** The generator impedance may be decreased 5%, and the load impedance increased 5%, without changing the specified performance characteristics.

15:1 TURNS RATIO

Pulse Width Range in Microseconds		Source** Impedance (Ohms)	Load** Impedance (Ohms)	Maximum Rise Time Microseconds	Aladdin Part Numbers	
Maximum*	Minimum				Single End Transformers	Double End Transformers
0.3	to 0.28	2200	10	0.14	20-165	94-165
0.5	to 0.36	4700	20	0.18	20-166	94-166
0.8	to 0.30	1100	4.7	0.15	20-165	94-165
1.0	to 0.34	2200	10	0.17	20-166	94-166
1.0	to 0.38	4700	20	0.19	20-167	94-167
1.5	to 0.40	2200	10	0.20	20-167	94-167
2.0	to 0.44	1200	4.7	0.22	20-166	94-166
2.0	to 0.70	8200	39	0.35	20-168	94-168
3.0	to 0.38	1800	8.2	0.19	20-167	94-167
3.0	to 0.66	5600	27	0.33	20-168	94-168
4.0	to 0.64	4700	22	0.32	20-168	94-168
5.0	to 0.50	1200	4.7	0.25	20-167	94-167
5.0	to 0.66	3900	18	0.33	20-168	94-168

20:1 TURNS RATIO

Pulse Width Range in Microseconds		Source** Impedance (Ohms)	Load** Impedance (Ohms)	Maximum Rise Time Microseconds	Aladdin Part Numbers	
Maximum*	Minimum				Single End Transformers	Double End Transformers
0.5	to 0.46	5600	15	0.23	20-170	94-170
1.0	to 0.44	3900	10	0.22	20-170	94-170
1.0	to 0.52	8200	22	0.26	20-171	94-171
1.5	to 0.44	3300	8.2	0.22	20-170	94-170
1.5	to 0.48	5600	15	0.24	20-171	94-171
2.0	to 0.50	2000	4.7	0.25	20-170	94-170
2.5	to 0.48	3900	10	0.24	20-171	94-171
3.0	to 0.48	3300	8.2	0.24	20-171	94-171

* For a 10% droop; transformer may be used for greater pulse widths if more droop can be tolerated.

** The generator impedance may be decreased 5%, and the load impedance increased 5%, without changing the specified performance characteristics.

1:1:1 TURNS RATIO

Pulse Width Range in Microseconds		Source** Impedance (Ohms)	Load# Impedance (Ohms)	Maximum## Rise Time Microseconds	Aladdin Part Numbers Double End
Maximum*	Minimum				
0.10	to 0.05	75	150	0.025	94-172
0.12	to 0.06	180	390	0.030	94-173
0.20	to 0.05	51	100	0.025	94-172
0.20	to 0.06	110	220	0.030	94-173
0.30	to 0.06	75	150	0.030	94-173
0.3	to 0.07	240	470	0.035	94-176
0.4	to 0.05	110	220	0.025	94-174
0.4	to 0.05	240	470	0.025	94-175
0.4	to 0.06	51	100	0.030	94-173
0.4	to 0.09	510	1000	0.045	94-177
0.6	to 0.08	110	240	0.040	94-175
0.7	to 0.05	75	160	0.025	94-174
0.8	to 0.05	240	470	0.025	94-177
1.0	to 0.06	150	300	0.060	94-176
1.0	to 0.08	56	100	0.040	94-174
1.0	to 0.14	75	160	0.070	94-175
1.3	to 0.08	51	100	0.040	94-174
1.5	to 0.12	110	220	0.060	94-177
1.5	to 0.15	330	680	0.075	94-178
1.8	to 0.08	75	160	0.080	94-176
1.8	to 0.30	820	1600	0.15	94-179
1.8	to 0.32	1600	3300	0.16	94-180
2.0	to 0.26	220	430	0.13	94-178
2.0	to 0.14	51	100	0.07	94-175
2.5	to 0.40	1600	3300	0.20	94-181
3.0	to 0.12	51	100	0.12	94-176
3.0	to 0.30	1000	2000	0.15	94-180
3.0	to 0.44	100	220	0.22	94-178
4.0	to 0.28	51	100	0.14	94-177
4.0	to 0.30	510	1000	0.15	94-179
5.0	to 0.54	330	680	0.27	94-179
5.5	to 0.40	1000	1800	0.20	94-181
6.0	to 1.10	68	120	0.55	94-178
6.0	to 0.32	620	1100	0.16	94-180
7.0	to 0.80	240	470	0.40	94-179
8.0	to 0.46	560	1100	0.23	94-181
11.0	to 0.52	330	680	0.26	94-180
13.0	to 0.68	330	680	0.34	94-181

- * For a 10% droop; transformer may be used for greater pulse widths if more droop can be tolerated.
 ** The generator impedance may be decreased 5%, and the load impedance increased 5%, without changing the specified performance characteristics.
 # The tabulated load impedance is the load across each secondary.
 ## The tabulated maximum rise time is the maximum rise time at each secondary.

1:2:2 TURNS RATIO

Pulse Width Range in Microseconds Maximum* Minimum	Source** Impedance (Ohms)	Load# Impedance (Ohms)	Maximum## Rise Time Microseconds	Aladdin Part Numbers Double End
0.13 to 0.06	130	1000	0.03	94-184
0.13 to 0.10	150	1100	0.05	94-183
0.15 to 0.10	100	820	0.05	94-183
0.20 to 0.06	82	680	0.03	94-184
0.20 to 0.08	51	390	0.04	94-183
0.3 to 0.06	68	560	0.03	94-184
0.5 to 0.06	51	390	0.03	94-184
1.0 to 0.12	150	1100	0.06	94-185
1.0 to 0.16	180	1600	0.08	94-186
1.5 to 0.14	82	680	0.08	94-185
1.5 to 0.18	150	1100	0.09	94-186
2.0 to 0.14	68	560	0.10	94-185
2.0 to 0.16	110	910	0.08	94-186
2.5 to 0.18	51	390	0.12	94-185
6.0 to 0.36	270	2200	0.18	94-187
7.0 to 0.36	150	1100	0.18	94-187
8.0 to 0.32	180	1600	0.16	94-187

1:3:3 TURNS RATIO

Pulse Width Range in Microseconds Maximum* Minimum	Source** Impedance (Ohms)	Load# Impedance (Ohms)	Maximum## Rise Time Microseconds	Aladdin Part Numbers Double End
0.10 to 0.10	100	1800	0.065	94-188
0.15 to 0.10	82	1500	0.050	94-188
0.20 to 0.12	68	1200	0.060	94-188
0.20 to 0.12	91	1500	0.060	94-189
0.25 to 0.10	51	1000	0.050	94-188
0.3 to 0.10	51	1000	0.05	94-189
0.3 to 0.16	68	1200	0.08	94-190
0.5 to 0.18	56	1000	0.09	94-190
1.5 to 0.30	110	2000	0.15	94-191
2.5 to 0.30	68	1100	0.15	94-191
3.0 to 0.26	51	1000	0.13	94-191
4.0 to 0.52	300	5600	0.26	94-192
4.5 to 0.46	240	4700	0.23	94-192
5.5 to 0.46	150	3000	0.23	94-192
7.0 to 0.50	100	1800	0.25	94-192

- * For a 10% droop; transformer may be used for greater pulse widths if more droop can be tolerated.
 ** The generator impedance may be decreased 5%, and the load impedance increased 5%, without changing the specified performance characteristics.
 # The tabulated load impedance is the load across each secondary.
 ## The tabulated maximum rise time is the maximum rise time at each secondary.

1:4:4 TURNS RATIO

Pulse Width Range in Microseconds		Source** Impedance (Ohms)	Load# Impedance (Ohms)	Maximum## Rise Time Microseconds	Aladdin Part Numbers Double End
Maximum*	Minimum				
0.20	to 0.14	51	1800	0.07	94-193
0.30	to 0.20	82	2700	0.10	94-194
0.35	to 0.16	51	1800	0.08	94-194
1.00	to 0.16	75	2700	0.08	94-195
1.00	to 0.36	100	3300	0.18	94-196
1.5	to 0.16	51	1800	0.08	94-195
1.5	to 0.40	82	2700	0.20	94-196
2.0	to 0.42	68	2200	0.21	94-196
3.0	to 0.44	51	1800	0.22	94-196

1:5:5 TURNS RATIO

Pulse Width Range in Microseconds		Source** Impedance (Ohms)	Load# Impedance (Ohms)	Maximum## Rise Time Microseconds	Aladdin Part Number Double End
Maximum*	Minimum				
0.2	to 0.20	51	2400	0.10	94-197
0.4	to 0.20	68	3300	0.10	94-198
0.6	to 0.18	51	2700	0.09	94-198
1.0	to 0.40	100	4700	0.20	94-199
1.5	to 0.32	51	2400	0.16	94-199
3.0	to 0.36	100	4700	0.18	94-200
4.0	to 0.32	56	2700	0.16	94-200
5.0	to 0.34	47	2200	0.17	94-200

- * For a 10% droop; transformer may be used for greater pulse widths if more droop can be tolerated.
 ** The generator impedance may be decreased 5%, and the load impedance increased 5%, without changing the specified performance characteristics.
 # The tabulated load impedance is the load across each secondary.
 ## The tabulated maximum rise time is the maximum rise time at each secondary.

2:1:1 TURNS RATIO

Pulse Width Range in Microseconds		Source** Impedance (Ohms)	Load# Impedance (Ohms)	Maximum## Rise Time Microseconds	Aladdin Part Numbers Double End
Maximum*	Minimum				
0.25	to .07	51	27	.035	94-204
0.30	to .08	130	68	.040	94-205
0.40	to .14	200	100	.070	94-206
0.50	to .08	110	56	.040	94-205
0.60	to .16	130	68	.080	94-206
0.7	to .12	62	33	.06	94-205
0.8	to .14	51	27	.07	94-205
1.0	to .16	100	47	.08	94-206
1.0	to .16	300	150	.08	94-207
1.0	to .20	39	18	.10	94-205
1.3	to .18	62	30	.09	94-206
1.5	to .18	510	270	.09	94-208
1.8	to .20	51	27	.10	94-206
2.0	to .26	180	82	.13	94-207
2.0	to .20	430	220	.10	94-208
2.0	to .42	1500	680	.21	94-209
3.0	to .46	1000	470	.23	94-209
3.0	to .30	110	68	.15	94-207
3.0	to .32	240	120	.16	94-208
4.0	to .64	560	270	.32	94-209
4.0	to .36	100	47	.18	94-207
4.0	to .44	1600	680	.22	94-210
5.0	to .64	560	270	.32	94-209
5.0	to .44	1100	560	.22	94-210
8.0	to .44	910	470	.22	94-210
10.0	to .52	620	300	.26	94-210

* For a 10% droop; transformer may be used for greater pulse widths if more droop can be tolerated.

** The generator impedance may be decreased 5%, and the load impedance increased 5%, without changing the specified performance characteristics.

The tabulated secondary impedance is the load across the secondary and the load across the tertiary.

The tabulated maximum rise time is the maximum rise time at both the secondary and the tertiary.

3:1:1 TURNS RATIO

Pulse Width Range in Microseconds		Source** Impedance (Ohms)	Load# Impedance (Ohms)	Maximum## Rise Time Microseconds		Aladdin Part Numbers Double End
Maximum*	Minimum					
0.20	to 0.12	150	36	0.06		94-211
0.35	to 0.14	180	39	0.07		94-212
0.40	to 0.14	100	22	0.07		94-211
0.50	to 0.20	220	47	0.10		94-213
0.50	to 0.16	75	15	0.08		94-211
0.6	to 0.14	150	33	0.07		94-212
0.7	to 0.22	51	10	0.11		94-211
1.0	to 0.16	150	36	0.08		94-213
1.0	to 0.22	680	150	0.11		94-214
1.3	to 0.20	2200	470	0.10		94-215
1.3	to 0.18	91	22	0.09		94-212
1.5	to 0.30	510	120	0.15		94-214
1.5	to 0.20	100	22	0.10		94-213
1.5	to 0.34	4700	1100	0.17		94-216
2.0	to 0.28	1000	180	0.14		94-215
2.0	to 0.40	360	82	0.20		94-214
2.0	to 0.30	68	15	0.15		94-213
2.3	to 0.34	3300	680	0.17		94-216
3.0	to 0.42	300	68	0.21		94-214
3.0	to 0.38	2200	430	0.19		94-216
3.5	to 0.32	51	13	0.16		94-213
3.5	to 0.46	1600	330	0.23		94-216
4.0	to 0.38	470	100	0.19		94-215
8.0	to 0.68	220	47	0.34		94-215

3:3:2 TURNS RATIO

Pulse Width Range in Microseconds		Source** Impedance (Ohms)	Secondary# Impedance (Ohms)	Maximum Rise Time## Microseconds		Aladdin Part Numbers Double End
Maximum*	Minimum			Secondary	Tertiary	
0.40	to 0.10	620	1200	0.045	0.050	94-357
0.60	to 0.09	240	510	0.045	0.045	94-357
0.80	to 0.11	180	330	0.055	0.055	94-357
1.35	to 0.26	62	120	0.130	0.110	94-357
2.30	to 0.60	22	39	0.300	0.220	94-357

* For a 10% droop; transformer may be used for greater pulse widths if more droop can be tolerated.

** The generator impedance may be decreased 5%, and the load impedance increased 5%, without changing the specified performance characteristics.

The tabulated secondary impedance is the load across the secondary and the load across the tertiary.

The tabulated maximum rise time is the maximum rise time at both the secondary and the tertiary.

4:1:1 TURNS RATIO

Pulse Width Range in Microseconds		Source** Impedance (Ohms)	Load# Impedance (Ohms)	Maximum## Rise Time Microseconds	Aladdin Part Numbers Double End
Maximum*	Minimum				
0.4	to 0.12	180	22	0.06	94-217
0.5	to 0.14	130	15	0.07	94-217
0.5	to 0.20	2400	300	0.10	94-220
0.6	to 0.16	200	39	0.08	94-218
0.8	to 0.18	75	10	0.09	94-217
1.0	to 0.22	180	22	0.11	94-218
1.0	to 0.16	300	39	0.08	94-219
1.0	to 0.22	1100	150	0.11	94-220
1.0	to 0.30	3300	430	0.15	94-221
1.0	to 0.26	56	6.8	0.13	94-217
1.5	to 0.26	130	15	0.13	94-218
1.5	to 0.28	2200	270	0.14	94-221
2.0	to 0.34	75	10	0.17	94-218
2.0	to 0.26	180	22	0.13	94-219
2.0	to 0.24	750	100	0.12	94-220
2.0	to 0.30	1600	180	0.15	94-221
3.0	to 0.36	470	56	0.18	94-220
3.0	to 0.36	1000	120	0.18	94-221
3.0	to 0.34	110	15	0.17	94-219
4.0	to 0.42	82	10	0.21	94-219

5:1:1 TURNS RATIO

Pulse Width Range in Microseconds		Source** Impedance (Ohms)	Load# Impedance (Ohms)	Maximum## Rise Time Microseconds	Aladdin Part Numbers Double End
Maximum*	Minimum				
0.5	to 0.10	180	15	0.050	94-222
0.5	to 0.12	1300	100	0.060	94-224
0.5	to 0.26	3900	300	0.130	94-225
0.8	to 0.11	750	56	0.055	94-224
0.8	to 0.25	2200	180	0.125	94-225
1.0	to 0.08	330	27	0.040	94-223
1.0	to 0.18	110	10	0.090	94-222
1.5	to 0.11	510	39	0.055	94-224
1.5	to 0.30	3900	300	0.150	94-226
1.5	to 0.18	180	15	0.090	94-223
1.5	to 0.22	91	6.8	0.11	94-222
1.7	to 0.26	1100	100	0.13	94-225
2.0	to 0.30	2400	180	0.15	94-226
2.0	to 0.22	150	13	0.11	94-223
2.5	to 0.30	2000	150	0.15	94-226
2.5	to 0.24	220	18	0.12	94-224
3.0	to 0.40	620	51	0.20	94-225
3.0	to 0.26	110	10	0.13	94-223
4.0	to 0.44	1100	82	0.22	94-226

* For a 10% droop; transformer may be used for greater pulse widths if more droop can be tolerated.

** The generator impedance may be decreased 5%, and the load impedance increased 5%, without changing the specified performance characteristics.

The tabulated secondary impedance is the load across the secondary and the load across the tertiary.

The tabulated maximum rise time is the maximum rise time at both the secondary and the tertiary.

6:1:1 TURNS RATIO

Pulse Width Range in Microseconds		Source** Impedance (Ohms)	Load# Impedance (Ohms)	Maximum## Rise Time Microseconds	Aladdin Part Numbers Double End
Maximum*	Minimum				
0.2	to 0.10	590	33	0.05	94-227
0.3	to 0.10	500	27	0.05	94-227
0.4	to 0.12	300	18	0.06	94-227
0.4	to 0.12	1200	68	0.06	94-228
0.5	to 0.18	180	10	0.09	94-227
0.6	to 0.16	850	47	0.08	94-229
0.9	to 0.20	590	33	0.10	94-229
1.0	to 0.20	360	22	0.10	94-228
1.1	to 0.22	500	27	0.11	94-229
1.5	to 0.22	300	18	0.11	94-228
1.5	to 0.24	360	22	0.12	94-229
1.5	to 0.22	1600	100	0.11	94-230
1.5	to 0.30	3900	220	0.15	94-231
2.0	to 0.32	180	10	0.16	94-228
2.0	to 0.26	1100	68	0.13	94-230
2.5	to 0.30	910	56	0.15	94-230
2.5	to 0.30	2700	160	0.15	94-231
3.0	to 0.34	750	47	0.17	94-230
3.5	to 0.32	2000	100	0.16	94-231
3.5	to 0.46	1100	68	0.23	94-231
7.0	to 0.58	820	47	0.29	94-231

7:1:1 TURNS RATIO

Pulse Width Range in Microseconds		Source** Impedance (Ohms)	Load# Impedance (Ohms)	Maximum## Rise Time Microseconds	Aladdin Part Number Double End
Maximum*	Minimum				
0.25	to 0.10	750	27	0.05	94-232
0.30	to 0.12	1800	68	0.06	94-233
0.35	to 0.12	510	22	0.06	94-232
0.40	to 0.12	1200	47	0.06	94-233
0.50	to 0.16	330	15	0.08	94-232
0.60	to 0.12	750	27	0.06	94-233
0.60	to 0.14	2000	68	0.07	94-234
0.65	to 0.20	240	10	0.10	94-232
0.65	to 0.30	5600	220	0.15	94-235
1.00	to 0.18	430	18	0.09	94-233
1.3	to 0.26	2700	100	0.13	94-235
1.4	to 0.36	110	4.7	0.18	94-232
1.5	to 0.14	1000	39	0.07	94-234
2.0	to 0.32	5600	220	0.16	94-236
2.5	to 0.24	470	22	0.12	94-234
3.0	to 0.32	3900	160	0.16	94-236
3.0	to 0.36	1100	47	0.18	94-235
4.0	to 0.40	270	10	0.20	94-234
6.0	to 0.70	510	22	0.35	94-235
8.0	to 0.50	1100	47	0.35	94-236

* For a 10% droop; transformer may be used for greater pulse widths if more droop can be tolerated.

** The generator impedance may be decreased 5%, and the load impedance increased 5%, without changing the specified performance characteristics.

The tabulated secondary impedance is the load across the secondary and the load across the tertiary.

The tabulated maximum rise time is the maximum rise time at both the secondary and the tertiary.

8:1:1 TURNS RATIO

Pulse Width Range in Microseconds Maximum* Minimum	Source** Impedance (Ohms)	Load# Impedance (Ohms)	Maximum## Rise Time Microseconds	Aladdin Part Numbers Double End
0.2 to 0.11	1100	39	0.055	94-237
0.4 to 0.12	750	22	0.060	94-237
0.5 to 0.14	470	15	0.070	94-237
0.5 to 0.13	1500	47	0.065	94-238
0.6 to 0.13	1000	33	0.065	94-238
0.7 to 0.24	300	10	0.12	94-237
1.0 to 0.22	750	22	0.11	94-239
1.0 to 0.20	510	15	0.10	94-238
1.4 to 0.28	560	18	0.14	94-239
1.7 to 0.32	4700	150	0.16	94-240
1.7 to 0.44	7500	220	0.22	94-241
2.0 to 0.28	470	15	0.14	94-239
2.0 to 0.32	3300	100	0.16	94-240
2.0 to 0.26	300	10	0.13	94-238
2.0 to 0.40	4700	150	0.20	94-241
2.5 to 0.32	2400	75	0.16	94-240
3.5 to 0.40	3300	100	0.20	94-241
4.0 to 0.38	330	10	0.19	94-239
4.0 to 0.38	1600	51	0.19	94-240
4.5 to 0.42	2400	75	0.21	94-241

9:1:1 TURNS RATIO

Pulse Width Range in Microseconds Maximum* Minimum	Source** Impedance (Ohms)	Load# Impedance (Ohms)	Maximum## Rise Time Microseconds	Aladdin Part Numbers Double End
0.25 to 0.10	1100	27	0.050	94-242
0.30 to 0.10	820	22	0.050	94-242
0.45 to 0.11	620	15	0.055	94-242
0.50 to 0.20	3300	75	0.100	94-244
0.60 to 0.17	430	10	0.085	94-242
0.6 to 0.16	1100	39	0.08	94-243
0.8 to 0.18	820	22	0.09	94-243
0.8 to 0.16	2000	51	0.08	94-244
1.4 to 0.22	620	15	0.11	94-243
1.8 to 0.20	820	22	0.10	94-244
1.8 to 0.34	3900	100	0.17	94-245
2.0 to 0.30	430	10	0.15	94-243
2.5 to 0.34	2700	68	0.17	94-245
3.0 to 0.34	2400	75	0.17	94-245
3.0 to 0.52	6800	150	0.26	94-246
3.5 to 0.36	2000	51	0.18	94-245
4.0 to 0.38	430	10	0.19	94-244
4.0 to 0.56	3900	100	0.28	94-246
4.5 to 0.46	1000	39	0.23	94-245
5.0 to 0.60	2700	68	0.30	94-246
7.0 to 0.64	1800	47	0.32	94-246

* For a 10% droop; transformer may be used for greater pulse widths if more droop can be tolerated.

** The generator impedance may be decreased 5%, and the load impedance increased 5%, without changing the specified performance characteristics.

The tabulated secondary impedance is the load across the secondary and the load across the tertiary.

The tabulated maximum rise time is the maximum rise time at both the secondary and the tertiary.

10:1:1 TURNS RATIO

Pulse Width Range in Microseconds		Source** Impedance (Ohms)	Load# Impedance (Ohms)	Maximum## Rise Time Microseconds		Aladdin Part Numbers Double End
Maximum*	Minimum					
0.3	to 0.18	1600	33	0.09		94-247
0.6	to 0.16	2000	39	0.08		94-248
0.6	to 0.20	750	15	0.10		94-247
0.8	to 0.24	510	10	0.12		94-247
1.0	to 0.16	1000	22	0.08		94-248
1.0	to 0.20	1600	27	0.10		94-249
1.0	to 0.26	330	6.8	0.13		94-247
1.5	to 0.26	1000	22	0.13		94-249
1.8	to 0.20	15000	300	0.10		94-250
2.5	to 0.32	750	15	0.16		94-249
2.5	to 0.48	3900	75	0.24		94-250
2.5	to 0.26	510	10	0.13		94-248
3.0	to 0.48	3300	68	0.24		94-250
3.0	to 0.58	9100	180	0.29		94-251
4.0	to 0.52	2000	39	0.26		94-250
4.5	to 0.50	510	10	0.25		94-249
4.5	to 0.50	240	4.7	0.25		94-248
5.0	to 0.48	4700	100	0.24		94-251
7.0	to 0.56	1200	27	0.28		94-250
9.0	to 0.56	2400	47	0.28		94-251

10:5:1 TURNS RATIO

Pulse Width Range in Microseconds		Source** Impedance (Ohms)	Secondary# Impedance (Ohms)	Maximum Rise Time## Microseconds		Aladdin Part Numbers Double End
Maximum*	Minimum			Secondary	Tertiary	
0.45	to 0.29	3900	2000	0.096	0.145	94-302
0.50	to 0.20	1800	1300	0.064	0.100	94-302
0.80	to 0.20	1100	560	0.052	0.100	94-302
1.60	to 0.32	510	230	0.057	0.160	94-302

* For a 10% droop; transformer may be used for greater pulse widths if more droop can be tolerated.

** The generator impedance may be decreased 5%, and the load impedance increased 5%, without changing the specified performance characteristics.

The tabulated secondary impedance is the load across the secondary and the load across the tertiary.

The tabulated maximum rise time is the maximum rise time at both the secondary and the tertiary.

15:1:1 TURNS RATIO

Pulse Width Range in Microseconds		Source** Impedance (Ohms)	Load# Impedance (Ohms)	Maximum## Rise Time Microseconds	Aladdin Part Numbers Double End
Maximum*	Minimum				
0.4	to 0.22	2200	22	0.11	94-252
0.6	to 0.22	1600	15	0.11	94-252
0.7	to 0.26	3300	27	0.13	94-253
0.7	to 0.46	6800	56	0.23	94-254
0.8	to 0.24	1100	10	0.12	94-252
1.0	to 0.28	2200	22	0.14	94-253
1.3	to 0.34	3300	27	0.17	94-254
1.5	to 0.40	560	4.7	0.20	94-252
1.5	to 0.30	1600	15	0.15	94-253
1.8	to 0.38	2200	22	0.19	94-254
2.5	to 0.40	1100	10	0.20	94-253
3.0	to 0.56	9100	75	0.28	94-255
3.5	to 0.50	1100	10	0.25	94-254
3.5	to 0.52	5600	47	0.26	94-255
4.5	to 0.54	4700	39	0.27	94-255
8.0	to 0.6	2200	22	0.30	94-255

20:1:1 TURNS RATIO

Pulse Width Range in Microseconds		Source* Impedance (Ohms)	Load# Impedance (Ohms)	Maximum## Rise Time Microseconds	Aladdin Part Numbers Double End
Maximum*	Minimum				
0.40	to 0.28	3900	22	0.14	94-256
0.55	to 0.28	3300	15	0.14	94-256
0.80	to 0.36	4700	22	0.18	94-257
1.10	to 0.30	2000	10	0.15	94-256
1.50	to 0.40	3300	15	0.20	94-257
1.5	to 0.56	7500	39	0.26	94-258
2.2	to 0.40	1000	4.7	0.20	94-256
2.5	to 0.50	3900	22	0.25	94-258
2.5	to 0.42	2000	10	0.21	94-257
4.0	to 0.60	2000	10	0.30	94-258
8.0	to 1.30	1000	4.7	0.65	94-258

* For a 10% droop; transformer may be used for greater pulse widths if more droop can be tolerated.

** The generator impedance may be decreased 5%, and the load impedance increased 5%, without changing the specified performance characteristics.

The tabulated secondary impedance is the load across the secondary and the load across the tertiary.

The tabulated maximum rise time is the maximum rise time at both the secondary and the tertiary.

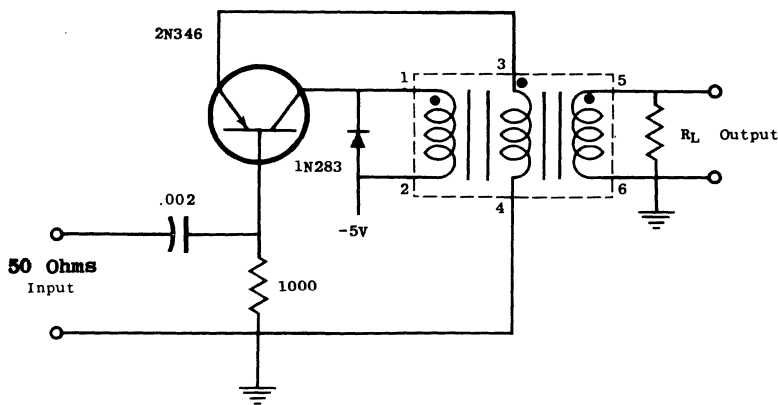
**TRIGGER CHARACTERISTICS:**

Pulse Width .05 Microseconds
 Rise Time .02 Microseconds
 Amplitude 2 Volts

Droop: 15% Maximum

Overshoot: 15% Maximum

Backswing: 30% Maximum

OUTPUT PULSE CHARACTERISTICS

Pulse Width ±50%	Rise Time Microseconds Maximum	Amplitude Volts ±10%	Load Impedance Ohms	Maximum Repetition Rate	Aladdin Part Numbers
0.2	0.025	6.5	1000	250KC	94-672
0.2	0.025	5.0	680	250KC	94-673
0.2	0.025	3.5	360	250KC	94-674
0.2	0.025	2.0	120	250KC	94-675
0.2	0.025	1.0	33	250KC	94-676
0.3	0.025	6.5	1000	150KC	94-677
0.3	0.025	5.0	680	150KC	94-678
0.3	0.025	3.5	360	150KC	94-679
0.3	0.025	2.0	120	150KC	94-680
0.3	0.025	1.0	33	150KC	94-681
0.4	0.025	6.5	1000	100KC	94-682
0.4	0.025	5.0	680	100KC	94-683
0.4	0.025	3.5	360	100KC	94-684
0.4	0.025	2.0	120	100KC	94-685
0.4	0.025	1.0	33	100KC	94-686
0.5	0.025	6.5	1000	70KC	94-687
0.5	0.025	5.0	680	70KC	94-688
0.5	0.025	3.5	360	70KC	94-689
0.5	0.025	2.0	120	70KC	94-690
0.5	0.025	1.0	33	70KC	94-691

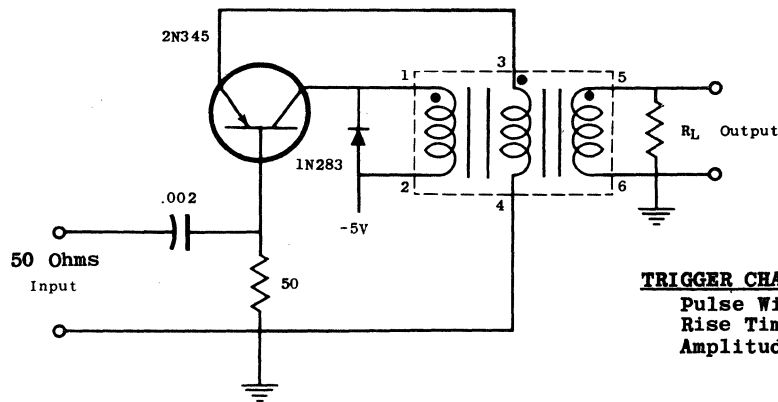

Drop: 20% Maximum
Overshoot: 15% Maximum
Backswing: 30% Maximum

TRIGGER CHARACTERISTICS:

Pulse Width .05 Microseconds
Rise Time .02 Microseconds
Amplitude 2 Volts

OUTPUT PULSE CHARACTERISTICS

Pulse Width ±50%	Rise Time Microseconds Maximum	Amplitude Volts ±10%	Load Impedance Ohms	Maximum Repetition Rate	Aladdin Part Numbers
1.0	0.04	6.5	1000	45KC	94-692
1.0	0.04	5.0	680	45KC	94-693
1.0	0.04	3.5	360	45KC	94-694
1.0	0.04	2.0	120	45KC	94-695
1.0	0.04	1.0	33	45KC	94-696
1.5	0.04	6.5	1000	30KC	94-697
1.5	0.04	5.0	680	30KC	94-698
1.5	0.04	3.5	360	30KC	94-699
1.5	0.04	2.0	120	30KC	94-700
1.5	0.04	1.0	33	30KC	94-701
2.0	0.04	6.5	1000	20KC	94-702
2.0	0.04	5.0	680	20KC	94-703
2.0	0.04	3.5	360	20KC	94-704
2.0	0.04	2.0	120	20KC	94-705
2.0	0.04	1.0	33	20KC	94-706
3.0	0.04	6.5	1000	15KC	94-707
3.0	0.04	5.0	680	15KC	94-708
3.0	0.04	3.5	360	15KC	94-709
3.0	0.04	2.0	120	15KC	94-710
3.0	0.04	1.0	33	15KC	94-711
4.0	0.05	6.5	1000	10KC	94-712
4.0	0.05	5.0	680	10KC	94-713
4.0	0.05	3.5	360	10KC	94-714
4.0	0.05	2.0	120	10KC	94-715
4.0	0.05	1.0	33	10KC	94-716
5.0	0.06	6.5	1000	9KC	94-717
5.0	0.06	5.0	680	9KC	94-718
5.0	0.06	3.5	360	9KC	94-719
5.0	0.06	2.0	120	9KC	94-720
5.0	0.06	1.0	33	9KC	94-721
6.0	0.07	6.5	1000	7KC	94-722
6.0	0.07	5.0	680	7KC	94-723
6.0	0.07	3.5	360	7KC	94-724
6.0	0.07	2.0	120	7KC	94-725
6.0	0.07	1.0	33	7KC	94-726
8.0	0.09	6.5	1000	5KC	94-727
8.0	0.09	5.0	680	5KC	94-728
8.0	0.09	3.5	360	5KC	94-729
8.0	0.09	2.0	120	5KC	94-730
8.0	0.09	1.0	33	5KC	94-731
10.0	0.09	6.5	1000	4KC	94-732
10.0	0.09	5.0	680	4KC	94-733
10.0	0.09	3.5	360	4KC	94-734
10.0	0.09	2.0	120	4KC	94-735
10.0	0.09	1.0	33	4KC	94-736

Micro-Miniature Section

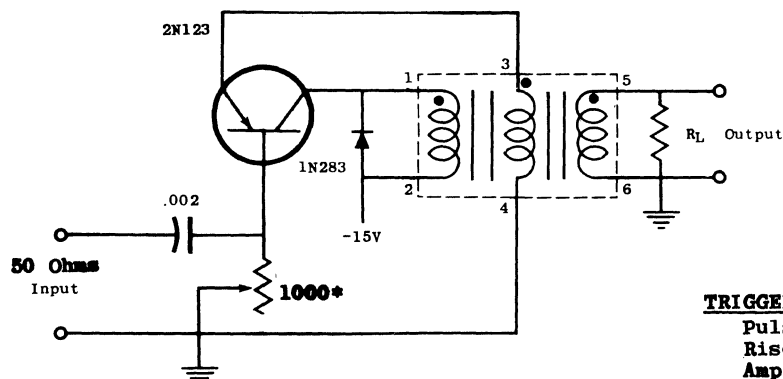

Droop: 18% Maximum
 Overshoot: 12% Maximum
 Backswing: 25% Maximum

TRIGGER CHARACTERISTICS:

Pulse Width .05 Microseconds
 Rise Time .02 Microseconds
 Amplitude 2 Volts

OUTPUT PULSE CHARACTERISTICS

Pulse Width ±20%	Rise Time Microseconds Maximum	Amplitude Volts ±10%	Load Impedance Ohms	Maximum Repetition Rate	Aladdin Part Numbers
0.5	0.10	18	2200	40KC	94-737
0.5	0.10	12	1000	40KC	94-738
0.5	0.10	8	470	40KC	94-739
0.5	0.10	5	180	40KC	94-740
0.5	0.10	2	33	40KC	94-741
1.0	0.10	18	2200	20KC	94-742
1.0	0.10	12	1000	20KC	94-743
1.0	0.10	8	470	20KC	94-744
1.0	0.10	5	180	20KC	94-745
1.0	0.10	2	33	20KC	94-746
1.5	0.10	18	2200	15KC	94-747
1.5	0.10	12	1000	15KC	94-748
1.5	0.10	8	470	15KC	94-749
1.5	0.10	5	180	15KC	94-750
1.5	0.10	2	33	15KC	94-751
2.0	0.10	18	2200	10KC	94-752
2.0	0.10	12	1000	10KC	94-753
2.0	0.10	8	470	10KC	94-754
2.0	0.10	5	180	10KC	94-755
2.0	0.10	2	33	10KC	94-756
3.0	0.12	18	2200	7KC	94-757
3.0	0.12	12	1000	7KC	94-758
3.0	0.12	8	470	7KC	94-759
3.0	0.12	5	180	7KC	94-760
3.0	0.12	2	33	7KC	94-761
4.0	0.12	18	2200	4KC	94-762
4.0	0.12	12	1000	4KC	94-763
4.0	0.12	8	470	4KC	94-764
4.0	0.12	5	180	4KC	94-765
4.0	0.12	2	33	4KC	94-766
5.0	0.12	18	2200	3KC	94-767
5.0	0.12	12	1000	3KC	94-768
5.0	0.12	8	470	3KC	94-769
5.0	0.12	5	180	3KC	94-770
5.0	0.12	2	33	3KC	94-771

* Nominally 470 Ohms