

# **PROTOCOLCOM P250**

# **INSTALLATION GUIDE**

**JANUARY 1986**

**AMNET**  
**HARDWARE LIBRARY**  
SIGN OUT AND RETURN

© COPYRIGHT 1986  
ProtoconDevices, Inc.  
190 WILLOW AVENUE  
BRONX, NEW YORK 10454  
PHONE: (212)-993-0077

## INTRODUCTION

The P250 is a high performance packet assembler/disassembler designed to enable data communication equipment functioning with synchronous protocols to interface with communications networks that utilize packet switching techniques and operate under the International X.25 Standard.

The P250 is available either as a stand alone unit or mounted in a card cage assembly. Each P250 is equipped with two synchronous ports, Channel A and Channel B. Channel A functions as the X.25 Network Port, while Channel B functions as a native port capable of supporting up to 32 synchronous devices.

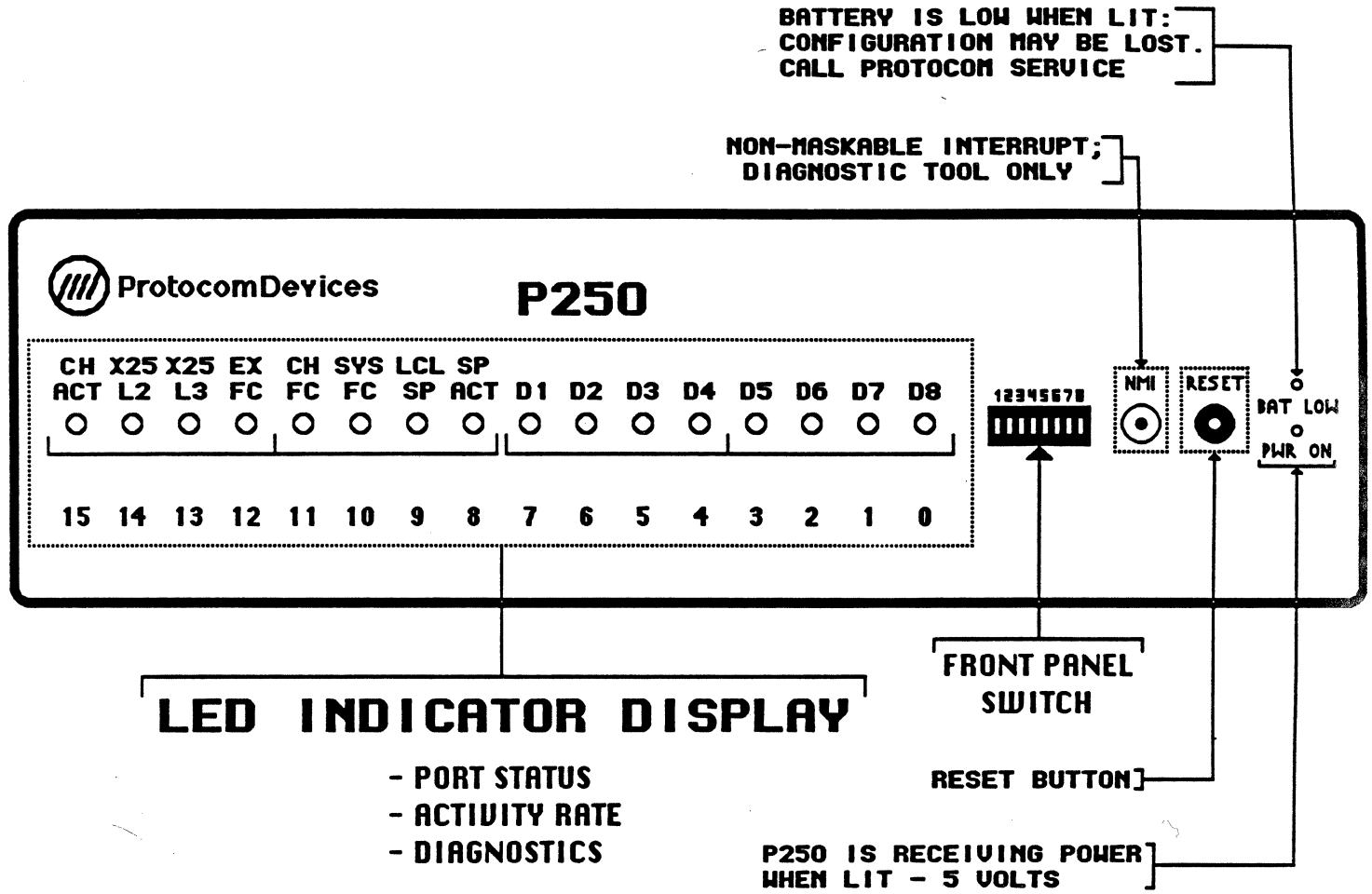
The P250 Installation Guide contains diagrams and instructions describing the physical specifications, installation guidelines, hardware configuration, and switch settings for both the stand alone unit and the card cage versions of the P250. Also included are diagrams illustrating possible network configurations involving the P250.

The P250 offers a wide range of configurable software parameters designed to optimize the unit's performance. For a detailed explanation of these parameters and examples of their form, syntax and implementation please refer to Chapter 5 'Extended Synchronous Parameters' of the P2500 Technical reference Manual.

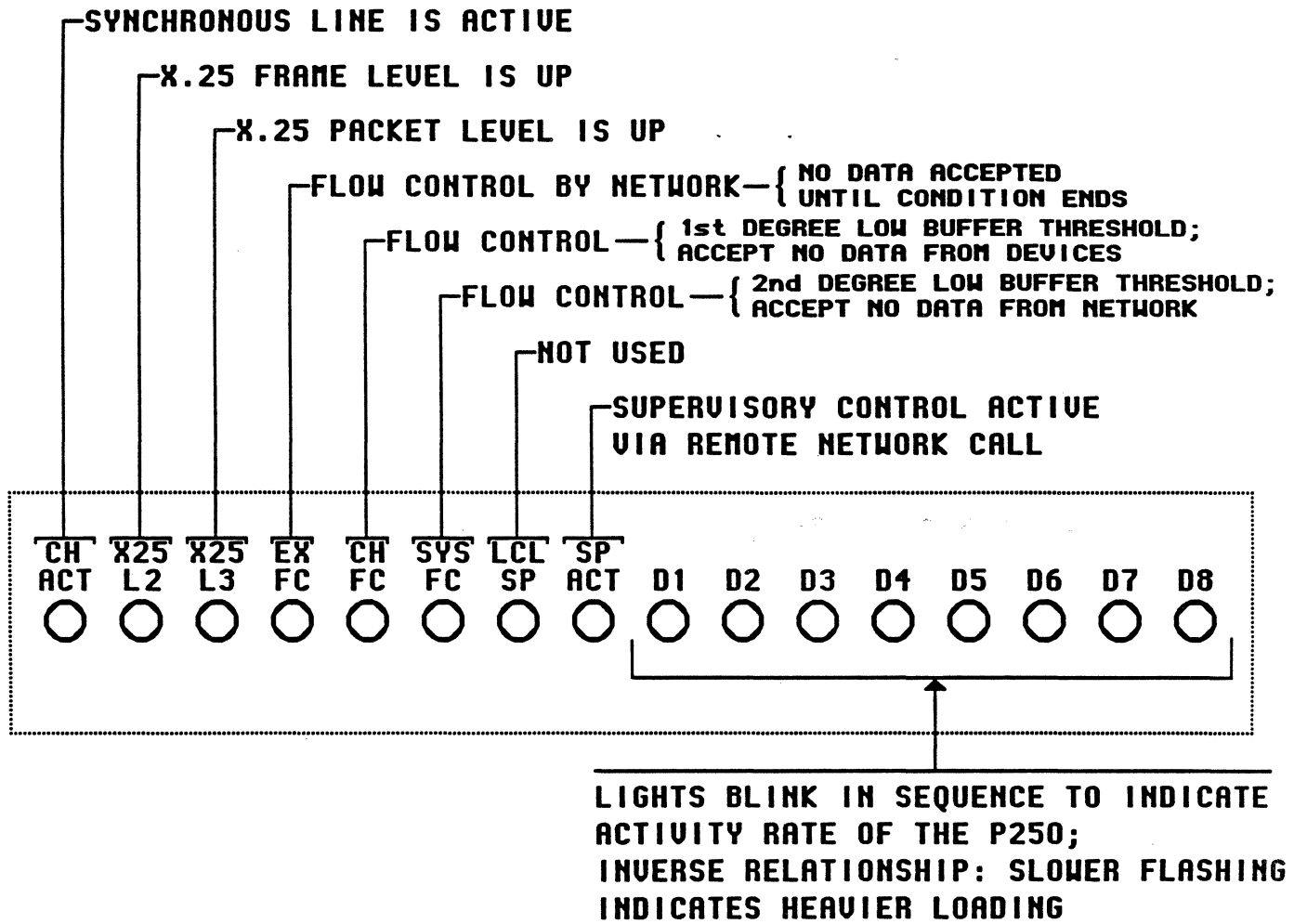
**WARNING**

This equipment generates, uses, and can radiate radio frequency energy and if not used in accordance with the instruction manual, may cause interference to radio communications. It has been tested and found to comply with the limits for a Class A computing device pursuant to Subpart J of Part 15 of FCC Rules, which are designed to provide reasonable protection against such interference when operated in a commercial environment. Operation of this equipment in a residential in a residential area is likely to cause interference in which case the user at his own expense will be required to take whatever measures may be required to correct the interference.

**FIGURE 1**  
**P250 STAND-ALONE UNIT**



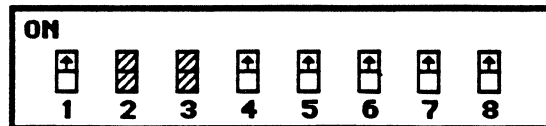
**FIGURE 2**  
**LED PANEL**  
**[STAND-ALONE UNIT]**



**FIGURE 3**  
**FRONT PANEL SWITCH**  
**[LOCATED ON FACE OF P250]**  
**[STAND-ALONE UNIT]**

**SWITCH SETTINGS ON**

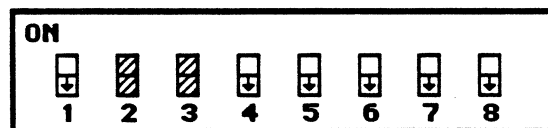
 = SWITCH ON



- <1> CCITT NETWORKS
- <2> UNUSED
- <3> UNUSED
- <4> RETAIN CONFIGURATION
- <5> TPAD
- <6> HALF-DUPLEX
- <7> CHANNEL B - NATIVE SYNC PORT - DCE
- <8> CHANNEL A - X.25 PORT - DCE

**SWITCH SETTINGS OFF**

 = SWITCH OFF

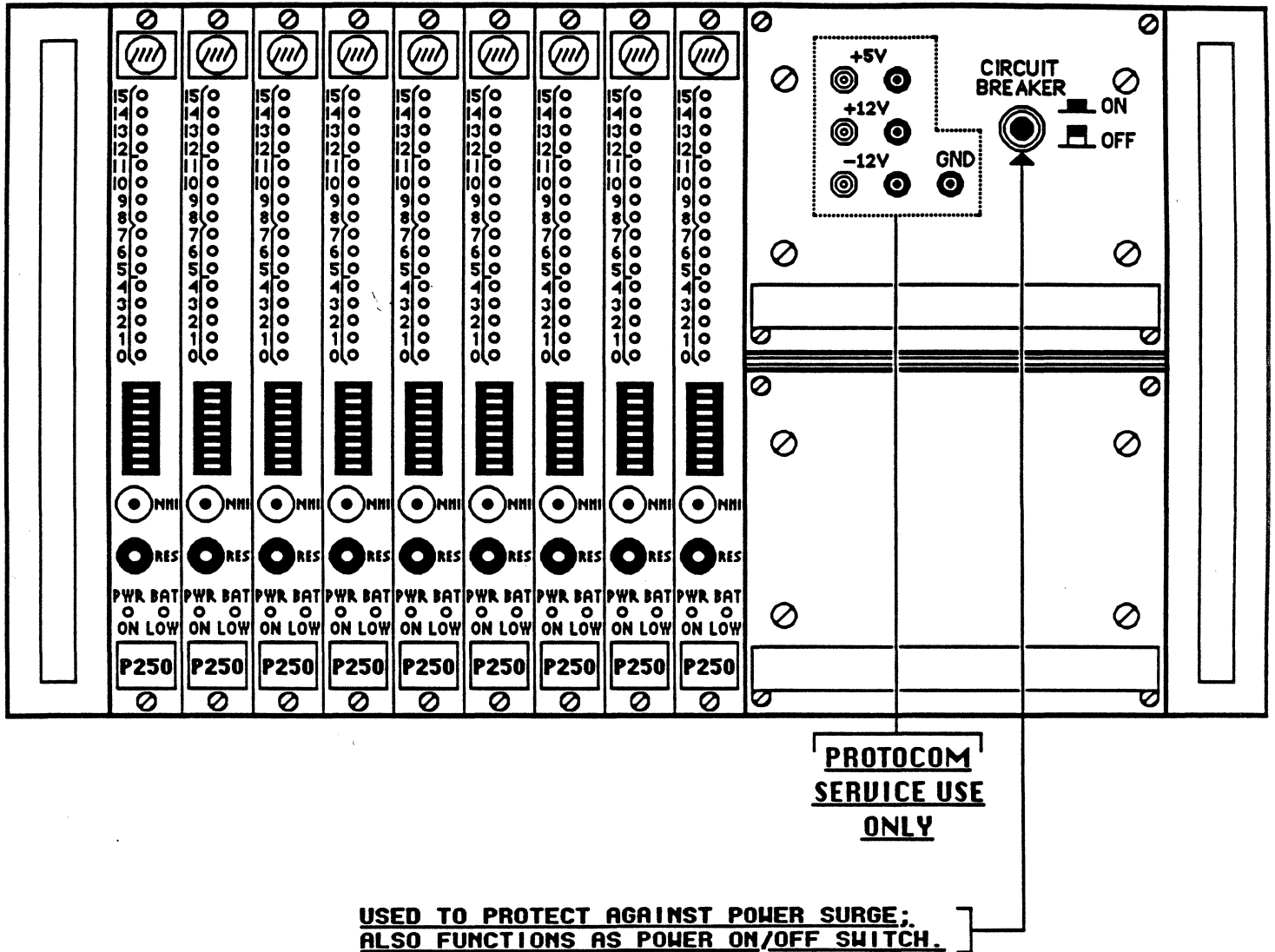


- <1> TELENET
- <2> UNUSED
- <3> UNUSED
- <4> COPY CONFIGURATION DEFAULTS
- <5> HPAD
- <6> FULL DUPLEX
- <7> CHANNEL B - NATIVE SYNC PORT - DTE
- <8> CHANNEL A - X.25 PORT - DTE

**NOTE :**

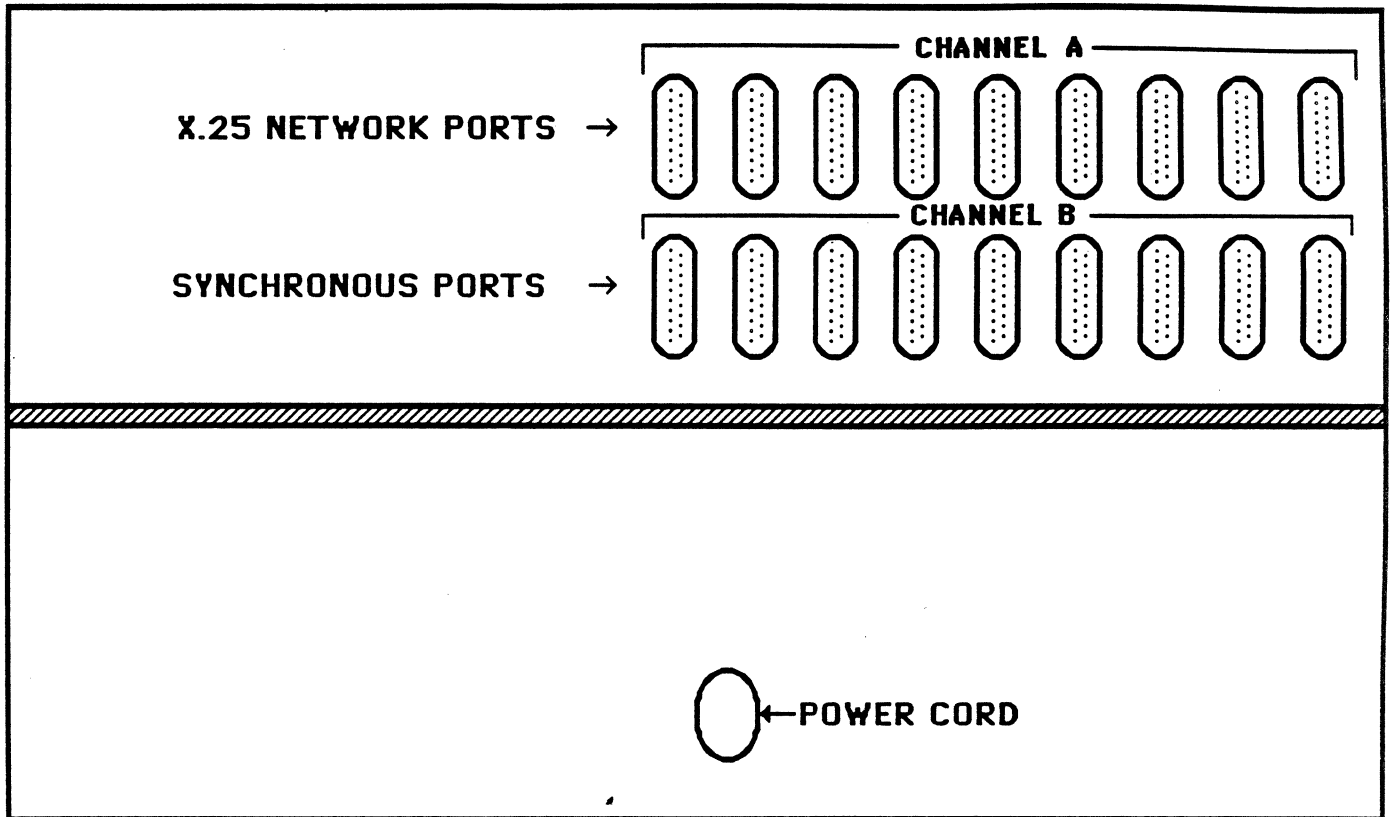
**RESET BUTTON MUST BE PRESSED  
FOR ALL ACTIONS TO TAKE PLACE!**

**FIGURE 4**  
**CARD CAGE MODEL**



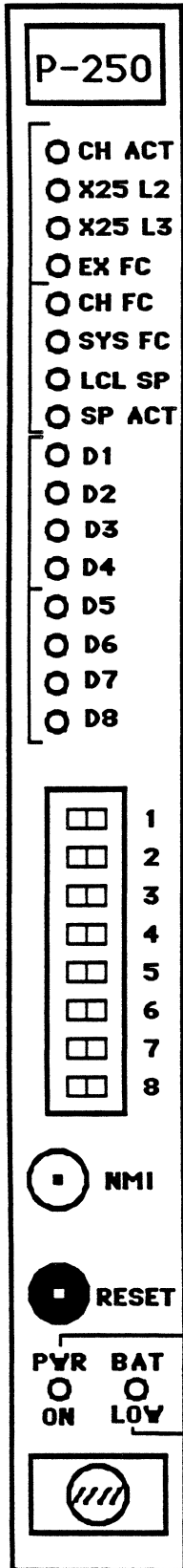
**FIGURE 5**

**BACK OF CARD CAGE**





**FIGURE 6**  
**P250 FRONT PANEL**  
**[CARD CAGE MODEL]**



**TOP CARD EJECTOR - CLIPS IN PLACE AUTOMATICALLY ON INSTALLATION  
TO EJECT CARD - PUSH UP AND PULL (PUSH DOWN AND PULL BOTTOM  
EJECTOR AT SAME TIME)**

**LED INDICATOR DISPLAY**

- PORT STATUS
  - ACTIVITY RATE
  - DIAGNOSTICS
- [SEE FIGURE 2]

**FRONT PANEL SWITCH**  
[SEE FIGURE 3]

**NON-MASKABLE INTERRUPT - DIAGNOSTIC TOOL ONLY**

**RESET BUTTON**

**P250 IS RECEIVING POWER WHEN LIT - 5 VOLTS**

**BATTERY IS LOW WHEN LIT: CONFIGURATION MAY BE LOST. CALL PROTOCOM SERVICE.**

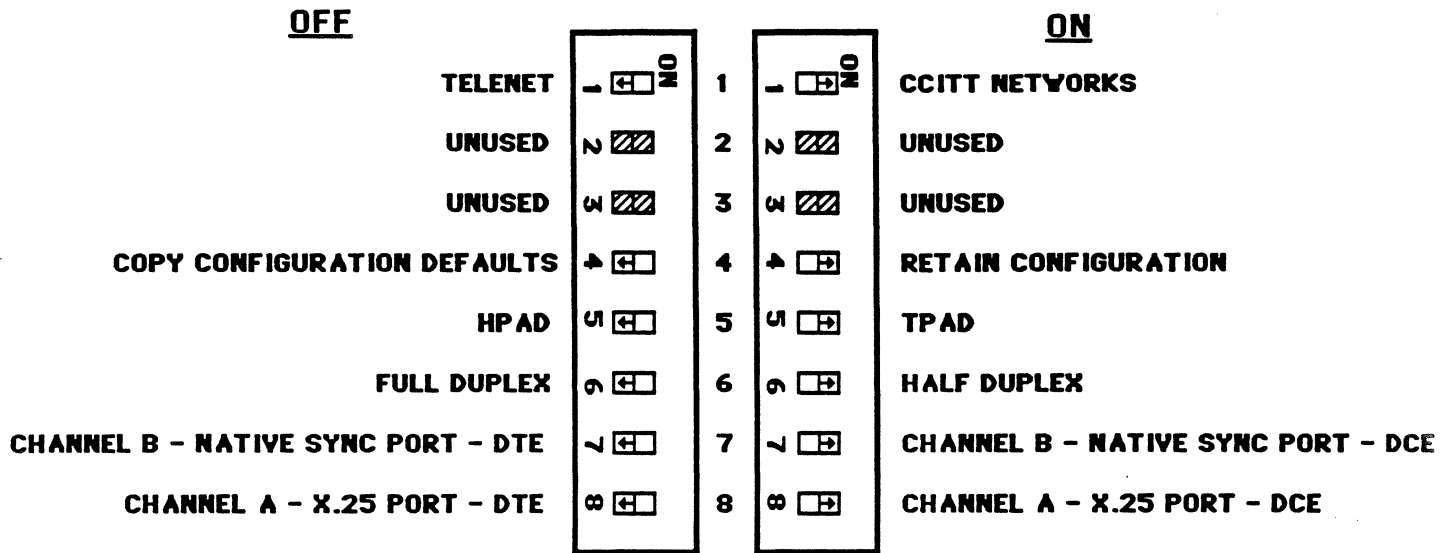
**BOTTOM CARD EJECTOR - CLIPS IN PLACE AUTOMATICALLY ON INSTALLATION.  
TO EJECT CARD - PUSH DOWN AND PULL (PUSH UP AND PULL TOP  
EJECTOR AT SAME TIME)**



**FIGURE 8**  
**FRONT PANEL SWITCH**  
 [LOCATED ON FACE OF P.C. BOARD]  
[CARD CAGE MODEL]

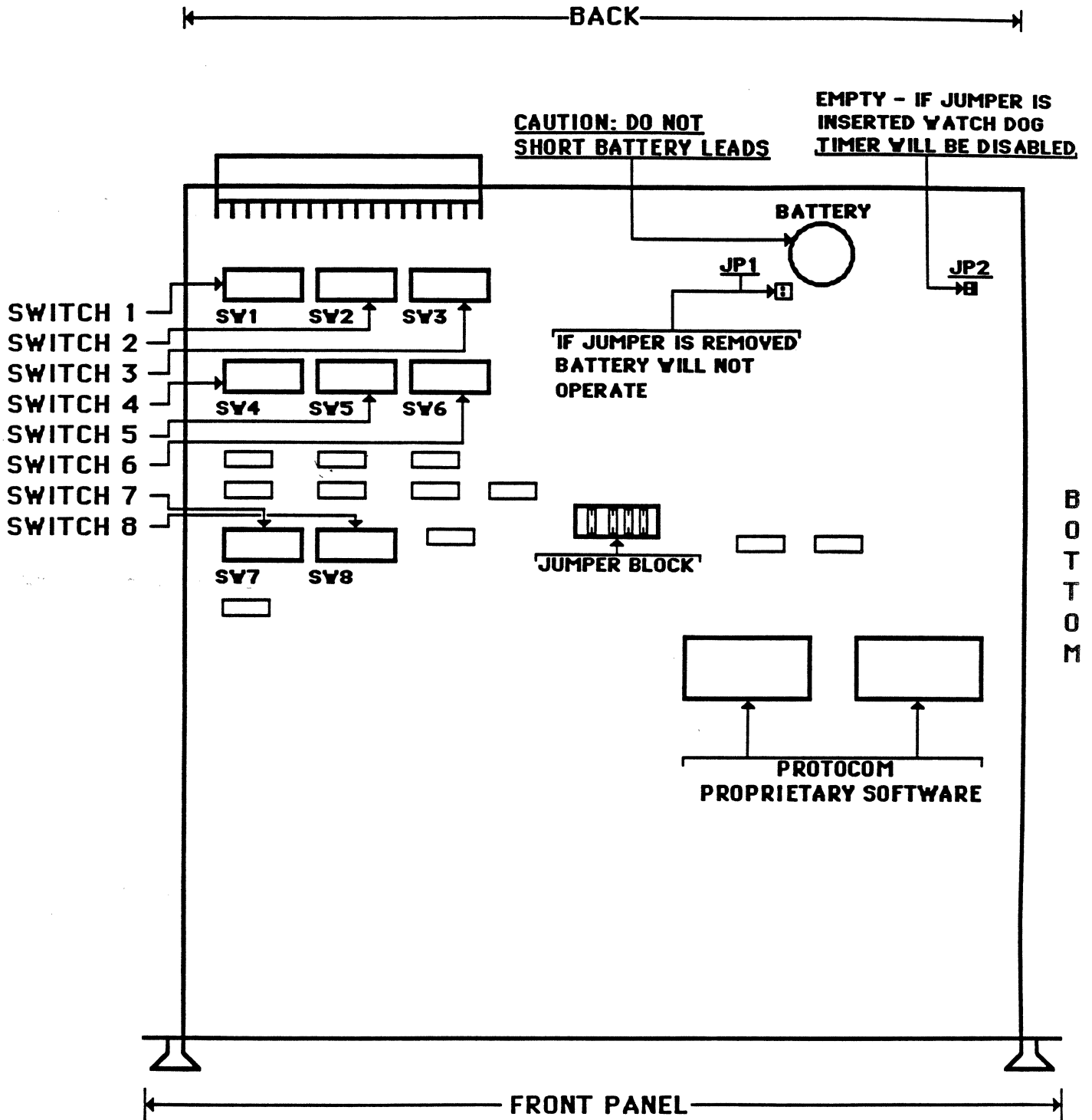
 = SWITCH OFF

 = SWITCH ON



**NOTE :**  
 RESET BUTTON MUST BE PRESSED  
 FOR ALL ACTIONS TO TAKE PLACE!

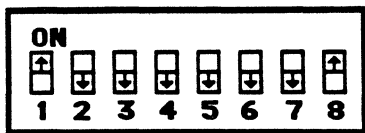
**FIGURE 9**  
**P250 PC BOARD**



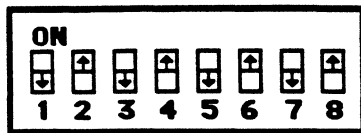
**FIGURE 10**

**SWITCH DESIGNATIONS - SWITCHES 1-8**

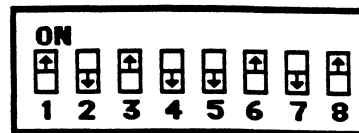
**CHANNEL A - X.25 PORT DCE**



**SWITCH 1-HEX 81**



**SWITCH 2-HEX 55**



**SWITCH 3-HEX A5**



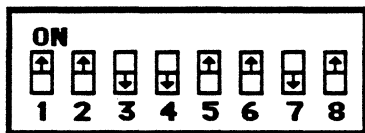
**SWITCH 4**



**SWITCH 5**



**SWITCH 6**



**SWITCH 7-HEX CD**

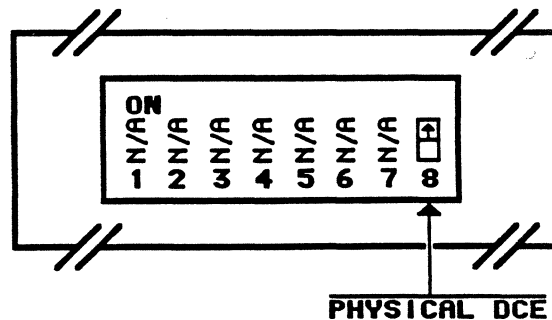


**SWITCH 8**

= SWITCH ON  
 = SWITCH OFF

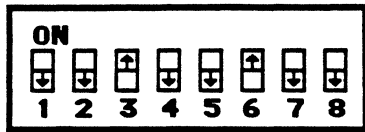
**N/A = NOT APPLICABLE**

**FRONT PANEL SWITCH**

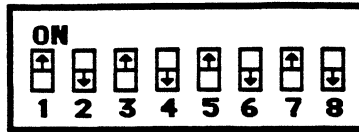


**FIGURE 11**  
**SWITCH DESIGNATIONS - SWITCHES 1-8**

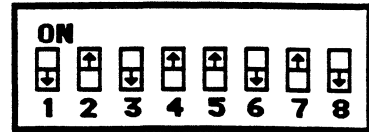
**CHANNEL A - X.25 PORT DTE**



**SWITCH 1-HEX 24**



**SWITCH 2-HEX AA**



**SWITCH 3-HEX 5A**



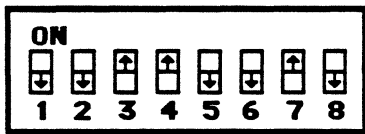
**SWITCH 4**



**SWITCH 5**



**SWITCH 6**



**SWITCH 7-HEX 32**

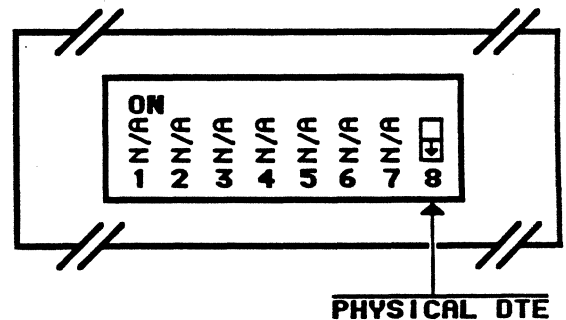


**SWITCH 8**

 = SWITCH ON  
 = SWITCH OFF

**N/A = NOT APPLICABLE**

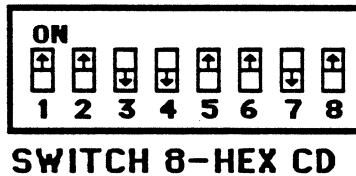
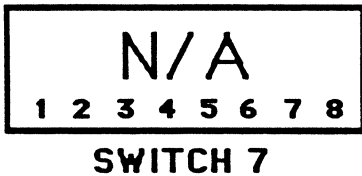
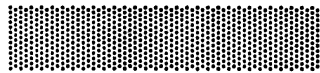
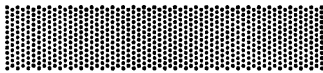
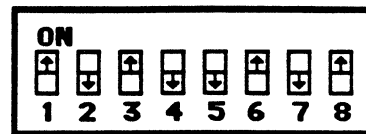
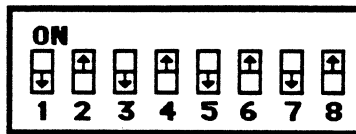
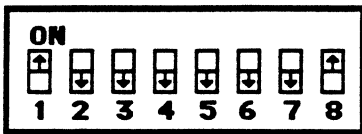
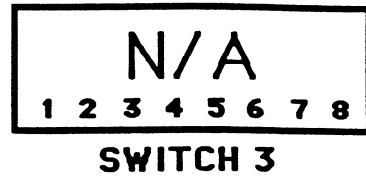
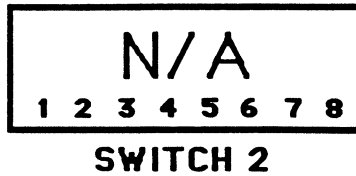
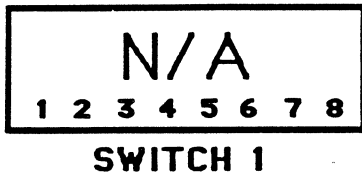
**FRONT PANEL SWITCH**



**FIGURE 12**

**SWITCH DESIGNATIONS - SWITCHES 1-8**

**CHANNEL B - NATIVE SYNCHRONOUS PORT - DCE**

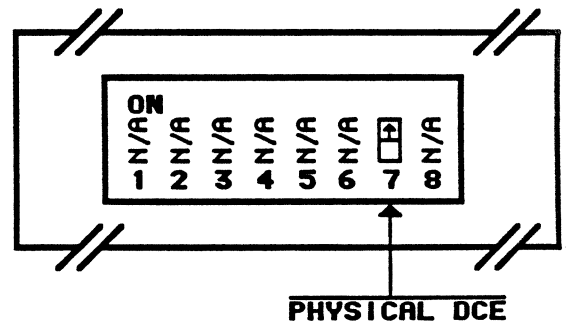


= SWITCH ON

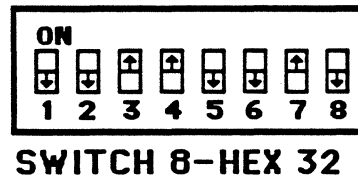
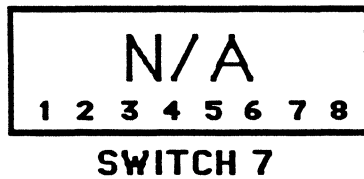
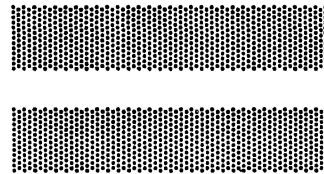
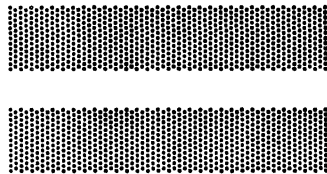
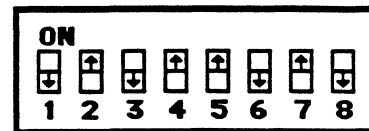
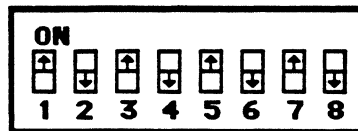
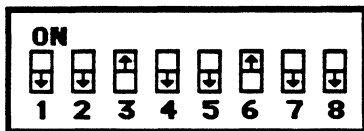
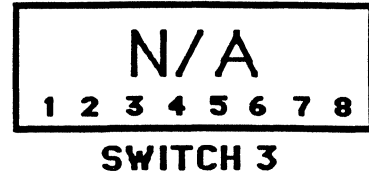
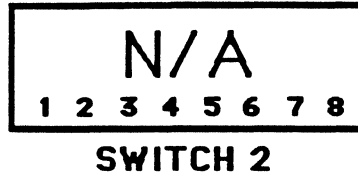
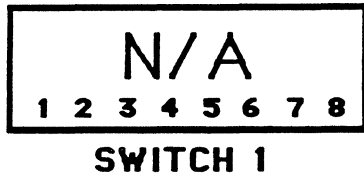
= SWITCH OFF

**N/A = NOT APPLICABLE**

**FRONT PANEL SWITCH**



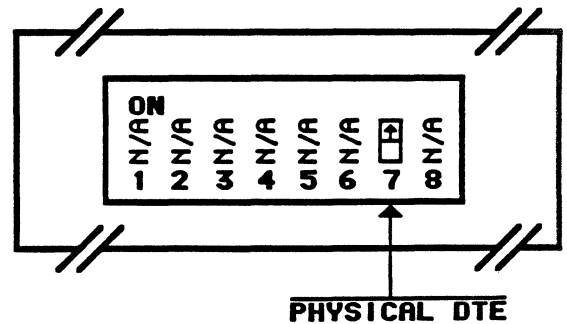
**FIGURE 13**  
**SWITCH DESIGNATIONS - SWITCHES 1-8**  
**CHANNEL B - NATIVE SYNCHRONOUS PORT - DTE**



 = SWITCH ON  
 = SWITCH OFF

**N/A = NOT APPLICABLE**

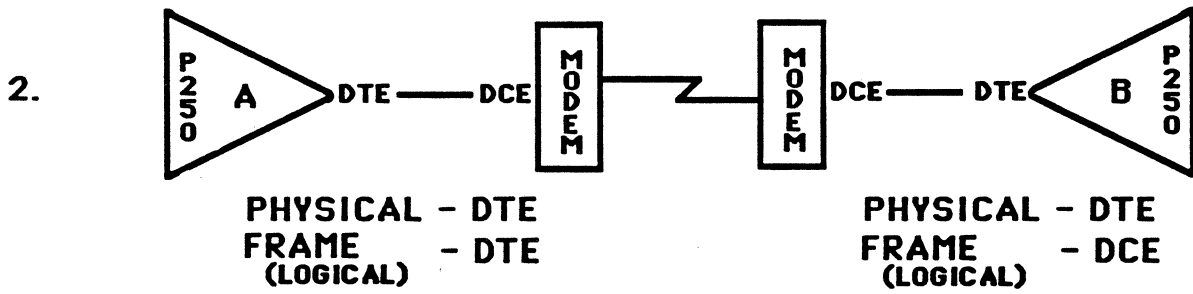
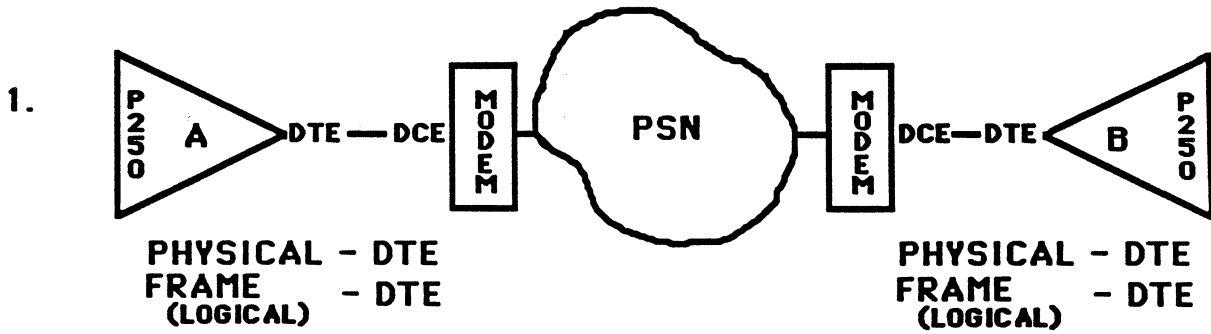
**FRONT PANEL SWITCH**



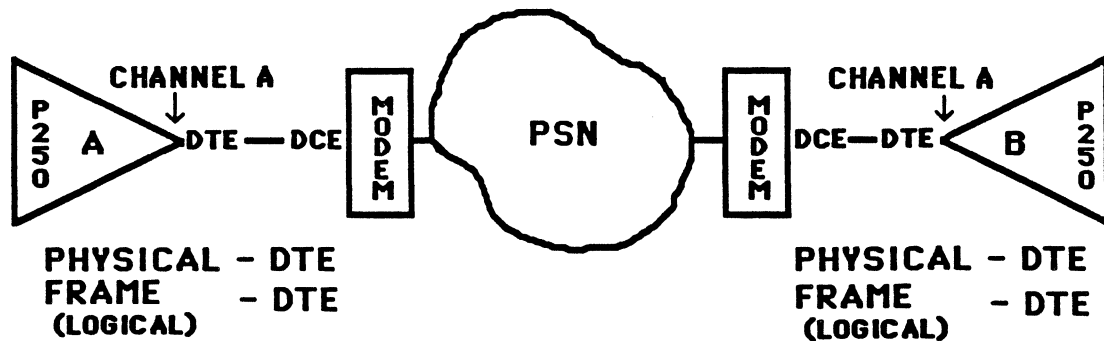


**FIGURE 14**

**P250 ↔ NETWORK CONFIGURATIONS**

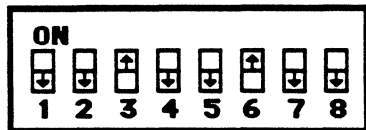


P250(A) ↔ X.25 NETWORK ↔ P250(B)

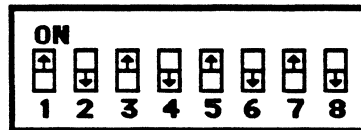


= SWITCH ON  
 = SWITCH OFF

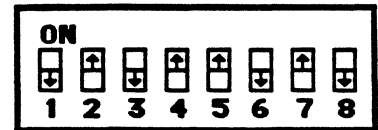
CHANNEL A SWITCHES  
 PHYSICAL DTE



SWITCH 1 - HEX 24



SWITCH 2 - HEX AA



SWITCH 3 - HEX 5A



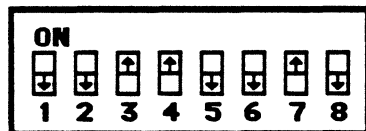
SWITCH 4



SWITCH 5



SWITCH 6

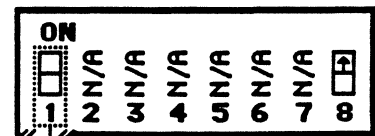


SWITCH 7 - HEX 32



SWITCH 8

FRONT PANEL SWITCH



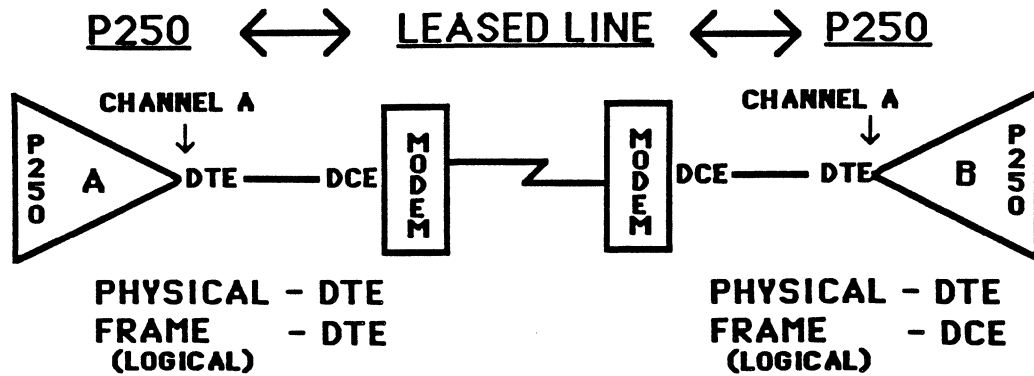
PHYSICAL DCE

= CCITT  
 = TELENET

CABLE - STRAIGHT THROUGH

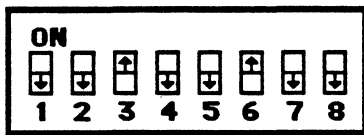
PARAMETERS

FRAME LEVEL: LOGICAL DTE  
 (DEFAULT SETTING)

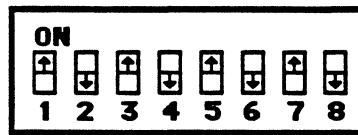


**CHANNEL A  
SWITCHES  
PHYSICAL DTE**

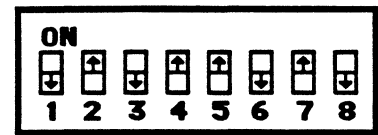
= SWITCH ON  
 = SWITCH OFF



SWITCH 1 - HEX 24



SWITCH 2 - HEX AA



SWITCH 3 - HEX 5A



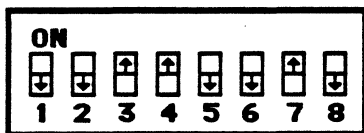
SWITCH 4



SWITCH 5



SWITCH 6

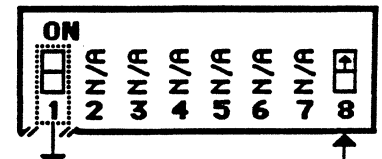


SWITCH 7 - HEX 32



SWITCH 8

**FRONT PANEL SWITCH**



= CCITT  
 = TELENET

↑ PHYSICAL DTE

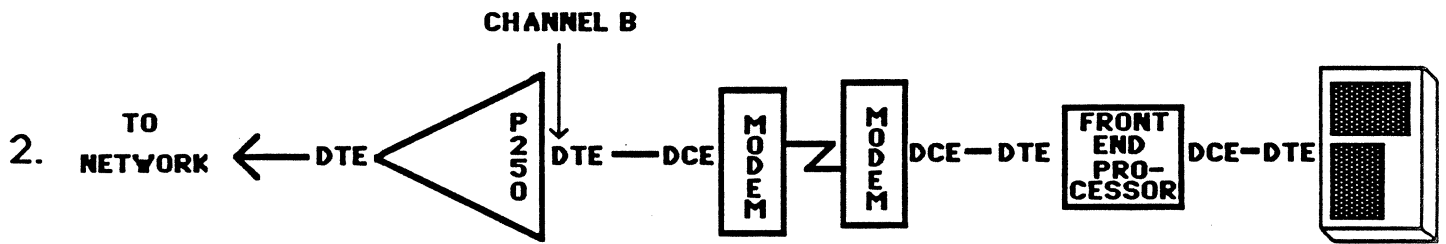
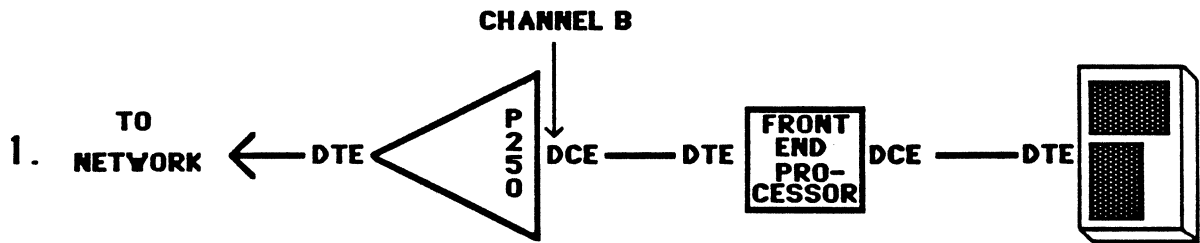
**CABLE - STRAIGHT THROUGH**

**PARAMETERS**

**FRAME LEVEL:** P250 [A] - LOGICAL DTE  
(DEFAULT SETTING)  
P250 [B] - LOGICAL DCE

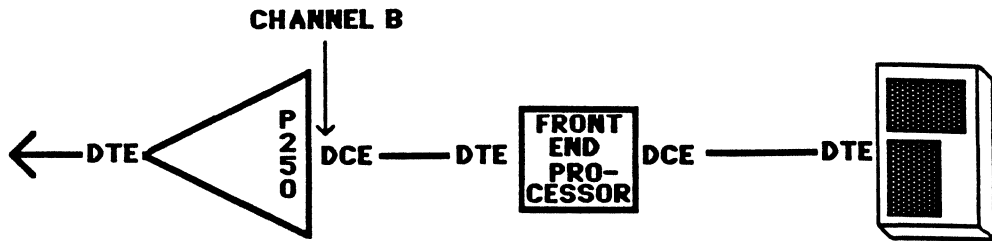
FIGURE 17

P250 HOST PAD CONFIGURATIONS



**FIGURE 18**

P250 (HPAD) ↔ SYNCHRONOUS HOST



**CHANNEL B  
SWITCHES  
PHYSICAL DCE**

= SWITCH ON  
 = SWITCH OFF



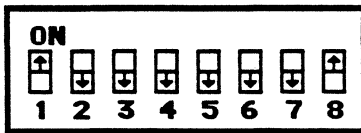
**SWITCH 1**



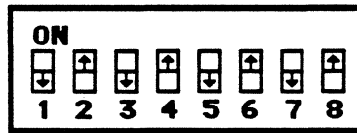
**SWITCH 2**



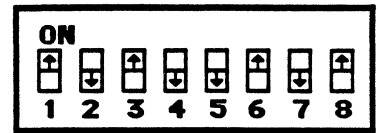
**SWITCH 3**



**SWITCH 4-HEX 81**



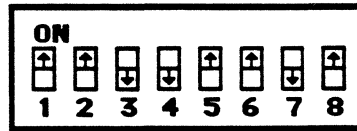
**SWITCH 5-HEX 55**



**SWITCH 6-HEX A5**

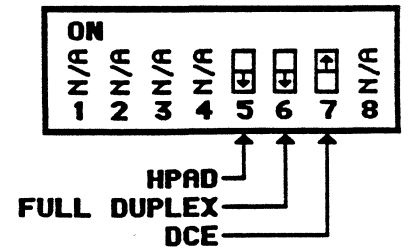


**SWITCH 7**



**SWITCH 8-HEX CD**

**FRONT PANEL SWITCH**

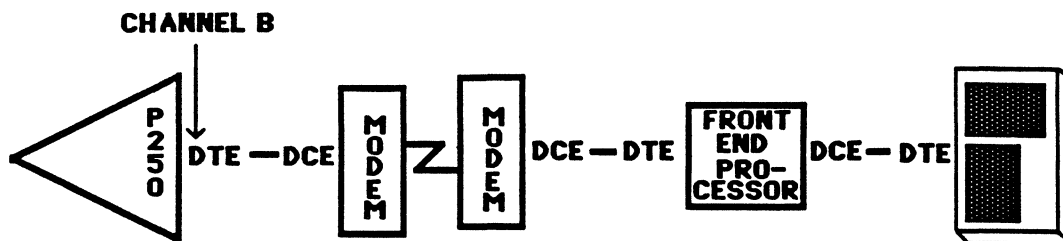


CABLE - STRAIGHT THROUGH

PARAMETERS - N/A

**FIGURE 19**

P250(HPAD) ↔ MODEM



**CHANNEL B  
SWITCHES  
PHYSICAL DTE**

= SWITCH ON  
 = SWITCH OFF



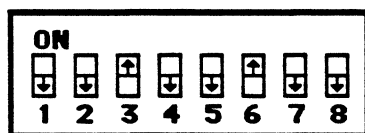
**SWITCH 1**



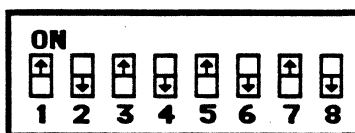
**SWITCH 2**



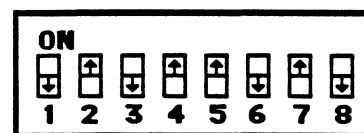
**SWITCH 3**



**SWITCH 4 - HEX 24**



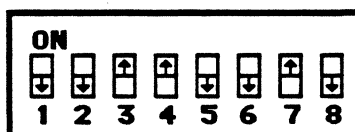
**SWITCH 5 - HEX AA**



**SWITCH 6 - HEX 5A**



**SWITCH 7**



**SWITCH 8 - HEX 32**

CABLE -STRAIGHT THROUGH

PARAMETERS -N/A

**FRONT PANEL SWITCH**

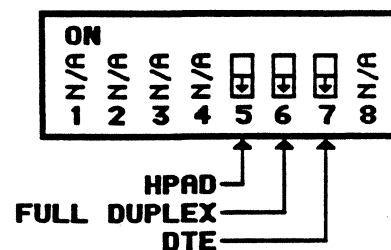
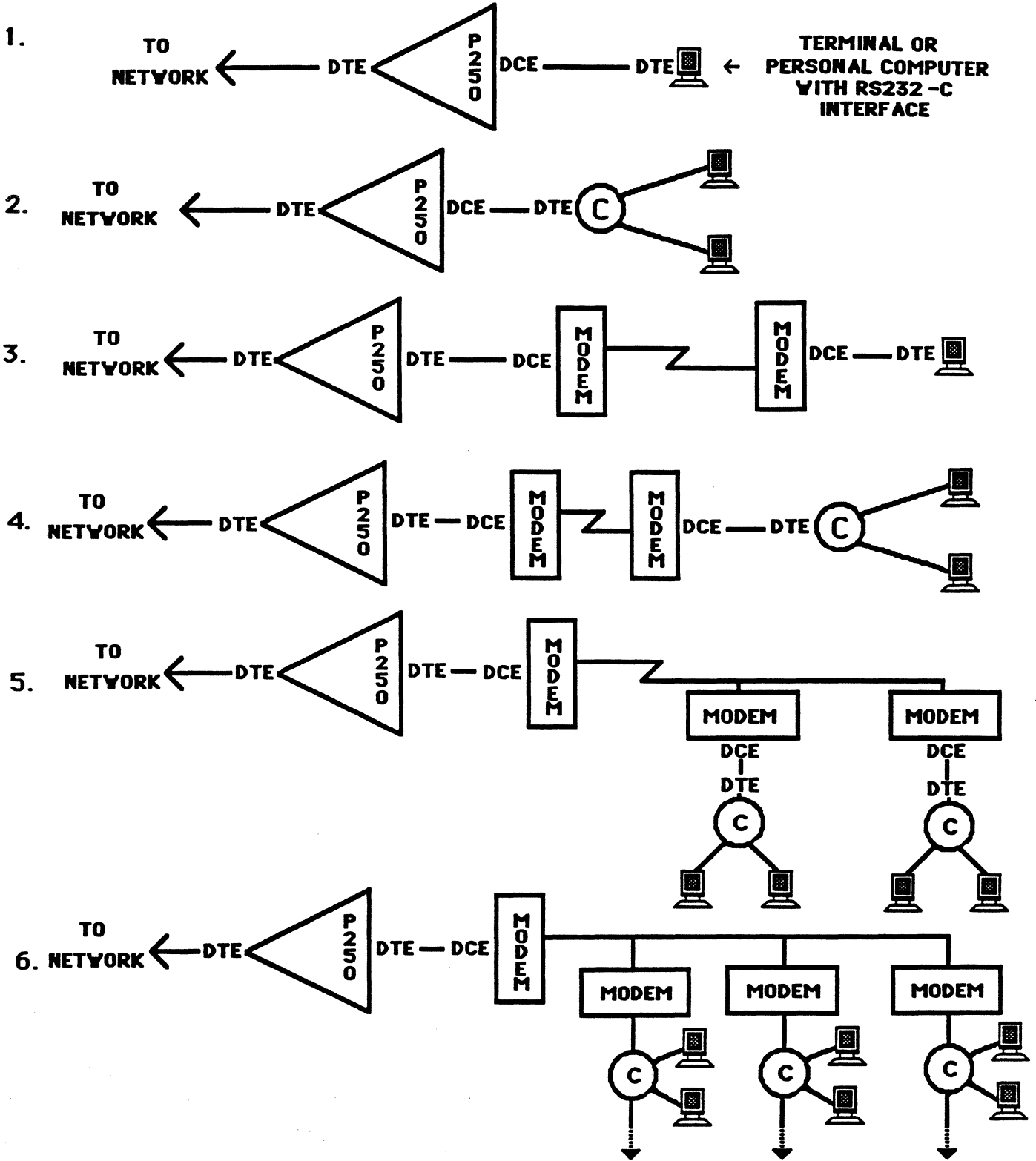
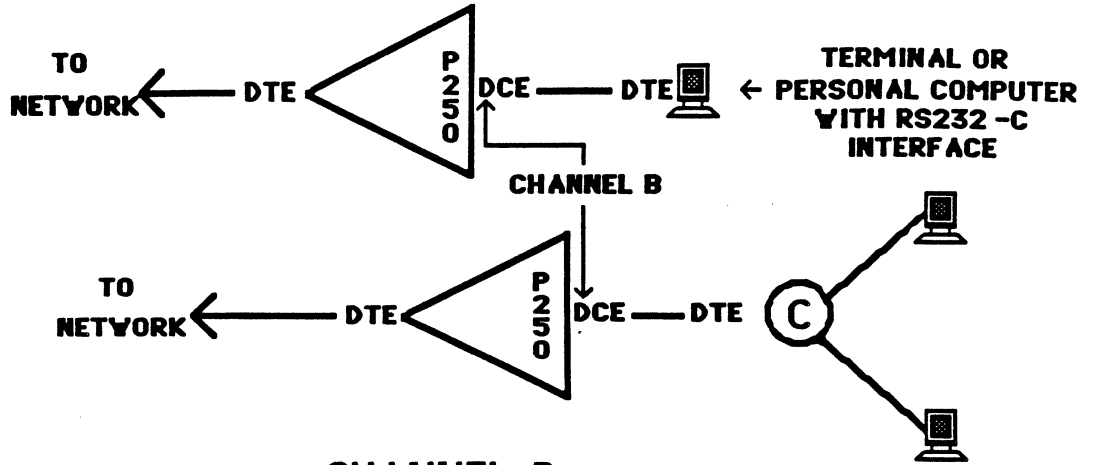


FIGURE 20

**P250 ↔ SYNCHRONOUS DEVICES**



P250 (TPAD) ↔ TERMINAL or CONTROLLER



**CHANNEL B  
SWITCHES  
PHYSICAL DCE**

= SWITCH ON

= SWITCH OFF



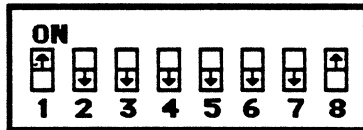
SWITCH 1



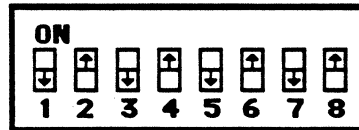
SWITCH 2



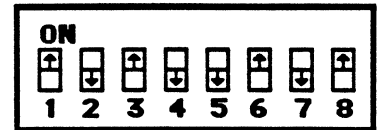
SWITCH 3



SWITCH 4 - HEX 81



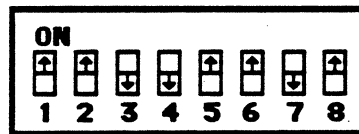
SWITCH 5 - HEX 55



SWITCH 6 - HEX A5

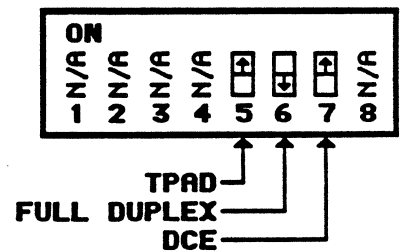


SWITCH 7



SWITCH 8 - HEX CD

FRONT PANEL SWITCH

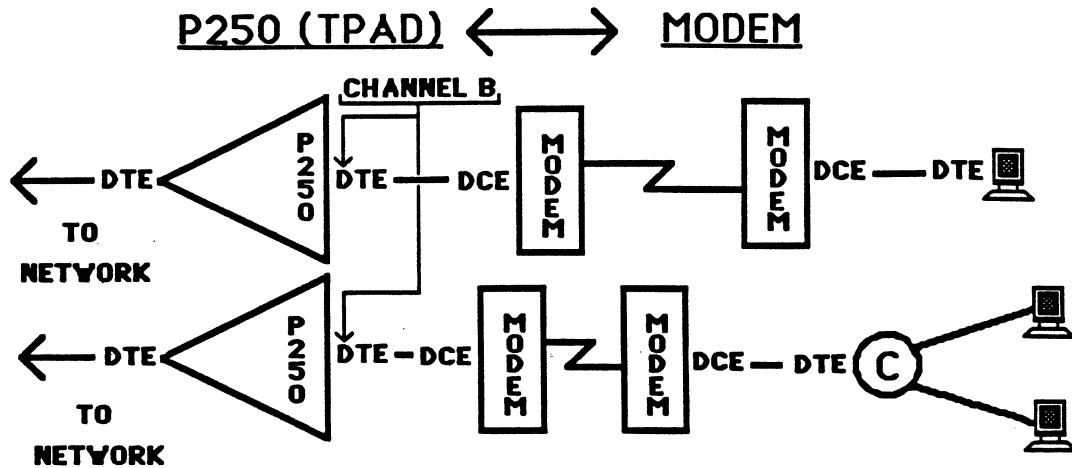


CABLE -STRAIGHT THROUGH

PARAMETERS -N/A



FIGURE 22



CHANNEL B SWITCHES  
PHYSICAL DTE

= SWITCH ON  
 = SWITCH OFF



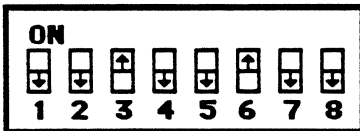
SWITCH 1



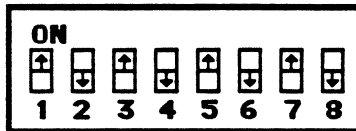
SWITCH 2



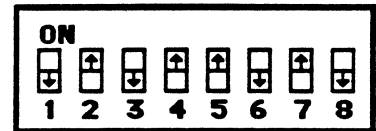
SWITCH 3



SWITCH 4-HEX 24



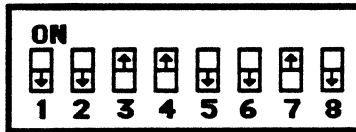
SWITCH 5-HEX AA



SWITCH 6-HEX 5A



SWITCH 7

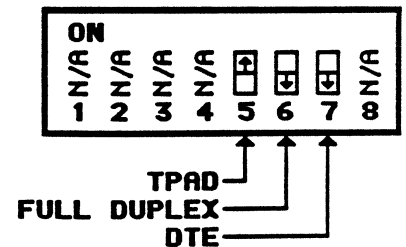


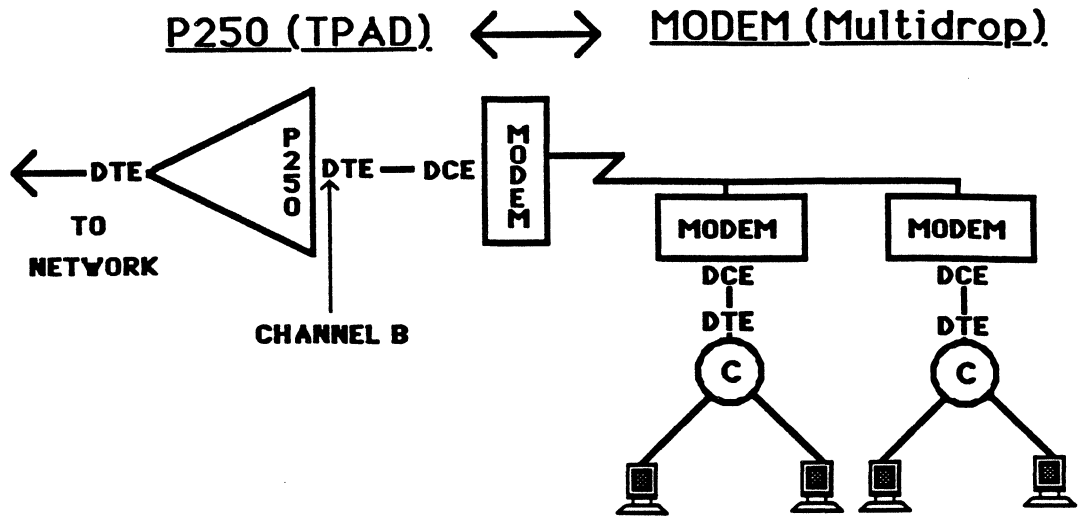
SWITCH 8-HEX 32

CABLE -STRAIGHT THROUGH

PARAMETERS -N/A

FRONT PANEL SWITCH





**CHANNEL B  
SWITCHES  
PHYSICAL DCE**

= SWITCH ON  
 = SWITCH OFF



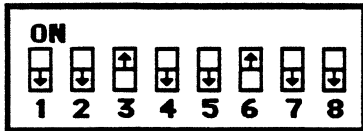
**SWITCH 1**



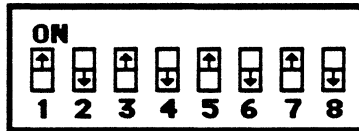
**SWITCH 2**



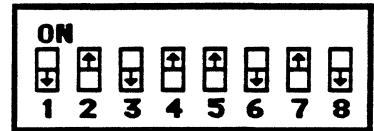
**SWITCH 3**



**SWITCH 4-HEX 24**



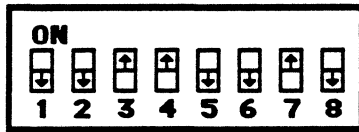
**SWITCH 5-HEX AA**



**SWITCH 6-HEX 5A**

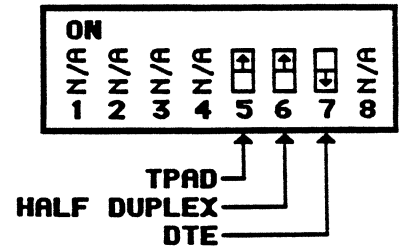


**SWITCH 7**



**SWITCH 8-HEX 32**

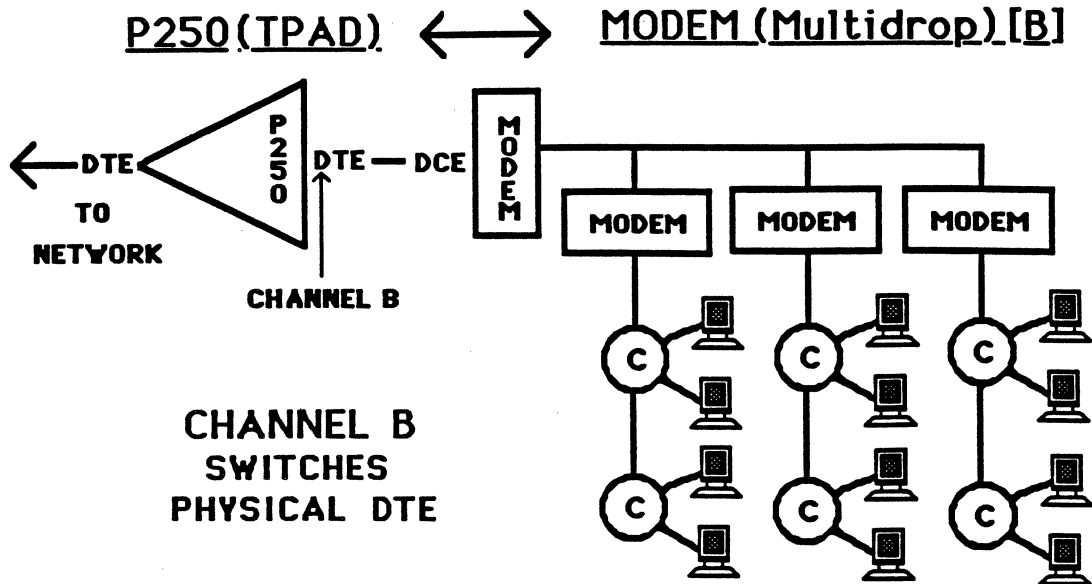
**FRONT PANEL SWITCH**



**CABLE -STRAIGHT THROUGH**

**PARAMETERS -N/A**

**FIGURE 24**



= SWITCH ON

= SWITCH OFF



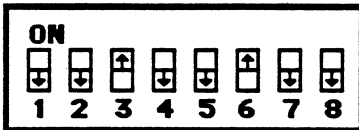
SWITCH 1



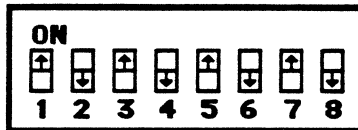
SWITCH 2



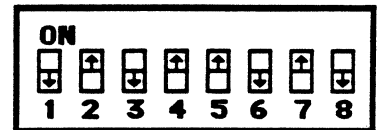
SWITCH 3



SWITCH 4 - HEX 24



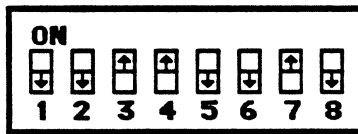
SWITCH 5 - HEX AA



SWITCH 6 - HEX 5A



SWITCH 7



SWITCH 8 - HEX 32

CABLE - STRAIGHT THROUGH

PARAMETERS - N/A

**FRONT PANEL SWITCH**

