

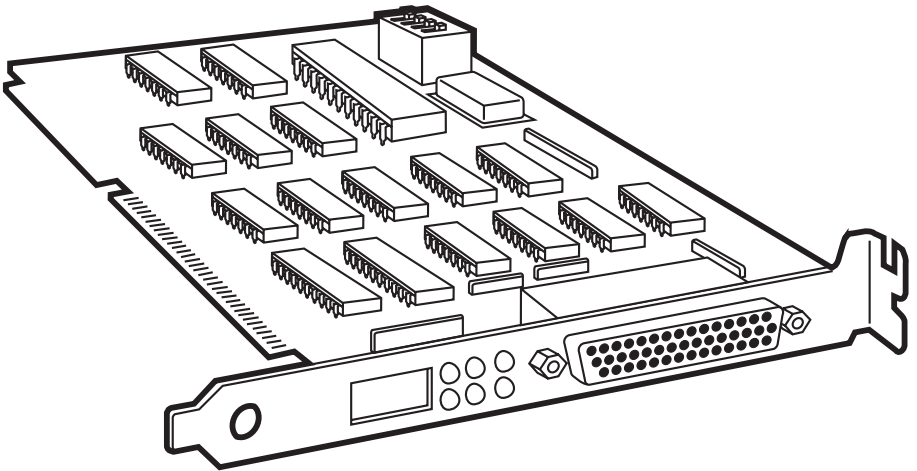

5250 Remote Emulator Card



**CUSTOMER
SUPPORT
INFORMATION**

Order toll-free in the U.S.: Call **877-877-BBOX** (outside U.S. call **724-746-5500**)
FREE technical support 24 hours a day, 7 days a week: Call **724-746-5500** or fax **724-746-0746**
Mailing address: **Black Box Corporation**, 1000 Park Drive, Lawrence, PA 15055-1018
Web site: www.blackbox.com • E-mail: info@blackbox.com

**FEDERAL COMMUNICATIONS COMMISSION
AND
INDUSTRY CANADA
RADIO FREQUENCY INTERFERENCE STATEMENTS**

This equipment generates, uses, and can radiate radio frequency energy and if not installed and used properly, that is, in strict accordance with the manufacturer's instructions, may cause interference to radio communication. It has been tested and found to comply with the limits for a Class A computing device in accordance with the specifications in Subpart J of Part 15 of FCC rules, which are designed to provide reasonable protection against such interference when the equipment is operated in a commercial environment. Operation of this equipment in a residential area is likely to cause interference, in which case the user at his own expense will be required to take whatever measures may be necessary to correct the interference.

Changes or modifications not expressly approved by the party responsible for compliance could void the user's authority to operate the equipment.

This digital apparatus does not exceed the Class A limits for radio noise emission from digital apparatus set out in the Radio Interference Regulation of Industry Canada.

Le présent appareil numérique n'émet pas de bruits radioélectriques dépassant les limites applicables aux appareils numériques de la classe A prescrites dans le Règlement sur le brouillage radioélectrique publié par Industrie Canada.

**NORMAS OFICIALES MEXICANAS (NOM)
ELECTRICAL SAFETY STATEMENT****INSTRUCCIONES DE SEGURIDAD**

1. Todas las instrucciones de seguridad y operación deberán ser leídas antes de que el aparato eléctrico sea operado.
2. Las instrucciones de seguridad y operación deberán ser guardadas para referencia futura.
3. Todas las advertencias en el aparato eléctrico y en sus instrucciones de operación deben ser respetadas.
4. Todas las instrucciones de operación y uso deben ser seguidas.
5. El aparato eléctrico no deberá ser usado cerca del agua—por ejemplo, cerca de la tina de baño, lavabo, sótano mojado o cerca de una alberca, etc..
6. El aparato eléctrico debe ser usado únicamente con carritos o pedestales que sean recomendados por el fabricante.
7. El aparato eléctrico debe ser montado a la pared o al techo sólo como sea recomendado por el fabricante.
8. Servicio—El usuario no debe intentar dar servicio al equipo eléctrico más allá a lo descrito en las instrucciones de operación. Todo otro servicio deberá ser referido a personal de servicio calificado.
9. El aparato eléctrico debe ser situado de tal manera que su posición no interfiera su uso. La colocación del aparato eléctrico sobre una cama, sofá, alfombra o superficie similar puede bloquea la ventilación, no se debe colocar en libreros o gabinetes que impidan el flujo de aire por los orificios de ventilación.
10. El equipo eléctrico deber ser situado fuera del alcance de fuentes de calor como radiadores, registros de calor, estufas u otros aparatos (incluyendo amplificadores) que producen calor.
11. El aparato eléctrico deberá ser conectado a una fuente de poder sólo del tipo descrito en el instructivo de operación, o como se indique en el aparato.

12. Precaución debe ser tomada de tal manera que la tierra física y la polarización del equipo no sea eliminada.
13. Los cables de la fuente de poder deben ser guiados de tal manera que no sean pisados ni pellizcados por objetos colocados sobre o contra ellos, poniendo particular atención a los contactos y receptáculos donde salen del aparato.
14. El equipo eléctrico debe ser limpiado únicamente de acuerdo a las recomendaciones del fabricante.
15. En caso de existir, una antena externa deberá ser localizada lejos de las líneas de energía.
16. El cable de corriente deberá ser desconectado del cuando el equipo no sea usado por un largo periodo de tiempo.
17. Cuidado debe ser tomado de tal manera que objetos líquidos no sean derramados sobre la cubierta u orificios de ventilación.
18. Servicio por personal calificado deberá ser provisto cuando:
 - A: El cable de poder o el contacto ha sido dañado; u
 - B: Objetos han caído o líquido ha sido derramado dentro del aparato; o
 - C: El aparato ha sido expuesto a la lluvia; o
 - D: El aparato parece no operar normalmente o muestra un cambio en su desempeño; o
 - E: El aparato ha sido tirado o su cubierta ha sido dañada.

Attachment 1 of BMPT Vfg 243/1991 Certificate of Compliance by Manufacturer

We hereby certify that the Equipment

Nomenclature: 5250 Remote Emulator Card Model No.: PC456C

is in compliance with the requirements of BMPT Vfg 243/1991 RFI suppressed. The normal operation of some equipment (e.g., signal generators) may be subject to specific regulations. Please observe the notices in this manual.

The marketing and sale of the equipment was reported to the Federal Office for Telecommunications Permits (BZT). The right to retest this equipment to verify compliance with the regulation was given to the BZT.

Anhang zur Anlage 1 zur AmtsblVfg 243/1991 Bescheinigung des Herstellers

Hiermit wird bescheinigt, daß der/die/das

DFÜ Emulator

(Gerät, Typ, Bezeichnung)

DIN-VDE-Norm bzw. EN-Norm bzw. BMPT-AmtsblVfg 243/1991 funkentstört ist.

Dem Bundesamt für Zulassungen in der Telekommunikation wurde das Inverkehrbringen dieses Gerätes angezeigt und die Berechtigung zur Überprüfung der Serie auf die Einhaltung der Bestimmungen eingeräumt.

TRADEMARKS USED IN THIS MANUAL

Quattro is a registered trademark of Borland International, Inc.

Wintronix is a registered trademark of Connectronix Corporation.

ETU is a trademark of Emerald Technology, Inc.

DecisionLink is a registered trademark of HandsOn Software, Inc.

Bar Codes & More, HP, LaserJet; Persuasive Presentations,

Polished Worksheets, ProCollection, and Forms, Etc. are registered trademarks of Hewlett-Packard.

AS/400, AT, DisplayWrite, IBM, Micro Channel, OS/400, Proprinter,

and Rumba are registered trademarks of International Business

Machines

Corporation. PC Support and PC/XT are trademarks of International Business Machines Corporation.

ITC Zapf Dingbats is a registered trademark of International Typeface Corporation.

Helvetica and Palatino are registered trademarks of Linotype Company.

Microsoft is a registered trademark of Microsoft Corporation. Windows is a trademark of Microsoft Corporation.

Novell and WordPerfect are registered trademarks of Novell Incorporated.

Epson is a registered trademark of Seiko Epson Corporation.

All other trademarks are the property of their respective owners.

DISCLAIMER

This manual was prepared by the manufacturer for use by its customers and resellers. All attempts have been made to ensure that the information presented in this manual is correct. However, no liability, expressed or implied, will be assumed by the manufacturer or its resellers for any damage resulting from the use of this information.

Contents

Chapter	Page
1.0 Specifications	8
2.0 Quick Setup Guide	11
2.1 Unpacking	11
2.2 Installing the Hardware	11
2.3 Installing the Software	14
2.4 Starting Emulation	15
3.0 Introduction	16
3.1 General Overview	16
3.2 Interfaces Supported	16
3.3 The Rest of This Manual	17
4.0 Hardware Installation	18
4.1 System Requirements	18
4.2 The Complete Package	18
4.3 Procedure for Hardware Installation	19
5.0 Software Installation	25
5.1 Installation/Pre-installation under DOS	25
5.2 Installation with Windows	26
5.2.1 Using Microsoft Windows 95/98	26
5.2.2 Using Microsoft Windows 3.1x.....	26
5.3 Installation with PC Support	27
6.0 Configuration	28
6.1 Configuring the Card	28
6.2 Basic Configuration	31
6.3 Advanced Functions	37
6.4 PC Support/400	49
7.0 Operation	50
7.1 Starting Emulation	50
7.2 Emulation Procedures under Windows 3.X	50
7.3 Hotkey Sequences	52
7.4 Status Line	54
7.5 Printing	55
7.6 Ending Emulation	60

Contents (continued)

Chapter	Page
8.0 Advanced Features	61
8.1 Record/Playback	61
8.2 3812 Printer Emulation	62
8.3 5219 Printer Emulation	69
8.4 The Command Language	72
9.0 Troubleshooting	76
9.1 Common Concerns	76
9.2 Error Messages	87
9.3 Application Compatibility	90
9.4 Calling Your Supplier	91
9.5 Shipping and Packaging	91
Appendix A: Names of Executable Files	92
A.1 User-Run Programs	92
A.2 Emulator-Run Programs	93
A.3 Other Files	93
Appendix B: Code-Set Tables	95
Appendix C: Typestyle (FGID) Tables	101
C.1 5219 Emulation	101
C.2 3812 Emulation	106
Appendix D: Keyboard-Scan Codes	128
Appendix E: Keyboard Templates	131
Appendix F: Related Documentation	140
Glossary	141
Index	149

1. Specifications

System Hardware Requirements —

PC: IBM PC, PC/XT, AT, or 100% compatible w/ free 16-bit ISA- or EISA-bus slot and 3.5" diskette drive;
Host: IBM System/3X or AS/400 with an available synchronous communications port that supports the SDLC protocol;
DCE (for remote operation only): (1) Pair of sync modems with appropriate DTE-to-DCE cables

System Software Requirements —

PC: DOS 3.3 or higher;
System/34 Host: System/34 release 9.0;
System/36 Host: System/36 release 5.1 or higher;
System/38 Host: System/38 release 8.0 or higher;
AS/400 Host: OS/400 V2R0 or higher

System Memory Requirements —

PC: 225 KB + 11 KB per display session + 29 KB per printer session; might require an additional 16 KB to save 132-column graphic screens when hotkeying between host and DOS sessions

Bus —

16-bit ISA or EISA; *not* compatible with Micro Channel Architecture (MCA)

Address Used —

Either 300 to 30F, 310 to 31F, 320 to 32F, 340 to 34F, 350 to 35F, 360 to 36F, 380 to 38F, or 3A0 to 3AF (user-selectable)

Interrupts Used —

Either IRQ3, IRQ4, IRQ10, IRQ11, or IRQ15 (user-selectable)

Cable Required —

For local operation:

- (1) 20-ft. (6.1-m) cross-pinned adapter cable:
 - Under EIA RS-232D/CCITT V.24: (1) DB44 male to DB25 female (EHN064-0020);
 - Under CCITT X.21: (1) DB44 male to DB15 female (EHN063-0020);
 - Under CCITT V.35: (1) DB44 male to 34-pin M-block male (EHN065-0020);

For remote operation:

- (1) 20-ft. (6.1-m) straight-thru-pinned adapter cable:
 - Under EIA RS-232D/CCITT V.24: (1) DB44 male to DB25 female (EHN061-0020);

	Under CCITT X.21: (1) DB44 male to DB15 female (EHN060-0020); Under CCITT V.35: (1) DB44 male to 34-pin M-block male (EHN062-0020)
Approvals —	FCC Part 15 Class A, DOC Class/MDC classe A, VDE B, CISPR 22 Class B
Standards —	Data Communication: EIA RS-232D/CCITT V.24, CCITT X.21, or CCITT V.35 (the standard used by your card depends on the adapter cable you attach to it)
Compatibility —	Operating Systems: DOS, Windows (under a DOS partition); Software: By IBM: Application Program Interface (API), File Support Utility (FSU), File Transfer Facility (FTF), PC Support/36, PC Support/38, PC Support/400, and Rumba®; By Emerald/Andrew: Emulator Transfer Utility (ETU™); By HandsOn: Decisionlink® and PC Connect; By Connectronix: Wintronix®
Interface —	Proprietary; with adapter cables, can support EIA RS-232D/CCITT V.24, CCITT X.21, and CCITT V.35
Protocol —	SDLC
Emulations —	Controllers: IBM 5251-12, 5294, and 5394; Displays: IBM 5251-11, 5291, 5292-1, 3179-1, 3180, 3196, 3197C, and 3197D; Printers: IBM 5224/5225, 5256, 4210 (under 4214 emulation), 4214 (can only support APF and BGU with IBM Proprinter® or Epson® EX or LQ models), 3812 (non-IPDS) and 5219 (HP LaserJet only)
PC Ports Supported —	LPT1, LPT2, LPT3, COM1, and COM2
Sessions Supported —	Minimum: One display; Maximum: Seven (session #1 must be a display, otherwise any combination of displays and printers; DOS supports a maximum of five printers)

5250 REMOTE EMULATOR CARD

Keyboard-Character

Sets Supported —	(18): (2) English: USA/Canada and UK; (4) French: France (AZERTY), France (QWERTY), Canada, and Switzerland; (1) French/Dutch: Belgium; (2) Spanish: Spain and Spanish-Speaking World; (2) German: Germany/Austria and Switzerland; (1) Italian; (1) Portuguese; (1) Dutch; (1) Danish; (1) Swedish; (1) Norwegian; (1) Finnish
Code Sets —	ASCII, EBCDIC
Data Rate —	Normal operation: Up to 128 kbps for remote applications, Up to 64 kbps for local applications (user-selectable with included software); When DMA channel is disabled: Up to 19.2 kbps (user-selectable with included software)
User Controls —	Software; (1) 4-position DIP switch for address selection
Indicators —	(6) LEDs: TXD, RXD, RTS, CTS, DSR, DCD
Connectors —	(1) DB44 (proprietary) female for data communication; (1) Card-edge male for power
Power —	From PC bus: +5 VDC at 620 to 650 mA, -5 VDC at 110 to 130 mA
Heat Emitted —	15.4 btu/hr. (4.5 watts) maximum
Operating Temperature —	32 to 110°F (0 to 45°C)
Storage Temperature —	-22 to +158°F (-30 to +70°C)
Humidity —	to 95% noncondensing
Size —	Half card; 4.2"H x 0.8"W x 6"D (10.7 x 2 x 15.2 cm)
Weight —	Net: 0.3 lb. (0.1 kg); Shipping: 3 lb. (1.4 kg)

2. Quick Setup Guide

Thank you for buying the 5250 Remote Emulator Card. If you are familiar with emulation equipment, this chapter is designed to help you get up and running in a short amount of time. It describes how to do the hardware installation, software installation, and configuration setup in just a few steps each.

CAUTION!

The 5250 Remote Emulator Card is a static-sensitive device. Keep the Card in its protective bag until you are ready to install it.

2.1 Unpacking

Check the package your Card was shipped in for water-related or shipping-related damage; contact the carrier if you find any. The package should contain the following:

- (1) 5250 Remote Emulator Card
- (1) 3.5" software diskette
- (1) copy of this manual

Keep the original packaging in case you ever have to reship the card. If your system requires 5 ¼" diskettes, contact your supplier.

2.2 Installing the Hardware

1. Turn OFF the PC and any peripherals that might be attached to it. Unplug the PC's power cord or power supply from the electrical outlet and (if possible) from the PC.

CAUTION!

Make sure that the PC is OFF and its power supply is unplugged and (if possible) its power cord removed before you begin installing the Card or connecting any of its cables. Don't turn the PC back ON until you have completely finished installing the Card and connecting all of its cables.

WARNUNG!

Vergewisseren Sie sich, dass die PC ausgeschaltet und die Netzzuleitung entfernt ist bevor irgendwelche Kabel angeschlossen werden. Schalten Sie Gerät nicht wieder ein bevor alle Kabel angeschlossen sind. Zur vollständigen Trennung vom Netz ist der Netzstecker zu ziehen.

2. Disconnect the PC from its monitor and remove the PC's cover. Locate an empty expansion slot and remove the slot's cover (but keep the slot cover's screw close by). Touch a grounded surface, other than the PC's chassis to dissipate any static charge you might have built up, then carefully remove the 5250 Remote Emulator Card from its anti-static bag.
3. Grasp the 5250 Remote Emulator Card by its edges. If the Card's factory-default I/O address 300 to 30F is available in your PC, go to Step 4. Otherwise, using a screwdriver, set the Card's DIP switch for an unused I/O address (see Table 2-1 below).

Table 2-1. Possible Settings of the Card's DIP Switch

Base I/O Address Used	Switch-Position Number			
	1	2	3	4
300 to 30F*	ON	ON	ON	ON
310 to 31F	ON	ON	ON	OFF
320 to 32F	ON	ON	OFF	ON
340 to 34F	ON	OFF	ON	ON
350 to 35F	ON	OFF	ON	OFF
360 to 36F	ON	OFF	OFF	ON
380 to 38F	OFF	ON	ON	ON
3A0 to 3AF	OFF	ON	OFF	ON

* Factory-default setting

4. Press the card firmly into the expansion slot. Screw the slot cover's screw back in.
5. Run the Card's diagnostic program *before* you replace the PC's cover:
 - a) Plug in the monitor, keyboard, and power without replacing the PC's cover, then turn ON the PC. (Be *extremely careful* while you do this.)
 - b) At the first DOS prompt, go to the directory where you have the 5250 Remote Emulator Card's software stored: Type the diskette-

drive letter followed by a colon and **[ENTER]** (if you are keeping it on a copy of the original diskette) or the hard-disk letter followed by a colon, a backslash, the subdirectory name, and **[ENTER]** (if you're keeping it on the hard drive).

- c) At the next DOS prompt, run the Emulator's diagnostic program by typing

emdiag [ENTER]

A copyright screen appears, prompting you to press **[ENTER]** to continue. Then a diagnostic screen appears, showing the PC I/O addresses the Card supports. Use the cursor to highlight the address you want to test-run, then press **[ENTER]**.

- d) If this test fails for the given address, there might be a conflict for that address that you're not aware of. Check the address settings of the PC's I/O components again, carefully, and try setting the Card to use a different address. If the test fails for any address you try, you probably have a bad Card. See **Section 9.4**.
- e) If this test is successful, the program prompts you to let it do a modem-loopback test. Select "N"; the program ends.
6. Use an appropriate cable to connect the 5250 Remote Emulator Card to a host's communication port or to a modem:
- For local operation (direct connection to host):
- Across EIA RS-232D/CCITT V.24 interface: Cross-pinned DB44 male to DB25 female (product code EHN064-0020);
 - Across CCITT X.21 interface: Cross-pinned DB44 male to DB15 female (product code EHN063-0020);
 - Across CCITT V.35 interface: Cross-pinned DB44 male to 34-pin M-block male (product code EHN065-0020);
- For remote operation (connection to host across modem link):
- Across EIA RS-232D/CCITT V.24 interface: Straight-through-pinned DB44 male to DB25 female (product code EHN061-0020);
 - Across CCITT X.21 interface: Straight-through-pinned DB44 male to DB15 female (product code EHN060-0020);
 - Across CCITT V.35 interface: Straight-through-pinned DB44 male to 34-pin M-block male (product code EHN062-0020);
7. **Remote operation only:** Follow the modem manufacturer's instructions for installing and configuring the modem to perform synchronous communication over your type of telephone line.

8. Now you can replace the PC's cover, reattach all cables, and power up any other peripheral you like.

2.3 Installing the Software

Now install software for the 5250 Remote Emulator Card from the software diskette included with the Card. (If you are using Microsoft® Windows™, refer to **Sections 5.2** and **7.2** for more information.)

1. If you're going to keep the Card's software on *diskette*, first make a backup copy of the original diskette and store the original. Then put the backup diskette into your computer diskette drive, switch to that drive's directory, and go to Step 8. If you're going to keep the Card's software on your *hard drive*, go to Step 2.
2. At the DOS prompt, go to the hard drive's root directory by typing the hard-drive letter followed by a colon and **[ENTER]** ("**c: [ENTER]**", for example).
3. Create a directory at the DOS prompt by typing
`md 5251r [ENTER]`
4. Insert the 5250 Remote Emulator Card's software diskette into the computer's diskette drive.
5. Assuming the diskette drive is drive a:, copy the software to the new directory on the hard drive by typing
`copy a:*.* c:\5251r`
6. Remove the diskette and put it away.
7. Change to the emulation directory by typing
`cd 5251r`
8. Run the configuration program by typing
`rconfig`
9. The 5250 Remote Emulator Card's software is preconfigured for a standard setup. Select "Modify" and the Operating Environment setup screen appears. You will be prompted to move the cursor to make a selection from its menu. Make sure you choose the host configuration. Refer to **Chapter 6** for more information.
10. After selecting your configuration option(s), press **[ESC]** (the escape key) until you return to the main menu. This prompt will appear:

Do you want to save this configuration? (Y/N)

Type “Y”. (If you selected “PC Support Only” or “Terminal Emulation and PC Support,” you will be prompted to enter the correct path for PC Support™.) Select “Exit” to end the program, then press [ENTER] to return to the DOS prompt.

2.4 Starting Emulation

To begin emulation with the default configuration, type

```
cd 5251r [ENTER]
```

```
em5251r [ENTER]
```

To begin emulation with a non-default configuration file, type

```
cd 5251r [ENTER]
```

```
em5251r filename [ENTER]
```

where *filename* is the name of the customized file.

The sign-on screen will appear. If you chose the DOS startup as your Emulator Startup option, the DOS screen will appear, and you will need to hotkey to the host session. Refer to **Section 7.4** for more information.

3. Introduction

3.1 General Overview

Thank you for purchasing a 5250 Remote Emulator Card. We hope that the Card helps you meet all of your PC-to-twinax connectivity needs.

The 5250 Remote Emulator Card brings the best of the twinax and PC worlds together by connecting your IBM® AS/400® or System/3X to a PC either directly or across a phone-line-plus-sync-modem SDLC link. The Card, which operates in DOS or Windows (under a DOS partition), lets your PC emulate (act like) any of several controllers or display stations and lets your PC's printer emulate several types of system printers. At the time of this writing, it is the fastest card of its type on the market, capable of local operation at up to 64 kbps or remote operation at up to 128 kbps. It emulates a 5394 remote controller, which gives it the capability of working with PC Support software on the AS/400. The Card has 132-column capability and supports multiple languages.

3.2 Interfaces Supported

The 5250 Remote Emulator Card supports these three interfaces:

- **EIA RS-232D**, known internationally as **V.24**, is a standard for interfacing Data Terminal Equipment (DTEs) with Data Communications Equipment (DCEs) over short distances.
- **X.21** is a general purpose interface between DTEs and Data-Circuit-Terminating Equipment (DCTs) for operating on synchronous Public Data Networks (PDN) that provide dialup and leased-line services for data communication. X.21 supports transmitting at speeds up to 64 Kbps to a maximum distance of 1000 meters (3280.8 feet).
- **V.35** is a high-speed interface. The 5250 Remote Emulator Card supports V.35 transmission at speeds up to 128 kbps (for remote applications) or up to 64 kbps (for local applications) to a maximum distance, depending on your data rate and the type of cable you use, of 600 to 1200 meters (1968.5 to 3937 feet).

3.3 The Rest of This Manual

Chapters 4 and 5 of this manual will guide you through step-by-step installation procedures. **Chapter 6** explains how to configure the Card. Once installed, the 5250 Remote Emulator Card can function without further operator intervention, but **Chapter 7** includes details on all of the Card's operating functions and **Chapter 8** explains the card's more advanced features such as record/playback, macros, 3812/5219 printer emulation, escape commands, and command pass-through. If problems should arise at any time, **Chapter 9** is a troubleshooting guide that might help you diagnose and possibly fix them.

4. Hardware Installation

4.1 System Requirements

4.1.1 PC REQUIREMENTS

You must have these PC resources to use the 5250 Remote Emulator Card:

- IBM PC, PC/XT™, AT®, 386, 486, or compatible personal computer that does not use the Micro Channel® Architecture
- Floppy-diskette drive
- DOS version 3.3 or higher
- 225K of RAM + 11K per display session + 29K per printer session

4.1.2 HOST REQUIREMENTS

You must have these host resources to use the 5250 Remote Emulator Card:

- IBM System/34, /36, /38, or AS/400
- Synchronous communications port that supports the SDLC protocol

4.2 The Complete Package

When you receive your Card, check the package it came in for water- or shipping damage; contact the carrier if you find any. The package should contain the following:

- (1) 5250 Remote Emulator Card
- (1) 3.5" software diskette
- (1) copy of this manual

Keep the original packaging in case the Card must be reshipped. If your system requires 5 ¼" diskettes, please contact your supplier.

4.3 Procedure for Hardware Installation

CAUTION!

The 5250 Remote Emulator Card is static-sensitive. Take the same precautions you would with any static-sensitive device. One such precaution is being aware that some elements of your work environment, such as carpeting, floor mats, dry air from winter heating, etc., can cause static buildup. To prevent a static discharge, touch a grounded surface, other than the PC's chassis, before handling the Card. Do not touch any components on the Card's surface, especially the microprocessor chips; handle the Card by the edges only.

Follow these instructions to install the 5250 Remote Emulator Card in your PC:

1. Turn OFF and unplug the PC and all devices attached to it.

CAUTION!

Make sure that the PC is OFF and its power supply is unplugged and (if possible) its power cord removed before you begin installing the Card or connecting any of its cables. Don't turn the PC back ON until you have completely finished installing the Card and connecting all of its cables.

WARNUNG!

Vergewisseren Sie sich, dass die PC ausgeschaltet und die Netzleitung entfernt ist bevor irgendwelche Kabel angeschlossen werden. Schalten Sie Gerät nicht wieder ein bevor alle Kabel angeschlossen sind. Zur vollständigen Trennung vom Netz ist der Netzstecker zu ziehen.

2. Disconnect the PC from its monitor. If the monitor is sitting on top of the PC's case, lift the monitor off and set it aside.
3. Follow the instructions in the PC's manual for removing the PC's cover. Set the cover aside and save the screws for reassembly.
4. Locate an empty expansion slot. Using a screwdriver (or, if necessary, a socket wrench), remove the slot's cover. Keep the slot cover's screw close by.
5. Touch a grounded surface such as the PC's chassis to dissipate any static charge you might have built up, then carefully remove the 5250 Remote Emulator Card from its anti-static bag.

6. When you install the Card into the PC, it uses one of the PC's I/O addresses. The Card is factory-preset to use the base I/O address of 300. Since two cards can't share the same address (that could cause the PC to crash), you might need to change the 5250 Remote Emulator Card's address setting. If you do have to change this setting, go to the next step; if you don't, go to Step 8.
7. Locate the DIP switch in the upper left-hand corner of the Card (see Figure 4-1 below).

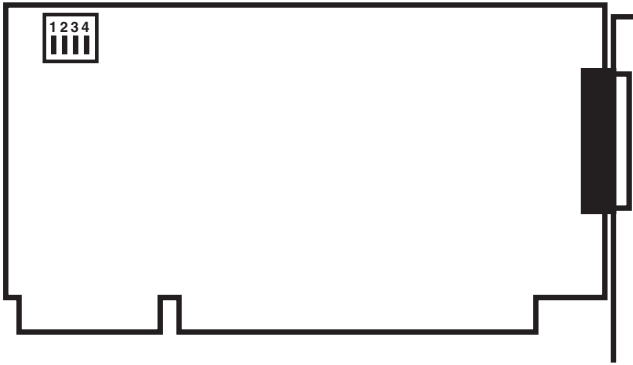

Figure 4-1. Location of the Card's DIP switch.

Using the screwdriver provided with your Card, set the DIP switch to select an unused I/O address (see Table 4-1 on the next page). Write down the address you've selected so that you'll have it handy when you're ready to do the software configuration.

8. Hold the card by its edges (do not touch the components or circuitry), and insert the card into the expansion slot. Firmly press the card into the PC motherboard's socket connector. See Figure 4-2 on the next page.
9. Align the slot on the Card's bracket with the hole you opened when you removed the expansion slot's cover: Gently lift or press down on the end of the Card opposite the bracket and connector until the slot and hole are properly lined up. If they are not properly aligned, the card will not seat correctly in the PC and will not function properly.

Table 4-1. Possible Settings of the Card's DIP Switch

Base I/O Address Used	Switch-Position Number			
	1	2	3	4
300 to 30F*	ON	ON	ON	ON
310 to 31F	ON	ON	ON	OFF
320 to 32F	ON	ON	OFF	ON
340 to 34F	ON	OFF	ON	ON
350 to 35F	ON	OFF	ON	OFF
360 to 36F	ON	OFF	OFF	ON
380 to 38F	OFF	ON	ON	ON
3A0 to 3AF	OFF	ON	OFF	ON

* Factory-default setting

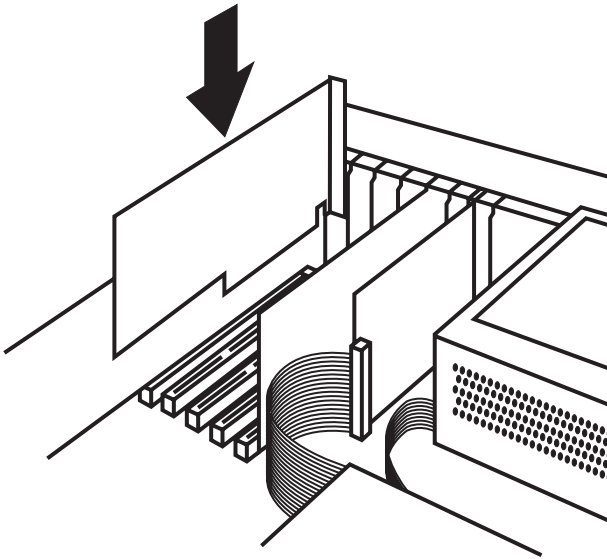
**Figure 4-2. Inserting the card into the PC.**

10. Insert the screw you removed from the slot cover into the hole on top of the Card's bracket. Tighten it to screw down the Card.

11. Run the Card's diagnostic program *before* you replace the PC's cover:
 - a) Plug in the monitor, keyboard, and power without replacing the PC's cover, then turn ON the PC. (Be *extremely careful* while you do this.)
 - b) At the first DOS prompt, go to the directory where you have the 5250 Remote Emulator Card's software stored: Type the diskette-drive letter followed by a colon and **[ENTER]** (if you are keeping it on a copy of the original diskette) or the hard-disk letter followed by a colon, a backslash, the subdirectory name, and **[ENTER]** (if you're keeping it on the hard drive).
 - c) At the next DOS prompt, run the Emulator's diagnostic program by typing

```
emdiag [ENTER]
```

A copyright screen appears, prompting you to press **[ENTER]** to continue. Then, as shown in Figure 4-3 on the next page, a diagnostic screen appears, showing the PC I/O addresses the Card supports. Use the cursor to highlight the address the DIP switch is set for, then press **[ENTER]**.
 - d) If this test fails for the given address, there might be a conflict for that address that you're not aware of. Check the address settings of the PC's I/O components again, carefully, and try setting the Card's DIP Switch to a different address. If the test fails for several addresses, make sure the Card is seated properly. If the test fails for all the addresses you try, the slot it's in might be defective; reinstall the Card in a different slot. If all addresses still fail, you probably have a bad Card. See **Section 9.3**.
 - e) If this test is successful, the program prompts you to let it do a modem-loopback test. Go to the next step.

EM5251R Diagnostics Program

Select address range that corresponds to the EM5251R
Switch Setting

300-30F
310-31F
320-32F
340-34F
350-35F
360-36F
380-38F
3A0-3AF

Menu Command Options:

Change Option ← Select Options [ESC] Previous
Screen

12. Use an appropriate cable to connect the 5250 Remote Emulator Card to a host's communication port or to a modem:
 - For local operation (direct connection to host):**
 - Across EIA RS-232D/CCITT V.24 interface: Cross-pinned DB44 male to DB25 female (product code EHN064-0020);
 - Across CCITT X.21 interface: Cross-pinned DB44 male to DB15 female (product code EHN063-0020);
 - Across CCITT V.35 interface: Cross-pinned DB44 male to 34-pin M-block male (product code EHN065-0020);
 - For remote operation (connection to host across modem link):**
 - Across EIA RS-232D/CCITT V.24 interface: Straight-through-pinned DB44 male to DB25 female (product code EHN061-0020);
 - Across CCITT X.21 interface: Straight-through-pinned DB44 male to DB15 female (product code EHN060-0020);
 - Across CCITT V.35 interface: Straight-through-pinned DB44 male to 34-pin M-block male (product code EHN062-0020);
13. **Remote operation only:** Follow the modem manufacturer's instructions for installing and configuring the modem to perform synchronous communication over your type of telephone line.
14. **Remote operation only:** Enter "N" at the prompt to let the Card initiate its modem-loopback test.

5250 REMOTE EMULATOR CARD

15. *Now* you can replace the PC's cover, reattach all cables, and power up any other peripheral you like. If necessary, put the monitor back on top of the PC.

5. Software Installation

This chapter contains instructions for installing the 5250 Remote Emulator Card's software for use with DOS, Windows (under a DOS partition), or PC Support. You'll take different kinds of actions to install, configure, and run this software, and we've used a different typestyle to highlight each kind of action, as shown in this key:

- Actions in **boldface type** are commands you'll type in.
- Actions in outlined type are buttons or icons you'll click on.
- Underlined actions are menu options you'll select.

Before installing the software for use with with Windows or PC Support, you must pre-install it under DOS, as detailed in **Section 5.1**.

5.1 Installation/Pre-installation under DOS

NOTE

The instructions in this section assume drive **A:** is the diskette drive. If the diskette drive has been assigned a different letter, use that letter instead.

Before beginning to install the 5250 Remote Emulator Card's software, make a backup copy of it:

1. Type **DISKCOPY A: A:** and follow the prompt.
2. Store the original disk in a safe place.

Now install the 5250 Remote Emulator Card's software by copying it to your PC's hard drive:

1. At the DOS prompt, create a directory named "5251R" under the root directory. Type:
C: [ENTER]
CD [ENTER]
MD EM5251R [ENTER]
2. Insert the 5250 Remote Emulator Card's software diskette into drive A:.

3. Copy the software to the new directory on the hard drive by typing:

```
COPY A:\*.* C:\5251R [ENTER]
```

4. When the copying is finished, remove the software diskette and store it in a safe place.

This completes the DOS installation.

5.2 Installation with Microsoft Windows

5.2.1 USING MICROSOFT WINDOWS 95/98

To create a shortcut in Windows 95/98 to access the emulation software, follow these simple steps after installing the software:

1. Insert the PC456C diskette.
2. Right click on the desktop and select New then select Shortcut.
3. Browse the c:\ drive for EM5251R.BAT (it should be in the folder you installed the software to).
4. Click Open, Next, Next, Pick an Icon, and then Finish.

5.2.2 USING MICROSOFT WINDOWS 3.1X

To install the 5250 Remote Emulator Card's software under Windows, follow these simple steps after finishing preinstallation:

1. Start Windows by typing **WIN**.
2. Go to the folder where the icon is to be located.
3. From the File menu, select New.
4. Select Program Item.
5. For the description, type **EM5251R**.
6. For the command line, type **C:\5251R\EM5251R.PIF**.
7. Select Change Icon.
8. For the icon name, type **C:\5251R\EM5251R.ICO**.
9. To save and exit, click on OK twice.

10. From the File menu, select New.
11. Select Program Item.
12. For the description, type **RCONFIG**.
13. For the command line, type **C:\5251R\RCONFIG.PIF**.
14. Select Change Icon.
15. For the icon name, type **C:\5251R\RCONFIG.ICO**.
16. To save and exit, click on **OK** twice.

You are now ready to begin configuration; follow the instructions in the next chapter. Be sure to change the hotkey code under the Keyboard Setup option (see **Section 6.3.2**). For hints about operating the Card under Windows, see **Section 7.2**.

5.3 Installation with PC Support

5.3.1 PC SUPPORT/38

To install IBM PC Support/38, follow the installation instructions in its technical reference manual, *IBM Enhanced Emulation*. Before you install the emulation software, configure the 5250 Remote Emulator Card (see **Chapter 6**). When you do this, set the virtual disk drive to your diskette drive and set the emulator startup to DOS (see **Section 6.2.2**). Install the emulation software when you're ready to start emulation (see **Section 7.1.3** for full instructions).

5.3.2 PC SUPPORT/36

To install IBM PC Support/36, follow the installation instructions in its user's guide. During the installation, when you are asked for the type of emulation program, specify "Other" and enter the name of the 5250 Remote Emulator Card's emulation program, **EM5251R.EXE**. PC Support/36 takes over from there; no further software installation is necessary.

You are now ready to begin configuration; follow the instructions in the next chapter. Be sure to change the hotkey code under the Keyboard Setup option (see **Section 6.3.2**).

6. Configuration

Before the 5250 Remote Emulator Card can communicate with the host system, both the host system and the 5250 Remote Emulator Card software must be configured.

6.1 Configuring the Card

6.1.1 LAUNCHING CONFIGURATION

The 5250 Remote Emulator Card's configuration information is contained in a disk file. A standard default configuration file is included with the Card's software. The default file can be changed, or you can create as many configuration files as needed.

The following keys are used throughout the configuration:

Key(s)	Function
[ENTER]	Selects and saves your choice
[ESC] (escape)	Returns to the previous screen
[↑], [↓], [↵], and [⌀]	Move from one option to another
[SPACE] (space bar)	Erases the choice shown at the cursor location, or toggles through the possible selections for a given option

Start the configuration process by following these steps:

- 1A. Under DOS: Make sure you are at the drive and directory where the 5250 Remote Emulator Card's software is stored. Then type **CD \5251R** [**ENTER**]. Type **RCONFIG** at the DOS prompt and press [**ENTER**].
- 1B. Under Windows: Double click on the **RConfig** icon.
2. After a few moments, the Main Menu appears as shown in Figure 6-1 on the next page.

```
Modify / Create /Delete / Exit                               File Name =
_____
```

```
Modify an existing configuration file.
```

```
Remote 5250 Configuration Utility
Version x.x
```

```
Copyright © 1993 SDE Corp.
```

```
When finished, select Exit, then type EM5251R <filename>
to enter emulation.
```

```
Menu Command Options:
```

```
Change Option  ↓  Select Options <ESC> Previous Screen
```

Figure 6-1. The configuration program's Main Menu.

- Use the cursor arrow keys to move the highlighted block on the top of the Main Menu to one of these options: Modify, Create, Delete, or Exit. Press [ENTER] to select your choice. (Modify changes the current configuration. Unless there is a need for more than one configuration, choose this option. Select Create if a new configuration is needed.)

6.1.2 MODIFY OR CREATE A CONFIGURATION

To change an existing configuration, select Modify from the Main Menu. The default configuration file is named EM5251R. You might want to modify the default configuration file, rather than create a new one, to reduce the amount of disk storage.

To create a new configuration file, select Create from the Main Menu. This creates and stores a new file. Type the new file name, then press [ENTER].

When you select Modify or Create, the "Operating Environment" setup screen appears. You will be prompted to select one of these options:

- Terminal Emulation Only
- PC Support/400 Only
- Terminal Emulation and PC Support/400

If you choose Option 2, PC Support/400 Only, skip ahead to **Section 6.4**.

If you choose Option 1, Terminal Emulation Only, the Configuration Menu will appear, as shown below in Figure 6-2. Follow the appropriate instructions in the remainder of **Sections 6.1** through **6.3**.

If you choose Option 3, Terminal Emulation and PC Support/400, the Configuration Menu will appear, as shown below in Figure 6-2. Follow the appropriate instructions in the remainder of **Sections 6.1** and **6.2**, then press **[ESC]** and go to **Section 6.4**.

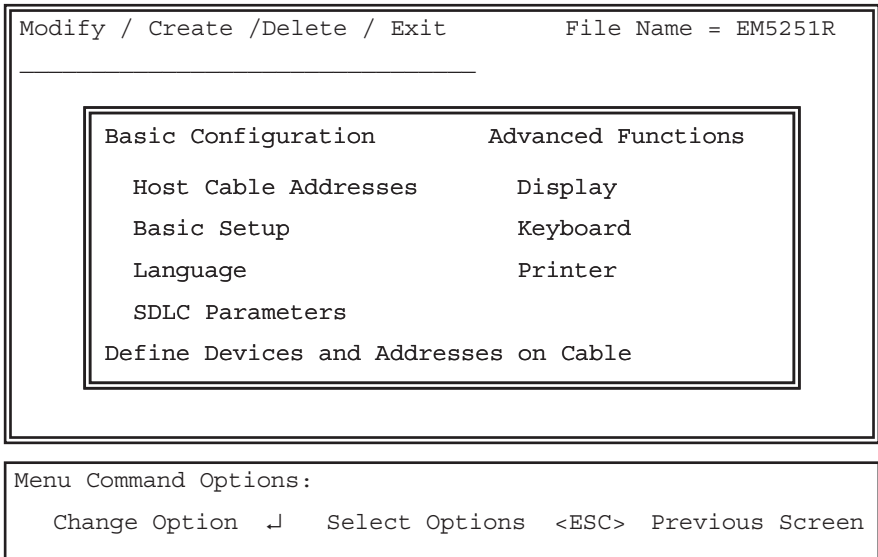

Figure 6-2. The configuration program’s Configuration Menu.

The items in this menu’s left-hand “Basic Configuration” column are necessary for the PC’s basic configuration. The items in the right-hand “Advanced Functions” column are for more advanced configuration of the PC as a peripheral. For standard DOS operation, the advanced functions do not need to be changed.

Move the cursor to an option on the Configuration Menu and press **[ENTER]**. This displays a second screen of options to select from, as shown in Figure 6-3 on the next page. The options and possible selections are described in **Sections 6.2** and **6.3**.

When you’ve finished making selections from the Configuration Menu, press **[ESC]** to return to the Main Menu. You will be prompted to save the configuration. Choose Yes to save the configuration. Choose No to exit without saving.

6.1.2 DELETE A CONFIGURATION

To delete a configuration file, select Delete from the Main Menu. The program displays a list of up to eight of these files. (You can create more than eight configuration files, but the program is only able to display the first eight in this menu. Move the cursor to the file you want to delete and press **[ENTER]**. You will be prompted,

Are you sure you want to delete this file (y/n)?

Press **Y** and then **[ENTER]** to delete the file. Press **N** and then **[ENTER]** to return to the Main Menu.

6.1.3 EXIT THE CONFIGURATION PROGRAM

After you've finished selecting your configuration options, press **[ESC]** until this prompt appears:

Do you want to save this configuration? (y/n)

Press **Y** to save the new configuration, or press **N** to discard the changes, then press **[ENTER]**. If you selected either Option 2, PC Support/400 Only, or Option 3, Terminal Emulation and PC Support/400, you will now be prompted to enter the correct path. Finally select Exit to end the program, then press **[ENTER]** to return to the DOS prompt.

6.2 Basic Configuration

These are the Basic Configuration options:

- Host cable addresses
- Basic setup options for the PC
- Language type
- SDLC parameters

6.2.1 CABLE ADDRESSES

At the Configuration Menu, move the cursor to Host Cable Addresses and press **[ENTER]**. The Cable Addresses Menu appears, as shown next in Figure 6-3.

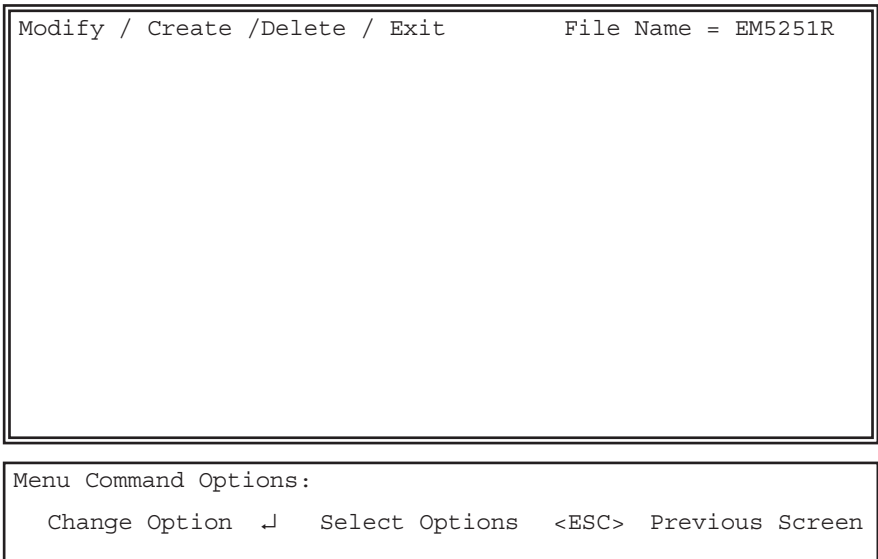

Figure 6-3. The Cable Addresses Menu.

You can set these options under this menu:

- **Logical Session #:** Each device on the twinax line is referred to as a Logical Unit (LU); when an LU communicates with the host, this is referred to as a “session.” Up to seven devices can be assigned logical session numbers.
- **Host Address:** The host address is the local station address as configured on the host. Use the space bar to erase an address selection. You can only use each address once; if you use an address more than once, an “address conflict” message will appear.
- **Device Emulated:** The 5250 Remote Emulator Card can emulate IBM displays or printers. Move the cursor to the Device Emulated column, and a menu window listing the possible display and printer choices appears on the screen. The display models you can choose from are the 5251 Model 11, 5291, 5292/3179, 3180, 3196, 3197C, and 3197D. The printers you can choose from are the 5256, 5224, 5225, 4214, 5219, and 3812.

Certain printers have a “text” option or a “graphics” option. Select the “text” option for basic operation or the “graphics” option if you want to use advanced printer functions.

Use the [↑] (cursor up) and [↓] (cursor down) keys to highlight your emulation choice and press [ENTER] to select it. Make sure the

emulation choice for each cable address matches the device that the system operator has configured the host to expect.

- **Printer Type:** When you move the cursor to this column, a menu window listing the possible printer types appears. If the printer connected to the PC is not listed, a printer definition can be created by selecting Other, typing a new name, and then defining the printer as discussed in **Section 6.3.3**—select Printer Commands Definition under the Printer-Setup Menu and follow the instructions on page 43.
- **PC Port:** Select the PC port to which the printer is physically attached. Choose an “LPT” port for parallel printers or a “COM” port for serial printers. Move the cursor to the PC Port column, and a window appears with the following choices: LPT 1, LPT 2, LPT 3, COM 1, or COM 2. If you choose a “COM” port for serial printers, a second window will appear on the screen to define communications protocol for data rate, data bits, stop bits, and parity.

6.2.2 BASIC SETUP

Basic Setup options are for configuring the PC in typical applications. At the Configuration Menu, move the cursor to Basic Setup and press [ENTER]. The Basic Setup Menu appears, as shown below in Figure 6-4.

Modify	Setup Options			
	Monitor Type (IBM)	Monochrome	Color	Color
	Emulator Startup	3X Emulation	DOS	
	PC Keyboard	AT	PC/XT	Enhanced
	Emulated Keyboard	5250	PC	
	Key Click	Off	On	
	File Transfer	No	Yes	
	Virtual Disk	A	B	C D
	Direct Hot Key	On	Off	
Menu				
Char	Select type of monitor connected to PC			

Figure 6-4. The Basic Setup Menu.

You can set these options under this menu:

- **Monitor Type:** Select the type of monitor connected to the PC. The options are Monochrome, Color, or Color (IBM). To make a selection, move the highlighted block to your monitor type. Only select Color (IBM) if you are using a CGA monitor and snow appears on the screen.
- **Emulator Startup:** After you start emulation, either a DOS screen or a host screen will appear. To start emulation with a DOS screen, which you must do if you're running emulation under PC Support/38, select DOS. From DOS, you can "hotkey" to enter the host session. To start emulation with a host screen, select 3X Emulation. From host sessions, you can hotkey to enter DOS.
- **PC Keyboard:** Identify which keyboard style is attached to the PC: an AT style (84 keys), PC/XT style (83 keys), or Enhanced style (101/102 keys). Move the cursor with the arrow keys and select the keyboard type you have attached to your personal computer. If you don't know which keyboard you have, look at the keyboard templates in **Appendix C**.
- **Emulated Keyboard:** Select the keyboard type to emulate. Keyboards used with a PC/XT or AT have the same number of keys as the IBM 5250 terminal keyboard; however, they have different key layouts and scan codes.

For experienced host-system users, the 5250 layout may be more comfortable. This selection uses the same general layout as a keyboard used on the host. For PC users, the PC layout may be the best. (See **Appendix D** for the keyboard templates.) The normal PC keyboard layout is restored when DOS is active.
- **Key Click:** The key click can be turned ON or OFF. If it is ON, you will hear a clicking sound each time you press a key.
- **File Transfer:** Select Yes to enable the FTP API used by all file transfer utilities. Select No to disable the FTP API.
- **Virtual Disk:** This option defines which disk drive is used by PC Support/38 as the virtual disk drive. If you're configuring the Card and software to run under PC Support/38, select the letter designation of your diskette drive (normally A:). If you are not using PC Support/38, ignore this option.
- **Direct Hot Key:** With the direct hotkey sequences, **[ALT] [1]** through **[ALT] [7]**, you can jump directly from one session to another rather than jumping sequentially through the sessions (see **Section 7.4**). This

hotkey can be turned ON or OFF. Disable it only if it will cause conflict with another PC program that also uses one or more of [**ALT**] [**1**] through [**ALT**] [**7**].

6.2.3 LANGUAGE

Language options are for matching the host's language settings. At the Configuration Menu, move the cursor to Language and press [**ENTER**]. The Language Options Menu appears, as shown below in Figure 6-5.

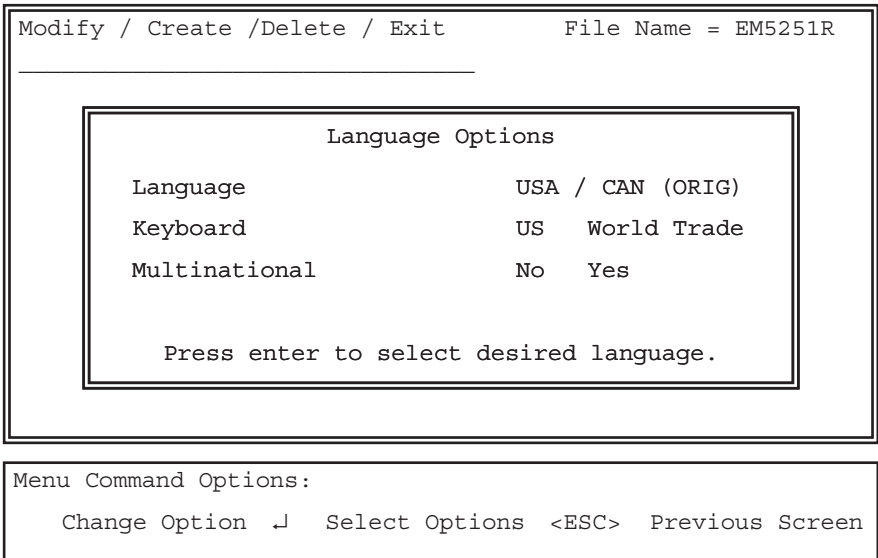

Figure 6-5. The Language Options Menu.

You can set these options under this menu:

- **Language:** The 5250 Remote Emulator Card supports 18 languages. Select the language that matches the host system's settings. The USA / CAN (ORIG) keyboard-language configuration uses the factory-default keyboard layouts, whereas the USA / CAN (TERM) uses a layout resembling the terminal keyboard (see **Appendix E**).
- **Keyboard:** Select the type of keyboard (U.S. or World Trade) configured on the host system.
- **Multinational:** If the host is configured for Multinational, select Yes.

6.2.4 SDLC PARAMETERS

SDLC parameters are for matching the host's line and controller settings. The system administrator should verify that the settings you choose match the host configuration. At the Configuration Menu, move the cursor to SDLC Parameters and press **[ENTER]**. The SDLC Parameters Menu appears, as shown below in Figure 6-6.

Modify / Create /Delete / Exit		File Name = EM5251R
SDLC Parameters	Values	
Controller Type	5394	
Station Address	0F	
NRZ/NRZI Encoding	NRZI	
DMA Channel 1	Enable	
DMA Channel 3	Enable	
IRQ Interrupts	IRQ10	
Base I/O Address	340-34F	
Baud Rate	9600	
Select type 5251-12, 5294, or 5394		

Menu Command Options:
 Use ↑ ↓ to select parameters ← → to modify values
 Change Option ↵ Select Options <ESC> Previous Screen

Figure 6-6. The SDLC Parameters Menu.

You can set these options under this menu:

- **Controller Type:** The type of remote controller to be emulated. This setting must match that of the host. The choices are 5394, 5294, and 5251-12.

NOTE

The System/34 supports only the 5251-12 controller type. System/36 and System/38 do not support the 5394 remote controller.

- **Controller Station Address:** An address used to identify the emulator to the host system. This setting must match that of the host. Enter the address assigned to the host controller.

- **NRZ/NRZI Encoding:** NRZ (Non-Return to Zero) and NRZI (Non-Return to Zero Inverted) are SDLC transmission-coding options used to keep synchronization loss between modems to a minimum. The recommended initial setting is NRZI. This setting must match that of the host.
- **Interrupt Request Level:** An IRQ (Interrupt Request) is a control signal sent by the emulator card to demand the PC's attention. The Card supports IRQ levels 3, 4, 10, 11, and 15. If you've installed the Card in an 8-bit slot, use IRQ 3 or 4. If you're running Windows, use IRQ 10, 11, or 15.

NOTE

PC adapter boards require a unique IRQ level. Make sure the 5250 Remote Emulator Card's IRQ level is not the same as the IRQ level of any other board in the same PC.

- **DMA Channel 1 and DMA Channel 3:** By using DMA (Direct Memory Access) channels, the 5250 Remote Emulator Card can transmit data to the host at a higher data rate than 19,200 bps. If you select Disable, the 5250 Remote Emulator Card will not operate above 19,200 bps.

NOTE

Both channels should be enabled. Problems might occur if both are disabled.

- **Base I/O Address:** This is the Card's address in the PC's I/O memory. The address you select here must match the one you set with the Card's DIP switches during the hardware installation (see **Section 4.3**). Refer to page 16 for the list of addresses you can choose from.

NOTE

PC adapter boards require a unique I/O address. Make sure the 5250 Remote Emulator Card's I/O address is not the same as the I/O address of any other board in the same PC.

- **Baud Rate:** The data rate at which the Card operates, measured in bits per second. Selecting Modem automatically sets the 5250 Remote Emulator Card to match the data rate of the attached modem. When you use a null-modem cable, manually select the data rate for the communications line.

6.3 Advanced Functions

NOTE

If you selected Option 3, Terminal Emulation and PC Support/400, at the Operating Environment setup screen (see Section 6.1.2), do not change any Advanced Functions; press [ESC] and skip ahead to Section 6.4.

For Windows applications, you must change the hotkey code (see **Section 6.3.2**); otherwise, only unique applications will require you to work with Advanced Functions (consult with your system operator before doing so). These Advanced Functions menus are available under the Configuration Menu:

- Display Setup
- Keyboard Setup
- Printer Setup

6.3.1 DISPLAY SETUP

Use the Display-Setup Menu, shown in Figure 6-7 below, to set up the attributes of the screen display.

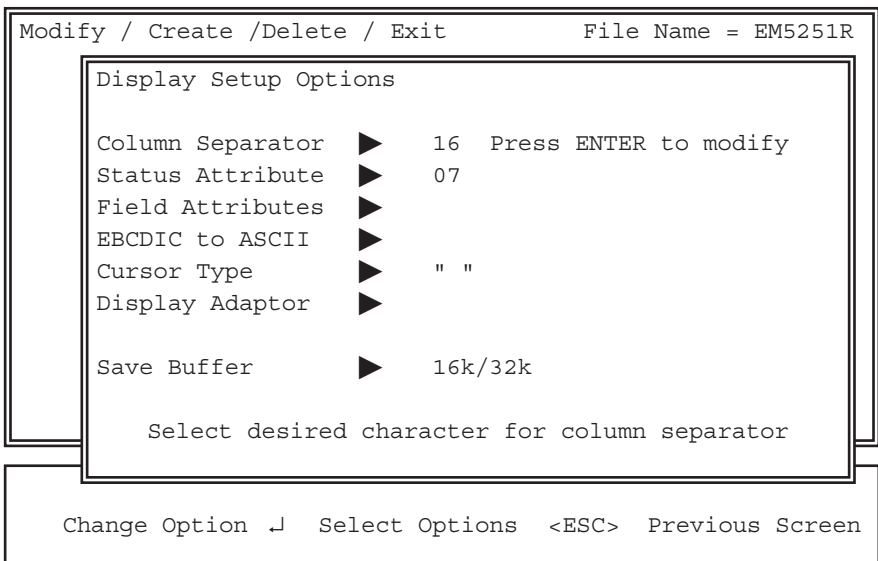

Figure 6-7. The Display-Setup Menu.

You can set these options under this menu:

- **Column Separator:** Use this option to change the column separator. Move the cursor to Column Separator and press [ENTER]. A window containing an ASCII-character table appears. Move the cursor around the table to highlight the character you want to be the column separator, then press the [ENTER] key to select the new character. The default character is hexadecimal 16, which is a straight horizontal line.

- **Status Attributes:** Use this option to define how the host system's status line is displayed on the PC screen. Move the cursor to Status Attributes and press [ENTER]. Type in the hexadecimal value corresponding to your desired display-line status attributes. (If your monitor is a monochrome model, you can find the list of possible values in Table 6-2; if your monitor is a color model, the possible values are listed in Table 6-3.)

NOTE

The value you enter here is for the first display session. If you're using a color monitor, the software automatically assigns each of the *following* sessions the correspondingly *preceding* character attribute. For example, if you select red text on a black background (hex value 04) for the first display session, the second session will have cyan text (03), the third session green text (02), and so on.

- **Field Attributes:** Host systems use field attributes to identify different field types on the display screen. For example, a warning or message field on the screen might be flashing red, while the normal screen fields might be green. You can customize these field colors to suit your tastes or applications. When you select the Field Attributes option, a window appears on the screen showing the current field attributes (see Figure 6-8 on the next page and Tables 6-1 through 6-3 on the following two pages).

```

Modify / Create /Delete / Exit           File Name = EM5251R

Least significant 5250 Attribute Digit (HEX)

  0  1  2  3  4  5  6  7  8  9  A  B  C  D  E  F
-----
2 | 02 20 07 70 0A 28 0F 00 04 40 84 C0 0C 48 8C 08
  |
3 | 03 30 06 60 0B 38 0E 00 05 50 01 10 0D 58 09 00
  |
-----

Enter 5250 Display Attribute code to be changed
<20 - 3F  00

Change Option  ↓  Select Options <ESC> Previous Screen

```

Figure 6-8. The Field Attributes Menu.

To change the field attributes at this screen, take these steps:

1. Find your desired IBM 5250 attribute in Table 6-1 on the next page. Type in the hex value for that field, then press **[ENTER]**. A “beep” will sound if you make an invalid choice.
 2. Find the attribute you wish to assign to this field in Table 6-2 (if you have a monochrome monitor) or 6-3 (if you have a color monitor) on page 39.
 3. Type in this value and press **[ENTER]**. Notice that the field assumes the attributes you’ve selected.
 4. Continue to change attributes until you’re finished, then follow the directions on the screen to exit.
- **EBCDIC to ASCII:** (This option is for advanced users only.) The character-code set used by the host (EBCDIC) is not compatible with that used by the PC (ASCII). To let both systems communicate, the 5250 Remote Emulator Card’s software uses an EBCDIC-to-ASCII translation table.
With this menu option, you can customize the table. For example, to force the “\$” character to display as a “#” character, move the cursor to the EBCDIC to ASCII option and press **[ENTER]**. The translation table will appear. Change the table by first entering the EBCDIC code for a “\$” character, which is **5B** (see **Appendix A** for EBCDIC and ASCII tables). Second, enter the ASCII code for the character to be displayed; in this case, the ASCII code for the “#” character is **23**.

NOTE

You might need to load a new code page into the PC for the desired character.

- **Cursor Type:** Use this option to customize your cursor. Choose between 1 (blinking block), 2 (blinking overline), 3 (no cursor) or 4 (blinking underline).
- **Display Adaptor:** Some monitors must change modes to display 132 columns, while other monitors may not support 132-column screens at all. If your monitor supports 132 columns, you must enter the “AL” value for the 132-column mode to enable 132-column display. (The AL value is listed in the video card’s manual as the MODE setting. For most cards, leave the “BL” value at 00.) Type in this value and press **[ENTER]**.

(text continues on page 43)

Table 6-1. IBM 5250 Field Attributes

Hex Value	Display
20	Normal display
21	Reverse image
22	High intensity
23	Reverse image, high intensity
24	Underscore
25	Reverse image, underscore
26	High intensity, underscore
27	No display
28	Blink
29	Reverse image, blink
2A	High intensity, blink
2B	Reverse image, high intensity, blink
2C	Underscore, blink
2D	Reverse image, underscore, blink
2E	High intensity, underscore, blink
2F	No display
30	Normal display, column separators
31	Reverse image, column separators
32	High intensity, column separators
33	Reverse image, high intensity, column separators
34	Underscore, column separators
35	Reverse image, underscore, column separators
36	High intensity, underscore, column separators
37	No display
38	Blink, column separators
39	Reverse image, blink, column separators
3A	High intensity, blink, column separators
3B	Reverse image, high intensity, blink, column separators
3C	Underscore, blink, column separators
3D	Reverse image, underscore, blink, column separators
3E	High intensity, underscore, blink, column separators
3F	No display

Table 6-2. Monochrome Field Attributes

Hex Value	Description
01	Normal, underscore
07	Normal
09	High intensity, underscore
0F	High intensity
70	Reverse image
81	Blink, underscore
87	Normal, blink
89	High intensity, blink, underscore
8F	High intensity, blink
F0	Reverse image, blink

Table 6-3. Color Field Attributes

1st Digit	Background	2nd Digit	Foreground
0	Black	0	Black
1	Blue	1	Blue
2	Green	2	Green
3	Cyan	3	Cyan
4	Red	4	Red
5	Magenta	5	Magenta
6	Brown	6	Brown
7	White	7	White
8	Black Blinking	8	Grey
9	Blue Blinking	9	Light Blue
A	Green Blinking	A	Light Green
B	Cyan Blinking	B	Light Cyan
C	Red Blinking	C	Light Red
D	Magenta Blinking	D	Light Magenta
E	Brown Blinking	E	Yellow
F	White Blinking	F	High-Intensity White

(text continued from page 40)

- **Save Buffer:** If you're going to use 132-column screens with DOS graphics applications, you'll need to allocate extra memory to make sure these screens are saved when you hotkey between sessions. Select 32K for 132-column screens used in DOS graphics applications, 16K for all other screens.

6.3.2 KEYBOARD SETUP

Use the Keyboard-Setup Menu, shown in Figure 6-9 below, to customize the keyboard. You can modify the hotkey, enable or disable the type-ahead, and modify scan codes.

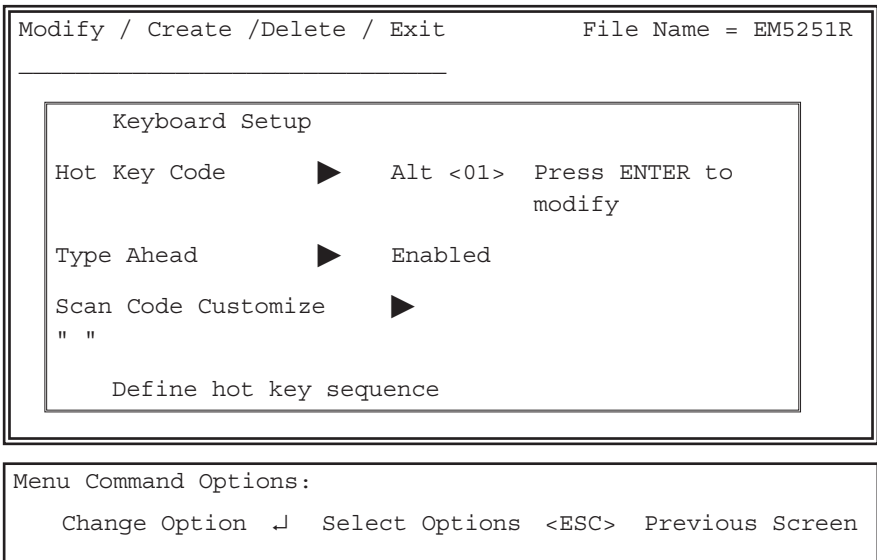

Figure 6-9. The Keyboard-Setup Menu.

- **Hot Key Code:** The Hot Key Code is the series of keystrokes used to jump from a DOS session to a host session. The default is **[ALT] [ESC]**. You can customize the hotkey code by pressing **[ENTER]** at this option. A new screen displaying the keyboard type will appear. Press the key you want to combine with **[ALT]** to form the hotkey, then press **[ENTER]**.

NOTE

If you plan to customize the hotkey, be aware that the emulator cannot use any keys whose scan codes are higher than 57.

NOTE

For Windows, change the hotkey to [ALT] [LEFT SHIFT]. This should be displayed as ALT <2A>.

- **Type Ahead:** When Type Ahead is enabled, the PC will hold characters in its buffer. If the host is not ready to accept the characters, the PC will send the characters to the host when it is ready for input.
- **Scan Code Customize:** The Scan Code Customize option lets you redefine how your keyboard's keys/characters are represented as numbers for transmission to the PC (and to the host during host sessions). Each type of keyboard uses different scan codes to represent its keys. The keyboard type you select is used on all host sessions during emulation. Factory-default scan codes are shown in **Appendix D**.

To change the keyboard scan codes, move the cursor to Scan Code Customize option and press [ENTER]. The screen then displays the keyboard layout. Follow the steps below to customize the keyboard:

1. Look at the keyboard layout, and determine the code of the key you want to change. At the prompt, below the keyboard layout, type in this code.
2. Press [ENTER] to display the key's function. In place of the prompt, the function of the key is displayed in the Normal mode (pressed alone), the Shifted mode (pressed with the [SHIFT] key), and the Alt mode (pressed with the [ALT] key). The key's Normal function is highlighted.
3. Use the up- and down-arrow keys ([↑] and [↓]) to highlight the mode you want to change. Press [ENTER]. A list of all the keys appears in a window at the right of the screen.
4. Use the arrow keys to highlight the function in this window to assign to this key. (Use the Page Up [Pg Up] and Page Down [Pg Dn] keys to bring different sets of functions into this window.) Press [ENTER]. The window at the right of the screen disappears, and the keyboard-layout screen reappears. The new function you've assigned appears under the chosen mode for the chosen key.

- Press **[ESC]** twice and you are prompted to save this keyboard file. Answer **Y** to save your changes or **N** to discard the changes. Press **[ENTER]** and then **[ESC]** to return to the Main Menu.

6.3.3 PRINTER SETUP

Use the Printer-Setup Menu (shown in Figure 6-10 below) to create a special or unique printer configuration.

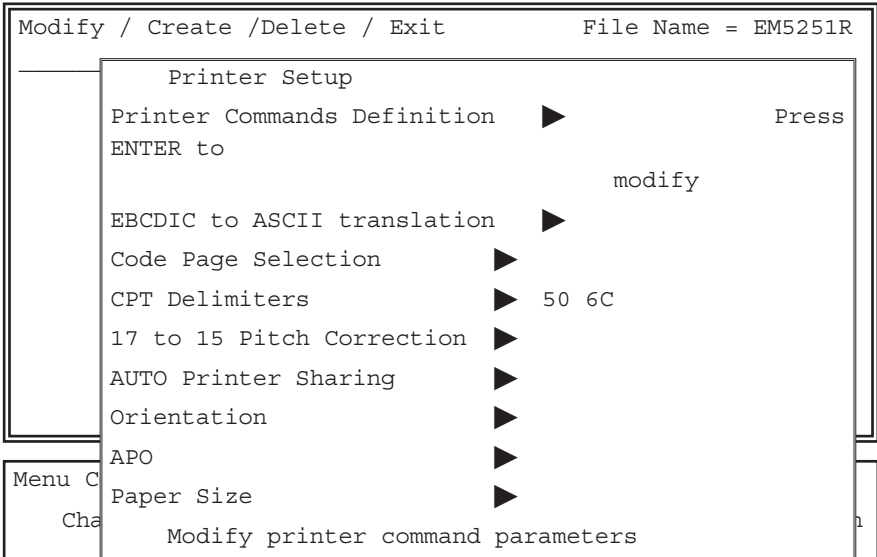

Figure 6-10. The Printer-Setup Menu.

- **Printer Commands Definition:** Use the Printer Commands Definition option to define a new printer or modify the command strings for an existing printer. (This is not valid for 5219 and 3812 printing.)

Press **[ENTER]** and type in the session number of the printer to be added or modified when you are prompted for it. A menu of command strings (something like what is shown in Table 6-4 on the next page) will appear. (If you choose a text-only printer, only half of this menu will be shown, ending with the “Begin NLQ” command for Near Letter Quality.)

Enter all command strings as sequences of two-digit hexadecimal control codes, preceded by a hexadecimal number indicating how long the sequence is.

Table 6-4. Programmable Command Strings

Command String	Function
Initialization string	Initialize printer
5 cpi	5 characters per inch
10 cpi	10 characters per inch
12 cpi	12 characters per inch
15 cpi	15 characters per inch
8 lpi	8 lines per inch
6 lpi	6 lines per inch
Begin draft string	Begin draft-quality printing
Begin NLQ string	Begin New Letter Quality (NLQ) printing
Vertical motion string	Used for vertical increments of the page
Increment (72, 60, 48)	The fraction of an inch used by the vertical motion string
Offset to variable data	Number of values before the variable data
Variable multiplier	Number multiplied to the variable to get the correct value
Page length string	Used to setup the page length
Offset to variable data used	Number of values before the variable data for the page length string
Length of variable data	Number of values for the variable data
Base to add to variable	Amount added to the variable data to get the correct value
Graphics command string	Sets the printer to accept graphics characters

For example, to set up an escape sequence for an HP® LaserJet® III, you would follow these steps:

1. Find the “6 lpi” control codes in the LaserJet manual.
2. If the manual doesn’t report these codes in hexadecimal, translate the decimal codes to hex using **Appendix B**.
3. The HP LaserJet “6 lpi” control codes are:

027	038	108	054	068	Decimal
1B	26	6C	36	44	Hexadecimal

Type in “05” to tell the software how many characters/codes long the sequence is, then type in the codes themselves, like this:

05	1B	26	6C	36	44
----	----	----	----	----	----

You don’t have to press **[ENTER]** when you finish; the software will automatically advance to the next line. Command-string sequences can be a maximum of fifteen (“0F”) characters/codes long.

- **EBCDIC to ASCII Translation:** (This option is for advanced users only.) The character-code set used by the host (EBCDIC) is not compatible with that used by the printer (ASCII). To allow both systems to communicate, the 5250 Remote Emulator Card’s software uses an EBCDIC-to-ASCII translation table.

With this menu option, you can customize the table. For example, to force the “\$” character to print as a “#” character, move the cursor to the EBCDIC to ASCII Translation option and press **[ENTER]**. The translation table will appear. Change the table by first entering the EBCDIC code for a “\$” character, which is **5B** (see **Appendix B** for EBCDIC and ASCII tables). Second, enter the ASCII code for the character to be displayed; in this case, the ASCII code for the “#” character is **23**.

- **Code Page Selection** (4214 only): The default code-page selection is Code Page 850. If the printer supports it, you can change to Code Page 437 by pressing **[ENTER]** at this field and selecting that page. Refer to the printer’s manual for information about the code page(s) the printer uses.

NOTE

When you change to Code Page 437, any changes made to the Code Page 850 character set will be lost, and vice versa.

- **CPT Delimiters:** The 5250 Remote Emulator Card’s “command pass-through” feature lets the Card recognize printer-control commands and transparently pass them through to the printer. A two-character delimiter (the default setting is “&%”) signals the card to pass the command through.

Select the new delimiter by typing the corresponding hexadecimal character codes (refer to **Appendix B**) in the spaces on the screen. See **Section 8.4.3** for more information on the command pass-through feature.

- **17 to 15 Pitch Correction:** Most PC printers do not support 15-pitch printing, but host systems use 15 pitch in many applications. If the printer supports 17 pitch and you would like to print 15 pitch, select this option by moving the cursor to the option and pressing [**ENTER**]. You will be prompted for the number of the printer session to modify.
Be aware that your printer might print very slowly in 15 pitch.
You can also be turn this option ON and OFF from the Printer-Control Screen (see **Section 7.6.1**).
- **Auto Printer Sharing:** When Auto Printer Sharing is enabled, you can print from either the host or the PC. Like pitch correction, you can turn this option ON and OFF from the Printer-Control Screen (see **Section 7.6.1**).

NOTE

DOS print jobs will only print during DOS sessions. If you hotkey to a host session while printing a DOS job, printing will be suspended until you return to the DOS session.

- **Orientation** (3812 only): Use this option to select the default print orientation. Your choices are Computer Output Reduction (COR), Portrait, or Landscape. You will be prompted for the number of the printer session to modify.
- **APO** (3812 only): Use this option to enable or disable Automatic Page Orientation. When enabled together with COR orientation (see the preceding paragraph), landscape orientation will be automatically selected if the page is wider than it is high. Portrait will be selected if the paper is higher than it is wide. (See **Section 8.2** for more information.) You will be prompted for the number of the printer session to modify.
- **Paper Size:** Use this option to select the size of paper used in the printer as follows:

Normal:	Letter size: 8.5 x 11 in. (216 x 280 mm) or Legal size: 8.5 x 14 in. (216 x 356 mm)
A4:	A4 size: 8.27 x 11.69 in. (210 x 297 mm)
No Size:	Whatever size is loaded in the printer

You will be prompted for the number of the printer session to modify.

6.4 PC Support/400

If PC Support/400 was selected for installation, the adapter-handler screen will appear (as shown in Figure 6-11 below) and will prompt you to enter the correct path for PC Support (this is required for PC Support/400 only).

NOTE

PC Support 400 must be installed as a twinax connection, not SDLC.

```

Modify / Create /Delete / Exit                               File Name =
_____

Configure PC Support/400 to use with EM5251R.

C:\PCS\STARTPCS.BAT

If PCS startup file is not at the default, please enter
correct path name. Press enter to continue, or press ESC
to abort PCS configuration.

Menu Command Options:
Change Option  ↵  Select Options  <ESC>  Previous Screen

```

Figure 6-11. The adapter-handler screen.

7. Operation

With the 5250 Remote Emulator Card installed and configured, host operations can begin.

7.1 Starting Emulation

To activate emulation between the PC and the host system, first vary on the line, controller, and devices on the host. Then follow the instructions in **Section 7.1.1, 7.1.2, or 7.1.3** as appropriate.

7.1.1 UNDER DOS

1. Change to the 5251R directory by typing **CD\5251R [ENTER]**.
2. Type **EM5251R [ENTER]**.

NOTE

If a new configuration file was created, add a space and the configuration file's name after "EM5251R".

A new screen/session appears; what type (a 3X emulation screen and session or a DOS prompt and session) depends on the startup option you chose during configuration. The 5250 Remote Emulator Card begins communicating with the host. Messages on the screen indicate the status of each session. The hotkey sequence between DOS and emulation applications is now available.

7.1.2 UNDER WINDOWS

Double-click on the **EM5251R** icon.

7.1.3 UNDER PC SUPPORT/38

NOTE

When you start emulation, do not specify a virtual source drive. Whenever you have to refer to the virtual source drive, use the letter designation of the virtual disk you specified in the Card's configuration program (see Section 6.2.2).

1. Create a hard-disk directory called "PCS38" by typing **MD PCS38**.
2. Start emulation by typing **EM5251** from the 5251R directory.
3. Hotkey to the S/38 signon screen and sign on.

4. Press [5] for the “execute command” option.
5. On the command line, type **ADDLIBLE QIWS**.
6. Press [3] for the “execute command” option.
7. Call **QIWDOWNL**.
8. Go to the copy screen, then hotkey to DOS.
9. Switch to your diskette drive and type **COPYLINK C:\PCS38**. (If your hard disk has a different letter designation, use that instead of **C:**.)
The program will begin to copy.
10. When the copying is complete, hotkey to emulation.
11. Execute [**CMD1**] (the “end” function) twice.
12. Sign off the PC.
13. Reboot the PC.
14. Start emulation.
15. Execute Link 38 from the PCS38 directory.

7.2 Emulation Procedures under Windows 3.X

7.2.1 EXITING EMULATION

To exit emulation, sign off all sessions, then use the hot key [**ALT**] [**SHIFT**] to go into DOS.

7.2.2 ENDING EMULATION

To end emulation, press [**CTRL**] [**C**].

7.2.3 RESTARTING EMULATION

To restart emulation, follow these steps:

1. Double-click on the **EM5251R** icon.
2. When the message appears, select [**C**] (continue).
3. If emulation does not start, double-click on the **EM5251R** icon for a second time. This will start emulation.

7.2.4 COPYING FROM EMULATION TO A DOCUMENT

To copy from emulation to a document, follow these steps:

1. Put the screen in a window by pressing **[ALT] [ENTER]**.
2. Bring up the System Menu by clicking on the system menu's "minus button"  located in the upper left-hand corner of the screen.
3. Select Edit.
4. Select Mark.
5. Using the mouse, mark the text to be copied.
6. Open the clipboard in Windows.
7. Open Display and select OEM text.
8. Go to the document where the paste will take place.
9. Select Paste.

7.2.5 COPYING FROM A DOCUMENT TO EMULATION

To copy from a document to emulation, follow these steps:

1. Cut the data using the normal sequence for the program.
2. Put the screen in a window by pressing **[ALT] [ENTER]**.
3. Put the cursor where the paste will take place.
4. Bring up the System Menu by clicking on the system menu's "minus button"  located in the upper left-hand corner of the screen.
5. Select Edit.
6. Select Paste.

7.3 Hotkey Sequences

7.3.1 OVERVIEW

Hotkey sequences are used to toggle from one session to another. For example, press and hold the **[ALT]** key and press the **[ESC]** key (or press the custom hotkey sequence you chose during the configuration—see **Section 6.3.2**) to move from a DOS session to a host session.

There are two major hotkey sequences, Direct Access and Round-Robin:

- **Direct Access:** This key sequence moves directly to a host session. (To be used, this sequence must be enabled during configuration—see **Section 6.2.2**.) For example, to move to host session 1, press and hold **[ALT]** and press **[1]**; to move to session 2, press and hold **[ALT]** and press **[2]**, etc. To return to DOS, press and hold **[ALT]** and press **[0]** or **[8]**. If an unconfigured session is pressed, the next available session will become active.

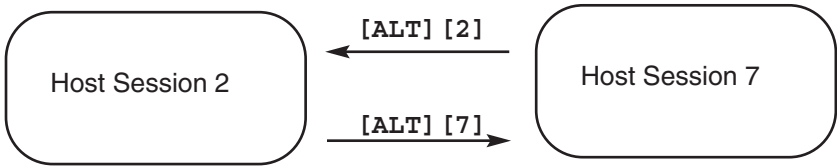

- **Round-Robin:** This key sequence moves sequentially through the available sessions as illustrated below. Starting at the current session, this sequence advances to the highest session and then to DOS. From DOS, this sequence continues back to the lowest session. (The printer-control screen is the printer session.) To use this method, press and hold **[ALT]** and press **[ESC]** (or the customized sequence—see **Section 6.3.2**).

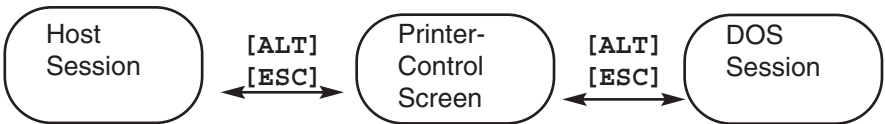

7.3.2 WINDOWS HOTKEY SEQUENCES

Different sequences allow you to jump between applications and sessions while in Windows.

- **Round-Robin (Scrolling) through Applications:** Starting at a currently active emulation, press **[ALT]** and then **[TAB]** to scroll through the active applications. This sequence advances to each of the currently active applications.



- **Round-Robin (Scrolling) through Sessions:** You can also scroll through active applications by pressing **[ALT] [SHIFT]**; you must press **[ENTER]** to activate the application. Also use **[ALT] [SHIFT]** (or the customized hotkey—see **Section 6.3.2**) instead of **[ALT] [ESC]** to change sessions while in an emulation window, as shown below; or use the direct-access sequences **[ALT] [1]**, **[ALT] [2]**, etc., as described in the previous section.

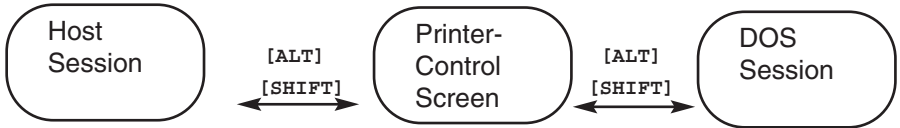

7.4 Status Line

During emulation, the bottom line of the screen is the session-status line. It displays information sent from the host, identifies which host address and session are currently being accessed, and highlights other information regarding the active sessions. See Table 7-1, below, for a list of the status-line abbreviations and their meanings. A status abbreviation is active when highlighted.

Table 7-1. Status-Line Abbreviations

Abbreviation	Meaning (When Highlighted)
<i>rr-cc</i>	CURSOR LOCATION (<i>rr</i> = row, <i>cc</i> = column): Identifies the cursor location by row and column.
SA	SYSTEM AVAILABLE: The host system is communicating with the active session.
MW _{<i>n</i>}	MESSAGE WAITING: A message from the host system is waiting for the active session. <i>n</i> is the number of the session the message is waiting for.
KS	KEYBOARD SHIFT: Keyboard shift is active.
IM	INSERT MODE: The LU session is in insert mode.
II	INPUT INHIBITED: Keyboard is locked, either because the host system has not completed a previous command, or there is a pending error condition.
KB	KEYBOARD BUFFERING: Highlighted when there are keystrokes waiting to be sent to the host.
S _{<i>n</i>}	LOGICAL UNIT: Where <i>n</i> is the active logical session or unit that is active.
A _{<i>n</i>}	HOST ADDRESS: Where <i>n</i> is the host address.

7.5 Printing

Printing from either DOS or host applications on the attached printer is a standard feature. To print from DOS, use either the DOS print command or print through a software program. When printing host jobs, specify the attached printer's host ID. This lets the host route the print job to the proper printer. The system operator will assign an ID to the attached printer when configuring the printer on the host.

7.5.1 THE PRINTER-CONTROL SCREEN

The Printer-Control Screen controls host printing sent to the attached printer. The PC is unaware that printing is taking place, even in a DOS session, host printing can continue without interruption. However, DOS printing does not continue in a host session.

Certain printer functions are controlled from the Printer-Control Screen. While in emulation, hotkey to the session assigned to the printer. The Printer-Control Screen will appear; it's divided into three (3) sections, as shown in Table 7-2 on the next page and described on pages 57 through 59.

Table 7-2. Layout of the Printer-Control Screen

1 Options F1 F2 F3 F4 F5 F6 F7 F8 F9 F10 Shift F1	Start/Stop Printer Truncate/Wrap-around Line Feed Form Feed Cancel Print Job User Override of Pitch, Quality, etc. Host Control of Pitch, Quality, etc. Re-Initialize Printer Buffer Print Assign Printer to DOS/Host/Auto 17 to 15 Pitch Correction
2 Printer is attached to: Host Status Ready System Available	Host DOS Auto Format Controls PC Printer User Override Active Selected Host Control Active Paper Out Buffer Print Mode Busy Truncate Fault 17 to 15 Pitch Fix Check Printer
3	Session: 5XX6XXX

1 To select any of the functions in Section 1, press the indicated function key. See Table 7-3 below for a description of these functions.

Table 7-3. Printer Commands

Command	Printer Function
F1	START/STOP: Press [F1] to start or stop the printer.
F2	TRUNCATE/WRAP-AROUND: In truncate mode, narrow-carriage printers ignore data beyond 8" (80 columns). In wrap mode, the data prints on the next line.
F3	LINE FEED: Each time the [F3] key is pressed, the paper in the printer will advance one line.
F4	FORM FEED: The paper advances to the top of the next page and resets the line and column counts to one.
F5	CANCEL PRINTER JOB: Sends a cancel request to the System/3X host. This will not cancel data already in the printer buffer.
F6	USER CONTROL OF PITCH, PRINT QUALITY AND LINE SPACING: Defines the pitch, printer quality and line spacing for the attached PC printer. Host commands which alter these values are ignored.
F7	HOST CONTROL OF PITCH, PRINT QUALITY AND LINE SPACING: With this enabled, host commands control pitch, print quality, and line spacing.
F8	RE-INITIALIZE PRINTER: Returns to the original printer configuration.
F9	BUFFER PRINT: Prints host commands for diagnostics. This is referred to as a "hex dump."
F10	ASSIGN PRINTER TO DOS/HOST/AUTO: Prints only DOS jobs when <u>DOS</u> is highlighted, only host jobs when <u>Host</u> is highlighted, or automatically selects from host or DOS when <u>Auto</u> is highlighted.
Shift F1	Shifts from 17- to 15-pitch printing (5219 and 3812 emulations do not support this function). Only affects dot-matrix printers.

2 Section 2 of the Printer-Control Screen shows host- and PC-printer status. These indicators highlight important information regarding the printer's status when it is assigned to either the host or the PC. For descriptions of these messages, see the "Printer is attached to" paragraph below, Table 7-4 below, and Table 7-5 on the next page.

Printer is attached to: Indicates which system is in control of the printer: the host, DOS, or auto. When Host is highlighted, print jobs can be sent from the host to the PC printer. When DOS is highlighted, the printer will not accept print jobs from the host, but a PC print job can print. When Auto is highlighted, the 5250 Remote Emulator Card automatically switches from host to PC printing and vice versa without going back to the printer-control screen (although DOS print jobs will print only during a DOS session). The screen will highlight the current setting of this option in reverse video.

Table 7-4. Indicators of Host-Printer Status

Status Message	Indicated Condition (When Highlighted)
READY	The printer is ready to receive data.
SYSTEM AVAILABLE	The host system is operational.
CHECK PRINTER	An error condition, such as a paper jam or out of paper, has been detected by the printer.
USER OVERRIDE ACTIVE	Host commands for pitch, print quality, and line spacing are ignored (the F6 command).
HOST CONTROL ACTIVE	Host commands for pitch, print quality, and line spacing are active (the F7 command).
BUFFER PRINT MODE	The printer is in buffer-print mode (the F9 command). Also known as a "hex dump."
TRUNCATE	Truncate mode is active (the F2 command).
17 TO 15 PITCH FIX	17- to 15-pitch correction is active (the Shift F1 command).

Table 7-5. Indicators of PC-Printer Status

Status Message	Indicated Condition (When Highlighted)
SELECT (parallel printer) or PRINTER READY (serial printer)	Printer is powered ON and ready to receive data.
PAPER OUT	Parallel printer only: Printer is out of paper. Load paper before continuing.
BUSY	Parallel printer only: Printer is processing data.
FAULT	Parallel printer only: Indicates a problem with the printer such as paper jam, out of paper, hardware failure, etc.
CHECK PRINTER	A general indicator that operator intervention is required for the printer.

3 Section 3 of the Printer-Control Screen shows the active display session, displayed in reverse video, and the status of all the sessions on the host. Numbers are session addresses; “X” is displayed for sessions that are not active.

7.5.2 THE PRINTER-OVERRIDE SCREEN

When you press [**F6**] at the Printer-Control Screen (User Override of CPI, LPI, and Quality), the Printer-Override Screen appears (see Table 7-6 below). This screen lets you “override” or change settings for the printer when you print host-print jobs. While User Override is active, host commands are ignored and the choices shown on this screen control the printing. (PC-print jobs can’t be controlled from this screen.)

Select any of the printer controls by pressing the function key shown to the left of the control description. The printer must be in a ready state for selections to take effect. If the printer is not ready, a message appears and the selection does not take effect.

Table 7-6. The Printer-Override (Emulation Control) Screen

Options	F1	Set Printer to 10 CPI
	F2	Set Printer to 12 CPI
	F3	Set Printer to 15 CPI
	F4	Set Printer to 6 LPI
	F5	Set Printer to 8 LPI
	F6	Set Printer to DRAFT
	F7	Set Printer to NLQ
	F8	
	F9	Return to Main Menu
	F10	
	Shift F1	
	[ALT][ESC]	Hot Key to Next Session
Printer is attached to:	Host DOS Auto	
Host Status	Format Controls	PC Printer
Ready	User Override Active	Selected
System Available	Host Control Active	Paper Out
	Buffer Print Mode	Busy
	Truncate	Fault
	17 to 15 Pitch Fix	Check Printer
Session: 5XX6XXX		

7.6 Ending Emulation

7.6.1 UNDER DOS

After finishing the work in the host sessions, log off each active display session. At a sign-on screen, press **[CTRL] [ALT] [DEL]** to end emulation and return to DOS.

7.6.2 UNDER WINDOWS

After finishing the work in the host sessions, log off each active display session. Hotkey to the DOS portion of the window. Press **[CTRL] [C]** to end the Windows session.

8. Advanced Features

The 5250 Remote Emulator Card has some unique features that come in handy with certain applications that require extra productivity tools. These added features include Record/Playback, 3812 printer emulations, 5219 printer emulations, a special command language, and command pass-through.

8.1 Record/Playback

With the Record/Playback feature, you can record a sequence of keystrokes and play them back later by pressing only three keys, which cuts down on repetition.

Use these keys to control the Record/Playback feature:

Keystroke	Function
------------------	-----------------

[ALT] [F10]	Record a sequence of keystrokes (functions as the <Record> key on a 5250 keyboard)
--------------------	--

[ALT] [F8]	Playback a sequence of keystrokes (functions as the <Play> key on a 5250 keyboard)
-------------------	--

[ALT] [F7]	Delete a recorded keystroke sequence
-------------------	--------------------------------------

[ALT] [F9]	Clear all recorded keystroke sequences
-------------------	--

8.1.1 RECORDING A SEQUENCE

To record a keystroke sequence, follow these steps:

1. Press and hold the **[ALT]** key, then press **[F10]** to enter Record mode. A blinking **R** appears in the lower left-hand corner of the screen. The number to the right of the blinking **R** is the number of keystrokes available for recording (maximum of 1,000).
2. Press the key (any of **[F1]** through **[F10]** or **[0]** through **[9]**) to assign as the “trigger key” for the recorded sequence. (You might want to write down each “trigger key” and its associated sequence in the **NOTES** pages at the end of this manual.)
3. Type the keystroke sequence to be recorded.
4. When the keystroke sequence is completed, press **[ALT] [F10]** again to save the sequence and exit the Record mode.

5. To permanently save a recorded sequence to the PC's hard disk, hotkey to DOS, then go to the drive and directory where the 5250 Remote Emulator Card's software is stored. Type **SAVEKEYS** and press **[ENTER]**. A message will appear indicating that the recorded keys have been saved. (Each time you start emulation, SAVEKEYS.DAT will be loaded so the saved keystroke sequences can be used.)

8.1.2 PLAYING A RECORDED SEQUENCE

Follow these steps to play back a recorded sequence:

1. Press **[ALT] [F8]** to enter Play mode. A blinking **P** appears in the lower left-hand corner of the screen.
2. Press the "trigger key" (any of **[F1]** through **[F10]** or **[0]** through **[9]**) assigned to the recorded sequence you want to play back.
3. The playback begins at the cursor location. When it ends, Play mode is automatically exited.

8.1.3 DELETING A SEQUENCE

To delete a recorded sequence, press **[ALT] [F7]**. A blinking **D** appears in the lower left-hand corner of the screen. Press the "trigger key" (any of **[F1]** through **[F10]** or **[0]** through **[9]**) assigned to the recorded sequence you want to delete, and the sequence will be deleted.

8.1.4 CLEARING ALL SEQUENCES

To clear all currently recorded keystroke sequences, press **[ALT] [F9]**. A prompt in the lower left-hand corner of the screen asks, "Clear All (Y/N)?" To clear all the recorded sequences, press **Y**.

8.2 3812 Printer Emulation

The 5250 Remote Emulator Card lets a local (attached to the PC) laser printer that supports HP or PPDS modes emulate the IBM 3812 (non-IPDS) printer. The 3812 printer provides font-changing capability, text rotation, compression features called Computer Output Reduction (COR), and Automatic Page Orientation (APO). The 5250 Remote Emulator Card's 3812 printer emulation provides font changes and a true 3812 COR emulation. It also obeys host commands for duplexing like the IBM 3816 printer.

The system operator will specify a default font ID when configuring the 3812 address on the host system. The default font ID should be the most commonly used typestyle. The system operator should select one of the typestyle numbers from the Typestyle Reference Chart in **Appendix C** with an asterisk (*) indicating the default font ID, then change it in the document, as necessary.

8.2.1 DATA PROCESSING

To change font IDs for a data-processing report, add the font number to the CL or OCL printer statement (for the System/36, convert the font number to hexadecimal before adding it to the printer statement). Only the font IDs marked with an asterisk (*) in the Typestyle Reference Chart in **Appendix C** can be used in host-printer statements.

The 3812's COR feature rotates data-processing reports to landscape orientation and compresses the text to fit 198 columns x 66 lines on the page. The steps below describe printing using the COR feature. Refer to Figure 8-1 on **page 66**.

1. If a Set Text Orientation (STO) command is specified, the report prints using the STO command to control orientation in the specified font. If an STO command is not specified, the report continues to block 2.
2. If APO is enabled (see **Section 6.3.3**), the report continues to block 3. With APO disabled, the report continues to block 4.
3. At block 3, the page size is calculated. If the page size is valid (8 1/2" x 14" or smaller) the report continues to block 6; the report prints at block 6 depending upon the page layout. An invalid page size (larger than 8 1/2" x 14") causes the report to continue to block 4.
4. At block 4, the orientation selected in the configuration program determines the output. If landscape is selected, the report prints in landscape using the specified font. If portrait is selected, the report prints in portrait using the specified font.
5. A COR override from the host determines the report orientation. Host COR overrides include:
 - System/36 OCL: Text-Yes or Rotate-0
 - System/38 CL: PRT QLTY (*STD) or (*NLQ), or PGRTT(0)
 - AS/400: PRT QLTY (*STD) or (*NLQ) and PAGRTT (*COR)

A host COR override causes the report to print in portrait with the selected font. If the host does not override the COR, the report prints in landscape orientation with the CPI and LPI reduced as shown in Figure 8-1.

The printer prints a maximum of 182 columns x 64 lines (IBM PPDS mode) or 198 columns x 66 lines (HP mode) when you use COR to control the output.

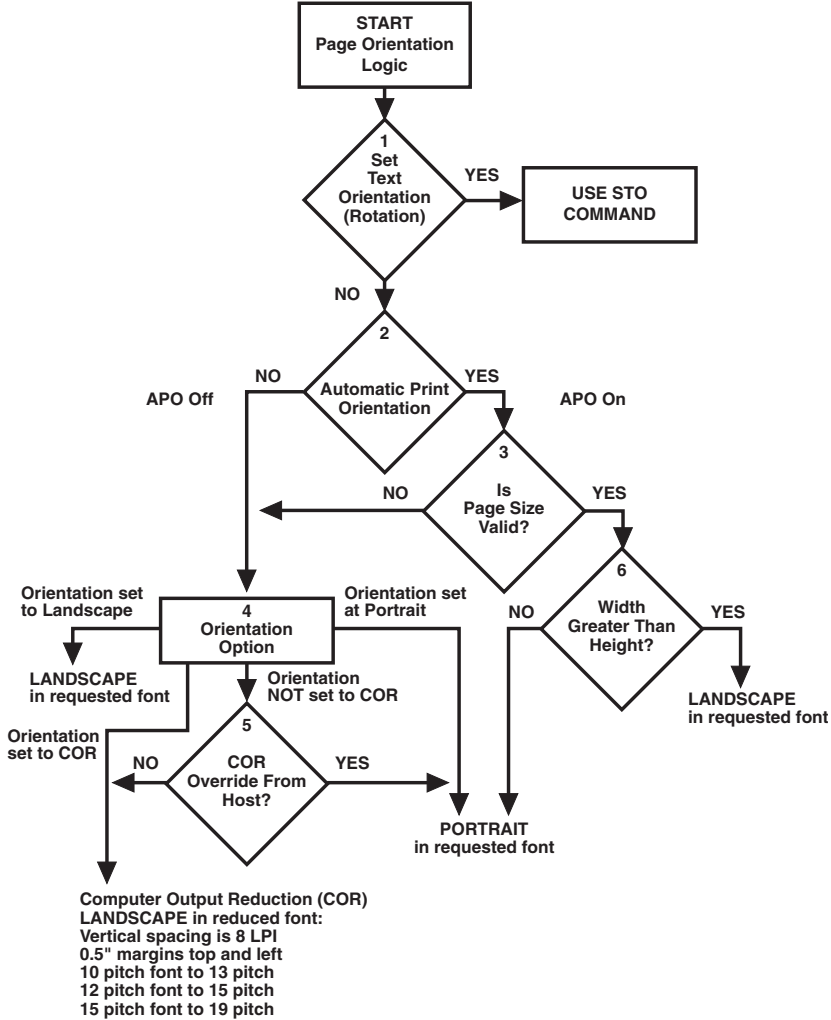

Figure 8-1. The decision-making process for page orientation.

8.2.2 WORD PROCESSING

When the system operator configures the printer on the host, a default font ID is configured for the printer, which should be the most commonly used font. The WP program may also have a default font ID. Since the default font ID can vary depending on the system setup, ask your system operator if you have questions about the default font ID.

To change the font, either use the font-change commands in the Card's command language, or select a font ID number within the word processing program. Refer to the WP program's manual for information on changing font IDs within the program. See **Section 8.4.3** for information on font-change commands for word-processing documents.

The 5250 Remote Emulator Card allows bolding, underlining, and super/subscripting by recognizing the host commands for these features in both WP and DP applications. The 5250 Remote Emulator Card uses a shadow print for bolding, even on small and italic fonts.

8.2.3 PAGE LENGTH

The printer prints up to 66 lines at 6 LPI in HP mode (the line spacing may be compressed slightly to fit), or 64 lines at 6 LPI in IBM PPDS mode, on each page of 8.5" x 11" letter-size paper. The System/36 only allows 65 lines per page on 8.5" x 11" letter-size paper.

The printer prints up to 72 lines at 6 LPI in HP mode (the line spacing may be slightly compressed to fit) or 70 lines at 6 LPI in IBM PPDS mode on each page of 8.27" x 11.69" A4 size paper.

8.2.4 PAPER SIZE

Configure the printer setup on Card for the paper size used most. The Card only recognizes these paper sizes:

Letter Paper: 8.5" x 11" (216 x 280 mm)

Legal Paper: 8.5" x 14" (216 x 356 mm)

A4 Paper: 8.27" x 11.69" (210 x 297 mm)

If you choose any other paper dimensions in the word-processing program, the 5250 Remote Emulator Card ignores them and uses the previous paper-size choice. The "No Paper Size" selection uses the paper installed in the tray, regardless of the paper's size.

8.2.5 BIN SELECTION

The 5250 Remote Emulator Card selects paper from bin 2 only if the optional paper tray is installed in the printer. If bin 2 or 3 is chosen in a host document, the printer will print from bin 1 unless the optional paper tray is installed.

8.2.6 DUPLEX PRINTING

The AS/400 will only recognize duplexing in word processing. To access duplexing in data processing, type one of these commands from the Card's command language into the first line of the document.

- D0 for simplex printing
- D1 for landscape duplex printing
- D2 for portrait duplex printing

Refer to **Section 8.3.6** for more information.

8.2.7 DOCUMENT/ENVELOPE PRINTING

Print a letter and an envelope from DisplayWrite/36 or AS/400 Office in the same document by following this procedure:

1. Set the format for the letter, and enter the letter file. On the first typing line, press [**CMD20**] for "Change Format."
2. Select 1 for "Entire Document Options."
3. Select 1 for "Document Format."
4. Select 3 for "Typestyle/Color," type in the font ID Number for the letter (such as No. **11**, **86**, etc.), then press [**ENTER**].
5. From the Document Format screen, select option 4 for "Page Layout/Paper Options." Scroll to the second screen of these options and select a paper size and a paper source. If the letter is more than one page, select the same paper source for the following pages. Press [**ENTER**] to return to the Document Format screen.
6. Press [**CMD12**] to return to the Document Options screen.
7. You can now set up the alternate format for the envelope. Select 2 for "Alternate Format."
8. Select 3 for "Typestyle/Color." Type in a font ID for the envelope, such as **5**, and press [**ENTER**] to return to the Alternate Format screen.
9. Select 4, "Page Layout/Paper Options." Type in a "first typing line" of **11**, then scroll down to the second screen of the options; choose a paper width of **7.5** (monarch size) or **9.5** (commercial, #10 size) and a paper length of **4** inches.

10. For a paper source, select 5 for “Envelope Feed.” Press [**ENTER**] to return to the Alternate Format screen.
11. Select option 1 for “Margins and Tabs” and type in a left margin of **40**. Press [**ENTER**].
12. Press [**CMD3**] to return to the document.
13. Type in the text. When you finish, add in a “page end” by pressing [**ALT**] [**P**].
14. Now load in the alternate format for the envelope. To do this, press the [**CMD5**] key, “Goto,” and type “rf” (Resetting Format). Press [**ENTER**].
15. Select option 4 on the Alternate Format screen, “Begin Alternate Format.” Press [**ENTER**].
16. The document will now be displayed with the alternate format. The cursor will be on the first typing line with a left margin of 40.
17. Type in the envelope address and send the file to print. The letter will print out first, then the envelope.

NOTE

The printer may eject a blank page when changing printing orientation. If the Buffer light and Ready light remain steady, press the Print/Check button on the printer's operator panel to eject the last page.

The System/38 only sends margins and other format specifications to a printer when they are different from the previous documents or when the printer has been turned OFF. To choose a different paper size:

1. Select a paper size in the program.
2. Insert paper of the correct size into the printer.
3. Power the printer OFF for about five seconds, then power it back ON again.
4. Release the job for printing from the host.

8.3 5219 Printer Emulation

The 5250 Remote Emulator Card's 5219 emulation is for LaserJet printers. The HP LaserJet printer file is automatically used when 5219 emulation is selected.

The 5250 Remote Emulator Card allows bolding, underlining, and super/subscript by recognizing the host commands for these features for DP or WP applications. The different character styles and pitch are controlled through the IBM typestyle number or font ID. The 5250 Remote Emulator Card uses the IBM typestyle number to select an HP font from a cartridge. The cartridges shown in the Typestyle Reference Chart in **Appendix C** are the only fonts supported.

The system operator will specify a default font ID when configuring the 5219 on the host system, which should be the font ID most commonly used. Select one of the font-ID numbers from the Typestyle Reference Chart in **Appendix C** with an asterisk (*) indicating the default font ID, then change it as necessary in the DP or WP document.

If data-processing reports are sent to the printer, typestyles in the printer's CL or OCL statement must be changed.

8.3.1 DATA PROCESSING

Condensed print and "8 lpi" commands do not work in data-processing documents, because 5219 printers only understand font-ID commands.

For DP documents, such as RPG-generated printouts, the Card uses the system-default typestyle unless you change the fonts by specifying the typestyle in the OCL or CL printer statement. Since the host only accepts certain fonts in OCL and CL statements, you can use only the font IDs marked with an asterisk (*) from the Typestyle Reference Chart in **Appendix C**.

To change typestyles in DisplayWrite/36, use one of the following commands:

[CMD20], selection No. 1, "Document Option"

[CMD20], selection No. 4, "Display Current Format"

[CMD9], selection No. 7, "Change Font"

See the DisplayWrite® user's guide for more information on changing typestyles.

8.3.2 WORD PROCESSING

When you configure a 5219 address on the host, you must select a default font ID. The normal value is 11 (or 0B in hex), which is a 10-pitch font.

There are two ways to change fonts for word-processing documents: either select a typestyle within the word-processing program or use a font-change command from the Card's command language in the document. The word-processing program's manual should describe how to change the typestyles within the program.

Some word-processing programs, such as Text Management/38, do not allow more than one typestyle number per line of text. In such cases, use the font-change commands in the Card's command language (see **Section 8.4.1**).

8.3.3 PAGE LENGTH

The 5219 emulation allows 65 lines per page at 6 LPI for word-processing documents and 66 lines per page at 6 LPI for data-processing documents. The HP LaserJet printer allows a maximum of 63 lines per page at 6 LPI. To print 65 lines, the 5250 Remote Emulator Card increases line spacing from 6 lines per inch to about 6.25 lines per inch. This small change is normally not noticeable. A similar small change is made to 8-LPI printing on 8.5" x 11" letter size paper.

The printer prints up to 72 lines at 6 LPI in HP mode (the line spacing may be slightly compressed to fit), or 70 lines at 6 LPI in IBM mode, on each page of 8.27" x 11.69" A4 size paper.

8.3.4 PAPER SIZE

Configure the printer setup on the Card for the paper size used most. The Card only recognizes these paper sizes:

Letter Paper: 8.5" x 11" (216 x 280 mm)

Legal Paper: 8.5" x 14" (216 x 356 mm)

A4 Paper: 8.27" x 11.69" (210 x 297 mm)

If you choose any other paper dimensions in the word-processing program, the 5250 Remote Emulator Card ignores them and uses the previous paper-size choice. The "No Paper Size" selection uses the paper installed in the tray, regardless of the paper's size.

Selecting legal or A4 size paper dimensions on the DisplayWrite/36 "Change Page Format" screen causes the LaserJet display window to flash "Legal Paper." If the paper dimensions specified are different from letter, legal, or A4, the paper size is unchanged.

In Text Management/38, the System/38 does not send paper dimensions to the printer. Instead, it sends a forms message for legal paper to the controlling workstation assigned to the printer. To change the paper tray, take these steps:

1. Insert a paper tray of the proper size and press the printer's RESET button.
2. Power the printer OFF and back ON.
3. Release the print job at the host.

The System/38 uses a "Printer Support Facility" that sends the margins and other document-form specifications to a printer only when these are different from the previous document or when the printer has been turned OFF. Either way, the LaserJet must be reset when a different paper tray is installed.

The line-format screens in DisplayWrite/36 (Command 20) also permit "Justify," which aligns the right margin. "One-Half Justify" causes only one-half as much alignment of the right margin. For best results in using justification, change the zone width from "6" to "1."

8.3.5 ENVELOPE PRINTING

To print envelopes, specify typestyle number 5, landscape orientation, with the first line of the address on line 30 and a left margin of 55. A trial run with a blank sheet of paper will often help identify an error in positioning the address.

Manual Feed: Select the "Envelope Feed" option in the word-processing program's paper-feed selections and a paper size of 11" x 11". The printer will flash "Manual Feed" on the front-panel display window. Manually feed the envelope into the printer.

Envelope Tray: Select "Envelope Feed" and a paper size of 7.5" or 9.5" (or 22 cm). The printer automatically finds the envelope tray (if this has been installed) and prints the envelope.

Envelope Feeder: Select "Envelope Feed" and a paper width of 7.5" or 9.5" (or 22 cm). The printer automatically finds the envelope feeder (if this has been installed) and prints the envelope.

NOTE

The LaserJet may eject a blank page when you change print orientation.

8.3.6 DUPLEX PRINTING

Some LaserJet models can print both simplex (single sided) and duplex (double sided); for that matter, they can print both long-edge (landscape) and short-edge (portrait) duplex. However, changing the printer's simplex/ duplex mode through its front panel can be time consuming. Instead, place printing commands on the first line of the document to control simplex, landscape-duplex, and portrait-duplex printing. Enter one

of these commands from the Card's command language on the first line of the document:

- D0 for simplex printing
- D1 for landscape-duplex printing
- D2 for portrait-duplex printing

If they are not on the first line, the commands will not become active until the following page. When the printer receives the printing command, it will do all printing in that mode until another printing command is received. In other words, if the printer is most often in simplex mode and is printing in the duplex mode, be sure to put a simplex command at the end of the document to return the printer to simplex mode. Envelope printing between documents won't change the printer's mode.

On some duplex printing, if the last page is blank on the back side, the information for the last page may remain in the printer until the next printing job is received. To print the last page, take the printer off-line by pressing the ONLINE button, then press the FORM FEED button to print the last page. Put the printer back on-line by pressing the ONLINE button again.

NOTE

Duplexing is supported in word-processing applications on the AS/400, but the AS/400 does not support duplex printing for data processing.

8.4 The Command Language

The 5250 Remote Emulator Card responds to a command language that consists of special character sequences you can place in your documents. The Card recognizes these sequences and sends corresponding codes to the printer to control the printer's output. You can use these commands in either data-processing or word-processing documents.

The Card's command language consists of three types of commands: font-change commands, escape commands, and command-pass-through commands. These are described in the next three sections.

8.4.1 FONT-CHANGE COMMANDS

To change fonts using font-change commands, type the font-change command into the document at the place where the font change is to take effect. The command is immediately active in the document; the Card prints the specified font until it encounters the next font-change command.

For example, when the ProCollection® cartridge is loaded in the printer, the codes embedded in the following sentence will cause the word “saves” to print in bold Helvetica® instead of plain Courier:

On screen: Quality -Q45 saves -Q85 you time and money.

Prints as: Quality **saves** you time and money.

NOTE

The host may send the original font code to the printer at the beginning of each page. If this happens, put a font-change command at the beginning of each page of the document.

If the font-change command changes the pitch, the host may continue to format each line with the original font-ID pitch. Text Management/38 and some other word-processing programs don't let you specify more than one font ID per line.

Font IDs and font-change commands for the fonts and font cartridges used by the 3812 and 5219 printer emulations are listed in **Appendix C**.

Format font-change commands this way:

- **3812 Printer Emulation:** Enter font-change commands for 3812 emulation using the format **-Qn**, where **¬** is a “logical not” (Shift 6), **Q** indicates a font change, and **n** is the typestyle number (font ID).
- **5219 Printer Emulation:** Enter either of two types of font-change commands that you can use with 5219 emulation:
 - **-QHL** selects fonts from HP font cartridges: **¬** is a “logical not” (Shift 6), **Q** indicates a font change, **H** indicates the HP font cartridge, and **L** is one or more uppercase letters that indicate a particular font in the cartridge;
 - **-QIn** selects fonts from IBM font cartridges: **¬** is a “logical not” (Shift 6), **Q** indicates a font change, **I** indicates the IBM font cartridge, and **n** is the typestyle number (font ID).

8.4.2 ESCAPE COMMANDS

You can also insert commands into your document that perform other functions, such as enabling true 6-LPI printing, causing the Card to ignore format commands from the host, and sending the printer an ASCII ESC command. These commands, shown below, are similar to the font-change commands.

Command	Function
¬Ex	Sends an ASCII ESC command to the printer (HP mode only).
¬TY	Forces true 6-LPI printing (HP mode only).
¬TN	Stops forcing true 6-LPI printing (HP mode only).
¬I	Makes Card ignore all formatting commands from the host.
¬S	Makes Card stop ignoring formatting commands from the host.

You can send an ESC (escape) print-control command to the printer with the **¬Ex** command (HP mode only); **x** stands for a sequence of characters that forms the rest of the command. For example, **¬E(s3B** would begin bold printing; see an HP operator's manual for a list of the **(sXX** commands.

When in HP mode, the printer may compress line spacing to fit 66 lines onto a page. This might be undesirable at times, especially with preprinted forms that must align correctly. In these cases, the **¬TY** command prevents the printer from compressing the line spacing, and **¬TN** permits it again.

Use the **¬I** and **¬S** commands to remove unwanted host commands from a print file. For example, when you print with forms-generating software, the host recognizes the files as text files and formats them with unwanted carriage returns and line feeds. Placing the **¬I** at the end of a line and **¬S** at the start of the next line causes the 5250 Remote Emulator Card to remove the host's carriage returns and line feeds and send only the data to the printer.

8.4.3 COMMAND PASS-THROUGH

The command-pass-through (hex-transparency) feature gives you access to all of a printer's built-in features, even if these features are not normally available through the host software. With the command-pass-through feature, you can place printer-specific command sequences into your document, and the 5250 Remote Emulator Card will recognize the sequences and "pass the commands through" to the printer. Take these steps to use this feature:.

1. Find the command (control codes) for your desired print feature in the printer's manual.
2. Convert the control codes to hexadecimal.
3. Type the delimiter **&%** (or any custom delimiter configured as described in **Section 6.3.3**) into the document at the point in the text

where the feature is to take effect. Type in the “turn feature ON” printer command, then type in the delimiter again. No spaces are allowed.

4. Move the cursor to the point in the text that you want to end the print feature. Type in the delimiter, followed by the “turn feature OFF” printer command, and then the delimiter again. Again, no spaces are allowed.

For example: If **[ESC] [E]** turns bold printing ON and **[ESC] [F]** turns bold printing OFF, first convert **[ESC] [E]** to the hexadecimal 1B45 (**[ESC]** = “1B” and **[E]** = “45”) and **[ESC] [F]** to 1B46. Then insert the commands into the text like this:

This is a &%1B45&%bold&%1B46&% word.

The above sentence will print on the printer as:

This is a **bold** word.

NOTES

Spaces are not allowed between the delimiter and the hex code.

Only hexadecimal digits (the numbers 0 through 9 and the letters A through F) may appear between delimiters.

Errors in the command-pass-through sequence will cause the 5250 Remote Emulator Card to ignore the command and resume printing at the point the error occurred.

Command pass-through may invalidate horizontal spacing.

9. Troubleshooting

The 5250 Remote Emulator Card is designed for easy installation and reliable operation. However, as with all electronic equipment, difficulties can arise. This chapter is intended to help you diagnose and solve these problems.

When trouble does crop up, the cause frequently turns out to be host configuration, emulator configuration, or modem settings. The devices emulated by the 5250 Remote Emulator Card must be recognized by the host, so make certain the configuration of the emulation software matches that of the host. Make sure the modem settings match the type of network the emulator is operating with. If this doesn't solve the problem, take these steps:

1. Verify that all of the installation steps have been completed (see **Chapters 4 and 5**).
2. Run the Card's diagnostic program.
3. Write down any error messages displayed or strange system-operating quirks you observe.
4. Try to find the problem and its solution in **Sections 9.1 through 9.3**.
5. If you're still stuck, contact your supplier. Go to **Section 9.4**.

9.1 Common Concerns

PC does not power ON.

- | | |
|----------------|---|
| Cause: | Power cord not plugged in. |
| Action: | Make sure the power cord is plugged into both the power outlet and the back of the PC. |
| Cause: | Faulty cord or power outlet. |
| Action: | Try another cord or outlet. |
| Cause: | No power connections inside PC. |
| Action: | Check power connections inside the PC that might have been disconnected during installation of the 5250 Remote Emulator Card. |

Graphics characters or blinking characters appear on the screen.

- Cause:** 5250 Remote Emulator Card not seated properly.
Action: Unplug the PC, open it, and check the installation of the 5250 Remote Emulator Card.
- Cause:** I/O-address conflict.
Action: Check the addresses of all other cards in the PC (referring to those cards' manuals if necessary). If one of the other cards is using the same address as the 5250 Remote Emulator Card, you must change one of the two cards' addresses.
- Cause:** Cable-address conflict.
Action: Make sure the cable-address settings on the host and in the 5250 Remote Emulator Card's software match (see **Section 6.2.1**).

Improper keystrokes or no keystrokes appear on the screen.

- Cause:** PC's keyboard loose or unplugged.
Action: Make sure the keyboard cable is tightly connected at both ends.
- Cause:** Host inhibited.
Action: Check the **II** indicator on the host session's status line.
- Cause:** Wrong keyboard emulation.
Action: Make sure the right keyboard emulation (PC or 5250) is selected in the 5250 Remote Emulator Card's configuration (see **Section 6.2.2**).

Cursor appears at the top left corner of the screen when emulation starts.

- Cause:** Invalid station address.
Action: Check the station addresses on the host and in the 5250 Remote Emulator Card's configuration (see **Section 6.2.1**).
- Cause:** Unanswered messages at the host.
Action: Check the host console for unanswered messages.

Cursor appears at the top right corner of the screen when emulation starts.

Cause: Invalid station address.
Action: Check the station addresses on the host and in the 5250 Remote Emulator Card's configuration (see **Section 6.2.1**).

Cause: Damaged cabling or connections.
Action: Make sure that no cables are broken and that all cable connections are tight. Substitute another cable if necessary.

"Snow" appears on the screen.

Cause: Wrong monitor type.
Action: Select Color (IBM) monitor type in the configuration program (see **Section 6.2.2**).

Printer does not work.

Cause: Printer not configured or configured incorrectly.
Action 1: Make sure that the printer emulation matches the emulation on the host (see **Section 6.2.1**).
Action 2: Make sure the printer is configured on the host and in the 5250 Remote Emulator Card's configuration (see **Section 6.3.3**).

Cause: Invalid cable address.
Action: Make sure the cable-address settings on the host and in the 5250 Remote Emulator Card's software match (see **Section 6.2.1**).

Cause: Printer is off line.
Action: Make sure the printer is on line and has paper. Send a print screen from DOS to see if the printer is communicating with the PC.

No host communication—emulator will not come on line or cannot be varied on.

Cause: Communication line to/from host not operating properly.

Action: Contact the system operator; he or she might need to IPL the host. Make sure the host/modem cable is attached to the emulator. If you can't find the problem on the premises at either end, have the telephone company check the line.

Cause: SDLC encoding not set properly.

Action: The host's and emulator's encoding settings must match: either both NRZ or both NRZI. If you're unsure what the host's setting is, change this setting on the emulator (see **Section 6.2.4**) and try to bring it on line again.

Cause: Either host or Card is configured incorrectly.

Action: Make sure the host is configured for the emulator, that the emulator address is correct at the host, and that the host configuration and the local configuration match.

Cause: Modem is not the proper type or is not strapped properly.

Action: Verify that both modems are of the proper type for the network. Make sure the modems can communicate at the chosen line speed. Check that the modem is "strapped" for the network type (half- or full-duplex, etc.). Perform loopback or end-to-end tests to make sure host-site and emulator-site modems can communicate with each other.

Cause: Host not varied on or subsystem not started.

Action: Vary on the host as described in **Section 7.1**. Some hosts require the line, device(s), and subsystem to be varied on before the host can communicate. Make sure the subsystem is started.

After you connect the two modems, or when the Card is directly connected to a host without modems, DCD and DSR should be lit.

Once the host starts polling, the RX LED should flash. If everything is configured properly, RTS should light, followed immediately by CTS, followed immediately by TX.

If DCD and/or DSR are not lit, either there is a problem with the configuration of the modem or CSU/DSU, or the cable between the emulator and the modem or CSU/DSU is defective.

5250 REMOTE EMULATOR CARD

To check the cable, remove the cable connections at both ends and check for bent, broken, or missing pins.

In the modem or CSU/DSU configuration, make sure the DSR (Data Set Ready) and DCD (Data Carrier Detect) are set to normal operation, not forced on.

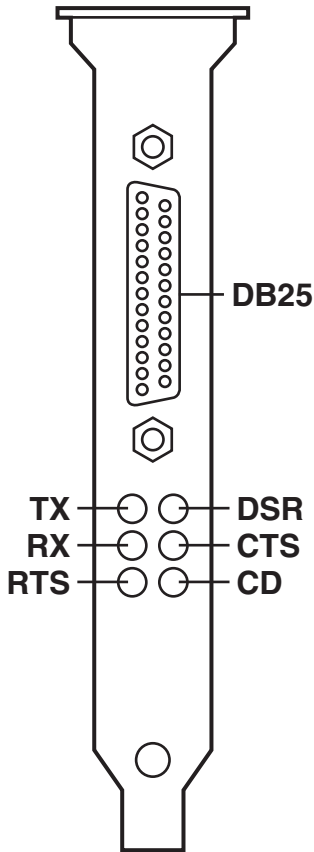

Figure 9-1. LEDs.

If you have tried all of the above solutions and the emulator is still not active, press the DOS Enter key. This will cause a red error code to appear in the bottom left corner of the display. Refer to the error code chart in **Table 9-1** for cause and solution.

Table 9-1. Error Codes.

SRC	Description	Possible Causes(s)
0040	<p>It has been at least thirty seconds since any valid SDLC frame has been received for any address, and it has also been at least 30 seconds since the DSR signal has been present on the cable from the modem/DCE.</p> <p>This code indicates conditions that would normally result in either error code 0055 or error code 0056, but gives the additional information that DSR is not present.</p>	<ul style="list-style-type: none"> a. The modem is not powered on. b. The telephone connection between the modems/DCEs is down. c. The modem cable is bad or is not corrected properly. d. The Controller is connected to a modem/DCE with a null-modem (cross-pinned) cable, or is directly connected to the host with straight-through-pinned cable. e. Modems are configured incorrectly.
0049	<p>Software has detected that the MPIC (host-communications card) has functioned in an invalid manner.</p>	<p>The MPIC is defective or not installed correctly. The software did not get the interrupt from the card, there is an I/O problem, or the board is bad.</p>

Table 9-1 (continued). Error Codes.

SRC	Description	Possible Causes(s)
0055	<p>Since the startup of the Controller, no valid SDLC frame has been received for the address.</p> <p>This error code will not be displayed if the Controller has ever received any good SDLC frames for any SDLC address. This is true even if the address in the frame is not the address configured for the remote controller, or any of the addresses configured for a multi-card Controller.</p>	<ul style="list-style-type: none">a. The remote controller has not been varied on at the host.b. NRZI/NONRZI configured on the remote controller does not match the host configuration.c. The cable connecting the Controller to its local modem/DCE (or that connecting the host to its local modem/DCE) is too long for the chosen data rate.d. The Controller is connected to a modem/DCE with a null-modem (cross-pinned) cable, or is directly connected to the host with straight-through-pinned cable.e. Modems are configured incorrectly.

Table 9-1 (continued). Error Codes.

SRC	Description	Possible Causes(s)
0056	<p>It has been at least 30 seconds since any valid SDLC frame has been received for any address. However, valid frames were received earlier.</p> <p>This error code will not be displayed if the Controller has received any good SDLC frames for any SDLC address in the last 30 seconds. This is true even if the address in the frame is not the address configured for the remote controller, or any of the addresses configured for a multi-card Controller.</p>	<p>The remote controller has been varied off at the host.</p>

Table 9-1 (continued). Error Codes.

SRC	Description	Possible Causes(s)
0057	Since the startup of the Controller (at least 30 seconds ago), no valid SDLC frame has been received for this display station's remote controller.	<ul style="list-style-type: none">a. The display station's remote controller has not been varied on, but one or more other remote controllers configured on the Controller are still varied on.b. The SDLC address configured for the display station's remote controller doesn't match the address configured on the host.c. The display station's remote controller has not been configured on the host at all.
0058	It has been at least 30 seconds since any valid SDLC frame has been received for the display station's remote controller. However, frames addressed to this remote controller were received earlier. This error normally shows up only on multi-card Controllers because it implies that other frames are still being received for other remote controller addresses; otherwise, error code 0056 would be displayed, indicating no frames are being received for any address.	The display station's remote controller has been varied off, but one or more emulated remote controllers in the same Controller are still varied on.

Table 9-1 (continued). Error Codes.

SRC	Description	Possible Causes(s)
0059	An SDLC XID command was received for the display station's remote controller, but that was at least 30 seconds ago and no SDLC i-frame (data frame) has been received since.	The remote-controller model (5294 or 5394) configured for the remote controller doesn't match the host configuration.

Table 9-1 (continued). Error Codes.

SRC	Description	Possible Causes(s)
0099	There is no SNA session active for the display station. Normally, this means that the display station or its remote controller is varied off, and the screen is blank.	<p>In many cases, when this error code appears, it will be replaced in about 30 seconds with one of the previous seven non-Token-Ring error codes. If this happens, the new error code will be more specific, and should be used to determine the problem. If error code 0099 is not replaced, the problem might be:</p> <ul style="list-style-type: none"> a. The display station has been varied off at the host, though its remote controller is varied on. b. The display station is not configured on the host, or its twinax address (0 through 6, local station address) is configured incorrectly.

Emulator drops off line and will not come back up or stays at a “Vary on pending” status.

Cause: Interference on telephone line.
Action: Have the phone company check the telephone line.

Cause: Message on console.
Action: Answer, then delete, the message.

Cause: Modem or emulator “locked up.”
Action: Power OFF, then power ON both modems and/or the emulator.

Cause: Subsystem terminated.

Action: Restart the subsystem.

Cause: “Drop line upon sign off” selected as “yes” on the AS/400’s display description.

Action: Select “no” to drop the line upon sign off.

Slow response time for attached devices.

Cause: Interference on communications line.

Action: Check for interference on the communications line to/from the host.

Cause: Selected data rate is too slow for the number of attached devices or the application.

Action: Raise the data-rate settings in the emulator’s configuration and on the modems.

Cause: Host has nonexistent controller varied on to a multipoint line.

Action: Check the host status of the line for such a controller. If the line shows any non-existent controllers that have status other than “varied off,” vary them off.

9.2 Error Messages

The error messages in this section are generated by the 5250 Remote Emulator Card during configuration, while starting emulation, or during active emulation. The IBM Systems/34, /36, /38, and AS/400 have various error messages to help identify communication problems between the host and the PC or PC printer. The IBM host also has a “help” facility designed for error-message recovery. Refer to the *IBM Technical Manual* for further details.

9.2.1 RUN-TIME ERROR MESSAGES

Address Conflict: The same cable address has been assigned to more than one logical-unit session.

Bad File Name: The file name cannot be read. This is typically caused when someone uses the wrong filename extension when typing in a configuration file’s name. The only valid extension is **.CFG**.

Error Creating File: DOS is unable to create a file in the current disk and directory. This is usually because the current disk is unavailable or write-protected.

Error Deleting File: DOS detects an error while attempting to delete a configuration file. This is usually because the current disk is unavailable or write-protected.

Error Reading File: The disk file is the wrong size or the data is invalid. If this error occurs while a user-created file is being read, the file must be recreated; otherwise, you should reinstall the configuration software.

Error Writing File: DOS detects an error while trying to write data to the current disk. The current disk might be unavailable, write-protected, or full. If you can correct the problem, do so, then press **Y** and DOS will retry the write; otherwise, press **N** to abort the write.

File Already Exists: The indicated file name already exists.

File Could Not Be Found: DOS can't find the indicated file name. Verify that the current disk and directory are correct. If so, create a new configuration file.

File Open Error: DOS detects an error while trying to open the requested file. Verify that the current disk and directory are correct; if so, you should reinstall the configuration software.

Invalid Configuration File: The configuration file you are trying to modify is invalid. Verify that you are specifying the correct file. If so, you'll have to delete and recreate the file.

Session is Not a Display Session: The logical session specified for the file transfer has not been configured or is configured as a printer.

9.2.2 ERROR MESSAGES ON LOADING EMULATION SOFTWARE

Configuration File is Invalid: The specified configuration file contains incorrect data. Verify that you are using the correct file. If so, you'll have to delete and recreate the configuration file.

Configuration File Not Found: The specified configuration file cannot be located. Verify that the current disk and directory are correct and that the correct configuration file is specified.

Device ID in Configuration File is Invalid: An incorrect device was found while processing the configuration file. Verify the device in the configuration file and, if necessary, delete and recreate the file.

Emulation Adaptor Does Not Respond: The 5250 Remote Emulator Card has detected a problem. Power OFF the PC and restart emulation. If the problem persists, verify the hardware configuration. If it is correct, contact your supplier.

Emulation Adaptor Diagnostic Error: The Card detects an error during power up. Power OFF the PC and restart emulation. If the problem persists, contact your supplier.

Error Reading Keyboard Definition File: The emulation software cannot read the keyboard-definition file. Verify that the current disk and directory are correct. If so, verify that the 5250 Remote Emulator Card's software diskette contains the three files KEYBOARD.BAS, KEYBOARD.CHG, and KEYBOARD.DEF. If it doesn't, contact your supplier.

Error Reading Printer Definition File: The emulator software cannot read the printer-definition file. Verify that the current disk and directory are correct; if so, check the configuration and make sure that the printer is correctly configured. If the problem persists, reinstall the software.

Keyboard Definition File is Invalid: The data in the keyboard-definition file is incorrect. Recopy the three files KEYBOARD.BAS, KEYBOARD.CHG, and KEYBOARD.DEF from the 5250 Remote Emulator Card's software diskette. If this doesn't help, briefly switch to another keyboard language and then switch back to your desired language; these three files will be overwritten and then recreated.

Keyboard Definition File Not Found: The emulation software is unable to locate the keyboard-definition file. If the current disk and directory are correct, copy the three files KEYBOARD.BAS, KEYBOARD.CHG, and KEYBOARD.DEF from the 5250 Remote Emulator Card's software diskette into the current disk and directory.

Printer Definition File Not Found: The emulation software is unable to locate the printer-definition file. Verify the printer configuration; if it is correct, reinstall the emulation software.

9.2.3 PC SUPPORT/400 ERROR MESSAGES

Handler is already resident: If PC Support is not active, reboot the system.

9.2.4 HOST ERROR MESSAGES

The host system also has a set of error messages to report problems with communication between the host and the display station. These four-digit error messages consist of codes 0040 through 0054. See the *IBM Technical Reference Manual* for your host type (System/34, /36, /38, or AS/400) for further information on host error messages.

Use the [**ERROR RESET**] key to clear the error condition and proceed with the host communications.

9.3 Application Compatibility

The 5250 Remote Emulator Card is compatible with most PC application programs. The following information may help prevent any conflicts.

9.3.1 MICROSOFT WINDOWS

The 5250 Remote Emulator Card software is Windows compatible if used under a Windows DOS partition. Included with the 5250 Remote Emulator Card's software are two *.PIFs (Program Information Files) for starting emulation from Windows. You must enter the pathname of the *.PIF file on the command line of the NEW PROGRAM OBJECT window when you create an icon for the emulation software.

9.3.2 DOS SHELL

Make sure all programs, including the 5250 Remote Emulator Card's emulation program, are loaded before you load the DOS Shell. If the emulation program is loaded from DOS Shell, the next application program may not load properly, since the PC's memory is not fully free.

9.3.3 43- OR 50-LINE MODE

The ANSI.SYS screen driver must be installed when you use programs with 43- or 50-line mode, such as Quattro® Pro. Otherwise, the number of lines might revert to another size when you hotkey to a host session and then back to the DOS session.

The screen colors may change during the hotkeying for some programs (such as Microsoft Works), but the data will remain unaffected and the screen colors will be restored after the next startup.

9.3.4 HANDSON

When you use HandsOn or Novell® Menu for file transfer, the PC clock might lose the proper time, but data is unaffected.

9.4 Calling Your Supplier

If you determine that your 5250 Remote Emulator Card is malfunctioning, *do not attempt to alter or repair it*. It contains no user-serviceable parts. Contact your supplier: The problem may be solvable over the phone.

Before you do, make a record of the history of the problem. Your supplier will be able to provide more efficient and accurate assistance if you have a complete description, including:

- the nature and duration of the problem,
- when the problem occurs,
- the components involved in the problem,
- any particular application that, when used, appears to create the problem or make it worse,
- the revision level of your software (this is printed on the diskette label),
- the date you purchased the Card,
- the make and model of any attached printer, and
- the type of host system to which the Card is attached.

9.5 Shipping and Packaging

If you need to transport or ship your Card:

- Package it carefully. We recommend that you use the original container.
- If you are shipping the Card for repair, include its software diskette. If you are returning the Card, make sure you include everything you received with the unit. Before you ship, contact your supplier to get a Return Authorization (RA) number.

Appendix A: Names of Executable Files

This appendix lists the filenames for the executable programs included with the 5250 Remote Emulator Card's software. An executable program is a set of step-by-step instructions the computer follows to complete a task. Some of the programs listed here are meant to be run directly by the user and some are meant to be executed by the emulator ("called" by the emulation program).

A.1 User-Run Programs

- EM5251R.EXE** The main emulation program. To execute this program at a DOS prompt, change to the emulation software's directory and type **EM5251R**.
- EMDIAG.EXE** This utility program checks for communication between the PC and the 5250 Remote Emulator Card. If this test is successful, the program checks for communication with the modem.
- EMKBCHK.EXE** This utility program helps to determine which type of keyboard is being used. To execute this program at a DOS prompt, change to the emulation software's directory and type **EMKBCHK**.
- RCONFIG.EXE** The configuration program. To execute this program at a DOS prompt, change to the emulation software's directory and type **RCONFIG**.
- SAVEKEYS.EXE** Use this program to save keystrokes recorded during the record/playback feature. You will need to hotkey out of emulation before you can run this program. At the DOS prompt, change to the emulation software's directory and type **SAVEKEYS**.
- WININST.EXE** This program adds the **emset** command to the **WINSTART.BAT** file. If **WINSTART.BAT** does not exist, **WININST** will create it. At the DOS prompt, type **WININST**.

A.2 Emulator-Run Programs

HP.EXE	This program enables 3812 emulation on a laser printer in HP mode.
HP4029.EXE	This program enables 3812 emulation on an IBM 4029 laser printer in HP mode.
HP5219.EXE	This program enables 5219 emulation on a laser printer in the HP mode.
PPDS4029.EXE	This program enables 3812 emulation on an IBM 4029 laser printer in PPDS mode.
PREM.EXE	This program enables 4214 emulation on a dot-matrix printer.
EM5251C.EXE	This program activates the controller and starts communication with the host.
EM5251CA.EXE	This program activates the controller under IBM PC Support/400.
EM5251E.EXE	This program runs the emulation software.
EM5251EA.EXE	This program runs emulation under PC Support/400.
EM5251RA.BAT	This program sets up the 5250 Remote Emulator Card to work with PC Support/400.

A.3 Other Files

The 5250 Remote Emulator Card's software also includes a number of nonexecutable files. These have suffixes other than **.EXE**:

- *.**P12** Printer files using 3812 emulation.
- *.**P14** Printer files using 4214 emulation.
- *.**P19** Printer files using 5219 emulation.

5250 REMOTE EMULATOR CARD

- *.**P56** Printer files using Text Mode.
- *.**DAT** File utilized in configuration to make changes for language.
- *.**CFG** Configuration files.
- *.**HEX** Files containing microcode for the 5250 Remote Emulator Card.
- *.**PIF** Program-Information File used in conjunction with Windows.
- *.**BAS** Keyboard-Base File.
- *.**CHG** Keyboard-Change File.
- *.**DEF** Keyboard-Definition File.
- *.**ICO** Icon files.

Appendix B: Code-Set Tables

The table that comprises the rest of this appendix shows decimal and hexadecimal codes and the corresponding characters in the U. S. National EBCDIC and U. S. National ASCII code sets.

Regarding the U. S. National EBCDIC code set:

- The first 64 characters, 0 to 63 decimal or 0 to 3F hex, are not listed here because they are very-seldom-used control codes that the 5250 Remote Emulator Card ignores.
- For the 8D, AD, BC and DA hex codes, either of the two listed characters might print, depending on the printer type or emulation.
- For lists of corresponding characters in EBCDIC versions other than U. S. National, refer to the *IBM 5250 Function Reference Manual*, SA21-9247-6.

Regarding the U.S. National ASCII code set:

- Only the standard 7-bit code set, consisting of character codes 0 to 127 decimal or 0 to 7F hex, is shown here. Many proprietary 8-bit extended ASCII code sets exist, but none of them are standard.

5250 REMOTE EMULATOR CARD

DECIMAL	HEX	ASCII
0	00	(NUL)
1	01	(SOH)
2	02	(STX)
3	03	(ETX)
4	04	(EOT)
5	05	(ENQ)
6	06	(ACK)
7	07	(BEL)
8	08	(BS)
9	09	(HT)
10	0A	(LF)
11	0B	(VT)
12	0C	(FF)
13	0D	(CR)
14	0E	(SO)
15	0F	(SI)
16	10	(DLE)
17	11	(DC1)
18	12	(DC2)
19	13	(DC3)
20	14	(DC4)
21	15	(NAK)
22	16	(SYN)
23	17	(ETB)
24	18	(CAN)
25	19	(EM)
26	1A	(SUB)
27	1B	(ESC)
28	1C	(FS)
29	1D	(GS)
30	1E	(RS)
31	1F	(US)

DECIMAL	HEX	ASCII
32	20	(SP)
33	21	!
34	22	"
35	23	#
36	24	\$
37	25	%
38	26	&
39	27	'
40	28	(
41	29)
42	2A	*
43	2B	+
44	2C	,
45	2D	-
46	2E	.
47	2F	/
48	30	0
49	31	1
50	32	2
51	33	3
52	34	4
53	35	5
54	36	6
55	37	7
56	38	8
57	39	9
58	3A	:
59	3B	;
60	3C	<
61	3D	=
62	3E	>
63	3F	?

DECIMAL	HEX	EBCDIC	ASCII
64	40	space	@
65	41	req. space	A
66	42	â	B
67	43	ä	C
68	44	à	D
69	45	á	E
70	46	ã	F
71	47	å	G
72	48	ç	H
73	49	ñ	I
74	4A	ç	J
75	4B	.	K
76	4C	<	L
77	4D	(M
78	4E	+	N
79	4F		O
80	50	&	P
81	51	é	Q
82	52	ê	R
83	53	ë	S
84	54	è	T
85	55	í	U
86	56	î	V
87	57	ï	W
88	58	ì	X
89	59	ß	Y
90	5A	!	Z
91	5B	\$	[
92	5C	*	\
93	5D)]
94	5E	;	^
95	5F	¬	_

5250 REMOTE EMULATOR CARD

DECIMAL	HEX	EBCDIC	ASCII
96	60	-	'
97	61	/	a
98	62	Â	b
99	63	Ä	c
100	64	À	d
101	65	Á	e
102	66	Ã	f
103	67	Å	g
104	68	Ç	h
105	69	Ñ	i
106	6A		j
107	6B	,	k
108	6C	%	l
109	6D	-	m
110	6E	>	n
111	6F	?	o
112	70	ø	p
113	71	É	q
114	72	Ê	r
115	73	Ë	s
116	74	È	t
117	75	Í	u
118	76	Î	v
119	77	Ï	w
120	78	Ì	x
121	79	`	y
122	7A	:	z
123	7B	#	{
124	7C	@	
125	7D	'	}
126	7E	=	~
127	7F	"	(DEL)

DECIMAL	HEX	EBCDIC
128	80	Ø
129	81	a
130	82	b
131	83	c
132	84	d
133	85	e
134	86	f
135	87	g
136	88	h
137	89	i
138	8A	«
139	8B	»
140	8C	d
141	8D	y or ↓
142	8E	
143	8F	±
144	90	°
145	91	j
146	92	k
147	93	l
148	94	m
149	95	n
150	96	o
151	97	p
152	98	q
153	99	r
154	9A	ª
155	9B	°
156	9C	æ
157	9D	ξ
158	9E	Æ
159	9F	€

DECIMAL	HEX	EBCDIC
160	A0	μ
161	A1	~
162	A2	s
163	A3	t
164	A4	u
165	A5	v
166	A6	w
167	A7	x
168	A8	y
169	A9	z
170	AA	j
171	AB	¿
172	AC	D
173	AD	Y or ↑
174	AE	
175	AF	®
176	B0	^
177	B1	£
178	B2	¥
179	B3	•
180	B4	f
181	B5	§
182	B6	¶
183	B7	¼
184	B8	½
185	B9	¾
186	BA	[
187	BB]
188	BC	- or ≠
189	BD	¨
190	BE	´
191	BF	_

5250 REMOTE EMULATOR CARD

DECIMAL	HEX	EBCDIC
192	C0	{
193	C1	A
194	C2	B
195	C3	C
196	C4	D
197	C5	E
198	C6	F
199	C7	G
200	C8	H
201	C9	I
202	CA	—
203	CB	ô
204	CC	ö
205	CD	ò
206	CE	ó
207	CF	õ
208	D0	}
209	D1	J
210	D2	K
211	D3	L
212	D4	M
213	D5	N
214	D6	0
215	D7	P
216	D8	Q
217	D9	R
218	DA	¹ or ≥
219	DB	û
220	DC	ü
221	DD	ù
222	DE	ú
223	DF	ÿ

DECIMAL	HEX	EBCDIC
224	E0	\
225	E1	# space
226	E2	S
227	E3	T
228	E4	U
229	E5	V
230	E6	W
231	E7	X
232	E8	Y
233	E9	Z
234	EA	²
235	EB	Ô
236	EC	Ö
237	ED	Ò
238	EE	Ó
239	EF	Õ
240	F0	0
241	F1	1
242	F2	2
243	F3	3
244	F4	4
245	F5	5
246	F6	6
247	F7	7
248	F8	8
249	F9	9
250	FA	³
251	FB	Û
252	FC	Ü
253	FD	Ù
254	FE	Ú
255	FF	(NUL)

Appendix C: Typestyle (FGID) Tables

The tables on the following pages list the IBM typestyle numbers (font IDs) that the 5250 Remote Emulator Card uses to select fonts internal to the printer and from HP font cartridges. Font-change commands for each font are also listed (see **Section 8.4.1**). As on the cartridges themselves, cartridge fonts are listed in ascending order by pitch.

Typestyle numbers with an asterisk (*) next to them are acceptable IBM font IDs for device configuration and OCL or CL printer commands (in hexadecimal). Typestyle numbers in parentheses are alternatives that more closely match the IBM CPI spacing of the font.

Font-change commands begin with a logical not (¬), which is [UPPER SHIFT] [6] on U. S. keyboards. The caret (^) symbol may be substituted in non-U.S. applications.

Remember that you can't right-justify proportional fonts with the IBM justify command.

C.1 5219 Emulation

Tables C-1 and C-2 on the next few pages list IBM typestyle numbers (font IDs) and font-change commands for resident (internal to the printer) HP LaserJet fonts and HP font cartridges with the 5219 printer emulation.

NOTE

Typestyle number 86 prints the resident 10-CPI Courier font at 12 CPI spacing in portrait (¬QXM). Typestyle number 85 prints the resident 16-CPI Line Printer font at 12-CPI spacing in landscape (¬QXN).

Table C-1. Hewlett-Packard LaserJet Internal Resident Fonts Under 5219 Emulation

Printer Model	Font	Orien- tation	Pitch	Point Size	Type- style No.	Font- Change Command
All Models	Courier	P	10	12	*11	-QXG
		L	10	12	*5	-QXH
Plus & Series II	Line Printer	P	16.66	8.5	*221	-QXJ
Series II	Line Printer (8 LPI)	P	16.66	8.5	*223	-QXL
Series II	Line Printer (8 LPI)	L	19.0	8.5	*225	-QLG
			13.3	8.5	*91	-QXK

Table C-2. Hewlett-Packard Cartridge Fonts Under 5219 Emulation

Font	Orien- tation	Pitch	Point Size	Typestyle No.		Font-Change Command	
				Standard	Legal	Standard	Legal
A Cartridge							
Courier bold	P	10	12	8	—	-QLA	—
	L	10	12	9	—	-QLC	—
Courier light	P	10	12	6	—	-QLB	—
	L	10	12	7	—	-QLC	—
Line Printer light	P	16.66	8.5	*221	—	-QLE	—
B Cartridge							
Helvetica bold	P	Prop.	14.4	175	—	-QBA	—
Times Roman med	P	Prop.	10	*158	—	-QBB	—
Times Roman bold	P	Prop.	10	*159	—	-QBC	—
Times Roman med itl	P	Prop.	10	*162	—	-QBD	—
Times Roman light	P	Prop.	8	154	—	-QBE	—
Line Printer light	L	16.66	8.5	255	—	-QBF	—
		19.0	8.5	*225	—	-QBG	—

5250 REMOTE EMULATOR CARD

Font	Orientation	Pitch	Point Size	Typestyle No.		Font-Change Command	
				Standard	Legal	Standard	Legal
E Cartridge							
Letter Gothic medium	P	12	12	*84	—	-QNA	—
	L	12	10	88	—	-QND	—
Letter Gothic bold	P	12	10	97	—	-QNB	—
	L	12	10	98	—	-QNE	—
Letter Gothic medium italic	P	12	10	107	—	-QNC	—
	L	12	10	108	—	-QNF	—
G Cartridge							
Prestige Elite med	P	12	10	*80	90	-QGUA	-QGLA
Prestige Elite bold	P	12	10	82	92	-QGUC	-QGLC
Prestige Elite medium	P	16.66	7	*222 (252)	227 (253)	-QGUD	-QGLD
		16.66	7	216 (250)	228 (254)	-QGUE	-QGLE
	L	19	7	214	—	-QGUF	—
Line Draw Set	P	12	12	110	—	-QGF	—
H Cartridge							
Courier medium	P	10	12	*20	30	-QHUA	-QHLA
Courier bold	P	10	10	22	32	-QHUC	-QHLC
Courier med italic	P	10	12	21	31	-QHUB	-QHLB
Prestige Elite medium	P	16.66	7	*222 (252)	227 (253)	-QHUD	-QHLD
		16.66	7	216 (250)	228 (254)	-QHUE	-QHLE
	L	19	7	214	—	-QHUF	—
Line Draw Set	P	10	12	40	—	-QHF	—

Font	Orientation	Pitch	Point Size	Typestyle No.		Font-Change Command	
				Standard	Legal	Standard	Legal
L Cartridge							
Courier bold	P	10	12	8	—	-QLA	—
	L	10	12	9	—	-QLC	—
Courier medium italic	P	10	12	6	—	-QLB	—
	L	10	12	7	—	-QLD	—
Line Printer medium	P	16.66	8.5	*221	—	-QLE	—
		16.66	8.5	255	—	-QLF	—
	L	19	8.5	*225	—	-QLG	—
Prestige Elite medium	P	12	10	*87	—	-QMA	—
	L	12	10	88	—	-QMD	—
Prestige Elite bold	P	12	10	97	—	-QMB	—
	L	12	10	98	—	-QME	—
Prestige Elite medium italic	P	12	10	107	—	-QMC	—
	L	12	10	108	—	-QMF	—
N Cartridge							
Letter Gothic medium	P	12	12	*84	—	-QNA	—
	L	12	12	*85	—	-QND	—
Letter Gothic bold	P	12	12	94	—	-QNB	—
	L	12	12	95	—	-QNE	—
Letter Gothic medium italic	P	12	12	104	—	-QNC	—
	L	12	12	105	—	-QNF	—
Q Cartridge							
Courier bold	P	10	12	8	—	-QQA	—
	L	10	12	9	—	-QQE	—
Courier medium italic	P	10	12	6	—	-QQB	—
	L	10	12	7	—	-QQF	—
Letter Gothic med	P	12	12	*84	—	-QQC	—
Letter Gothic bold	P	12	12	94	—	-QQD	—

5250 REMOTE EMULATOR CARD

Font	Orientation	Pitch	Point Size	Typestyle No.		Font-Change Command	
				Standard	Legal	Standard	Legal
R Cartridge							
Presentation bold	P	6.5	18	18 (240)	28 (242)	-QRUA	-QRLA
	L	6.5	18	19 (241)	29 (243)	-QRUD	-QRLD
	P	8.1	16	16 (260)	26 (262)	-QRUB	-QRLB
	L	8.1	14	17 (261)	27 (263)	-QRUE	-QRLE
	P	10	14	14	24	-QRUC	-QRLC
	L	10	14	15	25	-QRUF	-QRLF
Letter Gothic medium	P	10	14	*12	34	-QRUG	-QRLG
	L	10	14	*13	35	-QRUH	-QRLH
PC Line bold	P	10	14	36	—	-QRJ	—
	L	10	14	37	—	-QRK	—
Line Draw	P	10	14	38	—	-QRM	—
	L	10	14	39	—	-QRN	—

C.2 3812 Emulation

Tables C-3 through C-6 on the next few pages list IBM typestyle numbers (font IDs) and font-change commands that you'd use to change fonts within a document with the 3812 printer emulation.

Table C-3. HP Mode Fonts (Resident)

Typeface	Orien- tation	Pitch	Point Size	Type- style No.	Font- Change Command
All LaserJet Models:					
Courier	P/L	10	12	11	-Q11
Line Printer	P/L	15	9	223	-Q223
		17.1	8.5	254	-Q254
		19	8.0	282	-Q282
		13.33	9.5	201	-Q201
LaserJet IID, III, IIID Printers also have:					
Courier	P/L	10	12	46	-Q46
Courier	P/L	10	12	85	-Q85
Courier italic	P/L	10	12	18	-Q18
Courier bold	P/L	10	12	88	-Q88
Courier	P/L	12	10	89	-Q89
LaserJet III and IIISi Resident Scalable Fonts:					
CG Times	P/L	Prop.	6	4605	-Q4605
			8	4606	-Q4606
			10	4607	-Q4607
			12	4608	-Q4608
			14	4609	-Q4609
			18	4611	-Q4611
			24	4614	-Q4614
30	4617	-Q4617			

5250 REMOTE EMULATOR CARD

Typeface	Orien- tation	Pitch	Point Size	Type- style No.	Font- Change Command
CG Times bold	P/L	Prop.	6	4625	¬Q4625
			8	4626	¬Q4626
			10	4627	¬Q4627
			12	4628	¬Q4628
			14	4629	¬Q4629
			18	4631	¬Q4631
			24	4634	¬Q4634
			30	4637	¬Q4637
CG Times italic	P/L	Prop.	6	4645	¬Q4645
			8	4646	¬Q4646
			10	4647	¬Q4647
			12	4648	¬Q4648
			14	4649	¬Q4649
			18	4651	¬Q4651
			24	4654	¬Q4654
			30	4657	¬Q4657
CG Times bold italic	P/L	Prop.	6	4665	¬Q4665
			8	4666	¬Q4666
			10	4667	¬Q4667
			12	4668	¬Q4668
			14	4669	¬Q4669
			18	4671	¬Q4671
			24	4674	¬Q4674
			30	4677	¬Q4677
Univers medium	P/L	Prop.	6	4805	¬Q4805
			8	4806	¬Q4806
			10	4807	¬Q4807
			12	4808	¬Q4808
			14	4809	¬Q4809
			18	4811	¬Q4811
			24	4814	¬Q4814
			30	4817	¬Q4817

5250 REMOTE EMULATOR CARD

Typeface	Orien- tation	Pitch	Point Size	Type- style No.	Font- Change Command
Univers medium italic	P/L	Prop.	6	4825	¬Q4825
			8	4826	¬Q4826
			10	4827	¬Q4827
			12	4828	¬Q4828
			14	4829	¬Q4829
			18	4831	¬Q4831
			24	4834	¬Q4834
			30	4837	¬Q4837
Univers medium condensed	P/L	Prop.	6	4845	¬Q4845
			8	4846	¬Q4846
			10	4847	¬Q4847
			12	4848	¬Q4848
			14	4849	¬Q4849
			18	4851	¬Q4851
			24	4854	¬Q4854
			30	4857	¬Q4857
Univers medium condensed italic	P/L	Prop.	6	4865	¬Q4865
			8	4866	¬Q4866
			10	4867	¬Q4867
			12	4868	¬Q4868
			14	4869	¬Q4869
			18	4871	¬Q4871
			24	4874	¬Q4874
			30	4877	¬Q4877
ITC Zapf Dingbats®	P/L	Prop.	6	4985	¬Q4985
			8	4986	¬Q4986
			10	4987	¬Q4987
			12	4988	¬Q4988
			14	4989	¬Q4989
			18	4991	¬Q4991
			24	4994	¬Q4994
			30	4997	¬Q4997

5250 REMOTE EMULATOR CARD

Typeface	Orien- tation	Pitch	Point Size	Type- style No.	Font- Change Command
ProCollection Cartridge					
Line Printer	P/L	17.1	8.5	253	-Q253
Courier bold	P/L	10	12	45	-Q45
Courier italic	P/L	10	12	17	-Q17
Courier	P/L	12	10	85	-Q85
Courier bold	P/L	12	10	108	-Q108
Courier italic	P/L	12	10	92	-Q92
Courier	P	10	12	51	-Q51
Courier bold	P	10	12	52	-Q52
Courier italic	P	10	12	53	-Q53
Courier	P	12	10	93	-Q93
Courier bold	P	12	10	94	-Q94
Courier italic	P	12	10	95	-Q95
Prestige Elite	P/L	15	7	220	-Q220
		12	10	83	-Q83
Prestige Elite bold	P/L	12	10	113	-Q113
Prestige Elite italic	P/L	12	10	114	-Q114
Prestige Elite	P	15	7	219	-Q219
		12	10	97	-Q97
Prestige Elite bold	P	12	10	98	-Q98
Prestige Elite italic	P	12	10	99	-Q99
Letter Gothic	P/L	27	3.6	291	-Q291
		19	6	281	-Q281
		17.1	9.5	257	-Q257
		12	12	66	-Q66
Letter Gothic bold	P/L	12	12	69	-Q69
Letter Gothic italic	P/L	12	12	68	-Q68
Times Roman	P	Prop.	8	163	-Q163
			10	164	-Q164
Times Roman bold	P	Prop.	10	165	-Q165
Times Roman italic	P	Prop.	10	166	-Q166

Typeface	Orien- tation	Pitch	Point Size	Type- style No.	Font- Change Command
Times Roman	P	Prop.	12	167	-Q167
Times Roman bold	P	Prop.	12	168	-Q168
Times Roman italic	P	Prop.	12	169	-Q169
Times Roman	P	Prop.	8	173	-Q173
			10	174	-Q174
Times Roman bold	P	Prop.	10	175	-Q175
Times Roman italic	P	Prop.	10	176	-Q176
Times Roman	P	Prop.	12	177	-Q177
Times Roman bold	P	Prop.	12	178	-Q178
Times Roman italic	P	Prop.	12	179	-Q179
Helvetica	P	Prop.	8	183	-Q183
			10	184	-Q184
Helvetica bold	P	Prop.	10	185	-Q185
Helvetica italic	P	Prop.	10	186	-Q186
Helvetica	P	Prop.	12	187	-Q187
Helvetica bold	P	Prop.	12	188	-Q188
Helvetica italic	P	Prop.	12	189	-Q189
Helvetica bold	P	Prop.	14	190	-Q190
Helvetica bold	P	Prop.	14	191	-Q191
WordPerfect® Cartridge					
CG Times	P	Prop.	6	4685	-Q4685
			8	4686	-Q4686
CG Times bold	P	Prop.	8	4706	-Q4706
CG Times italic	P	Prop.	8	4814	-Q4814
CG Times	P	Prop.	10	4687	-Q4687
CG Times bold	P	Prop.	10	4707	-Q4707
CG Times italic	P	Prop.	10	4815	-Q4815
CG Times	P	Prop.	12	4688	-Q4688
CG Times bold	P	Prop.	12	4708	-Q4708
CG Times italic	P	Prop.	12	4816	-Q4816
CG Times	P	Prop.	14	4689	-Q4689
CG Times bold	P	Prop.	14	4709	-Q4709

5250 REMOTE EMULATOR CARD

Typeface	Orien- tation	Pitch	Point Size	Type- style No.	Font- Change Command
CG Times italic	P	Prop.	14	4817	¬Q4817
CG Times bold	P	Prop.	18	4711	¬Q4711
			24	4714	¬Q4714
Univers	P	Prop.	14	4789	¬Q4789
			18	4791	¬Q4791
			24	4794	¬Q4794
Microsoft Cartridge					
Helvetica	P	Prop.	8	34102	¬Q34102
			10	34103	¬Q34103
Helvetica bold	P	Prop.	10	34123	¬Q34123
Helvetica italic	P	Prop.	10	34231	¬Q34231
Helvetica	P	Prop.	12	34104	¬Q34104
Helvetica bold	P	Prop.	12	34124	¬Q34124
Helvetica italic	P	Prop.	12	34232	¬Q34232
Helvetica bold	P	Prop.	14	34125	¬Q34125
Times Roman	P	Prop.	8	5686	¬Q5686
			10	5687	¬Q5687
Times Roman bold	P	Prop.	10	5707	¬Q5707
Times Roman italic	P	Prop.	10	5815	¬Q5815
Times Roman	P	Prop.	12	5688	¬Q5688
Times Roman bold	P	Prop.	12	5708	¬Q5708
Times Roman italic	P	Prop.	12	5816	¬Q5816
Times Roman bold	P	Prop.	14	5709	¬Q5709
Line Printer	P/L	15	8.5	223	¬Q223
Polished Worksheets® Cartridge					
Prestige Elite	P/L	15	7	221	¬Q221
			12	86	¬Q86
Prestige Elite bold	P/L	12	10	111	¬Q111
Prestige Elite italic	P/L	12	10	112	¬Q112
Prestige Elite	P/L	15	7	219	¬Q219
			12	97	¬Q97
Prestige Elite bold	P/L	12	10	98	¬Q98
Prestige Elite italic	P/L	12	10	99	¬Q99

Typeface	Orien- tation	Pitch	Point Size	Type- style No.	Font- Change Command
Letter Gothic	P/L	27	3.6	290	-Q290
		12	12	87	-Q87
Letter Gothic bold	P/L	12	12	110	-Q110
Letter Gothic italic	P/L	12	12	109	-Q109
Letter Gothic	P/L	27	3.6	292	-Q292
		12	12	90	-Q90
Letter Gothic bold	P/L	12	12	107	-Q107
Letter Gothic italic	P/L	12	12	106	-Q106
Presentation bold	P/L	8.1	16	434	-Q434
Presentation bold	P/L	8.1	16	431	-Q431
Persuasive Presentations® Cartridge					
Letter Gothic	P/L	10	14	39	-Q39
Letter Gothic	P/L	10	14	38	-Q38
Presentation bold	P/L	10	14	6	-Q6
Presentation bold	P/L	10	14	7	-Q7
Presentation bold	P/L	8.1	16	434	-Q434
Presentation bold	P/L	8.1	16	431	-Q431
Presentation bold	P/L	6.5	18	435	-Q435
Presentation bold	P/L	6.5	18	432	-Q432
Presentation bold	P/L	5.7	24	436	-Q436
Presentation bold	P/L	5.7	24	433	-Q433
Helvetica Outline	P/L	Prop.	24	34115	-Q34115
Helvetica Outline	P/L	Prop.	24	34116	-Q34116
Serifa	P/L	Prop.	24	34215	-Q34215
Serifa	P/L	Prop.	24	34216	-Q34216
Line Draw	P/L	10	14	31	-Q31
PC Line bold	P/L	10	14	32	-Q32

5250 REMOTE EMULATOR CARD

Typeface	Orien- tation	Pitch	Point Size	Type- style No.	Font- Change Command
Forms, Etc.® Cartridge					
Univers	P/L	Prop.	6	33101	-Q33101
		Prop.	8	33102	-Q33102
Univers bold	P/L	Prop.	8	33122	-Q33122
		Prop.	10	33123	-Q33123
		Prop.	12	33124	-Q33124
		Prop.	14	33125	-Q33125
Helv Cond. Black bold	P/L	Prop.	24	34128	-Q34128
OCR-A	P	10	12	19	-Q19
Tax Line Draw	P/L	10	12	30	-Q30
Bar Codes & More® Cartridge					
Letter Gothic	P/L	15	9.5	230	-Q230
		12	12	87	-Q87
		10	14	40	-Q40
OCR-A	P	10	12	19	-Q19
OCR-B	P	10	12	3	-Q3
Code 3 of 9	P	8.1	12	60	-Q60
		4.6	12	240	-Q240
EAN/UPC 10 Mil	P	Prop.	12	170	-Q170
EAN/UPC 13 Mil bold	P	Prop.	12	171	-Q171
USPS Zip	P/L	Prop.	12	172	-Q172
Line Draw	P/L	10	12	33	-Q33
Text Equations Cartridge					
Prestige Elite	P	15	7	221	-Q221
		17.1	7	256	-Q256
		12	10	86	-Q86
Prestige Elite bold	P	12	10	111	-Q111
Prestige Elite italic	P	12	10	112	-Q112
CG Times	P	Prop.	8	157	-Q157
		Prop.	10	158	-Q158
CG Times bold	P	Prop.	10	159	-Q159
CG Times italic	P	Prop.	10	155	-Q155

Typeface	Orien- tation	Pitch	Point Size	Type- style No.	Font- Change Command
Global Text Cartridge					
CG Century Schoolbook	P/L	Prop.	8	16950	-Q16950
			10	16951	-Q16951
CG Century Schlbk bold	P/L	Prop.	10	16971	-Q16971
CG Century Schlbk italic	P/L	Prop.	10	17079	-Q17079
CG Triumvirate	P/L	Prop.	10	33335	-Q33335
CG Triumvirate bold	P/L	Prop.	14	33357	-Q33357
Pretty Faces Cartridge					
Microstyle	P	Prop.	18	5910	-Q5910
Microstyle bold	P	Prop.	36	5920	-Q5920
Hobo Medium	P	Prop.	30	5930	-Q5930
			14	5940	-Q5940
Thunderbird	P	Prop.	54	5950	-Q5950
Signet Roundhand	P	Prop.	18	5960	-Q5960
			14	5970	-Q5970
ITC Dingbats	P	Prop.	36	5980	-Q5980
			18	5990	-Q5990

5250 REMOTE EMULATOR CARD

Font	Pitch	Point Size	Type-style No.	Font-Change Command
Courier outline	Prop.	6	416	¬Q416
		8	426	¬Q426
		10	436	¬Q436
		12	446	¬Q446
		14	456	¬Q456
		18	466	¬Q466
		24	476	¬Q476
		30	486	¬Q486
Courier bold outline	Prop.	6	420	¬Q420
		8	430	¬Q430
		10	440	¬Q440
		12	450	¬Q450
		14	460	¬Q460
		18	470	¬Q470
		24	480	¬Q480
		30	490	¬Q490
Courier italic outline	Prop.	6	424	¬Q424
		8	434	¬Q434
		10	444	¬Q444
		12	454	¬Q454
		14	464	¬Q464
		18	474	¬Q474
		24	484	¬Q484
		30	494	¬Q494
Courier bold italic outline	Prop.	6	428	¬Q428
		8	438	¬Q438
		10	448	¬Q448
		12	458	¬Q458
		14	468	¬Q468
		18	478	¬Q478
		24	488	¬Q488
		30	498	¬Q498

Font	Pitch	Point Size	Type-style No.	Font-Change Command
Helvetica outline	Prop.	6	2304	¬Q2304
		8	2314	¬Q2314
		10	2324	¬Q2324
		12	2334	¬Q2334
		14	2344	¬Q2344
		18	2354	¬Q2354
		24	2364	¬Q2364
		30	2374	¬Q2374
Helvetica bold outline	Prop.	6	2305	¬Q2305
		8	2315	¬Q2315
		10	2325	¬Q2325
		12	2335	¬Q2335
		14	2345	¬Q2345
		18	2355	¬Q2355
		24	2365	¬Q2365
		30	2375	¬Q2375
Helvetica italic outline	Prop.	6	2306	¬Q2306
		8	2316	¬Q2316
		10	2326	¬Q2326
		12	2336	¬Q2336
		14	2346	¬Q2346
		18	2356	¬Q2356
		24	2366	¬Q2366
		30	2376	¬Q2376
Helvetica bold italic outline	Prop.	6	2307	¬Q2307
		8	2317	¬Q2317
		10	2327	¬Q2327
		12	2337	¬Q2337
		14	2347	¬Q2347
		18	2357	¬Q2357
		24	2367	¬Q2367
		30	2377	¬Q2377

5250 REMOTE EMULATOR CARD

Font	Pitch	Point Size	Type-style No.	Font-Change Command
Times New Roman outline	Prop.	6	2308	¬Q2308
		8	2318	¬Q2318
		10	2328	¬Q2328
		12	2338	¬Q2338
		14	2348	¬Q2348
		18	2358	¬Q2358
		24	2368	¬Q2368
		30	2378	¬Q2378
Times New Roman bold outline	Prop.	6	2309	¬Q2309
		8	2319	¬Q2319
		10	2329	¬Q2329
		12	2339	¬Q2339
		14	2349	¬Q2349
		18	2359	¬Q2359
		24	2369	¬Q2369
		30	2379	¬Q2379
Times New Roman italic outline	Prop.	6	2310	¬Q2310
		8	2320	¬Q2320
		10	2330	¬Q2330
		12	2340	¬Q2340
		14	2350	¬Q2350
		18	2360	¬Q2360
		24	2370	¬Q2370
		30	2380	¬Q2380
Times New Roman bold italic outline	Prop.	6	2311	¬Q2311
		8	2321	¬Q2321
		10	2331	¬Q2331
		12	2341	¬Q2341
		14	2351	¬Q2351
		18	2361	¬Q2361
		24	2371	¬Q2371
		30	2381	¬Q2381

Font	Pitch	Point Size	Type-style No.	Font-Change Command
Universal Cartridge 1255800				
Prestige Elite	12	10	86*	-Q86
Prestige Elite italic	12	10	112	-Q112
Courier italic	10	12	18	-Q18
Presentor	10	14	25	-Q25
Letter Gothic	12	12	87*	-Q87
Letter Gothic italic	12	12	109	-Q109
Letter Gothic symbol	12	12	80*	-Q80
Times Roman	Prop.	10	5687	-Q5687
Times Roman bold	Prop.	10	5707	-Q5707
Times Roman italic	Prop.	10	5815	-Q5815
Helvetica	Prop.	10	34103	-Q34103
Helvetica bold	Prop.	10	34123	-Q34123
Helvetica italic	Prop.	10	34231	-Q34231
Letter Gothic symbol	12	12	88	-Q88
Italic Cartridge 1255801				
Courier italic	10	12	18	-Q18
Courier symbol	10	12	8	-Q8
Courier italic	12	10	92	-Q92
Courier	15	9	223*	-Q223
Courier bold italic	Prop.	12	155	-Q155
Courier symbol	10	12	13*	-Q13
Prestige Cartridge 1255802				
Prestige Pica	10	12	12*	-Q12
Prestige Elite	12	10	86*	-Q86
Prestige Elite bold	12	10	111	-Q111
Prestige Elite italic	12	10	112	-Q112
Prestige	17.1	8.5	256	-Q256
	Prop.	12	164	-Q164
Prestige Elite symbol	12	10	89	-Q89

5250 REMOTE EMULATOR CARD

Font	Pitch	Point Size	Type-style No.	Font-Change Command
Letter Gothic Cartridge 1555803				
Letter Gothic	10	14	36	-Q36
	12	12	87*	-Q87
Letter Gothic bold	12	12	110	-Q110
Letter Gothic italic	12	12	109	-Q109
Letter Gothic symbol	12	12	88	-Q88
Delegate Cartridge 1255804				
Delegate	10	12	2	-Q2
Adjutant	12	10	95	-Q95
Modern	Prop.	12	158*	-Q158
Essay	Prop.	12	160*	-Q160
Essay italic	Prop.	12	162*	-Q162
Script/OCR Cartridge 1255805				
Script	12	10	84*	-Q84
Olde World	12	10	96	-Q96
Title	Prop.	12	157	-Q157
APL	12	10	76	-Q76
OCR-A	10	12	19	-Q19
OCR-B	10	12	3	-Q3
APT/TN	12	10	77	-Q77
Orator Cartridge 1255806				
Orator bold	8.1	16	434	-Q434
	6.5	18	435	-Q435
Orator	10	14	5*	-Q5
Compressed Cartridge 1225807				
Prestige	15	9	221	-Q221
Letter Gothic	15	9	222*	-Q222
	17.1	8.5	255	-Q255
	20	7.5	281	-Q281
	25	6	285	-Q285
Letter Gothic light italic	12	10	91*	-Q91

Font	Pitch	Point Size	Type-style No.	Font-Change Command
Press Roman Cartridge 1255808				
Press Roman	Prop.	10	186	¬Q186
Press Roman bold	Prop.	10	187	¬Q187
Press Roman italic	Prop.	10	188	¬Q188
Press Roman bold italic	Prop.	10	189	¬Q189
Press Roman symbol	12	10	185	¬Q185
Foundry Cartridge 1255809				
Foundry	Prop.	10	190	¬Q190
Foundry bold	Prop.	10	191	¬Q191
Foundry italic	Prop.	10	194	¬Q194
Foundry italic bold	Prop.	10	195	¬Q195
Foundry symbol	Prop.	10	192	¬Q192
Testimonial Cartridge 1255820				
Testimonial	Prop.	12	5943	¬Q5943
		14	5944	¬Q5944
		18	5945	¬Q5945
Engravers' Old English Cartridge 1255821				
Engravers' Old English	Prop.	12	37431	¬Q37431
		14	37432	¬Q37432
		18	37433	¬Q37433
Times Roman Cartridge 1255822				
Times Roman	Prop.	12	5688	¬Q5688
Times Roman bold	Prop.	14	5709	¬Q5709
		18	5710	¬Q5710
Times Roman Cartridge 1255823				
Times Roman	Prop.	6	5685	¬Q5685
		8	5686	¬Q5686
Times Roman bold italic	Prop.	10	5835	¬Q5835
Times Roman	Prop.	10	5687	¬Q5687
Times Roman bold	Prop.	10	5707	¬Q5707
Times Roman italic	Prop.	10	5815	¬Q5815

5250 REMOTE EMULATOR CARD

Font	Pitch	Point Size	Type-style No.	Font-Change Command
Combo (Data Stream 1) Cartridge 1255824				
Prestige Elite	12	10	86*	-Q86
Helvetica	Prop.	14	34105	-Q34105
Orator	10	14	5*	-Q5
OCR-A	10	12	19	-Q19
OCR-B	10	12	3	-Q3
Helvetica Cartridge 1255825				
Helvetica	Prop.	12	34104	-Q34104
Helvetica bold	Prop.	14	34125	-Q34125
		18	34126	-Q34126
Helvetica Cartridge 1255826				
Helvetica	Prop.	6	34101	-Q34101
		8	34102	-Q34102
Helvetica bold italic	Prop.	10	34251	-Q34251
Helvetica	Prop.	10	34103	-Q34103
Helvetica bold	Prop.	10	34123	-Q34123
Helvetica italic	Prop.	10	34231	-Q34231
Cursive Cartridge 1255827				
Cursive	Prop.	12	41783	-Q41783
		14	41803	-Q41803
		18	41804	-Q41804
Palatino® Cartridge 1255828				
Palatino	Prop.	12	6200	-Q6200
		14	6219	-Q6219
		18	6220	-Q6220
Palatino Cartridge 1255829				
Palatino	Prop.	6	6197	-Q6197
		8	6198	-Q6198
		10	6199	-Q6199
Palatino bold	Prop.	10	6218	-Q6218
Palatino italic	Prop.	10	6327	-Q6327
Palatino bold italic	Prop.	10	6347	-Q6347

Font	Pitch	Point Size	Type-style No.	Font-Change Command
Optima Cartridge 1255830				
Optima	Prop.	12	33336	-Q33336
Optima bold	Prop.	14	33356	-Q33356
		18	33357	-Q33357
Optima Cartridge 1255831				
Optima	Prop.	6	33333	-Q33333
		8	33334	-Q33334
		10	33335	-Q33335
Optima bold	Prop.	10	33355	-Q33355
Optima italic	Prop.	10	33463	-Q33463
Optima bold italic	Prop.	10	33483	-Q33483
Century Schoolbook Cartridge 1255832				
Century Schoolbook	Prop.	12	16952	-Q16952
Century Schoolbook bold	Prop.	14	16972	-Q16972
		18	16973	-Q16973
Century Schoolbook Cartridge 1255833				
Century Schoolbook	Prop.	6	16949	-Q16949
		8	16950	-Q16950
		10	16951	-Q16951
Century Schoolbook bold	Prop.	10	16971	-Q16971
Century Schoolbook italic	Prop.	10	17079	-Q17079
Century Schoolbook bold italic	Prop.	6	17099	-Q17099
Goudy Old Style Cartridge 1255834				
Goudy Old Style	Prop.	12	4920	-Q4920
Goudy Old Style bold	Prop.	14	4940	-Q4940
Goudy Old Style bold	Prop.	18	4941	-Q4941
Goudy Old Style Cartridge 1255835				
Goudy Old Style	Prop.	6	4917	-Q4917
		8	4918	-Q4918
		10	4919	-Q4919
Goudy Old Style bold	Prop.	10	4939	-Q4939
Goudy Old Style italic	Prop.	10	5047	-Q5047
Goudy Old Style bold italic	Prop.	10	5067	-Q5067

5250 REMOTE EMULATOR CARD

Font	Pitch	Point Size	Type-style No.	Font-Change Command
Baskerville Cartridge 1255836				
Baskerville	Prop.	12	8504	-Q8504
Baskerville bold	Prop.	14	8524	-Q8524
		18	8525	-Q8525
Baskerville Cartridge 1255837				
Baskerville	Prop.	6	8501	-Q8501
		8	8502	-Q8502
		10	8503	-Q8503
Baskerville bold	Prop.	10	8523	-Q8523
Baskerville italic	Prop.	10	8631	-Q8631
Baskerville bold italic	Prop.	10	8651	-Q8651
Futura Cartridge 1255838				
Futura Book	Prop.	12	33592	-Q33592
Futura Heavy	Prop.	14	33602	-Q33602
		18	33603	-Q33603
Futura Cartridge 1255839				
Futura Book	Prop.	6	33589	-Q33589
		8	33590	-Q33590
		10	33591	-Q33591
Futura Heavy	Prop.	10	33601	-Q33601
Futura Book italic	Prop.	10	33719	-Q33719
Futura Heavy italic	Prop.	10	33729	-Q33729
Code 3 of 9	N/A	4.6	21	-Q21
		8.1	22	-Q22
EAN/UPC	N/A	13 mil	23	-Q23
		10 mil	24	-Q24
USPS Zip	N/A	N/A	26	-Q26
Line Draw	N/A	N/A	312	-Q312

Table C-7. HP4029 Mode Fonts (Resident).

Font	Pitch	Point Size	Type-style No.	Font-Change Command
Courier	10	12	11*	-Q11
Courier bold	10	12	46	-Q46
Courier	15	8.5	223*	-Q223
	17.1	8.5	254	-Q254

5250 REMOTE EMULATOR CARD

Table C-8. HP4029 Mode Fonts (on HP Font Cartridges).

Font	Pitch	Point Size	Type-style No.	Font-Change Command
Combo Cartridge 1255824				
OCR-A	10	12	19	-Q19
OCR-B	10	12	3	-Q3
Prestige Elite	12	10	86*	-Q86
Orator	10	14	5*	-Q5
Courier	12	10	85*	-Q85
Helvetica	Prop.	14	34105	-Q34105
Supports M Cartridge 1255841				
Prestige Elite	12	10	86*	-Q86
Prestige Elite bold	12	10	111	-Q111
Prestige Elite italic	12	10	112	-Q112
Supports R Cartridge 1255842				
Orator bold	6.5	18	435	-Q435
	8.1	16	434	-Q434
	10	14	38	-Q38
Letter Gothic	10	14	40	-Q40
Lines I	10	14	31	-Q31
Lines II	10	14	32	-Q32

Font	Pitch	Point Size	Type-style No.	Font-Change Command
Supports U/V Cartridge 1255843				
Swiss 721	Prop.	6	34101	¬Q34101
		8	34102	¬Q34102
Swiss 721 bold	Prop.	10	34123	¬Q34123
		12	34124	¬Q34124
		14	34125	¬Q34125
Letter Gothic	15	9.5	230	¬Q230
Supports Z Cartridge 1255844				
Press Roman	Prop.	8	185	¬Q185
		10	186	¬Q186
Press Roman bold	Prop.	10	187	¬Q187
Press Roman italic	Prop.	10	188	¬Q188
Press Roman	Prop.	12	189	¬Q189
Press Roman bold	Prop.	12	190	¬Q190
Press Roman italic	Prop.	12	191	¬Q191
Press Roman bold	Prop.	14	192	¬Q192
Letter Gothic	17.1	8.5	255	¬Q255
Supports Z Cartridge 1255845				
Swiss 721	Prop.	10	34103	¬Q34103
Swiss 721 italic	Prop.	10	34231	¬Q34231
Swiss 721	Prop.	12	34104	¬Q34104
Swiss 721 italic	Prop.	12	34232	¬Q34232
Swiss 721	Prop.	8	34102	¬Q34102
Swiss 721 bold	Prop.	10	34123	¬Q34123
		12	34124	¬Q34124
		14	34125	¬Q34125
Letter Gothic	17.1	8.5	255	¬Q255

5250 REMOTE EMULATOR CARD

Font	Pitch	Point Size	Type-style No.	Font-Change Command
Courier	10	12	11*	-Q11
Courier bold	10	12	46	-Q46
Courier italic	10	12	18	-Q18
Courier bold	12	10	108	-Q108
Courier italic	12	10	92	-Q92
Courier	16.7	8.5	252	-Q252
	12	10	85*	-Q85
Supports N Cartridge 1255847				
Letter Gothic	12	12	87*	-Q87
Letter Gothic bold	12	12	110	-Q110
Letter Gothic italic	12	12	109	-Q109
Supports T Cartridge 1255848				
Swiss 721	Prop.	6 8	34101 34102	-Q34101 -Q34102
Swiss 721 bold	Prop.	10 12 14 8	34123 34124 34125 34122	-Q34123 -Q34124 -Q34125 -Q34122
Tax Line Draw	10	12	30	-Q30
OCR-A	10	12	19	-Q19
Bar None Cartridge				
Code 3 of 9	N/A	4.6 8.1	21 22	-Q21 -Q22
EAN/UPC	N/A	13 mil 10 mil	23 24	-Q23 -Q24
USPS Zip	N/A	N/A	26	-Q26
Letter Gothic (Roman 8)	N/A	10 12 15	36 88 225	-Q36 -Q88 -Q225
Presentation (Roman 8)	N/A	18	50	-Q50
Presentation (Legal)	N/A	18	51	-Q51
Line Draw	N/A	N/A	312	-Q312

Appendix D: Keyboard-Scan Codes

The keyboard diagrams on the next two pages show the four types of keyboards you will normally encounter in 5250 Remote Emulator Card applications, along with the factory-default values of their scan codes. You can change the scan codes that the Card relays from the keyboard connected to the Card's PC by using the Scan Code Customize option under the Advanced Functions—Keyboard menu in the configuration software (see **Section 6.3.2**). To make sure which code maps to which function, see **Appendix E**.

PC Keyboard

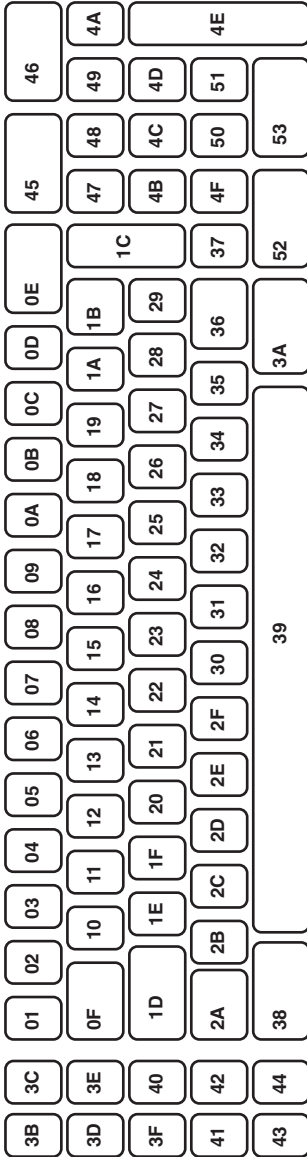

AT Keyboard

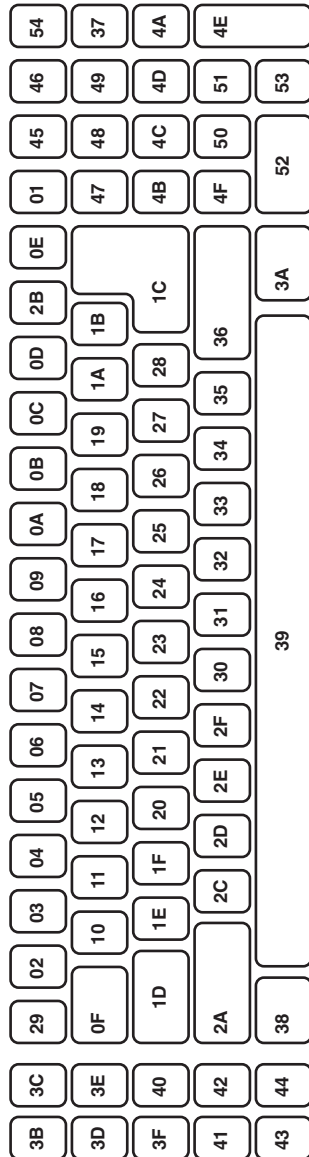

5250 Keyboard

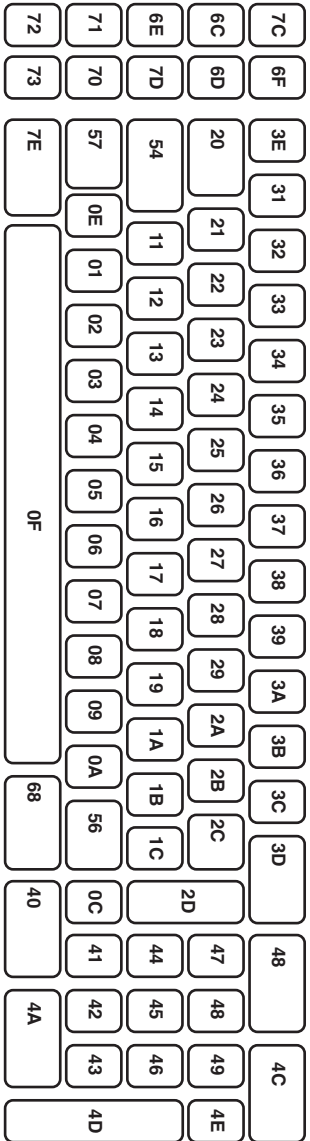

Enhanced PC Keyboard



Appendix E: Keyboard Templates

Table E-1 below gives a general definition for each 5250 (host) key. Use the table with the keyboard templates on the next eight pages to keep track of where the functions you need are. There is one keyboard template for each possible combination of PC Keyboard and Emulated Keyboard (see **Section 6.2.2**). In addition, there are two pairs of templates for the Enhanced keyboard, one for the USA / CAN (ORIG) language and one for the USA / CAN (TERM) language (see **Section 6.2.3**). (We've included an Emulator Card template with each keyboard template to give you a set of single-page quick reference guides.)

Use the information in this appendix with that in **Appendix D** when you want to customize your keyboard's scan codes.

Table E-1. Key Functions

5250 Keys	Functions of the Keys
[CMD]	Causes the host to disregard the normal function of a repeating key and perform the function assigned in the host's program instead.
[DEL]	Deletes the character where the cursor is located.
[DUP]	Requests that the host program duplicate the data from the same field in the previous record.
[ERASE INPUT]	Erases data entered in all input fields. The cursor will move to the top left corner of the screen.
[ERROR RESET]	Unlocks keyboard after it is locked because of an error condition. Will also reset the help, insert, command, and system-request modes.
[FIELD +]	Can be used as a field-exit key in all fields.
[FIELD -]	Operates much like the [FIELD +] key, but in signed-numeric and numeric fields only.
[FIELD EXIT]	Used to exit fields that are specified in a program as field-exit required, or as right-justified.
[HELP]	Describes the current error condition. The [ERROR RESET] key will reset the help message and error condition to restore the screen and unlock the keyboard.

PC Style on Enhanced Keyboard (ORIG)

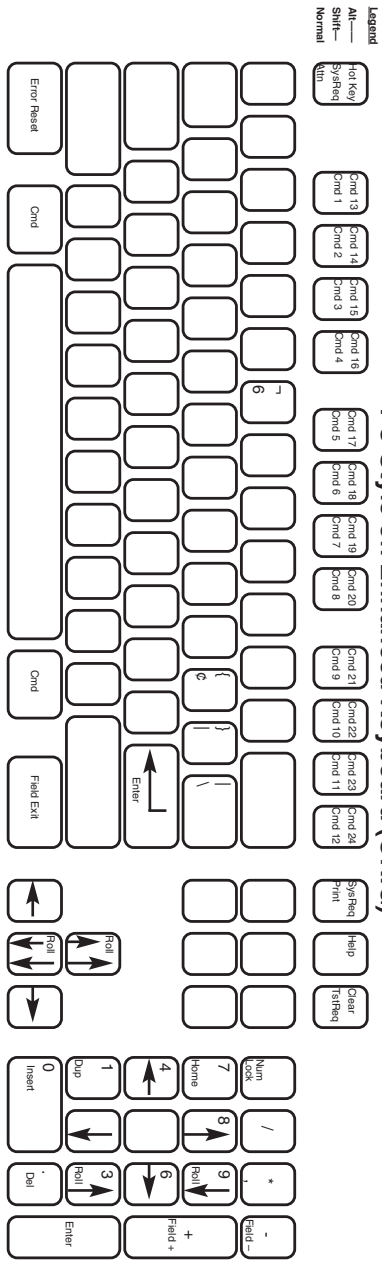

Template for the 5250 Remote Emulator Card

- Command Summary:**
 Configuration Program: EMCONFIG
 Start Emulation: EM5251
- End Emulation:**
 at 3X or AS/400 Main Menu: OFF [ENTER]
 at 3X or AS/400 Sign-On Screen: [ALT] [CTRL] [DEL]
- Hotkey to DOS or Printer-Control Screen:** [ALT] [ESC]
- Status Line:**
 rr-cc Cursor location (row-column)
 SA System Available
 MW Message Waiting
 KS Keyboard Shift
 IM Insert Mode
 II Input Inhibited
 KB Keyboard Buffering
 Sn n = active logical unit
 An n = active host address

PC Style on Enhanced Keyboard (TERM)

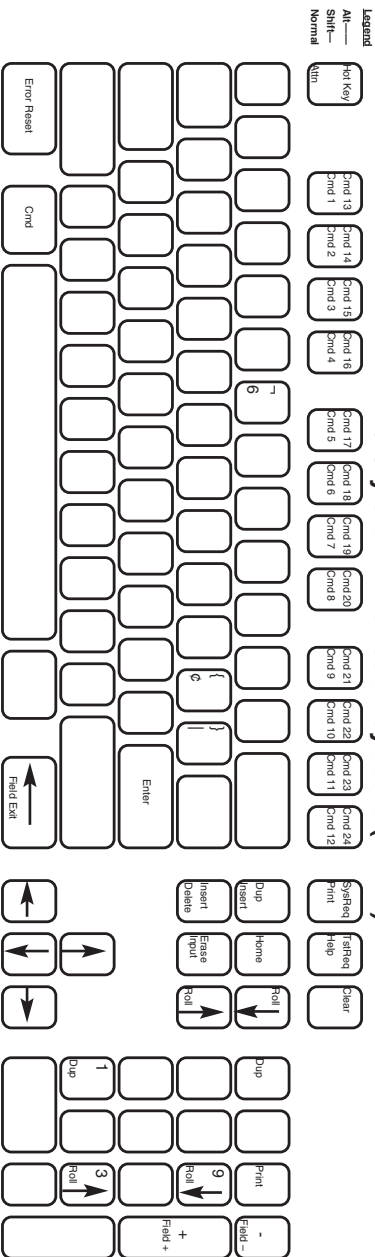

Template for the 5250 Remote Emulator Card

Command Summary:
 Configuration Program: EMCONFIG
 Start Emulation: EM5251

Status Line:
 rr-cc Cursor location (row-column)
 SA System Available
 MW Message Waiting
 KS Keyboard Shift
 IM Insert Mode
 II Input Inhibited
 KB Keyboard Buffering
 Sn n = active logical unit
 An n = active host address

End Emulation: OFF [ENTER]
 at 3X or AS/400 Main Menu: [ALT] [CTRL] [DEL]
 at 3X or AS/400 Sign-On Screen: [ALT] [ESC]

Hotkey to DOS or Printer-Control Screen: [ALT] [BSC]

PC Style on AT Keyboard

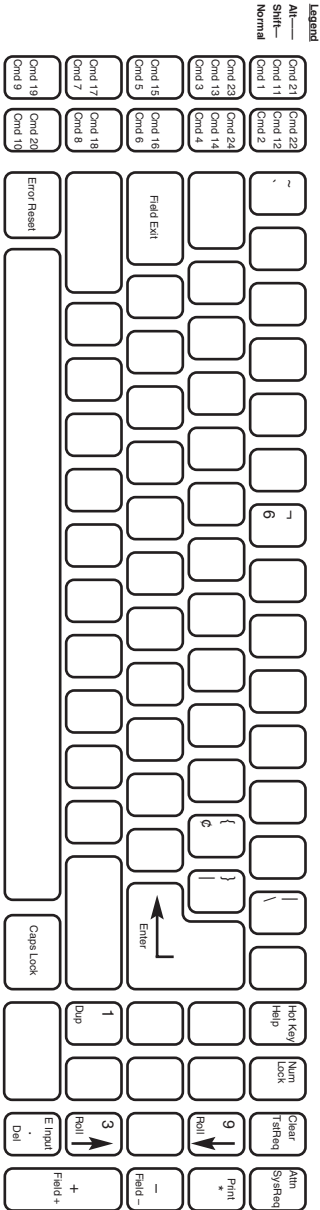

Template for the 5250 Remote Emulator Card

Command Summary:

Configuration Program: EMCONFIG

Start Emulation: EM5251

End Emulation:

at 3X or AS/400 Main Menu: OFF [ENTER]

at 3X or AS/400 Sign-On Screen: [ALT] [CTRL] [DEL]

Hotkey to DOS or

Printer-Control Screen: [ALT] [BSC]

Status Line:

rr-cc Cursor location (row-column)

SA System Available

MW Message Waiting

KS Keyboard Shift

IM Insert Mode

II Input Inhibited

KB Keyboard Buffering

Sn n = active logical unit

An n = active host address

PC Style on PC Keyboard

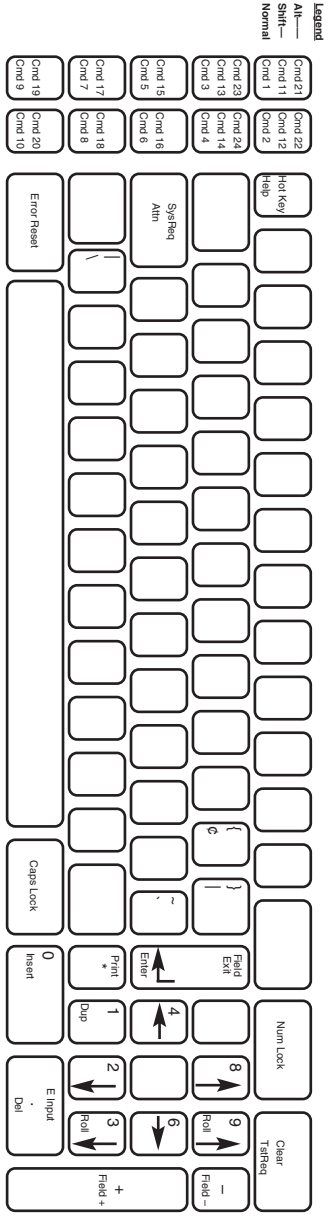

Template for the 5250 Remote Emulator Card

Command Summary:
 Configuration Program: EMCONFIG
 Start Emulation: EMS251
 End Emulation: OFF [ENTER]
 at 3X or AS/400 Main Menu: [ALT] [CTRL] [DEL]
 at 3X or AS/400 Sign-On Screen: [ALT] [ESC]
 Hotkey to DOS or Printer-Control Screen: [ALT] [ESC]

Status Line:
 rr-cc Cursor location (row-column)
 SA System Available
 MW Message Waiting
 KS Keyboard Shift
 IM Insert Mode
 II Input Inhibited
 KB Keyboard Buffering
 Sn n = active logical unit
 An n = active host address

Appendix F: Related Documentation

Here is a list of manuals that might be helpful during the installation and operation of PC Support:

IBM PC Support/36 Messages Guide, SC21-9525

IBM PC Support/36 Organizer, SC21-9563

IBM PC Support/36 User's Guide, SC21-9088

IBM PC Support/38 Messages Guide, SC21-9360

IBM PC Support/38 Technical Reference, SC21-9090

IBM PC Support/38 User's Guide, SC21-9089

IBM PC Support AS/400 DOS Installation and Administration Guide,
SC41-0006

IBM PC Support AS/400 DOS and OS/2 Technical Reference, SC41-
8091

IBM PC Support AS/400 User's Guide for DOS, SC41-8199

Glossary

active session: The host session that you are currently using, as opposed to an inactive session.

adapter, adaptor: A card that provides communications between part of a device and the processor.

address: In a computer, the location where the data is stored.

API (Application Program Interface): System software that provides resources to create user-interface features and to route programs or data.

APO (Auto Page Orientation): Software decides by the size of the page if the data is to be printed in landscape or portrait orientation.

application: Software program used on a personal computer (PC).

ASCII (American Standard Code for Information Interchange): The character set used by personal computer systems, as opposed to EBCDIC, the set used by IBM mainframes. Systems that link PCs to these mainframes must include a device to translate between the two character sets.

attribute: A characteristic, such as “bold” or “italic.”

auto configure: Configures a program automatically during the initialization process.

automatic printer sharing: Automatically switches from PC printing to host printing and vice versa.

backup: To save a second copy of data on some storage medium.

balun: The device used to convert twisted-pair wiring to the twinax connectors used on the T-connector.

baud rate: The transmission speed of the serial port, which is measured in bits per second (bps).

BGU: Business Graphics Utility.

BIOS (Basic Input/Output System): A set of programs encoded in read-only memory (ROM) of IBM PC-compatible computers that facilitate the transfer of data and control instructions between the computer and peripherals.

blank character: A character that is not displayed but occupies a position on the display screen.

buffer: An area in the memory that holds data temporarily.

cache memory: RAM (random access memory) set aside to store the most frequently accessed information stored in RAM.

character: A letter of the alphabet, a number, punctuation mark, or any other symbol that represents information.

character set: A set of alphabetic, numeric, and special characters that may be displayed or printed by a system unit or device.

code page: Set of coded characters often displayed as an array or code table.

column separator: A vertical line used to separate one field from another.

command: An instruction that directs the system to perform a particular operation.

command keys: The keys on the top row(s) of the keyboard that are used to request a pre-assigned function of the system.

command pass-through: This feature gives you access to all of a printer's built-in features, even if these features are not normally available through the host software. Printer-specific command sequences are placed into the data sent to the printer from the host. The display station recognizes these sequences and "passes the command through" to the printer.

configuration: Software setup of a computer program or system.

connector: A plug connected to a cable that fastens to a port of a device.

controller: A device used to coordinate and control the operation of one or more devices with a remote host system.

COR (Computer Output Reduction): Rotates data-processing reports to landscape orientation and then compresses the text to fit pages measuring 198 columns by 66 lines.

cpi: Characters per inch.

CTS (Clear to Send): The attached DTE may begin transmitting.

cursor: A character which indicates the position that data entry will occur.

DCD (Data Carrier Detect): The local modem is receiving data from the remote modem.

default: The value assumed when no other value is specified.

default setting: The standard setting for a feature which automatically appears unless the user selects a different setting.

delimiter: A character that marks the beginning and/or end of a unit of data.

DIP switch: Used to provide user-accessible configuration settings.

direct access: A hotkey sequence used to take the user directly to the next host session configured.

display screen: A cathode-ray tube that is used to display alphanumeric characters.

display station: An input/output device containing a display screen and an attached keyboard. Also called a terminal.

DOS (Disk Operating System): A single-user operating system developed by Microsoft. DOS can be referred to as PC-DOS for the PC, PS/1, and PS/2 series, or referred to as MS-DOS for non-IBM PCs.

DOS EMM386: A type of memory-management software.

dot-matrix: A text printer that prints a series of dots to create characters.

driver: A program routine that contains instructions necessary to control the operation of a peripheral.

DRS (Data Set Ready): This indicates that the modem is connected to the telephone circuit.

DTE (Data Terminal Equipment): A “communication destination” device such as a PC or terminal, as opposed to a “communication relay” device such as a modem.

duplex: Prints on both sides of the paper.

EBCDIC (Extended Binary Coded Decimal Interchange Code): The character set used by IBM mainframes, as opposed to ASCII, the set used by most personal computer systems.

emulation: The duplication or imitation of one device by another device.

emulator card: A card that is installed into a PC, which enables the PC and PC printer to emulate host devices while allowing access to PC applications.

expanded memory: When storage of the RAM on the board makes the size of the computer larger than it actually is.

extended memory: Memory that has been added to allow programs greater than 640K of RAM to run on a computer.

FGID (Font Global Identifier): Font identifier used by IBM to standardize typestyle numbers used globally.

field attributes: Control characters stored in the character buffer in the first character position of a field.

field: An undefined area that contains a certain type of data.

file extension: A three-letter suffix, used to describe a file's contents, appended to a DOS file name.

file transfer: A process used to transfer a file from one storage location to another.

font: (1) A collection of characters of a given typeface and (sometimes) size. (2) Used generically to mean the collection of coded fonts, font-character sets, and code pages. (3) A font file that contains characters that must be used in conjunction with a code-page file.

form feed: The advancing of a form in the printer to the top of the next page by a code sent to the printer from the computer.

hex, hexadecimal: A number system with a base of sixteen, using the "digits" 0 through 9 and A through F.

hex transparency: See command pass-through.

host: The central controlling processing unit in a twinax environment.

hot key, hotkey: A particular key or key combination that accesses a menu command.

HP mode: Third-party printer, if compatible, will receive HP LaserJet commands.

IBM mode: Same as HP, but will receive IBM LaserJet commands.

interface: The hardware and/or software that permit the exchange of information between computers or devices.

intensity: The brightness level at which characters are displayed on screen.

I/O (Input/Output): Transferring of data between the central processing unit and a peripheral device. Each transfer is an output from one device and an input into another device.

IRQ (Interrupt Request) Level: A hardware flag to the PC software that a hardware product needs immediate interaction with the software.

keyboard template: Pattern of a keyboard.

key click: Keys will make clicking sounds when depressed unless disabled.

landscape: A printing orientation in which the text prints across the length of a page.

LED (light-emitting diode): A light located on the back of the emulator card that lights up when the card communicates with the host.

line feed: A character code that advances the cursor on screen or in the printer to the next line.

logical unit (abbreviated "LU"): Manages the exchange of data between the user and a host application.

lpi (lines per inch): The number of lines per vertical inch of paper.

macros: Keystrokes that have been saved and which can be played back.

memory address: A code number that specifies a specific area in a computer's random access memory (RAM).

message line: See status message.

microcode: One or more micro instructions.

Microsoft Windows: Windowing environment and application-program interface (API) for DOS that gives IBM PCs and compatibles a graphical user interface.

motherboard: The main circuit board in a PC.

nonshifted: Allows keys to be entered as characters or functions similar to when a shift key is not held down on a PC or typewriter.

NRZ (Non-return to Zero): A binary encoding technique in which a change in state represents a binary one, and no change in state represents a binary zero.

NRZI (Non-return to Zero Inverted): A binary encoding technique in which a change in state represents a binary zero and no change in state represents a binary one.

parity: Error-detection system for a serial device. A method of error detection in which a redundant bit is added to each character in order to make the sum of the bits in the character either even or odd.

PC Support: An IBM host/PC communications program that provides the emulator card with access to virtual-disk, virtual-printer, and shared-folder functions.

pitch: The number of characters per horizontal inch, or the positioning intervals of characters in a line of text.

pixel: The smallest displayable unit on a video screen, out of which the displayed image is constructed.

portrait: A printing orientation in which the text prints across the width of a page.

PPDS (Personal Printer Data Stream): A printer-programming language for some IBM laser printers.

prompt: A display symbol, word, or phrase that requests the user to enter data from the keyboard.

RAM (Random Access Memory): A storage device in which data is entered and retrieved in a non-sequential manner.

record/playback: Keyboard macro used to save keystrokes and then play them back.

resident: Program is in the memory.

root directory: Directory that contains a list of files stored on that disk.

Round-Robin: A hotkey sequence used to take the user sequentially through the highest host session, then to the Printer Control Screen, and then to DOS.

router: PC Support/36, /38 and AS/400 programs that run on the personal computer (PC) and the host system. Routers manage communications between the PC Support facilities on the system and PC.

RTS (Request to Send): This indicates that the DTE has data to send.

RXD (Receive Data): Data from the host is being received by the 5250 Remote Emulator Card.

scan code: Code used to transmit data from the keyboard to the PC.

session: An active connection between the terminal emulation and a host system. A session is opened when the user signs on.

Set Text Orientation (STO): This command causes text to be printed in a specified orientation regardless of paper size.

SDLC (Synchronous Data Link Control): An IBM communications protocol commonly used in SNA environments.

simplex: Prints on only one side of the paper.

status attributes: An option used to define how the status line is displayed.

status line: An information line displayed on screen that displays information to the operator concerning the processing of the text.

status message: Information on the last line of the display screen that tells the operator about display station conditions.

stop bits: The number of bits sent to terminate each character sent to a serial printer.

third-party: Software and/or hardware made by a company other than the original manufacturer.

truncate: To break off a part of a number or character string.

twisted pair: A pair of small insulated wires, commonly used in telephone cables, that are twisted around each other to minimize interference from other wires in the cable.

TXD (Transmit Data): Data is being transmitted by the 5250 Remote Emulator Card to the host.

upper memory block: A block of memory between the 640K unit of conventional memory and the 1MB running on MS-DOS on an IBM-compatible PC.

virtual disk: Lets the user assign a portion of the host disk to the PC.

virtual printer: Lets users print data from the PC to a host-system printer.

workstation: A display station or printer.

Index

1	
132-column	16, 43
15-pitch printing	48
17 to 15 Pitch Correction	48
3	
3812 printer emulations	61
3812/5219 printer emulation	17
5	
5219 emulation	69, 70, 101
5219 printer emulations	61
5250 (host) key	131
6	
6-LPI printing	73, 74
A	
address conflict	32
Advanced Functions	30, 38
APO	48, 63
AS/400	18
ASCII-character table	38
Auto Printer Sharing	48
Automatic Page Orientation (APO)	62
B	
backup copy	25
Base I/O Address	37
Basic Configuration	30, 31
Basic Setup	33
C	
Cable Addresses	31
Calling Your Supplier	91
CCITT V.35	23
CCITT X.21	23
Clearing All Sequences	62
Code Page	47
Column Separator	38
COM port	33

command language	72
command pass-through	17, 61, 74, 75
communication port	23
Computer Output Reduction (COR)	48, 62
Configuration Menu	31
configuration options	31
Controller Station Address	36
Controller Type	36
CPT Delimiters	47
CSU/DSU	80
Cursor Type	40

D

DCD	79, 80
default configuration	15, 28, 29
diagnostic program	22, 76
DIP switch	20, 22
Direct Access	53
Direct Hot Key	34
Display Adaptor	40
DMA (Direct Memory Access) channels	37
DMA Channel 1	37
DMA Channel 3	37
DOS graphics applications	43
DOS prompt	25
DOS session	52
DOS partition 2	5
DSR	79, 80
duplex mode	72
Duplex Printing	71

E

EBCDIC to ASCII	40, 47
EIA RS-232D	16
EIA RS-232D/CCITT V.24	23
escape commands	17
execute command	51

F

Field Attributes	39, 40
File Transfer	34
font IDs	63, 73
font-change commands	66, 72, 73
font-ID pitch	73

H	
hexadecimal character codes	47
horizontal spacing	75
Host Address	32
host ID	55
host session	52
host sessions	44
Hot Key Code	43
hotkey	4, 50, 51, 52, 53, 60
HP or PPDS modes	62

I	
I/O address	37
I/O addresses 20, 22	
IBM 3812 (non-IPDS) printer 62	
IBM System/34, /36, /38	18
IBM typestyle number or font ID	69
IBM® AS/400®	16
IRQ (Interrupt Request)	37

K	
key click	34
keyboard emulation	77
Keyboard Setup	43
Keyboard Setup option	27
keyboard template	34, 131
keyboard type	44
keystroke sequence	61

L	
Language options	35
local operation	23
local station address	32
Logical Unit (LU)	32
LPT port	33

M	
Main Menu	29, 31, 45
Manual Feed	71
modem	23, 37, 80
modem-loopback test	22, 23
Monitor Type	34

N

Near Letter Quality	45
NRZ/NRZI Encoding	37
null-modem cable	37

O

OEM text	52
Orientation	48

P

Page Length	66
Paper Size	66
parallel printers	33
PC motherboard	20
PC printing	58
PC Support/38	27, 34
PC Support/400	29, 37, 49
PC-to-twinax connectivity	16
Play mode	62
printer definition	33
Printer-Control Screen	48, 56, 58, 59
Printer-Override Screen	59
Printer-Setup Menu	45
Printing	55

R

Record/Playback	61
remote operation	23
Round-Robin	53
Round-Robin (Scrolling)	53, 54
RPG-generated printouts	69
RTS	79

S

Save Buffer	43
Scan Code Customize	44
SDLC link	16
SDLC parameters	36
SDLC protocol	18
serial printers	33
session-status line	54
Shipping and Packaging	91
station address	77, 78

5250 REMOTE EMULATOR CARD

Status Attributes	39
System Menu	52
System/34	36
System/36 and System/38	36
System/38	68, 70, 71
System/3X	16
Text Management/38	70
TX	79

U

U. S. National EBCDIC	95
U.S. National ASCII code set	95

V

V.35	16
Virtual Disk	34, 50

W

Windows	27, 28, 44
Word Processing	66, 69
word-processing programs	70

X

X.21	16
------------	----



© Copyright 1999. Black Box Corporation. All rights reserved.

1000 Park Drive • Lawrence, PA 15055-1018 • 724-746-5500 • Fax 724-746-0746