

Signalling Link

CONTENTS

Contents	i
List of Figures	iii
1. General	1
1.1 Introduction	1
1.2 Signal Unit Delimitation and Alignment	3
1.3 Error Detection	3
1.4 Error Correction	3
1.5 Initial Alignment	4
1.6 Signalling Link Error Monitoring	4
1.7 Link State Control Functions	4
1.8 Flow Control	4
2. Basic Signal Unit Format	6
2.1 General	6
2.2 Signal Unit Format	6
2.3 Function and Codes of the Signal Unit Fields	6
2.4 Order of Bit Transmission	8
3. Signal Unit Delimitation	9
3.1 Flags	9
3.2 Zero Insertion and Deletion	9
4. Acceptance Procedure	10
4.1 Acceptance of Alignment	10
4.2 Error Detection	10
5. Basic Error Correction Method	12
5.1 General	12
5.2 Acknowledgements	12
5.3 Retransmission	14
6. Error Correction by Preventive Cyclic Retransmission	16
6.1 General	16
6.2 Acknowledgements	16
6.3 Preventive Cyclic Retransmission	17
6.4 Forced Retransmission	18
7. Initial Alignment Procedures	18
7.1 General	18
7.2 Initial Alignment Status Indications	18
7.3 Initial Alignment Procedure	19
7.4 Proving Periods	20
7.4A Initial Alignment Timers	20
8. Processor Outage	22

9.	Level 2 Flow Control	23
9.1.	General	23
9.2.	Detection of Congestion	23
9.3.	Procedure in the Congestion Situation	23
9.4.	Congestion Abatement Procedure	23
10.	Signalling Link Error Monitoring	24
10.1.	General	24
10.2.	Signal Unit Error Rate Monitor	24
10.3.	Alignment Error Rate Monitor	25
11.	Level 2 Codes and Priorities	26
11.1.	Link Status Signal Unit	26
11.2.	Transmission Priorities Within Level 2	26
12.	State Transition Diagrams	28
12.1.	Diagram Summary	28
12.2.	Abbreviations and Timers Used in Figures 7/ Q.703 to 19/ Q.703	29

Signalling Link

LIST OF FIGURES

Figure 1	Q.703: Interactions of the functional specification blocks for signalling link control	2
Figure 2	Q.703: Overview Diagram of Link State Control	5
Figure 3	Q.703: Signal Unit Formats	7
Figure 4	Q.703: Overview Diagram of Initial Alignment Control	21
Figure 5	Q.703: Relationship Between the Expected Number of Signal Units to Fault Indication and Signal Unit Error Rate	24
Figure 6	Q.703: Status Field Format	26
Figure 7	Q.703: Level 3 - Functional Block Diagram	35
Figure 8	Q.703: Link State Control (Sheet 1 of 7)	36
Figure 8	Q.703: Link State Control (Sheet 2 of 7)	37
Figure 8	Q.703: Link State Control (Sheet 3 of 7)	38
Figure 8	Q.703: Link State Control (Sheet 4 of 7)	39
Figure 8	Q.703: Link State Control (Sheet 5 of 7)	40
Figure 8	Q.703: Link State Control (Sheet 6 of 7)	41
Figure 8	Q.703: Link State Control (Sheet 7 of 7)	42
Figure 9	Q.703: Initial Alignment Control (Sheet 1 of 3)	43
Figure 9	Q.703: Initial Alignment Control (Sheet 2 of 3)	44
Figure 9	Q.703: Initial Alignment Control (Sheet 3 of 3)	45
Figure 10	Q.703: Processor Outage Control	46
Figure 11	Q.703: Delimitation, Alignment and Error Detection (Receiving)	47
Figure 12	Q.703: Delimitation, Alignment and Error Detection (Transmitting)	48
Figure 13	Q.703: Basic Transmission Control (Sheet 1 of 2)	49
Figure 13	Q.703: Basic Transmission Control (Sheet 2 of 2)	50
Figure 14	Q.703: Basic Reception Control (Sheet 1 of 4)	51

Signalling Link

Q.703

Figure 14/ Q.703: Basic Reception Control (Sheet 2 of 4) 52

Figure 14/ Q.703: Basic Reception Control (Sheet 3 of 4) 53

Figure 14/ Q.703: Basic Reception Control (Sheet 4 of 4) 54

Figure 15/ Q.703: Preventive Cyclic Retransmission - Transmission Control
(Sheet 1 of 3) 55

Figure 15/ Q.703: Preventive Cyclic Retransmission - Transmission Control
(Sheet 2 of 3) 56

Figure 15/ Q.703: Preventive Cyclic Retransmission - Transmission Control
(Sheet 3 of 3) 57

Figure 16/ Q.703: Preventive Cyclic Retransmission - Reception Control
(Sheet 1 of 3) 58

Figure 16/ Q.703: Preventive Cyclic Retransmission - Reception Control
(Sheet 2 of 3) 59

Figure 16/ Q.703: Preventive Cyclic Retransmission - Reception Control
(Sheet 3 of 3) 60

Figure 17/ Q.703: Alignment Error Rate Monitor 61

Figure 18/ Q.703: Signal Unit Error Rate Monitor 62

Figure 19/ Q.703: Congestion Control 63

1. GENERAL

1.1 Introduction

1.1.1 The Recommendation describes the functions and procedures for, and relating to, the transfer of signal messages over one signalling data link. The signalling link functions (with a signalling data line as bearer) provide a signalling link for reliable transfer of signalling messages between two directly connected "signalling points."

Signalling messages delivered by superior hierarchical levels are transferred over the signalling link in variable length "signal units." The signal units include transfer control information for proper operation of the signalling link in addition to the signalling information.

1.1.2 The signalling link functions comprise the following:

- (1) signal unit delimitation,
- (2) signal unit alignment,
- (3) error detection,
- (4) error correction,
- (5) initial alignment,
- (6) signalling link error monitoring, and
- (7) flow control.

All these functions are coordinated by the "link state control" (see Figure 1, Q.703).

An asterisk (*) indicates a change from CCITT Red Book, Vol. VI, which is specific to U.S. Networks.

**SIGNALLING LINK CONTROL.
(Level 2)**

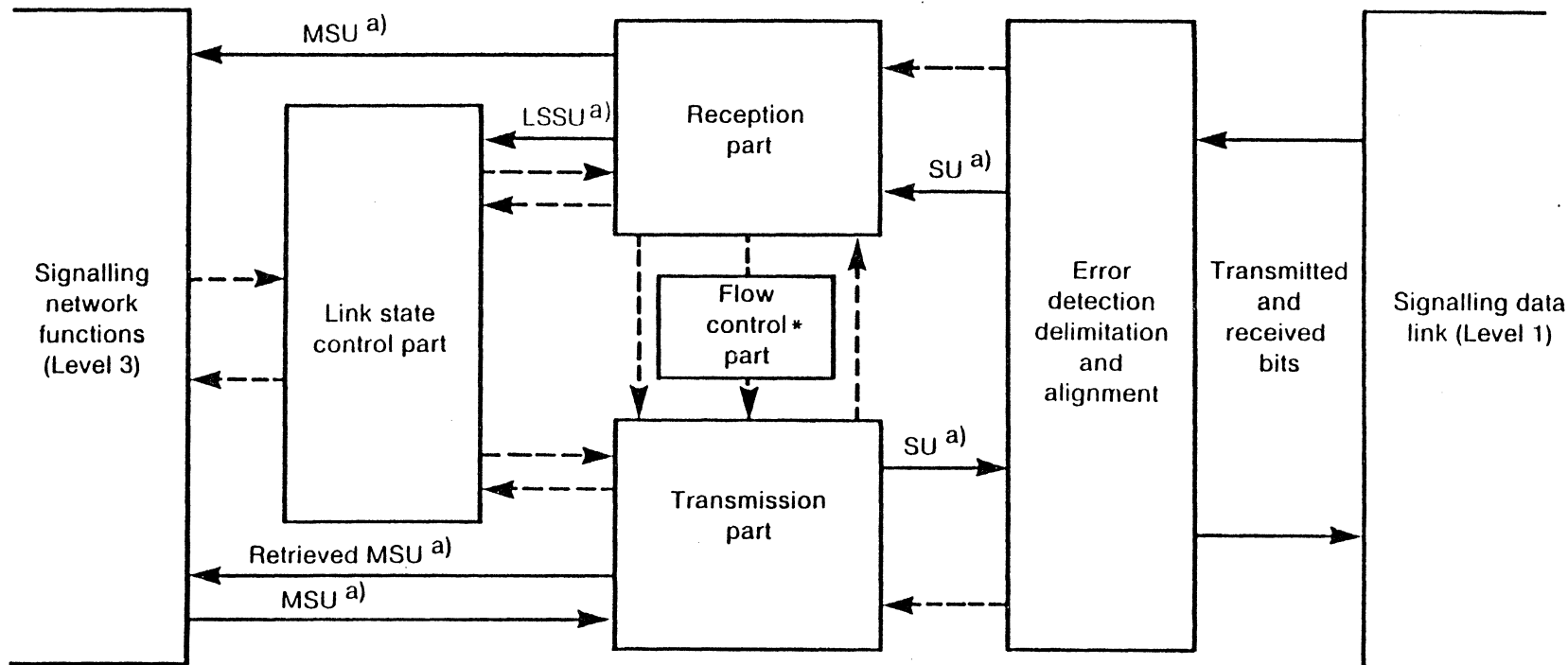

Figure 1/Q.703-
Interactions of the functional specification blocks for signalling link control

Signalling Link

1.2 Signal Unit Delimitation and Alignment The beginning and end of a signal unit are indicated by a unique 8-bit pattern, called the "flag".

Measures are taken to ensure that the pattern cannot be imitated elsewhere in the unit.

Loss of alignment occurs when a bit pattern disallowed by the delimitation procedure (more than six consecutive 1s) is received, or when a certain signal unit maximum length is exceeded.

Loss of alignment will cause a change in the mode of operation of the "signal unit error rate monitor."

1.3 Error Detection The error detection function is performed by means of 16 check bits provided at the end of each signal unit. The check bits are generated by the transmitting signalling link terminal by operating on the preceding bits of the signal unit, following a specified algorithm. At the receiving "signalling link terminal" the received check bits are operated on using specified rules, which correspond to that algorithm.

If, according to the algorithm, consistency is not found between the received check bits and the preceding bits of the signal unit, then the presence of errors is indicated and the signal unit is discarded.

1.4 Error Correction

1.4.1 Two forms of error correction are provided: the "basic method" and the "preventive cyclic retransmission method." The following criteria should be used for determining the application fields of the two methods.

- (1) The basic method applies to signalling links using terrestrial transmission means. *
- (2) The preventive cyclic retransmission method applies to all signalling links established via satellite. *

In cases where one signalling link within a link set is established via satellite, the preventive cyclic retransmission method should be used for all signalling links of that link set.

1.4.2 The basic method is a non-compelled, positive/negative acknowledgement, retransmission error correction system. A signal unit that has been transmitted is retained at the transmitting signalling link terminal until a positive acknowledgement for that signal unit is received. If a negative acknowledgement is received, then the transmission of new units is interrupted and those signal units that have been transmitted — but not yet positively acknowledged starting with that indicated by the negative acknowledgment — will be retransmitted (once) in the order in which they were first transmitted.

1.4.3 The preventive cyclic retransmission method is a non-compelled, positive acknowledgment, cyclic retransmission, forward error correction system. A signal unit that has been transmitted is retained at the transmitting signalling link terminal until a positive acknowledgement for that signal unit is received. During the period when no new signal units are to be transmitted, all the signal units that have not been positively acknowledged are cyclically retransmitted.

The "forced retransmission procedure" is defined to ensure that forward error correction occurs in adverse conditions (e.g., high error rate and/or high traffic loading).

¹ A "signalling link terminal" refers to the means for performing all of the functions defined at level 2, regardless their implementation.

Signalling Link

When a predetermined number of retained, unacknowledged signal units exist, the transmission of new signal units is interrupted and the retained signal units are cyclically retransmitted until the number of unacknowledged signal units is reduced.

1.5 Initial Alignment The initial alignment procedure is appropriate to both first time initialization (e.g., after "switch-on") and alignment in association with restoration after a link failure. The procedure is based on the compelled exchange of status information between the two "signalling points" concerned and the provision of a proving period. No other signalling link is involved in the initial alignment of any particular link, the exchange occurs only on the link to be aligned.

1.6 Signalling Link Error Monitoring Two signalling link error rate monitor functions are provided: one that is employed while a signalling link is in service and which provides one of the criteria for taking the link out of service, and one that is employed while a link is in the proving state of the initial alignment procedure. These are called the "signal unit rate monitor" and the "alignment error rate monitor," respectively. The characteristics of the signal error rate monitor are based on a signal unit error count, incremented and decremented using the "leaky bucket" principle, whereas the alignment error rate monitor is a linear count of signal unit errors. During loss of alignment, the signal unit error rate monitor error count is incremented in proportion to the period of the alignment loss.

1.7 Link State Control Functions "Link state control" is a function of the signalling link that provides directions to the other signalling link functions. The interfaces with link state control are shown in Figure 1/Q.703 and Figure 7/Q.703. The split into the functional blocks shown in the figures is made to facilitate description of the signalling link procedures and should not be taken to imply any particular implementation.

The link state control function is shown in the overview diagram (Figure 2/Q.703) and the detailed state transition diagram (Figure 8/Q.703).

1.8 Flow Control Flow Control is initiated when congestion is detected at the receiving end of the signalling link. The congested receiving end of the link notifies the remote transmitting end of the condition by means of an appropriate link status signal unit, and it withholds acknowledgement of all incoming message signal units. When congestion abates, acknowledgement of all incoming message signal units is resumed. While congestion exists, the remote transmitting end is periodically notified of this condition. If this congestion continues too long, the remote transmitting end will indicate the link as failed.

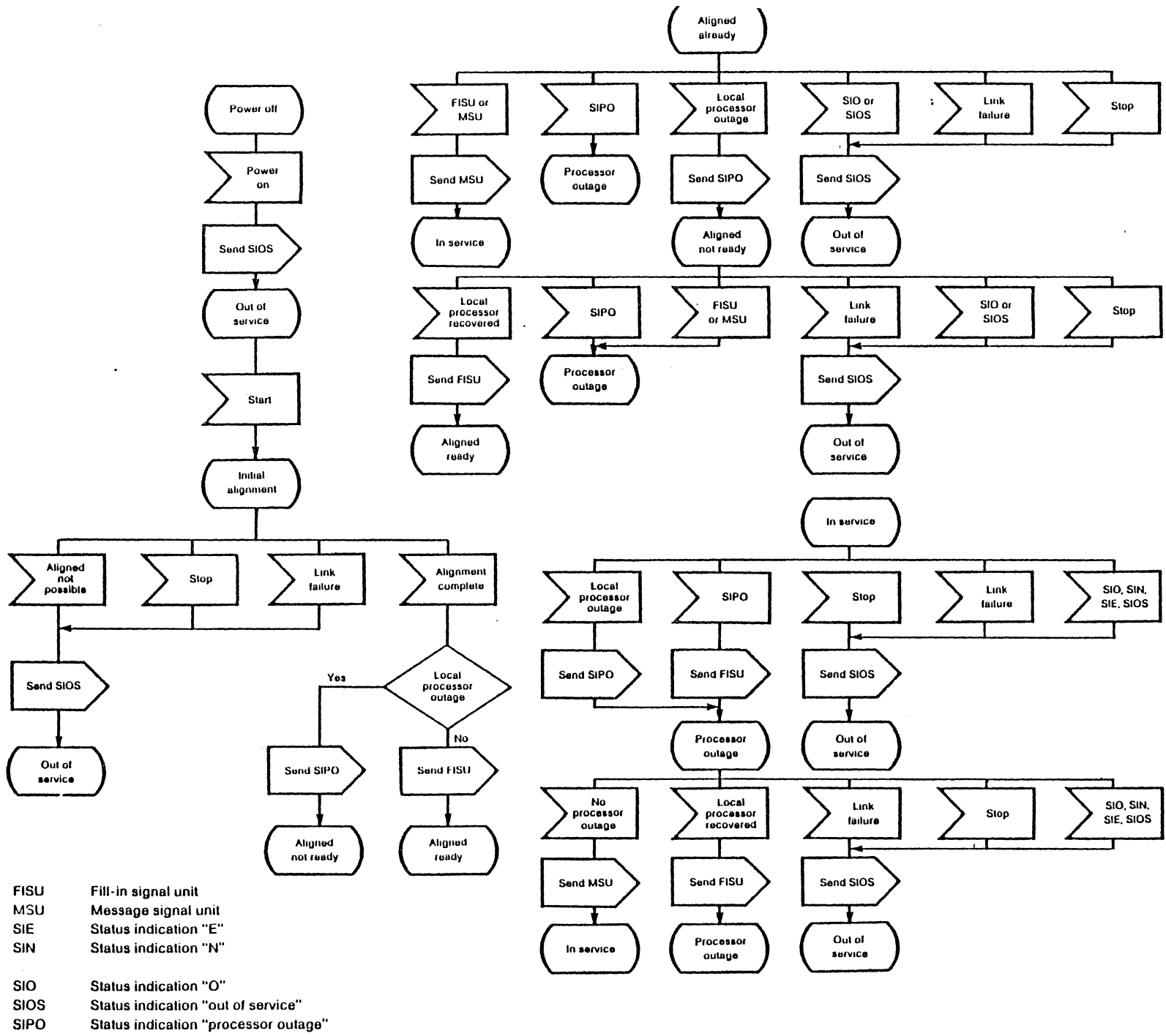

Figure 2/Q.703 - Overview diagram of link state control

Signalling Link

2. BASIC SIGNAL UNIT FORMAT

2.1 General Signalling and other information originating from a User Part is transferred over the signalling link by means of signal units.

A signal unit is constituted by a variable length "signalling information field" that carries the information generated by a "User Part" and a number of fixed length fields that carry information required for message transfer control. In the case of link status signal units, the signalling information field and the service information octet are replaced by a status field that is generated by the signalling link terminal.

2.2 Signal Unit Format Three types of signal units are differentiated by means of the "length indicator" contained in all signal units: i.e., message signal units, link status signal units and fill-in signal units. Message signal units are retransmitted in case of error, whereas link status signal units and fill-in signal units are not. The basic formats of the signal units are shown in Figure 3/Q.703.

2.3 Function and Codes of the Signal Unit Fields

2.3.1 General The message transfer control information encompasses 8 fixed length fields in the signal unit that contain information required for error control and message alignment.

2.3.2 Flag The opening flag indicates the start of a signal unit. The opening flag of one signal unit is normally the closing flag of the preceding signal unit. The closing flag indicates the end of a signal unit. The bit pattern for the flag is 01111110.

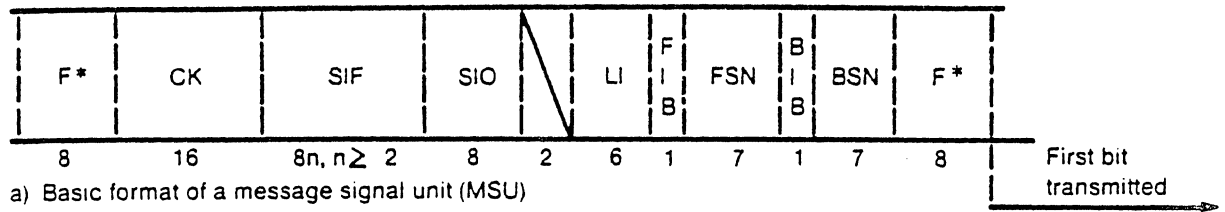

a) Basic format of a message signal unit (MSU)

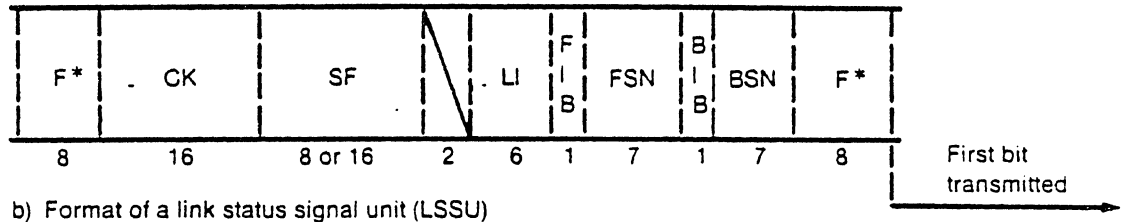

b) Format of a link status signal unit (LSSU)

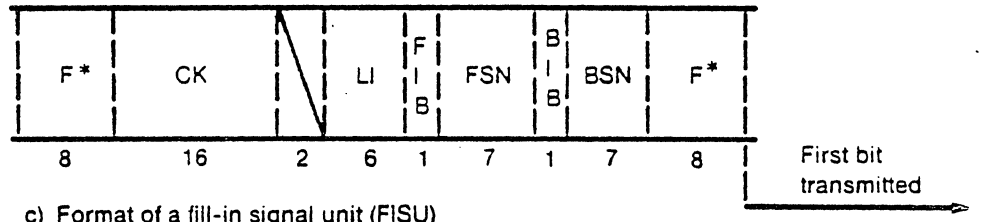

c) Format of a fill-in signal unit (FISU)

- | | |
|------------------------------|----------------------------------|
| BIB Backward indicator bit | FSN Forward sequence number |
| BSN Backward sequence number | LI Length indicator |
| CK Check bits | SF Status field |
| *F Flag | SIF Signalling information field |
| FIB Forward indicator bit | SIO Service information octet |

Figure 3/Q.703 - Signal Unit Formats

2.3.3 Length Indicator The length indicator is used to indicate the number of octets following the length indicator octet and preceding the "check bits," and is a number in binary code in the range 0-63. The length indicator differentiates between the three types of signal units as follows.

- | | |
|----------------------------|-------------------------|
| Length Indicator = 0: | fill in signal unit |
| Length Indicator = 1 or 2: | link status signal unit |
| Length Indicator > 2: | message signal unit |

In the case that a signalling information field spanning 62 octets or more is included in a message signal unit, the length indicator is set at 63. *

2.3.4 Service Information Octet The "service information octet" is present only in message signal units. The service information octet can be used at level 3 to distinguish between different message types and different label types. *

The content of the subservice field is described in Recommendation Q.704, Section 13.2.2.

2.3.5 Sequence Numbering The "forward sequence number" is the sequence number of the signal unit in which it is carried. *

The "backward sequence number" is the sequence number of a signal unit being acknowledged.

The forward sequence number and backward sequence number are numbers in binary code from a cyclic sequence ranging from 0 to 127. (See Sections 5.2 and 6.)

2.3.6 Indicator Bits The "forward indicator bit" and "backward indicator bit," with the forward and backward sequence numbers, are used in the basic error control method to perform the signal unit sequence control and acknowledgement functions. (See Sections 5.2 and 6.)

2.3.7 Check Bits Every signal unit has 16 check bits for error detection (see Section 4.).

2.3.8 Signalling Information Field The "signalling information field" consists of an integral number of octets, greater than or equal to 2, and less than or equal to 272². *

The format and codes of the signalling information field are defined for each user.

2.3.9 Status Field The formats and codes of the "status field" are described in Section 11.

2.4 Order of Bit Transmission Each of the fields mentioned in Section 2.3 will be transmitted in the order indicated in Figure 3/Q.703.

Within each field or subfield, the bits will be transmitted with the least significant bit first. The 16 check bits are transmitted in the order generated (see Section 4).

² This value of 272 octets is a U.S. Network option. The value allows a single message signal unit to accommodate information blocks up to 256 octets in length, accompanied by a label and possible additional housekeeping information that may, for example, be used by level 4 to link such information blocks.

SIGNALLING LINK

3. SIGNAL UNIT DELIMITATION

3.1 Flags † A signal unit includes an opening flag (see Section 2.2). The opening flag of a signal unit is normally considered to be the closing flag of the preceding signal unit. In certain conditions (e.g., signalling link overload), a number of flags may be generated between two consecutive signal units. However, a signalling terminal should always be able to receive consecutive signal units with either single or multiple flags between them. * | *

3.2 Zero Insertion and Deletion To ensure that the flag code is not imitated by any other part of the signal unit, the transmitting signalling link terminal inserts a 0 after every sequence of five consecutive 1s before the flags are attached and the signal unit is transmitted. At the receiving signalling link terminal, after flag detection and removal, each 0 which directly follows a sequence of five consecutive 1s is deleted.

† If the number of consecutive flags exceeds six (6), the signalling link error control characteristics may be adversely affected.

SIGNALLING LINK

4. ACCEPTANCE PROCEDURE

4.1 Acceptance of Alignment

4.1.1 A flag which is not followed immediately by another flag is considered an opening flag. Whenever an opening flag is received, the beginning of a signal unit is assumed. When the next flag (a closing flag) is received, it is assumed to be the termination of the signal unit.

4.1.2 If seven or more consecutive 1s are received, the signal unit error rate monitor or alignment error rate monitor enters the "octet counting" mode (see Section 4.1.4) and the next valid flag is searched for.

4.1.3 After deletion of the 0s inserted for transparency, the received signal unit length is checked for being a multiple of 8 bits and at least 6 octets, including opening flag. If it is not, then the signal unit is discarded and the signal unit error rate monitor or alignment error rate monitor is incremented. If more than "m" + 7 octets are received before a closing flag, the "octet counting" mode is entered (see Figure 11/Q.703) and the signal unit is discarded. "m" is the maximum length of the signalling information field (in octets) allowed on a particular signalling link. "m" takes the value 272³. In the case of the basic error control method, a negative acknowledgment will be sent, if required, according to the rules set out in Section 5.2. *

4.1.4 When the "octet counting" mode is entered, all the bits received after the last flag and before the next flag are discarded. The "octet counting" mode is left when the next correctly checking signal unit is received, and this signal unit is accepted.

4.2 **Error Detection** The error detection function is performed by means of 16 check bits provided at the end of each signal unit.

The check bits are generated by the transmitting signalling link terminal. They are the ones complement of the sum (modulo 2) of:

- (1) The remainder of $x^k (x^{15} + x^{14} + x^{13} + x^{12} + \dots + x^2 + x + 1)$ divided (modulo 2) by the generator polynomial $x^{16} + x^{12} + x^5 + 1$, where k is the number of bits in the signal unit existing between, but not including, the final bit of the opening flag and the first bit of the check bits, excluding bits inserted for transparency; and
- (2) The remainder after multiplication by x^{16} and then division (modulo 2) by the generator polynomial $x^{16} + x^{12} + x^5 + 1$ of the content of the signal unit existing between, but not including, the final bit of the opening flag and the first bit of the check bits, excluding bits inserted for transparency.

3. Text from the CCITT Red Book Vol. VI Fascicle VI.7, related to the maximum message length, was deleted from this section.

Signalling Link

As a typical implementation, at the transmitting signalling link terminal, the initial remainder of the division is preset to all 1s, and is then modified (by division) by the generator polynomial (as described above) on all fields of the signal unit; the 1s complement of the resulting remainder is transmitted as the 16 check bits.

At the receiving signalling link terminal, the correspondence between the check bits and the remaining part of the signal unit is checked. If complete correspondence is not found, the signal unit is discarded.

As a typical implementation at the receiving signalling link terminal, the initial remainder is preset to all 1s, and the serial incoming protected bits, including the check bits (after the bits inserted for transparency are removed) when divided by the generator polynomial, will result in a remainder of 0001110100001111 (x^{15} through x^0 , respectively) in the absence of transmission errors.

5. BASIC ERROR CORRECTION METHOD

5.1 General The basic error correction method is a non-compelled method in which correction is performed by retransmission. In normal operation, the method ensures correct transfer of message signal units over the signalling link, in sequence and with no double delivery. As a consequence, no resequencing or elimination of the received information is required within the user parts.

“Positive acknowledgements” are used to indicate correct transfer of message signal units.

“Negative acknowledgements” are used as explicit requests for retransmission of message signal units received in a corrupt form.

To minimize the number of retransmissions and the resulting message signal unit delay, a request for retransmission is made only when a message signal unit (not another signal unit) has been lost; e.g., due to transmission errors or disturbances.

The method requires that transmitted, but not yet positively acknowledged message signal units, remain available for retransmission. To maintain the correct message signal unit sequence when a retransmission is made, the message signal unit (the retransmission of which has been requested) and any subsequently transmitted message signal units are retransmitted in the order in which they were originally transmitted.

As part of the error correction method, each signal unit carries a forward sequence number, a “forward indicator bit,” a backward sequence number and a “backward indicator bit.” The error correction procedure operates independently in the two transmission directions. The forward sequence number and forward indicator bit in one direction, with the backward sequence number and backward indicator bit in the other direction, are associated with the message signal unit flow in the first direction. They function independently of the message signal unit flow in the other direction and its associated forward sequence number, forward indicator bit, backward sequence number and backward indicator bit.

The transmission of new signal units is temporarily stopped during retransmission or when no forward sequence numbers are available for assignment to new message signal units — due to a high momentary load or corruption of positive acknowledgements (see Section 5.2.2).

Under normal conditions, when no message signal units are to be transmitted or retransmitted, fill-in signal units are continuously sent. In some particular cases, link status signal units, continuous fill-in signal units or flags may be sent as described in Sections 7, 8 and 11.

5.2 Acknowledgements (Positive Acknowledgements and Negative Acknowledgements)

5.2.1 Sequence Numbering For the purposes of acknowledgement and signal unit sequence control, each signal unit carries two sequence numbers. The signal unit sequence control is performed by means of the forward sequence number. The acknowledgement function is performed by means of the backward sequence number.

The value of the forward sequence number of a message signal unit is obtained by incrementing (modulo 128, see Section 2.3.5) the last assigned value by 1.

This forward sequence number value uniquely identifies the message signal unit until its delivery is accepted without errors, and in correct sequence, by the receiving terminal. The forward sequence number of a signal unit other than a message signal unit assumes the value of the forward sequence number of the last transmitted

Signalling Link

message signal unit.

5.2.2 Signal Unit Sequence Control Information regarding the service information octet, signalling information field, forward sequence number, and the length of each message signal unit, is retained at the transmitting signalling link terminal until a positive acknowledgement for that signal unit is received (see Section 5.2.3). In the meantime, the same forward sequence number cannot be used for another message signal unit (see Section 5.2.3).

A forward sequence number value can be assigned to a new message signal unit when a positive acknowledgement concerning that value, incremented by at least 1 (modulo 128), is received (see Section 5.2.3). This means that not more than 127 message units may be available for retransmission.

The action to be taken at the receiving signalling link terminal upon receipt of a correctly checking signal unit is determined by comparing the received forward sequence number with the forward sequence number of the last previously accepted signal unit, and by comparing the received forward indicator bit with the last sent backward indicator bit. In addition, as the appropriate action differs for a message signal unit and another signal unit, the length indicator of the received signal unit must be examined.

- (1) If the signal unit is a fill-in signal unit, then:
 - (a) If the forward sequence number value equals the forward sequence number value of the last accepted message signal unit, the signal unit is processed within the message transfer part.
 - (b) If the forward sequence number value is different from the forward sequence number value of the last accepted message signal unit, the signal unit is processed within the message transfer part. If the received forward indicator bit is in the same state as the last sent backward indicator bit, a negative acknowledgement is sent.
- (2) If the signal unit is a link status signal unit, then it is processed within the message transfer part.
- (3) If the signal unit is a message signal unit, then:
 - (a) If the forward sequence number value is the same as that of the last accepted signal unit, the signal unit is discarded, regardless the state of the indicator bits.
 - (b) If the forward sequence number value is one more (modulo 128, see Section 2.3.5) than that of the last accepted signal unit, and if the received forward indicator bit is in the same state as the last sent backward indicator bit, the signal unit is accepted and delivered to level 3.

Explicit positive acknowledgements to the accepted signal units are sent as specified in Section 5.2.3.

If the forward sequence number is one more than that of the last accepted signal unit, and if the received forward indicator bit is not in the same state as the last sent backward indicator bit, then the signal unit is discarded.

- (c) If the forward sequence number value is different from those values mentioned in (a) and (b) above, the signal unit is discarded. If the received forward indicator bit is in the same state as the last sent backward indicator bit, a negative acknowledgement is sent.

Signalling Link

Processing of the backward sequence number value and backward indicator bit value, as described in Section 5.3, is performed for message signal units and fill-in signal units; except when unreasonable backward sequence number value or unreasonable forward indicator bit value is received. Discarding a signal unit means that if it is a message signal unit, it is not delivered to level 3.

5.2.3 Positive Acknowledgement The receiving signalling link terminal acknowledges the acceptance of one or more message signal units by assigning the forward sequence number value of the last accepted message signal unit to the backward sequence number of the next signal unit sent in the opposite direction. The backward sequence numbers of subsequent signal units retain this value until a further message signal unit is acknowledged, which will cause a change of the backward sequence number sent.

The acknowledgement of an accepted message signal unit also represents an acknowledgement of all, if any, previously accepted (though not acknowledged) message signal units.

5.2.4 Negative Acknowledgement If a negative acknowledgement is to be sent (see Section 5.2.2), then the backward indicator bit value of the signal units transmitted is inverted. The new backward indicator bit value is maintained in subsequently sent signal units until a new negative acknowledgement is to be sent. The backward sequence numbers assume the value of the forward sequence number of the last accepted message signal unit.

5.3 RETRANSMISSION

5.3.1 Response to a Positive Acknowledgement The transmitting signalling link terminal examines the backward sequence number value of the received message signal units and fill-in signal units that have satisfied the polynomial error check. The previously sent message signal unit, that has a forward sequence number value identical to the received backward sequence number value, will no longer be available for transmission.

When an acknowledgement of a message signal unit having a given forward sequence number value is received, all other message signal units that preceded that message signal unit are considered to be acknowledged, even though the corresponding backward sequence numbers have not been received.

In the case when the same positive acknowledgement is consecutively received a number of times, no further action is taken.

In the case when a message signal unit or fill-in signal unit is received having a backward sequence number value that is not the same as the previous one, or one of the forward sequence number values of the signal units available for retransmission, the signal unit is discarded.

The following message signal unit or fill-in signal unit is discarded.

If any two backward sequence number values in three consecutively received message signal units or fill-in signal units are not the same as the previous one, or any of the forward sequence number values of the signal units in the retransmission buffer at the time that they are received, then level 3 is informed that the link is faulty.

SIGNALLING LINK

A timing mechanism, timer $T7^4$, shall be provided which generates an indication of excessive delay of acknowledgement if, assuming that there is at least one outstanding message signal unit in the retransmission buffer, no new acknowledgement has been received within $T7^4$ seconds. In the case of excessive delay in the reception of acknowledgements, a link failure indication is given to level 3.

5.3.2 Response to a Negative Acknowledgement ⁵ When the received backward indicator bit is not in the same state as the last sent forward indicator bit, all the message signal units available for retransmission are transmitted in correct sequence, starting with the signal unit which has a forward sequence number value of one more (modulo 128, see Section 2.3.5) than the backward sequence number associated with the received backward indicator bit.

New message signal units can only be sent when the last message signal unit available for retransmission has been transmitted.

At the start of a retransmission, the forward indicator bit is inverted; it thus becomes equal to the backward indicator bit value of the received signal units. The new forward indicator bit value is maintained in subsequently transmitted signal units until a new retransmission is started. Thus, under normal conditions, the forward indicator bit included in the transmitted signal units is equal to the backward indicator bit value of the received signal units. If a retransmitted message signal unit is lost, then this is detected by a check on the forward sequence number and forward indicator bit (see Section 5.2.2), and a new retransmission request is made.

In the case that a message signal unit or fill-in signal unit is received having a forward indicator bit value indicating the start of a retransmission when no negative acknowledgement has been sent, then that signal unit is discarded. The following message signal unit or fill-in signal unit is discarded.

If any two forward indicator bit values in three consecutively received message signal units or fill-in signal units indicate the start of a retransmission when no negative acknowledgement has been sent at the time that they are received, then level 3 is informed that the link is faulty.

4. Timers defined in Recommendation Q.703 are absolute time values (values for further study): this means that, due to the possibility to insert multiple flags between signal units (see Section 3.1), there may be no fixed relation between the time-out values and the number of signal units transmitted/received during the time-out periods.

5. The signal unit sequence control makes it possible to repeat a message signal unit which has not yet been acknowledged, without affecting the basic error correction procedure. Thus, a form of forward error correction by means of repetition of message signal units is possible in applications to lower retransmission rates, thereby reducing the effective signalling link speed and reducing the average message delay. Each signal unit should be defined by its own opening and closing flags to ensure that the repeated signal unit is not lost by the corruption of only a single flag. This is an option that is not fully specified and requires careful consideration for application.

SIGNALLING LINK

6. ERROR CORRECTION BY PREVENTIVE CYCLIC RETRANSMISSION

6.1 General The preventive cyclic retransmission method is essentially a non-compelled forward error correction method, whereby positive acknowledgements are needed to support the forward error correction.

Each message signal unit must be retained at the transmitting signalling link terminal until a positive acknowledgment arrives from the receiving signalling link terminal.

Error correction is effected by preventive cyclic retransmission of the message signal units already sent, though not yet acknowledged. Preventive cyclic retransmission takes place whenever there are no new message signal units or link status signal units available to be sent.

To complement preventive cycle retransmission, the message signal units available for retransmission are retransmitted with priority when a limit of the number of message signal units, or a limit of the number of message signal unit octets available for retransmission, has been reached.

Under normal conditions, when no message units are to be transmitted or cyclically retransmitted, fill-in signal units are sent. In some particular cases, link status signal units, continuous fill-in signal units or flags may be sent as described in Sections 7, 8 and 11.

6.2 Acknowledgements

6.2.1 Sequence Numbering For the purposes of acknowledgement and signal unit sequence control, each signal unit carries 2 sequence numbers. The signal unit sequence control is performed by means of the forward sequence number. The acknowledgement function is performed by means of the backward sequence number.

The value of the forward sequence number of a message signal unit is obtained by incrementing (modulo 128, see Section 2.3.5) the last assigned value by 1. This forward sequence number value uniquely identifies the message signal unit until its delivery is accepted without errors and in correct sequence, by the receiving signalling link terminal. The forward sequence number of a signal unit other than a message signal unit assumes the value of the forward sequence number of the last transmitted message signal unit.

6.2.2 Signal Unit Sequence Control Information regarding the service information octet, signalling information field, forward sequence number, and the length of each message signal unit, is retained at the transmitting signalling link terminal until the related acknowledgement for that signal unit is received (see Section 6.2.3). In the meantime, the same forward sequence number value cannot be used for another message signal unit (see Section 6.2.3).

A forward sequence number value can be assigned to a new message signal unit to be sent when a positive acknowledgement concerning that value incremented by at least 1 (modulo 128) is received (see Section 6.2.3).

The action to be taken at the receiving signalling link terminal upon receipt of a correctly checking signal unit is determined by comparison of the received forward sequence number with the forward sequence number of the last previously accepted signal unit.

In addition, as the appropriate action differs for a message signal unit and another signal unit, the length indicator of the received signal unit must be examined. The forward indicator bit and the backward indicator bit are not used and are set to 1.

- (1) If the signal unit is not a message signal unit, then the signal unit is processed within the message transfer part.
- (2) If the signal unit is a message signal unit, then:

SIGNALLING LINK

- (a) If the forward sequence number value is the same as that of the last accepted signal unit, the signal unit is discarded;
- (b) If the forward sequence number value is one more (modulo 128, see Section 2.3.5) than that of the last accepted signal unit, the signal unit is accepted and delivered to level 3. Explicit positive acknowledgements for the accepted signal units are sent as specified in Section 6.2.3;
- (c) If the forward sequence number value is different from the values mentioned in a) and b) above, the signal unit is discarded. Processing of the backward sequence number value as described in Section 6.3 is performed for message signal units and fill-in signal units except when unreasonable backward sequence number value is received. Discarding a signal unit means that if it is a message signal unit, it is not delivered to level 3.

6.2.3 Positive Acknowledgement The receiving signalling link terminal acknowledges the acceptance of one or more message signal units by assigning the forward sequence number value of the latest accepted message signal unit to the backward sequence number of the next signal unit sent. The backward sequence numbers of subsequent signal units retain this value until a further signal unit is acknowledged, which will cause a change of the backward sequence number sent. The acknowledgement to an accepted message signal unit also represents an acknowledgement to all, if any, previously accepted, though not yet acknowledged, signal units.

6.3 Preventive Cyclic Retransmission

6.3.1 Response to a Positive Acknowledgement All message signal units sent for the first time are retained until they have been positively acknowledged.

The transmitting signalling link terminal examines the backward sequence number value of the received message signal units and fill-in signal units that have satisfied the polynomial error check. The previously sent message signal unit, the forward sequence number value of which is the same as the backward sequence number value, will no longer be available for retransmission.

When an acknowledgement for a message signal unit having a given forward sequence number value is received, all other message signal units, if any, having forward sequence number values preceding that value (modulo 128) are considered to be acknowledged, even though the corresponding backward sequence number has not been received.

In the case that the same positive acknowledgement is consecutively received a number of times, no further action is taken.

In the case that a message signal unit or fill-in signal unit is received having a backward sequence number value which is not the same as the previous one or one of the forward sequence number values of the signal units in the retransmission buffer, the signal unit is discarded. The following message signal unit or fill-in signal unit is discarded.

If any two backward sequence number values in three consecutively received message signal units or fill-in signal units are not the same as the previous one or any of the forward sequence number values of the signal units in the retransmission buffer at the time that they are received, then level 3 is informed that the link is faulty.

A timing mechanism, timer T7⁴, shall be provided which generates an indication of excessive delay of acknowledgement if, assuming that there is at least one outstanding message signal unit in the retransmission buffer, no new acknowledgement has been received within T7⁴ seconds. In the case of excessive delay of acknowledgement, a link failure indication is given to level 3. *|

SIGNALLING LINK

6.3.2 Preventive Cyclic Retransmission Procedure

- (1) If no new signal units are available to be sent, the message signal units available for retransmission are retransmitted cyclically.
- (2) If new signal units are available, the retransmission cycle, if any, must be interrupted and the signal units be sent with priority.
- (3) Under normal conditions, when no message signal units are to be transmitted or cyclically retransmitted, fill-in signal units are sent continuously. In some particular cases, link status signal units, continuous fill-in signal units or flags may be sent as described in Section 7, 8 and 11.

6.4 Forced Retransmission To maintain the efficiency of error correction in those cases where automatic error correction by preventive cyclic retransmission alone is made impossible (by, for example, high signalling load), the preventive cyclic retransmission procedures must be completed by the forced retransmission procedure.

6.4.1 Forced Retransmission Procedure Both the number of message signal units available for retransmission (N1) and the number of message signal unit octets available for retransmission (N2) are monitored continuously.

If one of them reaches its set limit, no new message signal units or fill-in signal units are sent and the retransmission cycle is continued up to the last message signal unit entered into retransmission buffer with priority, in the order in which they were originally transmitted. If all those message signal units have been sent once and neither N1 nor N2 is at its limit value, the normal preventive cyclic retransmission procedure can be resumed. If not, all the message signal units available for retransmission are sent again with priority.

6.4.2 Limitation of the Values N1 and N2 N1 is limited by the maximum numbering capacity of the forward sequence number range which dictates that not more than 127 message signal units can be available for retransmission.

In the absence of errors, N2 is limited by the signalling link loop delay T_L . It must be ensured that not more than $T_L/T_{eb} + 1$ message signal unit octets are available for retransmission.

where:

T_L is the signalling link loop delay, i.e., the time between the sending of a message signal unit and the reception of the acknowledgement for this message signal unit in undisturbed operation; and

T_{eb} is the emission time of one octet

When some signalling data links of different loop delays are alternated for application to that signalling link, the longest possible signalling link delay may be used to calculate the value of T_L .

7. INITIAL ALIGNMENT PROCEDURE

7.1 General The procedure is applicable to activation and to restoration of the link. The procedure provides a "normal" proving period for "normal" initial alignment, and an "emergency" proving period for "emergency" initial alignment. The decision to apply either the "normal" or the "emergency" procedures is made unilaterally at level 3 (see Recommendation Q.704). Only the signalling link to be aligned is involved in the initial alignment procedure (i.e, no transfer of alignment information over other signalling links is required).

7.2 Initial Alignment Status Indications The initial alignment procedure employs four different alignment status indications:

Signalling Link

- (1) status indication "O": out of alignment
- (2) status indication "N": "normal" alignment status
- (3) status indication "E": "emergency" alignment status
- (4) status indication "OS": out of service

These indications are carried in the status field of the link status signal units (see Section 2.2).

Status indication "O" is transmitted when initial alignment has been started and none of the status indications "O", "N" or "E" are received from the link. Status indication "N" is transmitted when, after having started initial alignment, status indication "O", "N" or "E" is received and the terminal is in the "normal" alignment status. Status indication "E" is transmitted when, after having started initial alignment, status indication "O", "N", or "E" is received and the terminal is in the "emergency" alignment status; i.e., it must employ the short "emergency" proving period.

Status indications of "N" and "E" indicate the status of the transmitting signalling link terminal: this is not changed by reception of status indications indicating a different status at the remote signalling link terminal. Hence, if a signalling link terminal with a "normal" alignment status receives a status indication "E", it continues to send status indication "N", but initiates the short "emergency" proving period.

Status indication "OS" informs the remote signalling link terminal that, for reasons other than processor outage (e.g., link failure), the signalling link terminal can neither receive nor transmit message signal units. Status indication "OS" is also sent on completion of power-up (see Figures 2/Q.703 and 8/Q.703) until initial alignment is started.

7.3 Initial Alignment Procedure The initial alignment procedure passes through a number of states during the initial alignment.

- (1) State 00, the procedure is suspended.
- (2) State 01, "not aligned": the signalling link is not aligned and the terminal is sending status indication "O". Time-out T2⁴ is started on entry to State 01 and stopped when State 01 is left⁴.
- (3) State 02, "aligned": the signalling link is aligned and the terminal is sending status indication "N" or "E". status indication "N", "E" or "OS" are not received. Time-out T3⁴ is started on entry to State 02 and stopped when State 02 is left.
- (4) State 03, "proving": the signalling link terminal is sending status indication "N" or "E", status indication "O" or "OS" is not received, the backward indicator bit and the backward sequence number transmitted are set to the received forward indicator bit and forward sequence number, proving has been started. *
*

Following successful alignment proving procedure, the signalling terminal enters Aligned/Ready State and the aligned/ready time-out T⁴ is started. Time-out T1 is stopped on entry in the In Service State and the duration of time-out T1 should be chosen such that the remote end can perform four additional proving attempts.

The procedure itself is described in the overview diagram, Figure 4/Q.703, and in state transition diagram, Figure 9/Q.703.

⁴ Ensure that the value of this time-out is different at each end of a signalling link for automatic allocation of signalling data links (see Recommendation Q.704, Section 11). *

7.4 Proving Periods The values of proving periods are:

$$P_n = 2^{14} \text{ octet transmission time}$$

$$P_a = 2^{12} \text{ octet transmission time}$$

for a 56 kbit/s rate or 64 kbit/s rate, or lower bit rates.⁷ These values correspond to times of 2.3s and 0.6s, respectively, at 56 kbit/s; and to times of 2.0s and 0.5s, respectively, for 64 kbit/s rate.

7.4A Initial Alignment Timers⁸ The values of the initial alignment timers are as follows.

$$T_1 = 5 \times P_n + \text{ERROR} = 13.0 \text{ secs, accuracy range [13,30]}$$

(where ERROR is the safety margin)

$$T_2 = [5 \text{ or } 10] \times P_n = 11.8 \text{ secs, } 23.5 \text{ secs}^8 \text{ (see Section 7.3), accuracy range [5,14] or [16,30], respectively}$$

$$T_3 = 5 \times P_n = 11.8 \text{ secs, accuracy range [5,14]}$$

$$T_4 = P_n \cdot P_a = 2.3 \text{ secs, } 0.6 \text{ secs, accuracy } \pm 10\%$$

⁷ The values of proving periods in conjunction with lower bit rates are not specified.

⁸ These values are tentative U.S. Network standards. The permanent adoption of these values will depend on the final implementation.

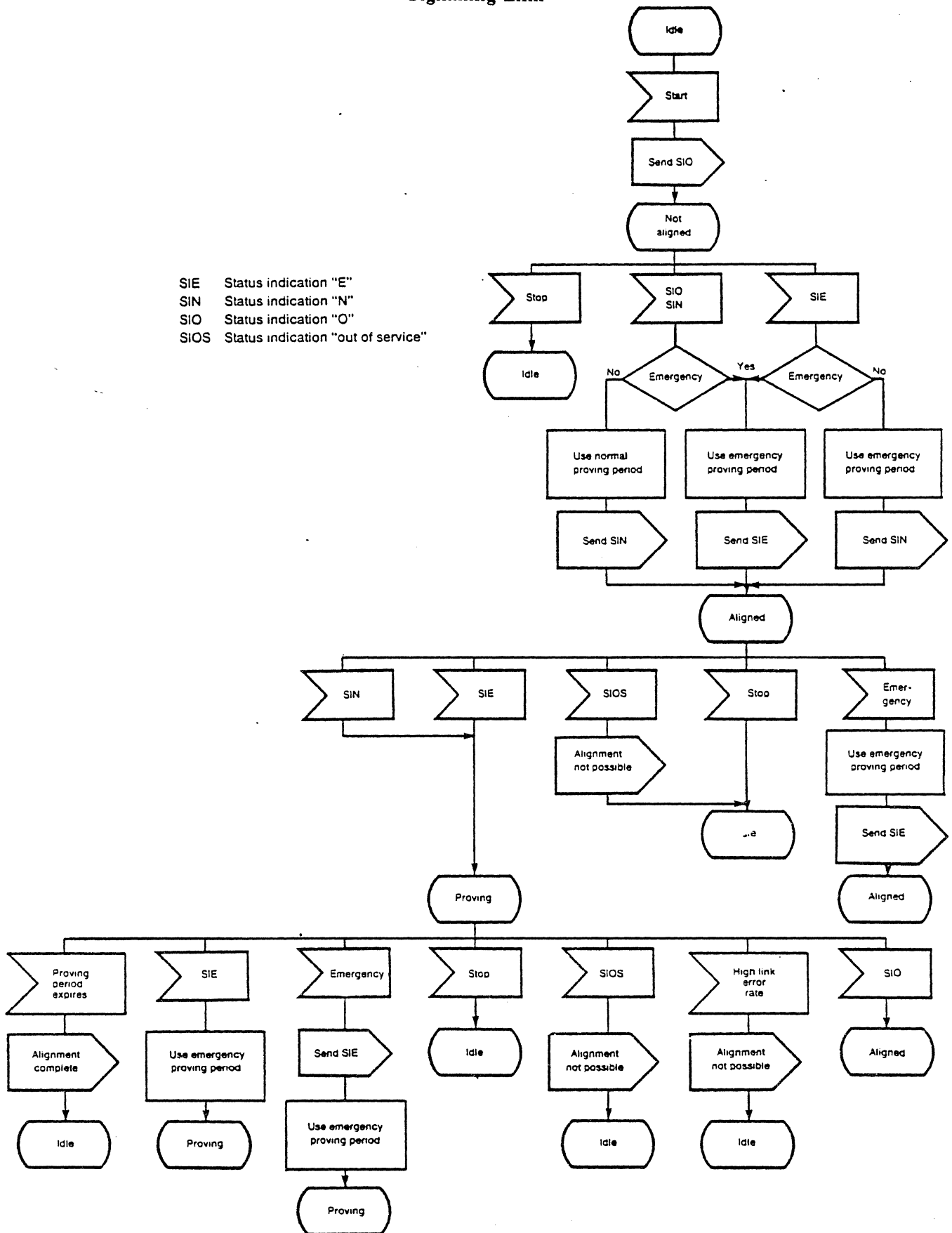

Figure 4/Q.703 - Overview diagram of initial alignment control

Signalling Link

8. PROCESSOR OUTAGE The procedure for dealing with local and/or remote processor outage is described in Figure 10/Q.703.

A processor outage situation occurs when, due to factors at a functional level higher than level 2, use of the link is precluded.

In this context, processor outage refers to a situation when signalling messages cannot be transferred to functional levels 3 and/or 4. This may be because of, for example, a central processor failure. It may also be due to a manually initiated blocking (management blocking or inhibiting) of an individual signalling link (see Recommendation Q.704, Sections 3.2.6 and 3.2.8). The management procedure, however, only temporarily uses the processor outage procedure to reroute traffic, and then reverses the processor outage condition. A processor outage condition may, thus, not necessarily affect all signalling links in a signalling point, nor does it exclude the possibility that level 3 is able to control the operation of the signalling link.

When level 2 identifies a local processor outage condition, either by receiving an explicit indication from level 3 (i.e., local signalling link blocking or management inhibiting or blocking, see Recommendation Q.704, Section 3.2.6 and 3.2.8), or by recognizing a failure of level 3, it transmits link status signal units indicating processor outage and discards message signal units received. Provided that the level 2 function at the far end of the signalling link is in its normal operating stage (i.e., transmitting message signal units or fill-in signal units) upon receiving link status signal units indicating processor outage, it notifies level 3 and begins to continuously transmit fill-in signal units.

When the local processor outage condition ceases, normal transmission of message signal units and fill-in signal units is resumed (provided that no local processor outage condition has arisen also at the remote end); as soon as the level 2 function at the remote end correctly receives a message signal unit or fill-in signal unit until it notifies level 3 and returns to normal operation.

Format and code of link status signal units indicating processor outage (status indicator "PO") appear in Section 11.

Signalling Link

9. LEVEL 2 FLOW CONTROL

9.1. General The procedure is used to handle a level 2 congestion situation. After the congestion is detected at the receiving end of the signalling link, both positive and negative acknowledgements to message units are withheld and a status indication "B" (BUSY) is sent from the receiving end of the link to the remote end in order to enable the remote transmitting end to distinguish between congestion and failure situations.

This indication is carried in the status field of a link status signal unit.

Note: The receiving end continues to process BSN and BIB carried in signal units received in order to, as far as possible, avoid disturbance of the message flow in the opposite direction and, in addition, may continue to accept message signal units.

9.2. Detection of Congestion The mechanism for detecting congestion at the receiving end of a signalling link is implementation dependent and not to be specified.

9.3. Procedure in the Congestion Situation The receiving end of a signalling link that detected a congestion situation periodically returns a link status signal unit containing a status indication "B" to the remote transmitting end of the link at interval T5⁴.

The receiving level 2 also withholds acknowledgement of the message signal unit, which triggered the congestion detection, and of message signal units received during the congestion situation; that is, fill-in signal units or message signal units are sent as usual, but with the backward sequence number and backward indicator bit assigned the values that are contained in the last transmitted signal unit before the congestion is recognized.

At the remote end of the signalling link, every reception of a link status signal unit containing indication "B" causes the excessive delay of acknowledgement timer T7⁴ to be reset. In addition, first reception of the link status signal unit containing a status indication "B" starts a long supervision timer T6⁴. Should timer T6 expire, link failure indication is generated.

9.4. Congestion Abatement Procedure When congestion abates at the receiving end of the signalling link, transmission of link status signal unit containing a status indication "B" is stopped and normal operation resumed.

At the remote end, the supervision timer T6⁴ is stopped when a negative or positive acknowledgement is received in case of the basic error correction method, or a positive acknowledgement is received in case of PCR method.

Note: Congestion onset and abatement detection is an implementation dependent function. Sufficient hysteresis should be provided in the implementation to prevent excessive oscillation between congested and non-congested states.

10. SIGNALLING LINK ERROR MONITORING

10.1. General Two link error rate monitor functions are provided: one that is employed while a signalling link is in service and which provides one of the criteria for taking the link out of service, and one that is employed while a link is in the proving state of the initial alignment procedure (see Section 7.3). These are called the single unit error rate monitor and the alignment error rate monitor, respectively.

10.2. Signal Unit Error Rate Monitor

10.2.1 The signal unit error rate monitor has as its function the estimation of the signal unit error rate in order to decide about the signalling link fault condition. The signal units in error are those rejected by the acceptance procedure (see Section 4). The three parameters that determine the signal unit error rate monitor are: the number of consecutive signal units received in error that will cause an error rate high indication to level 3, T (signal units); the lowest signal unit error rate that will ultimately cause an error rate high indication to level 3, 1/D (signal unit errors/signal unit); and the number of octets that cause an increment of the counter while in the "octet counting" mode, N (octets).

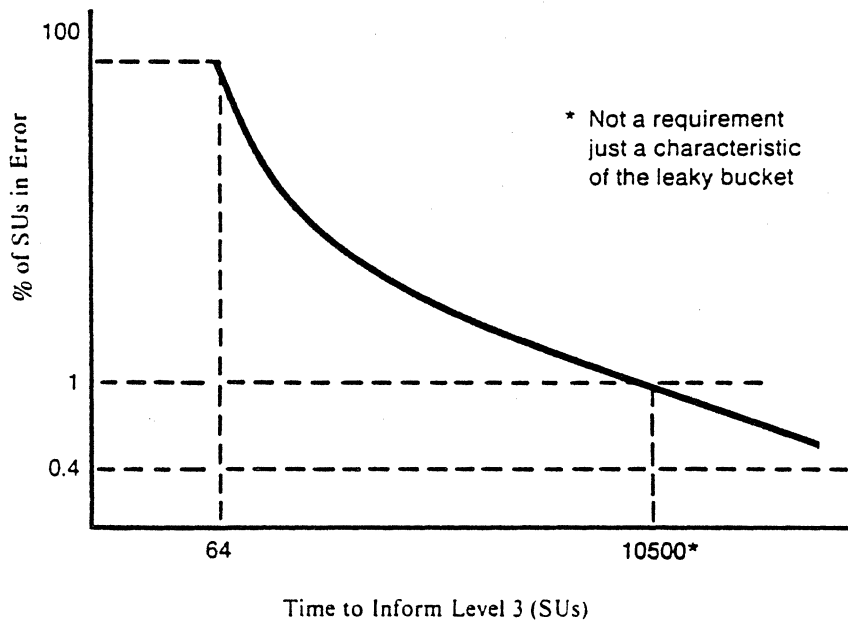

Figure 5/Q.703 -
Relationship between the expected number of signal units to fault indication and signal unit error rate

10.2.2 The signal unit error rate monitor may be implemented in the form of an up/down counter decremented at a fixed rate (for every D received signal units or signal unit errors indicated by the acceptance procedure), but not below zero, and incremented every time a signal unit error is detected by the signal unit acceptance procedure (see Section 4), but not above the threshold [T (signal units)]. An excessive error rate will be indicated whenever the threshold T is reached.

10.2.3 In the "octet counting" mode (see Section 4.1), the counter is incremented for every N octets received until a correctly checking signal unit is detected (causing the "octet counting" mode to be left).

10.2.4 When the link is brought into service, the monitor count should start from zero.

SIGNALLING LINK

10.2.5 The values of the three parameters are⁹:

T = 64 signal units	} For 56 kbit/s or 64 kbit/s	*
D = 256 signal units/signal unit error		*
N = 16 octets		*

In the case of loss of alignment these figures will give a time of approximately 146 ms to initiate changeover for 56 kbit/s operation, or approximately 128 ms for 64 kbit/s.

10.2.6 In the case where only random signal unit errors occur over the signalling link, the relationship between the expected number of signal units until the threshold of T (signal units) is reached and the signal unit error rate (signal unit errors/signal units) can be established. This relationship may be expressed by an orthogonal hyperbola which has parameters (T, 1/D). (See figure 5/Q.703).

10.3. Alignment Error Rate Monitor

10.3.1 The alignment error rate monitor is a linear counter which is operated during normal and emergency proving periods.

10.3.2 The counter is started from zero whenever the proving state (State 03 of Figure 9/Q.703) of the alignment procedure is entered and is then incremented for every signal unit error detected if it is not in the "octet counting" mode. It is also incremented for every N octets received while in the octet counting mode, as described in Section 10.2.3

10.3.3 When the counter reaches a threshold T_i , that particular proving period is aborted; on receipt of a correct signal unit or the expiry of the aborted proving period the proving state is reentered. If proving is aborted M times, the link is returned to the out-of-service state. A threshold is defined for each of the two types of proving period (normal and emergency, see Section 7). These are T_{in} and T_{ie} and apply to the normal proving period and the emergency proving period respectively.

Proving is successfully completed when a proving period expires without an excessive error rate being detected and without the receipt of status indication "O" or "OS".

10.3.4 The values of the four parameters for the 56 kbit/s or 64 kbit/s and lower bit rates are:

$T_{in} = 4$ signal units

$T_{ie} = 1$ signal unit

$M = 5$ proving periods

$N = 16$ octets

Note: It is noted that the emergency proving period may be successfully completed with some probability with a marginal and degraded bit error rate, i.e., around one error in 10^4 bits. Subsequently, the SUERM will quickly indicate an excessive error rate. However, short term operation on a degraded link may be acceptable (e.g., to send management messages).

9. Text which relates to the use of lower bit rates is not specified. Text from the CCITT Red Book Vol. VI Fascicle VI.7, which related to the use of lower bit rates, was deleted from this section.

SIGNALLING LINK

11. LEVEL 2 CODES AND PRIORITIES

11.1. Link Status Signal Unit

11.1.1 The link status signal unit is identified by a length indicator value equal to 1 or 2. If the length indicator has a value of 1 then the status field consists of one octet: if the length indicator has a value of 2 then the status field consists of two octets. The first octet contains the status indications, and the second octet, if present, is ignored. However, it is required that an LSSU of 1 or 2 octets in length is receivable. *

11.1.2 The format of one octet status field is shown in Figure 6/Q.703.

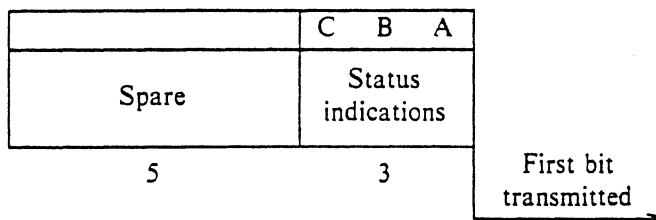

Figure 6/Q.703 - Status Field Format

11.1.3 The use of the link status indications is described in Section 7, 8 and 9; they are coded as follows:

CBA

000 - Status indication "O"

001 - Status indication "N"

010 - Status indication "E"

011 - Status indication "OS"

100 - Status indication "PO"

101 - Status indication "B"

11.2. Transmission Priorities Within Level 2

11.2.1 Five different items can be transmitted:

- (1) New message signal units;
- (2) Message signal units which have not yet been acknowledged;
- (3) Link status signal units;
- (4) Fill-in signal units;
- (5) Flags.

In certain failure conditions it may only be possible to send flags or nothing at all.

11.2.2 For the basic error control method the priorities are as follows.

Highest (1) Link status signal units

- (2) Message signal units that have not yet been acknowledged and for which a negative acknowledgement has been received

- (3) New message signal units
- (4) Fill-in signal units
- Lowest (5) Flags

11.2.3 For the preventive cyclic retransmission method, the priorities are as follows.¹⁰

- Highest (1) Link status signal units
- (2) Message signal units that have not yet been acknowledged and are stored in a retransmission buffer whose contents exceeds one of the parameters N_1 and N_2
- (3) New message signal units
- (4) Message signal units that have not yet been acknowledged
- (5) Fill-in signal units
- Lowest (6) Flags

¹⁰ Repetition of signal units for lower bit rates should have a priority immediately below that of link status signal units.

Signalling Link

12. STATE TRANSITION DIAGRAMS

12.1 Diagram Summary Section 12 contains the description of the signalling link control functions, described in this Recommendation, in the form of state transition diagrams according to the CCITT Specification and Description Language (SDL). These diagrams are summarized in the following list.

Level 2-Functional Block Diagram:	Figure 7/ Q.703
Link State Control:	Figure 8/ Q.703
Initial alignment Control:	Figure 9/ Q.703
Processor Outage Control:	Figure 10/ Q.703
Delimitation, Alignment and Error Detection (Receiving):	Figure 11/ Q.703
Delimitation, Alignment and Error Detection (Transmitting):	Figure 12/ Q.703
Basic Transmission Control:	Figure 13/ Q.703
Basic Reception Control:	Figure 14/ Q.703
Preventive Cyclic Retransmission (Transmission Control):	Figure 15/ Q.703
Preventive Cyclic Retransmission (Reception Control):	Figure 16/ Q.703
Alignment Error Rate Monitor:	Figure 17/ Q.703
Signal Unit Error Rate Monitor:	Figure 18/ Q.703
Congestion Control:	Figure 19/ Q.703

The detailed functional breakdown shown in the following diagrams is intended to illustrate a reference model and to assist interpretation of the text in the earlier sections. The state transition diagrams are intended to precisely show the behavior of the signalling system under normal and abnormal conditions as viewed from a remote location. It must be emphasized that the functional partitioning shown in the following diagrams is used only to facilitate the understanding of system behavior; it is not intended to specify the functional partitioning to be adopted in a practical implementation of the signalling system.

In the following figures, the term "signal unit" refers to units that do not contain all error control information.

SIGNALLING LINK

12.2. Abbreviations and Timers Used in Figures 7/Q.703 to 19/Q.703

AERM	Alignment error rate monitor
BIB	Backward indicator bit
BIBR	BIB received
BIBT	BIB to be transmitted
BIBX	BIB expected
BSN	Backward sequence number
BSNR	BSN received
BSNT	BSN to be transmitted
CC	Congestion Control
DAEDR	Delimitation, alignment and error detection (receiving)
DAEDT	Delimitation, alignment and error detection (transmitting)
FIB	Forward indicator bit
FIBR	FIB received
FIBT	FIB to be transmitted
FIBX	FIB expected
FISU	Fill-in signal unit
FSN	Forward sequence number
FSNC	Forward sequence number of the last message signal unit accepted by remote level 2
FSNF	FSN of the oldest MSU in the RTB
FSNL	FSN of the last MSU entered into RTB
FSNR	FSN received
FSNT	FSN of the last MSU transmitted
FSNX	FSN expected
IAC	Initial Alignment Control
L2	Level 2
L3	Level 3
LSC	Link state control
MGMT	Unspecified implementation dependent management function
MSU	Message Signal Unit
NACK	Negative Acknowledgement
PE	Emergency Proving Period
PN	Normal Proving Period
POC	Processor Outage control
RC	Reception Control
RTB	Retransmission Buffer
SIB	Status Indication "B" ("BUSY")
SIE	Status Indication "E" ("emergency alignment")
SIN	Status Indication "N" ("normal alignment")
SIO	Status Indication "O" ("out of alignment")
SIOS	Status Indication "out of service"
SIPO	Status Indication "processor outage"
SU	Signal Unit
SUERM	Signal Unit Error rate monitor
TB	Transmission Buffer
TXC	Transmission Control
UNB	Counter of Unreasonable BSN
UNF	Counter of unreasonable FIB
Ti	AERM threshold
Tie	Emergency AERM threshold
Tin	Normal AERM threshold

SIGNALLING LINK

Timers used in Figures 8/Q.703 to 19/Q.703⁴

T1	Timer "aligned/ready" = 13.0 secs.	*
		*
T2	Timer "not aligned" = 11.8 secs. and 23.5 secs.	*
		*
T3	Timer "aligned" = 11.8 secs.	*
		*
T4	Proving period timer = 2^{14} or 2^{12} octets = 2.3 secs. for P_n = 0.6 secs. for P_e	*
		*
		*
T5	Timer "sending SIB" = 80 - 120 ms	*
		*
T6	Timer "remote congestion" = 3 - 6 secs. (for 64 kbits/s)	*
		*
T7	Timer "excessive delay of acknowledgement" = 0.5 - 2 secs. (for 64 kbits/s)	*
		*
P_e	Emergency Proving Period = 2^{12} octets	*
		*
P_n	Normal proving period = 2^{14} octets	*
		*
		*

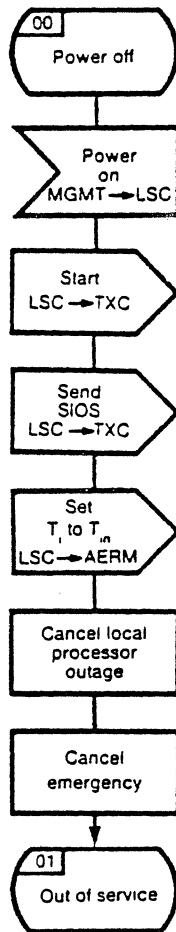

AERM	Alignment error rate monitor
LSC	Link state control
MGMT	Management system
TXC	Transmission control
T ₁	Monitor threshold
T _{in}	Normal monitor threshold

Figure 8/Q.703 -
Link state control (sheet 1 of 7)

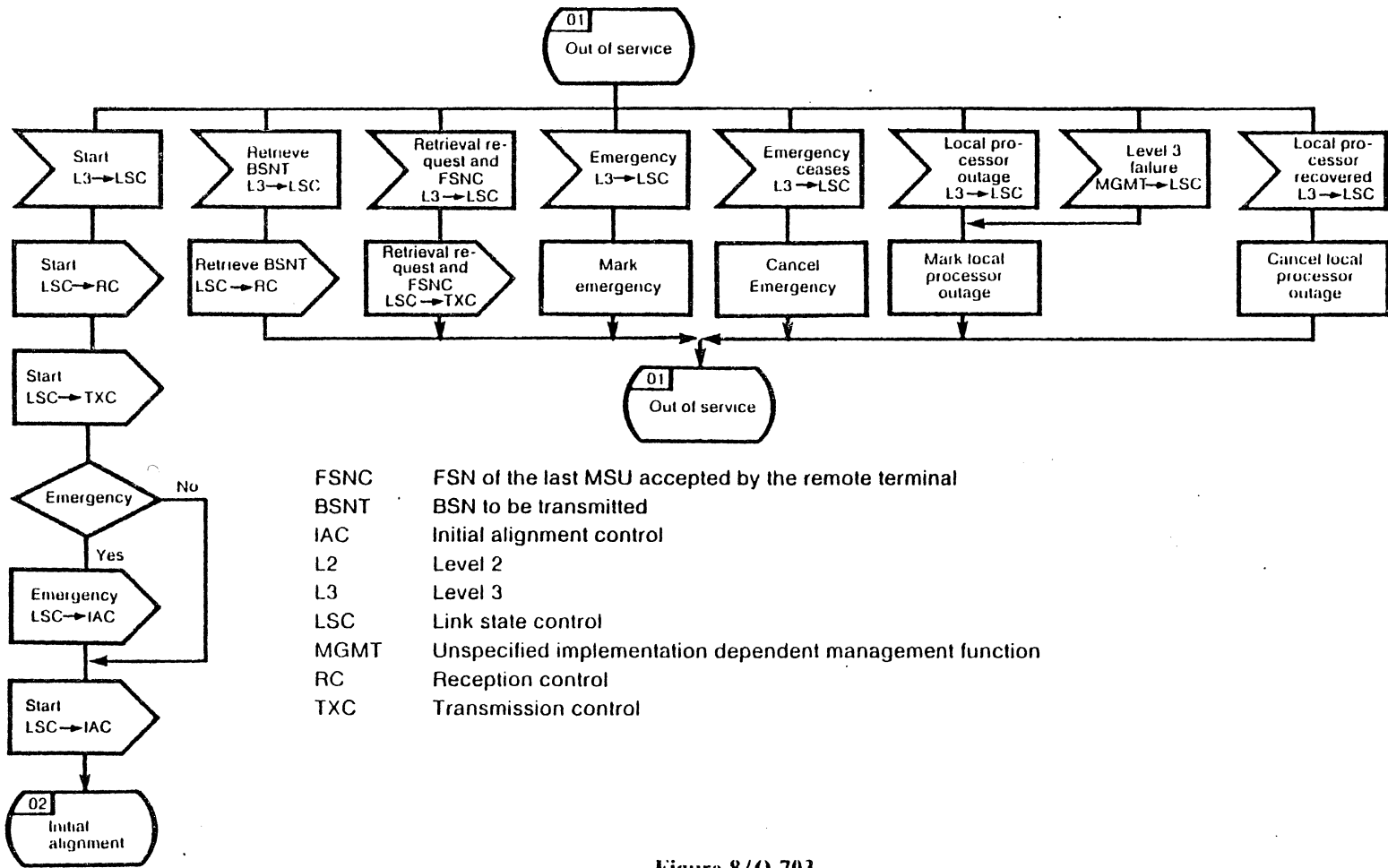

FSNC FSN of the last MSU accepted by the remote terminal
 BSNT BSN to be transmitted
 IAC Initial alignment control
 L2 Level 2
 L3 Level 3
 LSC Link state control
 MGMT Unspecified implementation dependent management function
 RC Reception control
 TXC Transmission control

Figure 8/Q.703 - Link state control (sheet 2 of 7)

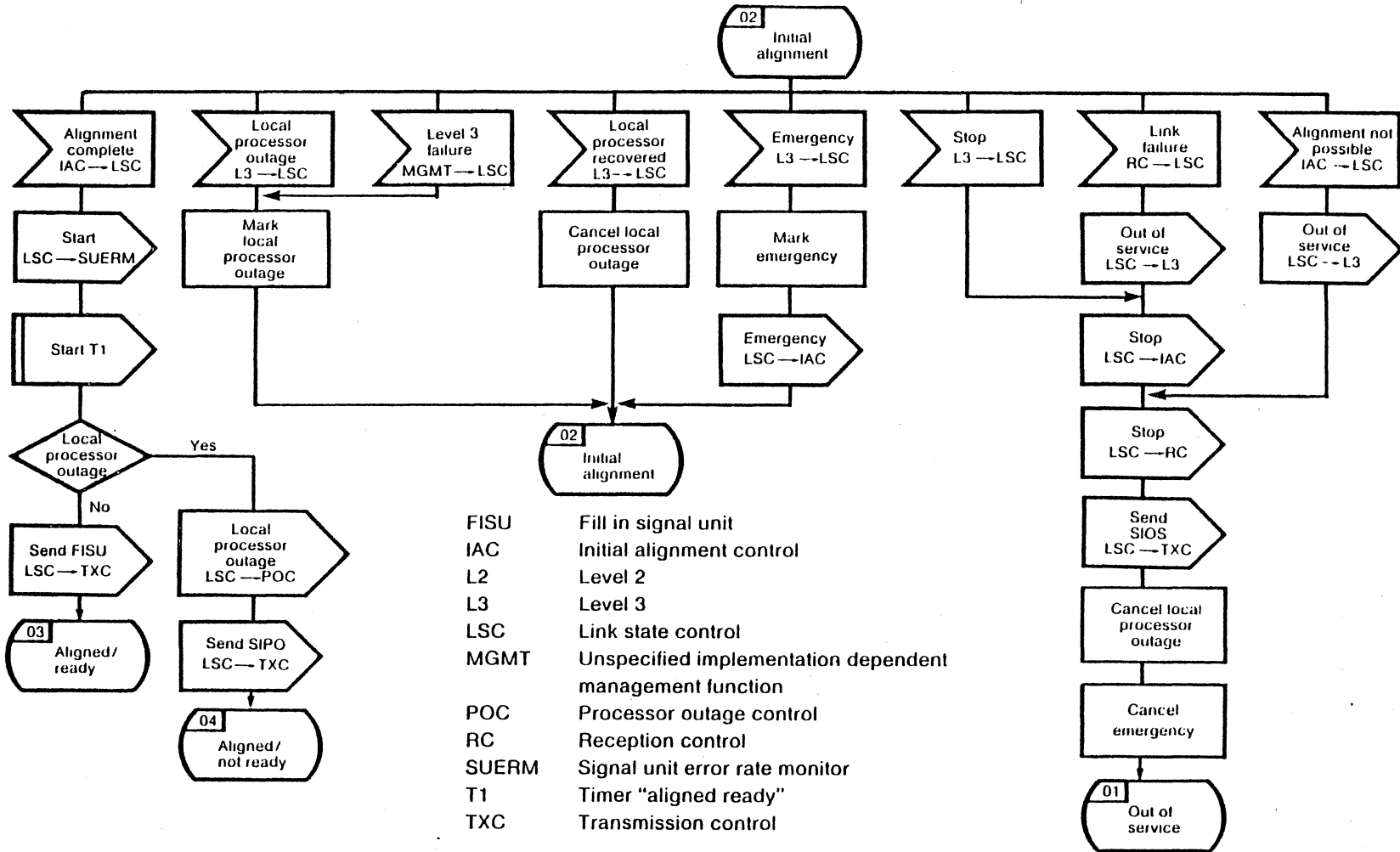

FISU	Fill in signal unit
IAC	Initial alignment control
L2	Level 2
L3	Level 3
LSC	Link state control
MGMT	Unspecified implementation dependent management function
POC	Processor outage control
RC	Reception control
SUERM	Signal unit error rate monitor
T1	Timer "aligned ready"
TXC	Transmission control

Figure 8/Q.703 -
Link state control (sheet 3 of 7)

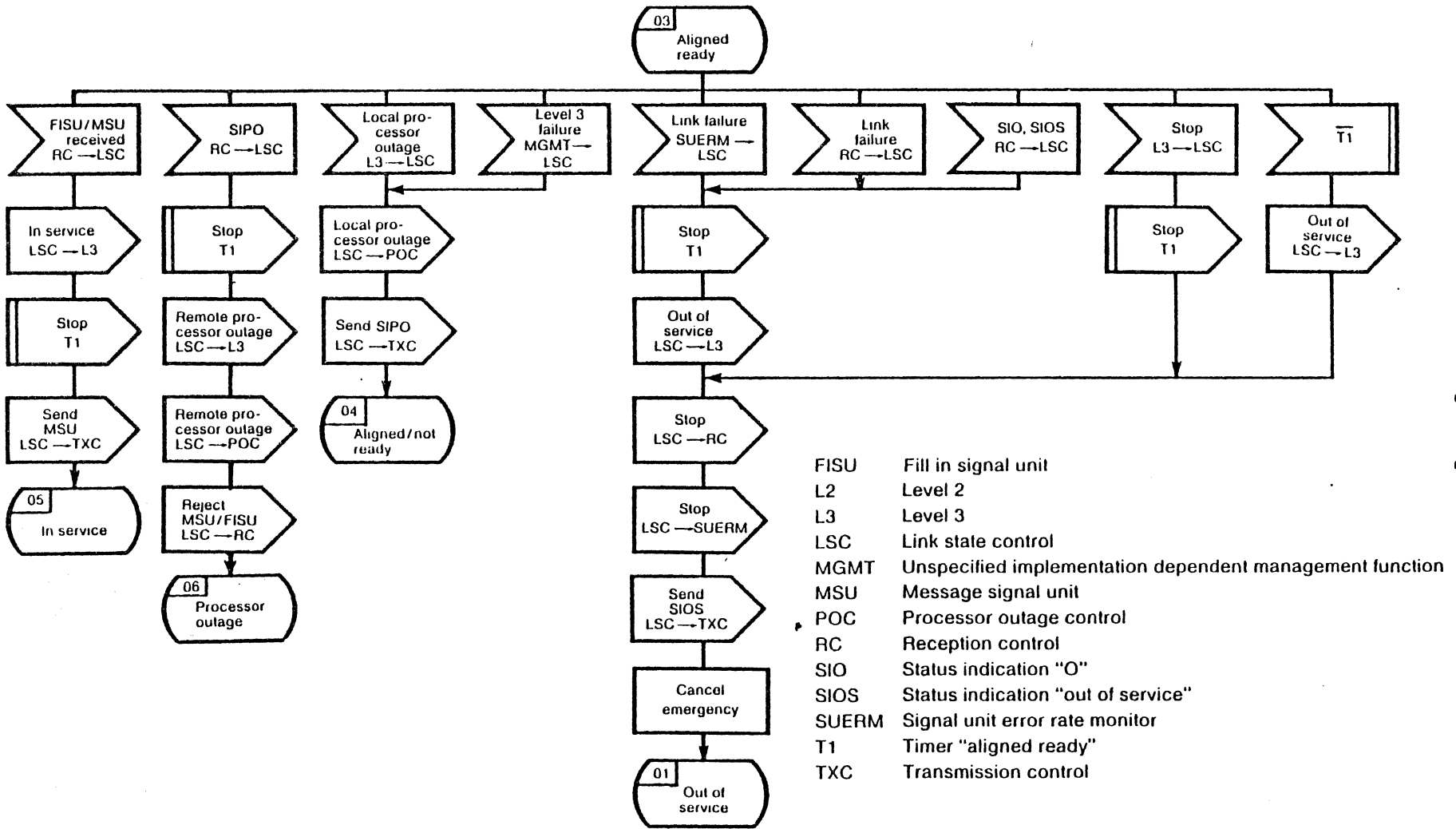

Signalling Link

Figure 8/Q.703 -
Link state control (sheet 4 of 7)

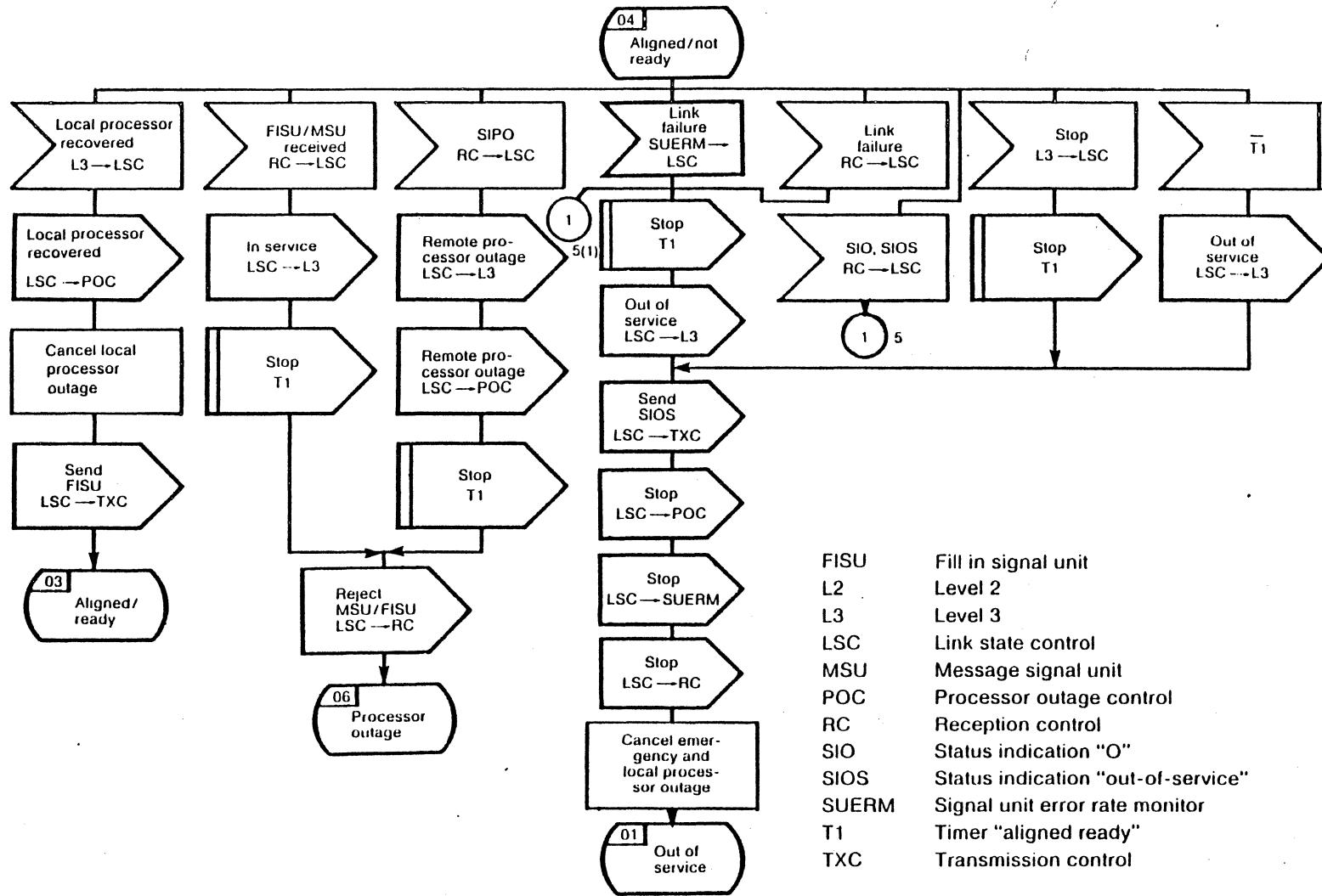

Figure 8/Q.703 -
Link state control (sheet 5 of 7)

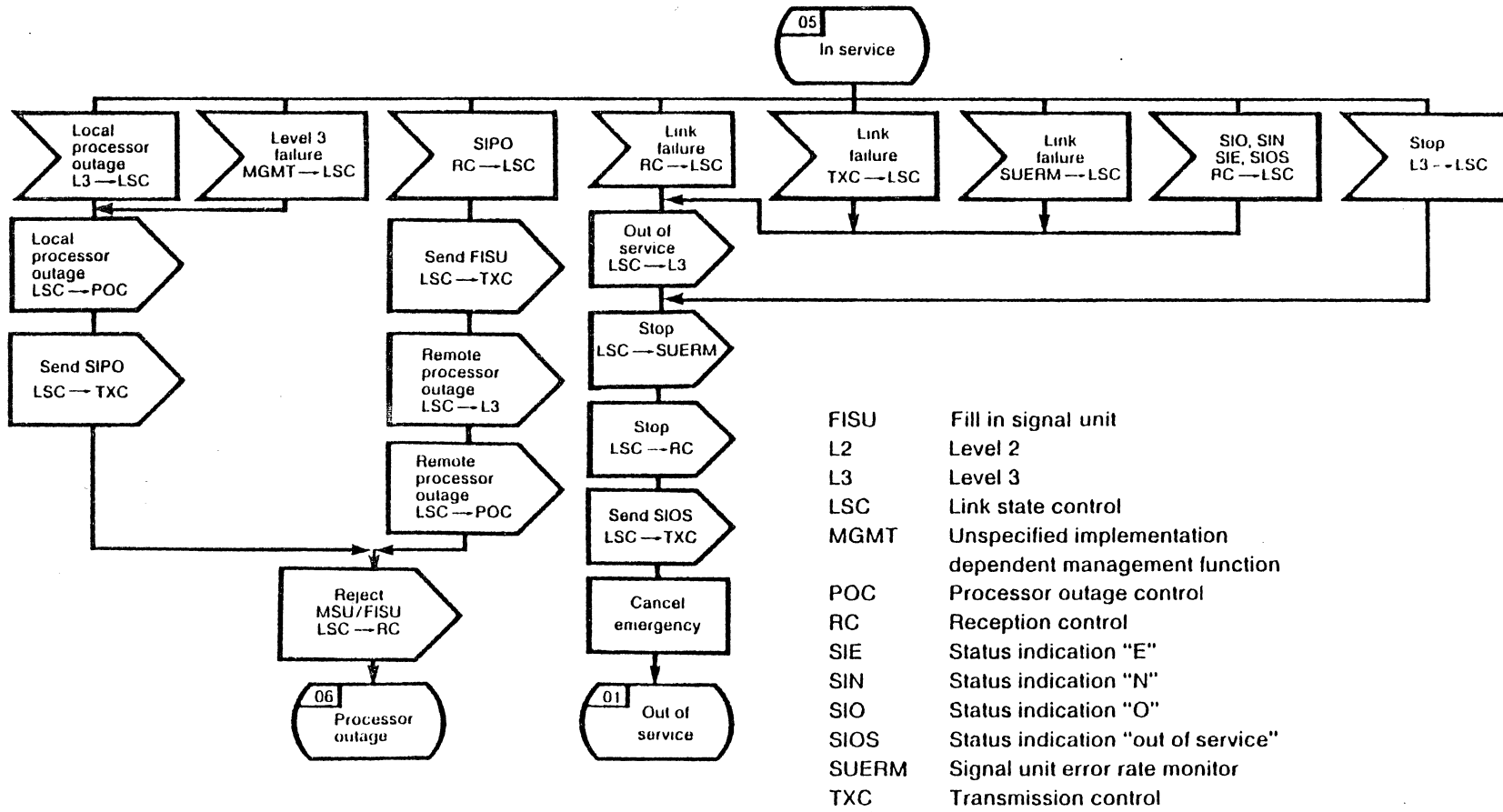

Figure 8/Q.703 -
Link state control (sheet 6 of 7)

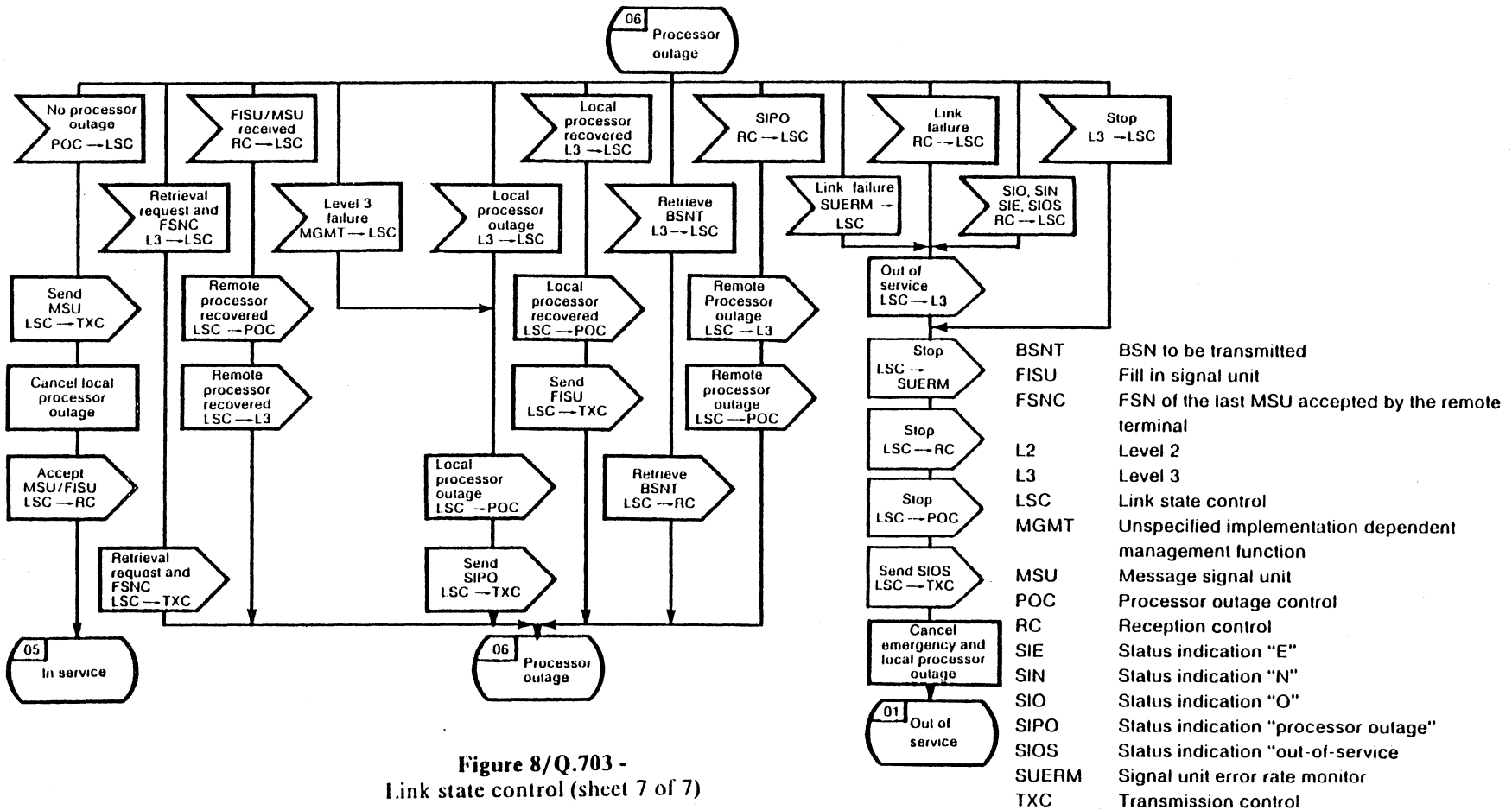

Figure 8/Q.703 -
Link state control (sheet 7 of 7)

Signalling Link

Signalling Link

Q.703

- IAC Initial alignment control
- LSC Link state control
- PE Emergency proving period
- PN Normal proving period
- RC Reception control
- SIE Status indication "E"
- SIN Status indication "N"
- SIO Status indication "O"
- TXC Transmission control
- T2 Timer "not aligned"
- T3 Timer "aligned"
- T4 Proving period timer

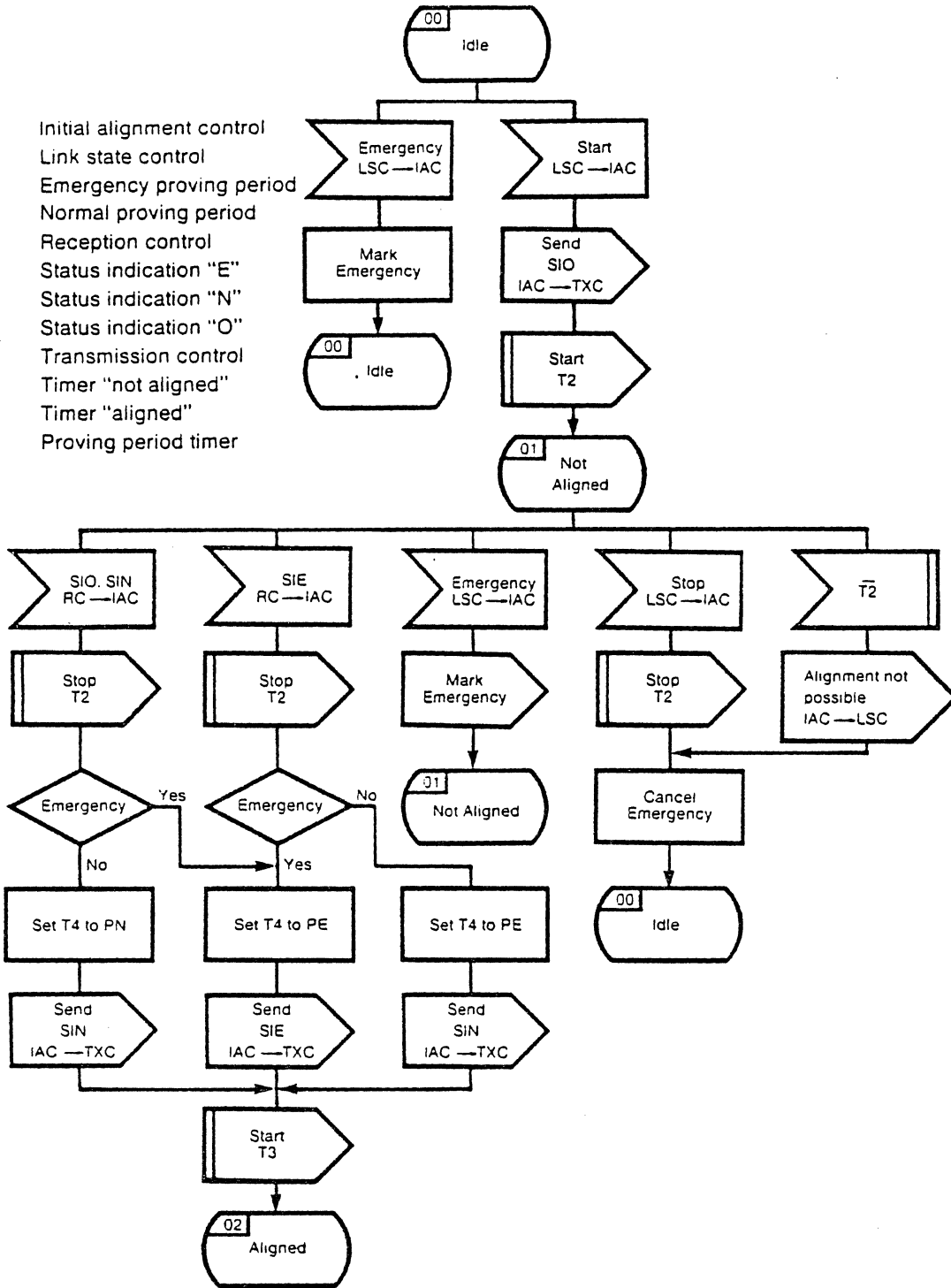
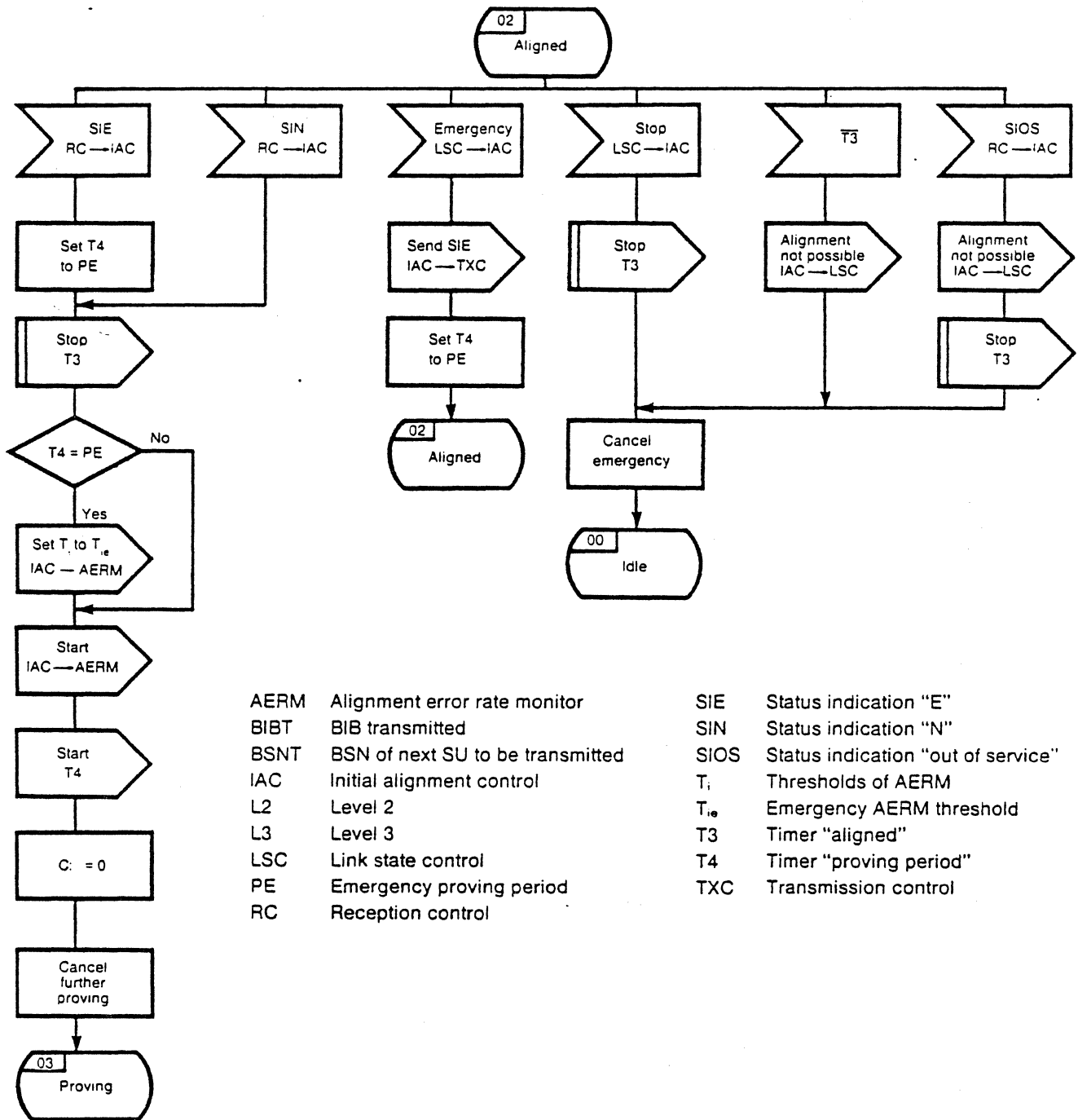

Figure 9/Q.703 - Initial alignment control (sheet 1 of 3)

Signalling Link



- | | | | |
|------|----------------------------------|-----------------|------------------------------------|
| AERM | Alignment error rate monitor | SIE | Status indication "E" |
| BIBT | BIB transmitted | SIN | Status indication "N" |
| BSNT | BSN of next SU to be transmitted | SIOS | Status indication "out of service" |
| IAC | Initial alignment control | T _i | Thresholds of AERM |
| L2 | Level 2 | T _{ie} | Emergency AERM threshold |
| L3 | Level 3 | T3 | Timer "aligned" |
| LSC | Link state control | T4 | Timer "proving period" |
| PE | Emergency proving period | TXC | Transmission control |
| RC | Reception control | | |

Figure 9/Q.703 -
Initial alignment control (sheet 2 of 3)

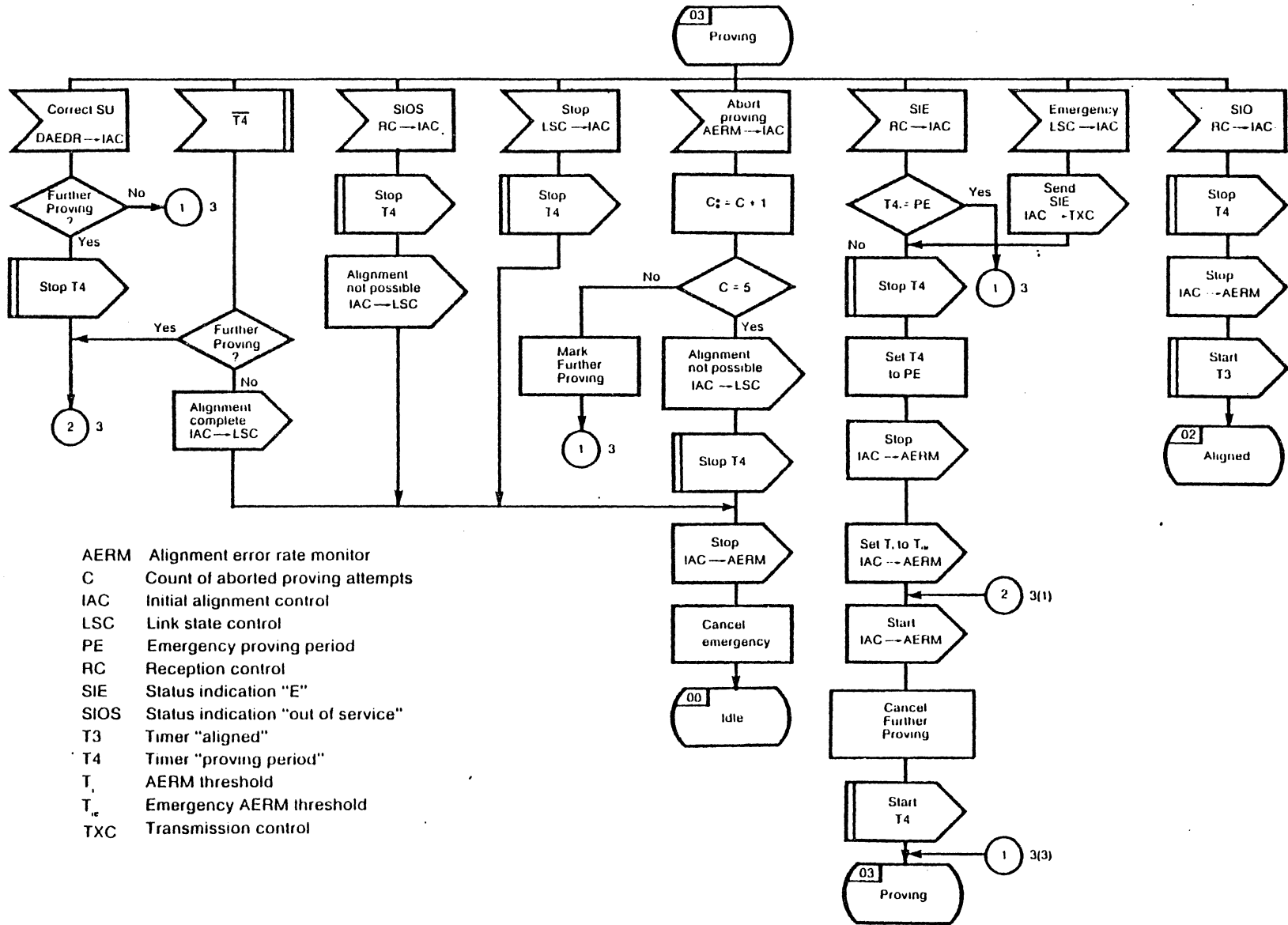

- AERM Alignment error rate monitor
- C Count of aborted proving attempts
- IAC Initial alignment control
- LSC Link state control
- PE Emergency proving period
- RC Reception control
- SIE Status indication "E"
- SIOS Status indication "out of service"
- T3 Timer "aligned"
- T4 Timer "proving period"
- T_e AERM threshold
- T_e Emergency AERM threshold
- TXC Transmission control

Figure 9/Q.703 -
Initial alignment control (sheet 3 of 3)

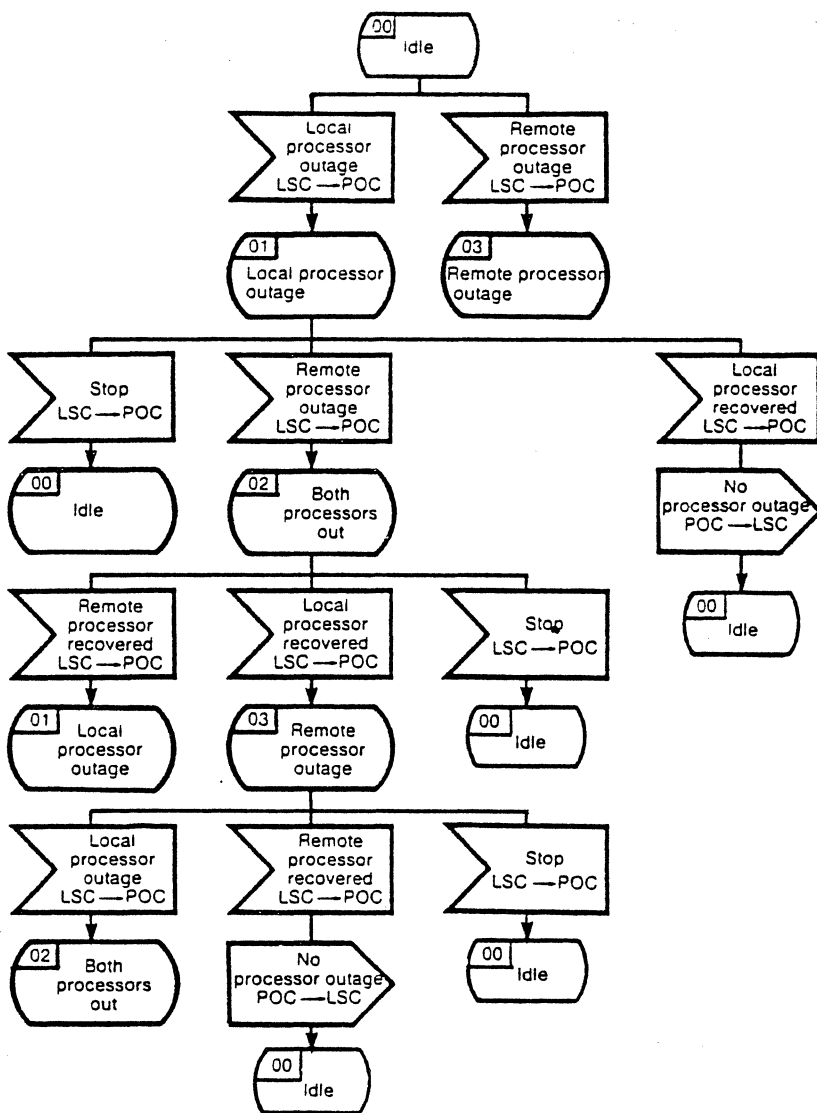

LSC Link state control
 POC Processor outage control

Figure 10/Q.703 -
 Processor outage control

Signalling Link

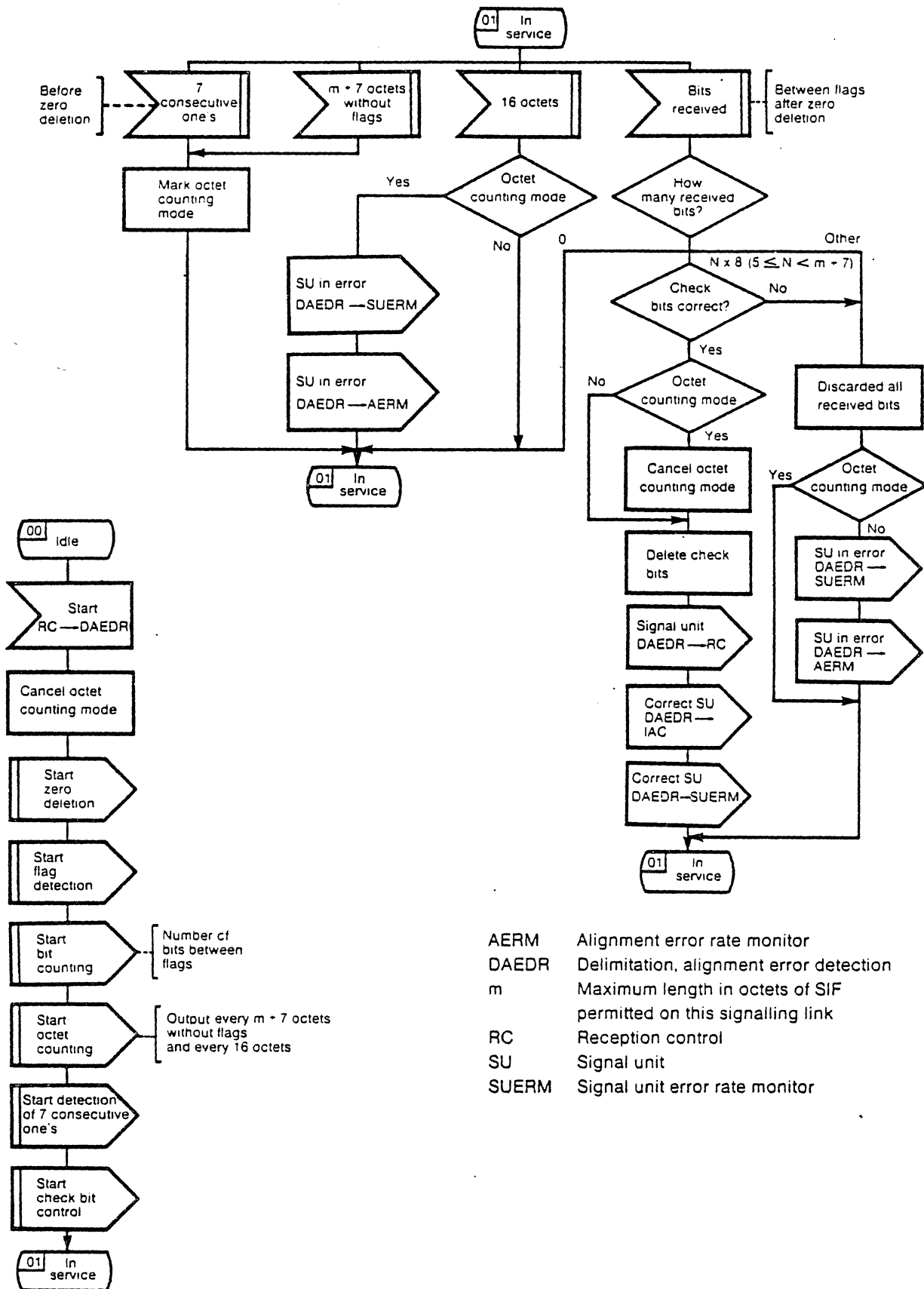

Figure 11/Q.703 -
Delimitation, alignment and error detection (receiving)

Signalling Link

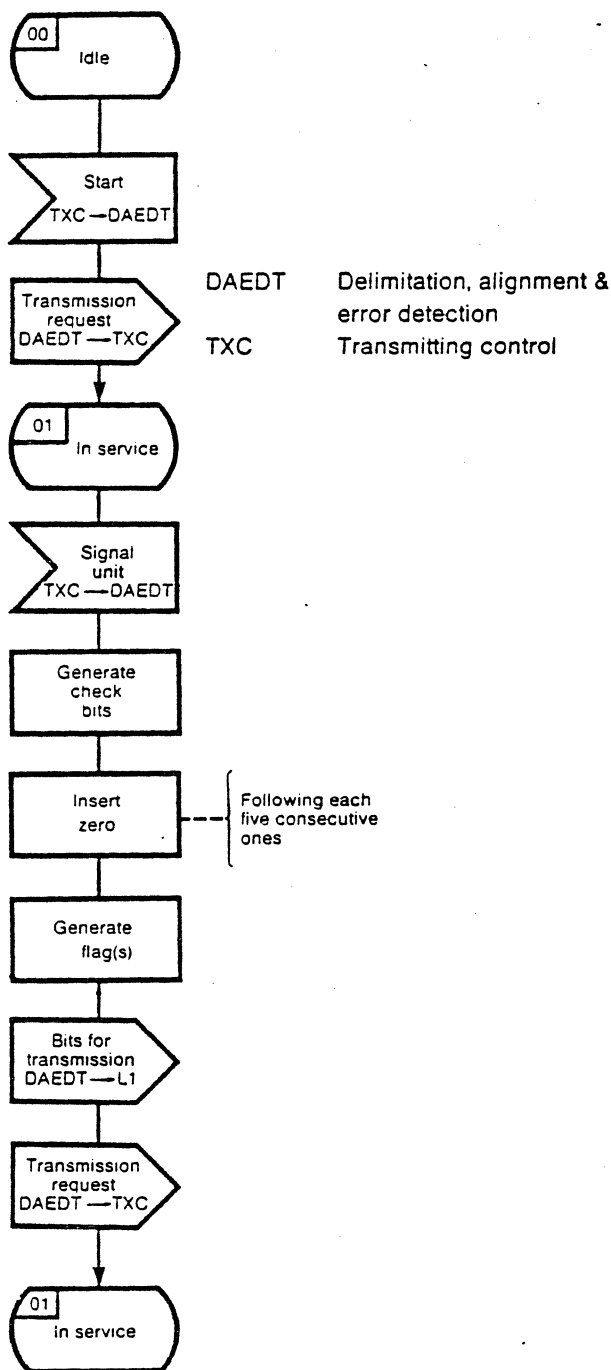

Figure 12/Q.703 -
 Delimitation, alignment and error detection (transmitting)

Signalling Link

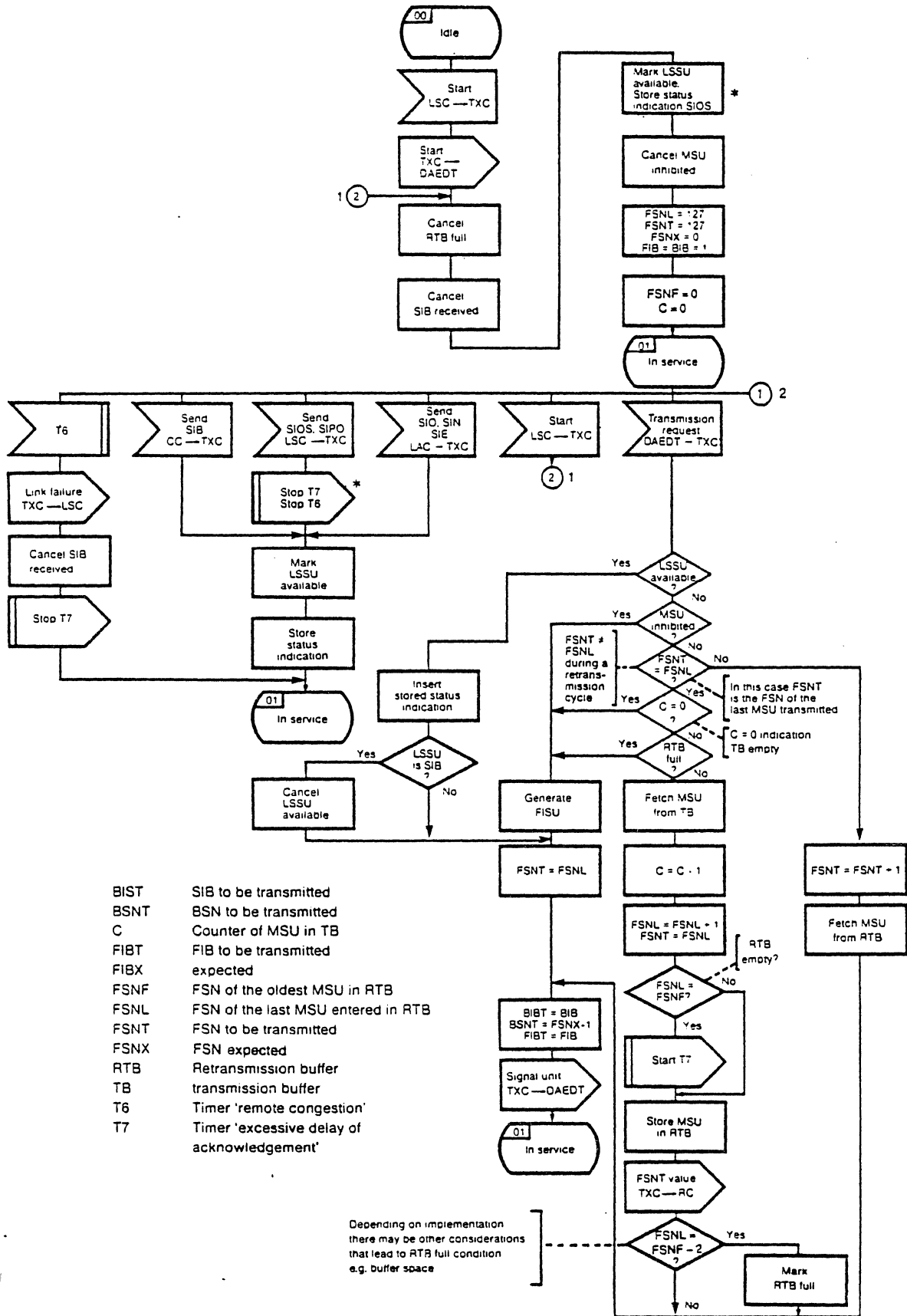
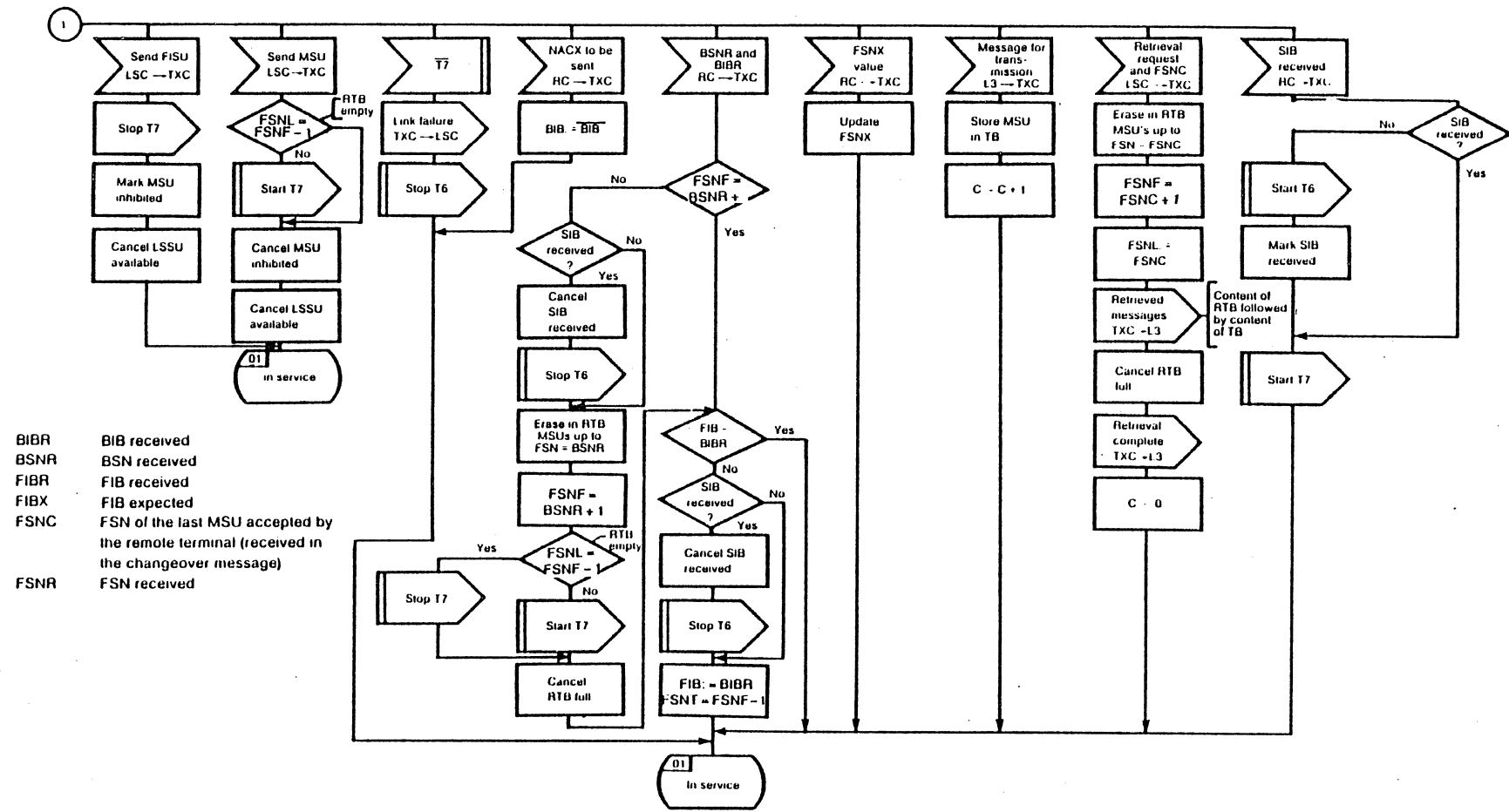

Figure 13/Q.703 - Basic transmission control (sheet 1 of 2)



BIBR BIB received
 BSNR BSN received
 FIBR FIB received
 FIBX FIB expected
 FSNC FSN of the last MSU accepted by
 the remote terminal (received in
 the changeover message)
 FSNR FSN received

Figure 13/Q.703 -
 Basic transmission control (sheet 2 of 2)

Signalling Link

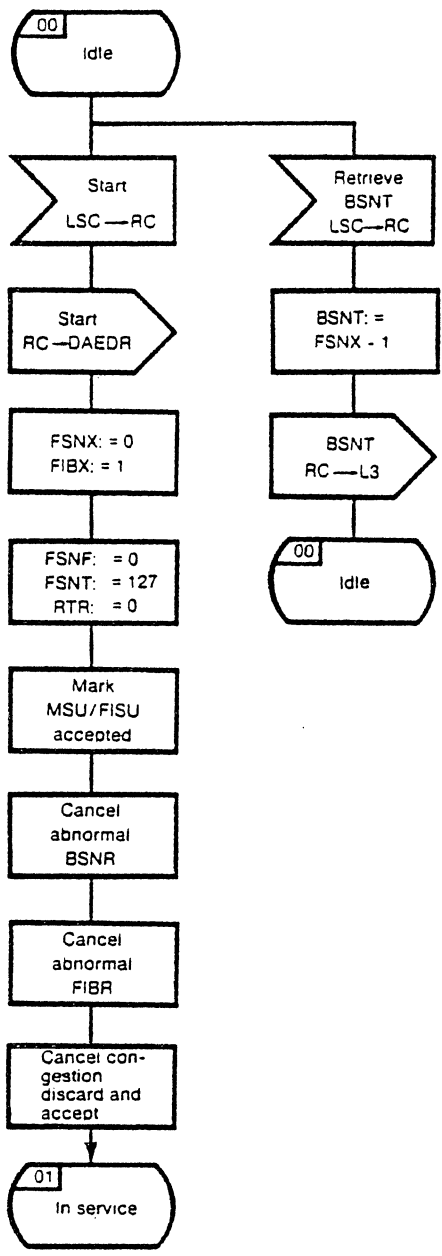
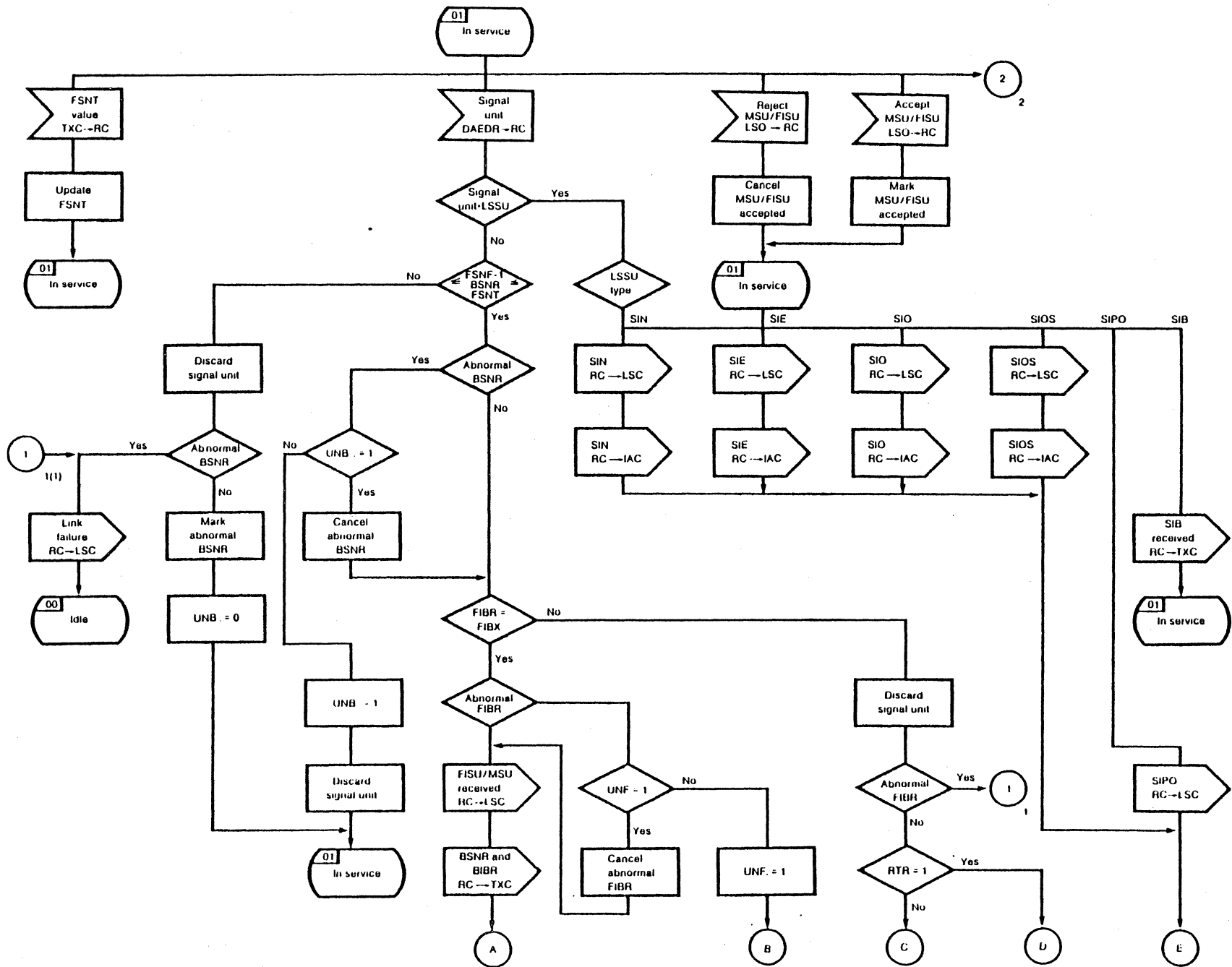

Figure 14/Q.703 - Basic reception control (Sheet 1 of 4)



Signalling Link

Figure 14/O.703-

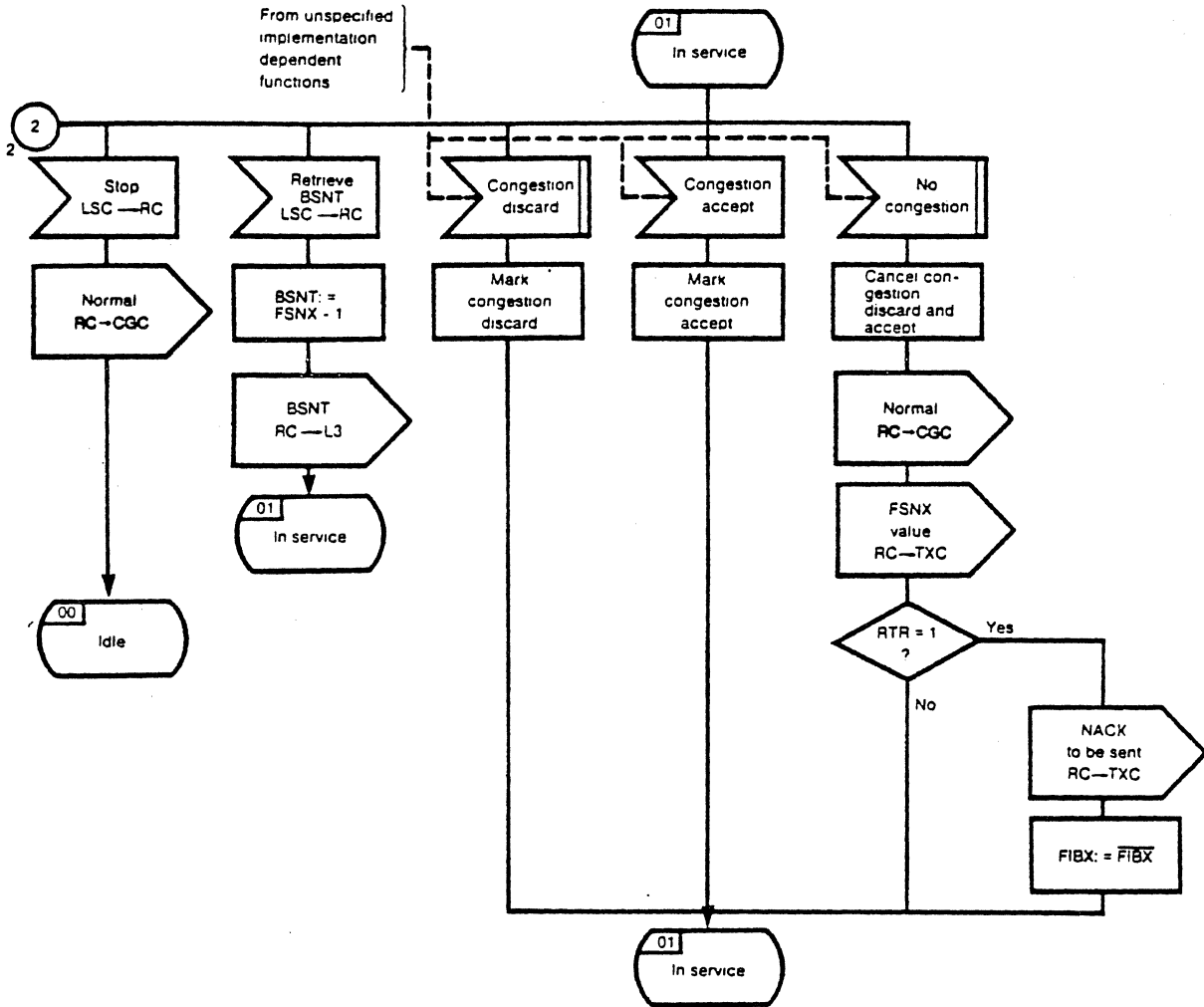
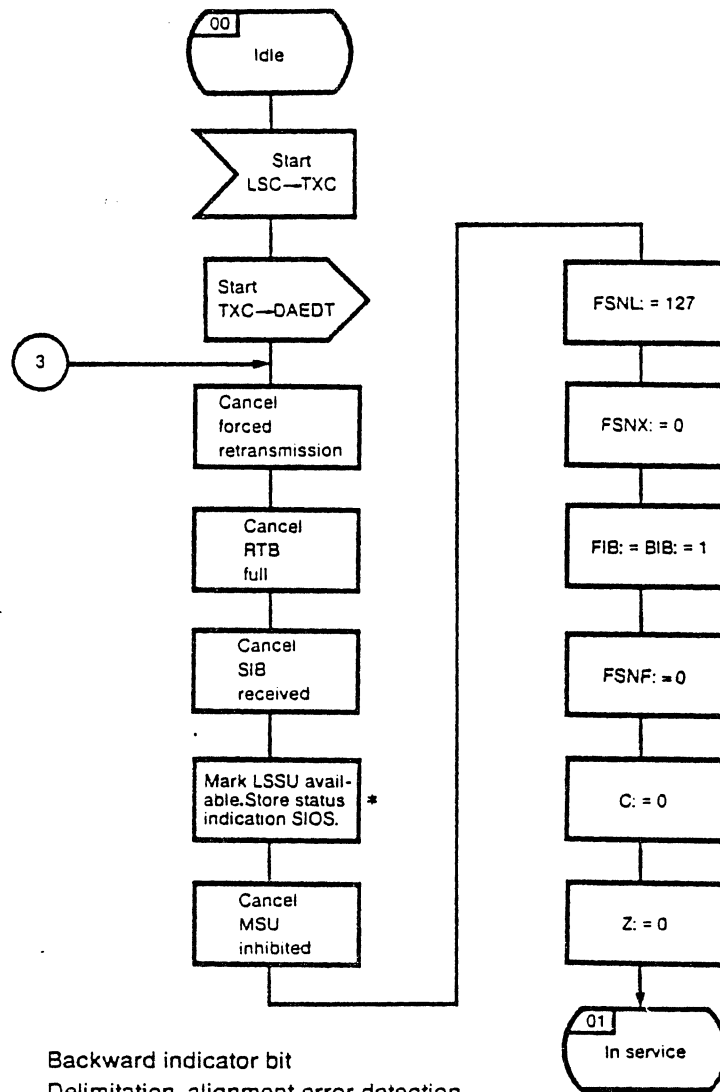

Figure 14/Q.703 - Basic reception control (Sheet 4 of 4)



BIB Backward indicator bit
 DAEDT Delimitation, alignment, error detection
 FIB Forward indicator bit
 FSNF FSN of the oldest MSU in RTB
 FSNL FSN of the last MSU entered into RTB
 FSNX FSN expected
 LSC Link state control
 RTB retransmission buffer
 TXC Transmission control

Figure 15/Q.703.

Preventive cyclic retransmission/transmission control (sheet 1 of 3)

Signalling Link

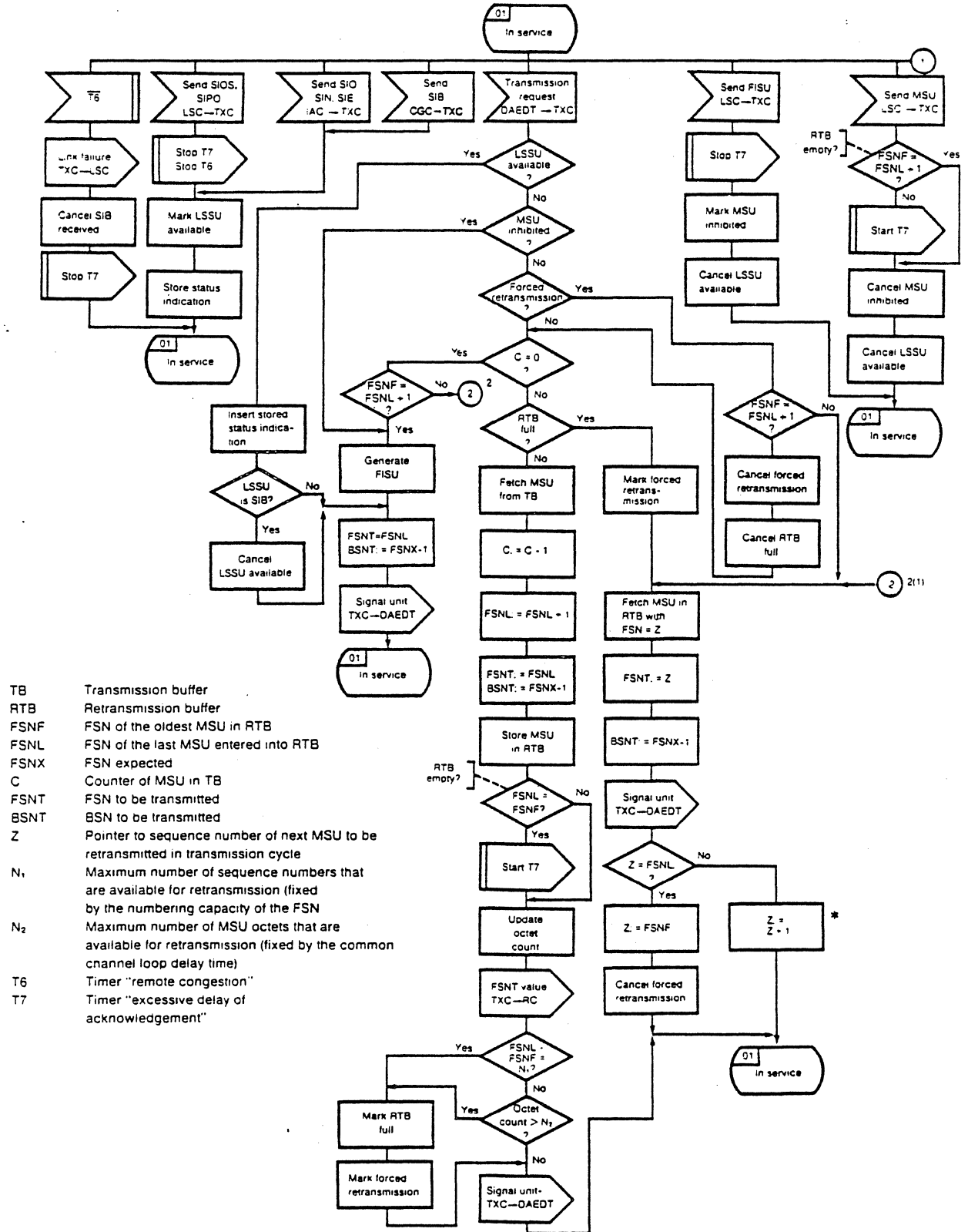

Figure 15/Q.703 - Preventive cyclic retransmission-transmission control (sheet 2 of 3)

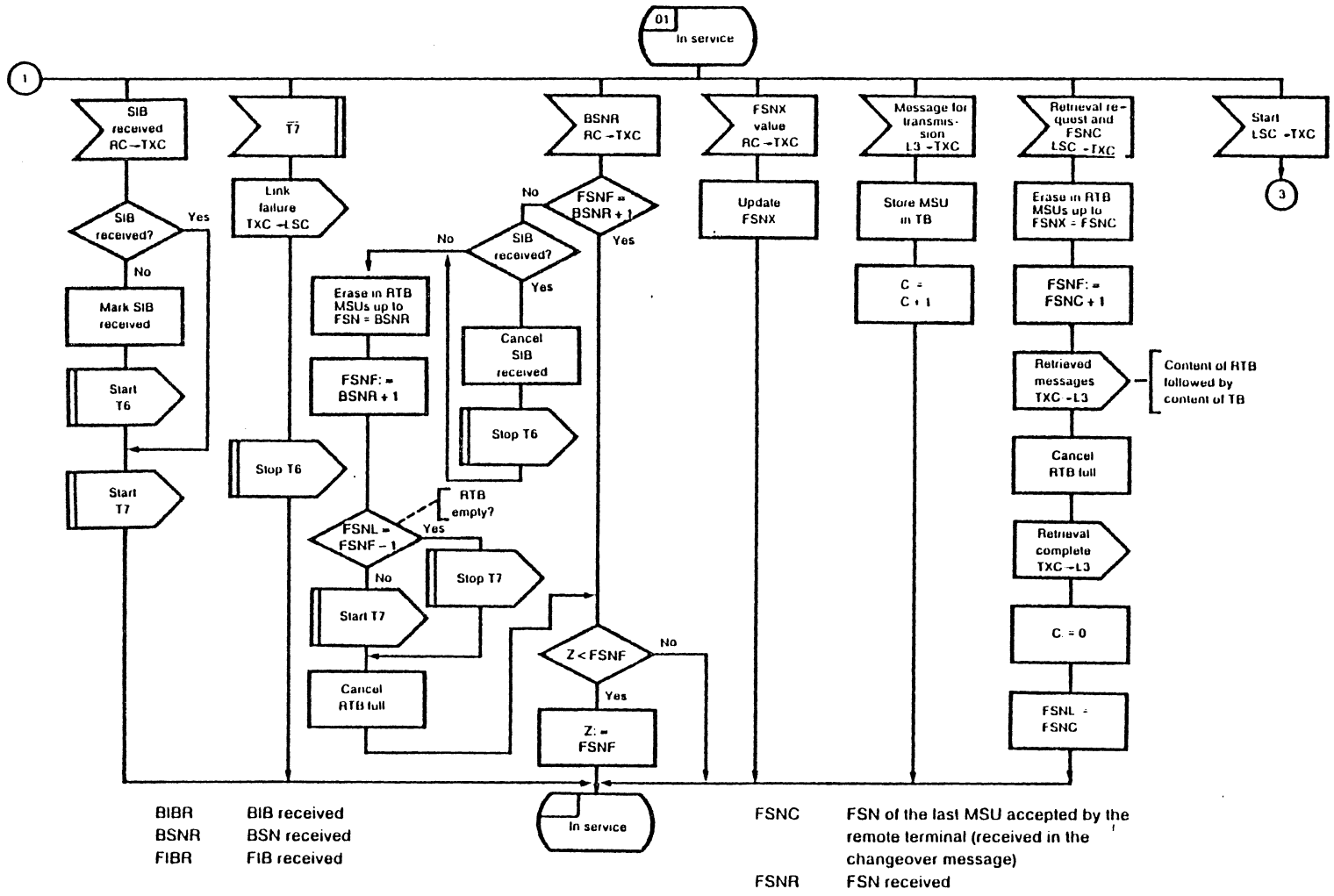

Figure 15/Q.703 - Preventive cyclic retransmission/transmission control (sheet 3 of 3)

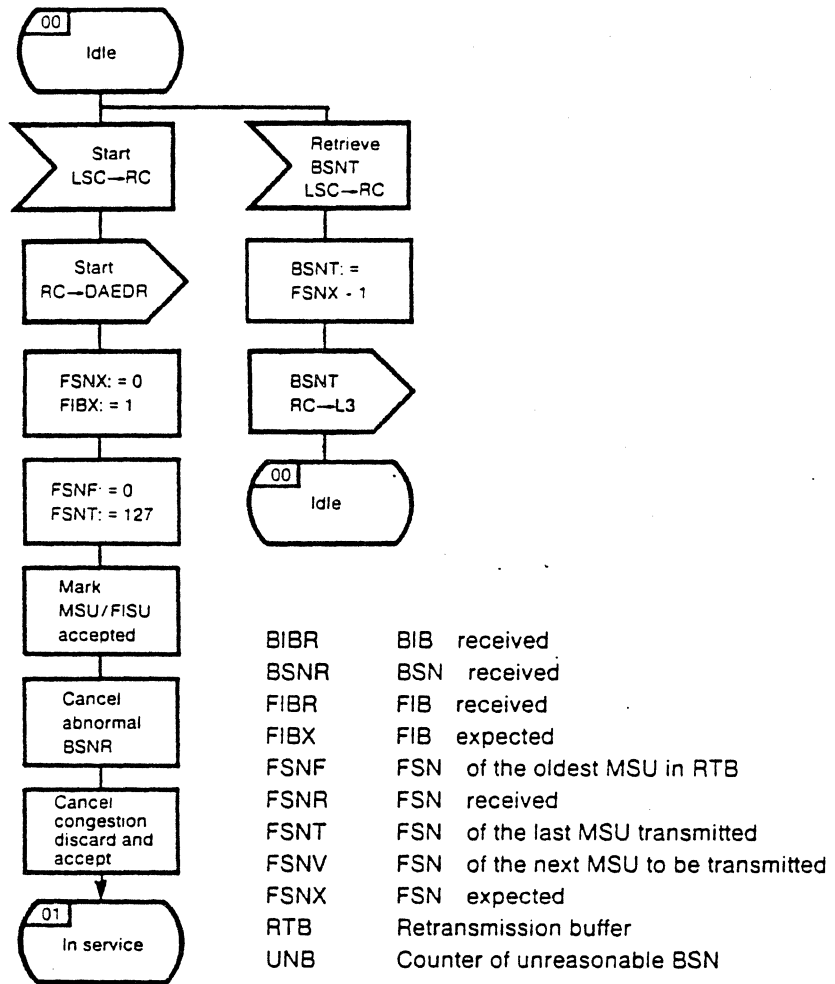

Figure 16/Q.703 - Preventive cyclic retransmission. reception control (Sheet 1 of 3)

Signalling Link

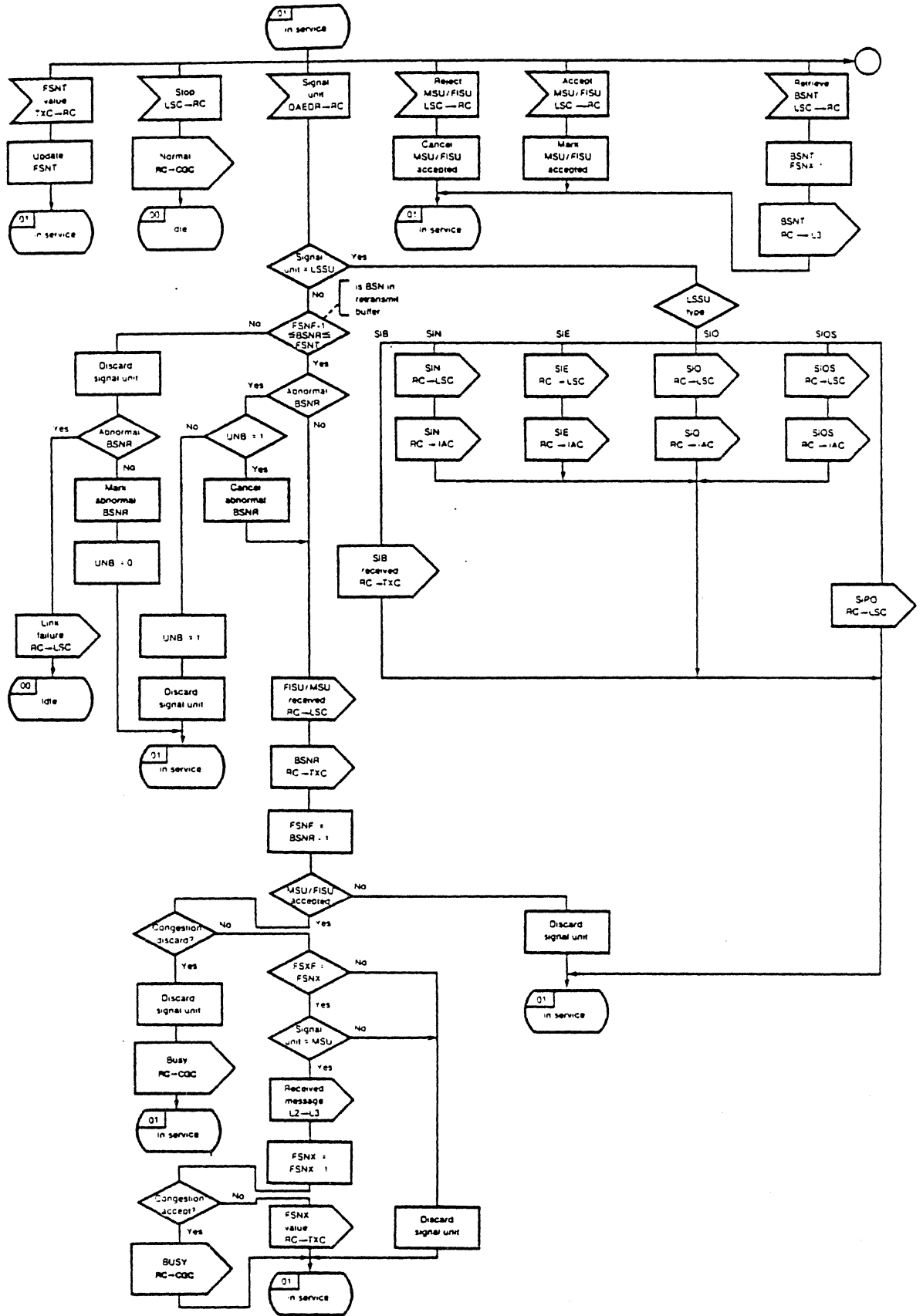

Figure 16/Q.703 - Preventive cyclic retransmission/reception control (sheet 2 of 3)

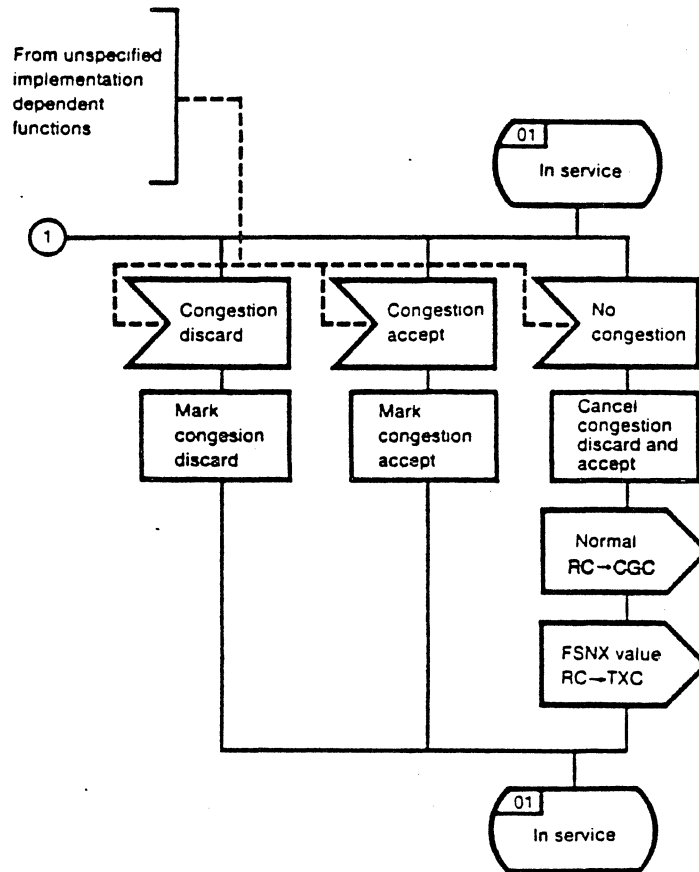

Figure 16/Q.703 - Preventive cyclic retransmission/reception control (sheet 3 of 3)

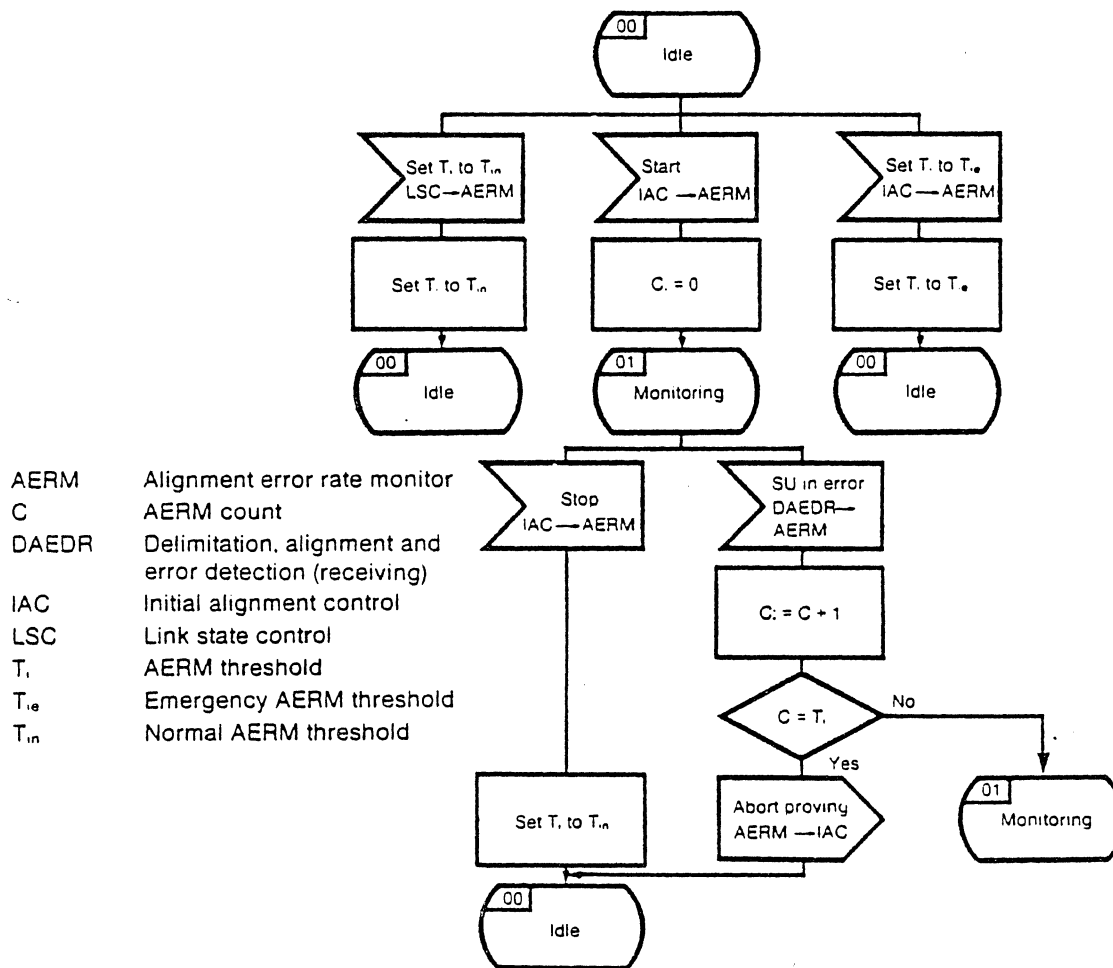

FIGURE 17/Q.703
Alignment error rate monitor

Signalling Link

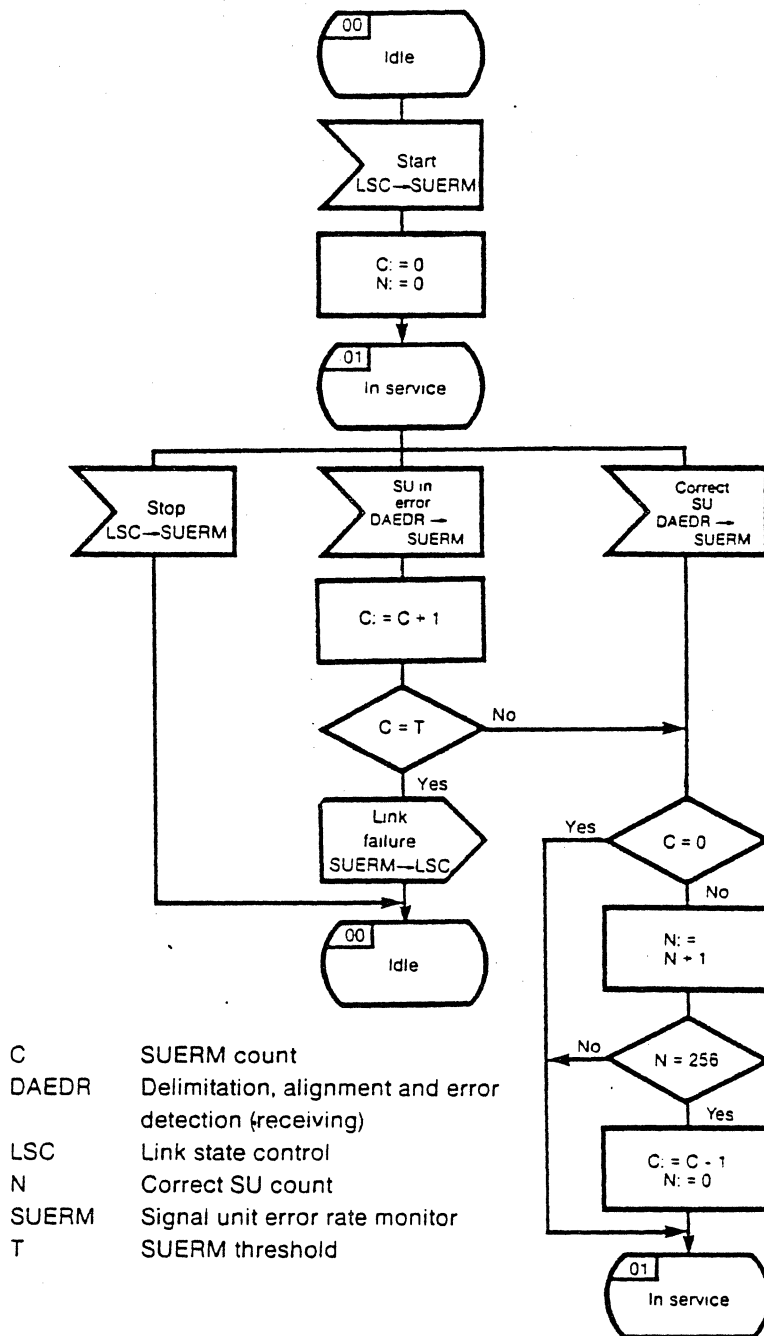

Figure 18/Q.703 -
Signal unit error rate monitor

Signalling Link

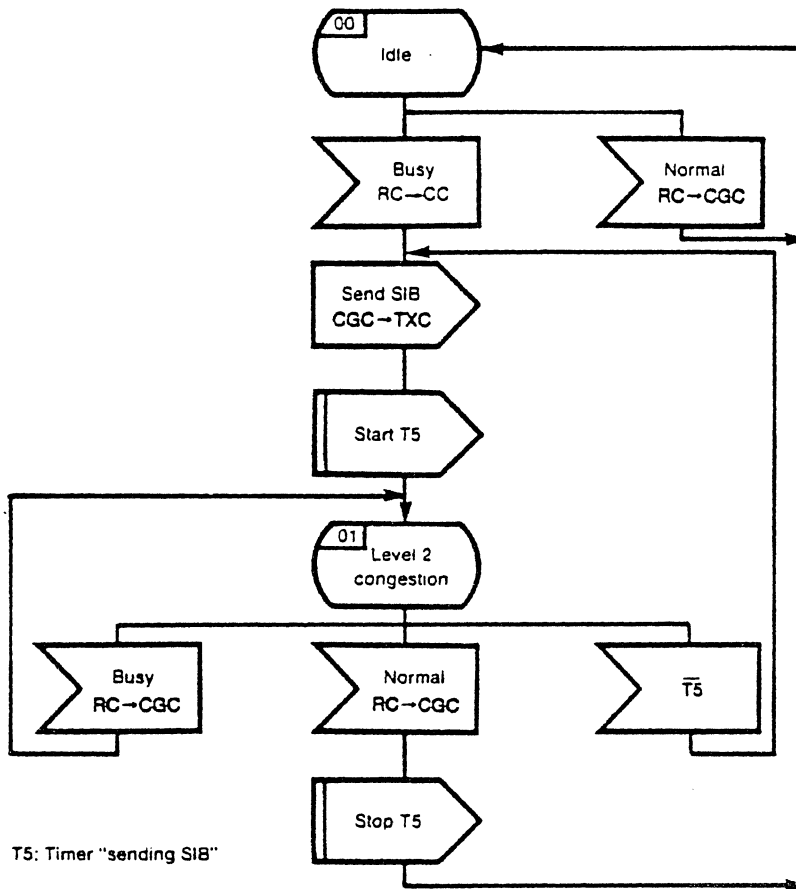

Figure 19/Q.703 - Congestion control