

DESKTOP POWER SERIES

PUBLISHING POWER WITH VENTURA

Second Edition



The Complete Teaching Guide
to Xerox Ventura Publisher

Martha Lubow and Jesse Berst

Supports Version 2

DAVID A. RICHARDS, CPA
1627 First Avenue
York, Pennsylvania
17403-1945

PUBLISHING POWER WITH VENTURA

**The Complete Teaching Guide to
Xerox Ventura Publisher**

Second Edition

Martha Lubow and Jesse Berst



**New Riders Publishing
Thousand Oaks, California**

PUBLISHING POWER WITH VENTURA

The Complete Teaching Guide to Xerox Ventura Publisher

Second Edition

by Martha Lubow and Jesse Berst

Published by:

New Riders Publishing
PO Box 4846
Thousand Oaks, CA 91360
U.S.A.

All rights reserved. No part of this book may be reproduced or transmitted in any form or by any means, electronic or mechanical, including photocopying, recording or by any information storage and retrieval system without written permission from the authors, except for the inclusion of brief quotations in a review.

Copyright © 1988 and 1989 by Martha Lubow and Jesse Berst

Second Edition 1989

Printed in the United States of America

Library of Congress Cataloging-in-Publication Data

Lubow, Martha, 1952-
Publishing Power with Ventura

Includes index.

1. Desktop Publishing. 2. Xerox Ventura
Publisher (Computer program) I. Berst, Jesse.
II. Title.

Z286.D47L8 1989
ISBN 0-934035-61-X

686.2'2

88-33034

About the Authors

MARTHA LUBOW has been teaching and writing about computer graphics and design since 1979. A graduate of Stanford University, Martha first got hooked on computer graphics at Bucks County Community College, where she designed one of the country's first computer art exhibits. Since then she has taught and developed computer graphics teaching guides for university-level and Fortune 500 training programs. She is the author of the popular training guide, *Working Out with AutoCAD*.

Martha is the co-author of two other New Riders books about Ventura, *Style Sheets for Business Documents* and *Style Sheets for Newsletters: Advanced Designs for Xerox Ventura Publisher*. She has also written articles on computer-aided-design and desktop publishing for trade publications. Martha is a design and editorial consultant in Bucks County, PA.

JESSE BERST was Executive Editor of *MicroPublishing Report*, the nation's first desktop publishing newsletter. He has authored or co-authored seven books on desktop publishing and other computer topics, including the bestselling *Inside Xerox Ventura Publisher*. He has written hundreds of magazine articles for publications such as *PC World*, *Personal Publishing*, *Publishers Weekly*, *Small Press* and many others.

Production

Lead Editor: Keith Thompson

Director of Production: Carolyn Porter

Production Manager: Todd Meisler

Cover design: Jill Casty

Page design: Jesse Berst, Keith Thompson, and Martha Lubow

Drawings and illustrations: Martha Lubow, Todd Meisler, Keith Thompson, and Melanie Powell

From a Concept by: Harbert Rice

Warning and Disclaimer

This book is designed to provide information about Xerox Ventura Publisher. Every effort has been made to make it as complete and as accurate as possible.

However, no warranty of suitability, purpose or fitness is made or implied. The authors and New Riders Publishing shall have neither liability nor responsibility to any person or entity with respect to loss or damages in connection with or arising from the information contained in this book.

If you do not agree with the above, you may return this book for a full refund.

Acknowledgments

The authors and New Riders Publishing wish to express their grateful appreciation to all the people who contributed their expertise, support, and inspiration to the creation of this book:

To John Meyer and Michelle Polliard (Ventura Software), Ellen Brout (Oracle Corporation), Lainie Howard (Relational Technology), Richard Katz and the UCLA PC Users Group, Dorothy Kent (Synergis Technologies), Ivy Strickler (Drexel University), Lisa Kirk, Mark Hirsh, De Winchell, and Linda Yoder.

Many thanks to Jon DeKeles for his technical assistance, support, and troubleshooting.

Special thanks and appreciation goes to Robert E. Sturmer of WordCraft Publishers, Yardley, PA, whose invaluable comments and thorough review and testing of the tutorials made this a better book for everyone.

Heartfelt appreciation goes to Carolyn Porter and Todd Meisler for their relentless hard work and their skill and talent in production; and to Keith Thompson for his imaginative suggestions and indispensable contributions to the design, review, and production of this book.

Martha would like to express her thanks to Jerry Waxler and Katherine Sharp for their enduring love, patience, and understanding during the writing of this book; to her parents, Oscar and Miriam Lubow, for their unconditional encouragement and support; and to Mac, whose love and companionship has given new meaning to life after work.

And finally, to Harbert Rice, whose vision brought us all together.

Special thanks from Jesse to Lori White for encouragement, assistance, and understanding.

Our appreciation to the companies and individuals who provided software or hardware for the project: Randi Doeker and Xerox Corporation, Annie Barfuss and Hill & Knowlton, Digital Research, Executive Systems, Inc.,

Microsoft Corporation, Moniterm, Symsoft, Verticom, Z-Soft Corporation.

For the design of the directory in Chapter Seven, many thanks to Jim Cavuoto, micropublishing Report.

For permission to reprint the computer drawing from Chapter Five, Digital Research, Inc.

Trademarks

Ventura Publisher is a registered trademark of Ventura Software, Inc.

Xerox is a registered trademark of Xerox Corp.

IBM is a registered trademark of International Business Machines

Illustrator and PostScript are registered trademarks of Adobe Systems.

AutoCAD is a registered trademark of Autodesk, Inc.

WordStar is a registered trademark of MicroPro International Corp.

MS-DOS, Microsoft and Word are registered trademarks of Microsoft Corp.

LaserWriter is a registered trademark of Apple Computer, Inc.

LaserTorq is a registered trademark of LaserTools Corporation.

Lotus 1-2-3 is a registered trademark of Lotus Development Corp.

PC Paintbrush is a registered trademark of Z-Soft, Inc.

Contents

Introduction

Becoming a Power Publisher *i*

Goals and objectives *i*
How to use this book *iv*
The Ventura Formula *x*

Chapter One

A Single-Column Report 1-1

Planning the report 1-7
Ventura prep 1-15
Text 1-20
Style 1-30
Pictures 1-57
Chapter 1-62

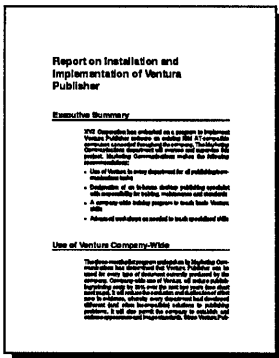

Chapter Two

A Two-Column Proposal 2-1

Planning the proposal 2-8
Ventura prep 2-10
Text 2-15
Style 2-22
Pictures 2-41
Chapter 2-54

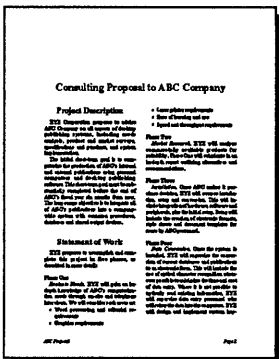

Chapter Three

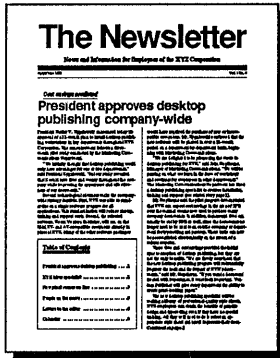

A Two-Column Newsletter 3-1

Planning the newsletter 3-13

Ventura prep 3-13

Text 3-16

Style 3-17

Pictures 3-58

Chapter 3-61

Chapter Four

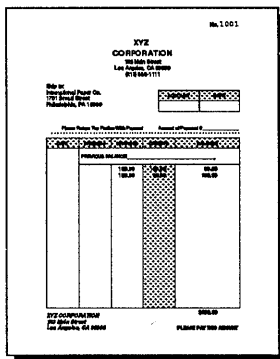

An Invoice 4-1

Planning the invoice 4-12

Ventura prep 4-13

Text 4-17

Style 4-17

Pictures 4-47

Chapter 4-53

Chapter Five

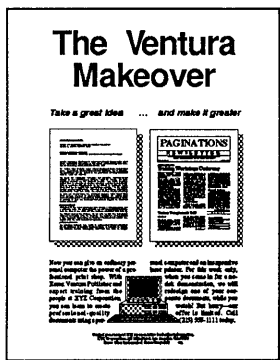

An Advertising Flyer 5-1

Planning the flyer 5-10

Ventura prep 5-12

Text 5-13

Style 5-14

Pictures 5-36

Chapter 5-52

Chapter Six

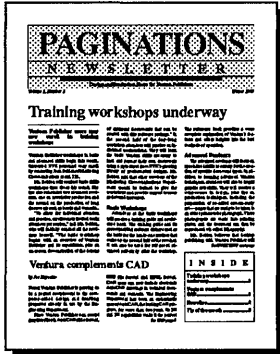

A Three-Column Newsletter 6-1

Planning the newsletter 6-6

Ventura prep 6-7

Style 6-11

Pictures 6-51

Chapter 6-59

Chapter Seven

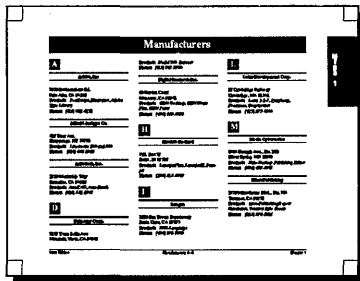

A Directory 7-1

7-1

Planning the directory 7-6

Ventura prep 7-7

Text 7-7

Style 7-8

Pictures 7-25

Chapter 7-38

Chapter Eight

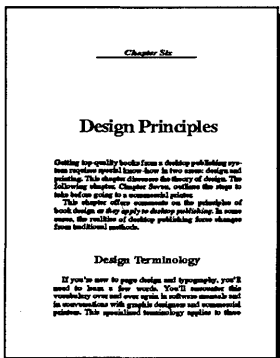

A Book 8-1

8-1

Planning the book 8-3

Ventura prep 8-4

Text 8-5

Style 8-17

Pictures 8-32

Chapter 8-32

Chapter Nine

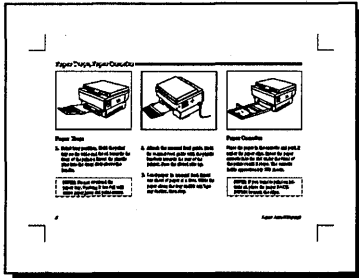

A Technical Manual

9-1

Planning the manual 9-5

Ventura prep 9-6

Style 9-7

Pictures 9-38

Chapter 9-50

Chapter Ten

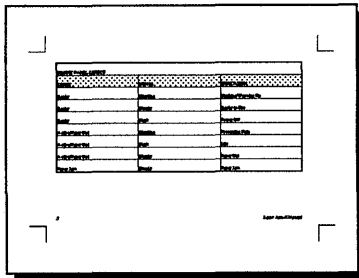

The Professional Extension 10-1

Ventura prep 10-16

Text 10-17

Style 10-23

Chapter 10-39

Appendix A

Text Files

A-1

Appendix B

Tag Tables

B-1

Appendix C

Installing the Power Disk

C-1

Appendix D

Colophon

D-1

Index

E-1

Introduction

Becoming a Power Publisher

Please don't skip this introduction. Yes, we know that many authors use the introduction just to say hello. Many readers, therefore, skip to Chapter One so they can get right to business.

This introduction, however, has several crucial functions. First, it explains the most productive, efficient way to use *Publishing Power with Ventura*. Second, it explains how to prepare your computer system so you can work along with the projects. Third, it contains a key formula you will use over and over again. *The Ventura Formula explained at the end of this introduction is the foundation for the rest of the book.*

Goals and objectives

Publishing Power with Ventura will help you tap the full potential of Xerox Ventura Publisher.

It's no secret that Ventura has more horsepower than ordinary page layout programs. Ventura can create virtually any type of document, from one-page ads to 500-page directories and anything in between.

With Ventura, you have the power to create almost any document. The samples on page *ii* were all created entirely with Ventura.

INVOICE
No. 2387

Orange Micro Books, Inc.
122341 River
Los Angeles, CA 90002
(213) 500-1512

Order No. Order Date Customer No.

| Qty. | Ordered | Unit | Item No. | Description |
|------|---------|------|----------|-------------|
| | | | | |

Please pay per invoice. All amounts include shipping and handling.

Purchase Agreement

THIS AGREEMENT IS ENTERED INTO as of January 1, 1988, by and between The Orange Corporation, a California corporation, and The Area Company, New York state proprietorship.

In consideration of the purchase and related agreements heretofore entered, the parties hereto have entered into the following:

1. Product Sample body text. This is text for the purpose of the test. This is sample text of purpose of demonstration.

2. Delivery Sample body text. This is text for the purpose of the test. This is sample text of purpose of demonstration.

3. Terms Sample body text. This is text for the purpose of the test. This is sample text of purpose of demonstration.

A. Order Payment Sample body text. This is text for the purpose of the test. This is sample text of purpose of demonstration.

B. Payment Methods Sample body text. Sample text.

C. Confidentiality Policy Sample body text. This is text for the purpose of the test. This is sample text of purpose of demonstration.

Page 1 of 2

3 Circuit Description

Overview
This section defines the functions of the LUPM 88 product hardware components. Each circuit is described by a block diagram accompanied by a written description.

General Architecture
Data is input to the LUPM 88 through the Universal Programmer's bus. This is a bidirectional bus which is connected to the LUPM 88 and output to the LUPM 88 through the LUPM 88 address, data, and control buses. Each of these buses is described below.

The LUPM 88 is controlled by the programmer's control signals through the LUPM 88 control bus. The control signals for the LUPM 88 are listed in the LUPM 88 control signal list (see page 10 of the LUPM 88 manual).

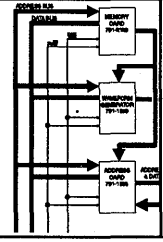

Chapter 5 Utilities Mode

Chapter Six

UTILITIES MODE is used to:

- execute 340 and return to DOS;
- mapes, models or drawings;
- mapes, models or macros that have just been saved;
- the GML Debug feature on or off; and
- names in a user specified directory.

through a model, using a poly line as the

APRIL POST

VENTURA Scoop

MARCH 1989 For Ventura Desktop Professionals VOL. 4/No. 4

Xerox shows off new version at Comdex '88

XEROX CORPORATION has introduced version 1.1 of its fast document publishing software product that uses an industry standard program. Xerox shows the Beta Center to improve the speed and reliability of the new version in the industry standard software market. Customer attention was impressed by the right one new features, all of which were added without compromising the speed of the product or its ease of handling.

The Xerox Desktop Publishing Software Series Ventura Publisher 1.1 is available through Xerox International/Canada/UK/China/India, Xerox International/UK/China/India, and the Xerox Desktop Software Center via 800 822 8211, and the Xerox present Line active Xerox. This includes a Xerox desktop. The benefits of this publication improve Xerox's

... (text continues) ...

THIS ISSUE

| | | | |
|----------------------------------|---|-------------------------|---|
| TRAINING WORKSHOPS OVERVIEW | 1 | 8086 AND OVERVIEW | 3 |
| XEROX RELEASES VERMONT 1.1 | 1 | BOOK TITLES OF INTEREST | 2 |
| ATOM INDEX FOR BELL/NOVA/CALIBAT | 3 | NEWSLINE | 4 |
| TOP OF THE MONTH | 3 | BROWNIE BUZZER | 4 |
| VENTURA COMMENTARY CAD | 5 | BOOKS FOR THE MONTH | 5 |

Design Principles

... (text continues) ...

Design Terminology

... (text continues) ...

5

UTILITIES MODE is used to:

- execute 340 and return to DOS;
- mapes, models or drawings;
- mapes, models or macros that have just been saved;
- the GML Debug feature on or off; and
- names in a user specified directory.

through a model, using a poly line as the

Yet with all that power at their disposal, some users complain. They feel like a beginning driver who hasn't learned to shift into high gear. They can get Ventura up and running, they can point it in the right general direction, but they can't seem to fine-tune its performance for maximum productivity.

This book will move you into the fast lane. Best of all, it will show you how to stay in control the whole time. You'll know where to start and where to go next, no matter what kind of document you are preparing. In short, you will always be in the driver's seat.

How do we plan to accomplish these goals? First, we put you behind the wheel right from the start. In every chapter, you "test drive" Ventura by creating an actual business document. There's no better way to acquire skills than with hands-on practice. Second, you start with simple documents before moving on to difficult ones. For example, Part One teaches fundamentals. You can follow along even if you are new to Ventura. Part Two, on the other hand, shows how to rev up your publishing with advanced techniques.

Don't be too impatient. Ventura Publisher is one of the most powerful applications ever written for the IBM PC. It will take some time before you reach expert status. To make the journey easier, we start each project with a roadmap, a before-and-after look at the document that shows where you are starting and where you are going. As we proceed, we provide you with signposts to check your progress. Simply check your results against the sample screens and printouts. You will always know if you're on the right track.

Why this Book is different

Publishing Power with Ventura differs from other books and tutorials. First, it is not just a beginner's session. It is a complete training course in Ventura, from novice to advanced. Second, it takes you step-by-step through real-life applications. If you complete all the chapters, you will have a personal library of industrial-strength business documents and style sheets. You will also have the skills to modify those documents to fit the unique requirements of your business. Third, *Publishing Power* provides more than how-to skills. It

also teaches you strategies, systems, techniques, and formulas for working through design problems.

We believe that if you follow the examples in this book, you will be able to gain full control over Ventura's sophisticated capabilities. You will be able to create virtually any kind of document — books, ads, newsletters, manuals, forms, reports — right on your desktop.

Now that's true publishing power.

How to use this book

Publishing Power with Ventura contains two sections. Part One, Getting Started, teaches basic skills. Part Two, Advanced Documents, teaches advanced techniques as they apply to specific business applications. Part Two also includes a chapter that teaches the advanced features of Ventura's Professional Extension. We recommend that everyone complete Part One (Chapters One, Two, and Three). Even experienced Ventura users should skim Part One, because it does more than clarify basic features. *Part One also provides a systematic plan for using Ventura.* The advanced chapters in Part Two assume that you understand the building blocks explained up front.

How to use part two

Although Part One is essential, not everyone needs to go through all of Part Two. The method you use for the second half will depend on your needs. If you are an occasional user, produce only one type of document, or are short on time, select chapters that teach the skills you need right now. If you later expand to different documents, return to Part Two to learn more. Table 1 suggests an abbreviated curriculum based on the type of document you produce.

Table 1. An Abbreviated Curriculum

| Document to Produce | Chapters to Study | Key Skills |
|-------------------------------|--|--|
| Books | Part One | Basic skills |
| | Chapter Eight — A Book | Multi-Chapter, footnotes, indexing, table of contents, equations, update counters, chapter templates |
| | Chapter Nine — A Technical Manual | Frame anchoring, auto-numbering, figure numbering, spot color |
| | Chapter Ten — Using the Professional Extension | Advanced typography, cross references, tables |
| Corporate Documents | Part One | Basic skills |
| | Chapter Four — An Invoice | Box Text |
| Directories, Catalogs | Part One | Basic skills |
| | Chapter Seven — A Directory | Preformatting text, databases and Ventura, chapter templates |
| | Chapter Eight — A Book | Multi-Chapter, footnotes, indexing, chapter templates |
| | Chapter Nine — A Technical Manual | Frames and anchoring, auto-numbering, figure numbering |
| Marketing | Part One | Basic skills |
| | Chapter Four — An Invoice | Box Text |
| | Chapter Five — An Advertising Flyer | Advanced graphics and typography |
| | Chapter Nine — A Technical Manual | Spot color |
| Newsletters, Magazines | Part One | Basic skills |
| | Chapter Three — A Two-Column-Newsletter | Newsletter-style layout, captions sizing and scaling images |
| | Chapter Four — An Invoice | Box Text |
| | Chapter Five — An Advertising Flyer | Advanced graphics and typography |
| | Chapter Six — A Three-Column-Newsletter | Advanced newsletter-style layout, captions, table of contents, calendar, |
| | Chapter Ten — Using the Professional Extension | Advanced typography |

On the other hand, if you plan to use Ventura for many different documents, try to finish Part Two from start to finish. Completing all ten chapters guarantees that you will understand Ventura's full range of features.

If you have installed the Professional Extension

If you have installed Ventura's Professional Extension, your screen will show several more dialog box options than the sample screens in this book. Do not be concerned if your screen looks slightly different. It will not effect your ability to complete the step-by-step instructions.

We suggest you master the basics in Chapters One through Nine before you tackle the advanced table editing and typographic features of the Professional Extension explained in Chapter Ten.

How each chapter is organized

Each chapter is divided into four sections: skills checklist, theory, tutorial, and tips. The skills checklist at the beginning gives you an overview of learning skills and key words. A glance at the list tells you what you will learn.

The theory section discusses the concepts and principles behind each chapter. Take the time to read the background information before you start the hands-on project. That way you will understand *why* you are making specific selections.

The tutorial section includes detailed instructions in bite-size, easy-to-follow steps. Usually, you can produce the desired result just by imitating the sample screens.

Finally, the tips section summarizes and expands on the techniques mentioned throughout the chapter. Some people like to skim through these tips before starting.

A note to instructors

If you are using *Publishing Power* for classroom instruction, you should know that each chapter has one or more stopping points. If you have time for extended sessions, ignore them and proceed straight through. However, if you want to pause

periodically, you will find clearly marked break points, with instructions on how to stop and resume.

Instructors may also want to assign advance reading. We suggest that students prepare by reading the theory section at the beginning and skimming the tips section at the end.

A final tip for instructors: If you want to focus on certain techniques, you can confine the classroom session to one portion of a chapter. Step through the project yourself up to the point at which you wish to begin. Save your work and distribute this partially completed chapter to students on floppy disks (or via network). Have the students load up the partially completed project at the beginning of the session. That way you and they can concentrate only on the specific skill you wish to present.

The ground rules

While we are explaining how to use this book, we should acquaint you with a few ground rules. The checklist that follows spells out six conditions. These are the assumptions that operate during the self-paced publishing projects. Before starting with Chapter One, make sure that your system matches all six.

WARNING: You may have difficulty recreating the examples if you do not meet all the assumptions explained below.

1. You are using Ventura 2 or higher. The sample projects in this book use Ventura 2 features. If you have installed the Professional Extension, your screen will include Table mode (in the Side-Bar) and several additional dialog box options. The slight variations you see between your screen and ours will not affect your ability to follow along.

The sample style sheets on the accompanying Publishing Power software disk *will not* work with version 1 or 1.1 Contact your local dealer or Xerox for upgrade information if you are working with the older version.

2. Ventura is located on drive C:. If you use a different letter for the hard disk containing Ventura, substitute that letter

whenever you see C:. Consider, for example, an exercise that asks you to move to the C:\POWER subdirectory. If your hard disk is D:, you would type D:\POWER instead.

3. You have the original Ventura examples intact on the C:\TYPESET subdirectory. If you have moved these style sheets or picture files, or if you have modified them in any way, copy the originals from the Ventura installation disk labelled "Examples." The command "**COPY A:&*.STY C:\TYPESET**" will copy all the style sheets you will need for this book. The commands "**COPY A:*.IMG C:\TYPESET**" and "**COPY A:*.GEM C:\TYPESET**" will copy all the picture files you will need for the book. You do not need to copy these files unless 1) you have erased the examples or 2) you answered "no" during installation when Ventura asked if you wanted to install the examples.

➔ *NOTE: If you have modified the example style sheets in any way, delete or move them from the \TYPESET subdirectory and recopy the originals from the installation disk.*

4. You have a Hercules-compatible graphics adapter. The sample screens in this book were created from a Hercules-compatible monitor. If you have a VGA, an EGA, a CGA, or a big-screen monitor instead, your display may look slightly different than the illustrations. This should not affect your ability to follow along.

5. You use a mouse. To gain the maximum productivity from Ventura we recommend a mouse. If you do not have a mouse, refer to the section "Operation without a mouse" in the Xerox Ventura Publisher Reference Guide.

6. (Optional) You have installed PostScript as one of your printer choices. Although you can follow along without installing a PostScript printer, a few of your dialog boxes will look slightly different from the examples. You may want to install PostScript as a second printer while you work through the projects. That way your screen will match our examples. You can quickly and easily install PostScript as a printer choice even if you do not own a PostScript printer and even if you have already installed Ventura. Simply reinstall the program. When it asks if this is the first time you are installing, answer No. Then select PostScript as one of your printer choices.

printer choices. When you load Ventura, select Set Printer Info from the Options menu and change to a PostScript printer. Before you print at the end of each chapter, switch back to your original printer.

Rules for Ventura prep

Each chapter contains a section called Ventura prep. This section explains the file management operations to create the sample document. These operations include loading and renaming text files, loading and renaming style sheets, loading graphics files, and saving chapters. What you do in this section depends on whether or not you own the Power disk.

The Power disk

The optional Power disk contains the sample text files from Appendix A, thereby saving you the trouble of typing them in yourself. In addition, it has style sheets and, in a few cases, sample chapters, for the advanced documents in Part Two. These samples give you a headstart. You can order the Power disk with the postage-free card at the back of the book, or by phoning New Riders's toll-free number.

If you own the Power disk

If you already own the Power disk, *go to Appendix C to learn how to install it on your hard disk*. During the tutorial, turn to the Ventura prep subsection marked with the disk icon:



If you do not own the Power disk

Appendix A gives a complete print out of all the text files and the style sheets used in the book. If you do not own the Power disk, turn to the subsection in Ventura prep displaying the no disk icon:



This section will tell you which text file and style sheet to copy from Appendix A.

The Ventura formula

One important task remains before you are ready for Chapter One: a brief explanation of the strategy that forms the foundation for this book. Every Ventura document, no matter how complex, is made up of just three parts: *text* (the words), a *style sheet* (the format), and *pictures* (the illustrations). Typically the text comes from word processing files and the pictures from graphics files, while the style sheets are created with Ventura Publisher. This formula helps explain how the software operates. It also becomes a good model for working with Ventura Publisher:

Text + Style + Pictures = Chapter

This formula illustrates not only the components, but also *the best order for building a document*. As we will show you, this simple idea is a powerful tool. It can serve as a blueprint for any document, long or short. Table 2 illustrates how the Formula will guide the construction of our projects.

Table 2. Using the Ventura Formula

| | |
|-----------------|---|
| Text | Load the text file(s) |
| Style | Load a style sheet |
| | Apply it to the text file |
| Pictures | Create the frame(s) for the picture(s) |
| | Load the graphics file(s) into the frame(s) |
| Chapter | Save the chapter |
| | Print the chapter |

As Ventura authors and consultants, we've talked with hundreds of users. Most have similar troubles. When confronted with the complexities of page design and the power of

Ventura, they don't know where to start. They flounder because they don't have a systematic approach. When they do get underway, they get lost among the menus. Or they forget key steps and have to redo the document. In short, they're often a bit confused.

It doesn't have to be that way. As you will see in the next three chapters, the Ventura Formula can rescue you from confusion. No matter how complex the project, you can always fall back on the Formula. As you grow proficient, you may decide to modify the Formula or abandon it entirely. As you are learning, however, it should be the foundation for everything you do. We have used it throughout this book.

Rather than belabor the theory, let's see it in practice by using the Formula to prepare a business report. Turn to Chapter One for your first hands-on Ventura project.

Chapter One Skills Checklist

Theory

- How Ventura manages files and builds chapters
- Renaming and relocating files with Ventura prep
- The Ventura user interface
- Multi-Chapter — a built-in copying function

Text

- Loading and placing text
- Renaming and relocating text

Style

- Loading a style sheet
- Renaming and relocating style sheets
- The Ventura Formula — easy rules for faster formatting
- The secret of the “Big Three” dialog boxes
- Why you should always start formatting with Body Text
- How to create a standard spacing unit

Picture

- Adding a frame
- Using padding to separate text from pictures
- Loading and placing a picture

Chapter

- Saving and printing
- How to back up Ventura chapters

Chapter One

A Single-Column Report

Ready to start putting Ventura through its paces? This first chapter provides a solid grounding in Ventura fundamentals. It also demonstrates how the Formula guides you step-by-step through a work session. The checklist to the left summarizes some of the skills you will acquire. You will find a similar list in every chapter.

A few preliminaries before we begin. All the projects in this book start with a before-and-after look at the document. In other words, we start by showing you where you are going. Then it's on to the sample project. In most cases, you can produce the results just by imitating the screens on the page. When you see an explanation followed by an illustration, simply make your dialog box match the one in the book.

That's all there is to it. Merely by following along, you will learn to handle Ventura like a pro.

Theory

We know you are eager to get started. Before you get behind the controls, however, you need to understand a few fundamentals. The hands-on practice will make more sense if you understand how Ventura manages files.

Parts of a chapter

Most other programs do all their work in one large file. By contrast, Ventura works with many different files. A master file, called the *chapter file*, stores *pointers* to other files, plus instructions on how to assemble these files onto the page. When you format on screen or print on paper, the chapter uses

instructions on how to assemble these files onto the page. When you format on screen or print on paper, the chapter uses

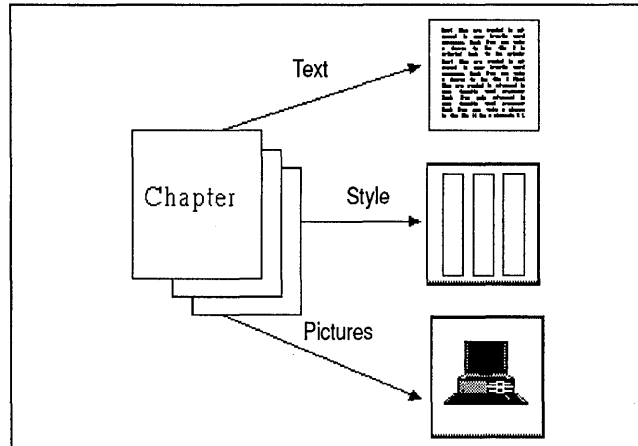

Figure 1-1. Ventura chapter files contain pointers that specify the location of the other component files.

its pointers to find the files it needs, and then uses its instructions to put the document together (Figure 1-1).

What kinds of files go into a document? The Ventura Formula provides the answer:

Text + Style + Pictures = Chapter

As Ventura builds a document, it creates additional files on its own if it needs them. For instance, if you put captions on the page, Ventura creates a separate caption file. If you use the drawing tools, Ventura opens a graphics file. When it opens these files, Ventura uses the same name as the chapter, but with a different extension. Thus, if the chapter is called SAMPLE.CHP, the caption file becomes SAMPLE.CAP and the graphics file SAMPLE.VGR. Table 1-1 gives a more in-depth look at the components of a typical Ventura chapter.

Renaming and relocating files

One more bit of theory about Ventura's file management and you will be ready to start the project. Ventura permits you to rename and/or relocate most of the files that make up a chapter. Ventura doesn't care where you store those files, as long as you tell it where to find them.

Table 1-1. Typical file names for a Ventura chapter

| File Type | File Name(s) | File Contents |
|-----------|--------------|---|
| TEXT | SAMPLE.TXT | Text file created with word processor and imported into Ventura (can be more than one) |
| | SAMPLE.CAP | Caption file created and named by Ventura to match the chapter name |
| STYLE | SAMPLE.STY | Style sheet with format instructions |
| PICTURE | PICTURE.IMG | Picture file created with outside graphics program and imported into Ventura (can be more than one) |
| | SAMPLE.VGR | Ventura graphics file for drawings created inside Ventura to match the chapter name |
| CHAPTER | SAMPLE.CHP | Chapter file containing pointers to all other files |
| | SAMPLE.CIF | Chapter information created and named by Ventura to match the chapter name |

In Ventura's eyes, the location of a file is part of its name. The four files below *are completely different* as far as Ventura is concerned:

```
A:\SAMPLE.TXT
C:\SAMPLE.TXT
C:\TEMP\SAMPLE.TXT
C:\POWER\SAMPLE.TXT
```

Renaming and relocating are accomplished in the same fashion (in fact, we use the word *rename* to mean either function). Although the procedure is slightly different for different files, the principle is the same. By entering a new name and/or a new location, you tell Ventura where to find it in the future.

- You make a copy of the file under the new name at the new location (you will have to delete the old one if you don't want it anymore).
- You change the pointers in the chapter file. From then on, Ventura looks for that file under the new name in the new location (Figure 1-2).

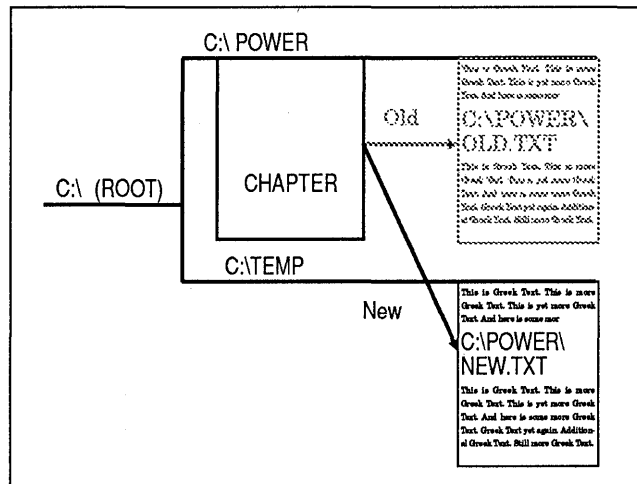

Figure 1-2. When you save and rename a file, you change the pointers in the chapter file. From then on, Ventura looks for that file under the new location.

WARNING: Do not use standard DOS functions to move Ventura chapters. Use Ventura's Multi-Chapter function instead, as taught at the end of this chapter.

DOS is able to copy files, but it does not change the pointers inside the chapter file. If you reopen the chapter at the new location, Ventura will be unable to reassemble the document. It will look for the files in their old locations, because the pointers were never changed.

By contrast, Ventura's built-in copying function not only moves the files, but changes the pointers as well. In addition, it moves all the files at once. By telling Ventura to copy a chapter, you are telling it to copy not only the chapter file, but also every other file associated with that document. You do not have to specify the individual files. Ventura remembers them for you, finds them on the disk and copies them to their new

location. This copying function is located in the Multi-Chapter dialog box.

↳ *TIP: Even though the name Multi-Chapter implies that it is intended only for multiple chapters, you can also use Multi-Chapter to copy a single chapter. You will have several opportunities for hands-on practice with Multi-Chapter in both Part One and Part Two.*

So much for your first exposure to the principles behind Ventura Publisher. You will need to learn additional theory before you're ready to strike out on your own. In the meantime, however, we suggest concentrating on the project that follows without worrying too much about the wherefores and whys. We will present more fundamentals in Chapters Two and Three.

Before

Report on Installation and Implementation of Ventura Publisher

Executive Summary

XYZ Corporation has embarked on a program to implement Ventura Publisher software on existing IBM AT-compatible computers as needed throughout the company. The Marketing Communications department will oversee and supervise this project. Marketing Communications makes the following recommendations:

- Use of Ventura in every department for all publishing/communications tasks
- Designation of an in-house desktop publishing specialist with responsibility for training, maintenance and standards
- A company-wide training program to teach basic Ventura skills
- Advanced workshops as needed to teach specialized skills

Use of Ventura Company-Wide

The three-month pilot program undertaken by Marketing Communications has determined that Ventura Publisher can be used for every type of document currently produced by the company. Company-wide use of Ventura will reduce publishing/printing costs by 35% over the next two years (see chart next page). It will reduce the confusion and duplication of effort now in evidence, whereby every department had developed different (and often incompatible) solutions to publishing problems. It will also permit the company to establish and enforce appearance and image standards. Since Ventura Publisher uses style sheets to store formatting information, the company can create a library of approved designs and code them into style sheets. Every document produced with these style sheets will automatically meet minimum standards for graphic design and quality; and all documents seen by the public will reinforce the same image.

We have identified potential uses in five departments; more will be developed as users become more proficient with Ventura and discover new applications.

Accounting Department:

Creation and maintenance of electronic forms, including purchase orders, invoices, collection notices, plus formatting of financial statements and reports.

Advertising Department:

In-house creation of direct mail flyers, brochures and, resulting in improved turnaround time and reduced fees from outside agencies and service bureaus.

Marketing Communications:

Company newsletters, both internal and those intended for customers, plus brochures and product specification sheets.

After

Report on Installation and Implementation of Ventura Publisher

Executive Summary

XYZ Corporation has embarked on a program to implement Ventura Publisher software on existing IBM AT-compatible computers as needed throughout the company. The Marketing Communications department will oversee and supervise this project. Marketing Communications makes the following recommendations:

- Use of Ventura in every department for all publishing/communications tasks
- Designation of an in-house desktop publishing specialist with responsibility for training, maintenance and standards
- A company-wide training program to teach basic Ventura skills
- Advanced workshops as needed to teach specialized skills

Use of Ventura Company-Wide

The three-month pilot program undertaken by Marketing Communications has determined that Ventura Publisher can be used for every type of document currently produced by the company. Company-wide use of Ventura will reduce publishing/printing costs by 35% over the next two years (see chart next page). It will reduce the confusion and duplication of effort now in evidence, whereby every department had developed different (and often incompatible) solutions to publishing problems. It will also permit the company to establish and enforce appearance and image standards. Since Ventura Pub-

Planning the report

The first step in producing a business document is to consider its purpose and audience. Your goal is two-fold: (1) to make the appearance appropriate to the readership and (2) to make the document easier and more efficient to use. Ventura's vast array of capabilities can help you achieve both goals.

Our first project is a business report. We use the word "report" to refer to a simple, straightforward document, usually intended for internal use (as opposed to proposals and annual reports, which often go outside the company). Target readers are other members of the company, usually at your own level or higher. Since reports often summarize difficult or dull information, they must use page design to make that information easily accessible. They should include charts, graphs, and other illustrations when possible, to help get the message across.

Because a report is an internal document, it does not demand high-end, cutting-edge graphic effects. At the same time, because most reports go up the ladder to management, they need a professional image: clean, simple and uncluttered without being loud or flashy. Look at the "before" example of the report. It is a typical report from the days before desktop publishing. Here are a few ways to enhance its effectiveness and appearance:

- An easy-to-read line length
- Bullets to make lists stand out
- A header and page numbers to help readers find their way around
- Prominent headlines and subheads
- Spacing based on a uniform, standard unit
- Additional white space for an open look

You will implement these ideas in this project.

Before you start

We assume that you are sitting in front of your computer with Ventura Publisher on the screen. If you have not already powered up Ventura, type: **VP** at the DOS prompt (**VPPROF** if you are using the Professional Extension).



If you have the Power disk

If you are using the optional Power disk, you should have installed it already following the instructions in Appendix C. If not, stop and do so now.



If you do not have the Power disk

You do not need to do anything special yet. Read on.

If you just started Ventura, the screen will be empty. If not, and there is a previous document active, select New from the File menu to clear the screen. Do not worry about what file names appear at the top of the screen. You will be changing the files you use anyway.

The Ventura user interface

Your screen should look similar to Figure 1-3. If it does not, select the View menu and Reduced View. If you are new to Ventura, take a moment to familiarize yourself with the key features of the Ventura user interface as shown in Figure 1-3.

The Menus at the top of the screen drop down when you point to a name with the mouse cursor. Move the cursor over the menu you want until it is displayed in reverse video (white on black). Then click the left button on your mouse to select an option. Menu options displayed in gray are not available for selection.

The Title Bar displays the current chapter and style sheet. As you step through the projects in this book, check to make sure the names of the chapter and style sheet in the Title Bar match the ones we show in the sample screens.

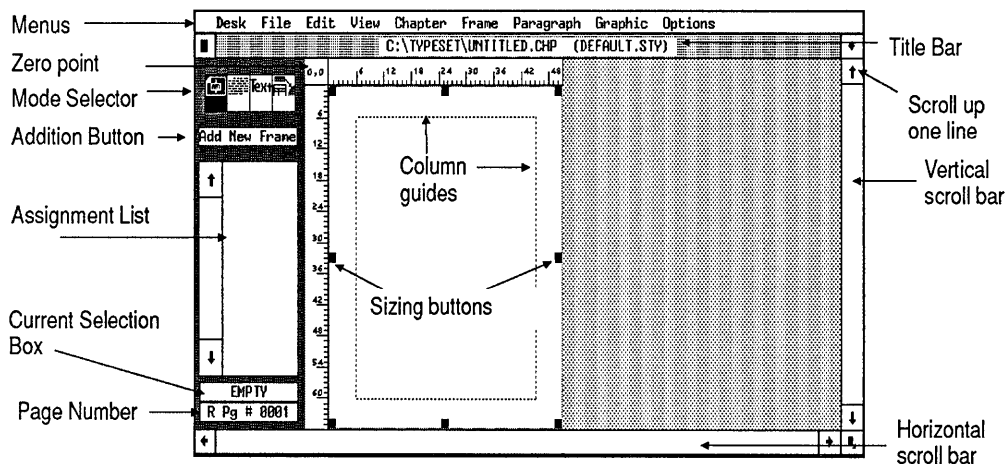

Figure 1-3. The Ventura interface.

The Mode Selector shows four pictures at the top of the Side-Bar. Each picture represents one of the four major modes in Ventura: (from left to right) Frame, Paragraph, Text, and Graphic mode. In Figure 1-3, Frame mode is enabled. Each mode allows you to perform a group of related tasks:

- Frame mode lets you create new frames on the page and place text and pictures inside. You can also cut, copy, paste, or delete frames.
- Paragraph mode lets you define, change, and apply a set of formatting rules, called tags, to individual paragraphs.
- Text mode lets you add or delete text on-screen, as well as change its font and attributes (for example, bold or italic).
- Graphic mode lets you add, delete, copy, size, or paste graphic lines, rectangles, circles, and Box Text (text inside a box).

The Addition Button lets you add a frame, tag, or text attribute, depending on which mode is enabled. Click on the Addition Button to choose the action (or function) specified in the Addition Button.

The Assignment List displays an alphabetical listing of items that you can choose for Frame, Paragraph, and Text mode. (In the Professional Extension, items are listed for Table mode.)

The Current Selection Box shows the name of the selected file, tag, graphic, or text attribute.

The Page Number shows the number and side (Right or Left) of the page.

The Sizing Buttons (also known as “handles”) show the frame that is currently selected.

The Column Guides display the borders of the columns. You can turn them on or off. They do not print out.

The Page (referred to as the Underlying Page in earlier versions of Ventura) is the blank frame that appears when you first start Ventura or when you select New from the File menu. You define the size and orientation of the Page in the Page Size & Layout dialog box from the Chapter menu. You can place text and pictures directly onto the Page, or you can put text and pictures into frames on top of the Page.

➔ **NOTE:** If you are using the Professional Extension, you have a fifth mode called Table mode. See Chapter Ten.

The other key feature of Ventura’s user interface is the dialog box. Let’s take a moment to review the major controls inside (Figure 1-4).

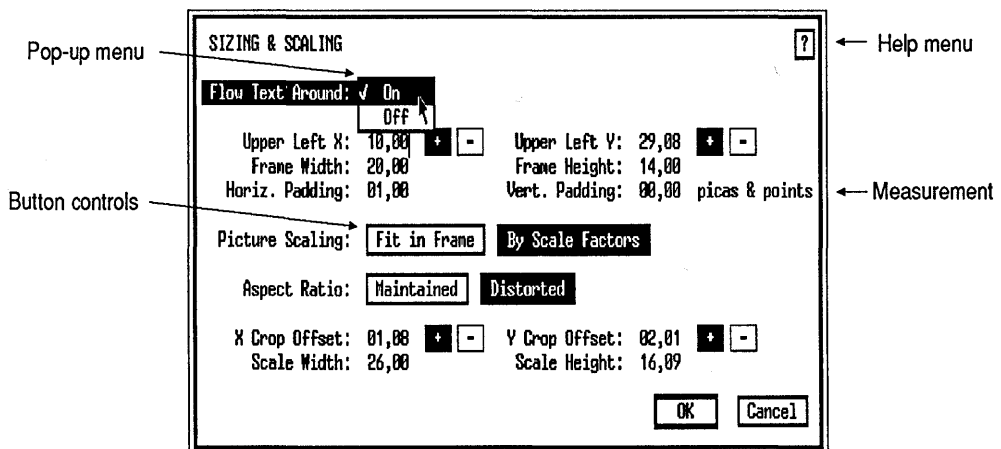

Figure 1-4.

Pop-Up menus appear when you place the cursor over an option followed by the double up-down arrow symbol. The pop-up menus show you all possible choices available for one option. To make your choice, place the cursor on the arrow symbol and click the left mouse button. Now hold down the button and drag the cursor up or down until you highlight the option you want, then release.

➡ *NOTE: For easier viewing, we've chosen to hide the up-down arrows in all our illustrations.*

Help menus are included in each dialog box. To get on-line help, click on the question mark inside the square and follow the prompts.

At any point you can cancel a dialog box choice by pressing Ctrl-X. To save your choices in a dialog box, press the Enter key or click the OK button. You'll get plenty of practice using dialog boxes as soon as you begin the tutorial section.

Our starting configuration

Ventura Publisher is easier to work with if you use the Options menu to make the selections shown in Table 1–2. There's nothing that says you can't configure Ventura differently. However, our experience has shown that these settings make page design easier and more accurate.

As you progress, you may decide to use other settings that you find more suitable to your own working style. In the beginning, however, we suggest that you follow these suggestions. Otherwise, your display and your results may differ slightly from ours, making it more difficult to follow along.

Take a moment now to make sure all your settings in the Options menu match those shown in Table 1–2. Select the Options menu and choose each option in turn.

Table 1-2 Suggested settings for use with this book

| Option | Setting | What It Does |
|--------------------------------|--|---|
| Set Preferences | Generated Tags: Shown | Displays tags created by Ventura at the bottom of the Assignment List |
| | Text to Greek: 6 | Speeds screen redraw by showing unreadably small text as blocks |
| | Keep Backup Files: Yes | Ventura automatically makes a backup copy of all related chapter files each time you save |
| | On-Screen Kerning: None | Speeds up screen drawing by eliminating screen kerning |
| | Auto-Adjustments:None | Does not automatically adjust the inter-line spacing when you change the font size |
| | Pop-Up Menu Symbols: Shown | Displays arrow symbol next to choices that offer pop-up menus in dialog boxes |
| Set Ruler | Horizontal and Vertical Units: Picas | Displays ruler in picas to match the units we use in this book |
| | Horizontal Zero Point: 00,00 picas Vertical Zero Point: 00,00 picas | Sets the zero point at the upper left corner of the Page |
| Set Printer Info | Device Name: PostScript | (Optional) Can be used even if you do not have a PostScript printer so font dialog boxes match those in the book |
| | Width Table: \\VENTURA\OUTPUT.WID | Uses the default width table so style sheet can be interchanged between systems with different printers |
| Show Side-Bar | Menu reads "Hide Side-Bar" | Displays Side-Bar on left side of screen |
| Show Rulers | Menu reads "Hide Rulers" | Displays rulers on top and left side of the Page |
| Show Column Guides | Menu reads "Hide Column Guides" | Displays lines to show the boundaries of the columns. Makes it easier to line up frames on the Page |
| Show Tabs & Returns | Menu reads "Hide Tabs & Returns" | Displays on-screen the visible marks in the text denoting tags, returns, line breaks, footnotes, etc. Makes text editing easier |
| Turn Column Snap On | Display reads "Turn Column Snap Off" | Forces frames to align with the edges of the column |
| Turn Line Snap On | Display reads "Turn Line Snap Off" | Forces the frame to align vertically with the inter-line spacing of Body Text |

When you are finished, check that your settings in the Set Preferences dialog box and in the Options menu match ours in Figure 1-5 and Figure 1-6:

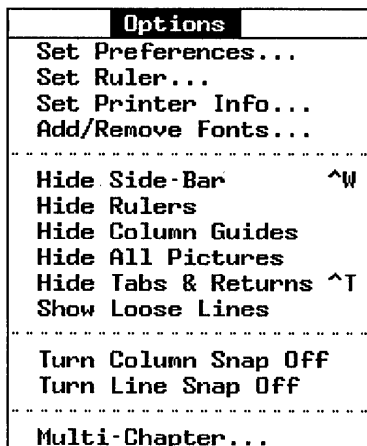

Figure 1-5.

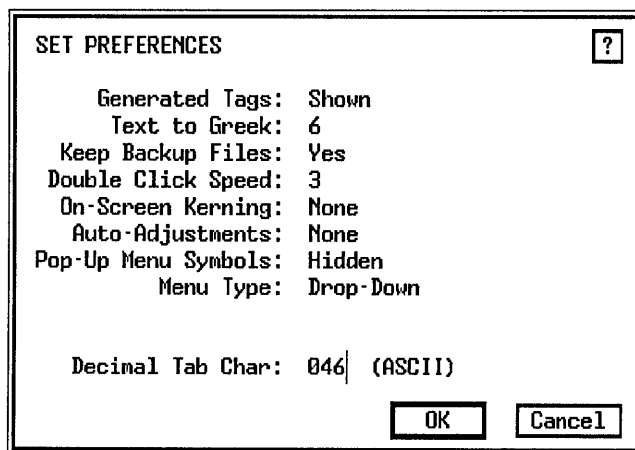

Figure 1-6.

If you cannot duplicate the results in a project, check to see that you are configured as shown in Figure 1-5 and Figure 1-6.

➡ **NOTE:** You will learn more about these settings as you work through the projects in the book.

Step one — file maintenance

If you don't tell Ventura where to put a file, it defaults to the location used last. The original default location is the C:\TYPESET subdirectory. Many beginners continue to store all their files in that one single directory. It soon becomes too crowded.

If you installed the optional Power disk for this book, you created a subdirectory called C:\POWER. This subdirectory stores sample documents and style sheets — the starting points for your documents. As part of this first project, you will create a subdirectory to store the results. From now on, you will always place your documents into this new subdirectory. Although you can create subdirectories in DOS, you can also do so within Ventura. Let's try it right now. Follow the step-by-step instructions below at your computer to create a subdirectory called C:\TEMP.

- Select DOS File Ops from the File menu.

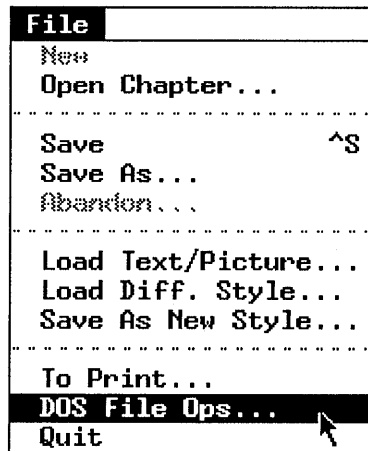

- Move the cursor to the File Spec line and click once. Then press the Esc key to clear the line. Type: **C:\TEMP**
- Choose Make Directory and Done.

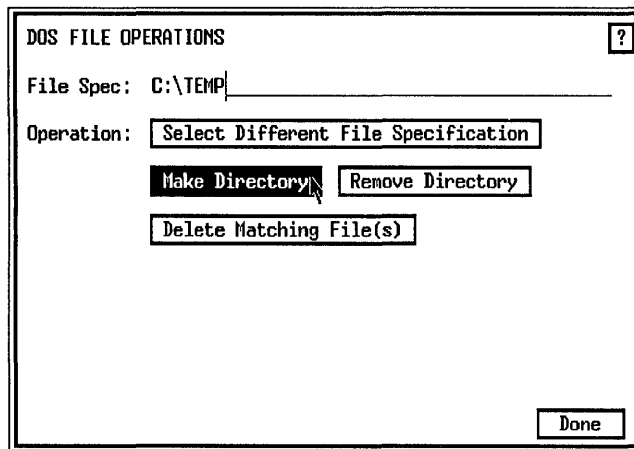

If you already have a C:\TEMP subdirectory, choose another name. In future chapters, substitute that name whenever you see C:\TEMP.

➔ *TIP: The best way to organize the hard disk is to create a separate subdirectory for each project, and use it to store all the files for that project — text, style, pictures, and chapter.*

Ventura prep

File management is one of the most difficult aspects of desktop publishing. Novice users sometimes encounter problems:

- They can't find files when it comes time to load them into Ventura
- They use the DOS copy command improperly and cannot get the chapter to load
- They make permanent, unwanted changes to original text files
- They destroy new versions by copying the old one on top
- They forget to save and thereby lose their work

To avoid such problems, you will start every project with a

Ventura prep section. You will load, rename, relocate, and save all the files for the exercise *before* you begin working. After you practice this file maintenance a few times, we hope it will become a habit.

By taking these steps at the beginning of every document, you can avoid losing work. In addition, you can easily take a break. Because all the files you will need are already loaded and renamed, all you have to do is save the chapter and quit. When you are ready to resume, you simply load Ventura, open the chapter and start where you left off.

WARNING: Renaming and relocating files does not take effect until you save the chapter. If you quit without saving, you lose the benefit of the Ventura prep process.

You will step through the Ventura prep section in the same order as the Ventura Formula: text, style, pictures, chapter. If you are used to working with DOS, it may take you a few times before you are comfortable with Ventura's methods. Although you can type in paths and file names, as in DOS, it is usually faster to navigate with the mouse.

We will step you through the Ventura prep process the first few times until it becomes second nature. It may seem lengthy at first, but with experience you can perform the entire process in a few moments.



If you have the Power disk

Follow the steps outlined below to load, place and rename a text file called 1RPRT.TXT. This text file is provided on the optional Power disk. If you did not purchase the disk, skip to the section below titled "If you do not have the Power disk."

When you load text, Ventura retrieves the original word processing file. It does not make a separate copy. It temporarily places hyphens in this file, then makes it a permanent part of the chapter by storing a pointer. This pointer tells Ventura where to find the text file the next time the chapter is loaded.

■ Select Load Text/Picture from the File menu.

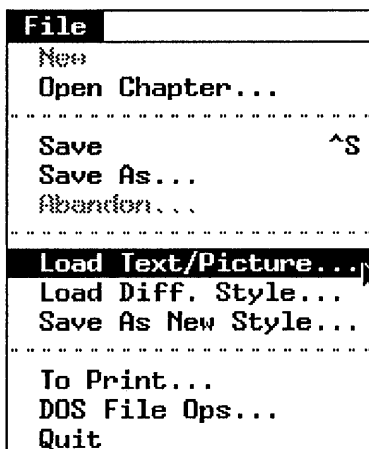

- Choose Type of File: Text, Text Format: ASCII, # of Files: One, Destination: List of Files, and OK.

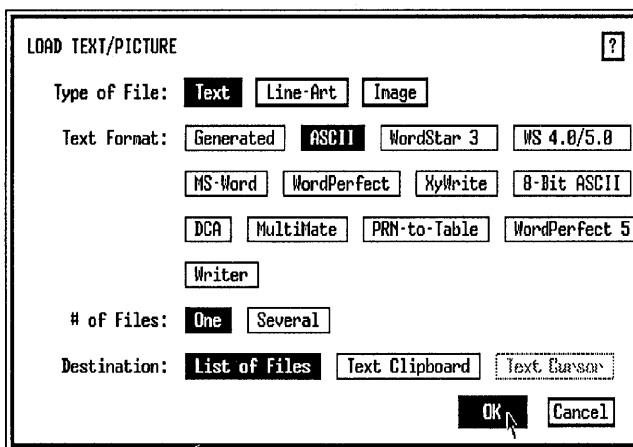

The Item Selector dialog box appears. Its listing shows both file names and subdirectories. Subdirectories are distinguished by a diamond in front of the name.

In the next section, you will practice moving around the hard disk with the mouse. To move “backward,” you click on the Backup button in the upper lefthand corner of the listing box. To move “forward” to a given subdirectory, click on the diamond that precedes its name, or the subdirectory name itself (Figure 1-7).

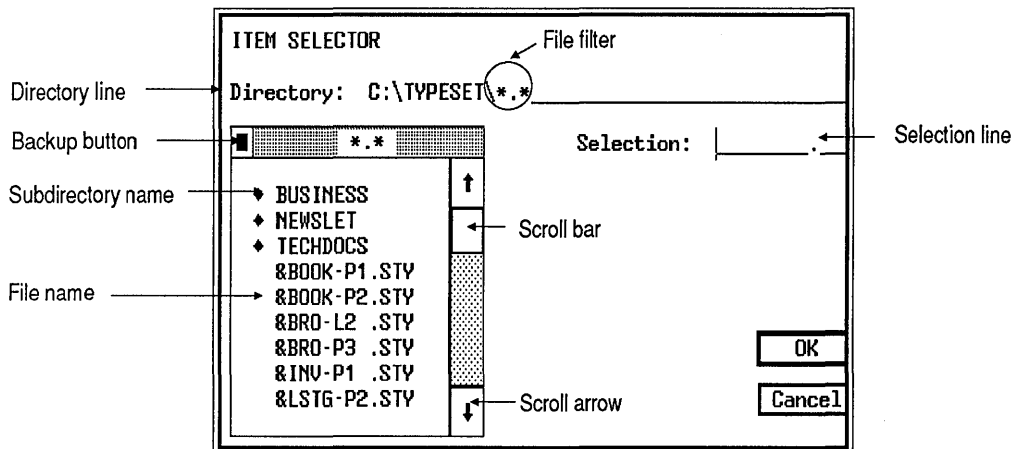

Figure1-7. The Item Selector lets you locate any file on your hard disk. Use the Backup button to move to the next higher level of subdirectories. Open a subdirectory by clicking on the diamond or the subdirectory name.

To move to a new subdirectory, click on its name:

- Click on the Backup button until the C:\POWER subdirectory appears on the list (preceded by a diamond). Click once on the diamond or the name to move to that subdirectory. The Directory line now reads C:\POWER*.TXT.

To find the file you need, click on the scroll arrows to move down or up one line at a time. Click on the gray area to move one screen at a time. To move a distance you select, press and hold the mouse button to drag the scroll box in the direction you want to move.

- Use the scroll box and arrow to scroll through the list of text files until you see 1RPRT.TXT.
- Select the file 1RPRT.TXT by clicking once on 1RPRT.TXT and once on OK.

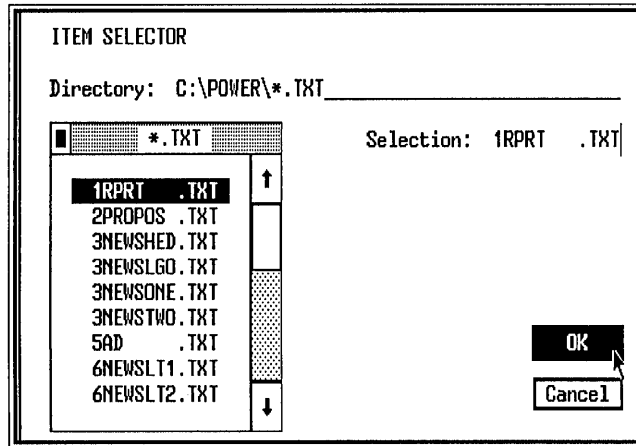

➔ *NOTE: Once you click on a file, its name appears on the Selection line. You can also select a text file by typing the name directly onto the Selection line and clicking OK or pressing the Enter key, or by double-clicking on the file.*

Ventura loads the file and the name 1RPRT.TXT appears in the Assignment List. If the Underlying Page is selected when you load a text file, Ventura automatically places the file on the Page.

➔ *NOTE: If you are in Paragraph, Text, or Graphic mode when you load a file, Ventura will not place the file on the Page.*



If you do not have the Power disk

To follow along, you will exit Ventura and load a word processor. You will type the text 1RPRT.TXT from Appendix A and save it in ASCII file format under the name and location C:\POWER\1RPRT.TXT. Then you will return to Ventura and follow the steps in the section above for loading the text file.

Place the text file

After you load a text file you must place it — that is, tell Ventura where you want it to appear. You can place text onto

the Page, or into separate frames on top of the Page. For this business report, you will place the text onto the Page.

➔ *NOTE: Ventura may have already put the file on the Page without your intervention. If you select an empty frame or a Page before loading a single file, Ventura assumes that you want the file in that location, and places it without being asked. If Ventura placed the file for you, read through the following section without doing anything.*

Select the Page

- Enable Frame mode by clicking on the Frame button in the Mode Selector.

- Select the Page by clicking once anywhere on the Page.

Notice the eight black handles, known as *sizing buttons*, around the border of the Page. They show you what has been selected and where Ventura is going to place the text.

- Click once on the file name 1RPRT.TXT in the Assignment List to place the file onto the Page.

The text fills the Page. The text file name is displayed in the Current Selection Box (Figure 1-8).

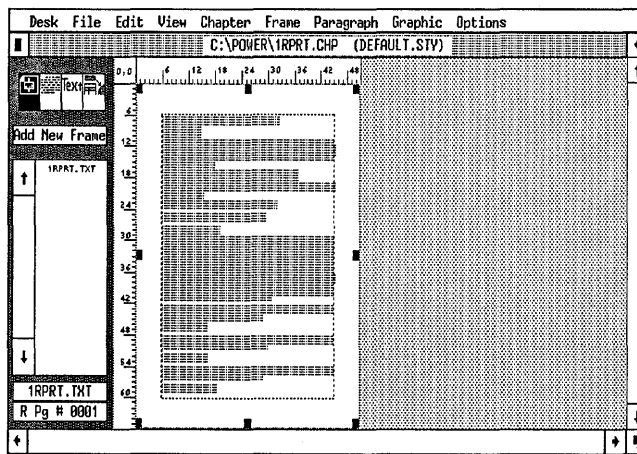

Figure 1-8.

Don't worry if your screen differs slightly from the example shown here. You may have started the project with something other than the DEFAULT.STY style sheet. That other style sheet may have different margins and columns. You will soon load a different style sheet.

Because you placed the file on the Page, Ventura continues to make new pages until the entire file is placed. If you were to press the PgDn key to move ahead in the document, you would find the additional pages already created.

Rename the text file

Once the file is on the Page you can change its name and/or its location. When you make changes to text they are reflected back to the original file. *If you do not want the original to be permanently modified, you must rename it before you save the chapter.*

- Select File Type/Rename from the Edit menu.

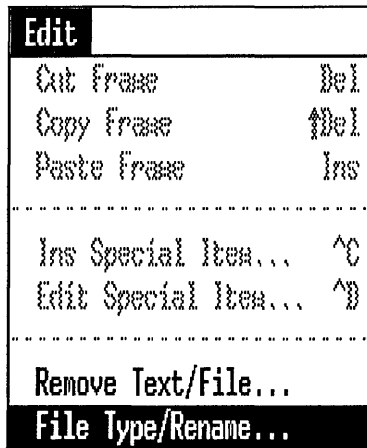

- Move to the New Name line and press Esc to clear the line. Then type in the new location and name:
C:\TEMP\1REPORT.TXT
- Click on ASCII and OK to close the dialog box.

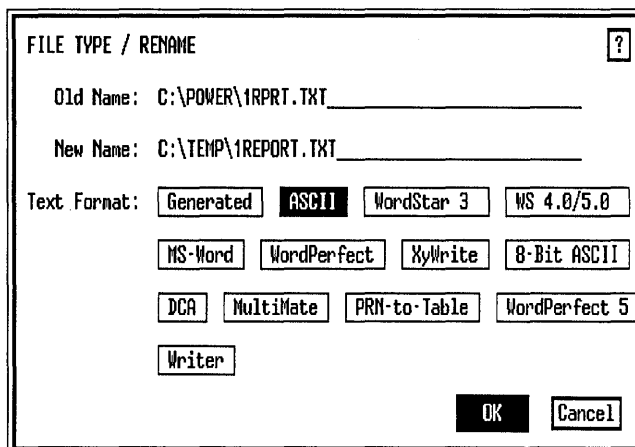

WARNING: If you did not make a C:\TEMP subdirectory, Ventura will not know where to relocate this file. Go back to the section "Step one — file maintenance" to learn how to make the C:\TEMP subdirectory.

➔ *TIP: You can correct typing mistakes by pressing the Backspace key to delete one character to the left, or the Del key to delete one character to the right. Use the Esc key to clear the line.*

If you prefer, you can save the file in your favorite word processing format instead. Follow the steps above and choose the text format you want rather than ASCII.

Load a style sheet

To continue the Ventura prep, you will load one of the original style sheets included with the Ventura software package.

WARNING: If you have moved or changed the style sheets in any way since buying Ventura, reload the originals as explained in the Introduction to this book.

■ Select Load Diff. Style from the File menu.

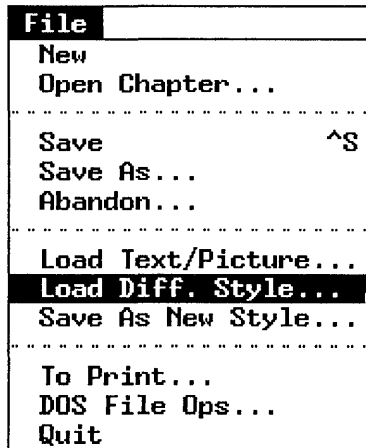

- Use the Backup button to find the C:\TYPESET subdirectory. The Directory line reads C:\TYPESET*.STY. Now select the style sheet &PRPT-P1.STY and click OK.

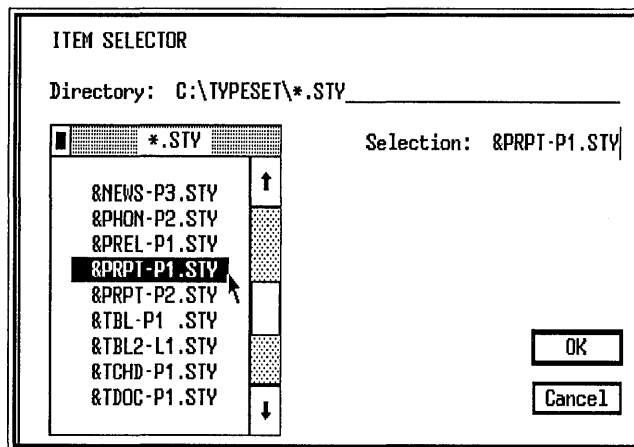

If you cannot find the style sheet, check that you are in the correct subdirectory. Scroll down the listing until &PRPT-P1.STY appears.

- NOTE:** You can move from subdirectory to subdirectory either by clicking on the Backup button and the diamonds, or by typing the desired subdirectory onto the Directory line and pressing Enter.

Rename the style sheet

If you save a chapter without renaming the style sheet, you will permanently change the original. It's better to leave the original intact for future use, and rename the new version.

- Select Save as New Style from the File menu.

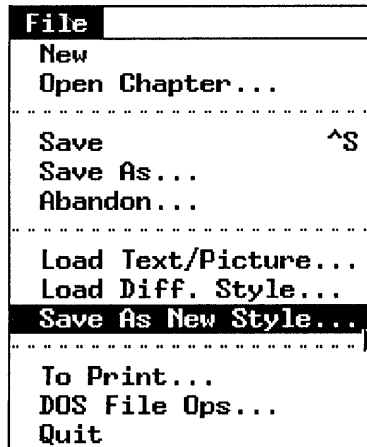

- Move the cursor to the Directory line, press Esc and type: `C:\TEMP*.STY` and press Enter.

The Item Selector searches the `C:\TEMP` subdirectory for files with the `.STY` extension. Because you haven't put any here yet, the list is blank.

- Move to the Selection line and type: `1REPORT` and click OK. Ventura stores the style sheet as `C:\TEMP\1REPORT.STY` (Figure 1-9).

➡ *TIP: Ventura automatically assigns a `.STY` extension to style sheets and `.CHP` extensions to chapter files. You do not need to type them in.*

The new style sheet name appears in the Title Bar at the top of the screen.

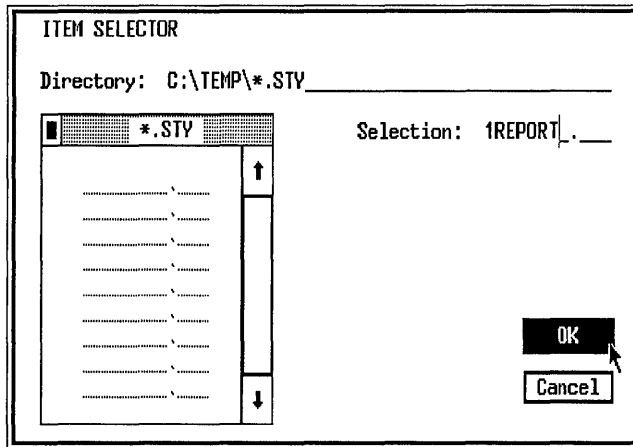
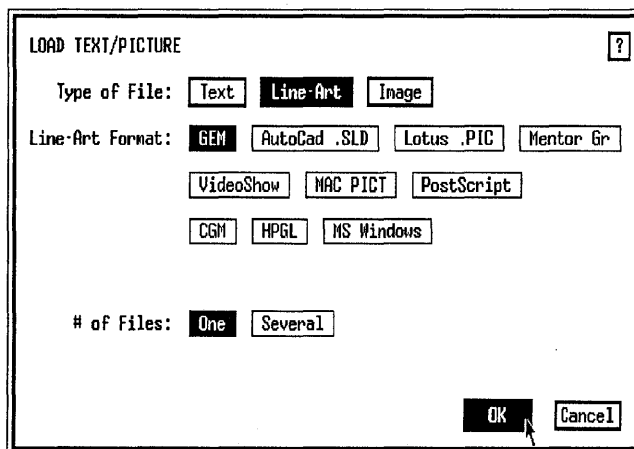

Figure 1-9.

Load a picture file

Loading pictures is very similar to loading text. In fact, you use the same option from the File menu: Load Text/Picture. As with text, you first load the file onto the Assignment List and then place it where you want it.

- Select Load Text/Picture from the File menu.
- Select Type of File: Line-Art, Line-Art Format: GEM, # of Files: One, and OK.



Ventura displays the Item Selector, which you will use to choose a picture file to load.

- If you are not already in the C:\TYPESET subdirectory, click the Backup button until C:\TYPESET shows on the list (preceded by a diamond). Click once on the name to move to that subdirectory. The Directory line now reads C:\TYPESET*.GEM.
- Scroll down until you see NOZZLE.GEM.
- Select NOZZLE.GEM and click OK (Figure 1-10).

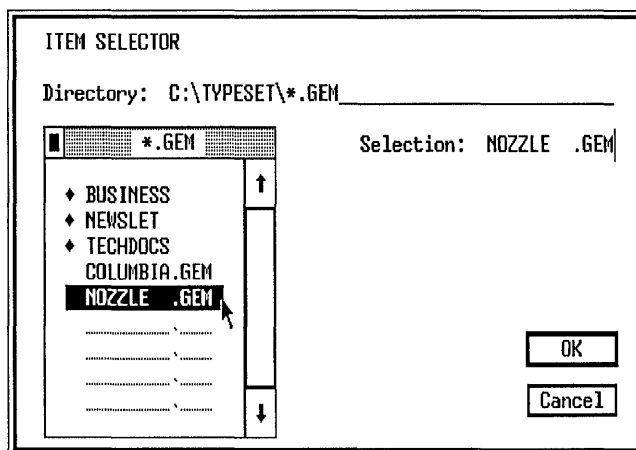

Figure 1-10. Selecting NOZZLE.GEM from the Item Selector.

Ventura loads the file. The name NOZZLE.GEM appears in the Assignment List. Do not place the picture for the moment. Later in this chapter you will draw a frame and place this picture inside it.

➔ **NOTE:** Although you can rename text files and style sheets with Ventura, you cannot rename picture files. You must exit Ventura and use the DOS Rename command to rename a picture file or use a third-party utility like Desktop Manager.

Save the chapter

When you save a chapter for the first time, use Save As from the File menu to specify the new name and location.

- Select Save As from the File menu.

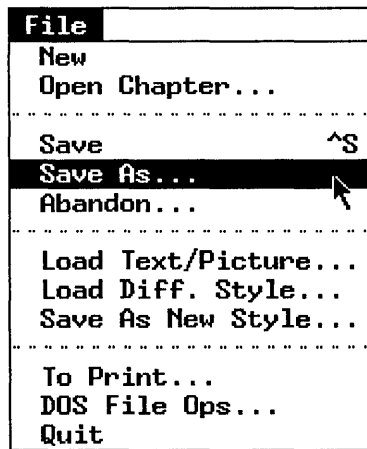

- Move the cursor to the Directory line and press Esc. Type in the new location **C:\TEMP*.CHP** and press Enter or click OK to move to that subdirectory.
- Move to the Selection line and type in the name: **1REPORT** and click OK.

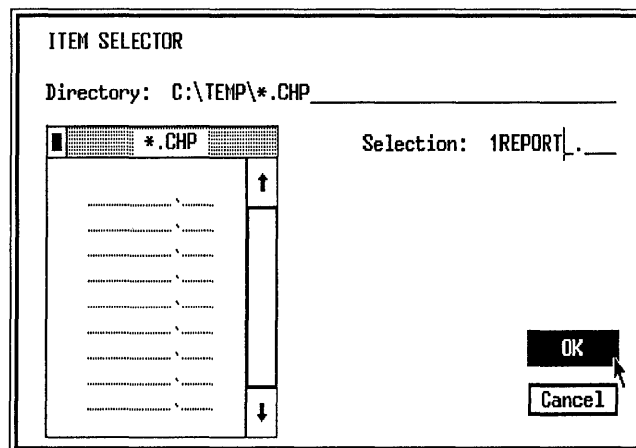

- ➔ **NOTE:** If you lose a chapter through a computer malfunction, you may be able to restore it from the backup files.

Ventura maintains backups of all key files, provided you choose Keep Backup Files: Yes from the Set Preferences dialog

box in the Options menu. Each time you save a chapter Ventura renames the backup files with a \$ extension. Thus the backup filename for SAMPLE.CHP is SAMPLE.\$HP.

The backups represent files as they were the last time you saved the chapter. To restore the backups, you must return to DOS. Delete the original files. Then rename the backups to their original names. Thus, you would rename SAMPLE.\$HP to SAMPLE.CHP. SAMPLE.\$TY would become SAMPLE.STY, etc. Be sure you delete and rename all the chapter files, including those with the extensions CHP, STY, VGR, CAP, and CIF files.



Stopping point

You have reached the first of our recommended breaking points for Chapter One. Before you do anything else, save what you have done so far.

■ Press Ctrl-S (or Select Save from the File menu).

At this point you can stop and shut down the computer if you do not have time to continue. To restart, load Ventura and open the sample chapter, C:\TEMP\1REPORT.CHP. If you have the time, you should simply go straight to the next section without stopping.

Even if you plan to continue on without stopping, we recommend that you save your work to prevent loss in the event of a power surge or computer malfunction.

Text

Even though you haven't yet started to work on the actual document, you have already acquired a collection of valuable Ventura skills. Most Ventura users learn about file maintenance the hard way — by accidentally destroying or losing some of their work. The Ventura prep section you just completed is the key to avoiding such disasters.

What to do if you make a mistake

If you've never made a mistake and don't ever plan to, you can skip this next section. Otherwise, you may want to know what to do in the event of a major error. If you goof and can't recover, you can always choose **Abandon** from the **File** menu. **Abandon** reverts to the previous version — that is, it goes back to where you were the last time you saved the file. For this reason, you may want to save fairly often. If you make a serious mistake, it may be simpler just to go back to the previous version with the **Abandon** option.

Now you are going to step through the construction of the sample document. In case you don't have time to finish the entire project in one session, we will suggest another stopping point about halfway through.

The normal progression through a Ventura document follows the Formula: **Text + Style + Pictures = Chapter**. You already have a head start on the text portion, since you loaded and placed a text file during Ventura prep. Normally you would do some text editing at this stage. However, to prevent this first project from dragging on too long, we will postpone teaching you about text editing until the next chapter. Instead, you will take a quick look at moving around and viewing the Page.

Move around the page

Before proceeding to the style section of this sample project, take a moment to practice getting around. To move a few lines at a time, click on the arrows at the ends of the scroll bars at the far right of the screen. To move one screen at a time, click on the gray area. To move a distance you determine, drag the scroll bar (click and move while holding the mouse button down).

To move to the next page, use the **PgDn** key on the numeric keypad. Use the **PgUp** key to move to the previous page. Press the **Home** key to move to the first page of a chapter and the **End** key to move to the last.

WARNING: If the keys on the numeric keypad do not work, it's likely that you accidentally enabled keyboard mode. You can turn it off by pressing the Ctrl and the right Shift key (you will hear a beep).

View the page

Ventura provides four views of the page. You will experiment with three of them in this exercise.

- Use the View menu to cycle between Enlarged, Normal, and Reduced Views (Figure 1–11).

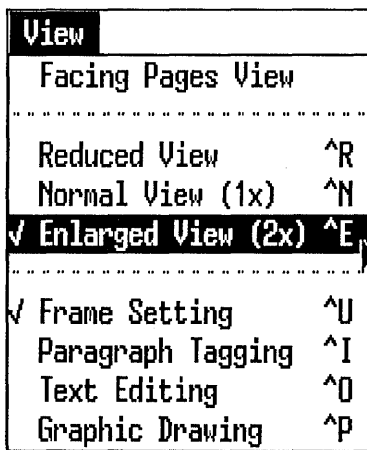

Figure 1–11. To zoom in, press Ctrl-E or select Enlarged View from the View menu.

You can also use keyboard shortcuts to cycle between different views. Press Ctrl-E, Ctrl-N, and Ctrl-R to change from Enlarged to Normal to Reduced View.

➡ *TIP: To zoom into a selected area, place the mouse cursor where you want the upper left corner of the magnified view. Then press Ctrl-E (or Ctrl-N).*

Style

In accordance with the Formula (Text + Style + Pictures = Chapter), the next section is concerned with style. More

specifically, you will load an existing style sheet and modify some of its tags.

A style sheet contains formatting rules. Some apply to the overall Chapter — margins, columns, vertical rules, and so forth. Others, called tags, apply to individual text elements. Style sheets are the key to Ventura's power. In fact, they are so powerful and so sophisticated they can intimidate a beginning user. Ventura has so many options you may have trouble knowing where to begin or remembering where you've been already. Fortunately, there are several easy ways to make sense of style sheets.

Rules of thumb

Three rules of thumb can help keep you from becoming disorganized and forgetting important steps.

➡ *TIP: Concentrate on three key menus during the style phase: Chapter, Frame, and Paragraph.*

➡ *TIP: Format the overall chapter before the individual text paragraphs.*

➡ *TIP: Work from left to right (from Chapter to Frame to Paragraph) and from top to bottom (from Font to Alignment to Spacing, etc.) in the menus.*

These three suggestions are guidelines only. You will find occasional exceptions to these rules as you work through the publishing projects. Nevertheless, they work well together. Most chapter formatting occurs in the Chapter and Frame menus. Most of the individual text formatting occurs in the Paragraph menu. Thus, if you move from left to right (Chapter to Frame to Paragraph), you automatically perform chapter functions first.

When we say to work from top to bottom, we do not mean that you must open each and every dialog box in a given menu. In the very beginning you may indeed want to do so, as a way of learning your way around. As you grow more accomplished, you'll soon know which menu options to ignore. But even if you skip menu options along the way, it's best to work from the

top to the bottom of the menu. If you work randomly you're likely to overlook an important menu choice.

You will follow these rules of thumb while in the style section of this first document. You will concentrate on the Chapter, Frame, and Paragraph menus. You will start with the design choices that affect the entire document — margins, columns, headers, footers, and so on. These layout decisions are applied to all the pages of the chapter.

You will begin with the first option in the Chapter menu.

Open the Page Size & Layout dialog box

- Select Page Size & Layout from the Chapter menu.
- Choose Orientation: Portrait, Paper Type & Dimension: Letter, Sides: Single, Start On: Right Side. Click OK to close the dialog box.

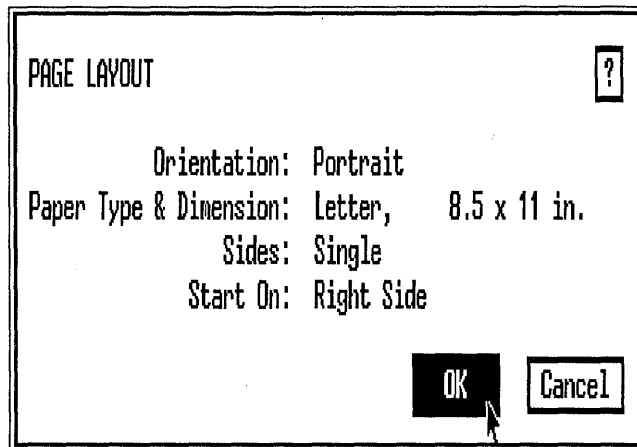

Page Size & Layout contains several options that affect the size of the Page and how pages are printed. Figure 1-12 summarizes the effects of some of these choices.

Single sides applies to documents that are printed on only one side. Later in the book you will work with double-sided documents, where print appears on both sides and such things as headers and footers and margins may be different for the left and right versions of the page.

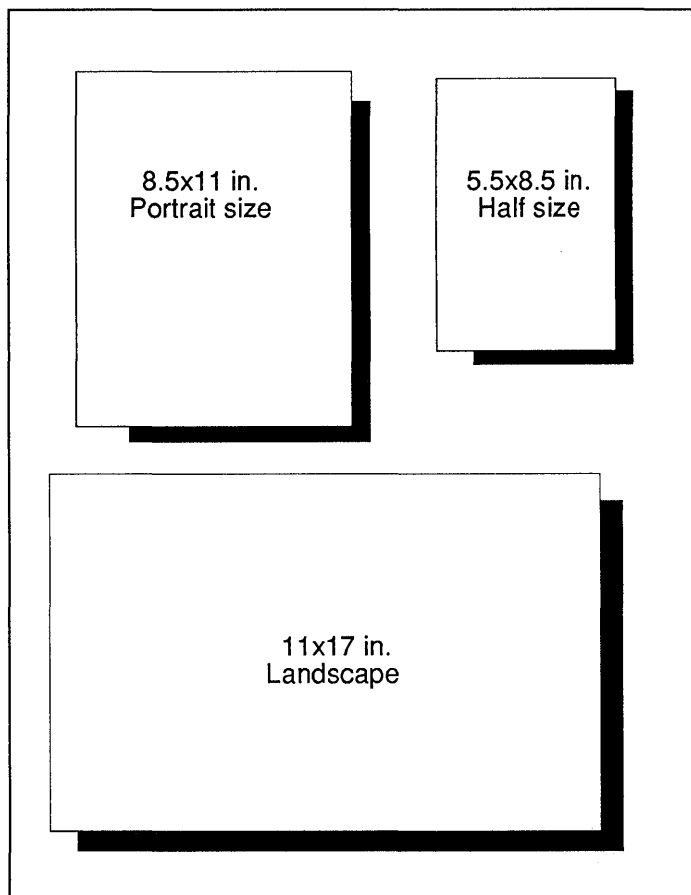

Figure1-12. Letter, Half and Landscape are the most common paper size options.

Create a header with page numbers

Our rule of thumb says that you should work from top to bottom in the Chapter menu. In this document, you will not be concerned with the Chapter Typography dialog box, or with any of the counting options. You can, therefore, move down to the Headers & Footers option.

Although we are using a header as an example, most of the concepts you are learning apply equally to footers. You can achieve similar effects in footers instead of headers, or you can combine both headers and footers on one page. For example,

you could place the document title in the header and the page numbers in the footer. In this example, however, you will place both a descriptive title and a page number in the header.

- Select Headers & Footers from the Chapter menu.

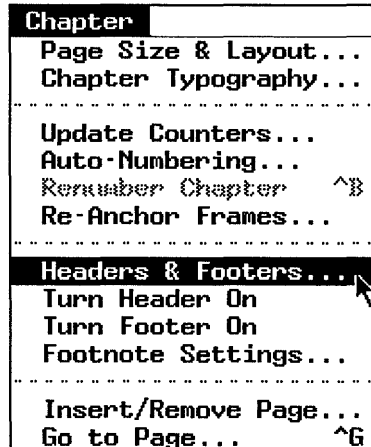

- Select Define: Right Page Header, Usage: On.

- On the line labeled Left, type:
Ventura Implementation

This action positions the report title (“Ventura Implementation”) on the left side of the page.

- Move the text cursor to the line labeled Right (click once next to the word “Right”). Now type: **Page** followed by a blank space.
- Choose the Page # button from the bottom of the dialog box. The page numbering code, [P#], appears on the line. Then click OK.

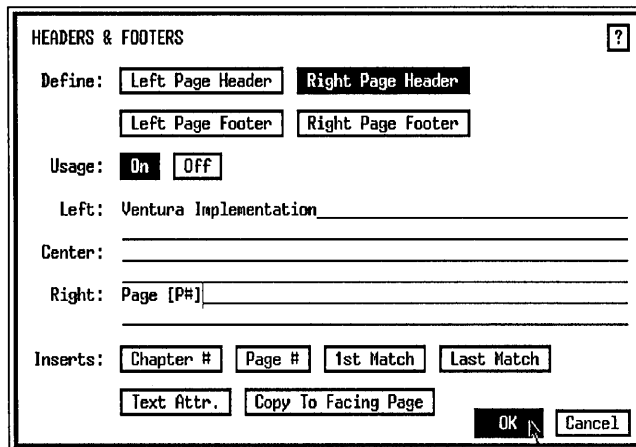

When you enter the page numbering code [P#] in the Headers & Footer dialog box, you tell Ventura to display the current number of each page in the header. If you prefer, you can also enter such codes into dialog boxes by typing them directly. Most people, however, prefer to use the buttons, thereby eliminating the need to memorize codes.

As soon as you close the dialog box, the header you created appears at the top of the page. (Since you are working with an existing style sheet, the format of the header has already been defined. Later you will change its style.) However, most reports do not include headers and footers on the first page. Let's turn the header off for the first page only while permitting it to remain on the following pages. Move further down the Chapter menu.

- Check to make sure you are on page one. If not, press Home to return to the first page of the document.
- Select Turn Header Off from the Chapter menu.

➔ **NOTE:** When you turn the header (or footer) off, the Chapter menu displays "Turn Header On" or "Turn Footer On." This menu option affects the current page only.

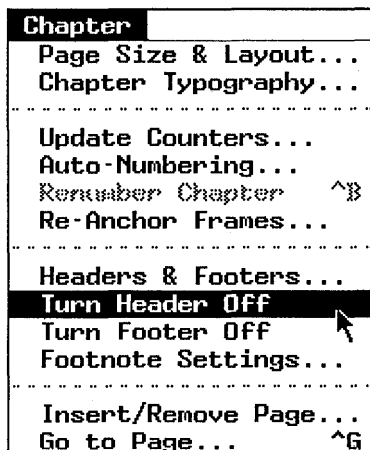

Change the margins

Since you are finished with the Chapter menu, the rule of thumb says you should now move to the Frame menu. Proceeding top to bottom, you come first to Margins & Columns. You will use this option to increase the margins from their original setting.

- Enable Frame mode (click the Frame button in the Mode Selector) and select the Underlying Page by clicking the mouse cursor anywhere on the workspace.
- Select Margins & Columns from the Frame menu.

If the dialog box shows measurements in units other than picas & points, place the mouse cursor anywhere on top of the unit measurement (e.g. inches or centimeters) and click until “picas & points” appears. If you are unfamiliar with picas and points, simply enter the settings for the time being. We will explain this measurement system in Chapter Two.

- Leave the top and bottom margins at 06,00 picas & points. Move the cursor to the Left line, press Esc to clear the line and type: 09,00. Then move to the Right line, press Esc and type: 09,00. Then click OK.

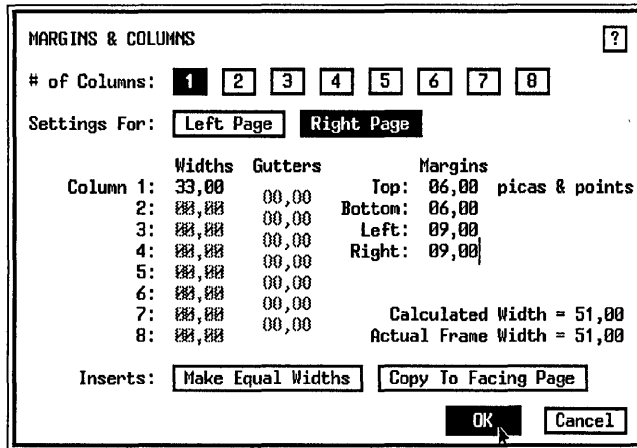

Reset the header to the new margins

Take a moment to look at the header on page two. It is aligned with the old margin settings. That's because Ventura sets the margins of the header equal to the margins of the Page. *Because you built the headers before you changed the margins, the header margins remain at the old value.* Therefore, you must now reset the header to match the new margin settings. Here's how.

- Select Headers & Footers from the Chapter menu and turn Usage: Off for both the right and left page header. Click OK.

This turns the header off for the entire document. Your settings are retained even though the header is no longer active.

- Now reselect the same dialog box and turn Usage: On. When you return to the document you will discover that the headers have been reset to match the current margins.

➔ *TIP: In actual practice, you may want to want to vary our left-to-right rule of thumb, and change the margins before creating the header. This way you can eliminate the extra step of changing the header margins.*

If you are feeling overwhelmed about now, remember this: you are learning valuable tips and techniques at the same time that you are learning basic skills. If you meet a concept that confuses you, don't stop. *Go on to the next section.* Come back

to the trouble spot later. Then you will see things from a new (and calmer) perspective. Believe it or not, everything will begin to fall into place.

Modifying tags

That's all the chapter formatting you will do for this first document. Now let's take a look at formatting individual paragraphs.

To Ventura, a paragraph *is any line or lines of text that ends with a carriage return*. A paragraph may be a single letter, a word, or several lines of text — as long as it is ended by pressing the carriage return (Figure 1-13).

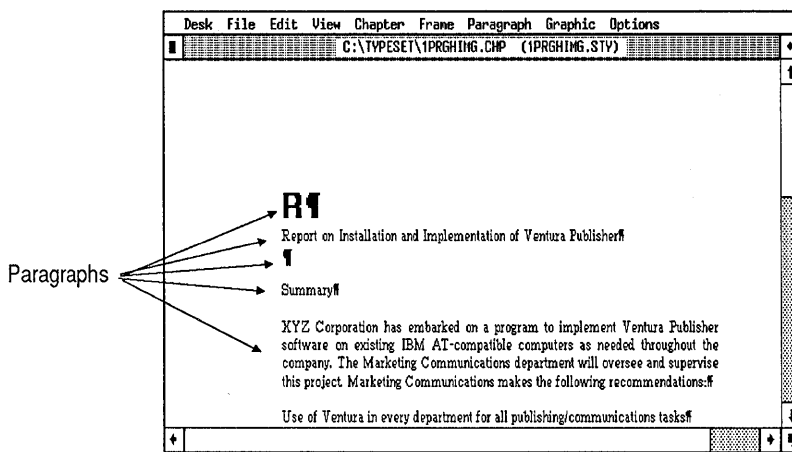

Figure 1-13. Ventura considers every line that ends with a Return as a separate paragraph, even "empty" lines.

You can make Ventura treat two or more sentences as one paragraph if you end a line with a line break (press Ctrl-Enter) instead of a carriage return. The line break appears as a backward arrow on the screen. Line breaks are useful when you want to break up information on separate lines, but you don't want to change the format (Figure 1-14).

For the most part, the formatting of individual paragraphs occurs in (surprise!) the Paragraph menu. The bad news: the Paragraph menu gives some users headaches because it packs so much power into so little space. The good news: we have a suggestion to make it simpler.

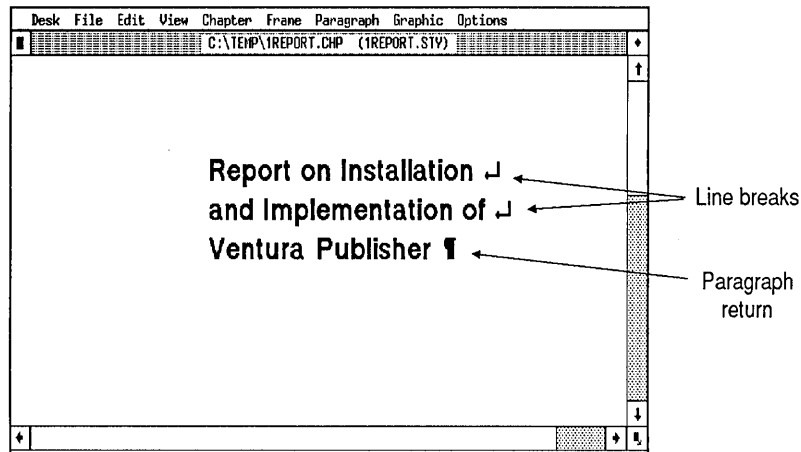

Figure 1–14. Line breaks let you start a new line without ending the paragraph.

➡ **TIP:** *Roughly 75% of all paragraph formatting is done in the first three dialog boxes: Font, Alignment, and Spacing.*

If you follow our previous suggestion to work from top to bottom, you'll soon make a discovery. By the time you finish with Font, Alignment, and Spacing, you've probably accomplished most of what you needed to do. In the beginning, concentrate your efforts on the "Big Three" dialog boxes and you'll soon gain a sense of control.

Let's pause for a moment to remind ourselves where we've been and where we're headed. You've completed the text portion of the report and now you're working on style. You've completed the chapter formatting and you're ready to start formatting the individual paragraphs. As you proceed through the rest of the style section, you will assign *tags* to individual paragraphs. Tags include attributes such as font type and size, alignment, spacing, and so forth. The style sheet you loaded at the beginning of the chapter comes with pre-defined tags.

Assigning a tag begins by enabling Paragraph mode and selecting a paragraph. While the paragraph is still highlighted, you tell Ventura which tag you want by clicking on a name from the Assignment List. The Assignment List includes all the style sheet's tags in alphabetical order.

➔ **NOTE:** The tags that begin with a “Z” are generated by Ventura. You will learn about generated tags in Chapter Two.

Your next question might be “Which paragraph should I work on first?” Here’s a guideline that applies to all documents:

➔ **TIP:** When you are ready to start working on individual paragraphs, format Body Text first.

As you will discover later in this chapter, the choices you make for Body Text affect the rest of the document. Thanks to Ventura’s style sheet approach, the changes you make to the first Body Text paragraph are automatically reflected in each and every Body Text paragraph throughout the document. There is no need to format each one individually. Any format change to one tag affects them all.

Change the Body Text font

- Enable Paragraph mode (click on the Paragraph button from the Mode Selector).
- Change to Normal View to select the first Body Text paragraph “XYZ Corporation has embarked...” (Figure 1–15.)

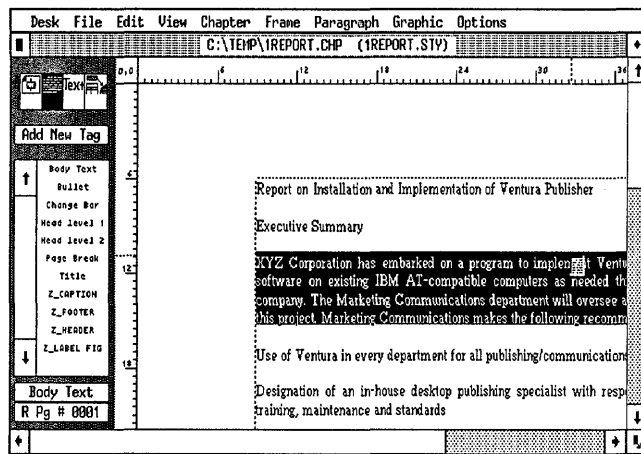

Figure 1-15.

- Select Font from the Paragraph menu.
- Choose Face: Helvetica, Style: Normal, Color: Black, and Size: 012.0 points. Click OK (Figure 1-16).

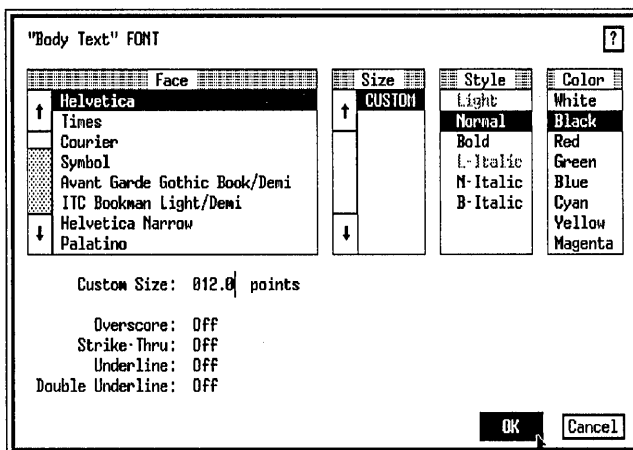

Figure 1-16. The Font dialog box for PostScript printers.

If you do not have a PostScript printer

Your Font dialog box may differ slightly from the one shown here if you did not choose PostScript as your printer. Do not worry about the slight variation (Figure 1-17). As you can see, there are only two differences. One is that you substitute Swiss for Helvetica. The second is that you choose the point size from a list rather than entering it on a line.

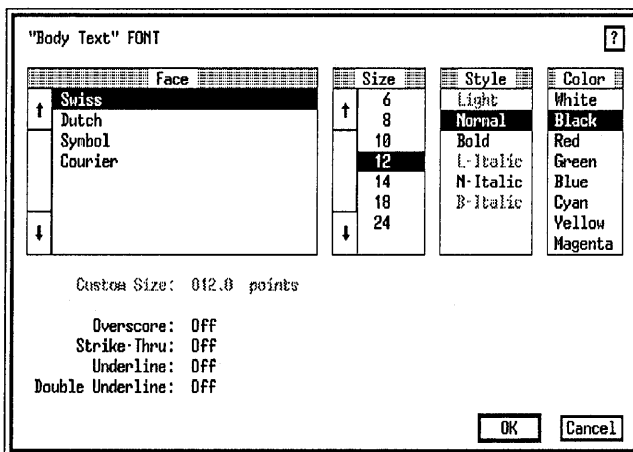

Figure 1-17. The Font dialog box for the Hewlett-Packard LaserJet.

All of the documents in the first section are constructed with the two basic fonts: Times and Helvetica. If you have a non-

PostScript printer, you know these fonts as Dutch and Swiss. As you may recall, we recommend that you install PostScript as one of your printer options even if you do not have a PostScript printer. You can switch to a PostScript printer during the projects with Set Printer Info from the Options menu. By selecting PostScript as your printer your screens will match the ones in the book. Then you would switch back (using Set Printer Info again) to your actual printer when it's time to print.

However, if you prefer not to install or use PostScript, you can use another printer. When you see instructions to use PostScript fonts, substitute your own font names instead. When you see Times, substitute Dutch. When you see Helvetica, substitute Swiss. (As an aid to remember which is which, it may help to recall that Helvetica is another name for Switzerland.)

➡ *TIP: If you did not install a PostScript printer, substitute Dutch whenever you see Times; substitute Swiss whenever you see Helvetica.*

Change the Body Text alignment

Most dialog boxes have multiple choices. We do not have the time to discuss every choice for every dialog box the first time we encounter it. For the moment, make the choices we suggest and leave the others unchanged. Rest assured that almost every choice in every dialog box is covered somewhere in the ten chapters of *Publishing Power with Ventura*.

- With the Body Text paragraph still highlighted, select Alignment from the Paragraph menu.
- Choose Horz. Alignment: Justified and click OK.

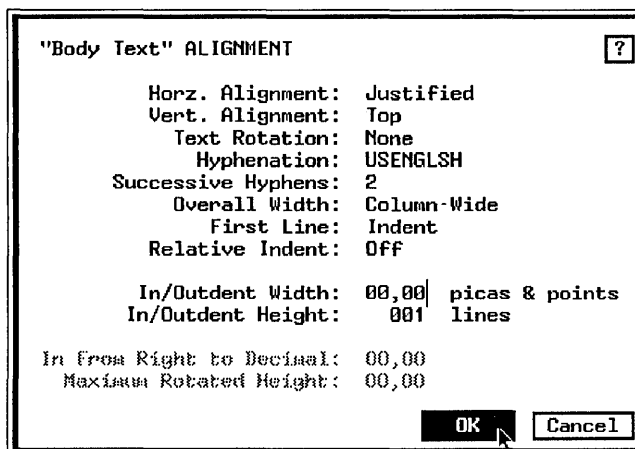

Change the Body Text spacing

The Spacing dialog box is one of the most complex, so take a deep breath. We need to spend a few paragraphs to get you started in the right direction. If you bear with us for a few minutes, you will have an easier time from now on.

The Spacing dialog box controls both vertical and horizontal spacing. Vertical spacing is handled in the top half (Above, Below, Inter-Line, Inter-Paragraph) and horizontal spacing is handled in the bottom half (In From Left, In From Right).

Vertical spacing has four variations: Above, Below, Inter-Line, and Inter-Paragraph. Above, Below, and Inter-Paragraph add space *between paragraphs*. Inter-Line puts space *between lines* (Figure 1-18).

➔ *TIP: Use Inter-Line Spacing for all tags. Use Above Spacing if you need additional space above the paragraph. Do not use Below unless you cannot get the effect you want with Above and/or Inter-Line. Avoid Inter-Paragraph.*

In other words, for additional space between two paragraphs, add Above Spacing to the lower paragraph. For instance, Figures 1-19 and 1-20 show what two paragraphs look like before and after you add Above Spacing.

Limiting spacing to Above and Inter-Line has advantages. Above spacing can be suppressed when a paragraph starts at

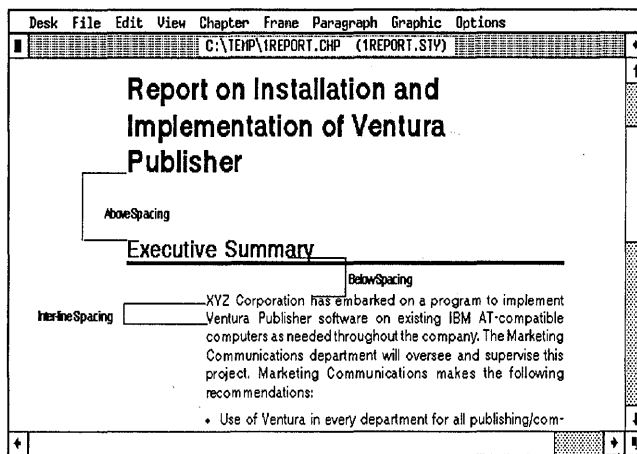

Figure 1-18.

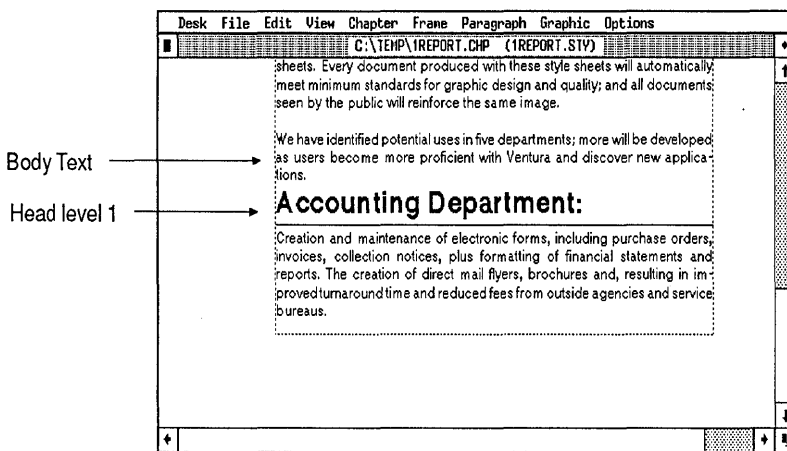

Figure 1-19. Here are two paragraphs before adding Above Spacing.

the top of a column by choosing Add in Above: When Not at Column Top. What's more, if two paragraphs have conflicting Above and Below spacing, *Ventura uses the larger value of the two*. If Body Text had 18.00 fractional pts Below Spacing and Head1 had 24.00 fractional pts Above Spacing, Ventura would use the 24.00 fractional pts from Head1 to add space between the paragraphs (Figure 1-21).

If you start by setting Below to zero, you don't have to worry

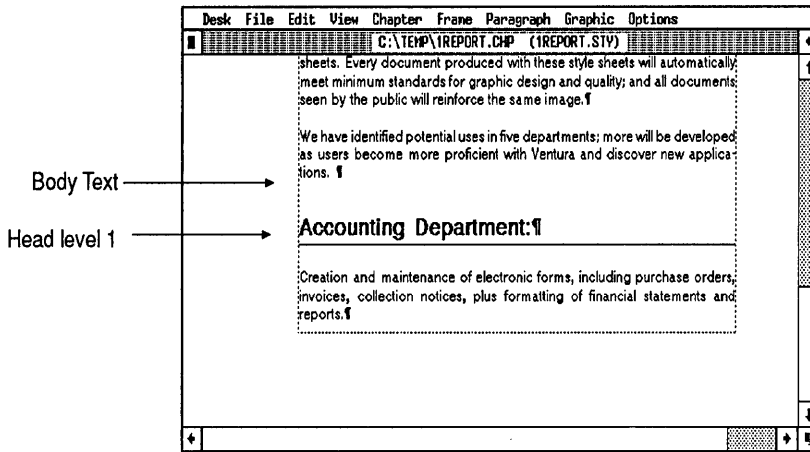

Figure1-20. With Above Spacing you add extra space above the Head1 paragraph to separate it from the Body Text.

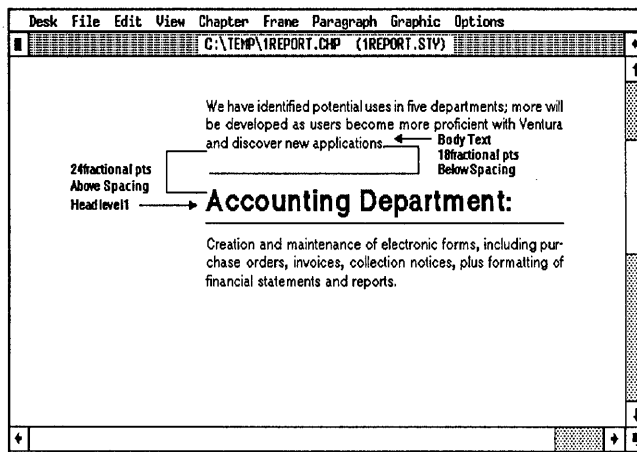

Figure 1-21. When conflicts arise between the spacing values of tags, Ventura chooses the largest value.

about one tag overriding another, and you always know where your spacing effect was created.

It is important to be consistent when working with Ventura. If you follow the tip above you will minimize the confusion some beginners experience with the Spacing dialog box. It's a simple system for first-time users. Nevertheless, there are exceptions to this rule. We'll explain the exceptions as you get to them. In general, however, you can get the look you want about 80% of the time using just Above and Inter-Line.

Let's put this rule of thumb into practice with the paragraph you were working on previously.

- With the paragraph "XYZ Corporation has embarked..." still highlighted, select Spacing from the Paragraph menu. Click on the unit of measurement until it reads fractional pts.
- Move the cursor to Above, press Esc to clear the line, and type: **14**

There is no need to type the .00. Ventura treats blanks as zeros. Thus, 14.00 and 14.__ are the same.

- Move the cursor to Below. Press Esc to clear the line. Leave it blank.

Since Ventura treats blanks as zero, leaving the line blank is equivalent to entering 00.00.

- Move the cursor to Inter-Line. Press Esc and type: **14**
- Move to Inter-Paragraph. Press Esc to clear the line. Leave it blank.
- Choose Add in Above: When Not At Column Top. Click OK.

When Not at Column Top eliminates the above spacing if the paragraph occurs at the top of a page or column (Figure 1-22).

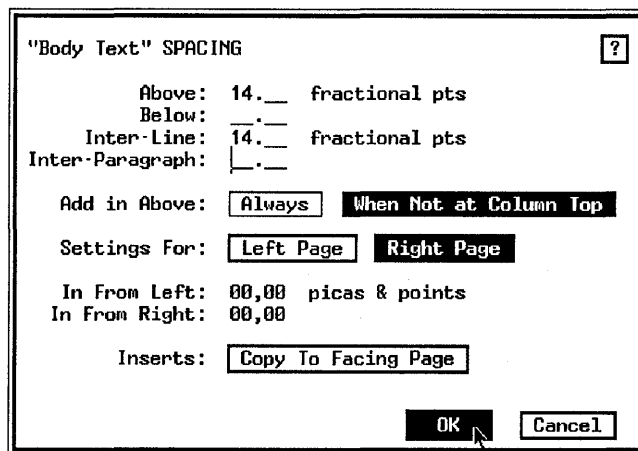

Figure 1-22.

Here's a second tip on vertical spacing:

➔ **TIP:** Spacing values should be an integer multiple of the inter-line spacing of Body Text.

You create a more pleasing page design by using standard vertical spacing, including spacing above headings, captions, subtitles and padding around pictures. That unit should be equal to or a multiple integer of Body Text's inter-line spacing. With consistent vertical spacing you can be assured that text will align across columns (Figure 1-23).

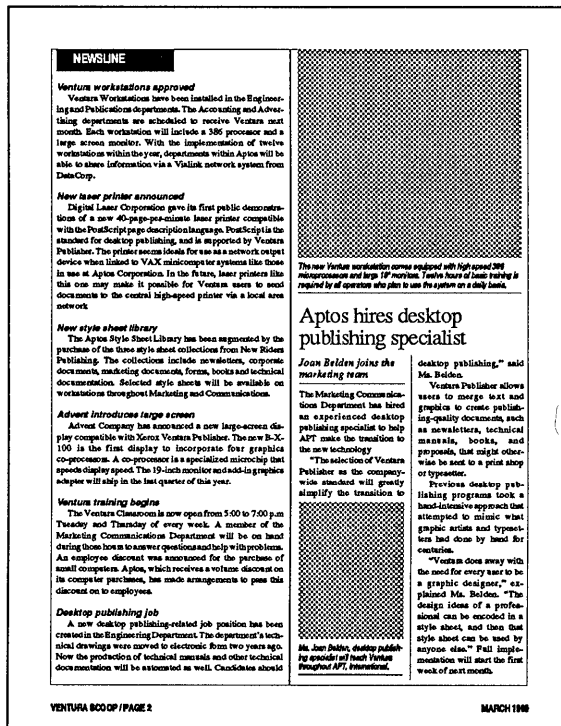

Figure 1-23. To align across columns, make spacing an integer of Body Text spacing.

In the example above, Inter-Line was 14.00 points, and we chose 14.00 fractional pts for Above. Other good choices might have been 07.00 fractional pts, 28.00 fractional pts, 42.00 fractional pts or other multiples of 14.00. If the inter-line spacing had been 12.00, then 06.00, 24.00 and 36.00 would have been valid options.

About horizontal spacing

Hang in there. You're halfway home. You've covered vertical spacing. Stick with it for a few more paragraphs as we explain the horizontal spacing options in the Spacing dialog box.

➔ *TIP: Treat In From Left and In From Right as "extra" margins when the original margins set in the Frame menu are not enough.*

In certain cases, you want an overall margin for most of the document, but different, smaller margins for other text elements. In such a case, use the Spacing dialog box to create secondary margins with In From Left and In From Right.

Create a secondary margin for Body Text

Try creating a secondary margin for the Body Text tag with In From Left. Shortening the line length will make the text easier to read.

- Select Spacing from the Paragraph menu or press Ctrl-X to bring up the last dialog box. If necessary, change the unit measurement. (Put the mouse cursor on top of the measurement units next to In From Left spacing and click until picas & points shows.)
- Make In From Left spacing 06,00 picas & points. Click OK.

"Body Text" SPACING ?

Above: 14.00 fractional pts
 Below: 00.00
 Inter-Line: 14.00 fractional pts
 Inter-Paragraph: 00.00

Add in Above:

Settings For:

In From Left: 06,00 picas & points
 In From Right: 00,00

Inserts:

➔ **NOTE:** *In From Left is measured from the edge of the margin not from the edge of the paper.*

When you return to the document, the Body Text now starts six picas & points from the original left margin (Figure 1-24).

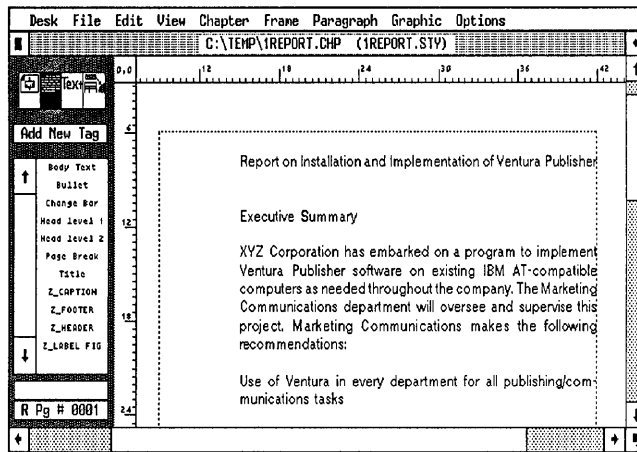

Figure 1-24.

You have already used the Big Three: the Font, Alignment, and Spacing options. Since there is nothing more that needs to be done to Body Text, you are ready to move to another text paragraph.



Stopping point

You have reached another recommended stopping point. If your time is limited, save your work and exit Ventura. Return to complete the project when your schedule permits.

Change the Title tag

If you are restarting after leaving Ventura, select Open Chapter from the File menu to open C:\TEMP\1REPORT.CHP.

If Body Text should always be the first tag you modify, what should be the second? We recommend starting at the top and marching through in order. The next paragraph is the title. In the next few steps, you will apply the Title tag. Then you will modify it by changing its font, alignment, and spacing.

- Select the paragraph “Report on Installation and Implementation of Ventura Publisher.” Select Title from the Assignment List to apply the tag (Figure 1-25).

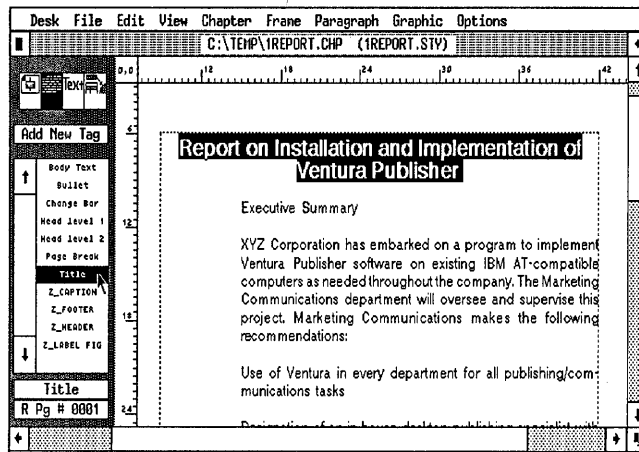
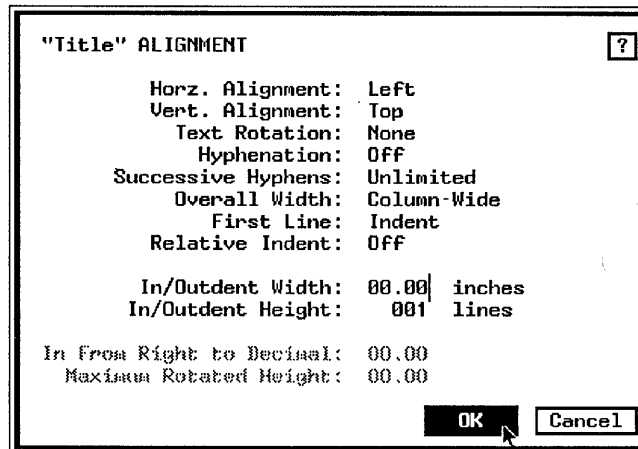

Figure 1-25.

- Select Font from the Paragraph menu. Make the Size: 024.0 points and click OK.

Change the Title alignment

- Select Alignment from the Paragraph menu. Choose Horz. Alignment: Left and Hyphenation: Off. Leave the remaining settings unchanged. Click OK.



The title appears flush against the left margin.

Notice that you turned off hyphenation. Titles and display type over 18.00 fractional pts. should generally not be hyphenated.

Adjust the Title spacing

- Select Spacing from the Paragraph menu. Verify that the units of measurement are displayed as fractional pts.
- Move to Above, press Esc to clear the line and type: **42.00**
- Move to Below and press Esc to clear the line. Leave it blank. Move to Inter-Line, press Esc and type: **28.00**
- Move to Add in Above and choose Always. Click OK.

As you can see, the settings in the Spacing dialog box adhere to the rule of thumb. You set Below Spacing to zero and created the space between paragraphs with Above Spacing. Because the Body Text inter-line spacing is 14.00 fractional pts, you used a multiple of 14 for the inter-line and above spacing in the Title tag.

WARNING: As you proceed through the additional tags, your results may not match the book unless you select Auto-Adjustments: None from Set Preferences in the Options menu (Figure 1-26).

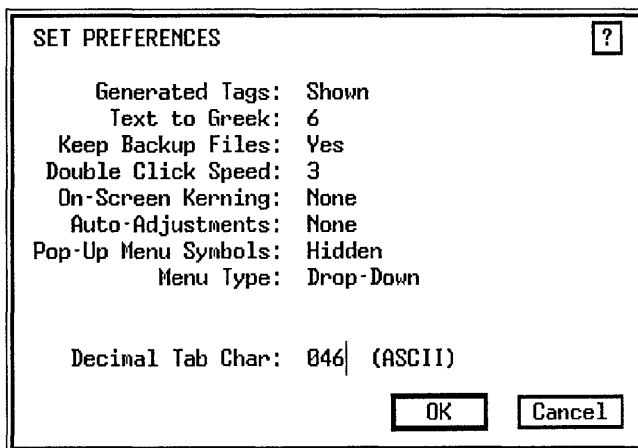

Figure 1-26.

The Auto-Adjustments setting in the Options menu affects the settings you use in the Spacing dialog box. If Auto-Adjustments is set to Styles, Ventura will automatically adjust the inter-line spacing of a tag each time you change its font size. If you increase the font size by 20%, Ventura will increase the inter-line spacing by the same percentage. This automatic adjustment may seem like a convenience. In practice, however, it usually results in hard-to-use fractional spacing. We recommend spacing related to the standard unit of the Body Text. Auto-Adjustments throws off this standardization. For these reasons, we recommend working with it off. Instead, you will manually adjust spacing as necessary.

In addition, as you get further along, we will not tell you each and every choice to make in each and every dialog box. Instead, we will mention only the changes. You will leave everything else unchanged. If you have Auto-Adjustments set to Styles, the inter-line spacing may differ from what we expect you to have.

The Head level 1 tag

Now that you are finished with the Title tag, you are ready to move on to the next paragraph down the page. Tag it as Head level 1 and then change the way it looks.

- Select the next paragraph “Executive Summary.” Select Head level 1 from the Assignment List (Figure 1–27).

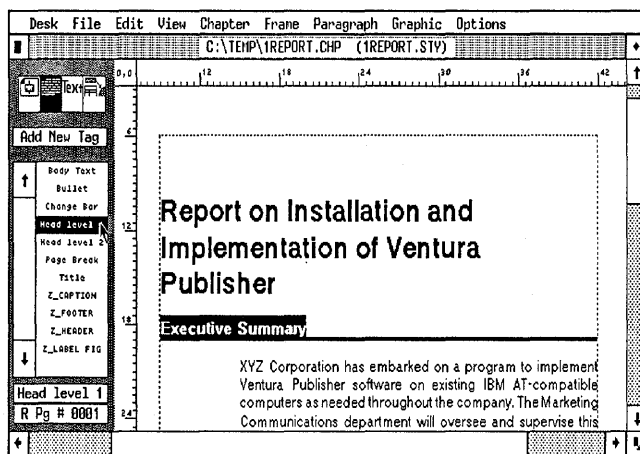

Figure 1–27.

The format that appears is part of the original style sheet that you loaded at the beginning of the project. For instance, the ruling line below was created by selecting the Ruling Line Below option in the Paragraph menu (you'll learn more about ruling lines later in the book).

➔ *NOTE: If you are curious to know how a format was created, look for clues in the Paragraph menu options. Exploring on your own can lead to discoveries. But before you start to experiment, save the chapter. Then, if you make a mistake, you can choose Abandon to return to the last saved version.*

Change to the abbreviated format

Now that you have assigned the Head level 1 tag, you can go through the “Big Three” — Font, Alignment, and Spacing — to change its appearance.

To speed the process, we will use a shorter method to note changes. For example, to change the Head level 1 font we will use:

■ Font Size: 018.0 points

This abbreviated format means that you should open the Font dialog box, change the point size to 018.0 points, *leave everything else unchanged*, and click OK to close the dialog box.

➔ *NOTE: Make only the changes indicated. Leave anything not listed the way you found it when you opened the dialog box. After making the indicated changes, click OK to close the dialog box.*

Change the Head level 1 spacing

You will use Above Spacing to add extra space between the Head level 1 and the Title tag.

■ Spacing Above: 42.00 fractional pts
Inter-Line: 28.00 fractional pts
Add in Above: When Not at Column Top

The Bullet tag

- Select the paragraph “Use of Ventura in every department...” and tag it as Bullet (select Bullet from the Assignment List). (Figure 1–28.)

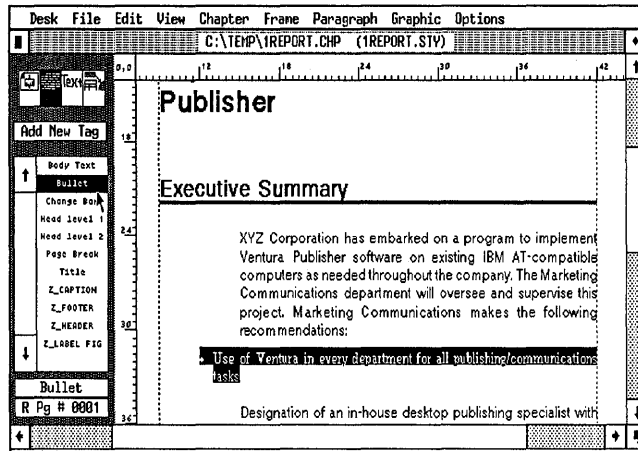

Figure 1–28.

➡ **NOTE:** You may have to scroll up or down the page to find the paragraph to select.

The attributes from the original style sheet are applied to the paragraph.

To change the tag, you will step through Font, Alignment, and Spacing. Since you have already encountered these dialog boxes several times, we will list the changes in abbreviated form.

- Font Face: Helvetica
- Spacing Above: 07.00 fractional pts
Below: 00.00 fractional pts
Inter-Line: 14.00 fractional pts
Add in Above: When Not at Column Top
In From Left: 06,00 picas & points
(or 72.00 fractional pts)

When you are finished, the Bullet tag should look similar to Figure 1–29:

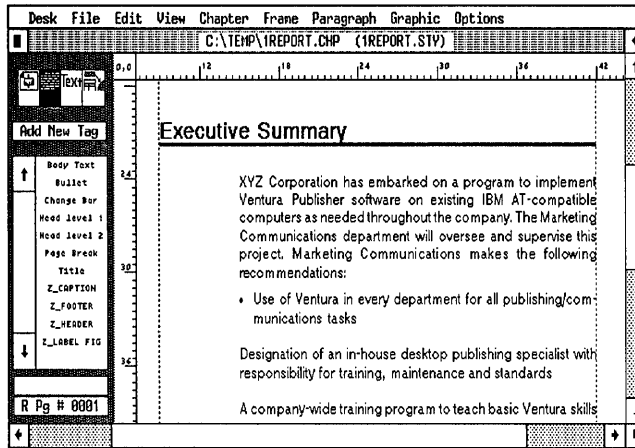

Figure 1-29.

Select multiple paragraphs

Next, you will tag three more paragraphs as Bullet using the Shift-Click technique. Shift-Click lets you tag several paragraphs at one time. Click on the first paragraph as you would normally. Then hold down the Shift key while clicking on the additional paragraphs. All the paragraphs are highlighted simultaneously and the Current Selection Box shows the word Multiple.

➔ *TIP: Use Shift-Click whenever possible when giving several paragraphs the same tag name.*

- Select the paragraph “Designation of an in-house...” *While holding down the Shift key, select the paragraph “A company-wide...” Without releasing the Shift key, select the third paragraph “Advanced workshops...”*
- When all three paragraphs are selected, release the Shift key. Then choose the Bullet tag from the Assignment List.

When you have finished, your document should look like Figure 1-30. Now you will finish the page by assigning the Head level 1 tag to the paragraph immediately below the bullets.

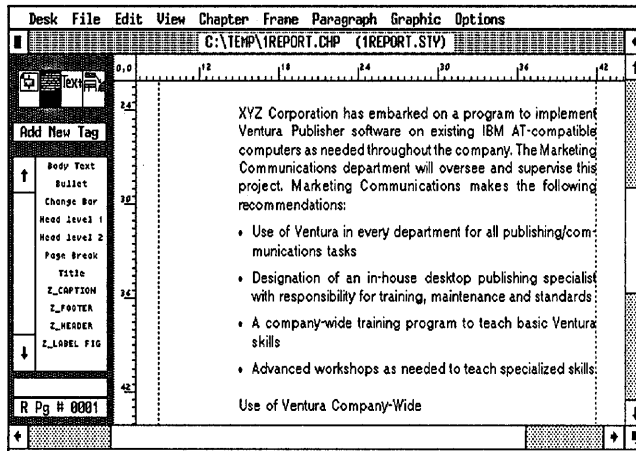

Figure 1-30.

- Select the paragraph “Use of Ventura Company-Wide” and tag it as Head level 1 (Figure 1-31).

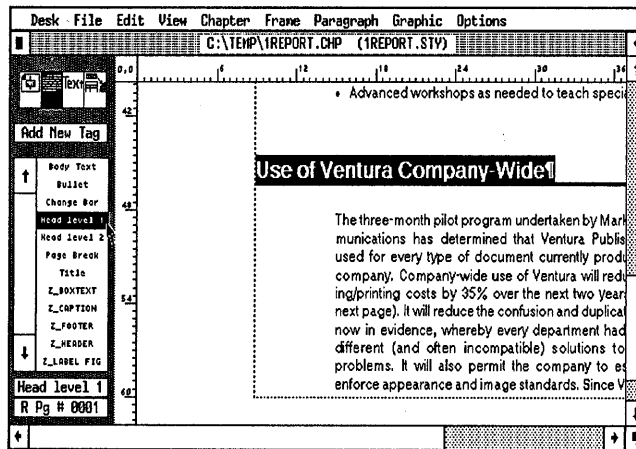

Figure 1-31.

The Head level 2 tag

Next go to page two, where you will assign the Head level 2 tag and change its attributes.

- Press the PgDn key to go to page two (if necessary, scroll to the top of the page).

- Select the paragraph “Accounting Department:” and tag it as Head level 2.

With the paragraph still highlighted, make the changes shown below in abbreviated form.

- Font Size: 014.0 points
- Spacing Above: 28.00 fractional pts
 Below: 00.00 fractional pts
 Inter-Line: 14.00 fractional pts
 Add in Above: When Not at Column Top
 In From Left: 06,00 picas & points
- Use Shift-Click to assign the Head level 2 tag to the following paragraphs: “Advertising Department,” “Market Communications,” “Internal Publications,” and “Engineering.”

Complete the tags

You have made all the changes to tags. All that remains in the style section is to assign these tags to a few more paragraphs.

- Select the paragraph “In-House Desktop Publishing Specialist” and tag it as Head level 1.

Because of the tag’s Above Spacing, the paragraph is forced onto the next page.

- Press PgDn to go to the next page (page three).
- Select the two paragraphs at the bottom of the page that begin “It will explain...,” and “It will teach...” and tag them as Bullet.
- Now select the paragraph “Company-Wide Basic Training for Ventura” and tag it as Head level 1.
- Press PgDn to go to the next page.
- Select the paragraph “Advanced Workshops” and tag it as Head level 1.

Pictures

Congratulations. You have finished the style portion of this document. By now you should already be seeing some im-

provement in the appearance of the report. Before you finish this first project, you will add a picture by drawing a frame on the page and placing a picture file inside.

Add a frame

Before placing a picture, you must add a frame to contain it. Check to make sure the rulers on the top and left side of the screen are displayed in picas. If not, use Set Ruler from the Options menu to change the units. Click once on the 0,0 square in the upper left corner. This sets the zero point to its original position and ensures that your rulers match ours (Figure 1-32).

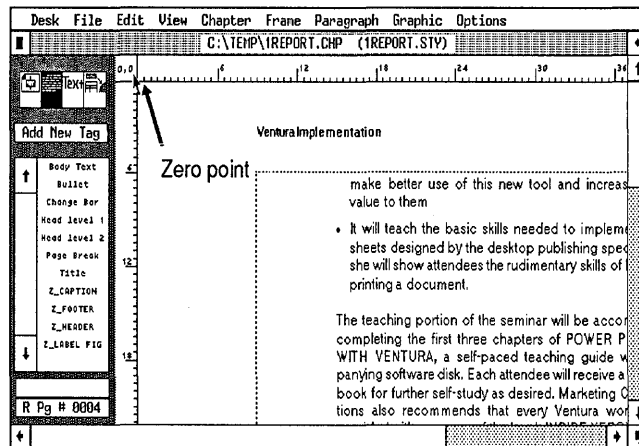

Figure 1-32.

Now you will go to the second page and add a frame.

- Select Go to Page from the Chapter menu. Choose Selected Page: 0002 and click OK.

Ventura takes you to page two.

- Enable Frame mode.
- Click on the Addition button from the Side-Bar. The words Add New Frame are highlighted (Figure 1-33).

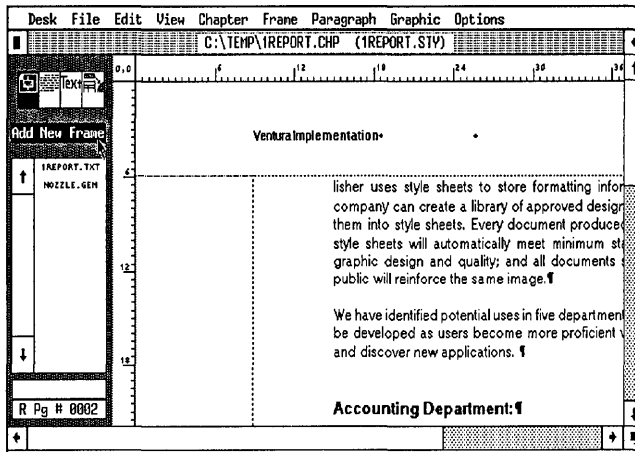

Figure 1-33.

- Place the corner of the cursor where you want the upper left corner of the frame to appear. Use the ruler to position the frame cursor so it lines up with the left margin of the Body Text and the top of the column guide (Figure 1-34.). Perfect accuracy is not important for this first attempt.

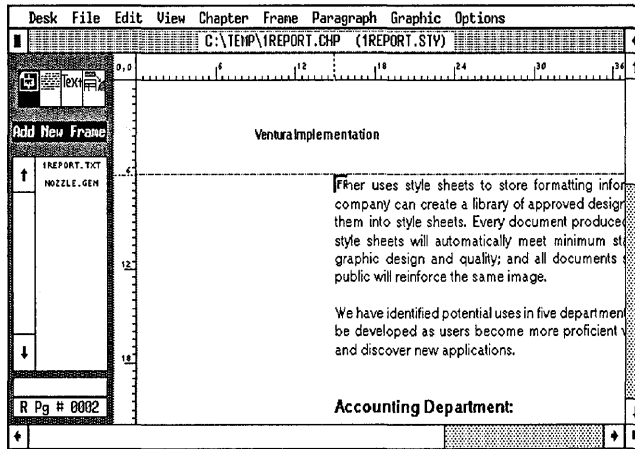

Figure 1-34.

It may help to position the frame if you change to Normal (Ctrl-N) or Enlarged (Ctrl-E) View.

- Press and hold down the mouse button. When the cursor changes to a picture of a pointing finger, drag the lower right corner of the frame downwards and to the right margin. Release the mouse button when you reach the 21-pica

position on the vertical ruler and position 42 picas on the horizontal ruler (Figure 1–35).

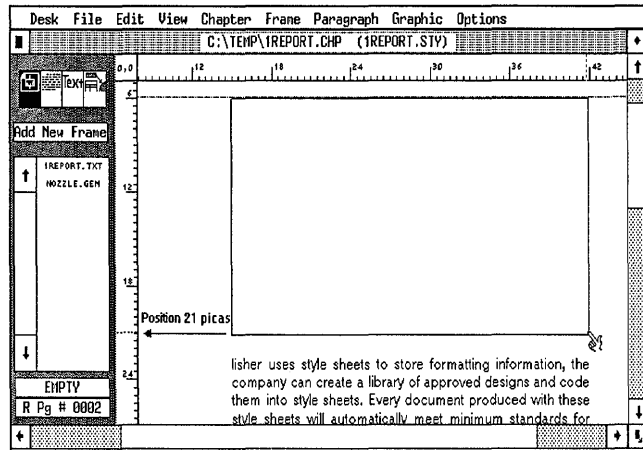

Figure 1–35.

Ventura’s column snap and line snap force the new frame to line up properly. Column Snap forces the frame to align with the margins. Line Snap, which is automatically set to Body Text’s inter-line spacing (14.00 fractional pts), makes the the frame an integer relationship to the other page elements.

If you have a problem placing or sizing the frame use one of the following tips:

- To delete a frame, select it and press the Del key (or select Cut Frame from the Edit menu).
- To adjust the size of the frame, point to one of the black sizing buttons around the frame. Then press and hold down the mouse cursor until the pointing finger appears. Then push or pull the frame into shape.
- To move a frame, place the cursor anywhere inside the frame (not on one of the sizing buttons) and hold down the mouse button. When the four-way arrow appears drag the frame to a new location.

Add padding to the frame

After you set the location of the frame, you should add some *padding* — extra breathing space that keeps surrounding text

from touching the border of the frame. In the following example, you will set vertical padding to 14.00 fractional pts — the standard spacing unit derived from Body Text.

The vertical padding option places a white space buffer both above and below the frame. Thus, in the example above, the frame will have 14.00 fractional pts of padding at the top and 14.00 fractional pts at the bottom. Text will not be allowed to come within 14.00 fractional pts at top or bottom.

- With the frame still highlighted, select Sizing & Scaling from the Frame menu.

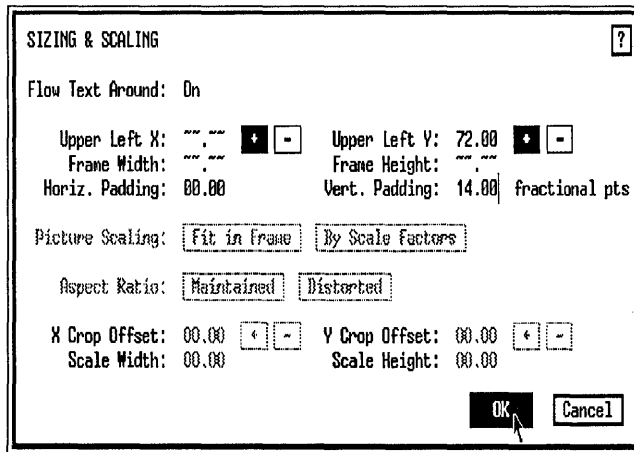

- Choose fractional pts as the unit of measurement.
- Move to the Vert. Padding line, press Esc to clear the line, type: **14.00** and click OK.

The frame now has a 14-point cushion of white space above and below it.

Place the picture

- With the new frame still selected, select the picture file NOZZLE.GEM from the Assignment List.

The picture appears inside the frame (Figure 1-36).

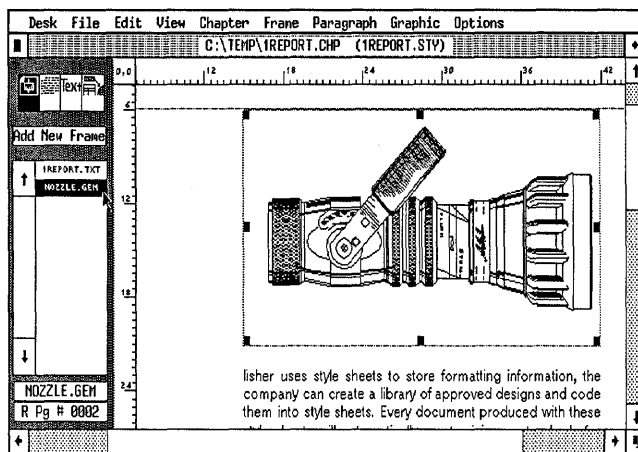

Figure 1-36.

Chapter

With text, style and picture finished, you need only complete the chapter portion of the report.

Print the chapter

The only real test of a document is how it looks on paper. In the chapter section of this project, you will print the report you just created. Then we will show you how to back it up on a floppy disk using Ventura's Multi-Chapter function.

- Press Ctrl-S to save the chapter.
- Select To Print from the File menu.

WARNING: If you installed PostScript as your printer for the purposes of this project, but you do not have a PostScript printer, use Set Printer Info to switch back to your original printer. Chapter Three contains a detailed explanation of the Set Printer Info dialog box.

- Choose Which Pages: All, Printing Order: 1st to Last. Leave all other settings alone. The Configuration line should match the default printer you selected when you installed Ventura. Click OK to print a single copy of the four-page report (Figure 1-37).

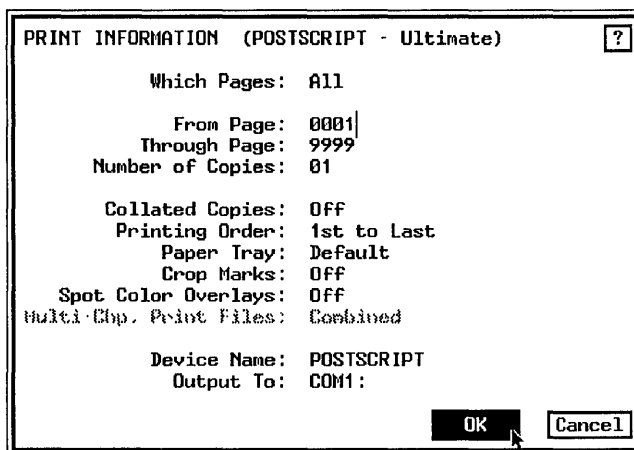

Figure 1-37.

Ventura displays a message that it is printing. If you need to cancel the printing command, press Esc. Ventura will then give you the choice of stopping or continuing.

Back up a chapter

As explained earlier, Ventura uses pointers to keep track of the files in a chapter. If you use DOS to back up a chapter with the COPY command, you will move all the files to a new location *but the pointers will still be set to the old location*. The chapter will load from the new location, but when the chapter looks for the text, style, and picture files it needs it will be unable to locate them. The chapter will still be looking for them at the old location.

To solve this dilemma, use Multi-Chapter from the Options menu to back up chapters. This utility not only copies the files, *it automatically changes the pointers to correspond to the new locations*.

Ventura permits you to create a *publication*, which can be a collection of many chapters. You can then copy or print all of the chapters in the publication with a single command. You will practice this skill in Chapter Three. But you don't have to create a publication just to copy a single chapter. Here's how it works:

- Place a formatted floppy disk in the A: drive.

- Select Multi-Chapter from the Options menu. If you haven't already saved the chapter, Ventura will ask you if you want to Save or Abandon your changes. Choose Save. The Multi-Chapter dialog box appears and the name of the current chapter, C:\TEMP\1REPORT.CHP is highlighted in the list (Figure 1-38).

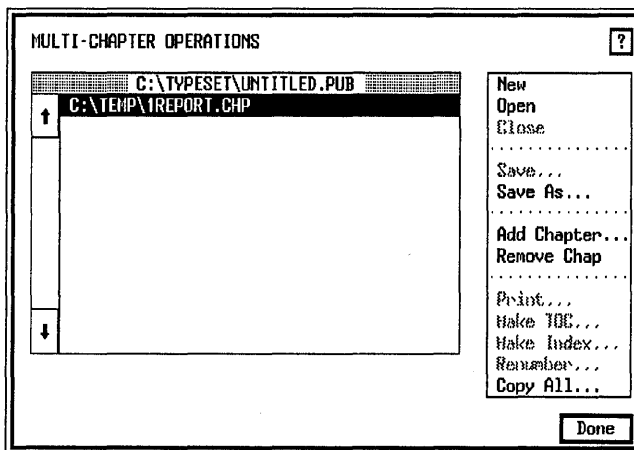

Figure 1-38.

- Select Copy All.

The Copy All dialog box appears (Figure 1-39).

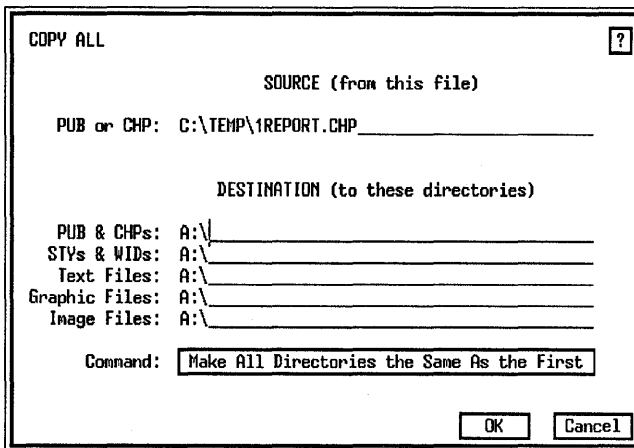

Figure 1-39.

The name of the chapter is displayed at the top of the dialog box. The destination lines show the disk drive and subdirectory to which each file will be copied. When you first select Copy All, Ventura will “guess” where you want to copy the files. You will change this guess to the actual destination (the A:\ drive).

- Move the cursor to the line PUB & CHPs. Press Esc to clear the line and type: A:\

As you can see, you have the option to copy different kinds of files to different subdirectories. In this case, however, you will copy all the chapter files to the A:\ drive. Luckily, Ventura has a feature that makes it unnecessary to type A:\ on each line.

- Choose Command: Make All Directories the Same As the First. Click OK.

Ventura copies all the files to the A:\ drive. When the copy function is complete, you return to the Multi-Chapter dialog box.

- Choose Done to close the Multi-Chapter dialog box.

If Ventura asks you if you want to abandon or save changes made to the publication, click on Abandon to return to the work area.

Once you have completed printing and backing up the chapter, you can go onto the next project or exit from Ventura. To exit:

- Select Quit from the File menu.

If you haven't saved recently, Ventura will ask you if you want to Save or Abandon. Choose Save.

You made it. You created a business document with Ventura. Although some of the new concepts and theory may have been tough going for beginners, you have already learned many of the basics — basics you will reuse again and again. Along the way, you made a big improvement in the appearance and efficiency of the sample report.

And you can do even more to enhance basic business documents. Turn to Chapter Two for more ideas and techniques for power publishing with Ventura.



Tips and techniques

Text tips

- Use File Type/Rename from the Edit menu to relocate text files (copy them to a new subdirectory) or to convert them to a different word processing format.
- Do as much editing, changing, adding, and spell checking as possible in the word processor before bringing the file into Ventura. Text editing in Ventura is slower and less efficient.

Style tips

- Always rename the style sheet at the beginning of the work session to avoid corrupting the original.
- To avoid confusion, many users give the style sheet the same name as the chapter (for instance, SAMPLE.CHP and SAMPLE.STY).
- Perform the Chapter formatting first, then move to individual paragraph formatting.
- You will feel less confused if you concentrate on the Chapter, Frame, and Paragraph menus during the style phase of a document.
- Work from left-to-right and from top-to-bottom in Ventura's menus to avoid overlooking important operations.
- When working in the Paragraph menu, focus on the Font, Alignment, and Spacing menus.
- Use Inter-Line spacing for every tag. Use Above spacing if necessary to provide additional separation from the preceding paragraph. Use Below spacing only if you cannot get the effect you want with Inter-Line and Above. Use Inter-Paragraph only as a last resort.
- If possible, make all vertical spacing an integer multiple of Body Text's inter-line spacing. This applies to spacing above and below headlines, subheads and bullets, as well as to frame sizes and frame padding (white space around pictures).

- For faster tagging, use Shift-Click to select several paragraphs at once.

Chapter tips

- Use Save As to rename (and/or relocate) the chapter at the beginning of every work session. Once you have renamed the chapter you can save it as you go along simply by pressing Ctrl-S.
- Create a separate subdirectory for each project. If the document is very large, subdivide the hard disk even further.
- Never use DOS copy to move chapters and associated files. Use Multi-Chapter so the internal pointers are changed to match the new location. Exception: You can use DOS to move files between two identically configured computers. For instance, you could move SAMPLE.CHP from the C:\TEMP subdirectory of one computer and put it on the C:\TEMP subdirectory of a second computer. As long as each and every file is found in the same location on both computers, the chapter will load properly on the new computer.
- You can type the new subdirectory location on the Directory line and move to it by pressing Enter (or clicking OK). However, the easiest way to navigate around the hard disk is with the mouse and the backup button.

Chapter Two Skills Checklist

Theory

- Understanding picas and points
- Preformatting text in your word processor
- Inserting special characters with bracket codes

Text

- Ventura's editing tools
- Adding text attributes with Text mode

Style

- The benefit of a two-column page format
- Adding and changing tags
- Creating a title page
- Creating a page break tag
- Setting off lists with bullets
- Using horizontal tabs to make a table

Pictures

- Placing text inside a frame
- Adding a ruling line around a frame
- Attaching captions to frames

Chapter

- Print the current page

Chapter Two

A Two-Column Proposal

Although you may not realize it yet, you have already acquired a solid grounding in Ventura fundamentals just by completing the first chapter. Chapter Two reinforces these basics while teaching the new skills summarized in the checklist to the left.

Why you should not get discouraged

This may be a good time to reassure novice users. If Ventura seems a bit intimidating during the first few weeks, remember that you are really tackling two things at once. First, you must learn the software, not a trivial task considering that Ventura is one of the most powerful packages ever written for a personal computer. At the same time, you must learn about layout and design, a separate (and complex) discipline of its own. This dual struggle frustrates some beginners. The best solution is to keep practicing.

After each chapter, you may want to apply what you've learned to a real-life project. If you get stuck, go back to the book for guidance. Remember, mastery of Ventura is a matter of hands-on experience over a period of time. The more documents you work on, the sooner you'll gain confidence and reach true proficiency. If you continue to follow along with the projects in the book, things will soon fall into place.

Theory

In this section, we will introduce you to the measuring system the professionals use when working with Ventura. The second

half of the theory section discusses how to preformat text with your word processor to save production time in Ventura.

Picas and points

Most Americans are comfortable with inches. But for desktop publishing, the method called printer's measure or *the point system* is superior. Since type sizes are always specified in points, it makes sense to use printer's measure for everything on the page so you don't waste time converting back and forth. In addition, the point system has units that are much smaller than inches, so it is rarely necessary to complicate things with fractional units. By contrast, using inches requires you to make many fractional computations.

For these reasons, printer's measure is the easiest way to talk to a page layout program. (Most programs let the user choose between inches, centimeters or printer's measure.) The two most important units in printer's measure are *points* and *picas*.

Points are very small unit, about $\frac{1}{72}$ inch. They are used to measure type sizes and rules. The point size of a typeface is roughly the measurement from the highest ascender (the top of a "b" for instance) to the lowest descender (the bottom of a "g"). This is only an approximation, since point sizes originate from the metal body used to carry type in the days before phototypesetting. The best way to get familiar with point sizes is by example. You'll soon develop an eye for the most common sizes.

Picas are a larger unit. Don't confuse them with the typewriter style of the same name. They are equal to 12 points (about $\frac{1}{6}$ inch). Printers and typographers use picas to measure lines, margins and columns. Table 2-1 will help you convert common sizes from one system to the other.

Table 2-1. Conversion table for common measurements.

| Inches | Picas & Points | Fractional Pts. |
|-----------|---|--------------------|
| 1/8 in. | 1 pica & points | 12 fractional pts. |
| 1/4 in. | 01,06 picas & points (1 pica and 6 points) | 18 fractional pts. |
| 1/3 in. | 02,00 picas & points | 24 fractional pts. |
| 1/2 in. | 03,00 picas & points | 36 fractional pts. |
| 1 in. | 06,00 picas & points | 72 fractional pts. |
| 5 1/2 in. | 33,00 picas & points | |
| 8 1/2 in. | 51,00 picas & points | |
| 11 in. | 66,00 picas & points | |

Preparing text for Ventura

You can make life with Ventura a lot easier if you learn how to prepare text files for Ventura in advance. All the sample files that you use for the publishing projects in this book are already prepared for you, so you won't have to worry about doing it now as long as you have the Power disk. Still, we want you to understand the theory so you can use it for files you create on your own. Preformatting text files can save you time in Ventura.

You've probably heard the expression "less is more." When creating text files for Ventura, however, less is *less* when it comes to inserting global formats such as indents, centering, page numbering, and so forth. The less you format with the word processor — the less formatting, the less extra spaces, the less extra carriage returns — the less work you will have when you bring the file into Ventura. At best, global formatting from a word processor is ignored by Ventura. At worst, it creates extra spaces, tabs, or characters that must be manually removed.

➔ *TIP: Do as little global formatting as possible with the word processor. Perform global formatting in Ventura instead.*

Here are some of the things you should *not* do with the word processor. Do not:

- Center text
- Justify text
- Indent the first line of a paragraph
- Create temporary (secondary) margins
- Put more than one space after a period, colon, or question mark
- Put more than one carriage return between paragraphs
- Put more than one tab stop between columns

As you can see, we recommend only one carriage return between paragraphs. Although this reduces the time spent deleting extraneous returns in Ventura, it does make the file hard to read in the word processor. Luckily, Ventura has a built-in feature to handle this problem: the `@PARAFILTR ON =` code. By using this code you can put an extra carriage return between paragraphs and Ventura will filter it out for you.

The `@PARAFILTR ON =` code must be inserted as the very first line of the document and it must be typed correctly, or Ventura will ignore it. Make sure you place a space before and after the word “ON” and a space before and after the equals sign (Figure 2-1).

One advantage a word processor has over Ventura’s current version is an easy search and replace function. For instance, you could use search and replace to remove all extra spaces after periods. Likewise, if you make a text change throughout a document — for example, substituting one name for another — do it with search and replace before starting Ventura.

We said that “less is less” for global formatting. When it comes to formatting individual paragraphs, however, we could say the opposite: more is more. The more individual formatting you do in the text file, the more efficient you’ll be.

```

[.....1.....2.....3.....4.....5.....].....7.....
@PARAFILTR ON = ¶
Consulting Proposal to ABC Company¶
¶
XYZ Corporation¶
¶
September 1, 1989¶
¶
Consulting Proposal to ABC Company¶
¶
Project Description¶
¶
XYZ Corporation proposes to advise ABC Company on all
aspects of desktop ¶
publishing systems, including needs analysis, product and
market surveys, specifications ¶
and purchase, and system implementation.¶
¶
The initial short-term goal is to computerize the production
of ABC's ¶
-ZPROPOS.TXT
COMMAND: Copy Delete Format Gallery Help Insert Jump Library
Options Print Quit Replace Search Transfer Undo Window
Microsoft Word Version 4.0 (S/A 834899-488-8837786)
Pg1 Co58 ? CL Microsoft Word

```

Figure 2-1. Place the @PARAFILTR ON = code as the first line of a document to filter out double carriage returns between paragraphs.

Individual formatting in text files

Individual formatting falls into two categories. The first is text attributes: boldface, italics, underlines, etc., when applied to a few words within a paragraph. The word *italics* in this sentence is an example of individual formatting (if the entire paragraph was in italics, it would be considered global formatting). The second category is typographic characters. Ventura Publisher provides the capability to insert true typographic characters, including characters that don't appear on the computer keyboard, such as the em dash (—), the copyright symbol (©), and so on.

➔ *TIP: You can enter text attributes and typographic characters with Ventura, but it's faster with a word processor.*

Bracket codes

Some people use the search and replace to convert standard keyboard characters into true typographic characters. For instance, after typing the text file, they search and replace characters such as “ or — with the *bracket code* that represents true open (“) and closed (”) quotes and an em dash (—). When Ventura encounters the bracket code, it substitutes the correct typographic character and displays it on-screen.

Other people use keyboard macros instead of search and replace. They program the keyboard to insert the proper bracket codes as they go along. Thus, they might program the key combination Alt-C to insert the code <189>. When Ventura sees this bracket code, it inserts the copyright symbol (©) onto the page. Figures 2-2 and 2-3 show a coded paragraph from a word processor and the same paragraph in Ventura.

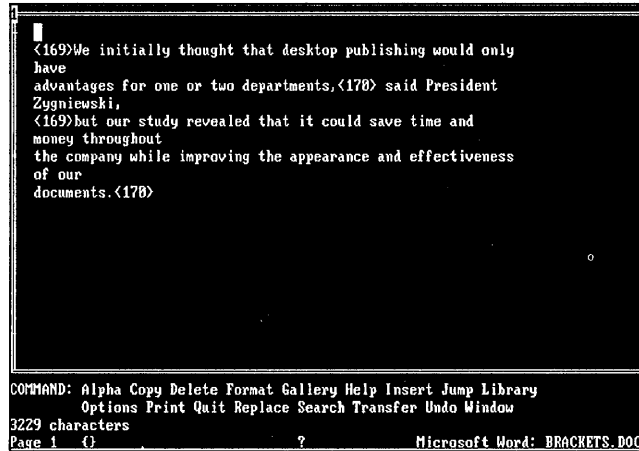

Figure 2-2. Bracket codes are used to insert true typographic characters in Ventura.

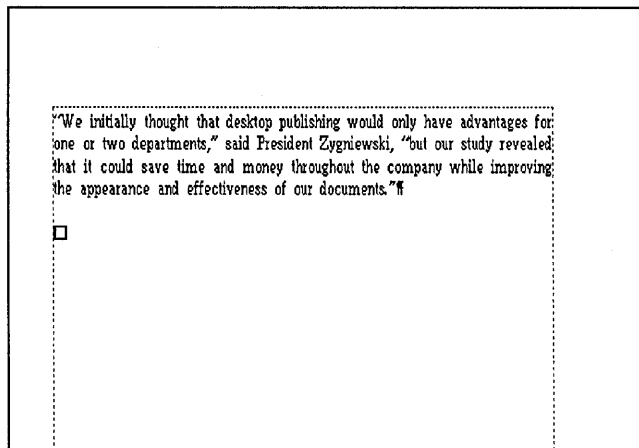

Figure 2-3. Ventura displays the bracket codes as true typographic characters.

Table 2-3 provides the proper substitutions and codes for the most common typographic characters not available from the keyboard, as well as their keyboard shortcuts (if any). You can use this table as a reference whether you use the search and replace method or the keyboard macro method.

Table 2-3 Common Typographic Characters

| Character | Symbol | Code | Keyboard Shortcut |
|---------------|--------|------|-------------------|
| open quote | “ | 169 | Ctrl-Shift-[|
| close quote | ” | 170 | Ctrl-Shift-] |
| em dash | — | 197 | Ctrl-] |
| en dash | - | 196 | Ctrl-[|
| copyright | © | 189 | Ctrl-Shift-C |
| registered | ® | 190 | Ctrl-Shift-R |
| trademark | ™ | 191 | Ctrl-Shift-2 |
| bullet | • | 195 | |
| cents symbol | ¢ | 155 | |
| pounds symbol | £ | 156 | |
| yen symbol | ¥ | 157 | |
| franc symbol | f | 159 | |
| section sign | § | 185 | |
| paragraph | ¶ | 188 | |
| ellipsis | ... | 193 | |
| degree symbol | ° | 198 | |

➔ *TIP: If you set Auto-Adjustments to “ and — in the Set Preferences dialog box (Options menu) Ventura will automatically convert all standard keyboard quotes (”) and hyphens (—) to true open and closed quotes and em dashes when it loads a text file.*

The next time you begin a project with Ventura, try preparing the text files with the guidelines we give in this chapter. Look through the text files in Appendix A for examples of how to prepare text in advance.

Planning the proposal

In the first chapter you prepared an in-house document. Now you will work on a document that you might send to a prospective customer outside your company.

The typical proposal serves as a sales document. Sometimes it goes to another department in the same company, or to upper management. Often, however, it is sent to customers. Since a proposal may go to the outside world, it must represent your company in the best light. The graphic design should work together with the words to reinforce the image your company wishes to project.

Although we kept our example short to conserve time and disk space, a real-life proposal may be many pages long. It may also incorporate graphics and/or financial tables. The document needs headers or footers for easy reference, plus captions to help readers correlate the visuals with the text.

Take a look at the “before” and “after” pictures of the proposal. Here are some of the effects you will work on in this chapter to improve its appearance:

- A separate title page
- A banner headline
- A two-column format to get more information on the page while enhancing readability
- A spreadsheet file integrated with the text

Before

Consulting Proposal to ABC Company

Project Description

XYZ Corporation proposes to advise ABC Company on all aspects of desktop publishing systems, including needs analysis, product and market surveys, specifications and purchase, and system implementation.

The initial short-term goal is to computerize the production of ABC's internal and external publications using personal computers and desktop publishing software. This short-term goal must be substantially completed before the end of ABC's fiscal year six months from now. The long-range objective is to integrate all of ABC's publications into a company-wide system with common procedures, databases and shared output devices.

Statement of Work

XYZ proposes to accomplish and complete this project in five phases, as described in more detail:

Phase One

Market Research. XYZ will analyze commercially available products for suitability. Phase One will culminate in an in-depth report outlining alternatives and recommendations.

Phase Two

Evaluate Needs. XYZ will gain an in-depth knowledge of ABC's computerization needs through on-site and telephone interviews. We will consider such areas as:

- Word processing and editorial requirements
- Graphics requirements
- Laser printer requirements
- Ease of learning and use
- Speed and throughput requirements

Phase Three

Installation. Once ABC makes its purchase decision, XYZ will oversee installation, setup and conversion. This will include integration of hardware, software and peripherals, plus the initial setup. Setup will include the creation of electronic formats, style sheets and document templates for reuse by ABC personnel.

Phase Four

Date Conversion. Once the system is installed, XYZ will supervise the conversion of current databases and publications to an electronic form. This will include the use of optical character recognition whenever possible to minimize the time and cost of data entry. Where it is not possible to optically read existing information, XYZ will supervise data entry personnel who will relay the data into the computers. XYZ will design and implement custom keyboard macro programs to facilitate data entry.

After

Consulting Proposal to ABC Company

XYZ Corporation

September 1, 1989

Consulting Proposal to ABC Company

Project Description

XYZ Corporation proposes to advise ABC Company on all aspects of desktop publishing systems, including needs analysis, product and market surveys, specifications and purchase, and system implementation.

The initial short-term goal is to computerize the production of ABC's internal and external publications using personal computers and desktop publishing software. This short-term goal must be substantially completed before the end of ABC's fiscal year six months from now. The long-range objective is to integrate all of ABC's publications into a company-wide system with common procedures, databases and shared output devices.

Statement of Work

XYZ proposes to accomplish and complete this project in five phases, as described in more detail:

Phase One

Evaluate Needs. XYZ will gain an in-depth knowledge of ABC's computerization needs through on-site and telephone interviews. We will consider such areas as:

- Word processing and editorial requirements
- Graphics requirements
- Laser printer requirements
- Ease of learning and use
- Speed and throughput requirements

Phase Two

Market Research. XYZ will analyze commercially available products for suitability. Phase One will culminate in an in-depth report outlining alternatives and recommendations.

Phase Three

Installation. Once ABC makes its purchase decision, XYZ will oversee installation, setup and conversion. This will include integration of hardware, software and peripherals, plus the initial setup. Setup will include the creation of electronic formats, style sheets and document templates for reuse by ABC personnel.

Phase Four

Date Conversion. Once the system is installed, XYZ will supervise the conversion of current databases and publications to an electronic form. This will include the use of optical character recognition whenever possible to minimize the time and cost of data entry. Where it is not possible to optically read existing information, XYZ will supervise data entry personnel who will relay the data into the computers. XYZ will design and implement custom keyboard macro programs to facilitate data entry.

ABC Proposal

Page 3

Ventura Prep



If you have the Power disk

For the purposes of this publishing project, we will assume that you have prepared a text file (2PROPOS.TXT) and a spreadsheet file (LOTUS.TXT) in accordance with the preformatting tips given in the theory section. (In actual fact, the sample text files on the Power disk have been preformatted for you.) Now they are ready to be loaded into the Assignment List.

Loading multiple files

In Chapter One you learned how to load one file at a time. Now we will show you how to load several files at once.

■ If you are continuing from the last project, select New from the File menu to clear the work space.

➔ *NOTE: You can only use the New option after you have opened an existing chapter. It is not available when you start Ventura for the first time. If you are starting from the DOS prompt, Ventura begins with an untitled chapter and you do not need to select New from the File menu.*

■ Select Load Text/Picture from the File menu.

■ Select Type of File: Text, Text Format: ASCII, # of Files: Several, Destination: List of Files, and OK.

■ If necessary, use the Backup button to find the C:\POWER subdirectory. Click on the diamond to go to the POWER subdirectory. The Directory line should read C:\POWER*.TXT. (If the Directory line reads differently, press ESC to clear the line, type C:\POWER*.TXT, and press Enter.)

Scroll through the listing until you see the file 2PROPOS.TXT. Select the file by double-clicking on the name or by typing the name on the Selection line and pressing Enter. This action loads it into the Assignment List.

After the first file is loaded, the Item Selector reappears and you can continue to load the next file.

- Scroll through the file listing again to locate the text file, LOTUS.TXT. To return to the document select the file name and choose OK, or double-click on the name, which has the same effect.
- Click OK to return to the work space.

► *NOTE: From this point on, when we ask you to select an item, use whichever selection method you prefer — typing the name on the selection line, double clicking, or clicking on the name and then OK.*

If the Page is selected when you load a file, Ventura immediately places the file on the Page. When you load several files at once, Ventura can't judge which files should be placed where, so it doesn't place any of them. When you are ready to place a file, first select the Page, then select the text file from the Assignment List.

Renaming the document files

We want you to get in the habit of renaming text files, style sheets, and chapters immediately to avoid making permanent changes to the originals. Start by renaming the text files.

To rename the text files, you must place them one at a time onto the Page. Once they are placed, use File Type/Rename to rename them and relocate them to a different subdirectory.

- Select the Underlying Page. When the sizing buttons are visible around the border of the Page, select the text file name LOTUS.TXT from the Assignment List.

Ventura places the text on the Page. Now rename and relocate the file.

- Select File Type/Rename from the Edit menu.
- Move to the New Name line, press ESC, and type:
C:\TEMP\TABLE.TXT Choose ASCII and OK (Figure 2-4).

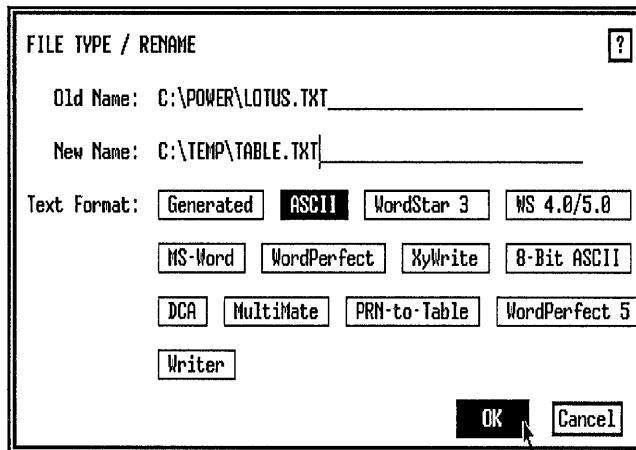

Figure 2-4.

The new file name, TABLE.TXT, appears in the Assignment List (Figure 2-5).

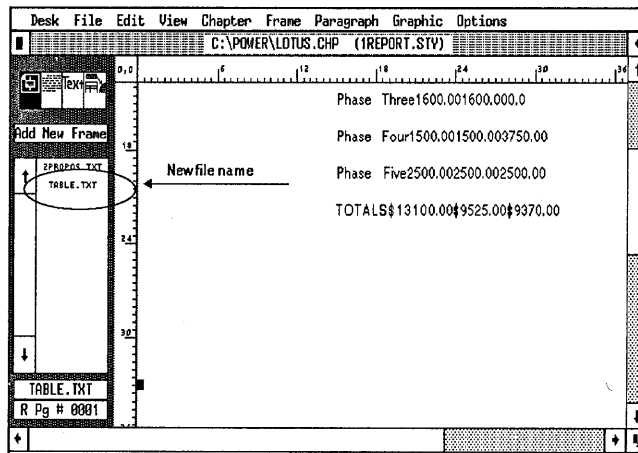

Figure 2-5.

Next you will remove the first file and place the second text file on the Page.

■ Select Remove Text/File from the Edit menu.

Ventura displays the file name, TABLE.TXT in the dialog box.

■ Choose Remove from: Frame and click OK.

➔ *TIP: You can also remove a file from the Page by selecting another file from the Assignment List. Ventura automatically replaces one text file with the other.*

Now place the proposal text on the Page.

■ Select the file name 2PROPOS.TXT from the Assignment List.

Rename the second text file.

■ Select File Type/Rename from the Edit menu.

■ Move to the New Name line, press ESC to clear the line, and type: **C:\TEMP\PROPOSAL.TXT**

■ Choose ASCII and OK.

Leave the file on the Page.

➔ *NOTE: File Type/Rename works for text files only. Use the DOS command Rename to rename picture files before or after the Ventura work session.*

Load and rename a style sheet

After renaming the two text files, load the style sheet.

■ Select Load Diff. Style from the File menu. Use the Backup button to locate the style sheet &PRPT-P1.STY in the C:\TYPESET subdirectory. Then load it into the document.

Now save the style sheet with a new name.

■ Select Save as New Style from the File menu. Locate the C:\TEMP subdirectory with the Backup button. At the Selection line type: **2PROPOS** and click OK.

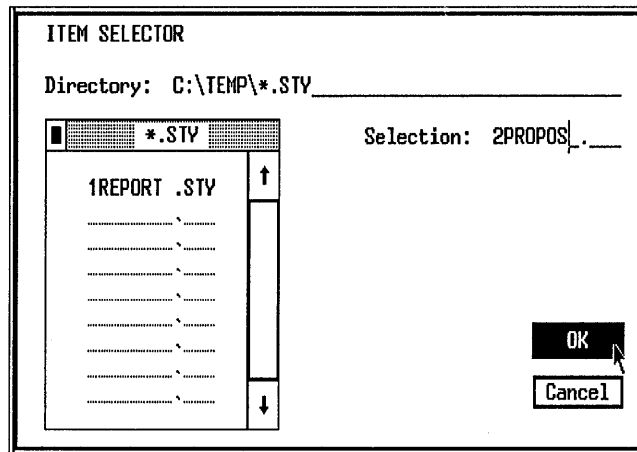

Rename and save the chapter

Now save the new chapter with the new text and style sheet.

- Select Save As from the File menu.
- Find the C:\TEMP subdirectory. Move to the Selection line and type: 2PROPOS. Click OK.



If you do not have the Power disk

- Use your favorite word processor to type in the two text files PROPOSAL.TXT and TABLE.TXT from Appendix A. Save them (or copy them) in the C:\TEMP subdirectory. Then follow the steps explained above to load the text files, and to load and rename the style sheet and chapter files.

➔ *NOTE: If you want, you can use any text file in place of the ones we include in Appendix A. However, it will be harder to follow along and match your screen with our sample illustrations unless you use the same text.*

Now that you've organized the chapter files, you are ready to begin. Where to start? As you know from the previous chapter, the Ventura Formula (Text + Style + Pictures = Chapter) helps with that question. As always, therefore, you will begin with text.

Text

Ventura's editing tools

Although it is usually easier to edit large sections of text with a word processor, Ventura provides a text editing toolkit for last-minute changes. You can cut, copy, and paste text or change the attributes of selected words within a paragraph.

Change text attributes

Before you begin, check to make sure the zero point is set correctly. Click once on the 0,0 square in the upper left corner of the Page. You may also want to use Normal or Enlarged View so you can easily position the text cursor.

■ Enable Text mode (click on the Text mode button in the Mode Selector). When you click on the work space, the mouse cursor turns into an "I-beam" (Figure 2-6).

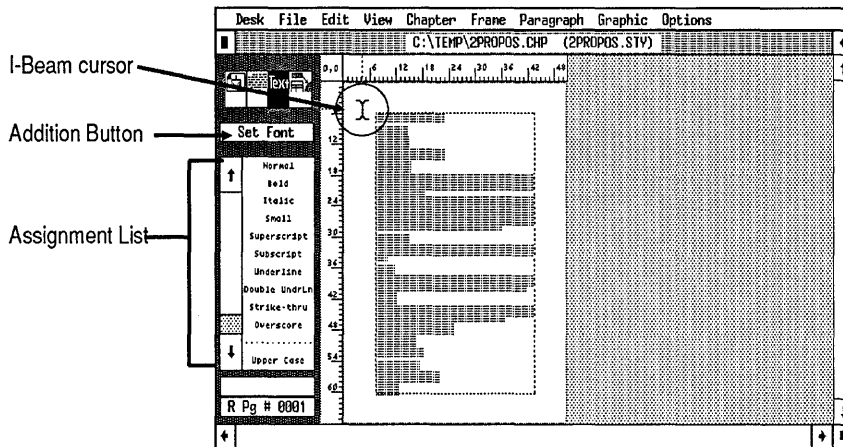

Figure 2-6.

When you enable Text mode, Ventura displays attributes — Normal, Bold, Italic, Small, and so forth — in the Assignment List and the words Set Font in the Addition Box.

In Chapter One you changed the font using Paragraph mode. But as you can see, Ventura also allows you to change text attributes in Text mode. What's the difference?

➔ *TIP: Use Text mode to change one or two words within a paragraph. Use a paragraph tag to change the text attributes of an entire paragraph.*

Let's use Ventura's text-editing tools to italicize several key words in the proposal. The italics will add emphasis and set them off from the rest of the paragraph. To italicize the text, first select the text then select the attribute.

■ Change to Normal (Ctrl-N) or Enlarged View (Ctrl-E).

■ Move the cursor in front of the "M" in the word "Market Research" near position 38 picas on the vertical ruler. Press and hold the mouse button as you drag the cursor to the end of the word "Research." The selected text appears in reverse video. Release the mouse button (Figure 2-7).

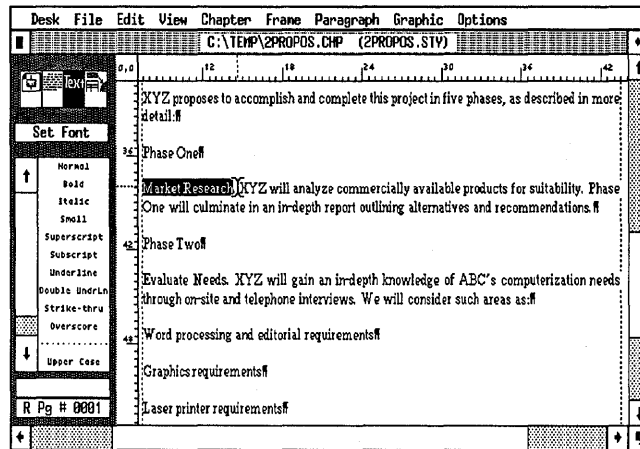

Figure 2-7.

➔ *NOTE: The traditional rule is not to italicize punctuation. Therefore, try not to select periods and commas when italicizing (or bolding) a phrase.*

Now make the text italic.

■ Select Italic from the Assignment List. The words "Attr. Setting" appear in the Current Selection Box (Figure 2-8).

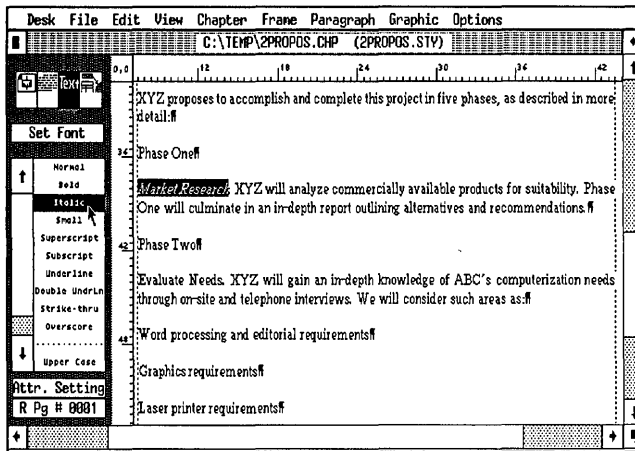

Figure 2-8.

The action you just took placed markers into the text file to turn the italics on and off. If you were to return now to the text file in your word processor, these markers would be visible as bracket codes (Figure 2-9):

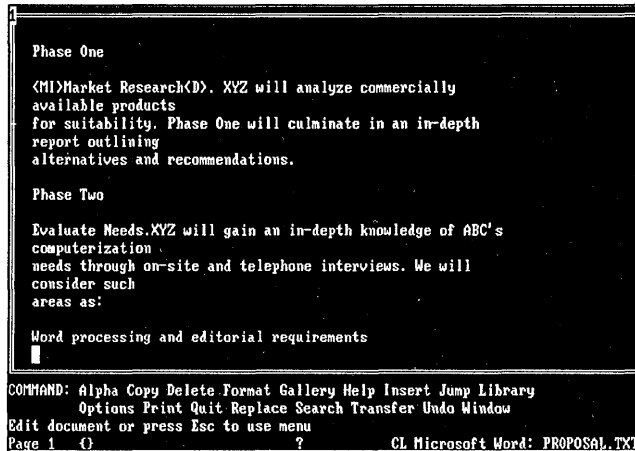

Figure 2-9.

In Ventura, however, the markers are invisible on the screen. Nevertheless, you can locate them using the left and right arrow keys and the Current Selection Box at the bottom of the Side-Bar.

➔ **NOTE:** Ventura places the hidden text attributes immediately before and after the word or phrase that was italicized, bolded, underlined, etc.

■ Place the cursor between the “M” and the “a” in Market Research and click once. Press the left arrow key on your keyboard several times until the words “Attr. Setting” appear in the Current Selection Box. This shows the location of the hidden marker.

➔ **NOTE:** To remove the text attributes, select the text then select Normal from the Assignment List. Or, use the arrow key to find the hidden marker (the words “Attr. Settings” appear in the Current Selection Box) and press the Del key.

Dragging the mouse is one way to select text. However, there is a more accurate way called the “Shift-Click” method.

■ Place your text cursor before the “E” of “Evaluate Needs” (two paragraphs down from “Market Research” near position 44 picas on the vertical ruler) and click once. *While holding down the Shift key*, move the text cursor to the end of the phrase (after the “s”) and click again. Now release the Shift key.

■ Now select Italic from the Assignment List.

➔ **NOTE:** You can change the amount of text selected by moving the cursor to another position and clicking again while holding down the Shift key. You can move forward or backward.

■ Press PgDn to go to the next page and scroll to the top of the page.

■ Use the Shift-Click method to select the three following phrases and make them italic as explained above: “Installation,” “Data Conversion,” and “Training and Implementation.”

When you are finished applying text attributes, your screen should look like Figure 2–10:

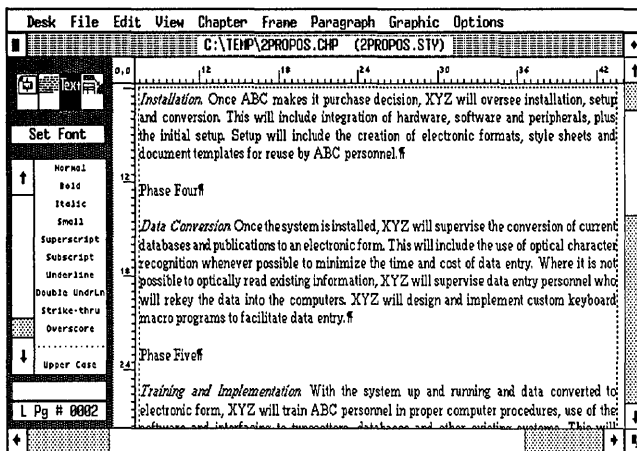

Figure 2-10.

Edit text

Now use Ventura's cut and paste tools to rearrange the copy in the proposal. It works like this: First you select the text you want (by dragging or by using the Shift-Click method). With the text highlighted, you then select Cut Text or Copy Text from the Edit menu. After you cut or copy text, Ventura stores it in temporary memory, called the Text Clipboard. To insert text from the Clipboard onto the page, select Paste Text from the Edit menu.

➔ **TIP:** Use keyboard shortcuts to speed text editing. Press *Del* to cut, press *Shift-Del* to copy, and press *Ins* to paste.

■ Press *PgUp* or *Home* to go back to page one. Select the paragraph starting with "Market Research" as shown below. Make sure you include the end of paragraph mark (¶) in the text selection by dragging the cursor down to the beginning of the next paragraph (Figure 2-11).

➔ **NOTE:** If the paragraph symbol is not displayed on-screen, select *Show Tabs & Returns* from the Options menu (or press *Ctrl-T*).

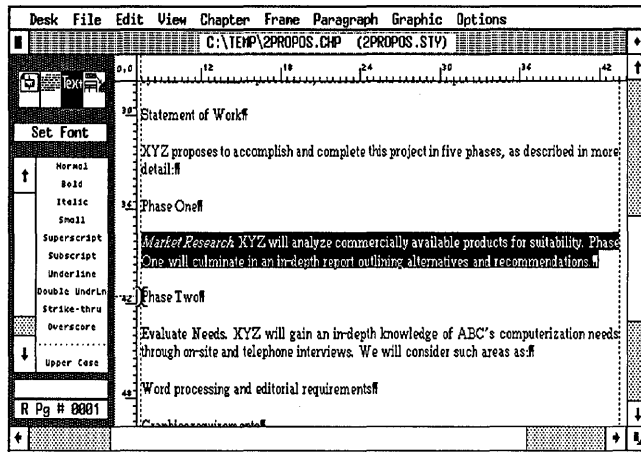

Figure 2-11.

■ Press the Del key.

➔ **NOTE:** If you delete the wrong text, press the Ins key immediately to paste the text back on the page. Then try again.

The text is cut from the document and placed on the Clipboard. Now you can paste it into a new location:

■ Place the cursor before the word "Evaluate." Click the cursor once.

■ Press the Ins key (Figure 2-12).

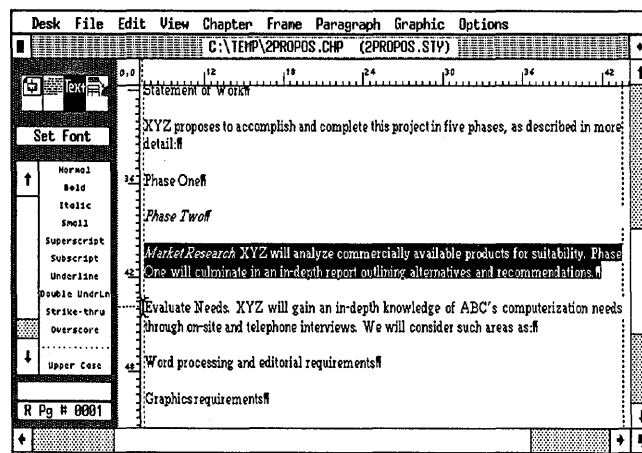

Figure 2-12.

➔ **NOTE:** Text remains in the clipboard until something else is cut or copied.

- Select the text starting with “Evaluate Needs” and ending with “Speed and throughput requirements” as shown in Figure 2–13. (Be sure to include the end of paragraph mark in your selection. If you have trouble, move the cursor down below the line and to the beginning of the next paragraph.)

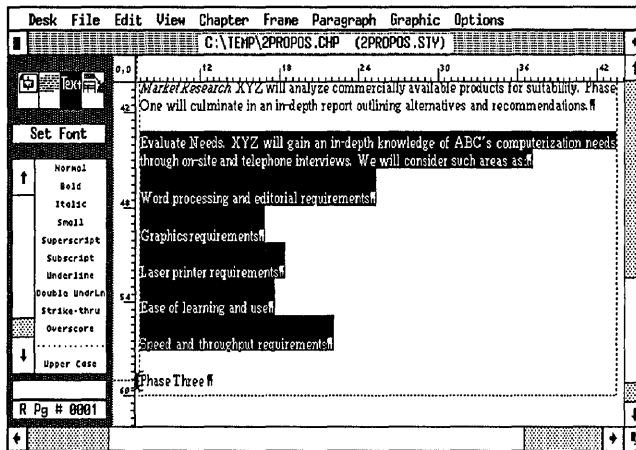

Figure 2–13.

- Press the Del key.

Now paste the text back into the document below the paragraph “Phase One.”

- Place the cursor in front of the “P” of “Phase Two” and press Ins.

After you rearrange the text, click once anywhere on the work space to deselect the text. Your screen should look similar to Figure 2–14:

➔ **NOTE:** Do not be concerned if the italics change or disappear during cut and paste. Sometimes when you move text in a document, you also move a text attribute. Use Normal and Italic from the Assignment List to get the text looking the way you want again.

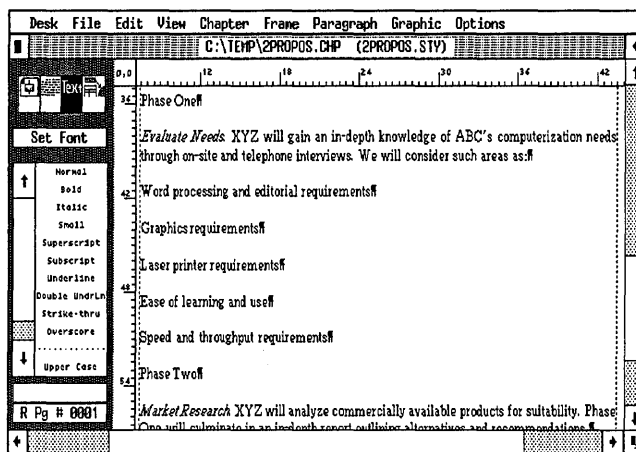

Figure 2-14.

Nice work. With just a little practice, you've learned the basics of text editing.

Style

You will begin the style portion of this project by completing the chapter layout. Then you will add tags to a style sheet and use a special tag named Page Break to isolate text on a page. These steps may save you some of the mistakes and confusion we experienced as first-time Ventura users.

Page layout strategy

Let's take a moment to review the formatting strategy we introduced in Chapter One, a strategy that helps you stay on course when working on the style of a document. First you make the global changes to the chapter. Then you tag individual paragraphs, starting with Body Text. As you make changes, you step through the menus from left to right, and from top to bottom.

Change the page layout

- Select Page Size & Layout from the Chapter menu. Choose Sides: Single and Start On: Right Side. Click OK.

Build the footer

Next, build a footer that includes the name of the proposal and the page number.

- Select Headers & Footers from the Chapter menu.
- Choose Define: Right Page Footer, Usage: On. Move to the Left line and type: **ABC Proposal**
- Move to the Right line and type: **Page** followed by a space. Then choose the Inserts: Page # button. The [P#] code appears on the line, instructing Ventura to insert page numbers in the footer. Click OK to close the dialog box.

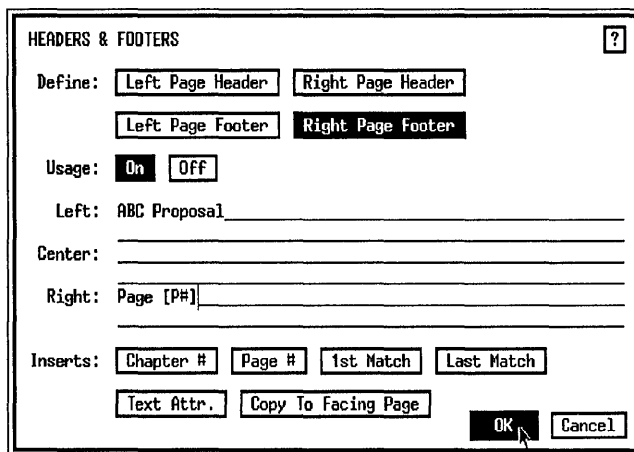

Now turn off the footer for the first page only.

- Verify that you are on page one. If not, press Home.
- Select Turn Footer Off from the Chapter menu.

Change to two-column format

After making the footer, you're ready to change the page margins and columns. As we explained earlier, a two-column page layout lets you fit more text on a page and enhance its readability. When you change from one to two-column format, watch how easily Ventura reflows the text.

- Enable Frame mode.

- Click the cursor anywhere on the work space to select the Underlying Page.
- Select Margins & Columns from the Frame menu. Choose # of Columns: 2. Make the top and bottom margins 06,00 picas & points and the left and right margins 07,06 picas & points. *Do not* press OK yet.

After you set the page margins, you enter the column and gutter widths. To make the columns equal widths, enter the first column width, then enter the gutter width (the space between columns), then choose Make Equal Widths. Do things in this order to ensure that Ventura accurately calculates the columns.

- ➔ *NOTE: The Make Equal Widths button does not stay highlighted after you choose it.*
- Move to the Column 1 line, press Esc to clear the line, and type: 1700
- Move to the first line of the Gutters column, press Esc and type: 0200
- Choose Make Equal Widths. Click OK.

MARGINS & COLUMNS ?

of Columns:

Settings For:

| | Widths | Gutters | Margins |
|-----------|--------|---------|----------------------------|
| Column 1: | 17,00 | | Top: 06,00 picas & points |
| 2: | 17,00 | 02,00 | Bottom: 06,00 |
| 3: | 00,00 | 00,00 | Left: 07,06 |
| 4: | 00,00 | 00,00 | Right: 07,06 |
| 5: | 00,00 | 00,00 | |
| 6: | 00,00 | 00,00 | |
| 7: | 00,00 | 00,00 | |
| 8: | 00,00 | 00,00 | |
| | | | Calculated Width = 51,00 |
| | | | Actual Frame Width = 51,00 |

Inserts:

Turn column balance on

To balance the text in adjacent columns, turn Column Balance on in the Chapter Typography dialog box. Without Column Balance on, Ventura fills the first column with text before starting the second. With Column Balance on, Ventura fills both columns equally. (You will notice the effects of column balance on page two.)

- Select Chapter Typography from the Chapter menu. Choose Column Balance: On and click OK.

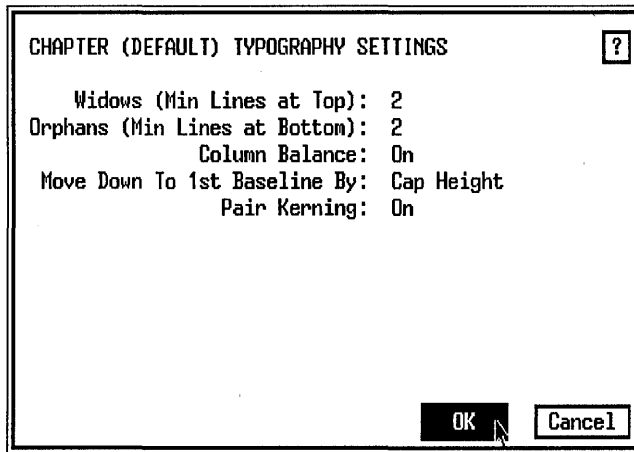

Modifying individual tags

Since there are no more overall changes to make, you can begin to tag individual paragraphs. Start with Body Text, because its inter-line spacing is the basis for all other tags. Once you complete Body Text, proceed systematically through the document from top to bottom. You can achieve most of the effects you want with the Font, Alignment, and Spacing options in the Paragraph menu. In this section, you will build up your tagging repertoire by learning about the Breaks menu. But first let's modify the Body Text tag.

Change the Body Text tag

The only change you need to make to Body Text is in the Alignment dialog box.

- Enable Paragraph mode.
- Select the paragraph that begins “XYZ Corporation proposes to advise...” (Figure 2-15).

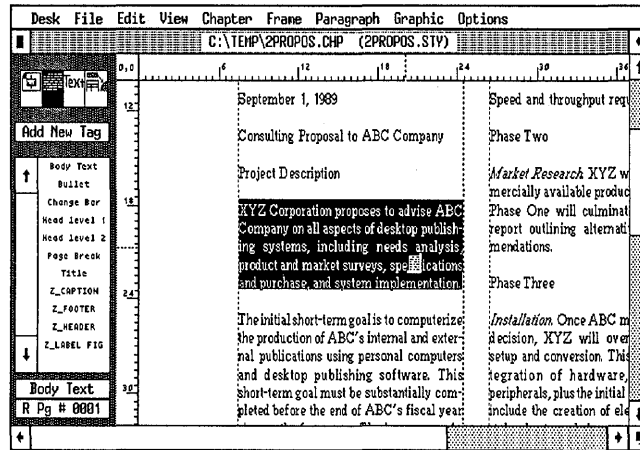

Figure 2-15.

The tag name Body Text appears in the Current Selection Box. Make the following changes:

- Alignment

In/Outdent Width: 01,00 picas & points

➔ *NOTE: Ventura measures indents from the left margin of the column, not the left edge of the page.*

- Spacing

Inter-Line: 14.00 fractional pts

Inter-Paragraph: 00.00 fractional pts

Change the tags on the title page

Now that you've finished changing the Body Text tag, you can change the other tags on the title page of the proposal.

- Select the first paragraph “Consulting Proposal to ABC Company” and tag it as Title (Figure 2-16).

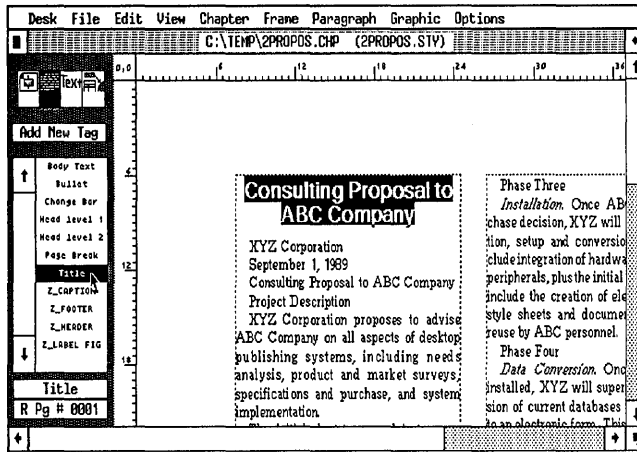

Figure 2-16.

➔ *TIP: If you tag the wrong paragraph, just retag it as Body Text and select again.*

The current format of the Title tag is part of the original style sheet you loaded at the beginning of this project. Now you will modify its design to better suit the new page design. You will make the Title tag stand out on the page by centering it frame-wide, enlarging its type size, and adding extra space above and below. When you are finished the paragraph will look like Figure 2-17.

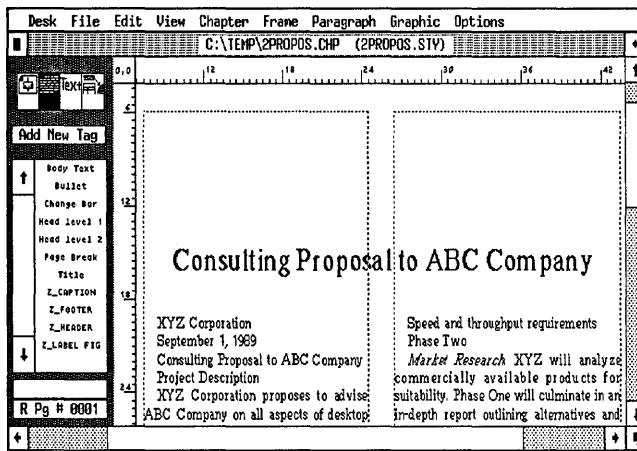

Figure 2-17.

- | | |
|-------------|--|
| ■ Font | Face: Times Size: 024.0 points |
| ■ Alignment | Overall Width: Frame-Wide |
| ■ Spacing | Above: 98.00 fractional pts Below: 28.00 fractional pts Inter-Line: 28.00 fractional pts |

A note about spacing: In Chapter One we said that (1) you should avoid using Inter-Paragraph spacing and (2) you can do without Below spacing about 75% of the time. The Title tag, however, is an exception to the rule. Because it is a banner headline — a headline that stretches across two or more columns — it usually requires extra space below to separate it from the following text.

After changing the attributes of the Title tag, apply it to the next paragraph.

- Select the paragraph “XYZ Corporation” and tag it as Title (Figure 2-18).

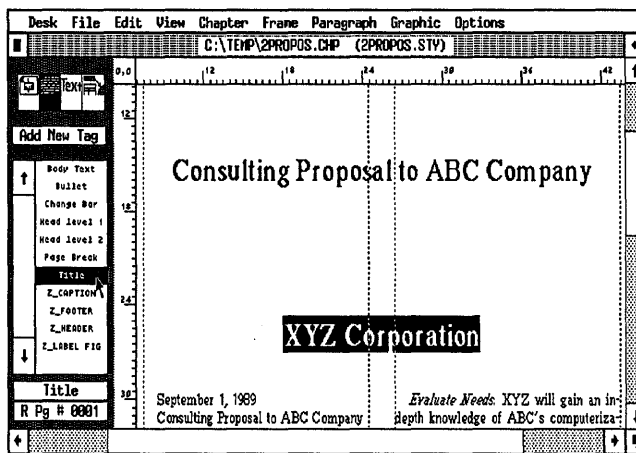

Figure 2-18.

Add a new tag

The next paragraph to tag is the date. To make it better match the Title tag, you will center it frame-wide and make it 12-point Times Bold. Since there are no tags in the Assignment List with these attributes, you will add a new tag.

To make a new tag, Ventura copies the attributes from an existing tag to the new one. Then you add or subtract attributes to the new tag name until you get the right effect. Here are the steps to add a new tag.

1. Enable Paragraph mode.
2. Select a paragraph with attributes similar to the tag you want to add.
3. Select Add New Tag from the Side-Bar.
4. Type in the name of the new tag.
5. Go through the Paragraph menus and add or subtract attributes to achieve the right effect.

Don't worry if this sounds confusing at first. You will get the hang of it as soon as you work through a few examples. So let's get started. Create a tag named "BodyCenter" and apply it to the date paragraph.

- Select the paragraph "September 1, 1989."
- Select Add New Tag from the Side-Bar.
- Move to Tag Name to Add and type: **BodyCenter** and click OK to close the dialog box.

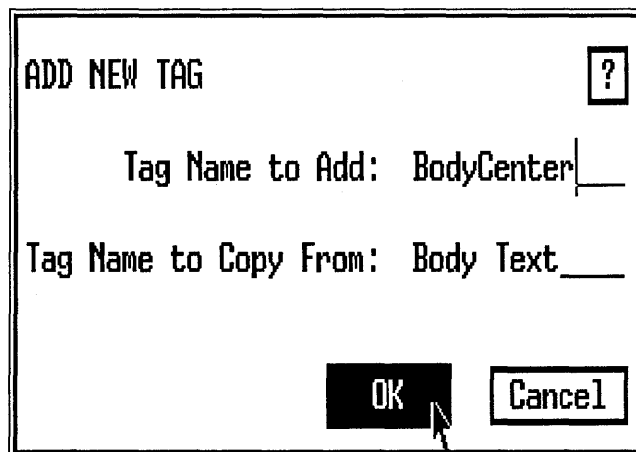

Ventura copies the attributes of Body Text — its Font, its Alignment, its Spacing, etc. — to the new tag.

Modify the new tag

Now that you've added a new tag, you can change its attributes. Simply work through the Paragraph menu from top to bottom until you achieve the right effect.

| | |
|-------------|--|
| ■ Font | Style: Bold |
| ■ Alignment | Horz. Alignment: Center Overall Width: Frame-Wide In/Outdent Width: 00,00 picas & points |
| ■ Spacing | Add in Above: When Not at Column Top |

Add a page break

With the first three paragraphs tagged, the title page is complete. Now you must separate the title page text from the rest of the document. To do this you use a special Page Break tag. The Page Break tag includes a *Page Break: After* (Breaks menu) that pushes everything after it onto a new page. The Page Break tag was already defined in the original style sheet with the Breaks options from the Paragraph menu.

Here's how to use the Page Break tag to create a separate title page.

Make sure that Show Tabs & Returns is turned on from the Options menu (the menu will read "Hide Tabs & Returns"). This allows you to see an on-screen display of all the text symbols (tabs, returns, line breaks, etc.).

- Enable Text mode. Place the text cursor after the "9" in the word "1989." The words "Paragraph End" appear in the Current Selection Box. Now press the Enter key once. This action creates an empty paragraph, that is, a paragraph containing an end of paragraph symbol (¶) and no text (Figure 2-19).

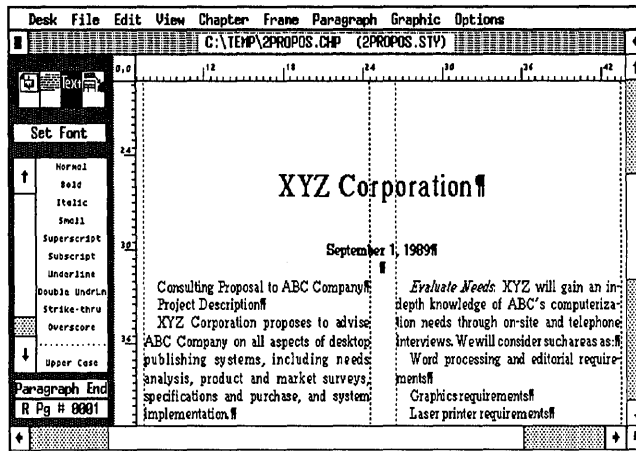

Figure 2-19.

➔ *TIP: You can apply tags to empty paragraphs as well as to text.*

Now tag the empty paragraph as Page Break, just as you would tag any other paragraph.

■ Enable Paragraph mode.

■ Select the empty paragraph (click on the ¶ symbol) and tag it as Page Break (Figure 2-20).

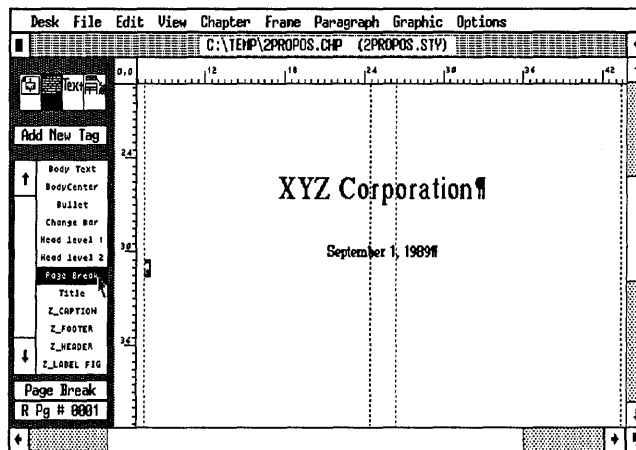

Figure 2-20.

The remaining text is pushed on to the second page. To understand this effect, leave the empty paragraph highlighted and

select Breaks from the Paragraph menu. There you see that the Page Break: After option was specified (Figure 2-21).

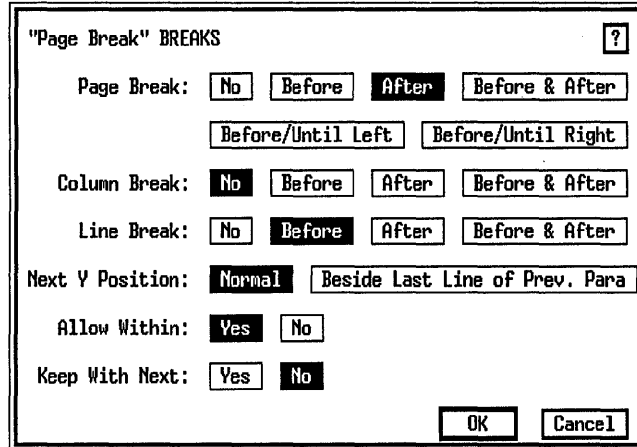

Figure 2-21.

The page break effect is an important one. Use the Page Break tag whenever you want to start text on a new page. Try to avoid the common mistake of entering a string of carriage returns to force text to another page (Figure 2-22).

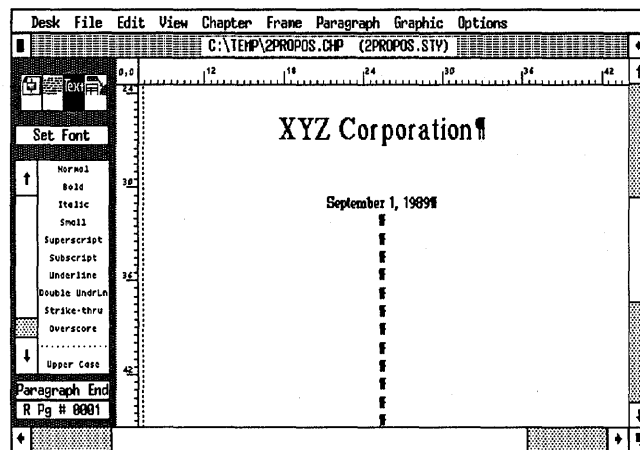

Figure 2-22. Wrong. To create a page break, use a page break tag — not a string of carriage returns.

This is *not* the right way to make a page break. If you later add text, or change the attributes of a tag, some of the extra carriage returns will “float” onto the next page causing every-

thing in the document to be pushed out of place. Remember to use the Page Break tag instead.



Stopping point

You have finished page one and reached a stopping point for Chapter Two. Continue on to page two if time permits. If not, you may wish to save the chapter, then print out page one. Check that your document matches Figure 2-23.

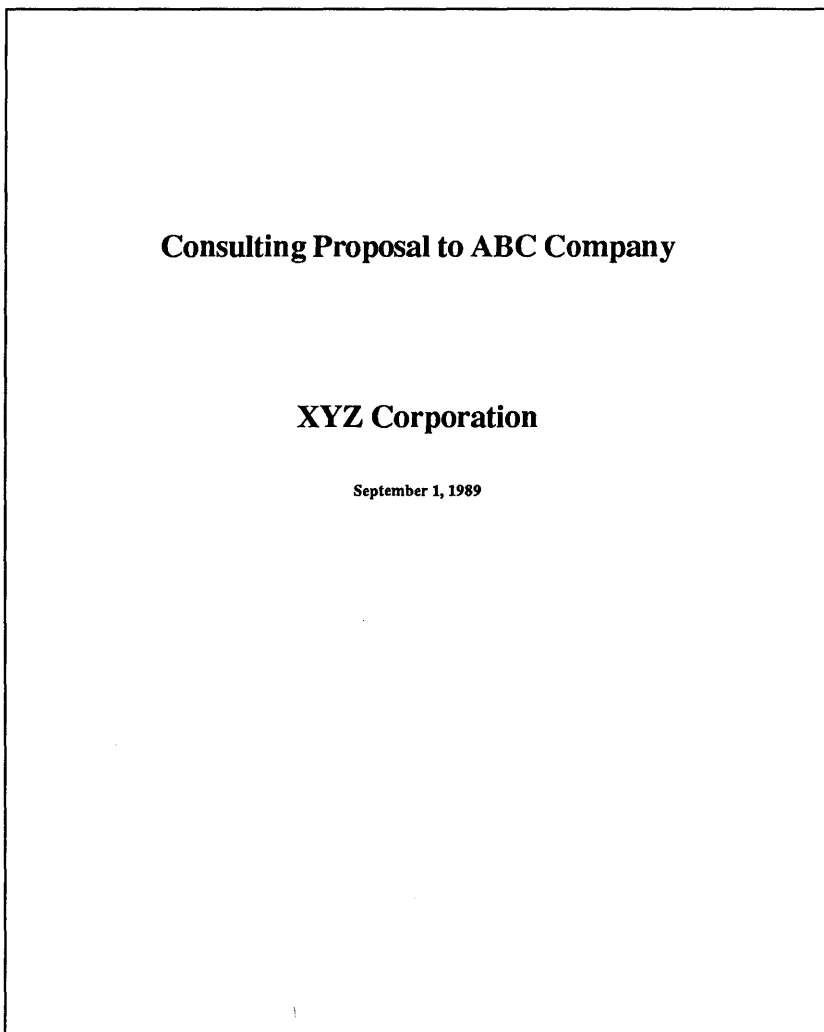

Figure 2-23.

Apply a tag to multiple paragraphs

If you are beginning fresh, open the chapter C:\TEMP\2PROPOS.CHP and start from where you left off.

Go to page two to continue tagging.

- Press PgDn to go to page two
- Tag the paragraph “Consulting Proposal to ABC Company” as Title.

Next you will change the Head level 1 tag. Since there are several Head level 1 tags on the same page, you can use the “Shift-Click” selection method to tag multiple paragraphs at one time.

- Select the paragraph “Project Description.”
- While holding down the Shift key, select the paragraph “Statement of Work.” Tag both paragraphs as Head level 1 (Figure 2–24).

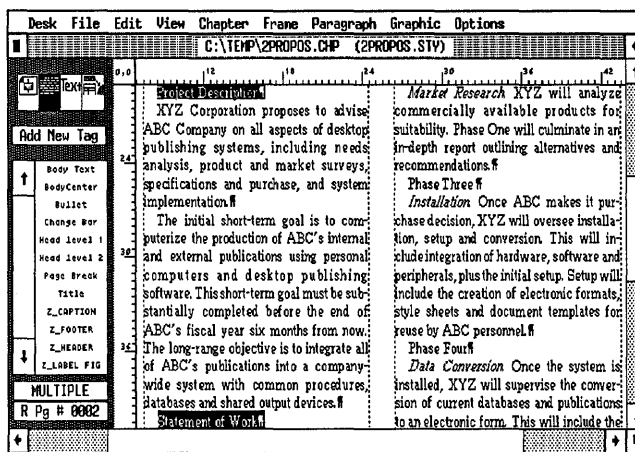
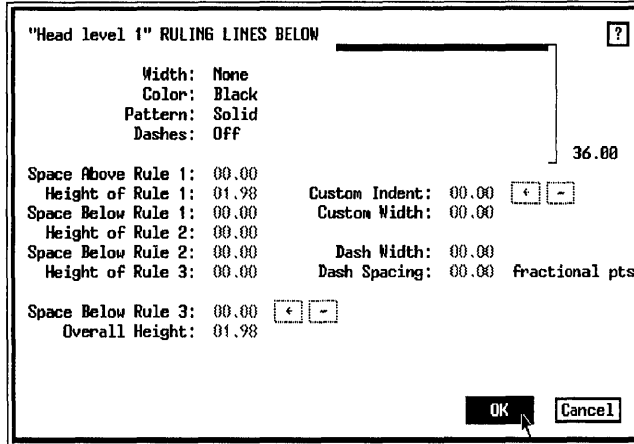

Figure 2-24.

Change the Head level 1 tag

With the two paragraphs still highlighted, change the tag. First remove the ruling line below that was specified in the original style sheet, then change its Font, Alignment, Spacing, and Breaks.

- Select Ruling Line Below from the Paragraph menu. Choose Width: None and click OK.



- Font Face: Times
Size: 018.0 points
- Alignment Horz. Alignment: Center
- Spacing Above: 28.00 fractional pts
Inter-Line: 28.00 fractional pts
Add in Above: When Not at Column Top

When you are finished, the tag should look like Figure 2-25:

To keep Head level 1 from becoming isolated at the bottom of

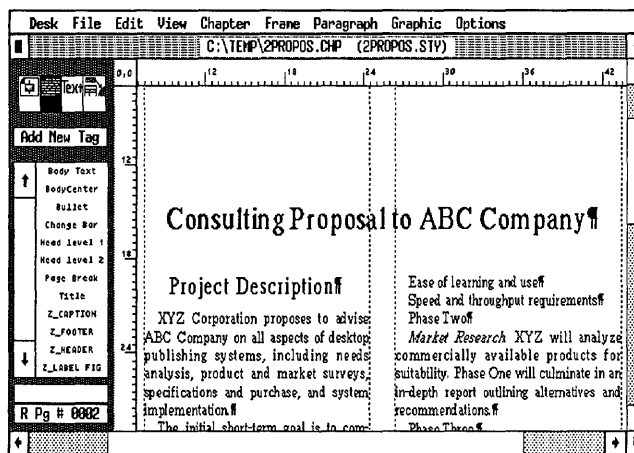
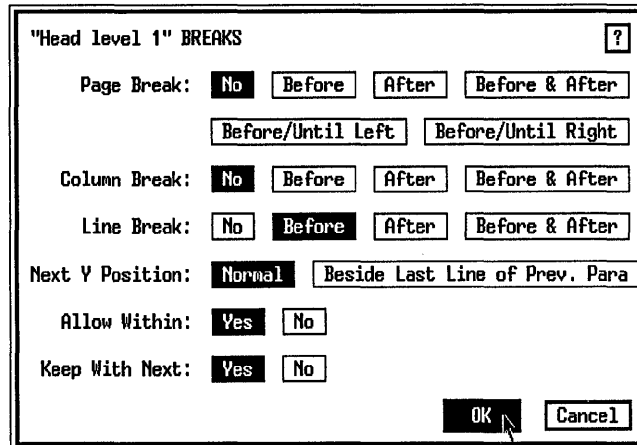

Figure 2-25.

a column or page, use the Breaks option **Keep With Next**. **Keep With Next** guarantees that a tag stays next to the paragraph that follows it.

- Select **Breaks** from the **Paragraph** menu. Choose **Keep With Next: Yes** and click **OK**.



- ➔ **NOTE:** *Headlines, headings, and subheads should have **Keep With Next** set to **Yes** to keep them from becoming isolated at the bottom of a page or column.*

The Head level 2 tag

Now tag each paragraph on page one that begins with the word “Phase” as Head level 2. You may want to change to **Reduced View** so that all four paragraphs are visible at once.

- Select the first paragraph “Phase One.” Then use **Shift-Click** to select the paragraphs, “Phase Two,” “Phase Three,” “Phase Four,” and “Phase Five” (Figure 2-26). Tag them as Head level 2. (If you select the wrong paragraph, simply click on it again to deselect it.)

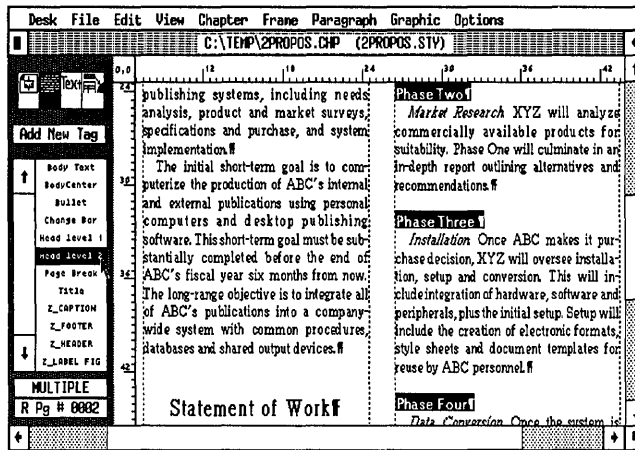

Figure 2-26.

➔ **NOTE:** Because of the above spacing in the Head level 2 tag, the phrase “Phase Five” will move to the next page as soon as it is tagged.

Change Head level 2 tag

Now change the attributes of the Head level 2 tag.

- Font Face: Times
- Spacing Above: 14.00 fractional pts
Inter-Line: 14.00 fractional pts
Add in Above: When Not at Column Top

Like Head level 1, Head level 2 includes a Break: Keep With Next to prevent it from becoming isolated at the bottom of a page or column.

- Breaks Keep with Next: Yes

Check that the tag you just completed looks like Figure 2-27.

Select the Bullet tags

The next tag you encounter is the Bullet tag. You will make the bullet size larger and you will reduce the Above and In From Left Spacing.

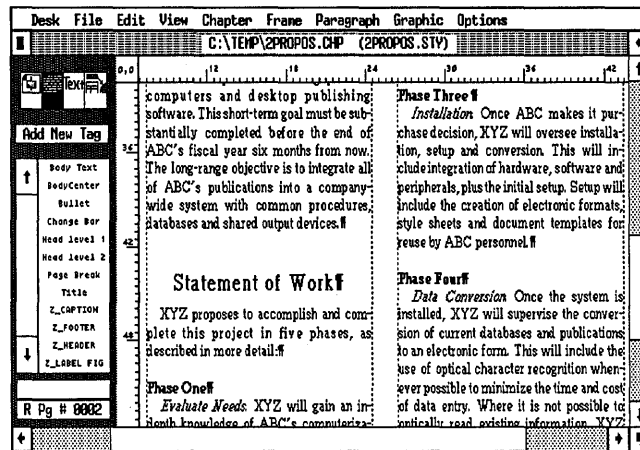

Figure 2-27.

- Select the following five bullet paragraphs using the Shift-Click method and tag them as Bullet.

“Word processing and editorial requirements”

“Graphic requirements”

“Laser printer requirements”

“Ease of learning and use”

“Speed and throughput requirements”

➡ *TIP: As long as you keep the Shift key depressed, you can scroll up and down the page to select multiple paragraphs. Select the first bullet at the bottom of the first column, hold down the Shift key, then scroll to the top of the second column and select the rest of the bullets.*

Change the Bullet tag

With the paragraphs still highlighted, you can change the attributes.

- Spacing

Above: 00.00 fractional pts

Below: 00.00 fractional pts

Inter-Line: 14.00 fractional pts

Add in Above: When Not at Column Top

In From Left: 01,00 picas & points

➔ **NOTE:** If you tend to confuse Spacing/In From Left with Alignment/Indent, remember this rule of thumb: Alignment/Indent affects only the first few lines of a paragraph. Spacing/In From Left affects every line.

☒ Breaks Keep With Next: No

Setting the Keep With Next option to No allows Ventura to split a list of bullets across a column or a page. Otherwise, if the list is too long, Ventura pushes all the bullets to the next column or page, leaving a big, empty gap in the document.

Increase the Bullet size

To change the size of the bullet itself, use the Special Effects dialog box in the Paragraph menu.

☒ Select Special Effects from the Paragraph menu. Choose Set Font Properties.

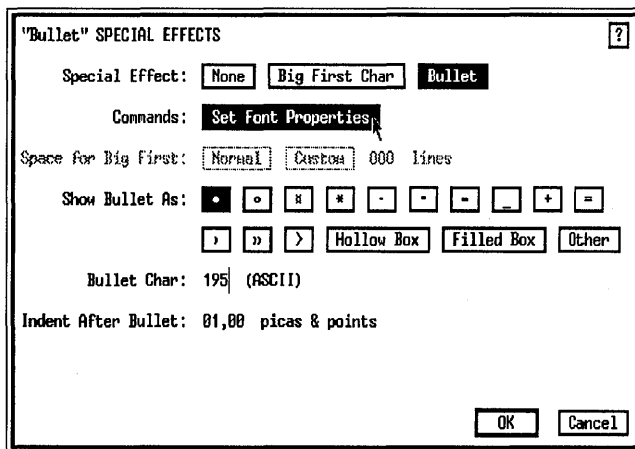

The Set Font Properties dialog box looks familiar, doesn't it? It's the same Font dialog box you've seen before. You simply got here a new way. The changes you make in this dialog box will affect *only* the bullet, not the rest of the paragraph.

☒ Enter Size: 014.0 points. Then click OK to return to the Special Effects dialog box. Click OK again to complete the effect and return to the document.

Change the Footer tag

Footers are among the special tags that Ventura creates on its own called “generated” tags. These tags are given names that begin with the letter Z (for instance, Z_HEADER for the header, Z_FOOTER for the footer, and so on) to distinguish them from others in the Assignment List. As with all tags, you can change the attributes of a generated tag simply by working through the options in the Paragraph menu. Let’s change the font of the Z_FOOTER tag so it matches the rest of the proposal.

➔ **NOTE:** If you do not see any generated tags in the Assignment List, check to make sure that *Generated Tags: Shown* is selected in the *Set Preferences* dialog box in the *Options* menu.

■ Select the footer on page two.

■ Font
 Face: Times
 Style: N-Italic
 Size: 010.0 points

When you are finished, the footer should look like Figure 2-28:

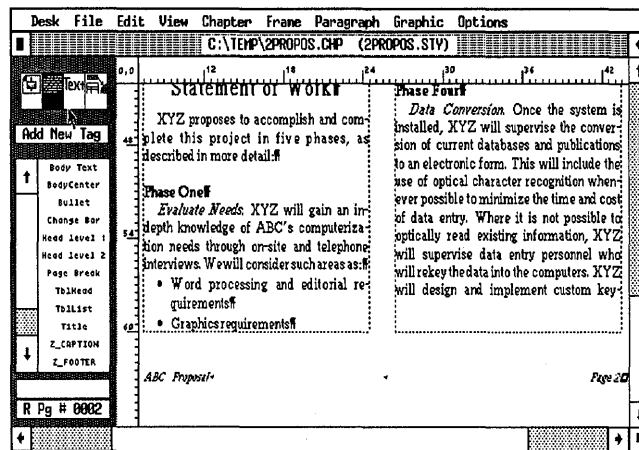

Figure 2-28.

Finish tagging the document

After you change the footer, finish tagging the remaining paragraphs in the document.

- Press the End key to go to the last page of the document.
- Tag the paragraph “Project Costs” as Head level 1.

Pictures

Now that you’ve completed the text and style sections of this project, let’s continue with pictures.

To add a picture to a document, you load a picture file and place it in a frame. You can make a frame any size or shape to fit with the page design and the artwork.

In Chapter One, you added a frame to hold a picture. However, frames can also contain text. One common example is a spreadsheet file. Instead of retyping a worksheet from scratch, you can load it into Ventura and place it in a frame. Once you have it in the frame, you can format it into a table. In this section, you will learn how to place and format a simple spreadsheet file.

For this project, you will place and format the TABLE.TXT file from the Power disk, which has already been prepared for you. If you don’t have the Power disk, you can type in the file from Appendix A.

Add the frame

Before you place a text file, you must add a frame to contain it.

➔ *NOTE: Placing text files in frames allows you to place several different text files on the same page.*

To make frame placement easier, make sure Column and Line Snap are turned on (Options menu). If they are on, the Options menu will read “Turn Column Snap Off” and “Turn Line Snap Off.” These snap-to functions ensure that frames align with the margins and the inter-line spacing of Body Text.

- Go to page three.

- Switch to Reduced View (press Ctrl-R). Then make sure you reset the zero point to the upper left corner of the Page (click once on the 0,0 square).
- Enable Frame mode.
- Select Add New Frame from the Side-Bar.
- Starting at position 29 picas on the vertical ruler, place the upper left corner of the frame next to the left margin. Then hold down the mouse cursor until it turns into a pointing hand.
- While holding down the mouse button, drag the lower right corner of the frame downwards and to the right. When the bottom of the frame aligns with the right margin of the page and reaches about 50 picas on the vertical ruler, release the mouse button (Figure 2-29). Don't worry about exact placement yet.

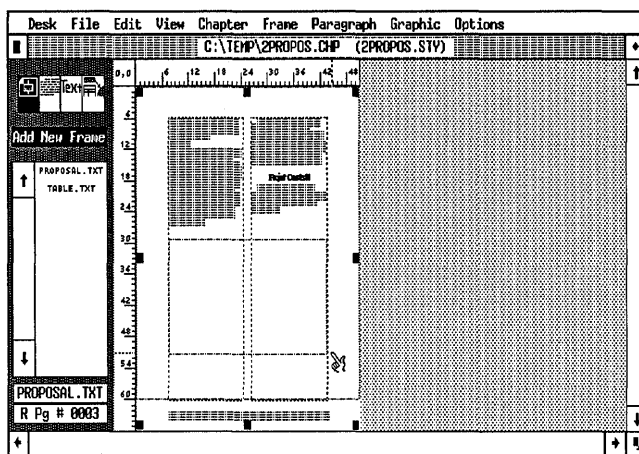

Figure 2-29.

Resize the frame

Now that you put the frame in the approximate position, you can fine-tune its placement. The Sizing & Scaling dialog box allows you to precisely control the placement and size of frames. The dialog box uses the terms “Upper Left X” and “Upper Left Y.” Upper Left X shows the horizontal distance from the edge of the page to the upper left corner of the frame.

Upper Left Y shows the vertical distance from the edge of the page to the upper left corner of the frame (Figure 2-30).

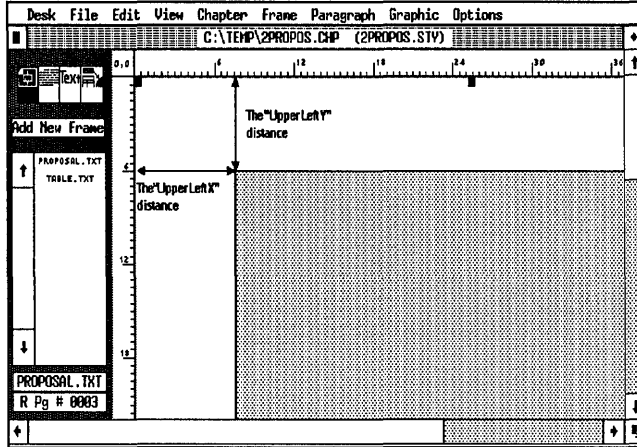
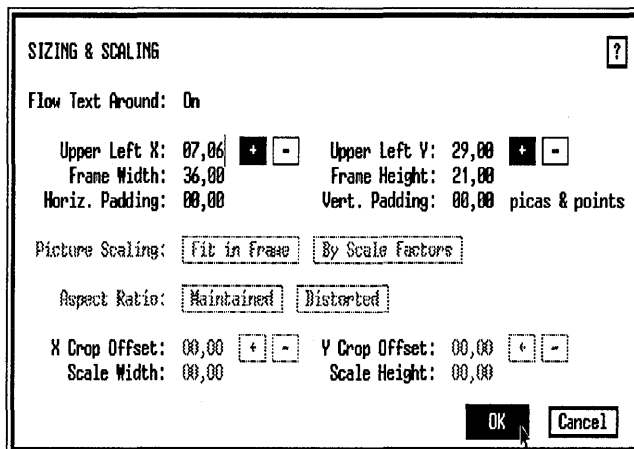

Figure 2-30. Upper Left X is the horizontal distance from the edge of the page to the upper left corner of the frame. Upper Left Y is the vertical distance.

- Select Sizing & Scaling from the Frame menu. Make sure the unit measurements are set to picas & points. Make the Upper Left X: 07,06 picas & points (if this is not the current value, press Esc to clear the line and type in 07,06 picas & points). Make the Upper Left Y: 29,00 picas & points. Make the frame width 36,00 picas & points and the frame height 21,00 picas & points.



Place the spreadsheet file

After you position and size the frame, place the sample spreadsheet file.

- Switch to Normal View (press Ctrl-N).
- With the frame still highlighted, select the text file name TABLE.TXT and place it in the frame (Figure 2-31).

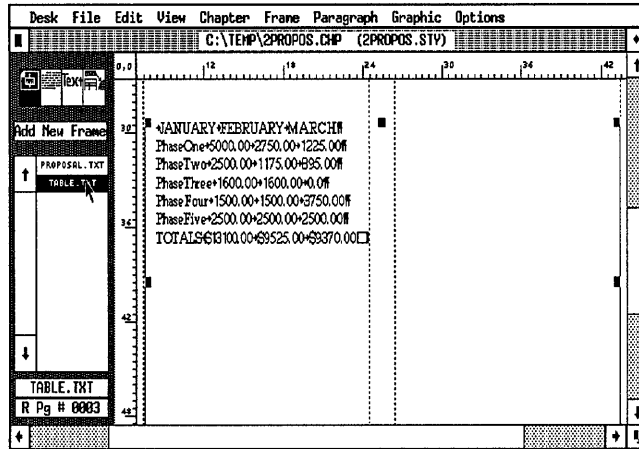

Figure 2-31.

Add margins to the frame

To center the spreadsheet text within the frame, add margins to the frame. These margins will affect only the selected frame. *They will not affect the Underlying Page beneath the frame.*

➔ **NOTE:** Frames that you place on top of the Page can have their own margins and columns, independent of the Page.

- Margins & Columns
 - Top: 02,00 picas & points
 - Bottom: 02,00 picas & points
 - Left: 02,00 picas & points
 - Right: 02,00 picas & points

Place a box around the frame

Next visually separate the frame from the above text by making a ruling box around the frame.

- Select Ruling Box Around from the Frame menu.
- Choose Width: Frame. Make sure the unit measurements are set to fractional pts. Give Rule 1 a height of 00.50 fractional pts. Click OK.

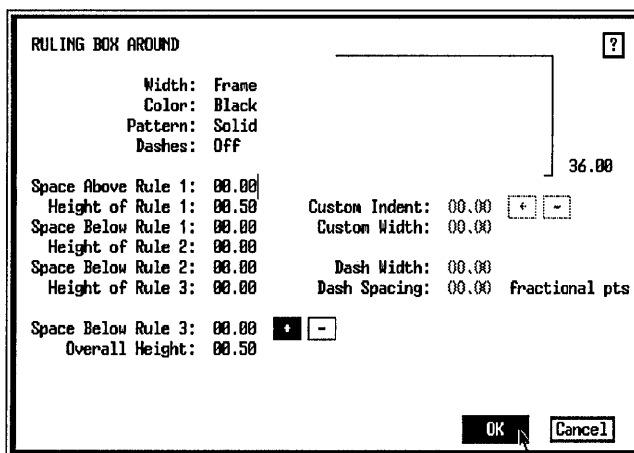

When you are satisfied with the appearance of the frame, you can continue to format the table.

Format the table

There are several ways to format tabular material, but the easiest and simplest way is to use horizontal tabs.

➡ *TIP: Use horizontal tabs for tables that do not exceed one line per entry, and vertical tabs (explained in Chapter Eight), for more tables with multiple lines. If you require very complex table formats, we recommend using the Table Editing feature in the Professional Extension (explained in Chapter Ten).*

Ventura allows up to sixteen tab positions per paragraph, with left, right, decimal, or center alignment. The sample table uses both right-aligned and decimal tabs. To format the

table properly you need to create two new tags — one for the table heading and one for the table listings.

Format the table heading

First you must add a new tag for the table heading and modify its Font, Alignment, and Spacing.

- Enable Paragraph mode and select the paragraph “JANUARY, FEBRUARY, MARCH.”
- Select Add New Tag from the Side-Bar. Move to the Tag Name to Add line and type: **Tb1Head**

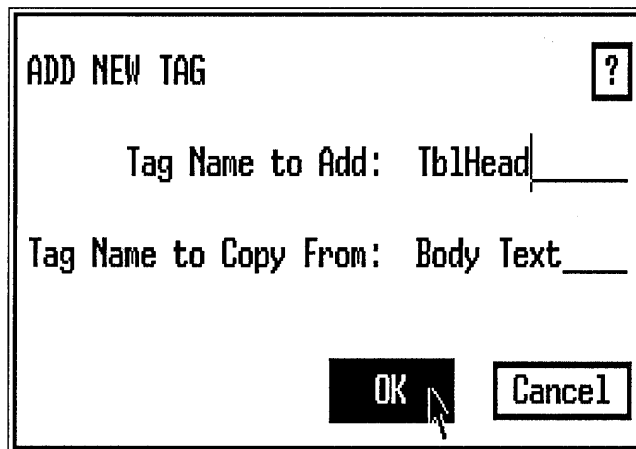

- Font
 - Face: Helvetica
 - Style: Bold
 - Size: 010.0 points
- Alignment
 - Horz. Alignment: Left
 - In/Outdent Width: 00,00 picas & points

➔ *NOTE: We changed the alignment of the tag to Left because tabs will not display when text is justified.*

Set the first tab stop

Now you will place tab settings at 15,03, 23,03 and 29,03 picas & points from the left margin of the frame. One at a time, you

will choose the number of the tab, select the tab alignment, and enter the tab location.

➤ **NOTE:** *Tab locations are measured from the left margin. Because the left margin of the frame is 02,00 picas in from the frame edge, Ventura begins measuring each tab location 02,00 picas in from the edge.*

■ Select Tab Settings from the Paragraph menu.

Tab number 1 is already selected for you.

■ Set the unit measurement to read picas & points.

■ Choose Tab Type: Right, Tab Shown As: Open Space. Move to the Tab Location line, press Esc, and type: 15, 03

Do not choose OK yet, since you still have more tabs to set.

"TblHead" TAB SETTINGS ?

Tab Number:

Tab Type: Right

Tab Shown As: Open Space

Tab Location: 15,03 | picas & points

Leader Char: Spaces 032 (ASCII)

Leader Spacing: 0

Auto-Leader: Off

Set the second tab stop

■ Choose Tab Number: 2 by clicking once on the right arrow next to the Tab Number line. Choose Tab Type: Right, Tab Shown As: Open Space. Move to the Tab Location line, press Esc, and type: 23, 03

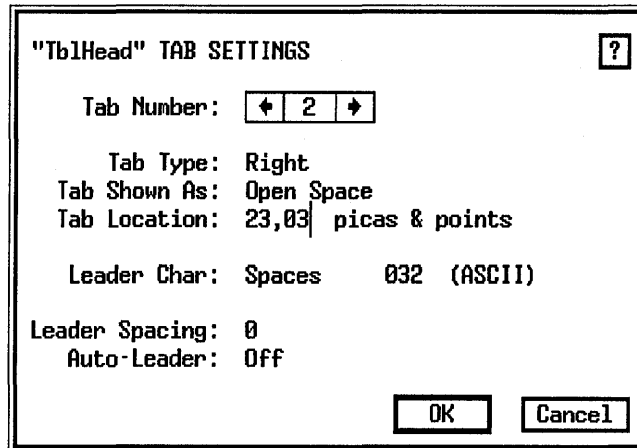

Set the third tab stop

- Click again on the right arrow again to choose Tab Number: 3. Then choose Tab Type: Right, Tab Shown As: Open Space. Move to the Tab Location line, press Esc, and type: 29,03

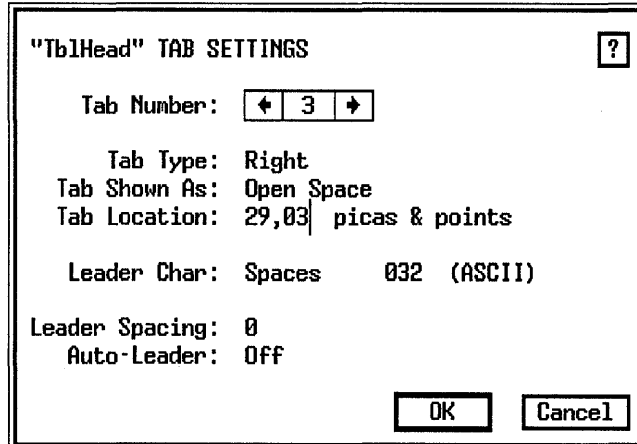

- Click OK to close the Tab Settings dialog box.

Set the tab stops

Since the font, alignment, and spacing are already correct, you need only modify the tab settings to get the new TblList tag to look the way you want. When you choose tab settings this time, use decimal tabs to line up the numbers with the decimal character in each column of the table.

- Tab Settings
 - Tab Number: 1
 - Tab Type: Decimal
 - Tab Shown As: Open Space
 - Tab Location: 14,00 picas & points
- Tab Number: 2
 - Tab Type: Decimal
 - Tab Shown As: Open Space
 - Tab Location: 22,00 picas & points
- Tab Number: 3
 - Tab Type: Decimal
 - Tab Shown As: Open Space
 - Tab Location: 28,00 picas & points

Check the appearance of your tag with Figure 2–32.

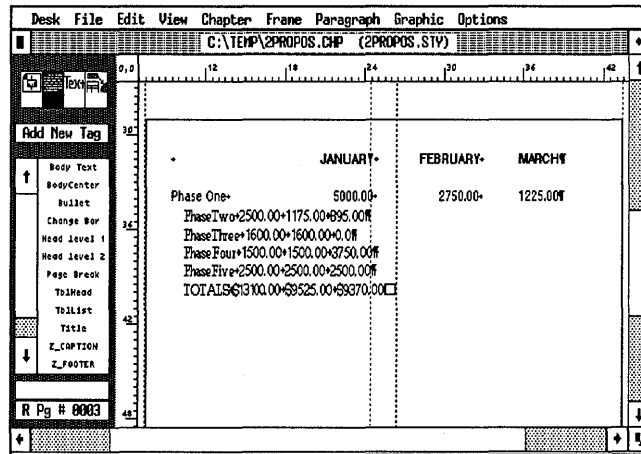

Figure 2–32.

➡ **NOTE:** If your table doesn't match our illustration, check the tab locations for the TblHead and TblList tags.

Apply TblList to the other paragraphs

Now that you've completed the attribute and tab settings for the new tag, apply it to the remaining paragraphs in the table. Remember, you can select multiple paragraphs using the Shift-Click method.

- Select the five paragraphs shown in Figure 2-33 and tag them as TblList.

| | JANUARY | FEBRUARY | MARCH |
|-------------|------------|-----------|-----------|
| Phase One | 5000.00 | 2750.00 | 1225.00 |
| Phase Two | 2500.00 | 1175.00 | 895.00 |
| Phase Three | 1800.00 | 1600.00 | 0.00 |
| Phase Four | 1500.00 | 1500.00 | 3750.00 |
| Phase Five | 2500.00 | 2500.00 | 2500.00 |
| TOTALS | \$13100.00 | \$9525.00 | \$9370.00 |

Figure 2-33.

Add a caption

To put the final touch on the spreadsheet, attach a caption and label to the frame.

- Enable Frame mode and select the frame that contains the spreadsheet.
- Select Anchors & Captions from the Frame menu.
- Choose Caption: Below and OK.

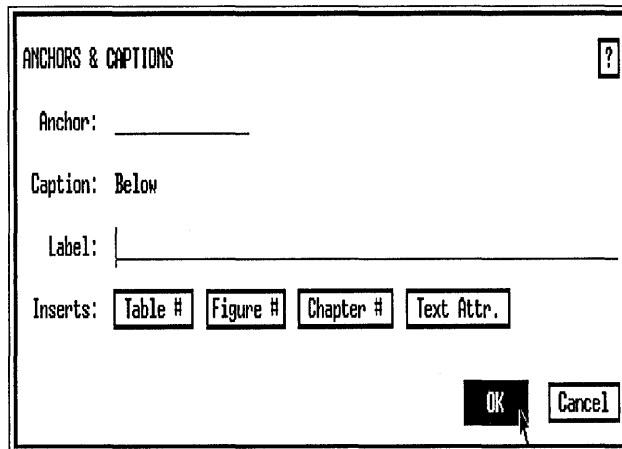

A blank caption frame appears below the existing frame.

Enlarge the caption frame

- Click in the caption frame so the sizing buttons appear.
- Place the cursor on any handle at the bottom of the frame. Press and hold down the mouse cursor until the pointing hand appears. Drag the frame downwards about 3 lines and release the cursor. You should see an end of file marker (□) in the middle of the frame. If the marker is not visible, stretch the caption frame downwards a few more lines.

The caption frame should look like Figure 2-34:

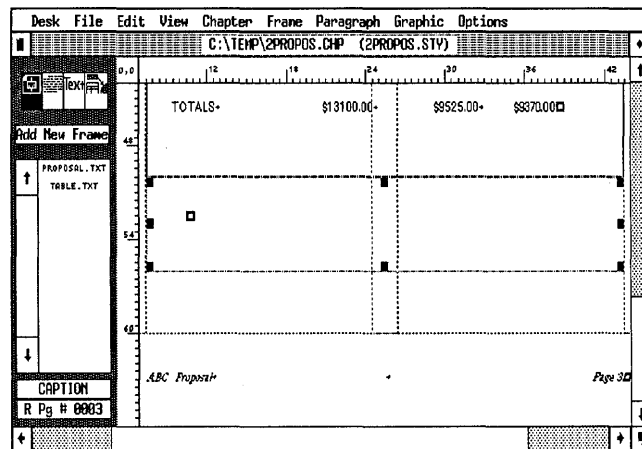

Figure 2-34.

➔ **NOTE:** *If the caption text disappears from view, do not be concerned. Simply enable Frame mode, select the caption frame, and stretch it downward until the text appears.*

Chapter

Now that you've completed text, style, and picture, it's time to complete the chapter part of the proposal. But first take a breather and save your work.

■ Select Save from the File menu (or press Ctrl-S).

Print the current page

To evaluate the editorial and stylistic changes you've made on screen, and to determine if you've achieved a more pleasing page design, print out the proposal. This time we will show you how to print the current page of a chapter.

■ Select To Print from the File menu.

■ Choose Which Pages: Current and OK.

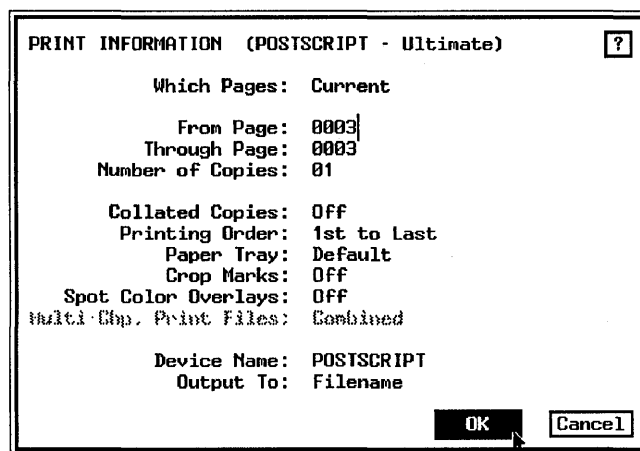

Ventura prints out the current page.

To print out the entire report, press Ctrl-X to bring up the To Print dialog box, choose Which Pages: All and click OK. Ctrl-X is a keyboard shortcut that recalls the last dialog box.

In the first two chapters you have learned how to build a report and a proposal using basic Ventura techniques. In the next chapter, you will polish off the remaining fundamentals while learning how to construct a new and important type of document — the newsletter.



Tips and techniques

Text tips

- Use a word processor to globally search and replace double spaces before loading a text file into Ventura.
- When you prepare text in your word processor for Ventura follow these guidelines. Do not: center or justify text; indent the first line of a paragraph; create temporary margins; put more than one space after a period, colon, or question mark; put more than one carriage return between paragraphs; or put more than one tab stop between columns.
- Use the @PARAFILTR = ON code to filter out extra carriage returns in a text file. It must be inserted as the very first item in the document and it must be typed accurately or Ventura will ignore it.
- If you want to load a single file into Ventura without it automatically being placed on the Page, select Load Text/Picture from the File menu while you are in Paragraph, Text, or Graphic mode.
- Rename text, style sheet, and chapter files before you make any changes to the document. Renaming files eliminates the possibility of permanently changing the originals.
- Use a word processor to make changes to large sections of text. Use Ventura's text-editing tools to make small, last-minute changes to text. You can cut, copy, or paste text or change text attributes of selected words within a paragraph.
- Use Text mode to change one or two words within a paragraph. Use a paragraph tag to change the attributes of an entire paragraph.
- Keyboard shortcuts can be used to speed up text editing in

Ventura. Press Del to cut text, Shift-Del to copy text, and Ins to paste text.

- When you cut or copy text, it remains on the Clipboard until something else is cut or copied. This feature allows you to insert text from one chapter to another. Simply copy or cut the text, close the current chapter, then open another chapter. Press Ins to insert the text into the new chapter.

Style tips

- To make column widths equal, enter the value of the first column width, then the first gutter width, then choose Make Equal Widths from the bottom of the Margins & Columns dialog box. Use this order so that Ventura makes the column widths equal.
- Turning Column Balance on from the Sizing & Scaling dialog box tells Ventura to fill all columns on the page equally. Without Column Balance on, Ventura fills the first column before starting the next.
- Ventura measures the In/Outdent Width from the left margin of the column.
- When you create a new tag, always copy from the tag that is nearest in appearance and format the new tag to the effect you want.
- To isolate text on a page, use a Page Break tag instead of a string of carriage returns. If you change a tag or add extra text, the carriage returns will “float” to the next page and push everything in the document out of place.
- You can use the Shift-Click method to tag multiple paragraphs.
- Headlines, headings, and subheads should include a Breaks: Keep With Next: Yes to keep them from becoming isolated at the bottom of a page or a column.
- Headers, footers, and captions are tags that are automatically generated by Ventura. Like all tags their attributes can be changed by working through the paragraph menu options. Generated tags have names that begin with a Z to distinguish them from other tags in the Assignment List.

Picture tips

- The Sizing & Scaling dialog box allows you to precisely control the position and size of a frame.
- Use horizontal tabs to format a table that does not exceed one line per entry. Use side-by-side paragraphs (see Chapter Eight) to format more complex tables.
- The tab location is always measured from the left margin.
- Turn off all tabs you do not use in a tag definition. Unused tab settings just take up extra memory.
- The caption labels you type directly into the Anchors & Captions dialog box can only be edited through that dialog box. For longer captions, type text directly into the caption frame.

Chapter Three Skills Checklist

Theory

- Frames versus the underlying page
- Newsletter-style layout

Text

- Typing text inside a frame
- Creating a text file inside Ventura
- Faster tagging with function keys in Text mode

Style

- Double-sided page format
- Vertical rules
- Renaming and removing tags
- How to create leader dots
- More effects with ruling lines

Pictures

- Sizing and scaling an image
- Creating caption labels

Chapter

- Manually inserting a page
- Creating a publication
- Backing up multiple chapters with Multi-Chapter
- Printing selected pages
- Switching printers properly

Chapter Three

A Two-Column Newsletter

Now that you've gained some momentum with Ventura, are you ready to step up the pace? In Chapter Three, you will create a newsletter, a document with different design requirements than business reports and proposals. This project will introduce you to some of Ventura's most powerful features. The checklist on the left lists some of the techniques you will learn.

Theory

By the time you've finished with Chapter Three, you'll have been exposed to all of Ventura's fundamental skills. You'll be equipped with the basic tools to construct virtually any type of document. You are not ready to graduate, however, until you understand the difference between frames and the Underlying Page, and how to use this difference to build newsletter-style layouts.

Understanding frames

Ventura uses frames to contain text and pictures. You can draw frames anywhere on the page.

To work on a frame — to change its size or to place something inside — you must first select it. To select a frame, enable Frame mode, then click once anywhere inside the frame boundary. Black sizing buttons appear around the edges (Figure 3-1).

You can use these sizing buttons to change the size of the frame. Place the cursor on top of a button and press the mouse button until the pointing finger appears (Figure 3-2). Now

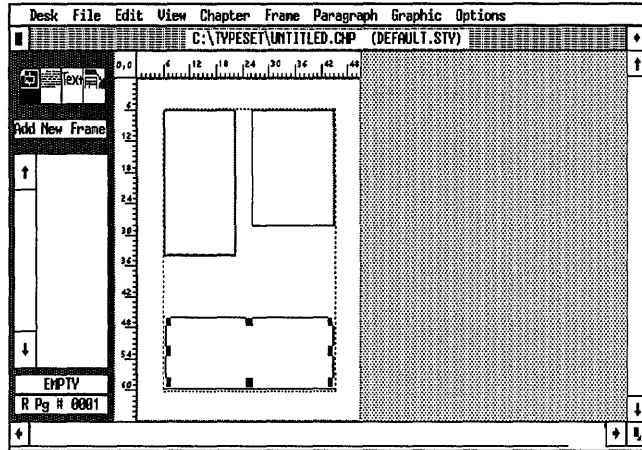

Figure 3-1. The black sizing buttons show which frame you selected.

drag the mouse — that is, move the mouse while holding the button down. When the frame is the proper size, release the button.

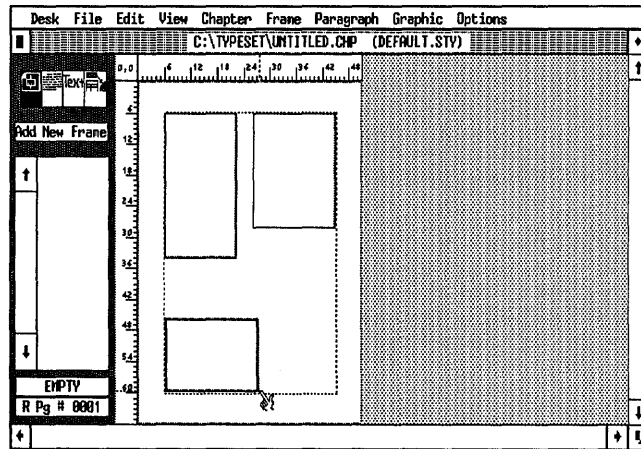

Figure 3-2. A pointing hand appears when you resize a frame.

You can also move frames with ease. Place the mouse cursor anywhere inside the frame. Press and hold the button until the four-way arrow appears (Figure 3-3). Then drag the frame to the new location (move the mouse while holding the button down).

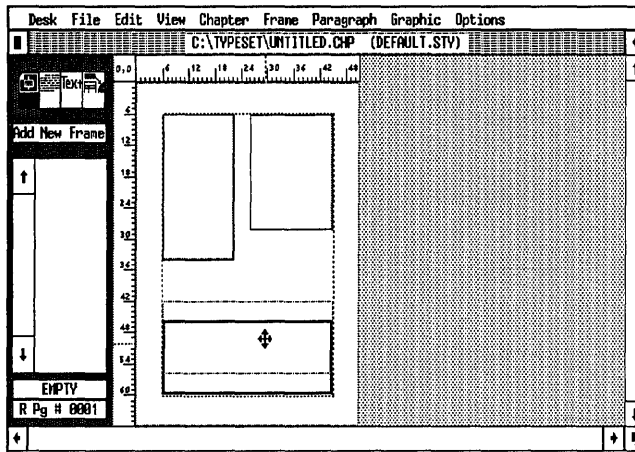

Figure 3-3. A four-way arrow appears when you move a frame

You can copy a frame onto the frame clipboard (also called temporary memory) and then paste as many copies as you want onto the Page. Initially, the copy is invisible because it appears on top of the original. When you move the copy away, you will see the original underneath. You can also overlap frames (Figure 3-4).

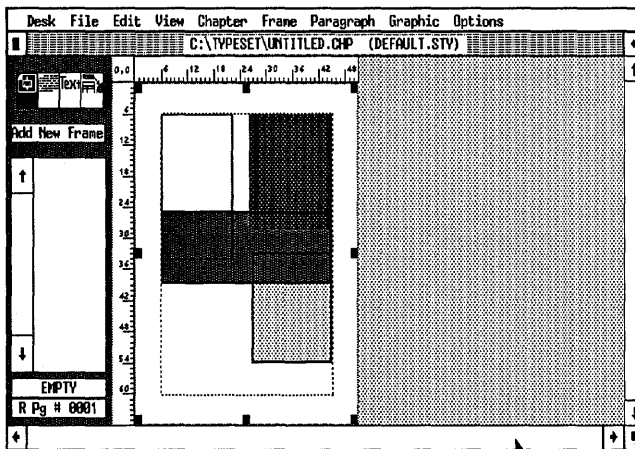

Figure 3-4. You can overlap multiple frames on the Page.

All frames have a boundary. That boundary can be invisible. Or, if you prefer, you can put a ruling line above, below or around the frame. The thickness of the ruling line is up to you.

As you can see in the Figure 3-5, the boundary acts as a container. You can place text or pictures inside.

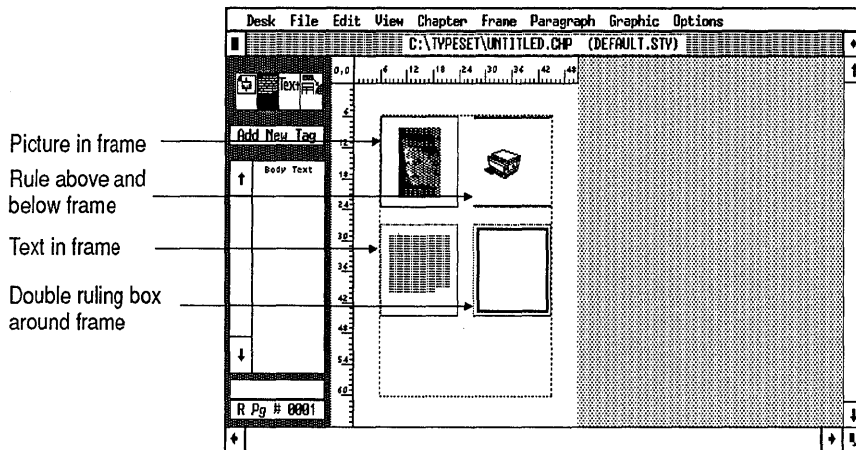

Figure 3-5. A frame acts as a container to hold text or pictures.

Suppose, that you pour a long file into a small frame. Ventura fits as much of the text as it can, then waits. You can draw additional frames to contain the rest of the text file. You can link these frames so the text file chains from one to the next. Frames can have margins and columns inside their boundaries. For instance, you might place a margin inside a frame to keep a picture from butting up against the edge (Figure 3-6). Or, you might create two columns within a single frame.

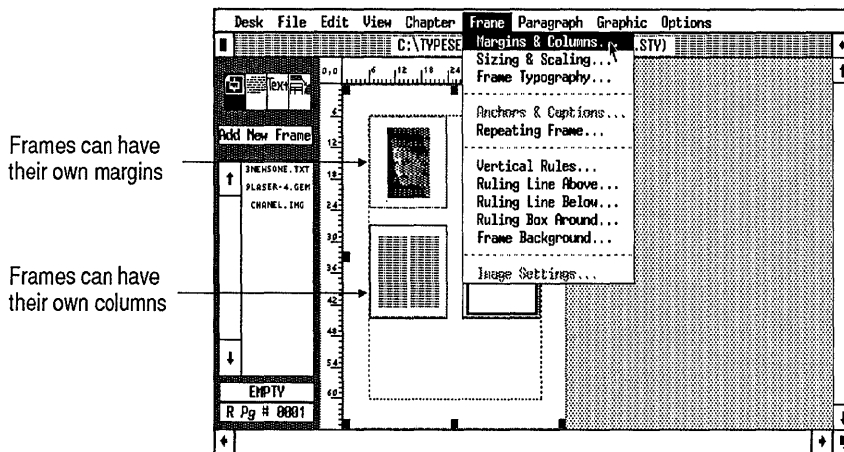

Figure 3-6.

If you place a frame on top of the Page, the margins and columns of the frame will override the margins and columns of the Page. For instance, in Figure 3-7, a three-column frame has been placed on top of a two-column Page.

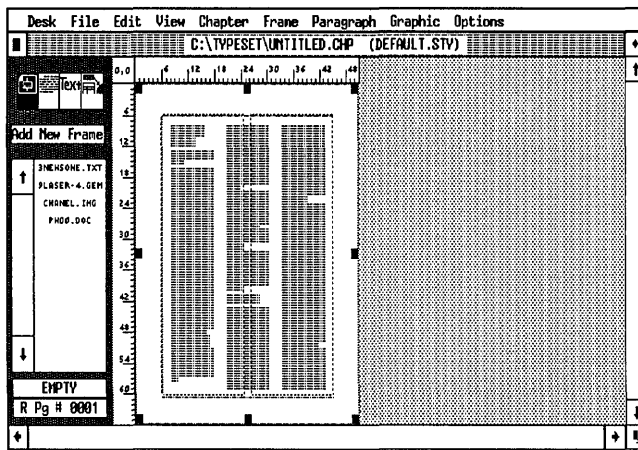

Figure 3-7. Frames can have different columns and margins from the Underlying Page.

You can also create a caption for any frame. This caption is a separate, smaller frame attached to the original. If you move the original frame, the caption moves with it. The text of the caption is contained within the caption frame (Figure 3-8).

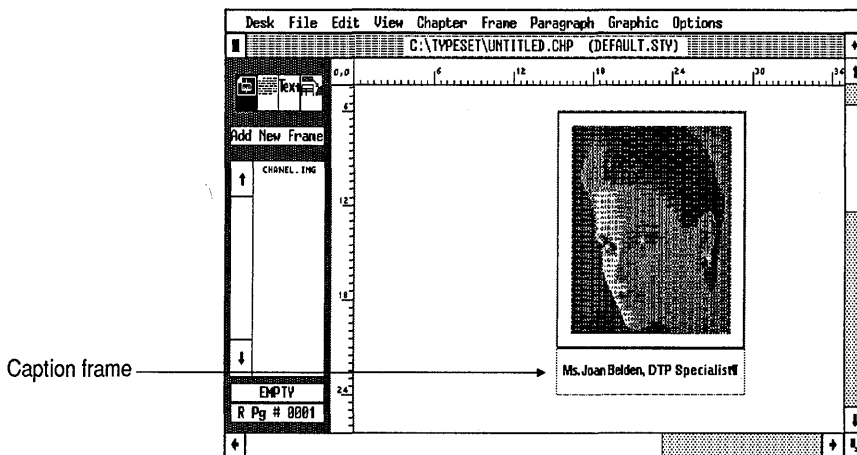

Figure 3-8. A caption frame is a separate frame attached to the original.

Understanding the Page

When you first learn Ventura, it is easy to become confused by Ventura's *Page* (referred to as the *Underlying Page*). Think of the Page as a large frame. Its boundaries equal the edges of the page (for instance, 8.5x11 in. for standard letter-size paper). Even though you can't see the boundaries, they are there, just as for smaller frames. In most respects, the Page acts like any other frame. For instance, you can change its size with the Sizing & Scaling dialog box. And you can give it margins and columns just like a frame (Figure 3–9).

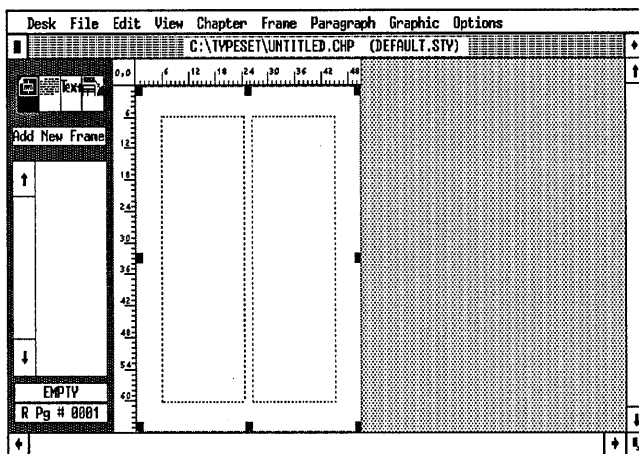

Figure 3–9A. The Underlying Page at normal size

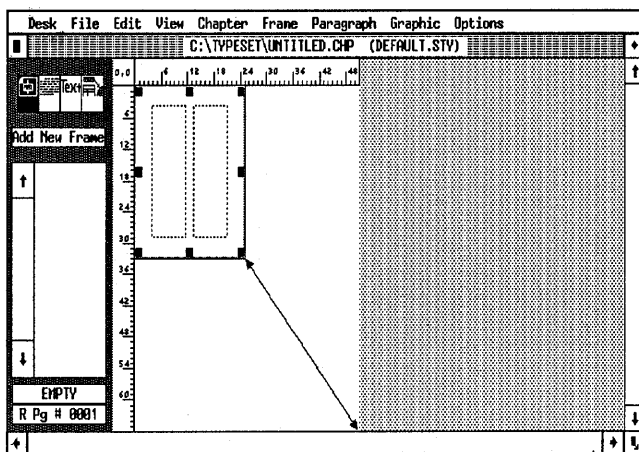

Figure 3–9B. The Underlying Page can be reduced in size.

➔ **NOTE:** You cannot change the size of the Underlying Page interactively with the sizing buttons. You must change its size through the Sizing & Scaling dialog box.

But the Page differs in one key aspect. When you place a text file into a frame, Ventura fits as much as possible, then waits for you to tell it where to put the rest. When you put text onto the Page, on the other hand, Ventura fits as much as possible onto the first page, *then automatically creates as many pages as necessary to accommodate the rest of the file.*

Frames versus Pages

You have placed text on the Page in the previous two chapters. Placing text on the Page is the method of choice when most of the chapter is made up of a single text file. But some documents contain many different text files. Newsletters are a prime example. Theoretically, you could combine all the copy for a newsletter into one large file, and then format that file on the Page. In practice, however, it is much easier to keep each article as a separate text file.

But how do you keep the articles separate when you bring them into Ventura? Simple: you draw frames on top of the Page. Then you place the articles into those frames.

By the way, you can combine both frames and pages in the same document, as we did in Chapter Two. The bulk of the proposal was in a single text file on the Page. The worksheet, however, was a separate file that resided inside a frame. That frame had been drawn on top of the Page.

Newsletter-style layout

Let's summarize what we've learned. Frames create boundaries that separate files. You can use frames to place one text file into the left column and a second file into the right column (Figure 3-10). When you put text into a frame, it flows to the end of that frame. Even if there is text left over, *Ventura does not create additional frames.* Instead, it remembers where it left off, and waits for you to place the remainder. You can put part of a file into column one on the page one, and continue the rest of it onto page two (Figure 3-11).

Continued from previous page

software. She has co-authored with Jesse Beest three books on Texas: Texas Publisher for New Moon Publishing, Thousand Oaks, CA.

For more information write or call Polly at 5052 Elmgrove Road, Westminster CA 92683, (714) 994-8142.

Patricia's PostScript:

Take the fits out of copyfitting

An important though sometimes mindboggling task is to determine how much space your headlines and body copy will take so you can plan your pages. You won't be so fortunate to have every story fit exactly where you want it, but with good planning you can make your finished pages look as if everything fit automatically.

Copyfitting is the process, in the same language, of fitting your copy into the space available. This may involve editing (shortening or revising a story) or maneuvering the various elements (body copy, headlines, photographs, artwork, and empty space) on your pages.

Use layout sheets (also called dummy sheets) for your layout design. These sheets contain the exact dimensions of your final pages, with all margins and columns marked in.

To plan your layout, have each writer write the copy to the exact width of your columns (e.g., an average of 33 characters per column if that is the width of your column size in Ventura). It does not matter what font the writer uses. You can always reformat the text after you have placed the story into the layout.

Give each writer an approximate number of lines to write, based on the amount of space you will allow for the story. For instance, a major story may require two columns, whereas a notice for an upcoming event may only need one half a column. If you know exactly how many lines a full column will hold, you can "guess-determine" how long each story should run.

Occasionally an article will contain exactly photos with very few words. Text should be limited to several paragraphs, and the story should be told through a single candid photo. Consider these tips when laying out the photos:

1. Edit all photos down to as few as possible. Choose photos that tell a specific story or scene event. Avoid playing politics with photos.
2. Crop all photos to the essence of the story. Eliminate any unnecessary clutter in the photo.
3. When assigning a photo layout, use a minimum amount of copy. Let the photos tell the story.
4. Have one photo dominate the supporting photos. Make a photo dominant with both size and content.

And Another's PostScript:

PC publishing—what's all the hype?

Recently we've heard a lot of talk about the merits and the nature of desktop publishing in the design.

Mark's Laboratory is an all desktop publishing on the IBM and PC platform. We share our knowledge of desktop publishing with the marketplace.

Mark's is one of the country's top writers and technical writers in the field of computer technology. One of the speakers will also be the author of Publishing from: Mark Vertice.

Polly is a publication design consultant and writer with more than 25 years professional design experience and magazine. She is one of the industry leading authorities on the IBM and PC platform and will discuss the benefits and benefits of desktop publishing.

Polly is the author of Report Design & Newsletter and the author of Classroom Newsletter Design, and 80 Ways to Save Money on Newsletter Design.

The speakers will discuss the pros and cons of desktop versus traditional publishing design. Cost and time are important considerations. Call today for a free brochure at (714) 994-1212 or send \$5.00 to the Publisher, Association of Computer Design, P.O. Box 18888-A, Los Angeles, CA 90019.

5. Keep centered a good consistent. Place an equal amount of white space between all elements in the layout (e.g. photos, captions, and columns)
6. Push white space to the outer perimeter of the page. Never top white space inside a layout.
7. Use contrasting sizes and shapes to increase emphasis in the layout. Avoid square-shaped photos. Crop photos to rectangular shapes.

Imagewriter
 The Orange County Newsletter Association
 P.O. Box 996, Chatterbox PA 19051
 September, 1989
 Editor: MARVIN LUBOW
 Please send suggestions or contributions to Po

Figure 3-10. Frames allow you to place different files on the same page.

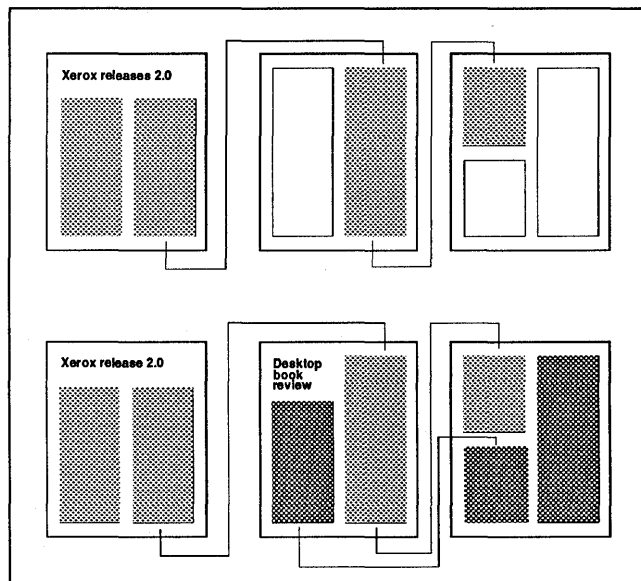

Figure 3-11. Text in frames can flow from one page to another.

Ventura remembers this path. As you make editing changes, the text automatically flows back and forth between page one and page two. In addition, articles can “leap-frog” one another. This automatic link between frames on different pages is sometimes called “chaining.”

➔ *TIP: When building newsletter-style documents composed of several different text files, put the text into frames, not onto the Page.*

How do you know where to position the frames? Simple: format the Page with the correct margins and columns. Then use the Page as a guideline. Thanks to Ventura’s snap-to features, your frames will automatically align with the columns on the Page.

➔ *TIP: Use the Page to create a snap-to grid for positioning frames in a newsletter-style layout (Figure 3–12).*

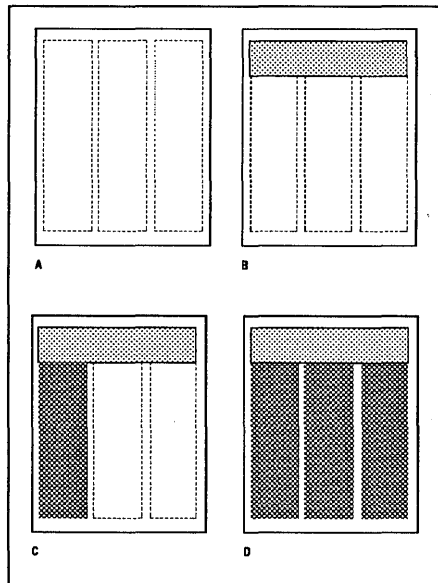

Figure 3–12. To create a newsletter-style layout, first create a snap-to grid by formatting the Underlying Page (A). Then stretch frames over the Page (B,C,D). You will place your text and pictures inside the frame.

There is one more crucial principle you need to know before you are ready to start building a newsletter: *Ventura can only flow text in a “forward” direction.*

We put quotes around the word forward, because it means different things to Ventura than it does ordinarily. On a page-by-page basis, the meaning is straightforward. Ventura cannot flow text backwards to a previous page.

The “forward-only” restriction also applies on a single page with several frames. On a single page, however, the flowing order depends on which frame was drawn first. Ventura can flow text from the first frame to the second frame, but it cannot flow “backward” from the second frame to the first.

The position on the page makes no difference. Ventura determines text flow strictly on the basis of the order the frames were placed on the page. For instance, in Figure 3–13, Ventura can flow text from frame #1 to frame #2 — not the reverse (Figure 3–13).

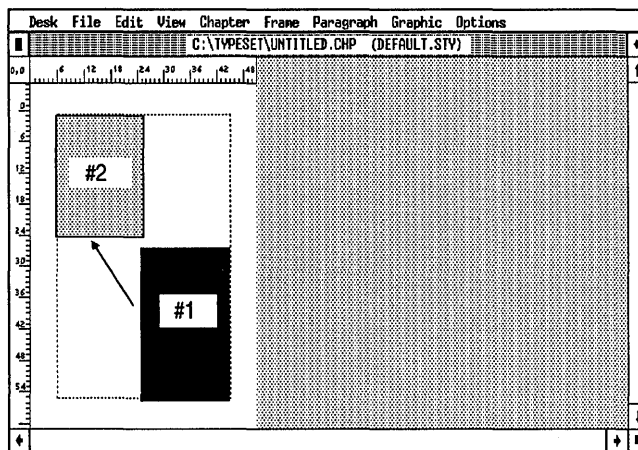

Figure 3–13. Since frame #1 was drawn first, text can flow from frame #1 to frame #2. Text cannot flow in the reverse direction.

WARNING: The sample project in this chapter uses numbered frames. Draw these frames in the order shown. If you draw them in a different sequence you may be unable to flow the text properly.

Fortunately, Ventura provides a simple method for changing the order of frames. To make a frame the “last” one, simply

select the frame, delete it, and reinsert it again. In Ventura's eyes, it is now the last frame on the page. If you accidentally draw frames out of order, use this method to correct the problem.

You will use the principles explained above to construct the newsletter in this chapter. First you will format the Page. Then you will draw frames on top, using the margins and columns of the Page as your guide. Finally, you will put text into the frames.

Before

The Newsletter

News and Information for Employees of the XYZ Corporation

President Approves Desktop Publishing Company-Wide

President Xavier Y. Zygnewski announced today his approval of a 13-month plan to install desktop publishing workstations in key departments throughout XYZ Corporation. The announcement follows a three-month pilot study conducted by the Marketing Communications Department.

"We initially thought that desktop publishing would only be a convenience for our sales representatives," said President Zygnewski. "But our study revealed that it could save a tremendous amount of money throughout the company while improving the appearance and effectiveness of our documents."

Several technological advances make the company-wide strategy feasible. First, XYZ was able to standardize on using software programs for all applications. This standardization will reduce setup, training and support costs. Second, the selected software, Xerox Ventura Publisher, will run on the IBM XT and AT-compatible computers already in place at XYZ. Many of the other software packages would have required the purchase of new or incompatible computers. Mr. Zygnewski confirmed that the new software will be phased in over a 13-month period on a department-by-department basis, beginning with Marketing Communications.

"We are delighted to be pioneering the move to desktop publishing for XYZ," said John Dugheim, Manager of Marketing Communications. "We will be helping our other work units in the form of workshops and seminars for employees in other departments." The Marketing Communications Department has hired a desktop publishing specialist to oversee implementation, taking total savings from about \$100,000 to over \$200,000.

Mr. Dugheim said the pilot program demonstrated that XYZ can expect cost savings in the area of 35% over the normal means now used to produce many company documents. In addition, turnaround times can usually be cut by 20% or more, since the documents no longer need to be sent to an outside company or department for typesetting and pasteup. These gains can give us a competitive advantage in the eyes of our customers.

These time and cost savings provided the impetus for adoption of desktop publishing, but they are not the only benefits. "We are finally convinced that the new desktop publishing program will dramatically improve the look and impact of XYZ's documents," said Mr. Dugheim. "If you want a document that will impress us, it must look important. Xerox Ventura Publisher will give every department the ability to create great-looking pages."

The new desktop publishing specialist will be making a library of professional-quality style sheets. XYZ employees can obtain the benefits of graphic design and typesetting even if they have no special training. All they will need to do is select a publication style sheet and use it to produce their documents. Layouts of type sheets including headlines, marginal annotations, and corrections will be developed for in-house use throughout XYZ Corporation.

"The average document is becoming increasingly cluttered with high-quality graphic design," said President Zygnewski. "They have come to expect it. In the future, documents that do not produce an effective document will be at a disadvantage. We are determined that the documents we produce at XYZ, both internal and external, will demonstrate the same commitment to quality that has always set this company apart from the rest."

According to President Zygnewski, the desktop publishing program will be phased in over a 13-month period on a department-by-department basis, beginning with Marketing Communications.

XYZ Hires DTP Specialist

John Dugheim, Marketing Communications Team

The Marketing Communications Department has hired an experienced desktop publishing (DTP) specialist to help XYZ implement its new desktop publishing program. The specialist will be responsible for overseeing the implementation of the program, taking total savings from about \$100,000 to over \$200,000.

Mr. Dugheim said the pilot program demonstrated that XYZ can expect cost savings in the area of 35% over the normal means now used to produce many company documents. In addition, turnaround times can usually be cut by 20% or more, since the documents no longer need to be sent to an outside company or department for typesetting and pasteup. These gains can give us a competitive advantage in the eyes of our customers.

These time and cost savings provided the impetus for adoption of desktop publishing, but they are not the only benefits. "We are finally convinced that the new desktop publishing program will dramatically improve the look and impact of XYZ's documents," said Mr. Dugheim. "If you want a document that will impress us, it must look important. Xerox Ventura Publisher will give every department the ability to create great-looking pages."

After

The Newsletter

News and Information for Employees of the XYZ Corporation

July/August 1988 Vol. 1 No. 4

Cost savings predicted

President approves desktop publishing company-wide

President Xavier Y. Zygnewski announced today his approval of a 13-month plan to install desktop publishing workstations in key departments throughout XYZ Corporation. The announcement follows a three-month pilot study conducted by the Marketing Communications Department.

"We initially thought that desktop publishing would only have advantages for our sales representatives," said President Zygnewski. "But our study revealed that it could save a tremendous amount of money throughout the company while improving the appearance and effectiveness of our documents."

Several technological advances make the company-wide strategy feasible. First, XYZ was able to standardize on using software programs for all applications. This standardization will reduce setup, training and support costs. Second, the selected software, Xerox Ventura Publisher, will run on the IBM XT and AT-compatible computers already in place at XYZ. Many of the other software packages would have required the purchase of new or incompatible computers. Mr. Zygnewski confirmed that the new software will be phased in over a 13-month period on a department-by-department basis, beginning with Marketing Communications.

"We are delighted to be pioneering the move to desktop publishing for XYZ," said John Dugheim, Manager of Marketing Communications. "We will be helping our other work units in the form of workshops and seminars for employees in other departments." The Marketing Communications Department has hired a desktop publishing specialist to oversee implementation, taking total savings from about \$100,000 to over \$200,000.

Mr. Dugheim said the pilot program demonstrated that XYZ can expect cost savings in the area of 35% over the normal means now used to produce many company documents. In addition, turnaround times can usually be cut by 20% or more, since the documents no longer need to be sent to an outside company or department for typesetting and pasteup. These gains can give us a competitive advantage in the eyes of our customers.

These time and cost savings provided the impetus for adoption of desktop publishing, but they are not the only benefits. "We are finally convinced that the new desktop publishing program will dramatically improve the look and impact of XYZ's documents," said Mr. Dugheim. "If you want a document that will impress us, it must look important. Xerox Ventura Publisher will give every department the ability to create great-looking pages."

The new desktop publishing specialist will be making a library of professional-quality style sheets. XYZ employees can obtain the benefits of graphic design and typesetting even if they have no special training. All they will need to do is select a publication style sheet and use it to produce their documents.

Continued on page 2

Table of Contents

| | |
|---------------------------------------|---|
| President approves desktop publishing | 1 |
| XYZ hires specialist | 3 |
| New plant comes on-line | 3 |
| People on the move | 5 |
| Letters to the editor | 6 |
| Calendar | 8 |

Planning the newsletter

The goal of a newsletter is to provide timely information to a specialized audience. This chapter's example is a corporate newsletter, an in-house organ for the fictitious XYZ Corporation.

Most newsletters are 8.5x11 in. The simplest design consists of two pages stapled together or printed on both sides. Even the most complex newsletters rarely exceed 24 pages or so. Overall design should be informal and relaxed to help convey a sense of timeliness. The best design is simple, open and uncluttered.

Look at the “before” picture of the newsletter. Below is a list of the methods you will use to enhance its appearance and effectiveness.

- Large type for a logo
- Rules to separate and define different sections
- A kicker and a banner headline
- A table of contents
- Two-column format
- Uniform spacing to align text across columns

Ventura prep

As you did in the previous two chapters, you will start the project by loading and renaming the text, style, picture and chapter files.



If you have the Power disk

For this project you will load four files at once. Later in the chapter, you will place them into frames — one for the logo, one for the headline, and two for articles. The text files are provided on the Power disk and should have previously been copied to the C:\POWER subdirectory according to the directions with the disk. These files have been preformatted with

tag names and non-keyboard character codes. (Refer to Chapters Two and Seven for more on preformatting.)

- ➔ **NOTE:** *If you did not purchase the Power disk, skip to the section below entitled "If you do not have the Power disk."*
- If you are continuing from the previous chapter, select New to clear the last project from the screen. Ventura removes the text files and frames but keeps the style sheet.
- Select Load Text/Picture from the File menu.
- Choose Type of File: Text, Text Format: ASCII, # of Files: Several, Destination: List of Files, and OK.

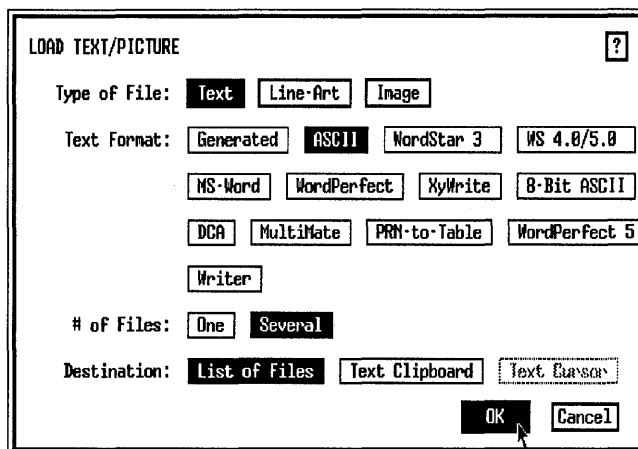

- Find the C:\POWER subdirectory and scroll through the list until you find the file 3NEWSHED.TXT. Select the file. After you select the first file, Ventura loads it, then redisplay the Item Selector so you can load more files.
- Load the files 3NEWSLGO.TXT, 3NEWSONE.TXT, and 3NEWSTWO.TXT. When you are finished, choose Cancel or OK to close the dialog box.

Rename the text files

In Frame mode, you will place each of the text files on the Page in turn.

- Using File Type/Rename from the Edit menu, rename the files as shown below:

Load from C:\POWER

C:\POWER\3NEWSHED.TXT

C:\POWER\3NEWSLGO.TXT

C:\POWER\3NEWSONE.TXT

C:\POWER\3NEWSTWO.TXT

Save to C:\TEMP

C:\TEMP\3HEAD.TXT

C:\TEMP\3LOGO.TXT

C:\TEMP\3NEWS-1.TXT

C:\TEMP\3NEWS-2.TXT

- Use Remove Text/File from the Edit menu to remove the last text file from the frame. *Remember to remove them from the frame but not from the list of files.*

Load and rename a style sheet

As before, you will be modifying one of the style sheets provided with the Ventura program disks.

- Select Load Diff. Style from the File menu.
- Use the Backup button if necessary to go to the C:\TYPESET subdirectory. Load the style sheet named &NEWS-P2.STY.
- Select Save as New Style from the File menu.
- Go to the C:\TEMP subdirectory and save the new file as 3NEWS.STY. Then click OK.

Load a picture

- Select Load Text/Picture from the File menu. Choose Type of File: Image, Image Format: GEM/HALO DPE, # of Files: One, and OK.
- Move to the C:\TYPESET subdirectory and load CHANEL.IMG.

If the picture is placed on the Page, use Remove Text/File to remove it from the frame (not from the list of files).

➔ *NOTE: CHANEL.IMG was copied to the \TYPESET subdirectory during Ventura installation. If you have deleted or moved this file, use DOS to copy it back from the original Ventura examples disk.*

Rename the chapter

When you have finished loading and renaming the text and style sheet files, save the chapter with a new name.

- Select Save As from the File menu. Go to the C:\TEMP subdirectory and type in the new chapter name, 3NEWS, and click OK.



If you do not have the Power disk

- Exit from Ventura.
- Use your word processor to type in the text files 3HEAD.TXT, 3NEWS-1.TXT, 3NEWS-2.TXT and 3LOGO.TXT from Appendix A. Copy them to the C:\TEMP subdirectory.
- Then load Ventura and proceed through the Ventura prep section starting at “Load and rename a style sheet.”

Text

Normally you would place the text files at this point. However, since you will be putting those files into frames, and not onto the Page, you must deviate slightly from the Ventura Formula. The only change is to delay placing the text files until you build frames to contain them. To build these frames, proceed to the Style section.

Style

Your goal is to create frames of the right size and position to hold the text files. To make this job easier, first construct the Underlying Page. Then you can use the Page as a guide for placing frames.

➡ *NOTE: Remember our rule of thumb: complete the chapter formatting before the individual text paragraphs. This rule is even more important when using newsletter-style layout.*

Change to double sides

The in-house newsletter will be printed on both sides of the paper, so you must switch to double-sided page layout. Ventura then makes a mirror image of headers, margins, etc., from the right to the left page. For instance, the page number format on the right side of a right-page header will be copied to the left side of the left-page header.

■ Select Page Size & Layout from the Chapter menu. Choose Sides: Double, and Start On: Right Side.

Change the margins

Now increase the size of the page margins and the gutter margin. You are altering the original style sheet to make the columns shorter and to add more white space around the edges of the page.

■ Enable Frame mode.

■ Select Margins & Columns from the Frame menu. Make the top and bottom margins 04,06 picas & points, the left and right margins 06,00 picas & points. Make the Column 1 width 18,06 picas & points and the first gutter 02,00 picas & points. Make the Column 2 width 18,06 picas & points. Choose Copy to Facing Page and click OK. (The Copy to Facing Page button does not stay highlighted after you choose it.)

| MARGINS & COLUMNS | | | | ? | | | | |
|-------------------|--|---------------------------------------|---|----------------------------|----------------------------|----------------------------|----------------------------|----------------------------|
| # of Columns: | <input type="checkbox"/> 1 | <input checked="" type="checkbox"/> 2 | <input type="checkbox"/> 3 | <input type="checkbox"/> 4 | <input type="checkbox"/> 5 | <input type="checkbox"/> 6 | <input type="checkbox"/> 7 | <input type="checkbox"/> 8 |
| Settings For: | <input type="checkbox"/> Left Page | | <input checked="" type="checkbox"/> Right Page | | | | | |
| | Widths | Gutters | Margins | | | | | |
| Column 1: | 18,06 | 02,00 | Top: | 04,06 | picas & points | | | |
| 2: | 18,06 | 00,00 | Bottom: | 04,06 | | | | |
| 3: | 00,00 | 00,00 | Left: | 06,00 | | | | |
| 4: | 00,00 | 00,00 | Right: | 06,00 | | | | |
| 5: | 00,00 | 00,00 | | | | | | |
| 6: | 00,00 | 00,00 | | | | | | |
| 7: | 00,00 | 00,00 | | | | | | |
| 8: | 00,00 | 00,00 | | | | | | |
| | | | Calculated Width = 51,00 | | | | | |
| | | | Actual Frame Width = 51,00 | | | | | |
| Inserts: | <input type="checkbox"/> Make Equal Widths | | <input checked="" type="checkbox"/> Copy To Facing Page | | | | | |
| | | | | OK | Cancel | | | |

Create a vertical rule

Vertical Rules creates a ruling line between columns. The rule is always the same height as the columns.

- Select Vertical Rules from the Frame menu.
- Place the cursor on the Rule 1 Width line and change the unit measurement to fractional pts.
- Select Settings For: Right Page, Inter-Col. Rules: On, Width: 00.25 fractional pts. Choose Copy to Facing Page to mirror these settings to the opposite page. Click OK to close the dialog box.

| VERTICAL RULES | | | | ? |
|-------------------|---|----------------|--|---|
| Settings For: | <input type="checkbox"/> Left Page | | <input checked="" type="checkbox"/> Right Page | |
| Inter-Col. Rules: | On | Width: | 00.25 | |
| Rule 1 Position: | 00,00 | picas & points | | |
| Rule 1 Width: | 00.00 | fractional pts | | |
| Rule 2 Position: | 00,00 | | | |
| Rule 2 Width: | 00.00 | | | |
| Inserts: | <input checked="" type="checkbox"/> Copy To Facing Page | | | |
| | | OK | Cancel | |

Add a header

To complete the chapter format, add a header that includes the newsletter's name, the page, and the month of the issue.

- Select Headers & Footers from the Chapter menu.
- Choose Define: Right Page Header, Usage: On. Move to the Left line and type: **The Newsletter**, move to the Center line and type: **Page [P#]**, and move to the Right line and type: **Fall/Winter 1989**

➔ *NOTE: You can also use the Inserts: Page # button to insert the [P#] code.*

- Choose Copy to Facing Pages to mirror the header settings to the left page. Click OK to close the dialog box.

HEADERS & FOOTERS

Define: Left Page Header Right Page Header

Left Page Footer Right Page Footer

Usage: On Off

Left: The Newsletter _____

Center: Page [P#] _____

Right: Fall/Winter 1989 _____

Inserts: Chapter # Page # 1st Match Last Match

Text Attr. Copy To Facing Page

Now turn the header off for the first page only.

- Select Turn Header Off from the Chapter menu.

Fine-tune the chapter format

Now that you are warmed up, we're going to pick up the pace and show you how to use some special typographic techniques to fine-tune the chapter format.

■ Select Chapter Typography from the Chapter menu.

There's a lot to the Chapter Typography menu. We will explain only those options you need for this project — so don't panic. The other options we will leave for later chapters. Because Chapter Typography is complex, you may want to read through this section more than once.

Let's start with the option: Widows and Orphans.

A widow is a single line of text at the top of a frame or column. An Orphan is a single line of text at the bottom of a page or column. The Widows and Orphans option lets you control the number of lines you will permit on a page.

Normally, the default setting for both widows and orphans is 2. However, for a newsletter-style document, we suggest that you disable Widows and Orphans completely (by setting both values to 1). With Widows and Orphans turned off, Ventura can place a single line of text at the top or bottom of a frame. This makes it easier for text files to reach the bottom of the frame and reduces the change for a white-space gap at the bottom.

- Move to the Widows (Min Lines at Top) line and choose 1.
Move to the Orphans (Min Lines at Bottom) line and once again choose 1.

Next, verify that Column Balance is off. With Column Balance on, Ventura fills all the columns on the Underlying Page equally with text. In a newsletter-style document, however, you achieve balanced columns by placing text files in individual frames on the Page.

- Choose Column Balance: Off. *Do not* close the dialog box yet.

The next option, Move Down to 1st Baseline By, lets you control the position of text at the top of a column or page. You can choose either Move Down to 1st Baseline: By Cap Height or Move Down to 1st Baseline: By Inter-Line.

Move Down to 1st Baseline by Cap Height places the baseline of the first line of text so the tops of capital letters touch the top of the column guide. On the other hand, Move Down to 1st Baseline by: Inter-Line, positions the baseline a *distance equal to the tag's inter-line spacing*. Both methods affect the way that Ventura will flow the text on the page (See Figures 3-14 and 3-15).

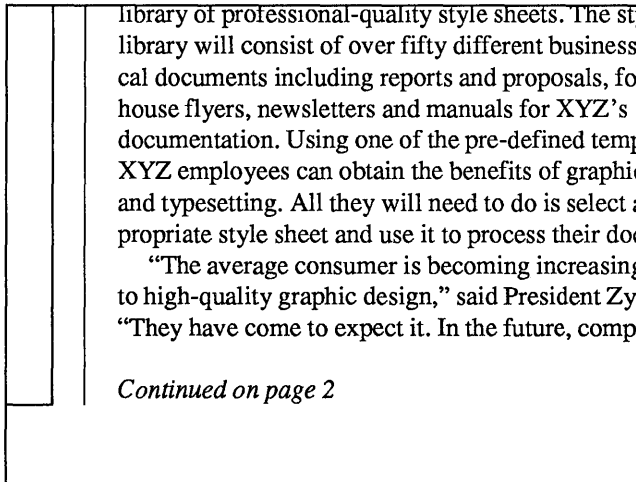

Figure 3-14. Although the differences between By Cap Height and By Inter-Line are not obvious at first glance...

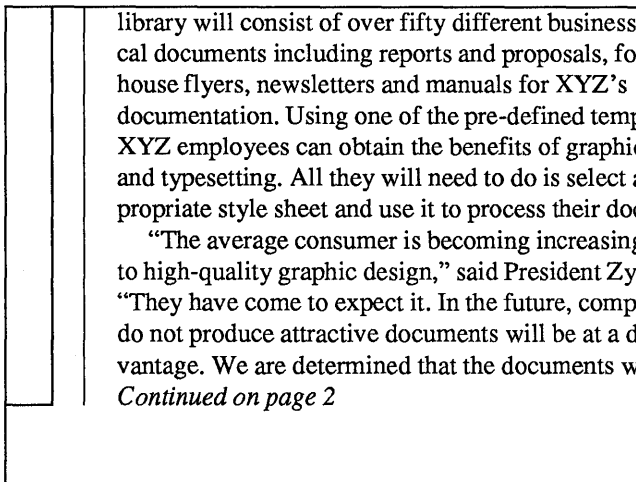

Figure 3-15. ...they can add up in a multi-column document. The only change between these two examples is that the top one is By Cap Height and the bottom is by Inter-Line.

The position of the text baseline affects the alignment of text across columns. For best results in a newsletter, we suggest that you 1) choose Move Down to 1st Baseline By: Inter-Line and 2) make all vertical spacing an integer multiple of Body Text. That way you get

- an integral number of Body Text lines per page
- a more uniform-looking page
- text that is aligned across multiple columns

Now go ahead and change the baseline position of the text.

- Choose Move Down To 1st Baseline By: Inter-Line. Then click OK to close the dialog box.

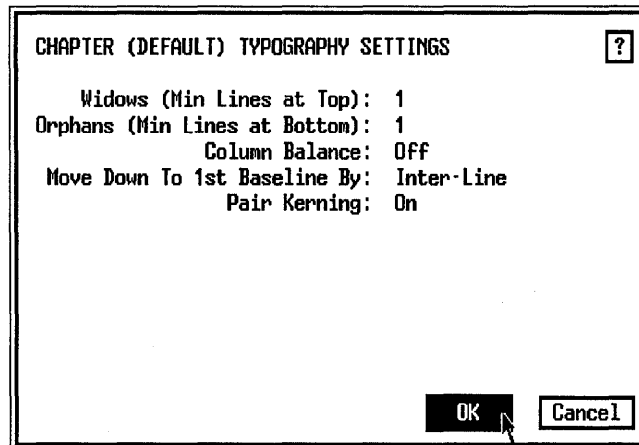

You made it. You got through the hardest part of the Chapter Typography menu. Now catch your breath and take a moment to save your work.

- ➔ *TIP: Save every 15 minutes or less to reduce the risk of losing work due to a computer glitch, software crash, or power outage.*

From now on, we will not remind you to save. We will assume that you are regularly pressing Ctrl-S as you progress through the chapter.

Add frames

With the structure of the Underlying Page complete, you can draw frames on the Page.

Before you start, go to the Options menu and confirm that Line Snap and Column Snap are turned on (when Column and Line Snap are on, the Options menu displays “Turn Column Snap Off” and “Turn Line Snap Off”) and that the column guides are visible (the Options menu displays “Hide Column Guides”).

These snap-to features help line up frames properly. Thanks to Column Snap, frames automatically snap to the column guides on the Page. Use the ruler to gauge the approximate height.

- *TIP: Before you place any frames, check that the zero point is reset to the upper left corner of the Page (click the 0,0 square in the upper left corner). Otherwise, the ruler settings on your screen will not match ours.*
- Enable Frame mode. Select Add New Frame from the Side-Bar. Place the frame cursor at the upper left corner of the dotted column guides on the Page.
- Press and hold down the mouse button. Drag the lower right corner of the frame downwards and to the right.
- Release the button when the bottom of the frame reaches the right margin and lines up with position 16,06 picas on the vertical ruler (Figure 3-16).

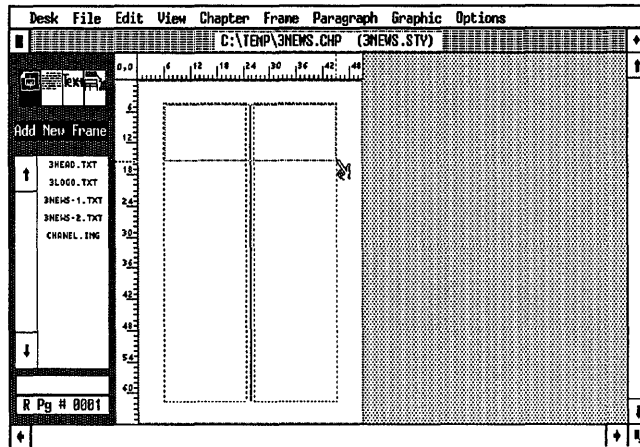

Figure 3-16.

- Repeat the step above to place all the frames on the page. Place the frames in the numeric order (1 through 6). Use Figure 3–17 as a guide before you fine-tune the frame size as explained in the next step.

Try to get the frame sizes approximately right, but don't worry about precise placement yet. Some users prefer to make the initial placement in Reduced View, before switching back to Normal View for fine-tuning.

➔ *NOTE: If you place a frame in the wrong position, delete it and try again, or move it with the mouse cursor.*

After drawing the frames, you can use the Sizing & Scaling dialog box to make sure they match the values shown in Figure 3–17.

- Select each frame in turn.

- Select Sizing & Scaling from the Frame menu. If necessary, change the frame height, width, or upper left X,Y position.

➔ *TIP: You can use Ctrl-X to bring up the Sizing & Scaling dialog box again. Ctrl-X is the shortcut for "recall the last dialog box."*

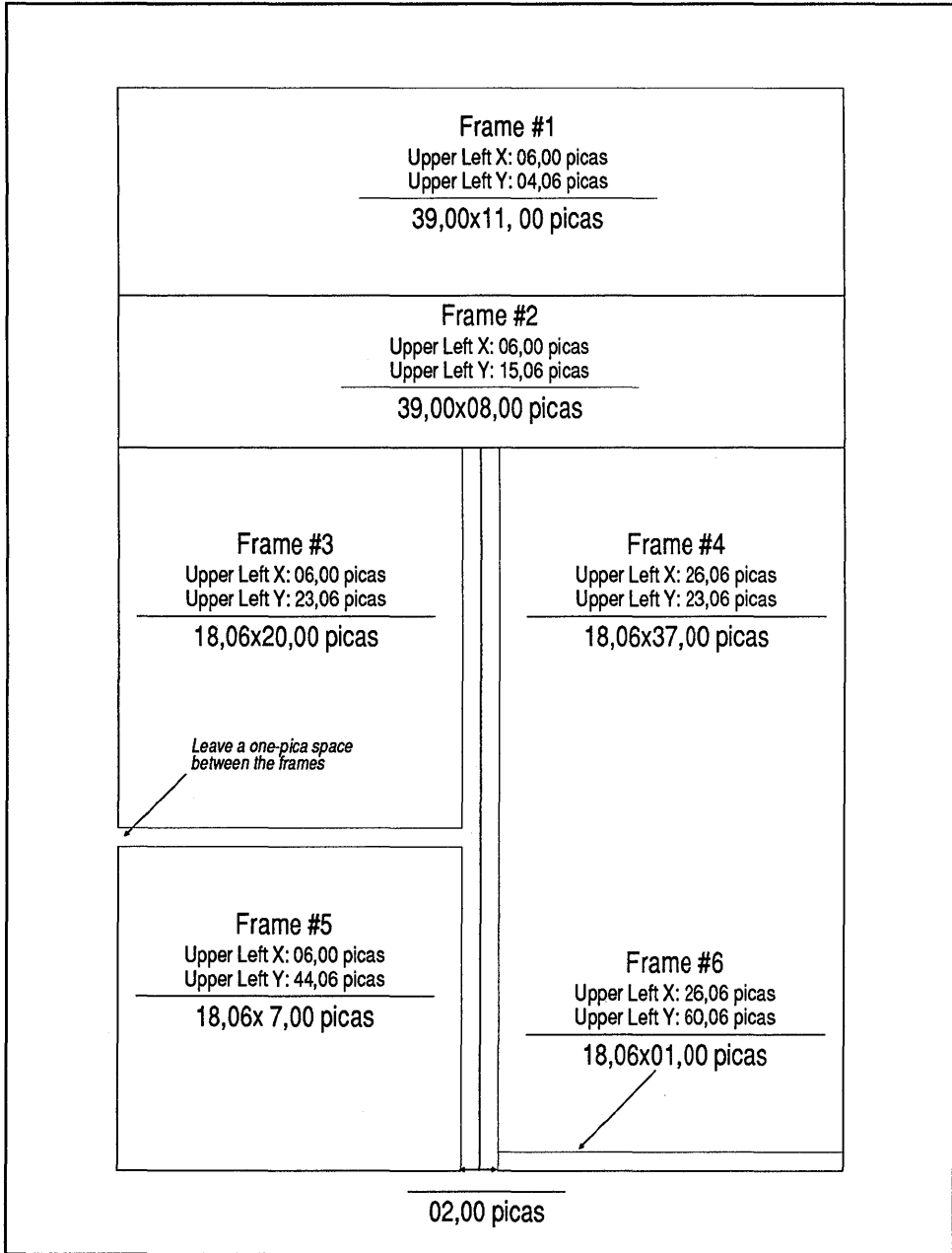

Figure 3-17

For instance, Figure 3-18 shows the correct Sizing & Scaling settings for frame #1.

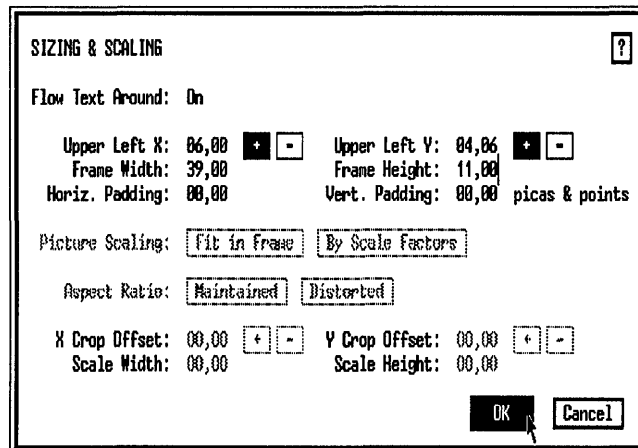

Figure 3-18.

➔ **NOTE:** Don't be concerned if the small "jump text frame" at the bottom of the page overlaps the frame above it. Later, when you change the Body Text inter-line spacing, you will make the frame line up with the bottom column guide.

Add a ruling box around the TOC

Before you place the text, add a Ruling Box Around the frame reserved for the Table of Contents (frame #5). This box will visually separate the TOC from the adjacent articles.

■ Select frame #5.

■ Ruling Box Width: Frame
 Around Height of Rule 1: 00.25 fractional pts

Place the text files

With the frames in place and correctly sized, you are ready to place the text files. Since the text files were pretagged, they will be partially formatted as soon as they are placed. You will do the rest of the formatting later.

■ Select frame #1, then place the file 3LOGO.TXT by selecting its name from the Assignment List (Figure 3-19).

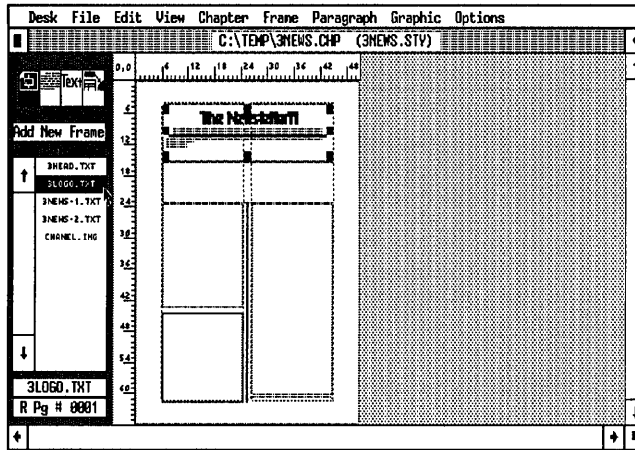

Figure 3-19.

- Select frame #2 and place 3HEAD.TXT inside of it (See Figure 3-20).

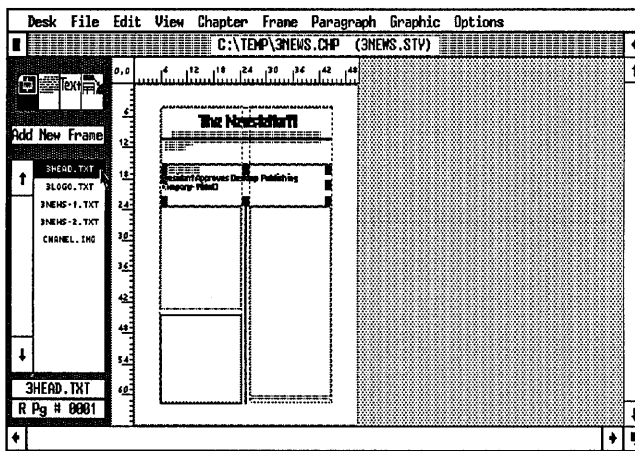

Figure 3-20.

- Select frame #3 and place 3NEWS-1.TXT inside.

Ventura fits as much of 3NEWS-1.TXT into the frame as it can and then stops. To continue placing the text file, select another frame and click again on the file name in the Assignment List.

- Select frame #4 and select 3NEWS-1.TXT again from the Assignment List.

Ventura picks up where it left off and flows more of the file into frame #4. It stops again when the frame is filled. Later you will place the remainder of the article on page two. Before going on, check to make sure your first page resembles the one we show in Figure 3–21.

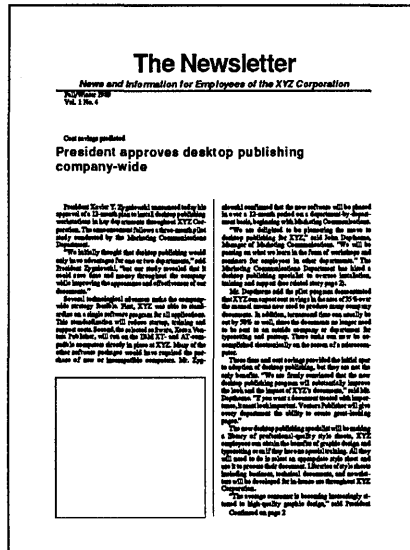

Figure 3-21. After placing the text on the first page, your page should look like this illustration.

Create a table of contents

To create a table of contents, you will type text directly into a frame. The text you enter will be treated as a separate file when you save the chapter.

➔ **NOTE:** Text typed into a separate frame is saved as part of the caption file unless you rename it as shown below.

- Enable Text mode. Change to Normal or Enlarged View. Make sure Show Tabs & Returns is selected from the Options menu. Click the cursor anywhere inside frame #5.

The end of file marker appears at the top left corner of the frame.

➔ **TIP:** Remember, you can zoom into a selected area on the page by placing the mouse cursor at the spot which will be the upper left corner of the magnified view and pressing **Ctrl-N** or **Ctrl-E**.

▣ Place the text cursor in front of the marker and type: **Table of Contents** [Enter]

Now type the TOC entries, line by line. Press the tab key once between the text and the page number (Figure 3-22).

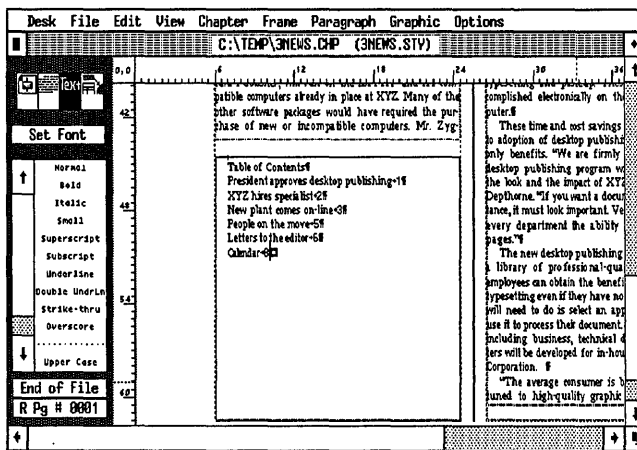

Figure 3-22

President approves desktop publishing [Tab] 1 [Enter]

XYZ hires specialist [Tab] 2 [Enter]

New plant comes on-line [Tab] 3 [Enter]

People on the move [Tab] 5 [Enter]

Letters to the Editor [Tab] 6 [Enter]

Calendar [Tab] 8 [Enter]

➔ **NOTE:** If you make a mistake you can delete a letter by pressing the backspace or **Del** key.

Once you type text into a frame, you can give it a name and save it in the text format of your choice (Figure 3-23).

- Enable Frame mode. Select the table of contents frame (frame #5).

The default file name, "FRAME TEXT," appears in the Current Selection Box.

- Select File Type/Rename from the Edit menu.
- Move to the New Name line. Press Esc to clear the line and type: `C:\TEMP\3NEWSTOC.TXT`
- Choose Text Format: ASCII and click OK to close the dialog box.

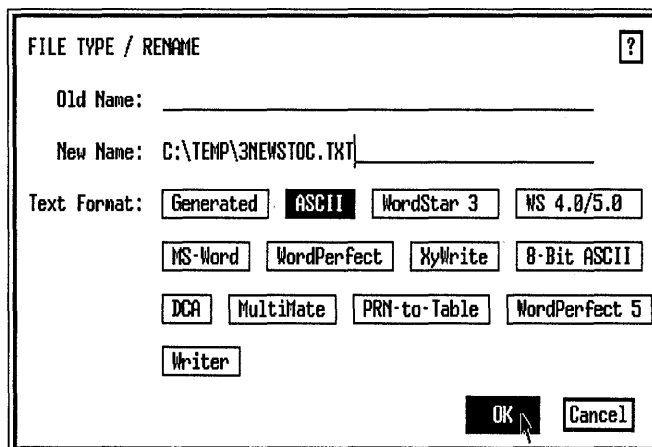

Figure 3-23.

This saves the table of contents text as the file 3NEWSTOC.TXT in the C:\TEMP subdirectory and displays the new file name in the Assignment List.

There's one thing left on the first page: the *jump* text at the bottom of the page. You will create it just as you created the TOC text: by typing directly into the frame. This time, however, you will not give it a new file name. Because you are not renaming the file, the text you type will be stored in the chapter's caption file.

- Enable Text mode and click anywhere inside frame #6 (See Figure 3-24). Then type: **Continued on page 2**

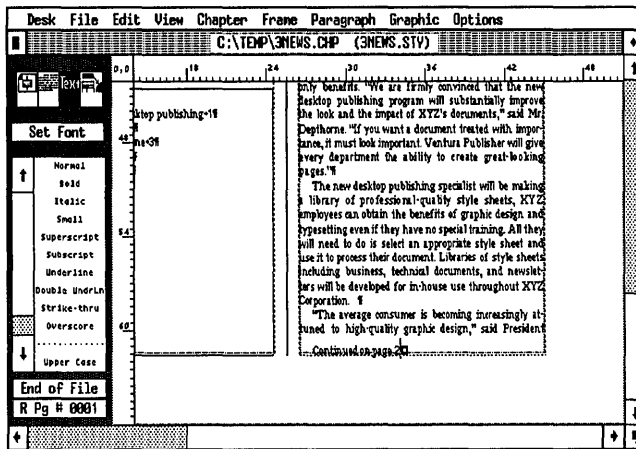

Figure 3-24



Stopping point

Are you keeping up with the pace? If not, take a moment to get out of your chair and stretch. When you're recharged, sit back and review what you've done and what remains to be completed in the style section. First you made format changes to the overall chapter. Then you laid out page one by adding frames and placing text inside.

Now you are ready to tackle page two. Once this layout work is complete, you can begin to format the text by working systematically through each paragraph in each frame.

If you must stop now, save your work by pressing Ctrl-S, then select Quit from the File menu. Return to this spot in the text when you are ready to resume the project. Otherwise, move on to the next section now.

Insert a page

If you are starting up again, load Ventura and open the chapter C:\TEMP\3NEWS.CHP to begin where you left off. Once

you are on page one of the document, you are ready to proceed with the instructions that follow.

When you place text in frames (as opposed to putting it on the Page), Ventura does not create new pages automatically. Therefore, you must manually insert a new page.

- Select Insert/Remove Page from the Chapter menu. Choose Operation: Insert New Page After Current Page. Click OK.

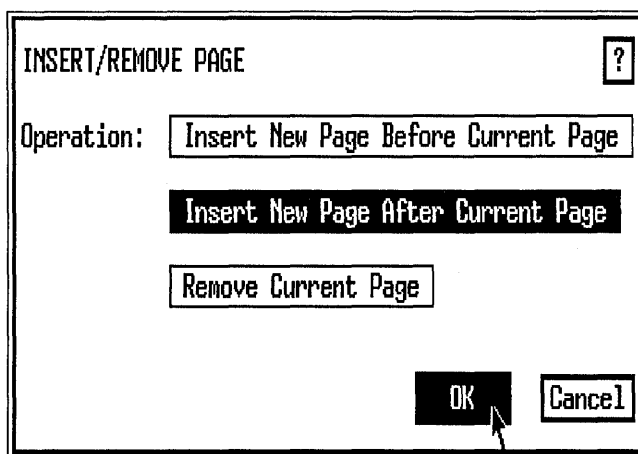

Ventura inserts the new page and moves you to it.

At this point, you can add frames to the new blank page as you did earlier on page one. Use Figure 3-25 to gauge the approximate positions and sizes.

You can use several strategies for placing frames on the page. One idea is to draw the frames in approximate position, then return to each frame one by one to check its position with the Sizing & Scaling dialog box (as explained below). In that case, we recommend that you press and hold the Shift key as you click on the Add New Frame button. As long as the Shift key is depressed, Ventura will let you continue to draw frames without the need to choose the Add New Frame button each time.

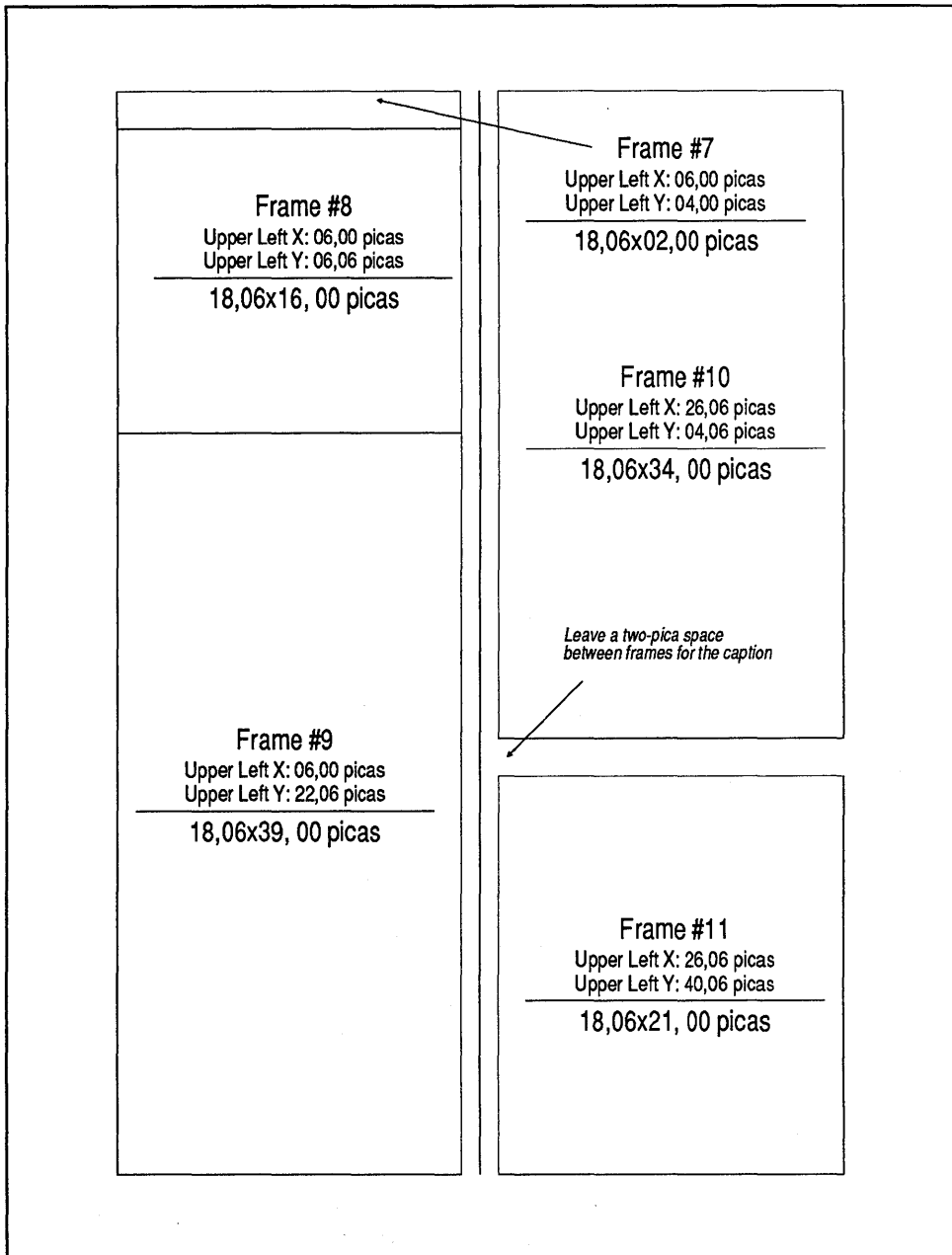

Figure 3-25

If you prefer, you can draw and position each frame as you go. First, draw the frame as closely as you can. Then, with the frame still highlighted, choose Sizing & Scaling, you can return to this dialog box for the next frame by pressing Ctrl-X, a keyboard shortcut that tells Ventura to bring up the last dialog box again.

➡ **NOTE:** *If you make a mistake, you can always delete a frame by pressing the Del key or selecting Cut Frame from the Edit menu.*

Finally, you can also create frames by drawing the first one, then copying it to the clipboard. Create new frames by pressing the Ins key to put a copy on the page. Move the copy into position and change its size. This is particularly useful when creating multiple frames of the same size.

Size and scale the frames

After adding the frames, check the dimensions one by one with Sizing & Scaling from the Frame menu. Use Figure 3-22 as your guide.

Place the text

Finish placing the text files by selecting the frame, then choosing a file name from the Assignment List. At this stage, don't worry whether or not the text fits perfectly inside the frame.

- Select frame #8 and place the remainder of text file 3NEWS-1.TXT inside.
- Select frame #9 and place 3NEWS-2.TXT inside.
- Select frame #10 and place 3NEWS-2.TXT inside.

When you have finished, change to Reduced View to check that your screen looks similar to Figure 3-26:

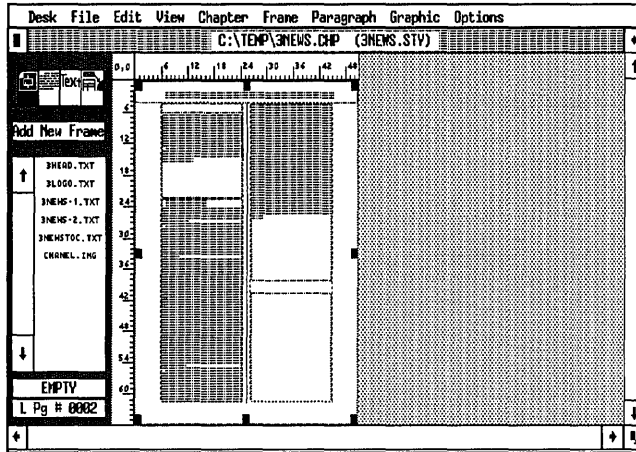

Figure 3-26.

Add jump text on page two

- Enable Text mode.
- Change to Normal or Enlarged View. Place the text cursor anywhere in the small frame (frame #7) at the top of the left column (Figure 3-27). Type: **Continued from page 1**

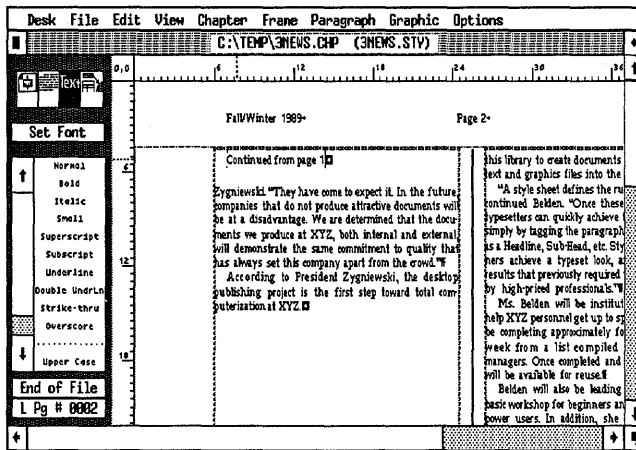

Figure 3-27.

As before, the text you type into the frame is automatically saved to the caption file the next time you save the chapter.

Mission accomplished. Since frame #11 is reserved for a picture file (to be added later), you have finished the basic layout. Now you can start tagging. As always, you should start with Body Text and then step through the document from beginning to end.

Format the Body Text

You may want to change to Normal View (Ctrl-N) as you tag the document.

- Press the Home key to return to the first page of the document.
- Enable Paragraph mode.
- Select the paragraph in frame #3 that begins “We initially thought...” (Figure 3-28). Refer back to Figure 3-17 if necessary to recall the frame numbers and positions.

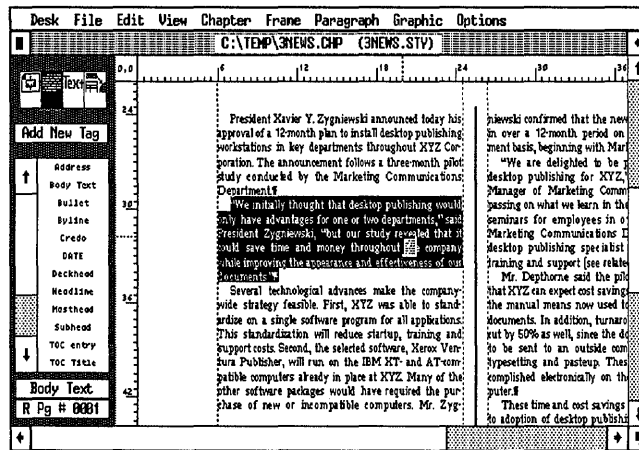

Figure 3-28.

- Alignment Horz. Alignment: Left
- Spacing Inter-Line: 12.00 fractional pts
Add in Above: When Not At Column Top

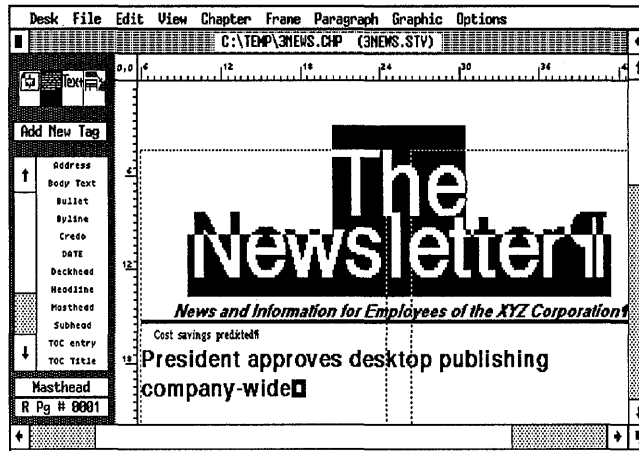

Figure 3-29.

- Alignment Overall Width: Frame-Wide
- Spacing Below: 12.00 fractional pts
Inter-Line: 48.00 fractional pts

The logo is too large for the current frame. You could reduce the font size, but that would diminish the impact of the logo. Instead, you can use one of Ventura's typographic functions to tighten up the spacing between individual characters. This technique, called tracking, has two benefits: It fits the word into the frame and it enhances its readability. Tracking is most often used to improve the look of large banner headlines. Headlines tend to appear loose if spaced with the same proportion as sub-heads or Body Text. Figure 3-30 shows how different tracking values affect the appearance of a headline.

By changing the tracking of the Logo tag you can make it fit into the frame without changing the font size or the frame size.



Figure 3-30

- Select Paragraph Typography from the Paragraph menu.
- Choose Automatic Pair Kerning: On, Letter Spacing: Off. Choose Tracking: Tighter. Press Esc to clear the tracking line and type 0.048 Ems. Click OK.

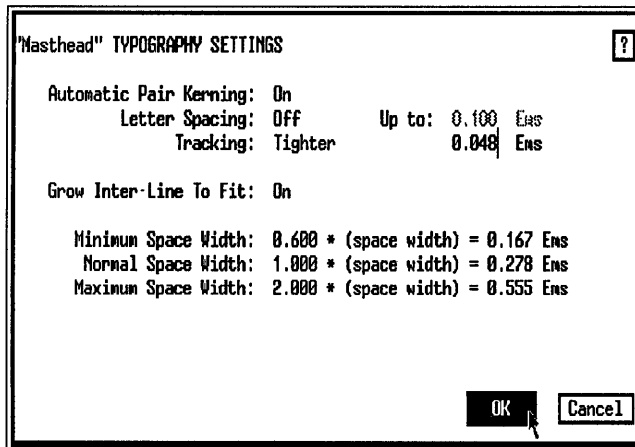

➤ *NOTE: Don't worry if the text overlaps on-screen. When you print out the document, the text will appear correctly.*

There's a lot of power in the Paragraph Typography dialog box. For now, we'll talk about tracking and leave the other features for later. Tracking controls the space between letters. It is measured in ems. An em space is equal to the point size of the type. For 10-point type, an em space is 10 points, for 18-point type it is 18 points, and so on.

➤ *TIP: Standard spacing is generally too wide for display type larger than 24.00 fractional pts. To make your pages look more professional, use tracking to tighten display type.*

Once you adjust the tracking, the logo should fit neatly into the frame on one line. If not, use tracking to tighten it further.

Change the Credo paragraph

If you continue with our suggested top-down order, the next paragraph you should format is the credo. You will change the font and increase the width of its ruling line.

■ Select the next paragraph in frame #1 starting with "News and Information...."

■ Confirm that it is tagged as Credo.

■ Font Face: Times
 Style: Normal

■ Alignment Overall Width: Frame-Wide

■ Spacing Inter-Line: 18.00 fractional pts

Now add a ruling line below. Notice that when you widen the rule, you also add extra space above it. The extra white space helps visually separate the rule from the text.

■ Select Ruling Line Below from the Paragraph menu. Choose Width: Frame. Make Space Above Rule 1: 06.00 fractional pts and Rule 1: 10.00 fractional pts.

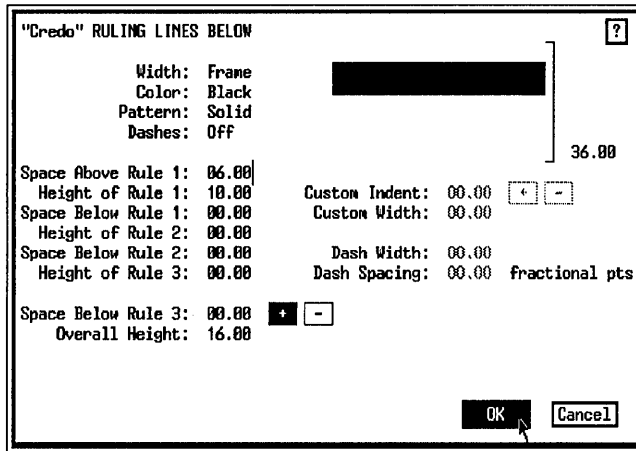

When you are finished the frame should look like Figure 3-31:

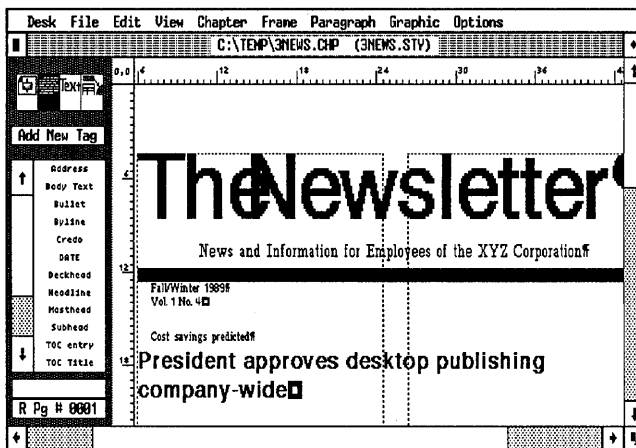

Figure 3-31.

Create a dateline

Next you will create a dateline that puts two different tags — Date and Volume — on the same line.

■ Select the next paragraph “Fall/Winter 1989.”

Since this paragraph was already pretagged, the tag name (DATE) appears in the Current Selection Box. However, since the format for this tag doesn’t yet exist in the style sheet, Ventura displays it with Body Text attributes and in all caps

in the Assignment List. You will adjust its font, alignment, and spacing and add a rule below.

- Font Size: 008.0 points
- Alignment Horz. Alignment: Left
 In/Outdent Width: 00,00 picas & points
- Spacing Inter-Line: 12.00 fractional pts
- Select Breaks from the Paragraph menu. Confirm that Line Break is set to Before.

Now add a frame-wide rule below the tag.

- Select Ruling Line Below. Choose Width: Frame. Enter 06.00 fractional pts of Space Above Rule 1, and give Rule 1 a height of 00.25 fractional pts (Figure 3-32.)

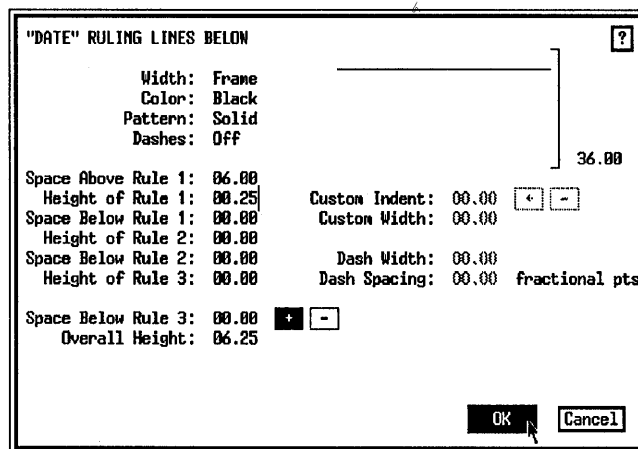

Figure 3-32.

Change the Volume tag

Now you will select the paragraph pre-tagged as Volume. To allow it to reside on the same line as the Date, make it right-justified and set the Line Break *after* the tag instead of before. (A Line Break Before would cause a break between the date and the volume paragraphs.)

- Select the last paragraph in frame #1, “Vol.1 No. 4.”
- Font Size: 008.0 points

- Alignment Horz. Alignment: Right
 In/Outdent Width: 00,00 picas & points
- Breaks Line Break: After

Check that your screen resembles Figure 3-33 (if you do not see the tab and end of paragraph symbols, make sure Show Tabs & Returns is turned on in the Options menu).

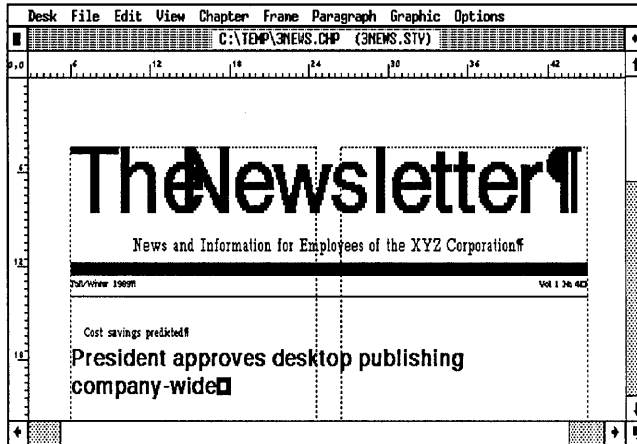

Figure 3-33.

You’ve just learned a valuable skill: How to make two different tags reside on the same line. As you saw, the trick is to give the first tag a line break *before* and the second tag a line break *after*.

You have to be careful when putting two paragraphs on the same line or the text will overlap. In the example above, you kept them separate by making one flush left and the other flush right. You could also have used In From Left and In From Right spacing to separate the two.

Add the Kicker tag

A kicker is a lead-in heading that introduces a headline. Since the tag name and format does not exist in the current style sheet, you will add a new tag.

- Select the paragraph “Cost savings predicted.”
- Select Add New Tag from the Side-Bar.

- When the dialog box appears, move to the Tag Name to Add line and type: **Kicker** (Figure 3-34).

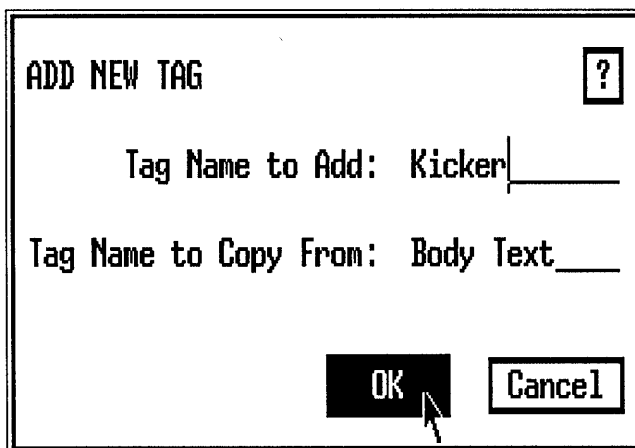

Figure 3-34.

Format the Kicker tag

- Font
 - Face: Helvetica
 - Style: N-Italic
 - Size: 012.0 points
- Alignment
 - Overall Width: Frame-Wide
- Spacing
 - Above: 12.00 fractional pts
 - Inter-Line: 24.00 fractional pts
 - Add in Above: When Not at Column Top

Now you will add a ruling line below the kicker to separate it from the headline.

- Ruling Line Below
 - Width: Text
 - Space Above Rule 1: 03.00 fractional pts
 - Height of Rule 1: 00.25 fractional pts

By selecting Text in the Ruling Line Below dialog box, you are telling Ventura to make the ruling line exactly as long as the text. If you write a longer kicker, the rule will automatically be lengthened. For a shorter kicker, the rule will be shortened.

Change the Headline tag

To make the headline in frame #2 easier to read, increase its size and its inter-line spacing.

■ Select the paragraph, “President approves desktop publishing company-wide” in frame #2.

■ Font Size: 030.0 points

■ Spacing Below Spacing: 00.00 fractional pts
Inter-Line: 30.00 points
Add in Above: When Not at Column Top

■ Paragraph Tracking: Tighter
Typography Ems: 0.035

When you are finished making these changes, the headline should look like Figure 3–35:

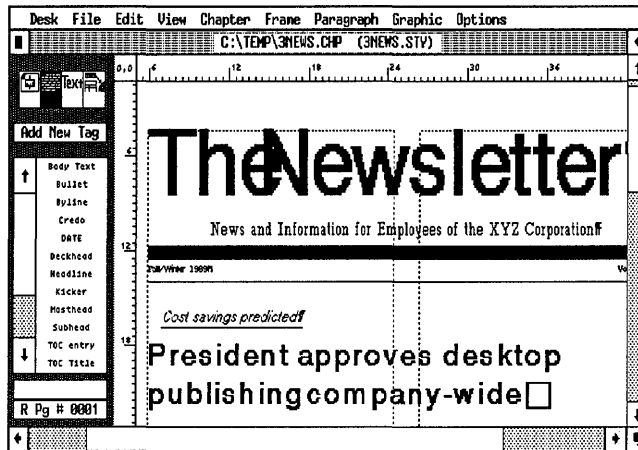

Figure 3-35.

Are you beginning to notice improvements? By enlarging the logo and the headline and adding rules, you have made the front page easier to read and less cluttered.

We realize you are working very hard in this chapter. You are duplicating the steps you must go through in real life to construct a professional-looking newsletter. Although taking the “real-life” approach means spending a few extra minutes, it pays off. By the end of this chapter, you will be familiar with all of Ventura’s basic functions. Stick with it.

Add a BodyFirst tag

To distinguish the lead-in paragraph from Body Text, you will create a tag called BodyFirst. The tag will be aligned flush left with no first-line indent.

- Select the paragraph that begins “President Xavier Y. Zygniewski announced...” in frame #3.

- Add New Tag Tag Name to Add: BodyFirst

- Alignment In/Outdent Width: 00,00 picas & points

The first paragraph should look like Figure 3-36:

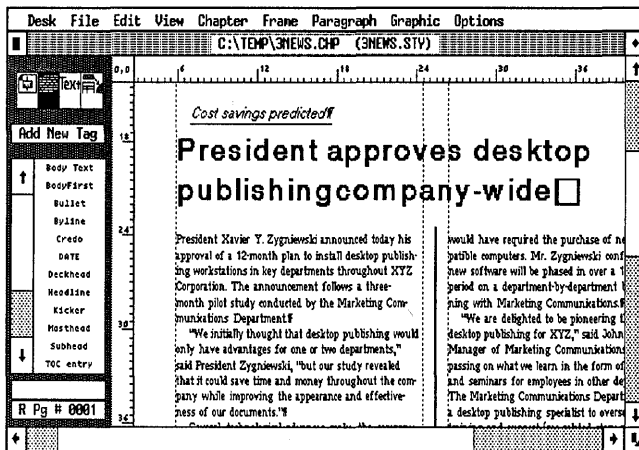

Figure 3-36.

Change the TOC Title

The last frame (frame #5) on the page includes the text for the table of contents. To format the TOC, first tag the text, then change the tag attributes.

- Select the paragraph “Table of Contents” and tag it as TOC Title, which was already defined in the original style sheet (Figure 3-37).

- Font Face: Times

- Alignment Horz. Alignment: Left

➔ *TIP: We used Below Spacing to visually separate the Title of the TOC from the following TOC entries.*

Modify the TOC entry tag

■ Select the paragraph “President approves desktop publishing...” and tag it as TOC entry.

■ Font Face: Times
 Style: Bold

■ Spacing Above: 18.00 fractional pts
 Inter-Line: 06.00 fractional pts

You will use Tab Settings to create leader dots. As the name implies, these dots help lead the eye across the page. They are useful for indexes, tables of contents, and other lists.

■ Select Tab Settings from the Paragraph menu. Choose Tab Number: 1, Tab Type: Right, Tab Shown As: Leader Char., Tab Location: 17,00 picas & points. Then choose Leader Char: (...) and Leader Spacing: 1.

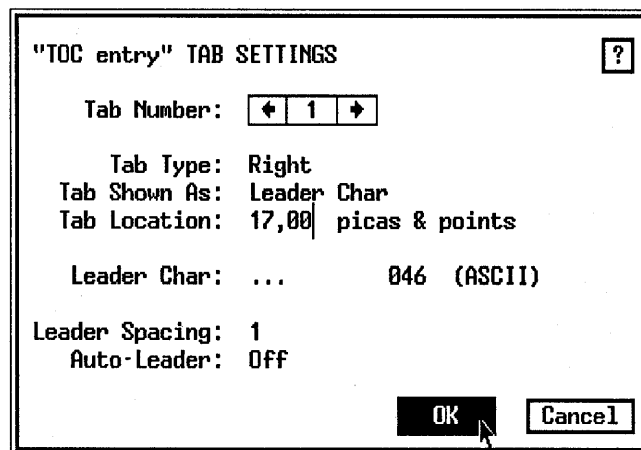

■ Tag the remaining paragraphs in the table of contents as TOC entry. (Hint: use the Shift-Click method to tag them all at once.)

The finished TOC should look like Figure 3–39.

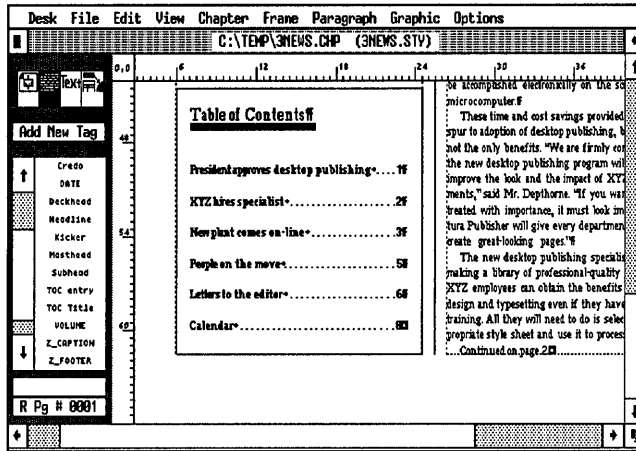

Figure 3-39.

Add the Jump tag

There's only one more paragraph to tag on page one: the jump text.

- Select the paragraph "Continued on page 2."
- Add New Tag Tag Name to Add: Jump
- Font Style: N-Italic
 Size: 010.0 points
- Alignment In/Outdent Width: 00,00 picas & points

➔ **NOTE:** If necessary, adjust the frame size so the text aligns with the bottom of the column guide.

After you finish making these changes, your screen should look similar to Figure 3-40.

Do not be concerned if your screen doesn't match ours exactly. Different monitors and slight differences in frame sizes can vary the position of elements on the page. The important thing is to understand how to adjust for these differences. You may have to experiment with font size or frame size to make the small jump text appear correctly. Remember, we are giving you guidelines, not a rigid structure for creating documents. You should feel free to explore on your own if you don't like the way something turns out.

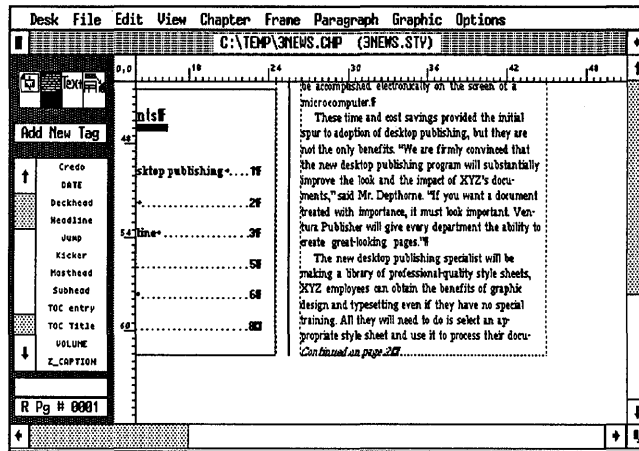

Figure 3-40.



Stopping point

With only a page to go, take a break and admire your work. (Hint: Save what you've done so far before you start patting yourself on the back.) Your efforts have paid off: The newsletter is really shaping up. If you must pause, you can quit now and resume at a later time. Otherwise, continue on to the next section.

Assigning function keys

If you are starting up anew, load Ventura and open the chapter C:\TEMP\3NEWS.CHP. Before you go to page two, we want to introduce another time-saving Ventura feature that speeds up tagging.

Until now you have always tagged text with the mouse while in Paragraph mode. You can decrease formatting time by assigning tag names to Function Keys in the Update Tag List Option (Paragraph menu). By assigning key tags to each of the 10 function keys, you can edit and tag *simultaneously*, without switching back and forth between Text and Paragraph modes. Here's how:

- While you are in Paragraph mode, select Update Tag List from the Paragraph menu.

- ➔ **NOTE:** You can also bring up the Assign Function Keys dialog box by pressing Ctrl-K. If you press Ctrl-K while you are in Paragraph mode, Ventura displays the Update Tag List dialog box. Then you choose Assign Func Keys button to view the function keys. If, however, you press Ctrl-K while you are in Text, Frame, or Graphic mode, Ventura automatically displays the Assign Function keys dialog box.
- If Ventura asks you if you want to Save or Abandon your work, choose Save.
 - Choose Assign Func Key from the dialog box. A list of ten function keys appears.
 - Move to the F2 line and type: **BodyFirst**
 - Now complete the dialog box as shown in Figure 3-41. Make sure you match the existing tag names character for character and space for space. Click OK to return to the dialog box. Click OK again to return to the document. When Ventura asks if you want to Save, Save As, or Abandon the changes to the style sheet, choose Save.

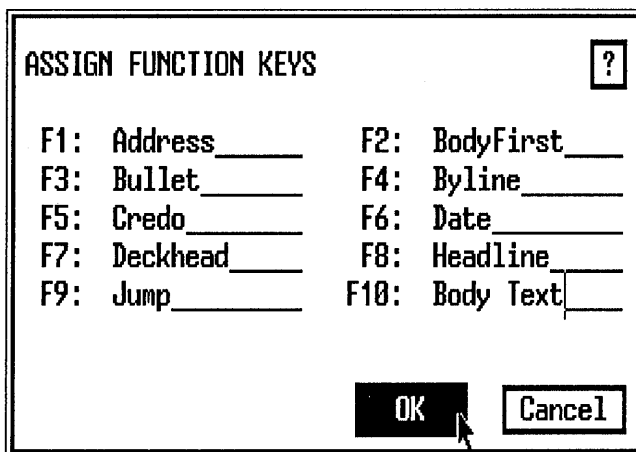

Figure 3-41. The Assign Function Keys dialog box.

Notice that we have listed the tags in the same alphabetical order as they are found in the Assignment List. Alphabetical order makes it easier to remember which tags are assigned to which function keys. However, feel free to use any order that makes sense to you. For instance, you might choose to assign

Head1 to F1, Head2 to F2, and so on. Many people reserve the F10 key for Body Text, to follow the convention established with the style sheets that come with Ventura.

➔ *TIP: It is generally best to assign tag names to function keys in the same alphabetical order as they appear in the Assignment List. If you have more tags than function keys, assign the most commonly-used tags to the ten keys.*

Now go to page two and try out the new function key assignments.

- Press End to go to the last page of the document.
- Go to frame #9. Enable Text mode. Place the text cursor anywhere within the paragraph “By Joe Smith.” Press the F4 key to tag it as Byline (See Figure 3-42).

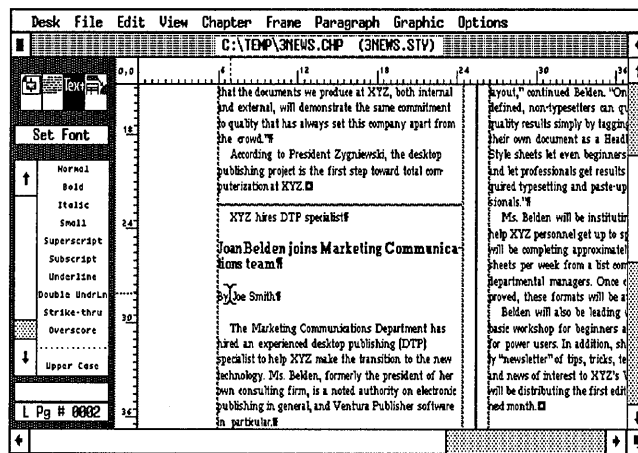

Figure 3-42.

Now you will use the function keys again to tag the first paragraph of the article as BodyFirst.

- Place the text cursor anywhere in the paragraph “The Marketing Communications Department...” Press F2 to tag it as BodyFirst.

- *TIP: If you forget which tags are assigned to which function keys while you are tagging in Text mode, press Ctrl-K to bring up the Assign Function Keys dialog box and review the key assignments. When you are finished, click OK to close the dialog box.*
- Go to small frame (frame #7) at the top of the page. Move the text cursor to the paragraph "Continued from page 1." Press F9 to tag the paragraph as Jump.
- *NOTE: You can use function keys to apply tags, but you must switch to Paragraph mode to change or add tags.*

Change the Z_Header tag

Now you will continue to format page two by adding a ruling line below the header text. As you will see, you can change the appearance of the header just as you can change any other paragraph on the page. The difference, however, is that any changes apply to all the headers throughout the document.

- Enable Paragraph mode. Select the header paragraph "Fall/Winter 1989 Page 2 The Newsletter," (Figure 3-43)

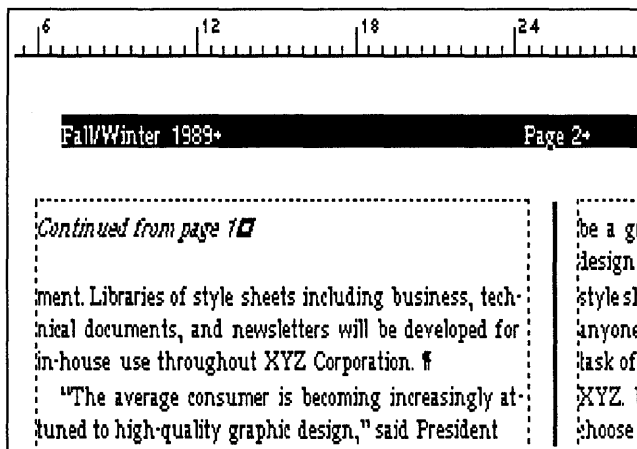

Figure 3-43.

- Alignment Overall Width: Frame-Wide
In/Outdent Width: 00,00 picas & points

- Ruling Line Below
 - Overall Width: Frame
 - Space Above Rule 1: 02.00 fractional pts
 - Height of Rule 1: 10.00 fractional pts

Add a Headline2 tag

Since the original style sheet contained only one tag for headlines, you will add a second tag to achieve a different look. The new Headline2 tag will include a rule with a custom width.

- Select the paragraph “XYZ hires DTP specialist” in frame #9.

- Add New Tag
 - Tag Name to Add: **Headline2**
- Font
 - Face: Helvetica
 - Style: Bold
 - Size: 024.0 points
- Alignment
 - Overall Width: Frame-Wide
 - In/Outdent Width: 00,00 picas & points
- Spacing
 - Above: 24.00 fractional pts
 - Inter-Line: 24.00 fractional pts
 - Add in Above: When Not At Column Top
- Select Ruling Line Above. Choose Width: Custom. Make the Height of Rule 1: 06.00 fractional pts and the Space Below Rule 1: 06.00 fractional pts. Now switch from fractional points to picas & points by clicking on top of the unit measurements several times. Next move to Custom Width, press Esc to clear the line and type: **14,00** and click OK.

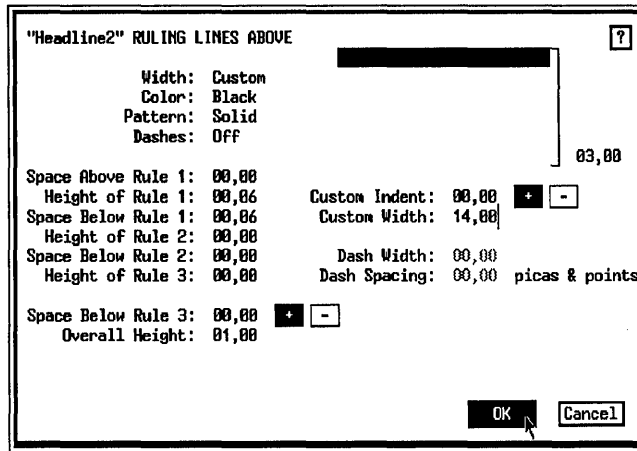

Change the Deckhead tag

Only two more tags to change. Then we will show you how to rename and remove tags and you will be ready to move on to the picture section.

A deckhead is a short lead-in paragraph that follows the headline and introduces the body copy. Change the format of the deckhead paragraph.

■ Select the paragraph "Joan Belden joins Marketing Communications..." in frame #9.

■ Font Face: Helvetica
 Style: B-Italic

■ Spacing Above: 12.00 fractional pts
 Inter-Line: 12.00 fractional pts
 Inter-Paragraph: 00.00 fractional pts

The finished tag looks Figure 3-44:

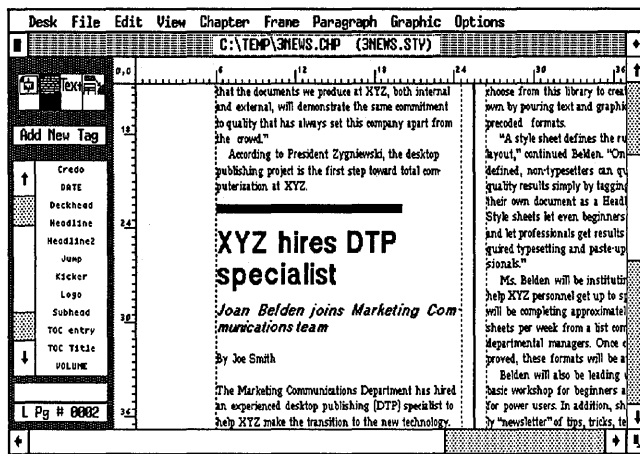

Figure 3-44.

Change the Byline tag

- Select the Byline paragraph "By Joe Smith."
- Font Style: N-Italic
- Spacing Above: 12.00 fractional pts
Below: 00.00 fractional pts
Inter-Line: 12.00 fractional pts

Rename a tag

After tagging the text, take a moment to clean up the Assignment List. Remove tags you don't need, and rename tags with unclear names. When you rename and remove tags, *the results are reflected in the current style sheet and in every other document that uses that style sheet.* If you do not want to rename or remove a tag in every document, remember to choose Save As and enter a different style sheet name when you close the dialog box.

In this section you will rename the tag "Masthead" to "Logo." Then change the DATE and VOLUME tags from all caps to upper and lower case. Since this is the only document so far that uses the style sheet 3NEWS.STY no other documents will be affected by these changes.

- *NOTE: The masthead is a listing of the staff and publisher of the newsletter that is normally placed on the inside or last page. People commonly confuse the terms logo and masthead.*
- Select Update Tag List from the Paragraph menu and choose Save.
- Scroll through the tag name list at the top of the dialog box until you see the name Masthead. Click once on the name to highlight it.
- With the name selected, choose Rename Tag. Move to the New Tag Name line and type: **Logo** then click OK.



- Scroll through the list again and highlight the tag name **DATE**. Choose Rename Tag. Then move to the New Tag Name line and type: **Date**
 - Repeat the step above to rename the **VOLUME** tag to Volume (from all caps to initial capital only).
- *NOTE: Do not use Ctrl-X to bring up the Rename Tag dialog box again. This will cancel the Update Tag List dialog box without saving your changes.*

Remove a tag

- While you are still in the Update Tag dialog box, scroll through the tag name list until you see the name Address. Click once on the name to highlight it. Choose Remove Selected tag, then click OK. The Remove Tag dialog box appears.

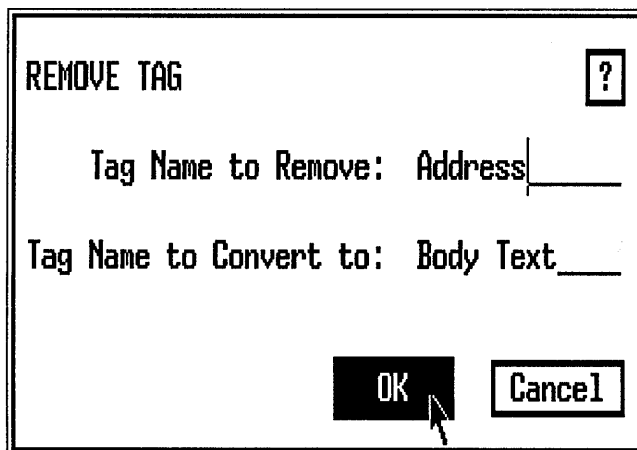

- Click OK again to close the dialog box and choose Save to save your changes.

➔ *NOTE: When you remove a tag, Ventura converts all occurrences of this tag to Body Text unless you tell it otherwise.*

Pictures

Give yourself another pat on the back. You've completed the style portion of this document. With text and style complete, you're ready to add a picture to your newsletter. In this section you will load and place a picture, and then add a caption.

- Make sure you are on page two.
- Enable Frame mode. Click anywhere on the empty frame (frame #11).
- Select CHANEL.IMG from the Assignment List.

The picture is placed into the frame. Now size the picture to fill the frame.

➔ **NOTE:** If the picture is not visible, select *Show This Picture from the Options menu*.

☒ Select *Sizing & Scaling* from the *Frame* menu.

☒ Choose *Fit in Frame* and *Aspect Ratio: Maintained*.

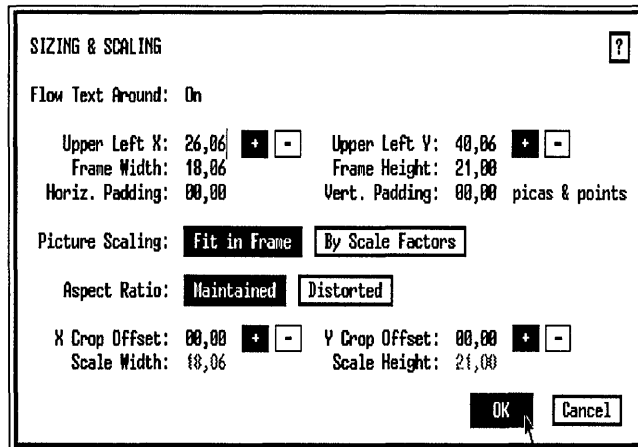

Choosing *Fit in Frame* and *Aspect Ratio Maintained* fits the picture in the frame and maintains the same horizontal and vertical proportions.

Once the picture has been placed, you can add a caption to the frame. In the previous chapter, you created a caption by typing directly into the caption frame. This method allows you to create long captions and edit them in text editing mode.

This time you will create a *caption label*. Caption labels are entered and edited in the *Anchors & Captions* dialog box. *They cannot be entered or changed in text editing mode*. Chapter Nine explains how to use caption labels for automatic numbering. Right now, however, you will simply use this feature to add a short, unnumbered label.

☒ Select *Anchors & Captions* from the *Frame* menu.

☒ Choose *Caption: Above*. Move to the *Label* line and type: **Ms . Joan Belden** and then click **OK**.

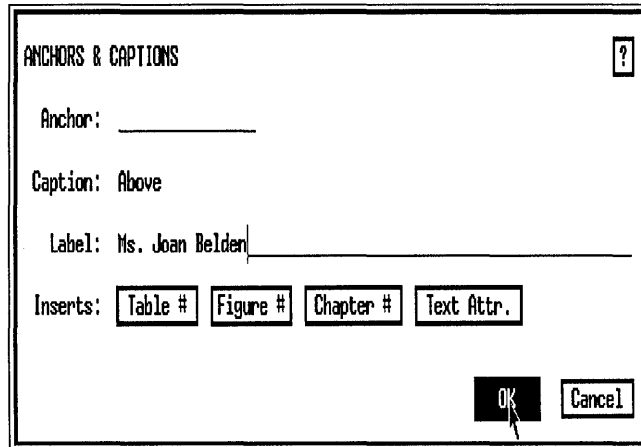

➔ **NOTE:** If the caption frame overlaps the frame above it, don't worry. Later you will resize the frame to fit the space.

At this point you can change the attributes of the caption label you just created.

- Enable Paragraph mode. Select the paragraph “Ms. Joan Belden.”

Notice that the Current Selection Box displays a generated tag name: Z_LABEL CAP. Ventura automatically assigned this tag to the label when you typed it into the Anchors & Captions dialog box. You can change this tag in Paragraph mode as you would any other.

- Font Style: B-Italic
 Size: 010.0 points
- Spacing Above: 06.00 fractional pts
 Inter-Line: 10.00 fractional pts
 Add in Above: Always

After you change the attributes, shorten the caption frame one line length so the caption text is visually separated from the text above.

- Enable Frame mode.
- Select one of the sizing buttons on the caption frame menu and reduce the frame by one line snap unit (Figure 3-45).

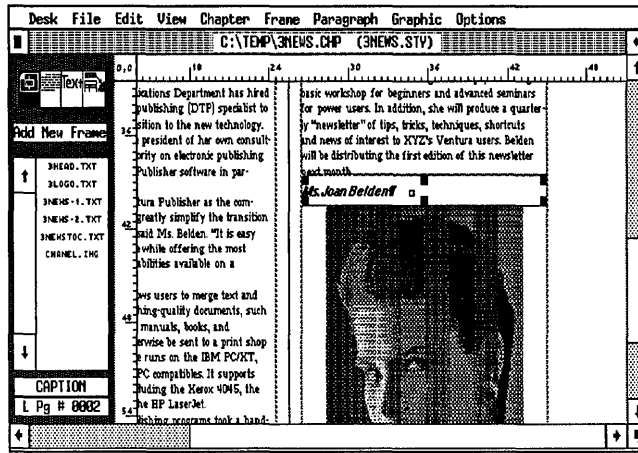

Figure 3-45.

➔ **NOTE:** If you make the frame too small, select *Sizing & Scaling* from the *Frame* menu and make the frame height 02,00 picas & points.

Chapter

Print selected pages

Having added a picture, you are ready to print the newsletter to see the results of your changes. The *To Print* option (File menu) lets you specify which pages to print and the order in which to print them.

- Save the chapter (press Ctrl-S).
- Select *To Print* from the File menu.
- Choose *Which Pages: Selected*. Move to *Through Page*, press Esc, and type: 0002
- Choose *Printing Order: 1st to Last* and click OK.

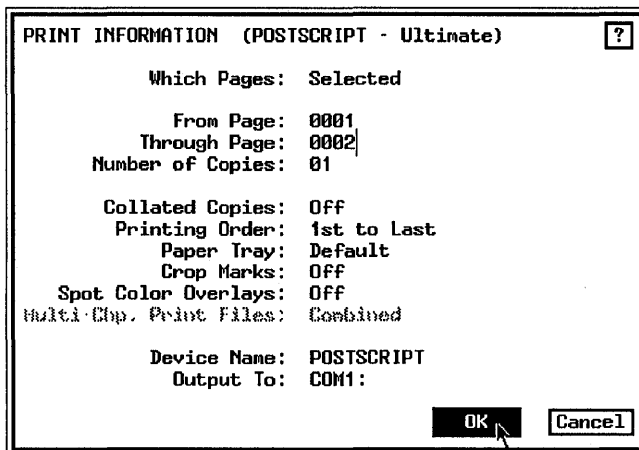

Ventura prints both pages of the newsletter.

➔ *NOTE: Because of the image on page two of the newsletter, the document will take longer to print.*

Understanding set printer info

This is a good point to introduce you to the Set Printer Info dialog box. This selection from the Options menu allows you to change printers. Take a moment to glance through the sample dialog box in Figure 3-43.

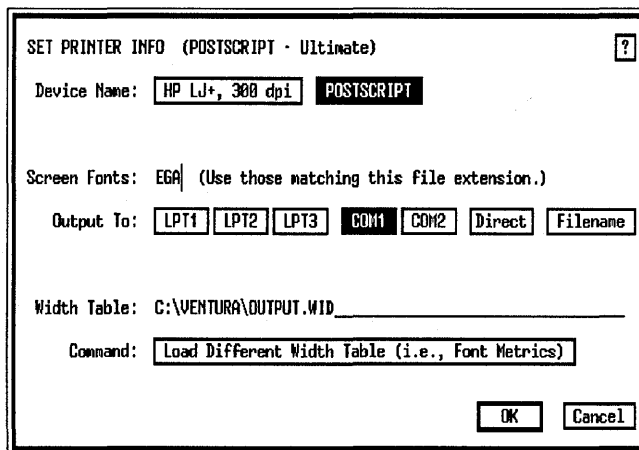

Figure 3-46.

Let's consider each line and its function. At the top is Device Name. As you can see from the example above, this line permits you to choose between different printers. If you installed only one printer during VPPREP then only one printer name will appear on the Device Name line.

➡ *TIP: To add a new printer after installing Ventura, insert Ventura Disk #1 into the A: drive and type VPPREP, just as you did when originally installing the program. Answer No when VPPREP asks you if you are installing for the first time so you will not have to redo the entire installation.*

Switching printers is not as simple as making a choice from the Device Name line. You must also confirm that the width table matches the printer. The width table is a separate file that tells Ventura how much space to allow for each character. The last line in the dialog box, Quality, signals whether or not the width table matches the printer. If Quality says "Ultimate," then you have a correct match. If Quality reads "Draft," you have a mismatch.

Suppose you choose a new device name and notice that Quality says "Draft." To switch to the correct width table, click on the Load Different Width Table button. Ventura will display an item selector. Width tables are clearly labeled with names similar to printer names. Pick the one that matches your printer, then click OK. When you will return to the Set Printer Info dialog box, the Quality line will read "Ultimate."

➡ *TIP: Use Draft quality to mimic one printer with another. For instance, you could use a LaserJet Plus to imitate a PostScript typesetter for proofing purposes. Select the LaserJet device, but use the PostScript width table. Although the output will not be very attractive, the line endings will be accurate.*

The Screen Fonts line enables you to add screen fonts that more closely mimic printed fonts. Adding screen fonts is outside the scope of this project. The Output To line lets you change the printer port. For example, if you switch your printer from COM1 to COM2, there is no need to reinstall Ventura. Just make the correct selection on this line. From then on, Ventura will send its output to the COM2 serial port instead.

The Width Table line enables you to confirm which width table is in use. It is originally set for the default width table, called OUTPUT.WID. Under most circumstances, OUTPUT.WID is the best choice for the documents you create. Ventura saves the name of the width table with the style sheet. As long as a style sheet specifies the default OUTPUT.WID, it can be used on another system, even if that system has a different printer. OUTPUT.WID automatically matches the printer in use on that particular computer.

Back up a publication

You have already encountered Multi-Chapter, which you use to back up individual chapters. You can also combine chapters into what Ventura calls a *publication*. The chapters that make up a publication can be copied or printed as a group.

Create a publication

You will use Multi-Chapter to create a publication called PART_ONE. You will use this publication to back up all three of the chapters you created in the first section of this book.

- Place a formatted floppy disk in the A: drive.
- Select Multi-Chapter from the Options menu. If you haven't saved recently, Ventura asks you to Save or Abandon your changes. Choose Save.

The Multi-Chapter dialog box appears and the current chapter, C:\TEMP\3NEWS.CHP appears highlighted in reverse video at the top of the list.

- Choose Add Chapter.

Ventura displays the Item Selection box.

- With the Backup button, locate the C:\TEMP subdirectory and scroll through the listing until you find the 1REPORT.CHP chapter. Select the chapter.

Ventura returns you to the Multi-Chapter Operations Box. Use the same Add Chapter function to add 2PROPOS.CHP to the publication list.

- Choose Add Chapter. Select the chapter 2PROPOS.CHP.

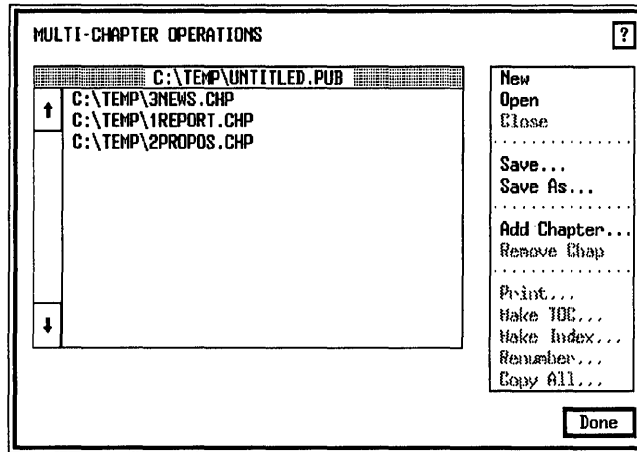

Save the publication

- While still in the Multi-Chapter dialog box, select Save As.
- Use the Backup button to find the C:\TEMP subdirectory and enter the name PART_ONE (notice the underline character between the “T” and the “O”). Click OK.

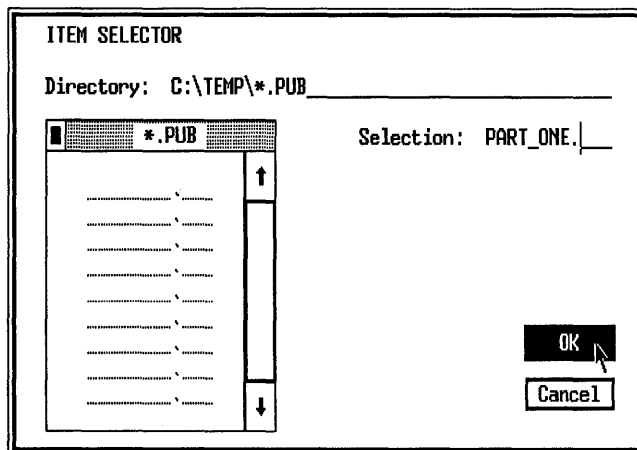

Copy the publication

- Make sure that none of the chapters is highlighted.

If a chapter is highlighted, you will copy just that chapter instead of the publication. To deselect a chapter, click anywhere inside the dialog box.

■ **Select Copy All.**

The name of the publication is displayed at the top of the dialog box. The destination lines show the disk drive and subdirectory to which each file will be copied. Tell Ventura which disk and subdirectory you want to use.

■ **Move the cursor next to the PUB & CHPs: line, press Esc to clear the line and type: A: **

■ **Choose Make All Directories the Same As the First. The click OK.**

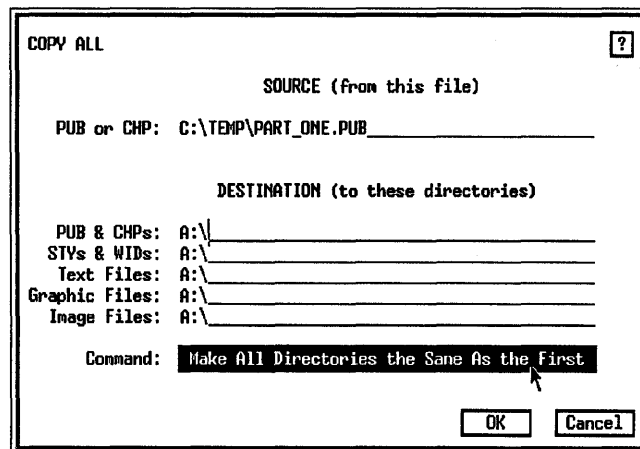

Ventura copies all the files for all three chapters to the A: drive. When the copy function is complete, you return to the Multi-Chapter dialog box.

■ **If you have the time, print the publication by selecting Print from the Multi-Chapter dialog box.**

■ **Choose Done. When Ventura asks you if you want to abandon or save changes made to the publication, click on Abandon to return to the work space.**

Congratulations — you made it through Ventura boot camp. Getting started from scratch is always the hardest part. Now that you've completed basic training you're in shape for al-

most any assignment. You've got the know-how to make documents more professional, more pleasing, and more effective.

In the next section of this book, you will use this fundamental knowledge as the jumping off point. Part Two will teach you to put Ventura through its paces by creating a series of specialized, high-performance documents.

Some of you may not plan to go on to Part Two immediately. We recommend that you skim the theory sections of the advanced chapters even if you can't take the time to complete the exercises. Chapter Four, for instance, introduces the important concept of thumbnail sketches. Thumbnail sketches are such time-and-trouble-savers that some Ventura instructors won't let their beginning students start a document until they have completed a sketch.

Tips and techniques

Frame tips

- To select a frame, click once anywhere inside its boundary while in Frame mode.
- To resize a frame, place the cursor on a sizing button on the edge of the frame and drag with the mouse to the new size.
- To move a frame, place the mouse cursor anywhere inside the frame. Hold down the mouse button until the four-way arrow appears. Then drag the frame to a new location.
- Once you copy a frame into the clipboard, it stays there until you replace it with another frame (or until you exit Ventura).
- You can copy several frames into memory at once. Use Shift-Click to select the frames, then delete them or copy them to temporary memory.
- You can move frames and their contents from one chapter to another using temporary memory. Open the first chapter. Place the frames you want to move onto one page, then copy or delete them to put them into temporary memory. Now open the second chapter. (Abandon the changes to the first chapter so it will revert to its original form.) Enable Frame

mode and press Ins. The frames will appear inside the new chapter.

- If you will be drawing many frames with similar attributes (frame backgrounds, ruling lines, etc.), use the clipboard to speed the process. Draw one frame and change its attributes. Copy it to memory. Now paste copies for the succeeding frames. This is faster than changing line and background attributes one by one for each frame as you draw it.
- Ventura can flow a long text file from one frame to another. Select the first frame and click on the file name in the Assignment List. Now select the second frame and click on the file name again. If you make additions or deletions to the text, it will flow back and forth between the frames.
- Ventura cannot flow text “backwards.” It cannot flow text to a previous page. In addition, it cannot flow text to a previous frame (one that was drawn on the page first).
- Use sizing & scaling from the Frame menu to fine-tune the size and position of frames.
- Think of the Page as a page-sized frame that automatically repeats itself if necessary to accommodate large text files.
- You can change the size of the Page with Sizing & Scaling just as if it were an ordinary frame.
- For documents with several text files, such as newsletters, place text into frames rather than placing it on the Page.
- When creating a newsletter-style document with frames, format the Page first and use it as an invisible snap-to grid for drawing frames.

Text tips

- You can type text directly into frames while in Ventura.
- Text typed in frames is stored in the caption file unless you specify otherwise. To save to a different file, select the frame, then use File Type/Rename from the Edit menu to specify the file name and format you want instead.
- Use the function keys to tag paragraphs while in Text mode. First assign tag names to different function keys using Assign Function Keys from the Update Tag List

dialog box (Paragraph menu). Then you can retag any paragraph in Text mode just by pressing a function key while the cursor is anywhere within that paragraph.

- You can assign a tag to multiple paragraphs in Text mode. Drag the cursor through (or use Shift-Click) the paragraphs you want to tag. When all the text is highlighted press a function key.
- Assign function keys alphabetically, or in any fashion that makes the assignments easy to remember (for example, F1 for Head1, F2 for Head2, etc.).
- If you cannot remember which tags are assigned to which function keys while you are in Text mode, press Ctrl-K to bring up the Assign Function Keys dialog box. Click OK to close the dialog box.
- If you press Ctrl-K while you are in Paragraph mode, Ventura displays the Update Tag List dialog box. Choose Assign Function keys to review the function key assignments. Then click OK twice to return to the work space. If you are in Text, Frame, or Graphic mode, Ventura automatically displays the Assign Function Keys dialog box.

Style tips

- To place two tags on the same line, give the first tag a line break before. Give the second tag a line break after.
- There are two ways to keep two tags on the same line from overlapping. First, you can align one flush left and the other flush right. This method is satisfactory as long as the text is short enough that the tags will not meet in the middle and overlap each other. Second you can use In From Left and In From Right (Spacing, Paragraph menu) to confine each tag to a specific area.
- Create leader dots with the Tab Settings dialog box. Instead of showing the tab as an open space, show it as leader dots. The dialog box also lets you vary the spacing between the dots.

Picture tips

- Use Ventura's caption label function for brief captions, or captions that must be numbered (for example, "Figure 1-1"). Use the Anchors & Captions dialog box to type them in or to edit them. Longer captions are typed directly into the caption frame in Text mode.
- Caption labels are automatically tagged by Ventura and can be modified in Paragraph mode like any other paragraph.

Chapter tips

- Use the Last to 1st print option if your printer produces pages face up. If it puts out pages face down, use the 1st to Last option.
- You can install additional printers by reusing the VPPREP installation program. You will not have to go through the entire process. Ventura will only copy over the new fonts and drivers you need.
- Use Set Printer Info from the Options menu to switch from one printer to another. Be sure to change width tables at the same time.
- You can mimic one printer with another by using a different width table. The most common use of this capability is to use a non-PostScript laser printer to preview pages that will ultimately be sent to a PostScript typesetter.
- To copy or print several chapters at once, place them into a publication using Multi-Chapter from the Options menu. Then copy or print the entire publication.

Chapter Four Skills Checklist

Theory

- How Graphic mode works
- Easy drawing with the snap-to grid
- When (and when not) to use Box Text
- Modifying generated tags

Text

- Typing and editing Box Text

Style

- Adding text attributes to the header
- Line and fill attributes
- Using leader dots for a tear off line
- Creating an underscore
- Number lists with decimal alignment

Pictures

- Enhancing graphic shapes with line and fill attributes
- Adding lines and arrows
- Showing graphics on all pages

Chapter

- Updating page counters
- Inserting a page
- Printing multiple copies

Chapter Four

An Invoice

Welcome to Chapter Four, where you will learn a simple but highly effective strategy for creating a standard business form. In this first advanced chapter, we will be showing you a lot of new techniques and features. The checklist on the left lists some of the skills you will learn.

Like all of the advanced section, Chapter Four assumes that you understand the basics from Part One. We will move faster than we did before. We will assume you can handle standard functions such as loading and placing files, adding and changing tags, etc., with a minimum of instructions. We will save step-by-step explanations for techniques you haven't seen before.

Theory

Most of this chapter's sample document is built using Ventura's Graphic mode. You will find it easier to follow along if you understand these three important concepts:

- How Graphic mode works
- The snap-to grid
- Box Text

Graphic mode

Ventura has tools for building lines, circles, rectangles, and Box Text (text inside a rectangle). You can use these shapes to draw simple artwork, create tables, add crop marks, annotate illustrations from other programs, or to build forms. Once you've learned to operate these tools, you'll find important

uses for them in many kinds of documents. Nevertheless, we recommend using a specialized, stand-alone graphics program to create complex illustrations, just as we recommend using a stand-alone word processor to create more than a paragraph or so of text.

How graphic mode works

The five key points explained below will help you understand how the Graphic mode operates. We use the term *shape(s)* to refer to lines, boxes, or circles created in Graphic mode.

➤ *Key Point #1: Every shape is attached to a "parent," which can be a frame or the Page.*

If you move, copy, or delete the parent, the shapes are moved, copied, or deleted as well.

➤ *Key Point #2: The parent is the frame or Page that is active when you select a graphic shape.*

The parent can be the Page itself, or a frame on top of the Page. Anything you draw is attached to that parent. In both Frame and Graphic mode, look for the sizing buttons that indicate which frame is active (Figure 4-1).

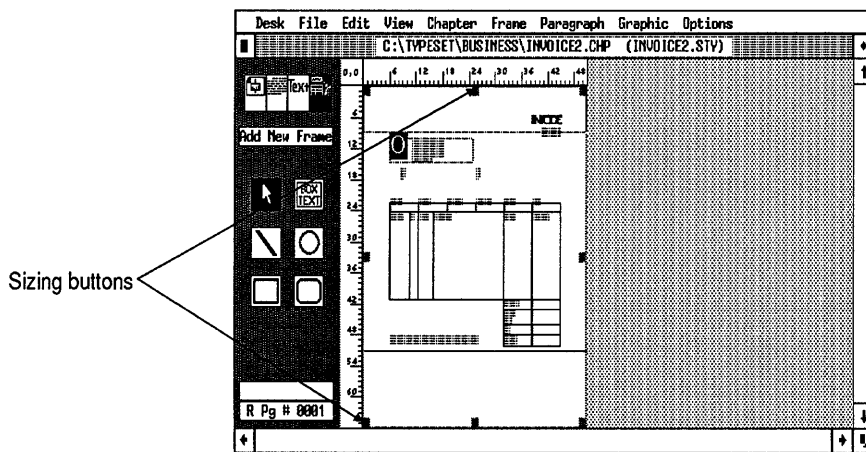

Figure 4-1. Sizing buttons are displayed around the edge of the active frame or Page.

➔ **Key Point #3:** *Shapes do not have to be near the parent frame, but they must be on the same page.*

There is no restriction on the placement of shapes on a page. They can be inside the parent frame; touching the parent frame; or completely removed from the parent frame, *as long as they are on the same page*. For instance, you could place a tiny frame in the upper left corner of the page, and then draw a shape in the lower right corner. That shape would still be tied to the parent, even though the two are nowhere near each other on the page (Figure 4–2).

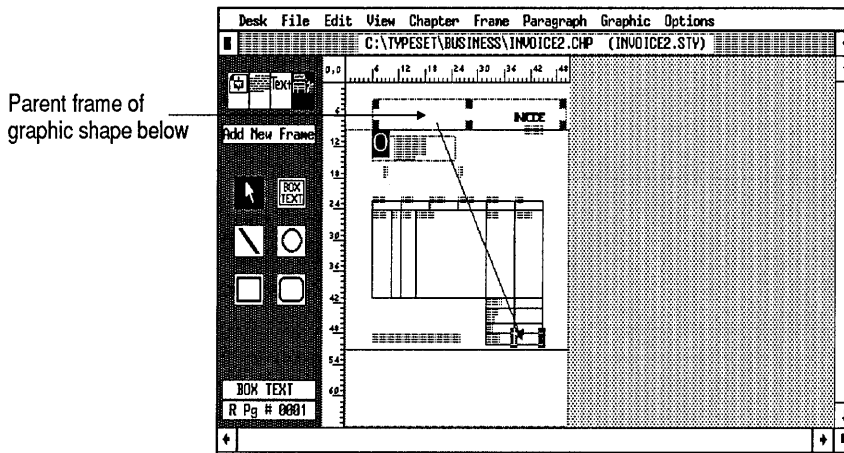

Figure 4–2. You can place a graphic shape anywhere on the page. It doesn't need to be near the parent frame.

➔ **Key Point #4:** *Different shapes can have different parents even if they are on the same page.*

To choose a new parent frame, select a new frame in Graphic mode. The new frame will be the parent to any shapes you draw from now on.

➔ **Key Point #5:** *You can make a shape repeat on all pages of the document.*

Normally, when you draw a shape on the Underlying Page it appears only on that page. If you want to make the shape appear in the same position on every page of the document, you select Show On All Pages from the Graphic menu.

↳ *NOTE: In earlier versions of Ventura, the shapes you attached to the Underlying Page automatically repeated on every page in the document. In Version 2, you must select Show On All Pages (Graphic menu) to make the shapes display throughout the document.*

The five points above are the major factors to consider when using Graphic mode. There are additional tips at the end of the chapter. If you have never used Graphic mode before, you may want to read through the tips now. Then, after you've had some practice drawing shapes, you can review the list again.

The snap-to grid

The most important part of graphics drawing is getting shapes the right size and position. Ventura's Column Snap and Line Snap functions do not work in Graphic mode. Fortunately, Graphic mode has its own snap-to grid function.

The snap-to grid is the secret to working painlessly and productively in Graphic mode. If you know how to set up a good grid, Ventura does the hard work for you. The Grid Settings feature is found in the Graphic menu. It allows you to turn the grid snap on and off, and to set the horizontal and vertical grid spacing.

The invisible grid starts from the upper left edge of the page, dividing it into horizontal and vertical units. Take a look at Figure 4-3, which shows how a typical grid would appear if its lines were visible. Figure 4-3 has both horizontal and vertical units set to six picas. The tick marks on the ruler show that the first grid lines begin six picas from the left edge of the paper and six picas from the top edge of the paper, and continue in six-pica increments.

The grid acts like a magnetic field. Any shape you place on the Page snaps to the nearest invisible line. You cannot misalign a shape; Ventura won't let you. With the grid shown in Figure 4-3, for example, you can draw a box that is six picas on each side; or 12 picas; or 18 picas — or any shape with measurements in units of six (Figure 4-4). You cannot, however, draw a 10-pica box. To do that, you would have to change the grid settings to 2, 5, or 10.

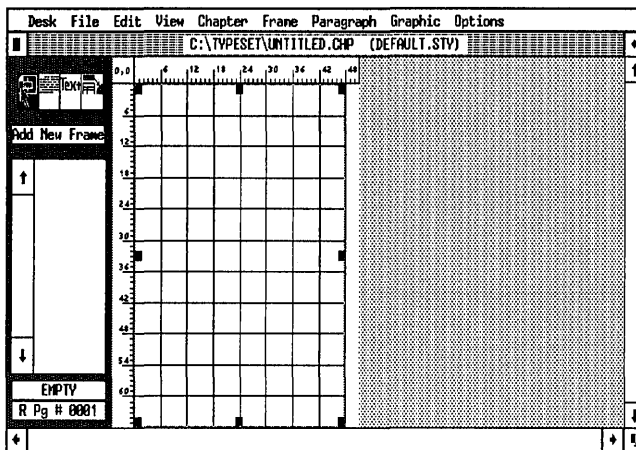

Figure 4-3. If you could make the snap-to grid visible, you would be able to see how it divides the page into horizontal and vertical units.

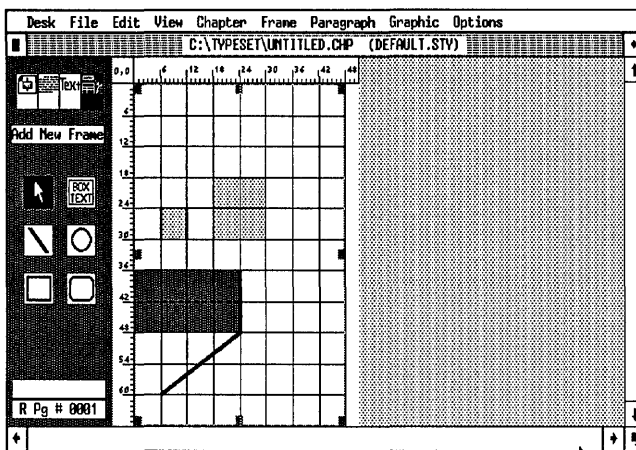

Figure 4-4. Any shape you place on the page automatically snaps to the nearest grid unit. (Grid made visible for illustration purposes only.)

Planning the grid

Once you understand that the grid is measured from the upper left corner of the page or frame *no matter what the margin settings are*, then you can plan the grid settings to coordinate with the overall page design.

First you must consider the size of the grid setting. With a large grid setting it is harder to make mistakes. If you want to

draw six-pica boxes and you set the grid at six picas, it will be hard to go wrong.

Next consider the margin settings. For instance, to draw a row of six-pica boxes across the page, you might set your page margins *and* your grid settings to six picas. The grid would let you line up the shapes with the margin. But if you were drawing those same boxes on a page with four-pica margins, the boxes would not line up with the margin. The grid would allow the shapes six picas from the edge of the paper, or 12 picas, or 18 picas — but not four picas (Figure 4–5).

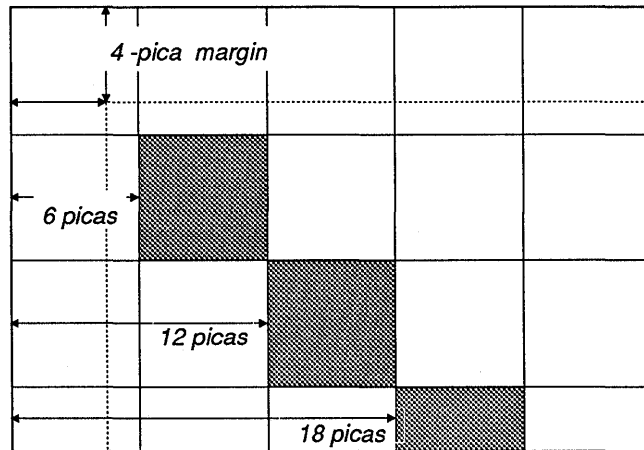

Figure 4–5. The six-pica shapes will not align with the four-pica margin in this illustration. To line up boxes with the margins, make the grid setting a common denominator of the shapes and the margins.

To line up boxes with the margins, set the grid *to the common denominator of the shapes and the margins*. For instance, you might choose two picas for the grid setting in the example above. Two picas is the lowest common denominator between the six-pica boxes and the four-pica margins. You could even turn the grid off and align the boxes by eye. However, you will never be as accurate manually as Ventura’s automatic grid.

In some cases, you might want to change the grid as you go along. For instance, you might select six picas to draw six-pica boxes, then switch to two picas to draw narrower boxes. Be careful, though. If you change the size of the boxes you have already drawn, they will automatically snap to the new grid settings.

➤ **NOTE:** Each frame can have a different grid setting. If you are working inside multiple frames, make sure they all have the same grid settings to avoid confusion.

You will learn more about how to use the snap-to grid by following along with this chapter's project.

Box Text

Box Text is the third and final concept you should understand before tackling the invoice. Box Text is a special type of graphic shape. It is drawn, placed, and sized just like an ordinary rectangle. But when you release the mouse key, the *end of file marker* (□) appears inside the rectangle. Then you can switch to Text mode to type your own text directly into the box (Figure 4–6).

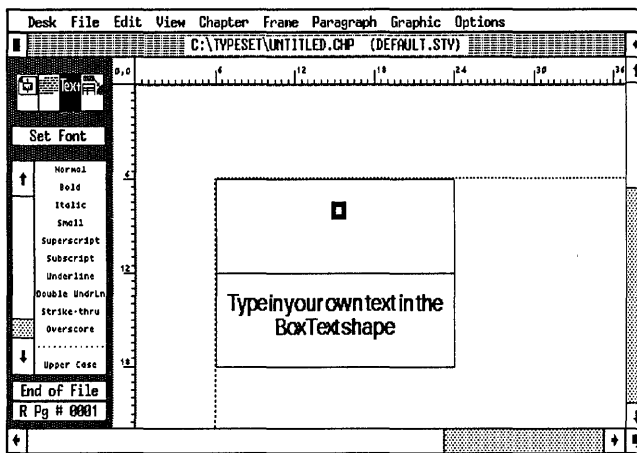

Figure 4–6. Type your own words into the Box Text shape.

The name *Box Text* leads some users to believe that the text must always appear inside a visible rectangle. In fact, you can make the rectangle “invisible” so the text is the only thing that shows. This is a convenient way to stick a word or two anywhere on the page without regard to the margin or frame boundaries. Box Text, like all shapes, can appear anywhere on the same page as the parent frame (or Page).

You can vary the lines and the background shading of Box Text to create a variety of effects (Figure 4–7). When combined with Ventura's line drawing function, Box Text is a handy way

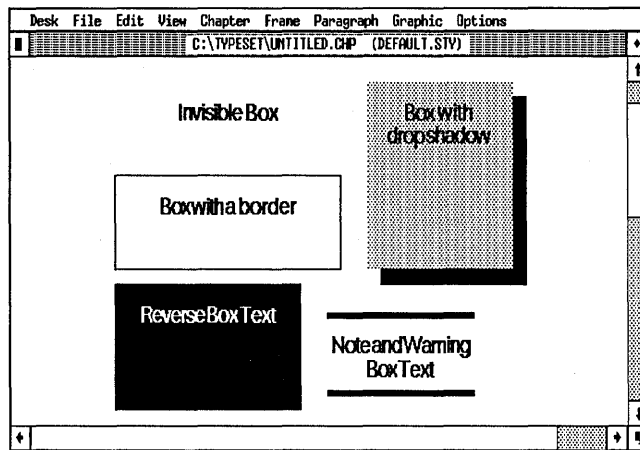

Figure 4-7. By changing Box Text's line and fill attributes, you can create a variety of effects.

to create callouts — labels that point to a particular feature of an illustration.

WARNING: Not all of the effects shown in Figure 4-7 are available with all printers.

You may have to test your printer to see just how well it performs at overlapping one graphic shape with another. With many PostScript printers, for example, you cannot place Box Text with a white background over a frame with a pattern background. The Box Text will show on screen, but it will not print out. Here's how to trick most PostScript printers into printing overlapping graphics: First draw a solid white rectangle shape over the frame background. Then place a white, hollow, transparent Box Text shape on top of the rectangle. This double overlap effect allows you to print out Box Text shapes on patterned backgrounds.

Box Text versus frame text

In some ways, Box Text resembles text in small frames. Indeed, there are many situations when you can create the same effect with frame text as with Box Text. Perhaps the easiest way to distinguish between them is to say that frame text can be a separate file (if you want it to be). Box Text, by contrast, must always be typed by the user directly into the chapter,

where it is stored in the caption file. As a general rule, you should use frames to place more than two dozen words or so. Use Box Text to place smaller amounts of text. At the end of the chapter we give you more tips on when to use frames and when to use Box Text.

Box Text versus rectangles

A final point about Box Text: Sometimes you should use it instead of the standard rectangle drawing tool. If you simply want a box without any words inside, the rectangle tool is fine. But if you think that you might want to place text inside at any time, use the Box Text tool instead. You will be able to type text into this rectangle at a later time.

For example, when creating the form in this chapter, we used Box Text to build all the empty boxes and columns. Because of this, an operator could fill in the form on-screen (Figure 4–8).

| Order No. | Order Date | Customer No. | |
|--------------|------------|--------------|--------------------|
| #1234 | 11/4/88 | 345009-90 | |
| Qty. Ordered | Unit | Item No. | Item Description |
| 1 | 1 | 23409 | 4 1/4" Cedar Table |

Figure 4–8. Use Box Text instead of a rectangle if you plan to enter text inside a shape.

The Z_BOXTEXT tag

Now that you understand the graphic capabilities of Box Text, let's take a closer look at the "text" part of Box Text. Box Text, like headers, footers, and captions, is a generated tag (Z_BOXTEXT). You can format it with the attributes in the Paragraph

menu, rename it to another tag, or remove it from the Assignment List. In this chapter's invoice, for example, all the text is created via Box Text, then formatted with different tags from the style sheet.

After reading the theory behind Graphic mode, you're ready to put the theory into practice. While you work on the invoice, you may find it helpful to refer back to this theory section or refer ahead to the tips at the end of the chapter.

Before

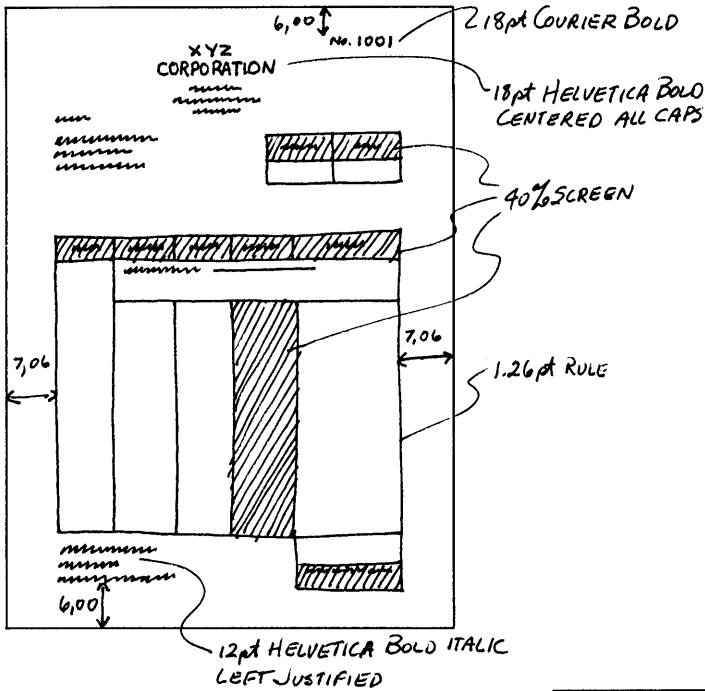

After

No. 1001

XYZ CORPORATION
123 Main Street
Los Angeles, CA 90000
(213) 555-1111

Ship to:
International Paper Co.
1701 Broad Street
Philadelphia, PA 19000

| Please Return Top Portion With Payment | | Amount of Payment \$ | |
|--|--------|----------------------|--------|
| DATE | AMOUNT | DATE | AMOUNT |
| PREVIOUS BALANCE | | | |
| | 150.00 | 150.00 | 60.00 |
| | 150.00 | 60.00 | 160.00 |
| | | \$200.00 | |

XYZ CORPORATION
123 Main Street
Los Angeles, CA 90000

PLEASE PAY THIS AMOUNT

Planning the invoice

An invoice is a standard business form for billing information. Its goal is to present separate categories of information in an orderly fashion, while making the most important numbers stand out. For example, you want it to be very easy for your customers to spot how much they owe you. Our example uses boxes, lines, and shading to differentiate and clarify information.

There are other design considerations. For instance, many invoices are divided into two parts so customers can return one portion with their payments. The design should include a place for the company address on both halves of the form, so customers know where to write or call even if they have already sent off the other half. In addition, the customer's mailing address should be positioned to show through a standard-size window envelope.

The method of fill-in must also be part of your planning. If the form will be filled out with a typewriter, make the (Body Text) inter-line spacing in increments of one pica, so it matches the standard line spacing of typewriters. If it will be filled out by hand, make sure the blanks and boxes are large enough for easy writing.

The invoice you make can be used as a camera-ready master and sent to a printer, or it can be filled in on-screen on an "as needed" basis.

A thumbnail sketch

It is easier to work with Ventura if you draw a simple thumbnail sketch before starting. In the first three chapters, the "after" versions of the sample documents have served this role. As you begin creating documents of your own, spend a few moments planning the design with pencil and paper before loading Ventura. Creating a thumbnail sketch forces you to do some hard thinking and decision-making up front.

The suggestion to "start with a thumbnail sketch" is probably found in more books on page design than any other piece of advice. Certainly, advance planning can speed the process of

producing pages in Ventura. Here are a few of the elements to consider as you draw the sketch:

- Margins
- Columns
- Gutters
- Size of frames or Box Text
- The upper left starting position of frames or Box Text on the page

Do as many of the calculations as possible while preparing the sketch. Jot down dimensions and positions of key page elements. While you're at it, figure out the horizontal and vertical grid units by finding a common denominator between the margins and the size of the shapes. It is much easier to do calculations on paper than in your head while staring at a dialog box.

Look at the pictures of the thumbnail sketch and the final version of the invoice. Here are some of the techniques you will use to achieve these effects:

- Snap-to grid
- Black type on a patterned background
- Lines and line attributes
- Box Text, rectangles, and tint screens (fill patterns)
- Automatic invoice numbering in the header
- Dotted tear line

Ventura prep

As always, prepare for the project by loading and renaming files to their proper location.

Start a new chapter

If you are continuing directly from Chapter Three, select New from the File menu to start a new chapter. Selecting New

removes the current chapter and text from your screen, but retains the current style sheet.

- Select New from the File menu.



If you have the Power disk

If you have the Power disk, complete the next two steps, then skip to the text section.

- Use Load Diff. Style to load the style sheet 4FORM.STY from the C:\POWER subdirectory. Then select Save As New Style to save and rename it as C:\TEMP\4IN-VOICE.STY.

Save and rename the chapter so you can safely save your progress under the correct name just by pressing Ctrl-S.

- Select Save As and save the chapter as C:\TEMP\4IN-VOICE.CHP.

➔ *NOTE: Save As makes a copy of the files (.CHP, .VGR, .CIF, etc.) linked to the chapter. It does not make a copy of the picture files.*

Since all the text for this document is created with Box Text shapes, you do not need to type in a separate text file for this project.



If you do not have the Power disk

You will find it a bit more difficult to follow along without the Power disk in the advanced section. The Power disk includes sample style sheets, text files and (in a few cases) sample chapters with most of the basic work done already. You need only work on advanced techniques and skills to complete the document.

Nevertheless, with just a bit more work on your part it is possible to complete all the sample documents without the disk. In general, you must take these four steps:

1. Type in the text file for that chapter from Appendix A using a word processor. Then load it into the \TEMP subdirectory.
2. Load one of the style sheets that come with Ventura instead of the style sheet from the Power disk. In each advanced chapter, we give you brief suggestions on which style sheets to use and what modifications to make.
3. Modify the columns and margins as necessary to match the Power style sheet using the illustrations provided.
4. Find the tag table in Appendix B and change or modify the tag attributes. The tag table describes the style sheets that come with the Power disk. If you don't have the disk, you must enter these attributes manually before you start the project.

For this chapter, we recommend starting with the &INV-P1.STY sheet from the \TYPESET subdirectory. (If you cannot find it, then copy the style sheet from the original Ventura Examples Disk.)

- Load the &INV-P1.STY style sheet into the new chapter and then save it under the new name C:\TEMP\4INVOICE.STY. Change the margins and columns to match Figure 4-9.

If you do not have the Power disk, manually format your Page as shown in the Figure 4-9.

- Change the tags to match the attributes provided in the tag table in Appendix B.

All the text in this chapter is created with Box Text. You do not need to load a separate text file.

After loading and renaming the style sheet, save and rename the chapter file.

- Select Save As from the File menu and save the chapter as C:\TEMP\4INVOICE.CHP.

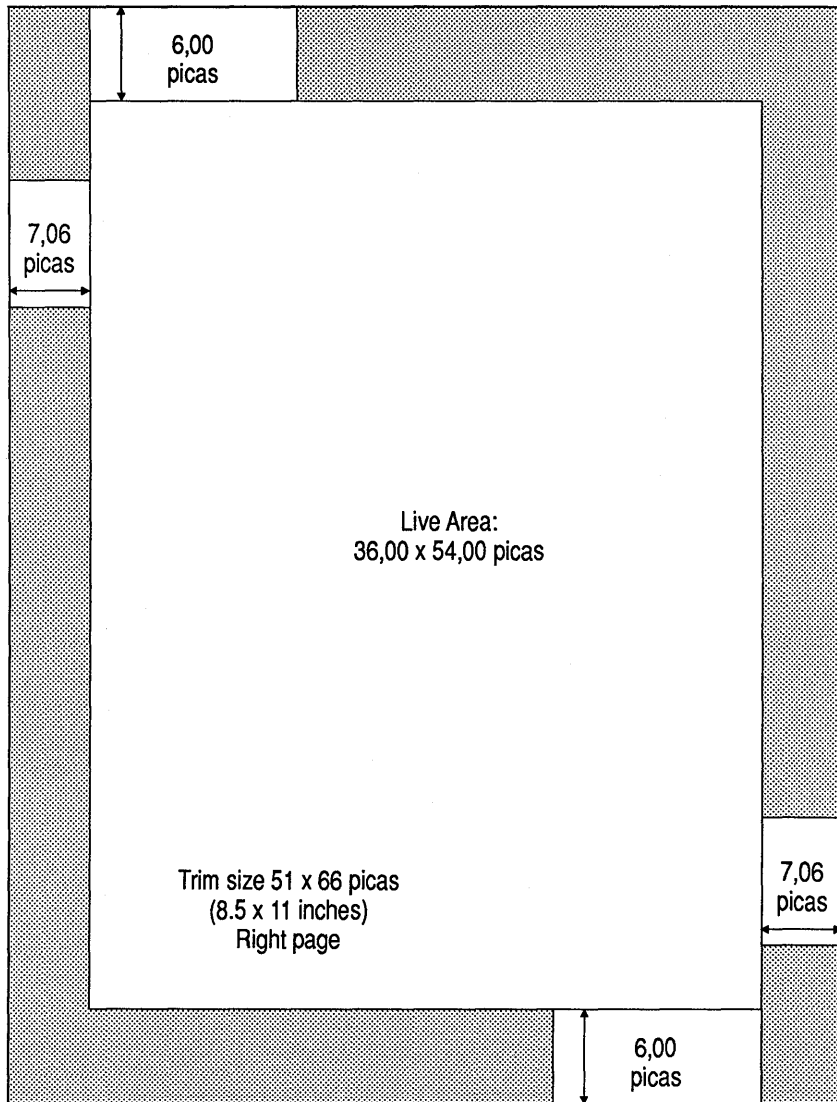

Figure 4-9 The margins and column settings for the Invoice.

Text

The Ventura Formula provides a solid strategy for completing most documents, but you must vary it slightly for documents where you place text in frames and boxes. In Chapter Three, for example, you placed text files *after* building frames to contain them. Similarly, to create this chapter's invoice you will add text *after* building boxes. Here's the order to follow:

- Format the Page
- Build a snap-to grid
- Draw the Box Text shapes
- Add your own text to the boxes

After you enter the text to the boxes you can proceed with the rest of the Ventura Formula.

➔ *NOTE: The Ventura Formula is a handy rule of thumb to get you started. As you become more proficient, you will discover new strategies to fit your personal style.*

Style

Whether you loaded the style sheet from the Power disk or recreated it on your own, you should have the correct values for the paper size, starting page, and margins and columns. To complete the chapter layout you only need to enter the header text. Header text is not stored in the style sheet (although the header *format* is).

Build the header

Since you learned how to create basic headers in Part One, we are now going to show you some advanced techniques.

You already know that you can change the attributes of the header text using the Paragraph menu. In this example, you will learn how to make similar format changes using text attribute codes in the Headers & Footers dialog box. By using the dialog box, you can make part of the header display in one

format (which you set in the dialog box) while another part displays a different format (which you set with the Paragraph menu).

If you refer back to the “After” picture earlier in this chapter, you will notice that the “Invoice No.” portion of the header displays in 14-point Times, but the “1001” portion is in 18-point Courier Bold. Now we will show you how to achieve this effect.

Change text attributes in the dialog box

In the instructions that follow, you will change text attributes in the Headers & Footers dialog box. To do so, you will make use of the buttons at the bottom of the dialog box to enter a generic code. After you choose a button, you must then erase part of the code and put in the information you want to use. For instance, choosing the Text Attr. button inserts the code <D>, which is the code to turn off all text attributes. To turn *on* the text attributes you want, you must substitute another code inside the brackets. For instance, you could substitute the letter B inside the brackets to specify bold or I for italic. Keep in mind that all the buttons in the dialog box merely serve as a shortcut. You could just have as easily typed or <I> right from the start. However, most people find that it is faster to use the buttons, since they eliminate the need to memorize the correct codes.

➡ *NOTE: The buttons at the bottom of the dialog box are for convenience only. If you prefer, you can type in the codes without using the buttons.*

- Select Headers & Footers from the Chapter menu. Choose Define: Right Page Header, Usage: On. Move to the Right line and type: **No**. followed by a space.
- Choose the Text Attr. button and delete the letter “D” (do not delete the right and left brackets). Then type the following codes inside the brackets: **BF1P18**

You have just inserted the codes for three text attributes. Let's look at each one in turn.

- B tells Ventura to make the following text bold.
- F1 tells Ventura to switch to font #1, which is Courier. (Ventura assigns numbers to fonts. The Xerox Ventura Publisher Reference Guide lists the font number codes).
- P18 tells Ventura to change the point size to 18 points.

Now you will tell Ventura to display the current page number after the word "No." As you will see, Ventura's page counter will then automatically number the invoices in sequence when you add a new page.

- Move the cursor after the right bracket and choose Inserts: Page #. The page numbering code [P#] appears on the line.

To complete the header dialog box, turn off the attributes at the end of the line.

- Choose Inserts: Text. Attr.

The last <D> symbol tells Ventura to return the font to normal.

Make sure the dialog box looks like Figure 4-10:

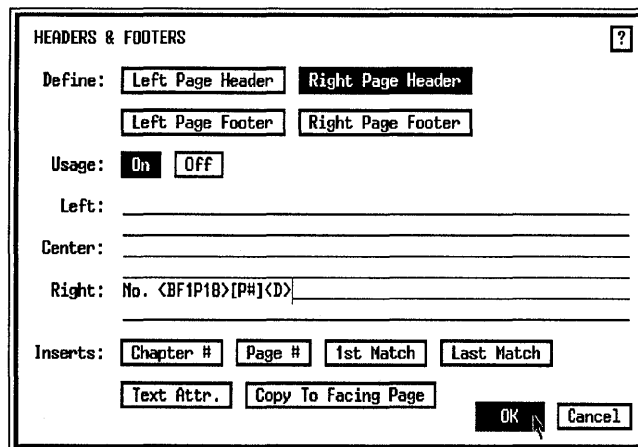

Figure 4-10.

After you close the dialog box, the header appears at the top right corner of the page (Figure 4-11).

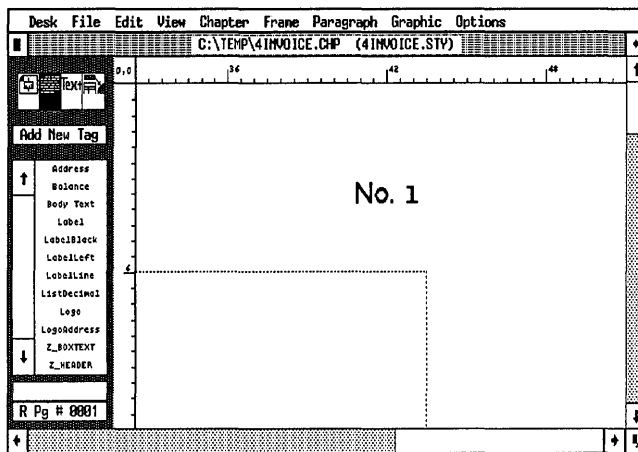
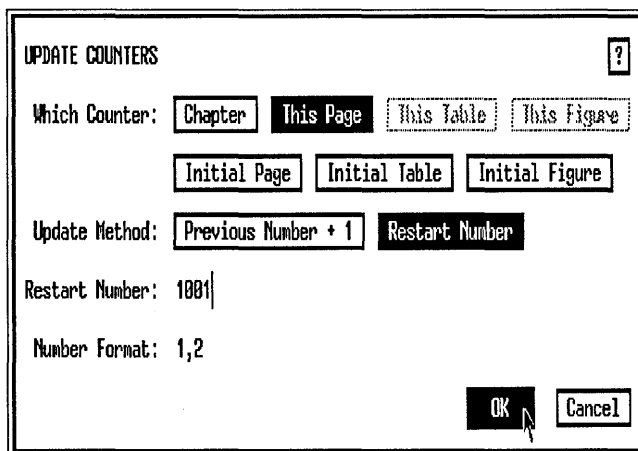

Figure 4-11.

Change the page number

Right now the header displays the number 1. With Ventura's Update Counters feature, you can make a document begin on any page number. For example, let's make the first page start at 1001.

- Select Update Counters from the Chapter menu. Choose Which Counter: This Page, Update Method: Restart Number, Restart Number: 1001, and Number Format: 1,2.



When you select Which Counter: This Page, you change the numbering starting with the current page only. On the other hand, when you select Which Counter: Initial Page, Ventura resets the numbering starting with the first page in the document. In both cases, the subsequent pages follow sequentially.

Since the invoice number is based on the current page number, it will change as soon as you click OK and return to the page (Figure 4-12).

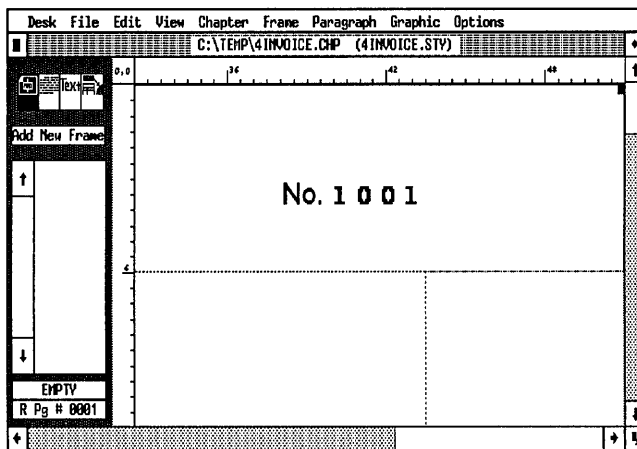

Figure 4-12.

Once you finish the header, the chapter layout is complete. Now you can begin to add the boxes, starting with the lower half of the form and then continuing with the top half. The dimensions in Figure 4-13 will help you gauge the size of the shapes.

Reset the zero point

It's easier to draw the invoice shapes if you reset the zero point of the ruler so it lines up with the upper left corner of the column margin. Here's how:

- Change to Reduced View (press Ctrl-R).

- Place the cursor on the zero point square (0,0) in the upper left corner of the Page. Press and hold the mouse button until the four-way arrow appears. Drag it downwards until the horizontal and vertical crosshairs line up with the upper left corner of the column margin. Then release the mouse button. Notice that “0” on the horizontal and vertical rulers now lines up with the upper left corner of the column margin (Figure 4–14).

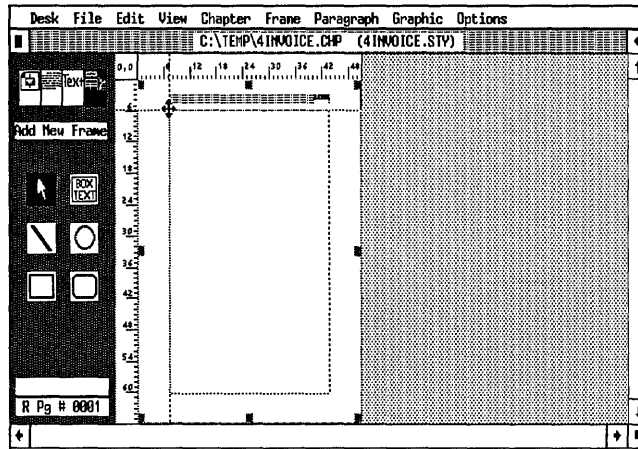

Figure 4-14.

WARNING: If you do not reset the zero point as we explained above, your horizontal and vertical rulers will not match the rulers we show in the project's illustrations.

Select grid settings

After you reset the zero point, you are ready to draw.

To help you accurately line up graphic shapes, you should use Grid Settings from the Graphic menu. You will set the horizontal and vertical spacing to the largest common measurement between the margins and the graphic shapes. In this example, we recommend that you set the horizontal spacing to 01,06 picas & points and the vertical spacing to 03,00 picas & points.

- Enable Graphic mode (click on the Graphic button in the Mode Selector).
- Select the Box Text tool from the Side-Bar.

- Now select Grid Settings from the Graphic menu. Change the unit measurements to picas & points.
- Choose Grid Snap: On. Make the Horizontal Spacing: 01,06 picas & points and Vertical Spacing: 03,00 picas & points. Click OK.

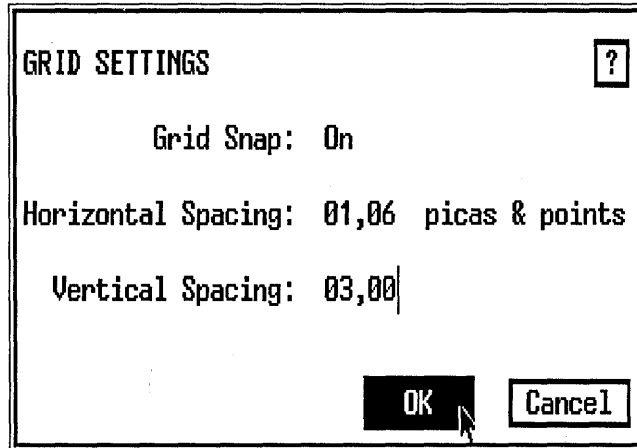

Draw Box Text

- Place the upper left corner of the Box Text 21 picas down from 0,0 so it lines up with the left page margin.
- Drag (press and hold down the left mouse button) the box downwards and to the right until it lines up with position 51 picas on the vertical ruler and 6 picas on the horizontal ruler. Release the mouse button (Figure 4-14).

The end of file marker (□) appears inside the shape.

➔ **NOTE:** You may have to change to Normal or Enlarged View to see the end of file marker.

If you need to change the dimensions of a shape after it is drawn you can resize it with the cursor. Place the cursor on one of the black sizing buttons around the outside of the shape. Then press and hold the mouse button until the pointing hand appears. Stretch the shape to the new size and release the mouse button. To delete a shape, select it and press the Del key (or select Cut Graphic from the Edit menu).

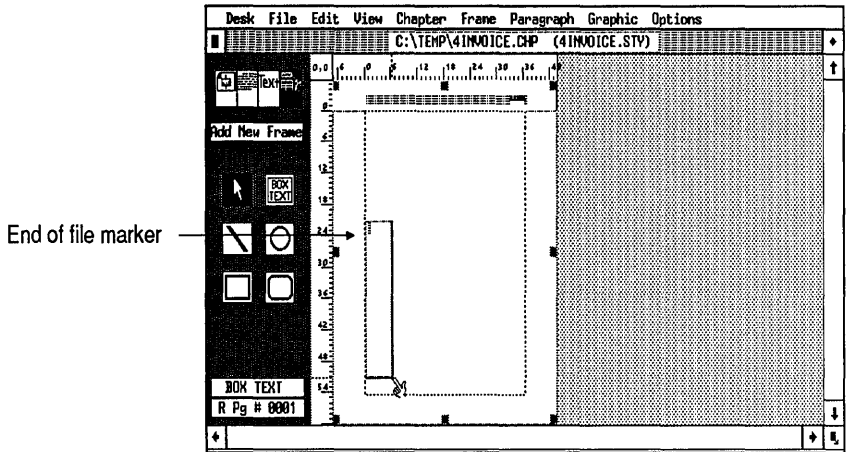

Figure 4-15.

- Now move the shape until it snaps to the horizontal and vertical grid.

Change line attributes

When you are satisfied with the size of the first Box Text, save the line and fill attributes so they will automatically apply to the other Box Text shapes you draw.

- Select Line Attributes from the Graphic menu (or press Ctrl-L).
- Choose Thickness: Thin and Color: Black. Make both End Styles: Square. Choose Save To and click OK.

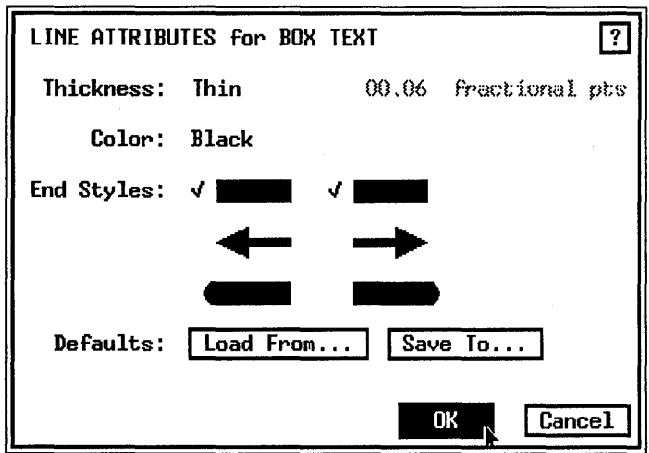

➡ **NOTE:** *The Save To button does not stay highlighted after you choose it in the dialog box.*

Save To stores these line attributes as default values. Ventura remembers your choices the next time you draw a Box Text.

Let's take a moment to explain Ventura's application of end styles, which can be confusing. Ventura doesn't care which end is left or right. It only cares which end was drawn first.

Look again at the Line Attributes dialog box. The End Styles field on the left applies to the *starting* point. The End Styles field on the right applies to the *ending* point. This holds true whether you draw from left to right, from right to left, from top to bottom, or from bottom to top.

Change fill attributes

■ With the Box Text still selected, select Fill Attributes from the Graphic menu (or press Ctrl-F). Choose Color: White, Pattern: Hollow, Result: Transparent, and Defaults: Save To. Now click OK.

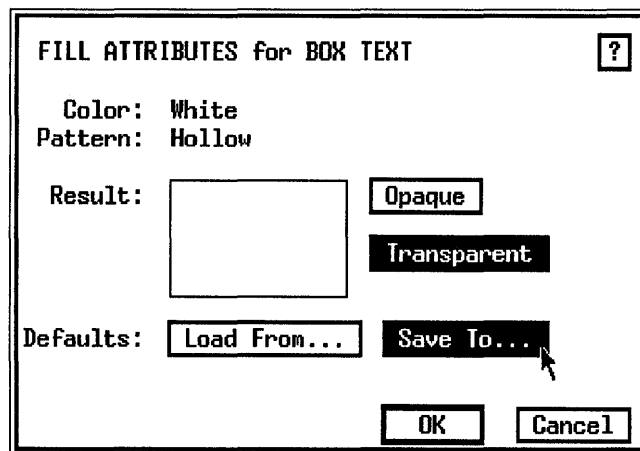

Copy the Box Text

Now that you've made one Box Text, we will show you a shortcut for the next four. Instead of using the Box Text tool to draw each shape, use the copy and paste commands to reproduce four copies of the original.

- With the first Box Text still selected, press Shift-Del (or select Copy Graphic from the Edit menu).

You have just copied the Box Text onto the Graphic clipboard.

➔ *NOTE: Ventura uses the same copy and paste procedures for Graphic, Text, and Frame mode. Since Ventura treats all three independently, you can copy or delete to three clipboards at the same time.*

Paste the Box Text

- Press the Ins key (or select Paste Graphic from the Edit menu).

You will see the screen redraw itself, which is your sign that Ventura has pasted a new Box Text onto the Page. Otherwise you might not know for sure, since Ventura pastes the copy directly on top of the original.

Move the copy

Once you paste the copy, you can move it to a new position.

- Press and hold the cursor anywhere in the middle of the Box Text until the four-way arrow appears. With the mouse button still depressed, move the Box Text to the right of the original as shown in Figure 4-16.

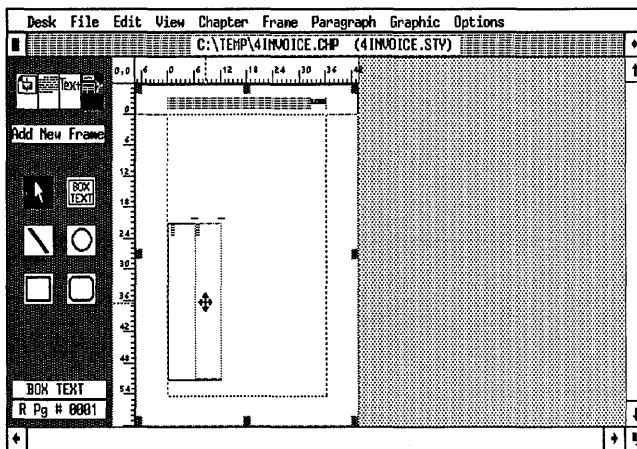

Figure 4-16.

- Repeat the above step by pasting and moving three more Box Text shapes into place. The snap-to grid should make aligning the shapes easy (Figure 4-17).

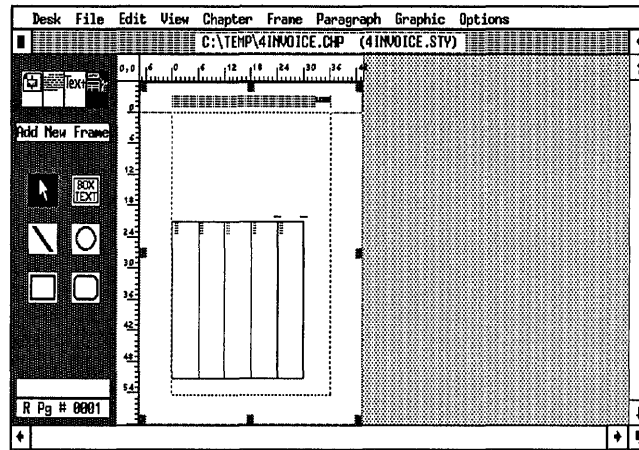

Figure 4-17.

- NOTE:** Once you copy a shape onto the clipboard, it remains there until replaced by something else. To insert another copy, simply press the *Ins* key again.

Stretch the last Box Text

Now you will stretch the last Box Text so it lines up with the right edge of the right page margin.

- Select the last Box Text (the one on the far right).
- Place the cursor on any black sizing button on the right side. Press and hold down the mouse button until the pointing hand appears.
- Stretch the Box Text until it lines up with the right page margin. Release the mouse button. The Box Text is now twice the size as the other shapes (Figure 4-18).

Resize Box Text

You will shorten four of the Box Text shapes to make room above for the next Box Text shape.

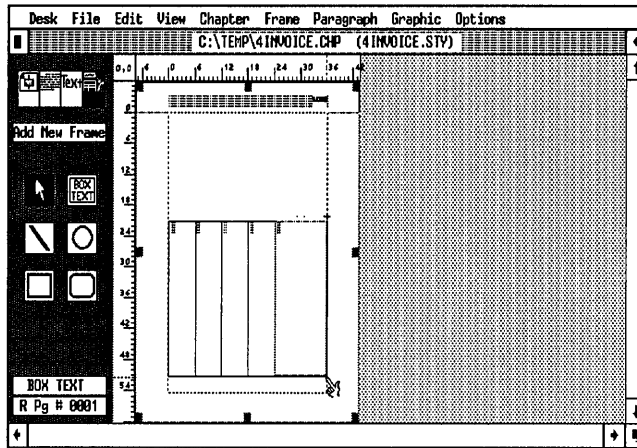

Figure 4-18.

- Click on the right-most shape. Then as you hold down the Shift key select the three shapes to the left (the left-most Box Text is not selected). The word MULTIPLE appears in the Current Selection Box.

➔ *NOTE: If you accidentally click on the wrong graphic shape, while holding down the Shift key, click on the shape again to “deselect” it. Then choose another shape.*

After all four shapes are selected, you can resize them together.

- Place the cursor on the black sizing button at the upper right corner of the right-most Box Text. Press and hold the mouse button until the pointing hand appears. Drag the boxes downwards one snap grid unit (Figure 4-19).

See how quick and easy it is to draw when you use a grid? Now that you’ve resized the four boxes, you’re ready to draw the next Box Text shape.

Draw Box Text

- Select the Box Text tool from the Side-Bar.

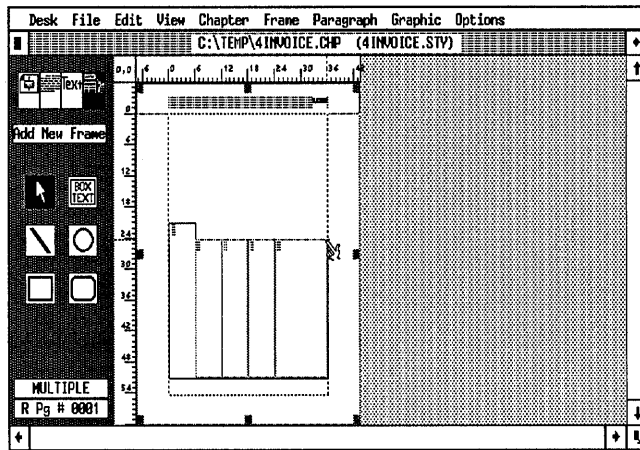

Figure 4-19.

➡ **NOTE:** You can draw several shapes, one after another, by holding down the Shift key while you draw. The cursor stays in the current shape drawing mode (Box Text, rectangle, line, or ellipse) and you can draw a second shape without reselecting a graphic tool from the Side-Bar.

▣ Line up the Box Text cursor with the upper right corner of the first rectangle. Stretch it down one snap grid unit and all the way over to the right so it lines up with the right column margin (Figure 4–20).

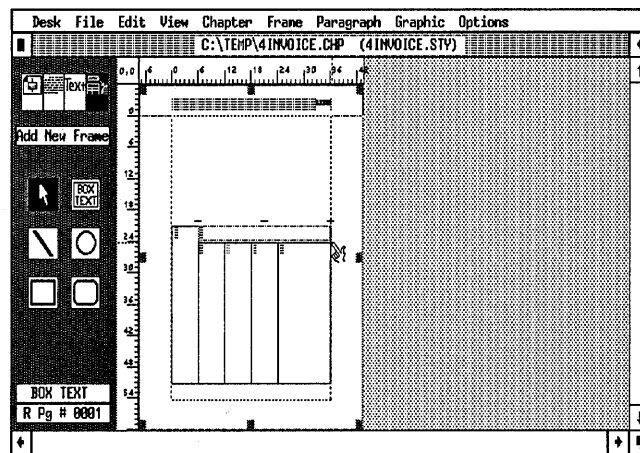

Figure 4-20.

Draw more shapes

Now that you have the basics of Graphic mode under your belt, you can draw the bottom section of the form.

- Select the Box Text tool.
- Align the cursor with the bottom left corner of the right-most box. Stretch the Box Text down one snap grid unit and over to the right margin (Figure 4-21).

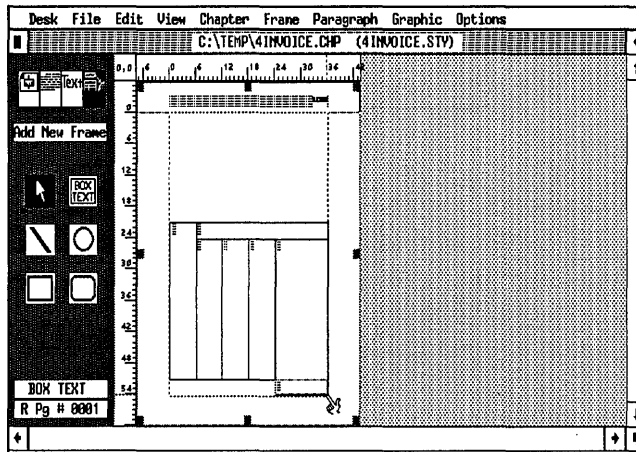

Figure 4-21.

Now you will add another Box Text shape immediately below.

- Select Box Text.
- Align the cursor with the lower left corner of the Box Text just drawn. Stretch the shape down one snap grid unit and over to the right column margin. The bottom of the shape extends below the column guide (Figure 4-22).

➔ *NOTE: You could also copy and paste the graphic to create the second shape.*

Draw the final shape

Only one more shape and you are finished with the lower half of the form.

- Select the Box Text tool.

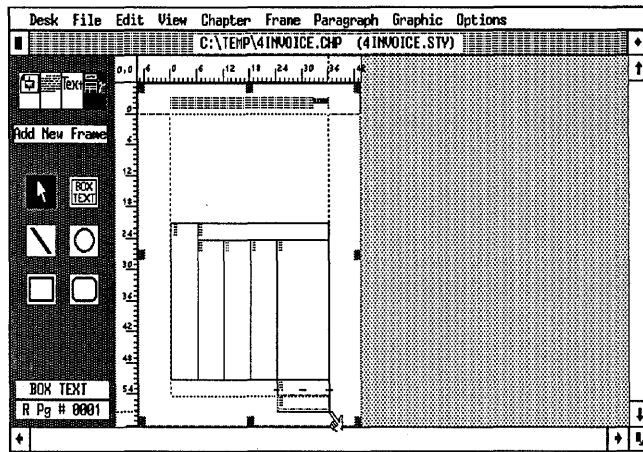

Figure 4-22.

- Align the cursor with the lower left corner of the left-most column. Stretch the shape down two grid snap units (06,00 picas & points) and over two columns to the right, as shown in Figure 4-23.

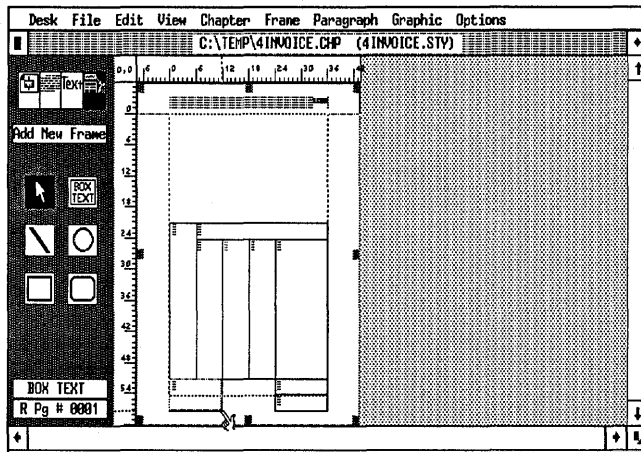

Figure 4-23.



Stopping point

Good work. You've already completed more than half of the invoice. Now that you've learned how to draw and resize shapes, the second part of the invoice should be easy. Take a moment to evaluate your progress. You may want to change to

Normal or Enlarged View to make sure each shape is correctly placed. Check that your screen matches Figure 4-24.

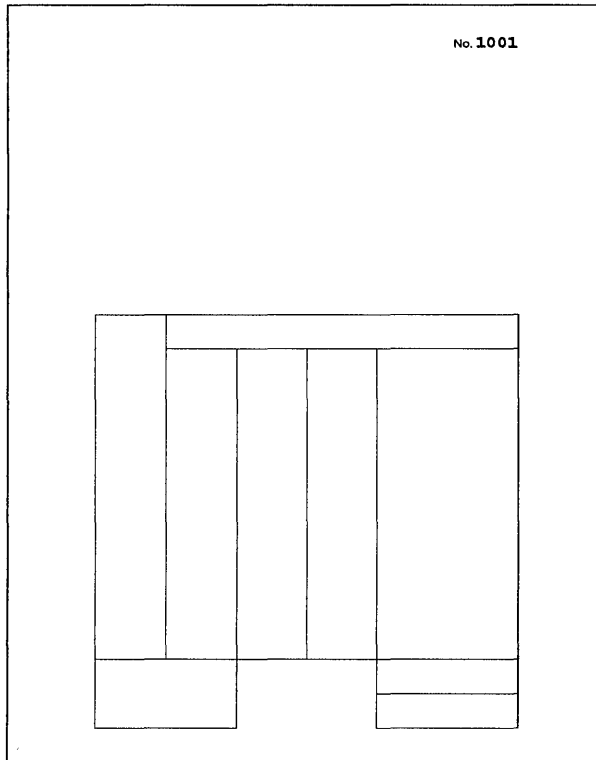

Figure 4-24 Check to make sure your form matches this illustration before you continue.

This is a good point in the exercise to take a break and save your work (press Ctrl-S to save). If you're short on time, quit now and start again later. If your schedule permits, continue on to the next section without stopping. If you're in a real rush, you can simply read through the next few pages without actually drawing in the rest of the box text, and skip to the section titled "ReCap," where we show you how to type in your own text. However, we highly recommend that you complete the entire project if you possibly can. The more time you devote to practice now, the easier it will be to do your own projects later. And drawing the last shapes should only take a few more minutes.

If you are starting again after a break

If you are starting fresh, reload Ventura and open the chapter C:\TEMP\4INVOICE.CHP. Continue to the next section where you will finish drawing the invoice.

Change grid settings

To create the narrower boxes in the top portion of the form (refer back to Figure 4-12), make the vertical spacing smaller. The horizontal grid spacing stays the same.

■ Make sure you are in Graphic mode with the Page selected.

■ Grid Settings Grid Snap: On
Horizontal Spacing: 01,06 picas & points
Vertical Spacing: 01,00 picas & points

Draw Box Text

You will now draw the next five box shapes, which will contain the words Date, Invoice #, Charges, Credits, and Balance. Use the same shortcut you did to create the first set of boxes — draw one shape, then copy and paste it to make four more.

➡ *NOTE: Depending on your display screen, you may find it easier to draw these smaller shapes if you change to Normal (Ctrl-N) or Enlarged (Ctrl-E) View.*

■ Select Box Text.

■ Starting at position 19 picas on the vertical ruler, draw a Box Text shape that is 02,00 picas high and 06,00 picas wide. Since the vertical spacing is 01,00 picas & points and the horizontal spacing is 01,06 picas & points, the box is two snap grid units high and four snap grid units wide (Figure 4-25).

You will now copy the Box Text to the clipboard and paste it back onto the page.

■ With the first Box Text still selected, press Shift-Del to place a copy into the clipboard.

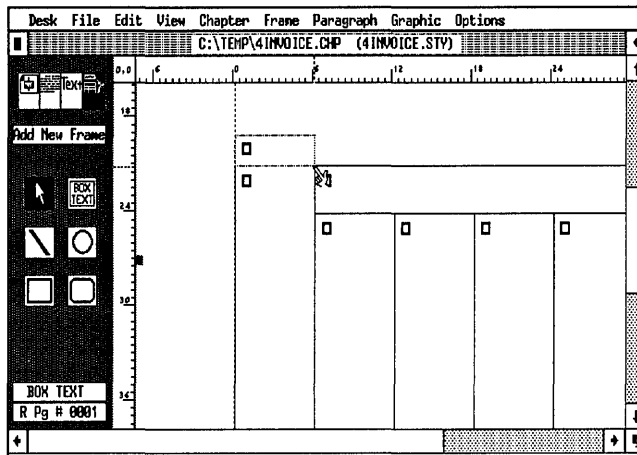

Figure 4-25.

Paste and place the copies

- Press the Ins key to paste a copy back onto the page.
- Insert three more Box Text shapes to the right of the first ones and move them so they line up side-by-side as shown in Figure 4-26. Then stretch the last Box Text so it snaps to the right page margin. After you make the copies, the invoice should look like this:

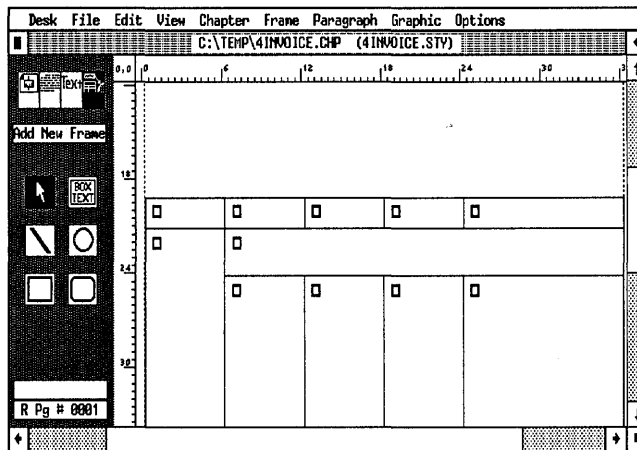

Figure 4-26. Here's what your invoice should look like at this stage.

Add Box Text for the tear off line

You will add another Box Text above the five just drawn. You will use it later to contain the dotted tear off line. (The dotted line itself will be created with the Tab Settings option from the Paragraph menu.)

- Select the Box Text tool.
- Starting at position 17 picas on the vertical ruler, stretch the Box Text shape so it measures 02,00 picas high and the width of the entire column (Figure 4-27).

➔ **NOTE:** If your monitor won't allow you to draw the Box Text the entire column width, stretch it as far as you can to the right. Then scroll to the right side of the page and stretch the Box Text to the right margin.

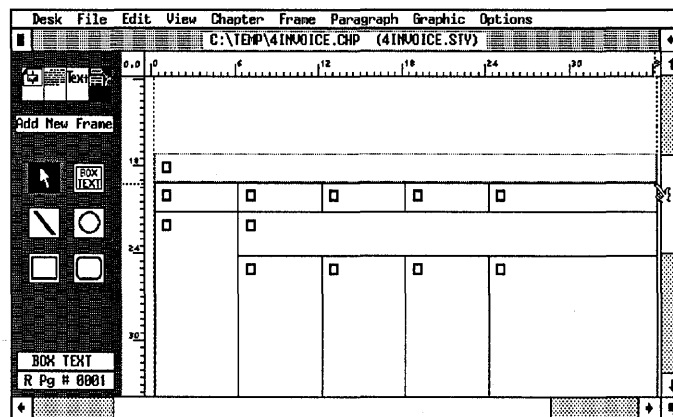

Figure 4-27.

Add two Box Text shapes

Now you will add two more Box Text shapes to contain the text “Please Return Top Portion With Payment” and “Amount of Payment \$.” Initially, these shapes will overlap the Box Text shapes below them by one pica. Later, when you change the line and fill attributes, the overlap will become “invisible.”

- Select Box Text.
- Starting at position 16 picas on the vertical ruler, draw a Box Text shape that measures 02,00 picas high and 21,00

picas wide. Draw a second shape next to the first and make it 02,00 picas high and 15,00 picas wide. It will automatically snap to the right page margin (Figure 4–28).

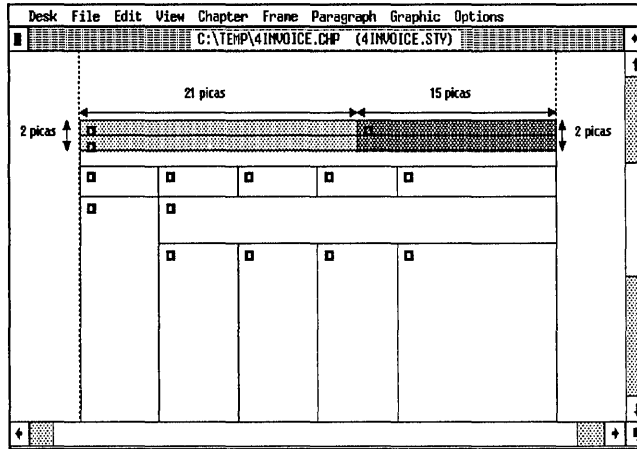

Figure 4-28. Draw the two shapes that appear shaded in the above illustration.

➔ **NOTE:** The shading in the Figure 4–27 is to help you distinguish the shapes on-screen. Do not fill them in with a pattern.

Draw the final shapes

Only six more shapes to go. Now that you’ve had some practice, you’re ready to step out on your own. For the last part of the layout, refer to Figure 4–29 for placing and drawing the final shapes.

Here are some tips to help you get started:

➔ **TIP:** Reset the zero point to line up with the upper left corner of the Box Text that will contain the word “DATE” (Figure 4–29).

➔ **TIP:** Use the zero point and rulers to align and measure shapes. Simply place the zero point of the ruler on one corner of the shape. Then count off the tick marks to measure the width and height of the shape.

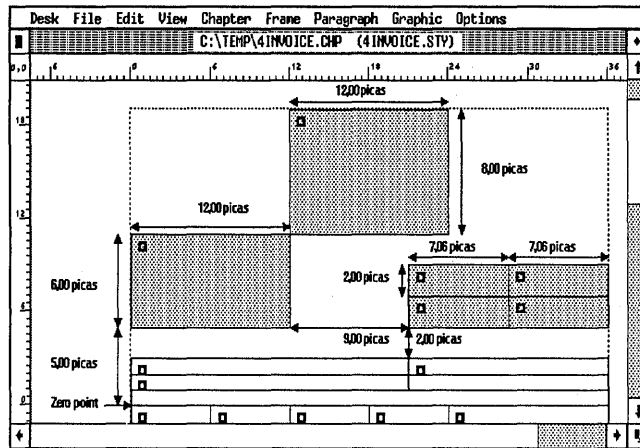

Figure 4-29. Finish by drawing the six shapes that are shaded in this drawing.

➡ **TIP:** If you draw a Box Text that is too small for the text size inside it, Ventura displays the message, “This frame has text which won’t fit on any page...” To cancel the message, choose OK. Then draw a larger Box Text or make the Box Text font smaller.

When you finish, your screen should look like Figure 4–30:

A Recap

At this point, you have built a header and added Box Text. Now you are ready to add text. As explained earlier, you will type this text directly into the Box Text shapes. You will use Text mode to enter your own words. (You may want to change to an Enlarged View while you type.)

Add the logo text

Start at the top of the page and work downwards. Do not be concerned yet with appearance of the text, which you will later reformat with tags from the style sheet.

- Enable Text mode.
- Place the cursor in front of the end of file mark in the top-most shape (Figure 4–31).

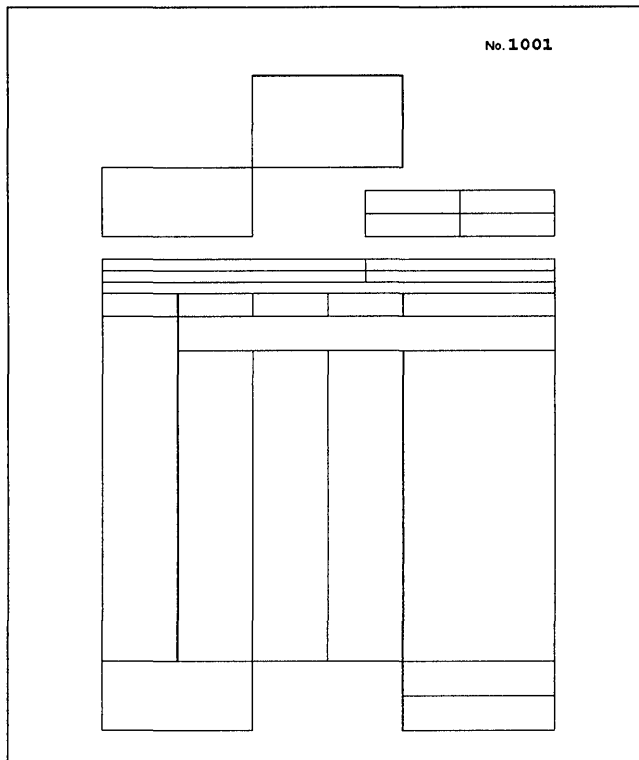

Figure 4-30.

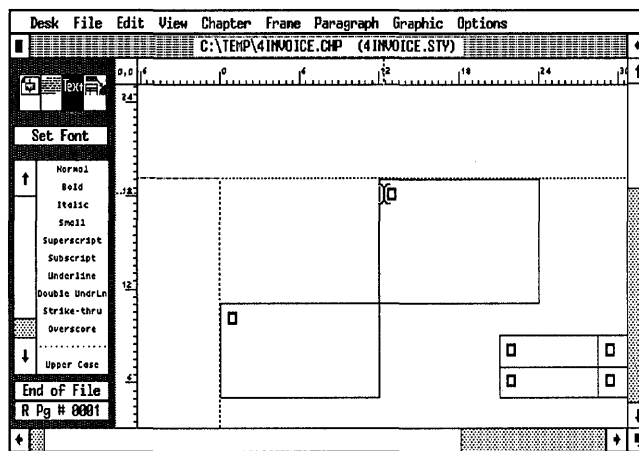

Figure 4-31.

■ Now type:

**XYZ [Ctrl-Enter]
CORPORATION [Enter]**

The line break (hold down the Ctrl key and press Enter) tells Ventura to treat the first two sentences as the same paragraph even though they are on separate lines. Line breaks are useful when you want information on separate lines, but you don't want to bother retagging each line.

Add the logo address

■ With the text cursor still in the first box, type:

**123 Main Street [Ctrl-Enter]
Los Angeles, CA 90000 [Ctrl-Enter]
(213) 555-1111**

Add the shipping address

When typing the shipping address, make a line break after each sentence so Ventura treats all the lines as one paragraph.

■ Place the cursor in front of the end of file mark in the shipping address box (immediately below the top box) and type:

**Ship to: [Ctrl-Enter]
International Paper Co. [Ctrl-Enter]
1701 Broad Street [Ctrl-Enter]
Philadelphia, PA 19000**

Add the amount of payment

Now place the text cursor in the Amount of Payment box (Figure 4-32). Type: **Amount of Payment [Space] \$**

Add the remaining text

To add the rest of the text, remain in Text mode and reposition the text cursor from box to box. Use Figure 4-33 as your guide. Don't worry about matching the font of the illustration.

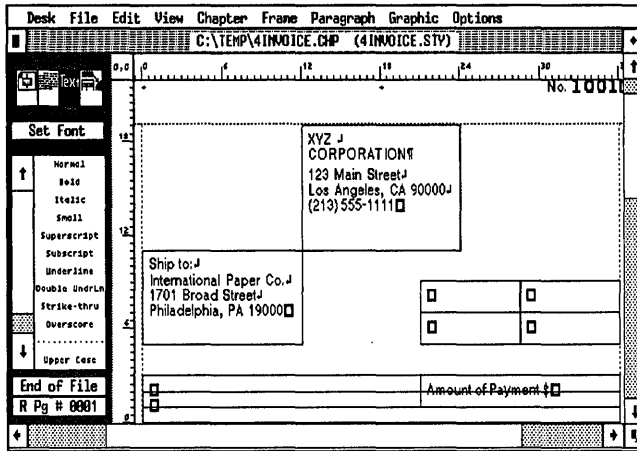

Figure 4-32.

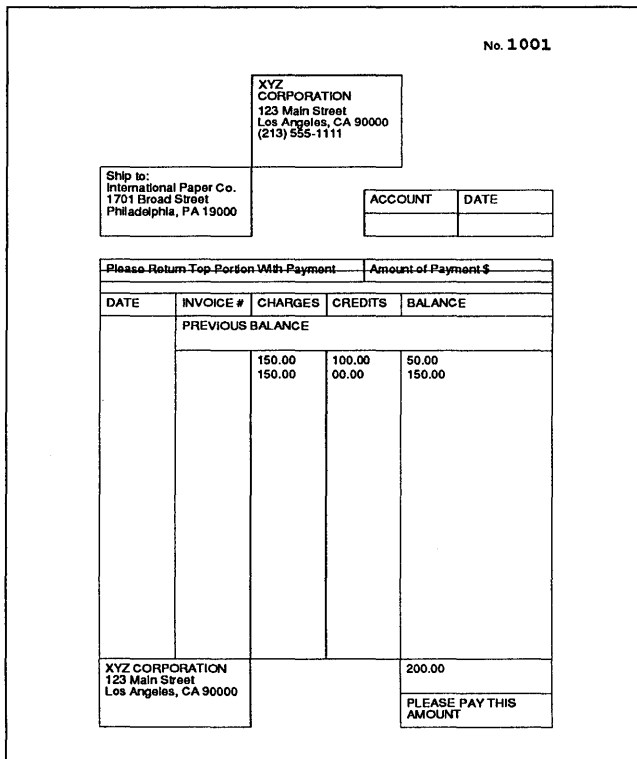

Figure 4-33 Use this illustration to finish adding text.

Tag the text

The style sheet loaded at the beginning of the chapter already includes pre-defined tags. This will make formatting go fairly fast — all you need to do is apply the right tag to the right text. Once you apply the pre-defined tags, we will show you how to create the tear off line with a new tag. Otherwise, the tags we provide in the style sheet will create the effects you need without modification. (If you did not purchase the Power disk, you must build the tags on your own from Appendix B.)

Apply the first tags

Start at the top of the document and work down. Although Box Text starts as a generated tag, you can retag it as any other tag name.

- Enable Paragraph mode. Select the paragraph “XYZ CORPORATION” and tag it as Logo.
- Select the company address paragraph and tag it as Logo-Address (Figure 4-34).

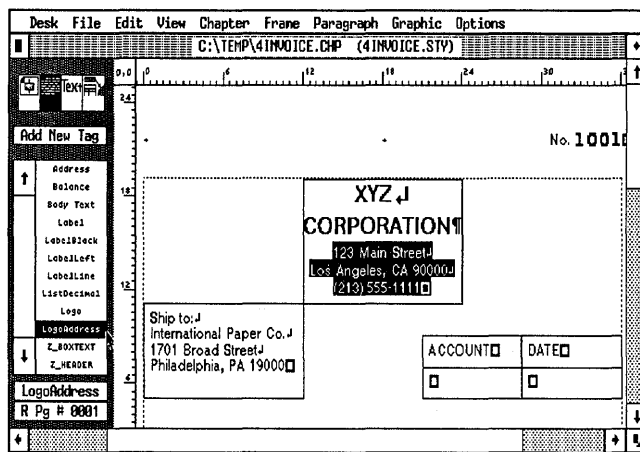

Figure 4-34.

- Select the “Ship To” address paragraph and tag it as Body Text.
- Use Shift-Click to select the next three paragraphs, “ACCOUNT,” “DATE,” and “Please Return Top Portion With Payment,” and tag them as Label.

In the Label tag, we used Vert. Alignment: Middle to vertically center the text within the Box Text shapes. As a general rule use Middle alignment to center text within Box Text or frames. Figure 4-35 shows the alignment settings for the Label tag.

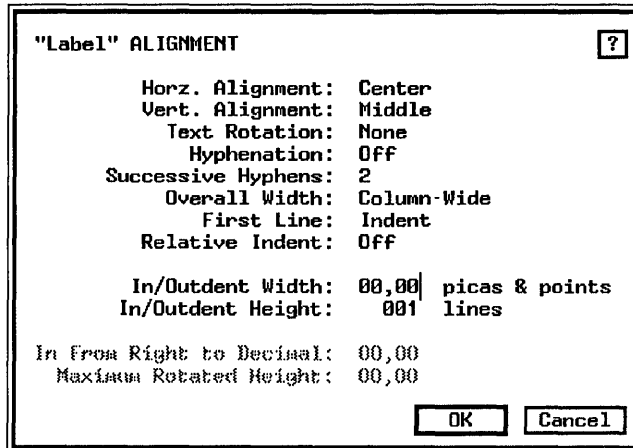

Figure 4-35. The alignment settings for the Label tag.

- Select the paragraph "Amount of Payment \$" and tag it as LabelLine (Figure 4-36).

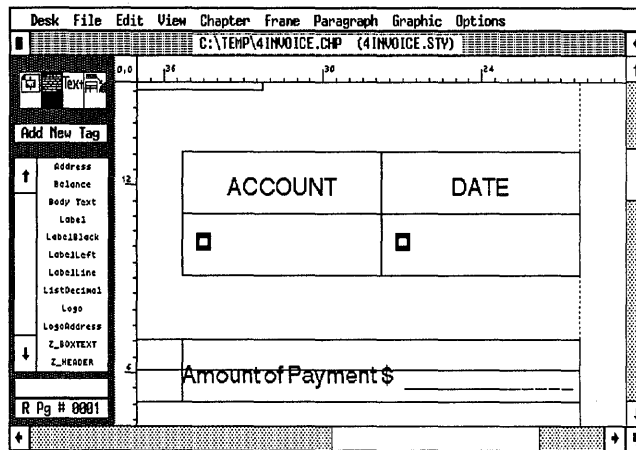

Figure 4-36.

Create an underscore

Let's pause for a minute to show you how we got the underscore effect in the LabelLine tag above. Open the Tab Settings dialog box so you can see what we did.

- With the "Amount of Payment" paragraph still selected, select Tab Settings from the Paragraph menu.

"LabelLine" TAB SETTINGS

Tab Number:

Tab Type: Off

Tab Shown As: Leader Char

Tab Location: 00,00 picas & points

Leader Char: _____ 095 (ASCII)

Leader Spacing: 0

Auto-Leader: On

OK Cancel

To make the solid line, we turned Auto-Leader on in the Tab Settings dialog box. Auto-Leader creates a leader line from the end of the paragraph all the way to the right margin. The leader character itself is a series of small straight lines (____) with no space between. In other words, the solid line was created by placing small underline characters side-by-side with no spaces between them.

➡ *NOTE: Do not be concerned if the lines appear dashed on-screen. When you print out the invoice, the lines will be solid.*

Create the tear off line

You will use the Auto-Leader technique to construct the dotted line in the next Box Text shape. First you will add a tag named TearOff. Then you will turn Auto-Leader on to create a line to the right margin. In this case, however, the leader character will be a dotted line instead of a solid line.

- Select the end of file marker (□) just as you would select any other paragraph you wanted to tag (Figure 4-37).

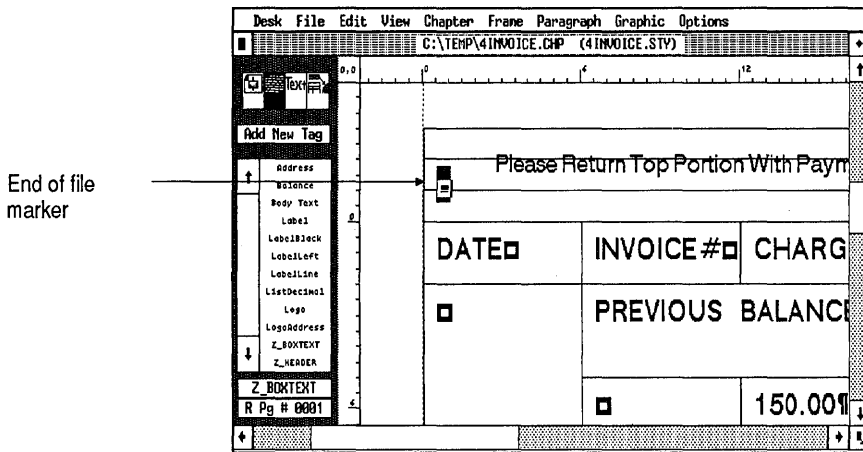
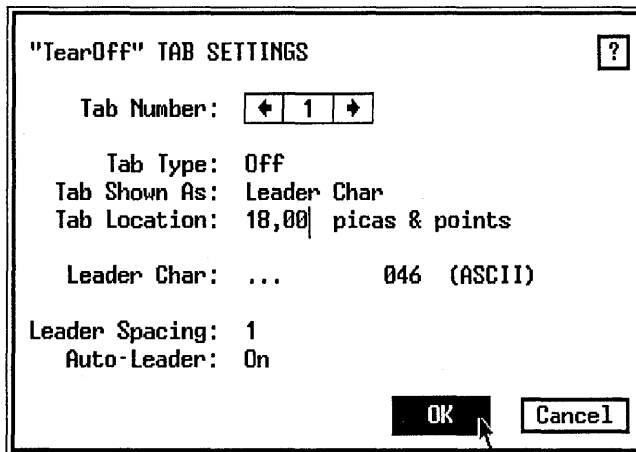

Figure 4-37.

- Add New Tag Tag Name to Add: TearOff

To create the dotted tear line effect turn Auto-Leader on in the Tab Settings dialog box.

- Select Tab Settings from the Paragraph menu. Choose Tab Number: 1, Tab Type: Off, and Tab Shown As: Leader Character. Then choose the Leader Character (...) with 1 Leader Spacing and choose Auto-Leader: On.



The dotted line extends across the Box Text to the margin.

Tag the remaining text

Now finish tagging the invoice using the pre-defined tag names from the Assignment List. Change views as necessary.

- Select the paragraphs “DATE,” “INVOICE #,” “CHARGES,” “CREDITS,” and “BALANCE” and tag them as Label.
- Select the paragraph “PREVIOUS BALANCE” and tag it as LabelLeft.
- In the Balance column tag “50.00, 150.00, and \$200.00” as Balance. Then tag “150.00 and 150.00” in the Charges column and “100.00 and 00.00” in the Credits column as ListDecimal.
- Select the paragraph “PLEASE PAY THIS AMOUNT” at the bottom of the page and tag it as LabelBlack.
- Select the paragraph at the bottom of the page that begins “XYZ CORPORATION, 123 Main Street...” and tag it as Address.

Number lists with decimal alignment

If you work with lists of numbers on a regular basis, you may want to know how we got all the numbers to line up in the columns. (If you do not work with tables, feel free to skip to the next section.) The trick is to use Ventura’s Decimal Alignment feature (Alignment, Paragraph menu). With Decimal Alignment you tell Ventura how far from the right margin you want to position the first decimal point of the paragraph. For the Balance tag in the example above, we specified In From Right To Decimal spacing as 05,06 picas & points. Then all the paragraphs tagged as Balance line up under the decimal point. Figure 4–38 shows the Alignment dialog box settings for the Balance tag.

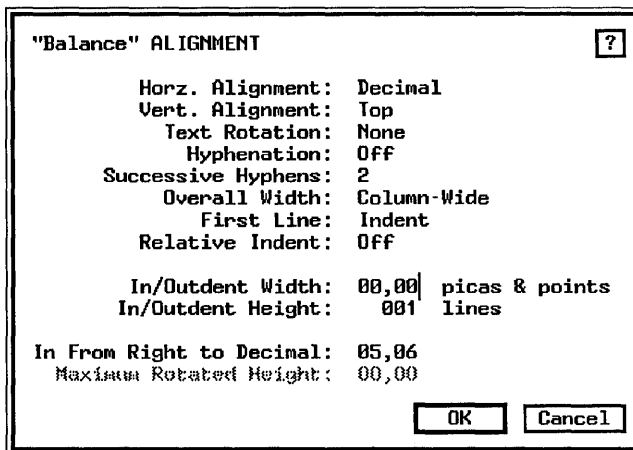

Figure 4-38. The Alignment settings for the Balance tag.

Pictures

With Text and Style behind you, you can look ahead to the next part of the formula: Pictures. Now that you've placed and positioned the shapes, you can modify the line and fill attributes of the shapes to create new effects. In this section you will create a gray pattern (tint screen) effect and make the border lines around selected Box Text invisible.

Change fill attributes

Start by selecting the shapes you want to fill with a pattern.

- Enable Graphic mode.
- Use Shift-Click to select the boxes that will be shaded. Use Figure 4-39 as your guide. (You may want to change to Reduced View to select the shapes.)

➔ *NOTE: If you click on the wrong box, simply click it again to deselect it. Then select another shape.*

- Select Fill Attributes from the Graphic menu (or press Ctrl-F). Choose Color: Black, Pattern: 2, and Result: Transparent and click OK (Figure 4-40).

No. 1001

XYZ CORPORATION
123 Main Street
Los Angeles, CA 90000
(213) 555-1111

Ship to:
International Paper Co.
1701 Broad Street
Philadelphia, PA 19000

| ACCOUNT | DATE |
|---------|------|
| | |

Please Return Top Portion With Payment Amount of Payment \$ _____

| DATE | INVOICE # | CHARGES | CREDITS | BALANCE |
|------------------|-----------|---------|---------|-----------------|
| PREVIOUS BALANCE | | | | |
| | | 150.00 | 50.00 | 50.00 |
| | | 150.00 | 60.00 | 150.00 |
| | | | | \$200.00 |

XYZ CORPORATION
123 Main Street
Los Angeles, CA 90000

PLEASE PAY THIS AMOUNT

Figure 4-39 Select the boxes that are shaded in this illustration.

FILL ATTRIBUTES for BOX TEXT ?

Color: Black
Pattern: 2

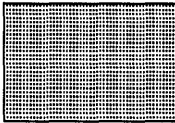
Result:  Opaque
Transparent

Defaults: Load From... Save To...

OK Cancel

Figure 4-40.

Change line attributes

Now you will remove the lines around selected shapes.

- Use Shift-Click to select the Box Text shapes highlighted in Figure 4-41.

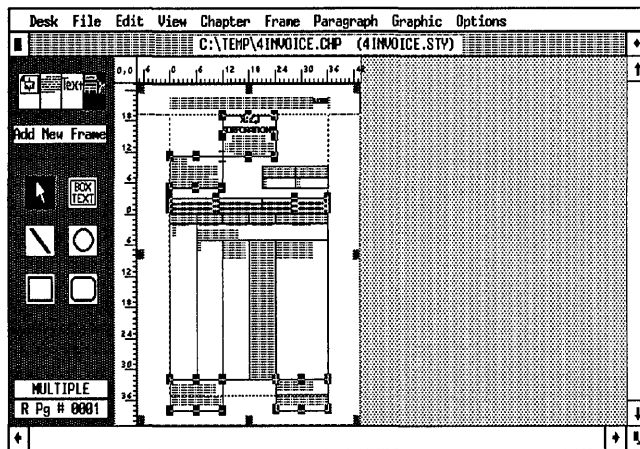
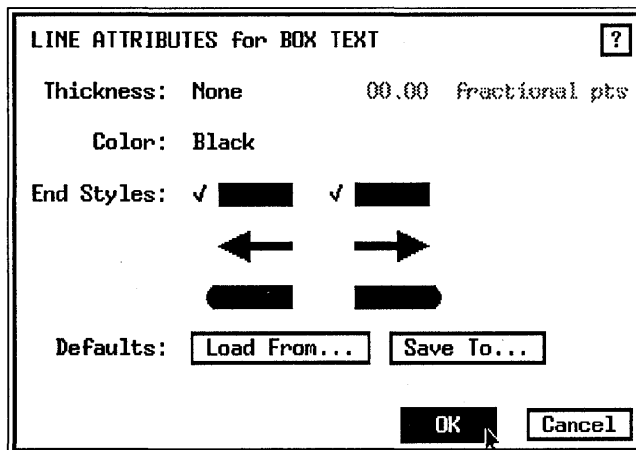

Figure 4-41. Select the Box Text shapes shown in this illustration.

➤ **NOTE:** Make sure you select the Box Text shapes, "Please Return...", "Amount of Payment," and the tear off line.

- Select Line Attributes from the Graphic menu (or press Ctrl-L). Choose Thickness: None. Click OK.



If any of the Box Text still have borders, simply reselect the box and change its line attributes to none.

Check that the invoice resembles Figure 4–42.

No. 1001

**XYZ
CORPORATION**
123 Main Street
Los Angeles, CA 90000
(213) 555-1111

Ship to:
International Paper Co.
1701 Broad Street
Philadelphia, PA 19000

| ACCOUNT | DATE |
|---------|------|
| | |

Please Return Top Portion With Payment Amount of Payment: \$ _____

| DATE | INVOICE # | CHANGES | CREDITS | BALANCE |
|------------------|-----------|---------|---------|-----------------|
| PREVIOUS BALANCE | | | | |
| | | 150.00 | 150.00 | 50.00 |
| | | 150.00 | 150.00 | 150.00 |
| | | | | \$200.00 |

XYZ CORPORATION
123 Main Street
Los Angeles, CA 90000

PLEASE PAY THIS AMOUNT

Figure 4-42 After shading some of the boxes, and removing some lines, the invoice should look like this.

Add line and arrow

To add the finishing touches to the form, you will add an arrow after the words “Previous Balance.”

- Select the line tool from the Side-Bar. When the slanted pencil appears, place its “point” after the *e* in the word Balance. You may want to change to Enlarged View to draw the line (Figure 4–43).

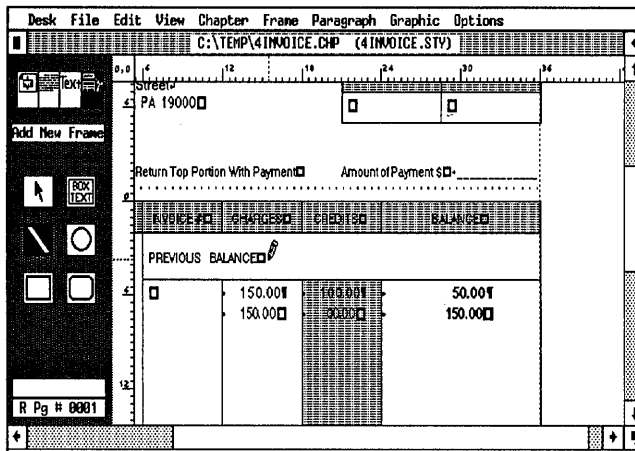
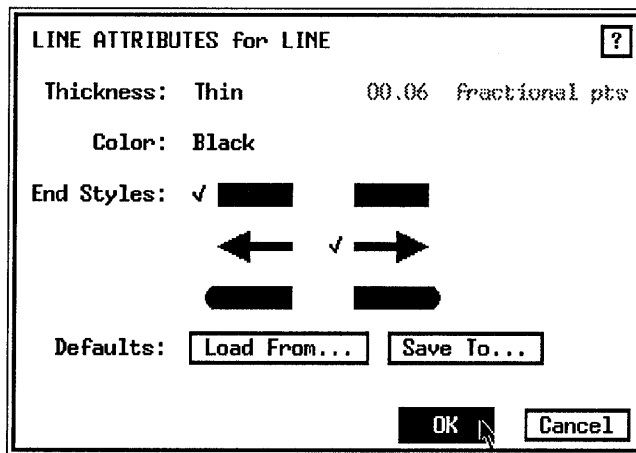

Figure 4-43.

- Press the Alt key as you drag the line to the right. (The Alt key keeps the line perfectly straight as you draw.) Stretch the line until it lines up with the letter “B” in the word BALANCE on the line above.

Use the Line Attributes dialog box to put an arrow at one end of the line.

- Select Line Attributes (or press Ctrl-L). Choose Thickness: Thin, Color: Black and choose the arrow in the right column of End Styles.



Show the graphics on all pages

To create more numbered invoices you will add pages and tell Ventura to repeat the graphics on all pages. Because the header includes the page numbering code ([P#]), when you add a page the invoice number will increase by one.

You must select all the graphic shapes before you tell Ventura to repeat them on all pages of the document.

- Choose Select All from the Graphic menu (or press Ctrl-Q).
- Select Show On All Pages from the Graphic menu.

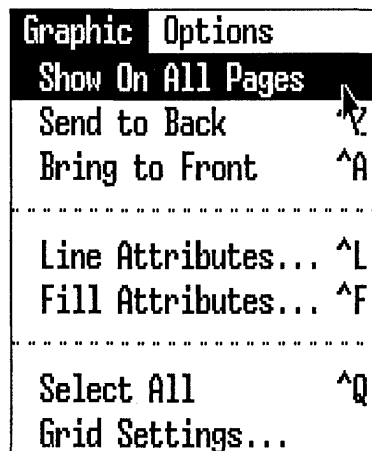

PW04RPTG.IMG

To see the shapes repeated, you will insert a new page.

➡ **NOTE:** When you use Box Text as the only text in the document, Ventura doesn't automatically create a new page for you. Therefore, you must insert one manually.

- Select Insert/Remove Page from the Chapter menu. Choose Operation: Insert New Page After Current Page and click OK.

Ventura adds a page and moves you to it. Because you inserted a page manually, you must update the page counter so that the invoice number will change.

- Select Update Counters from Chapter menu.
- Choose Which Counter: This Page, Update Method: Previous Number + 1, Number Format: 1,2 and click OK.

The header now reads "1002." Now every page you insert will increase the page number by one (Figure 4-44).

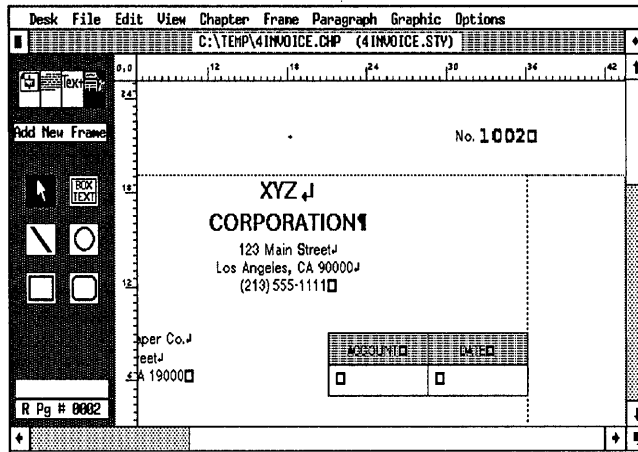

Figure 4-44.

Chapter

Now that you've seen the invoice on the screen, let's see how it looks printed out. Ventura's print option allows you to print multiple copies of a document. When you print this time, tell Ventura to make three copies of the form.

- To Print Which Pages: Current
- Number of Copies: 3

Ventura prints out three copies of the invoice. Incidentally, once a laser printer has processed one copy of a single page, it takes less time to make additional copies, because the fonts are already in memory.

In this chapter, you learned how to create a graphics-intensive document using Ventura's graphic tool kit. In the next chapter, you will learn how to create another document that relies heavily on graphics to convey a message: an advertising flyer.



Tips and techniques

When to use Box Text

Use Box Text to contain text if you want to:

- Quickly place less than two dozen words. For longer selections, consider using a frame so the text can be placed into a separate file if desired.
- Attach the text to something else. If, for example, you wish to create callouts for an illustration, you want the text to be tied to that frame. When you move the frame, the Box Text automatically moves with it. And since you can anchor a frame to a text reference, the graphics attached to the frame will move according to the text reference.
- Move Box Text shapes as a group. Box Text can be grouped by attaching them all to the same parent frame. When you move the parent you automatically move all the Box Text. Frames, on the other hand, cannot be permanently linked (although you can temporarily group them using shift-click to select several at a time).

When to use frames

Use a frame to contain text if you want to:

- Import a file. You cannot load a file into Box Text. You must always type Box Text directly onto the page.
- Rename the text to a separate file. Even if you originally type the text into the chapter, you may sometimes want to rename text into a separate file. A stand-alone text file can be easily edited or updated with a word processor.
- Create more than one column inside the rectangle. You can create multiple columns inside a frame, but not inside Box Text.
- Flow text around the rectangle. Text can flow automatically around a frame. By contrast, Box Text coexists with whatever else is in the same space.
- Put more than one ruling line around the rectangle. Box

Text can have only a single ruling line around. Frames can have up to three.

More graphic drawing tips

- Align Box Text shapes along a grid. The snap-to grid available in Graphic mode is more versatile than the column- and line-snap available in Frame mode.
- When you draw a shape it appears on that page only. To repeat graphic shapes on all pages of the chapter select Show On All Pages from the Graphic menu.
- When selecting the parent, make logical groupings so all related shapes can be moved as one by moving the parent. For instance, if you were constructing a two-part form using frames instead of the Page, you could attach all the shapes on the top half to one parent, and all the shapes on the bottom half to a different frame. That way the two halves could be adjusted independently.
- Ctrl-Q is the keyboard shortcut for Select All from the Graphic menu. This graphics command operates even in Frame mode. (It is the only one that works in this manner. To use any other graphic commands, you must switch to Graphic mode.)
- Establish snap-to grid settings before you start to draw. There may be a few exceptions where you wish to turn grid settings off for complete freedom in placing a shape. In most cases, your drawings will be more accurate and attractive if you establish a snap-to grid in advance.
- Set the grid as large as possible. The larger the units of the grid, the smaller the possibility for error.
- Consider the margin when setting the grid. If possible, make the snap grid units an integer multiple of the margins so the shapes can also snap to the margin.
- To move a very small shape, attach it to a larger frame. (The frame can be “invisible” if you do not want it to print.) Then move the frame. The shape moves with it.
- To draw several shapes at once, hold the Shift key down while dragging the mouse. The cursor stays in shape drawing mode and you can draw a second shape immediately.

- To speed the creation of identical shapes, use the Save To button in the Line Attributes and Fill Attributes dialog boxes. This saves the attributes you have just chosen. From then on, every shape you draw is identical to the previous one.
- To select several shapes at once, use the same Shift-Click method that operates in Paragraph mode. Once you have selected more than one shape, you can move, resize, or change the attributes of these shapes as a group.
- To select a shape that is underneath another, hold down the Ctrl key while clicking on the shape with the mouse. Each time you Ctrl-click, Ventura selects the next lowest “layer,” no matter how many shapes are piled one on top of the other.

Chapter Five Skills Checklist

Theory

- How Ventura manages pictures
- Line-art versus bit-mapped images
- Encapsulated PostScript

Text

- Improving headlines with manual kerning
- Entering non-keyboard characters
- Understanding letter spacing
- Reducing loose lines

Style

- Combining two page formats in one document
- Improviing display type with interactive tracking and kerning
- Adding columns to frames
- Adjusting the vertical spacing in frames
- Rotating text

Pictures

- Sizing and scaling pictures
- Cropping pictures
- Loading and placing PostScript files
- Creating text runarounds
- Adding drop shadows to frames

Chapter

- Printing to a disk file
- Creating PostScript files
- Printing hidden pictures

An Advertising Flyer

Advertisements and flyers are invaluable promotional tools. In Chapter Five, you will learn how to create a self-mailing ad. Although we constructed this project as a direct mail piece, many of the techniques apply equally well to print advertisements. In essence, we will show you the basics of creating an ad *plus* the added techniques to turn that ad into a self-mailing flyer. The checklist on the left lists some of the special skills you will learn.

Theory

In Chapter Four, you learned how to use Ventura's built-in graphics to create simple box, line, and rectangle shapes. These basic shapes are useful for forms, annotations, and simple artwork. But for the sophisticated graphics required of an advertisement, you need dedicated, stand-alone graphics programs. Programs like AutoCAD, Adobe Illustrator, and PC Paintbrush provide specialized drawing and painting tools for creating high-quality images. Fortunately, Ventura makes it easy to import these complex images into a document.

The advertising project you will complete in this chapter depends heavily on graphics effects. You will find it easier to follow along if you understand these three key concepts:

- How Ventura manages picture files
- The two kinds of pictures
- How to change the size and position of pictures inside the frame

How Ventura manages pictures

After you create a picture, you load and place it in a frame. However, the chapter file doesn't store the image itself, it stores a pointer to the picture file with information about how to display and assemble the picture in the chapter. Picture files cannot be changed from inside Ventura.

Two kinds of pictures

Ventura accepts two kinds of picture files: bit-mapped images and line-art. Paint programs, scanners, and screen capture utilities create bit-mapped images. These images are a collection of thousands of individual dots (or bits). As you draw, the computer makes a map of the screen and figures out which dots to turn on and off (Figure 5-1).

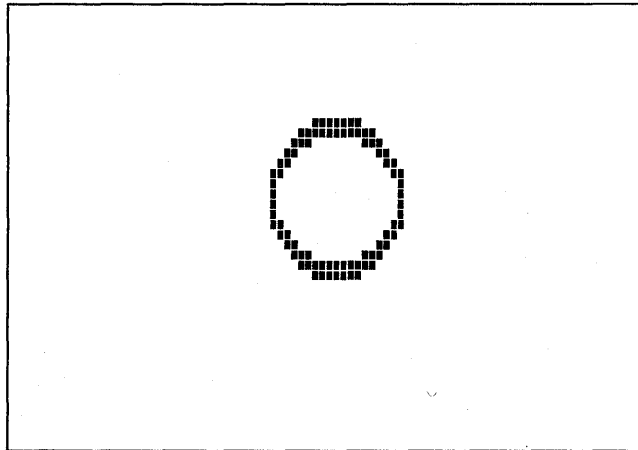

Figure 5-1. With a bit-mapped image, the picture is made up of individual dots.

Since an image is a map of the screen, the final quality of the picture is only as good as the screen's resolution. Few screens can match the 300 dots-per-inch resolution of a laser printer. Therefore, at print time, bit-map curves and diagonals appear jagged. Despite this trade-off in quality, a paint package can provide subtle, artistic effects, shades and shadows that are difficult to achieve with line-art.

By contrast, line-art programs such as AutoCAD, MacDraw, and GEM Draw do not use bit-maps. They combine basic

geometric shapes to build up pictures. Shades, surfaces, and planes are rendered as lines, arcs, circles, and other geometric objects. Hence the term “object-oriented” graphics.

These objects are stored as mathematical expressions. A circle is described as a center point and a radius, a line is described as a starting and ending point, an arc as three consecutive points, and so forth. Line-art has several advantages. When you print an object-oriented picture, the computer sends its description to the printer. The picture is then printed at whatever resolution the printer or phototypesetter is capable of — 300, 600, 1200, or 2500 dots per inch. As a result, lines and curves appear smooth (Figure 5–2).

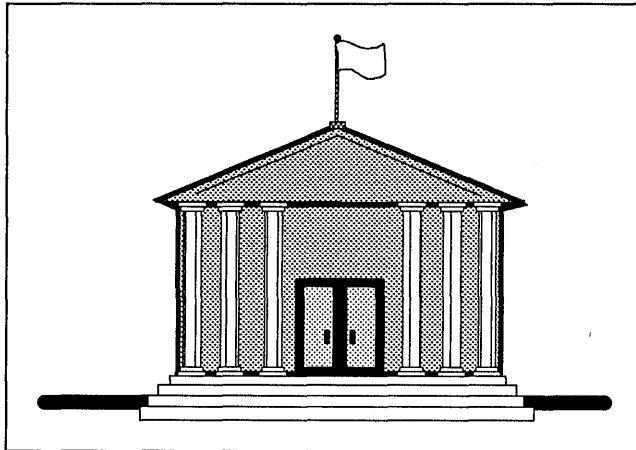

Figure 5–2. When you print an object-oriented picture, you send its mathematical description to the printer. The picture is printed at the resolution of the printer or typesetter.

Line-art has another advantage. You can enlarge or reduce it without losing picture quality. You don’t have to worry about creating it at the same size as the final version.

Encapsulated Postscript files

If you have a PostScript printer you can also use a special kind of line-art. With the Encapsulated PostScript (EPS) format you can create a small facsimile of each of your Ventura documents and insert them as line-art in a frame. For instance, we used the EPS format to produce the “after” pictures

near the beginning of each chapter. When you place an Encapsulated PostScript file created in Ventura, the picture is not displayed on screen. Instead, the picture appears as a large “X” (Figure 5-3). The picture, however, is visible when you print. You will have a chance to use Encapsulated PostScript to build the sample advertisement in this chapter.

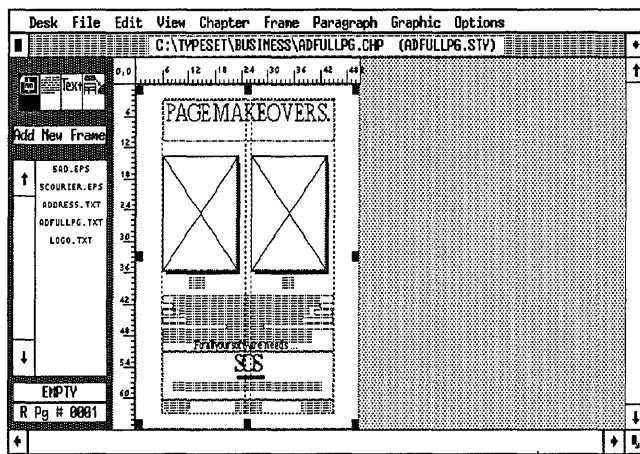

Figure 5-3. Encapsulated PostScript files generated by Ventura appear on-screen as a large X.

➔ **NOTE:** Programs that embed TIFF image or Windows metafile representations of PostScript within the EPS file will be visible on-screen.

Sizing and scaling pictures

Both line-art and images can be scaled and cropped through the Sizing & Scaling dialog box (Figure 5-4).

For many beginners, Sizing & Scaling is one of the most difficult Ventura functions to grasp. We will present you with basic concepts here in the theory section, but don't be too surprised if you don't understand all the ins and outs until you've had some hands-on practice.

The dialog box gives you two options: Fit in Frame and By Scale Factors (Figure 5-5). Fit in Frame enlarges the picture until it fills the entire frame. (If you've set margins, Ventura will fill the frame up to the frame margins.)

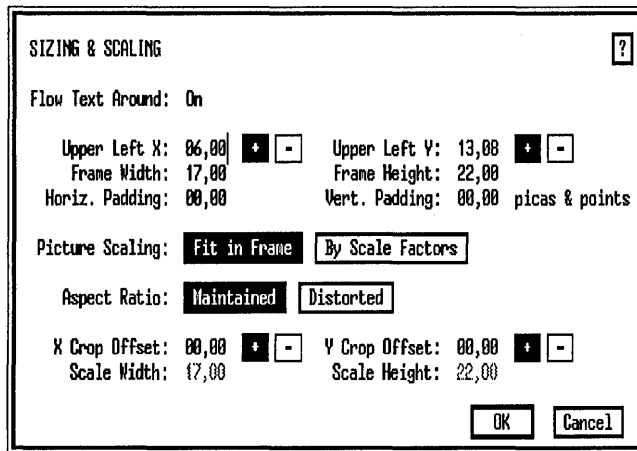

Figure 5-4.

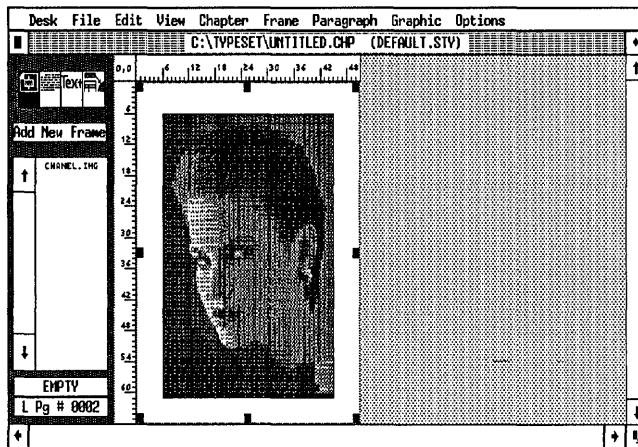

Figure 5-5. Fit in Frame enlarges the picture to fill the frame up to its margins.

When you fit a picture into a frame, you can instruct Ventura whether to maintain or ignore the original aspect ratio. By setting Aspect Ratio: Maintain Ventura enlarges the picture as much as it can without changing the original horizontal and vertical proportions. This may leave some extra white space around the image. Aspect Ratio: Distorted, on the other hand, stretches the picture as necessary to fill the frame even if it has to distort the proportions (Figure 5-6).

Remember when we warned you earlier that Sizing & Scaling can be confusing at first? Here comes the part that trips up

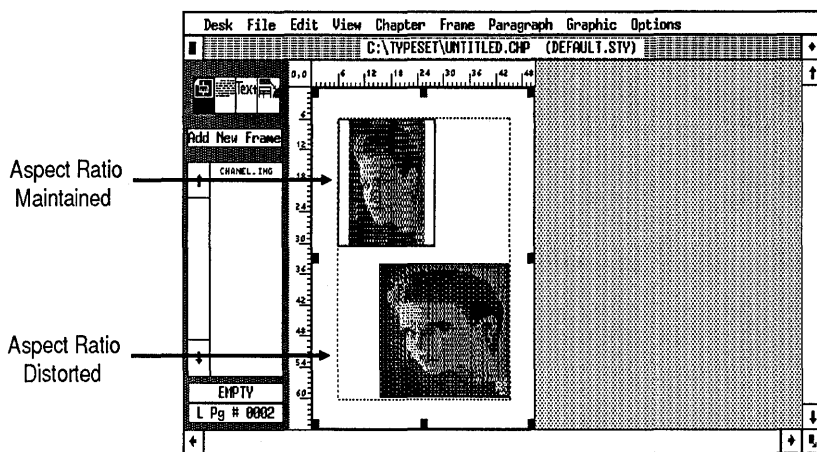

Figure 5-6. You can maintain or distort the aspect ratio to achieve the desired effect.

many beginners. When you choose *Fit in Frame*, Ventura scales (resizes) the picture for you. If you want to resize the picture manually, you must choose *By Scale Factors*.

Maybe it's the name that puzzles people. *By Scale Factors* is a fuzzy phrase that doesn't really explain what's going on. Perhaps it will be easier for you to grasp if you think of it as *Manual Resizing* or *Changing Dimensions*. Here's the idea in a nutshell: Ventura displays the old dimensions. You type in the new ones. Simple, isn't it? Now let's examine the operation in more detail.

When you choose *Picture Scaling: By Scale Factors*, Ventura displays the picture's original size (on the lines *Scale Width* and *Scale Height*). To change the size, you enter a new width or height (or both). Suppose you start with a picture 06,00 picas & points wide by 08,00 picas & points tall. To double the picture's width, you would choose *Picture Scaling: By Scale Factors* and then enter 12,00 picas & points as the new width. After you enter the new width, you can choose whether or not to keep the original proportions. *Aspect Ratio: Maintain* calculates the height to maintain the same proportions as the original. In the previous example, if you entered a new width of 12,00 picas & points, Ventura would double the height to 16,00 picas & points to maintain the original width and height ratio. With *Aspect Ratio: Distorted* you can choose any combination of widths and heights (Figure 5-7).

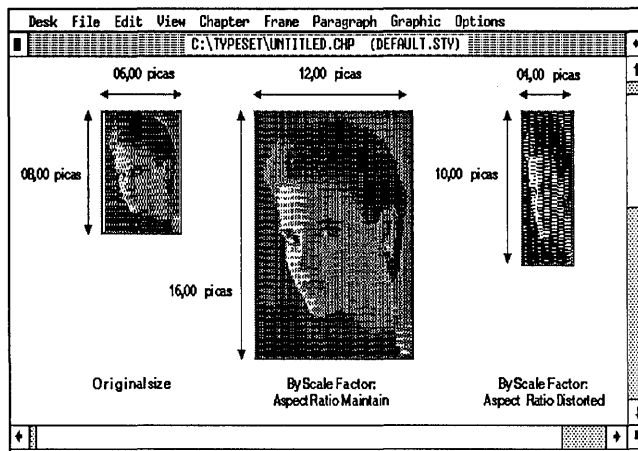

Figure 5-7. When you increase the size of a picture By Scale Factors, you can maintain or distort the aspect ratio.

➔ *TIP: When working with scale factors, the height and width in the Sizing & Scaling dialog box represent the current size of the picture. To change the dimensions of a picture, enter a new height and width.*

Cropping pictures

While scaling enlarges or reduces a picture, cropping moves it up, down, right, or left within the frame to display selected portions of the picture.

With both bit-mapped and line-art images, you can crop interactively by moving the picture within the frame with the mouse cursor. Here's how: In Frame mode, you select the frame containing the picture to crop, and place the mouse cursor somewhere in the middle of the frame (or picture). Then you hold down the mouse button while pressing the Alt key. A picture of a hand appears. You hold the mouse button down and drag the hand to move the image (Figure 5-8).

If you need more precision, you can crop the picture by entering a positive or negative X or Y offset. The offset is the distance the picture moves from its original position. Imagine a horizontal and vertical axis starting at the upper left corner. You can slide the picture along the horizontal (X) axis or the vertical (Y) axis. A positive X offset moves the picture left; a

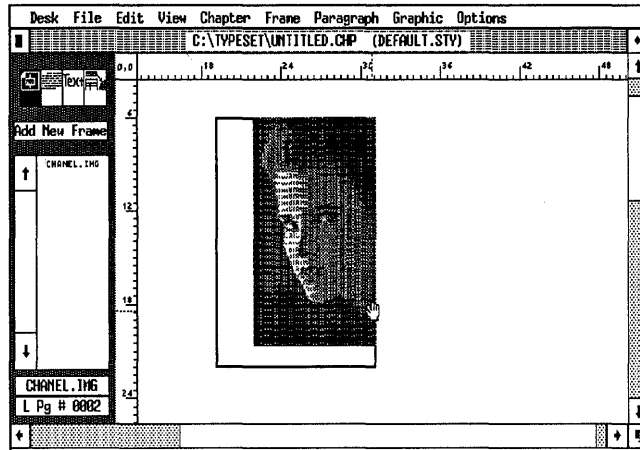

Figure 5-8. You can crop bit-mapped and line-art pictures interactively by pressing the Alt key and holding down the button as you move the mouse inside the frame.

negative X offset moves it right. A positive Y offset moves the picture up; a negative Y offset moves it down.

If you want to practice cropping, try changing one variable at a time: enter a positive X offset only, then a positive Y offset, and so forth. Then try combining a positive X and a positive Y offset; a negative X and a Y. The more you practice, the better you'll be able to visualize the position of the picture in the frame. Figure 5-9 shows one example.

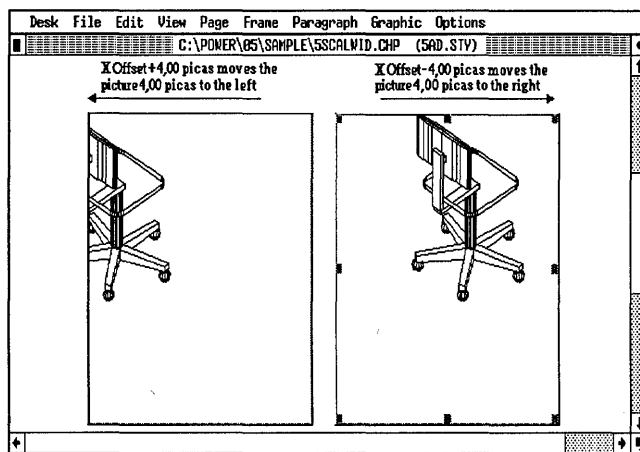
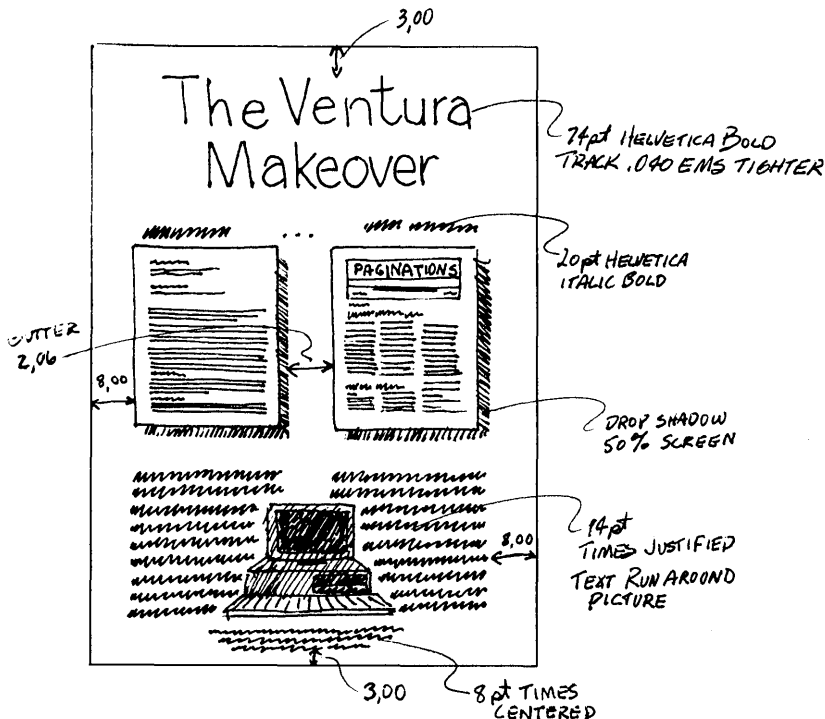

Figure 5-9. You can also crop pictures by entering numbers into the Sizing & Scaling dialog box.

Before



After

Introducing a cure for the common document...

Learn how to turn your ideas into polished, professional-looking documents — right on your desktop!

XYZ Corporation
123 Main Street
Los Angeles, CA 90008

International Paper Company
370 Broad Street
Philadelphia, PA 19108

The Ventura Makeover

Take a great idea ... and make it greater

Now you can give an ordinary personal computer the power of a professional print shop. With Xerox Ventura Publisher and expert training from the people at XYZ Corporation, you can learn to create professional-quality documents using a personal computer and an inexpensive laser printer. For this week only, when you come in for a no-risk demonstration, we will redesign one of your corporate documents, while you watch! But hurry—our offer is limited. Call (213) 555-1111 today.

Created your original XYZ documents by the folks at Xerox. XYZ Corporation, 123 Main Street, Los Angeles, CA 90008. Xerox is a trademark of Xerox Corporation.

Planning the flyer

Consider the thousands of advertisements you see each year. How many do you remember? In a small amount of space an advertisement must provoke, lure, entice (or annoy) the prospect into reading the copy and (hopefully) buying the product. Advertisements also carry another responsibility: They project the company name and image to the outside world. For these reasons, good design is crucial to the success of an advertisement. Some documents — reports, proposals, memos — can get by with an adequate page design. But adequate is not good enough for an ad. The public is bombarded by hundreds of advertisements each day. Sales materials that are merely average will be ignored.

The design of an advertisement carries several burdens. First, it must attract attention. Second, it must lead the eye into the copy and keep it moving. And third, it must reinforce the underlying theme and message of the words. Meeting these goals requires attention to all the details that make up good design — the layout, the typography, the white space, the graphics, and so on. Fortunately, Ventura Publisher provides the tools to fine-tune your pages so they stand out from the crowd.

This chapter's sample advertisement is a self-mailer — it can be folded in thirds, stapled, and mailed without needing an envelope. The first page is the mailer. It has been divided into three panels as illustrated in Figure 5-10. The top panel (#1) is the inner flap. It is tucked inside when the flyer is folded and stapled for mailing. The center panel (#2) is the back flap. Both the inner and the back flap contain "teaser copy," designed to entice the reader into opening the mailer and reading further. The bottom panel (#3) is for the address. It appears on top when the flyer is folded and contains the return address, mailing label, and stamp.

The second page of this document is the advertisement itself. It will be printed on the opposite side from the mailer. When the readers open the flyer, they can see the ad as a single, full-page unit.

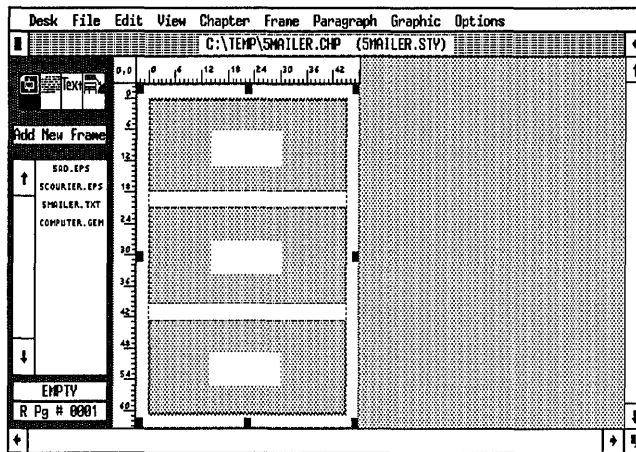

Figure 5-10. The first page of the flyer has three panels that can be folded for mailing.

➔ **NOTE:** *If your company does not prepare mailers, you can skip the instructions for page one and produce only the ad on page two. The principles and theories taught for page two apply equally to print advertisements.*

The thumbnail sketch for the the advertisement shows you some of the techniques you will use to create these effects:

- Frames on the Page
- Box Text
- Text runarounds
- Kerned headlines
- Drop shadows
- Special non-keyboard characters for a trademark symbol, ellipsis, and em dash
- Typographic controls to fine-tune the headlines and body copy

Ventura prep



If you have the Power disk

- If you are continuing from the previous chapter, select New from the File menu to clear the screen.
- Enable Frame mode and select the Page.
- Select Load Text/Picture to load the ASCII format text file 5AD.TXT from the C:\POWER subdirectory. The text automatically flows onto the Page. Use File/Type Rename to rename it as C:\TEMP\5MAILER.TXT.

Because the Page was selected when you loaded the file, Ventura placed the file on the Page for you (when you load several files, Ventura does not attempt to place any of them. You must remove the file from the Page, however, before you can add frames to contain text and graphics.

- Select Remove Text/File from the Edit menu. The file name **5MAILER.TXT** appears on the File name line. Choose Remove from: Frame.

➔ *NOTE: As we explained earlier in Chapter Two, Ventura will not allow you to rename a text file until it has been placed on the Page.*

- Select Load Diff. Style to load the style sheet 5AD.STY from the C:\POWER subdirectory.
- Use Save As New Style to save it as C:\TEMP\5MAILER.STY.

Now load the two PostScript files.

- Select Load Text/Pictures and choose Type of File: Line-Art, Line-Art Format: PostScript, and # of Files: Several. Load the two files, 5AD.EPS and 5COURIER.EPS in turn from the C:\POWER subdirectory. When you are finished, click OK or Cancel to return to the document.

Next, load the line-art picture.

- Press Ctrl-X to redisplay the Load/Text Picture dialog box.

Choose Type of File: Line-Art, Line-Art Format: GEM. Load the file COMPUTER.GEM from the C:\POWER subdirectory.

➡ *TIP: You can use Ctrl-X whenever you want to redisplay the previous dialog box.*

■ Use Save As to save the chapter as C:\TEMP\5MAILER.CHP.



If you do not have the Power disk

- Using your word processor, type the text file for Chapter 5 from Appendix A and save it as C:\TEMP\5MAILER.TXT.
- Load the original Ventura style sheet &PREL-P1.STY from the C:\TYPESET subdirectory. Change the margins and columns to match Figure 5–11. Rename it as C:\TEMP\5MAILER.STY.
- Change the tags to match the ones listed in the tag table in Appendix B.
- Load three Ventura sample line-art picture into the Assignment List. If you don't have any line-art pictures of your own, load the Ventura sample picture COLUMBIA.GEM from the C:\TYPESET subdirectory.
- Save the chapter as C:\TEMP\5MAILER.CHP.

Text

In this project, you will use three techniques to place text. You will place a file into a frame; you will type text directly into a frame; and you will use Box Text. This is a good opportunity to apply what you've already learned about text to a design that requires a combination of different skills. Like the newsletter and form in Chapters Three and Four, this sample document relies heavily on text in frames and Box Text. Therefore, you will vary slightly from the Ventura Formula and delay placing text until you build frames and boxes to contain it.

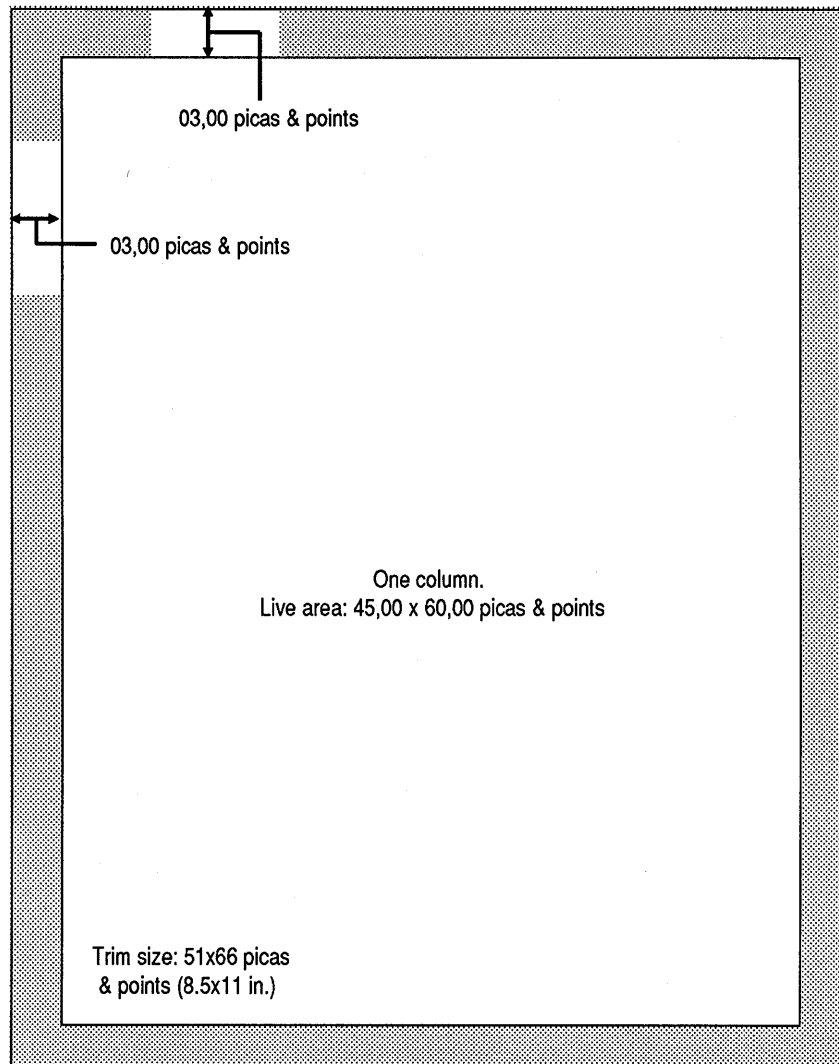

Figure 5-11. If you do NOT have the Power disk, change &PREL-P1.STY to match these dimensions.

Style

Your first task is to size and position frames and Box Text. If you start by laying out the margins and columns on the Page, you can use them later as a guide.

➔ *TIP: Even when creating a free-form, graphics-intensive document, start by formatting the Page as a framework.*

Select the page format

Since this piece is a self-mailer, it will be printed on both sides — the mailing information on the outside and the ad on the inside. As you know from Chapter Three, a double-sided format allows you to mirror identical headers, footers, margins, etc., on right and left pages. For this advertisement, however, you will create left and right pages that have completely different values (Figure 5–12).

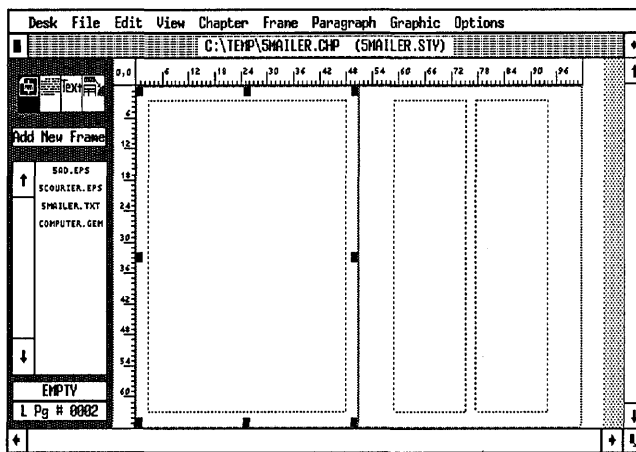

Figure 5–12. This project has different formats for the left and right pages.

- Select Page Size & Layout from the Chapter menu. Choose Sides: Double, Start On: Right Side.

Layout page one

The style sheet you loaded (or created) contains the column and margin settings for the first page. This one-column format lets you easily place and size frames for the mailing panels. Continue on to add frames and Box Text to the page.

- Verify that Column Snap and Line Snap are turned on from the Options menu. (The menu displays “Turn Column Snap Off” and “Turn Line Snap Off.”)

- Reset the zero point to line up with the upper left corner of the column guide (Figure 5-13).

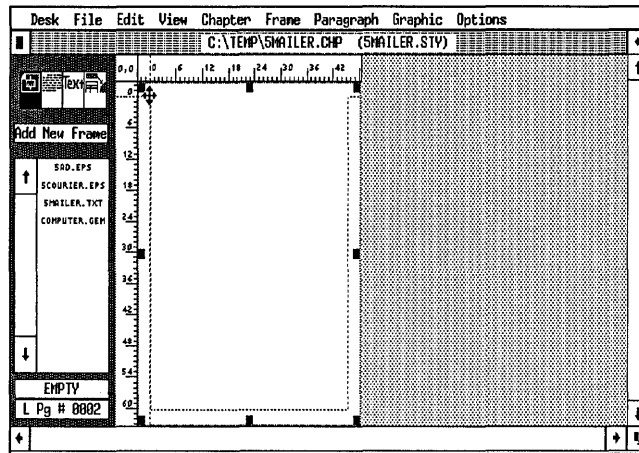

Figure 5-13.

- **NOTE:** If you reset the zero point (to a point other than the upper left corner of the Page), the Upper Left X and Y values in the Sizing & Scaling dialog box do not change to reflect the new ruler positions. The Upper Left X and Y values are always measured from the upper left corner of the page.

Draw three frames on page one

- Draw three frames on top of the Page. Draw frame #1 starting at position 0,0 picas on the ruler. Draw frame #2 starting at position 21 picas on the vertical ruler and frame #3 starting at position 42 picas on the vertical ruler.

Use the horizontal and vertical crosshairs and rulers, and the Sizing & Scaling dialog box to position and size the frames on the Page. Figure 5-14 will help you gauge the frame dimensions.

- **TIP:** For more accuracy, you may want to change to Normal View . Place the upper left corner and stretch the frame as large as possible. Then enter the width and height of the frame through the Sizing & Scaling dialog box.

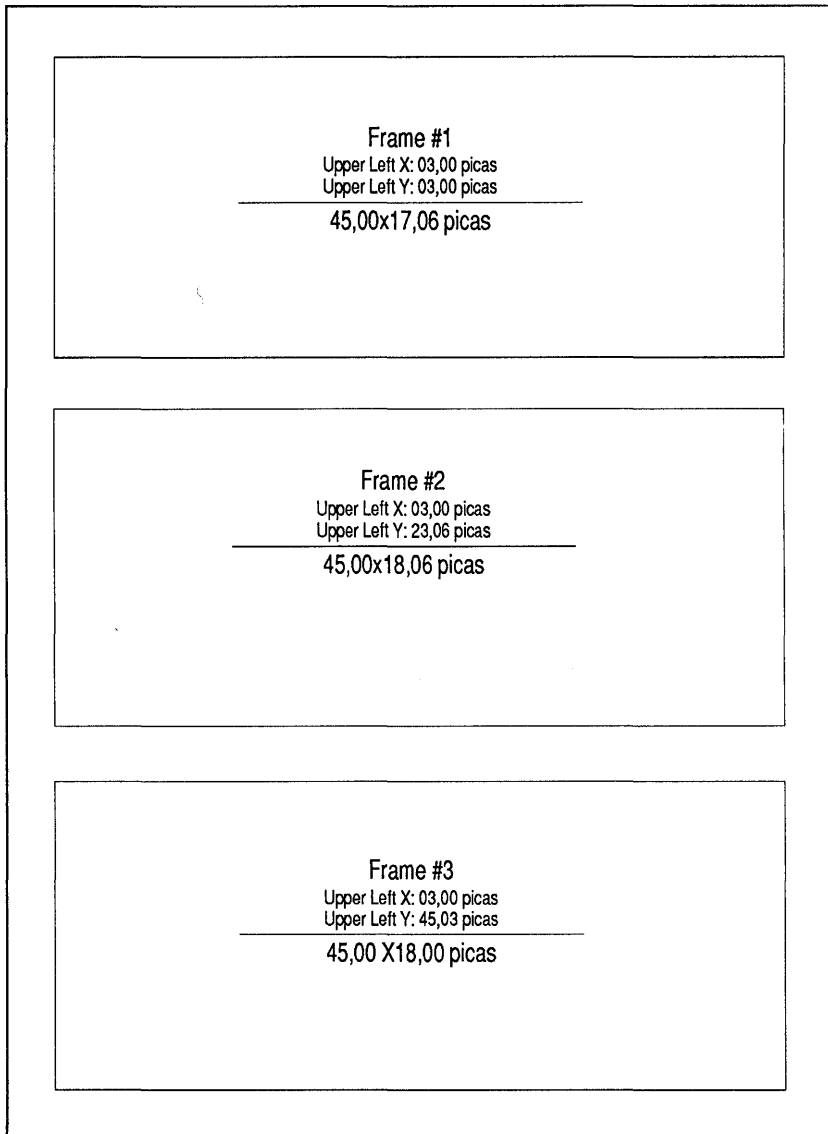

Figure 5-14. Draw these three frames on page one.

You will notice that the frames are not of equal size; nor are they spaced equally. Rather, they have been sized so that the smaller inner flap can fold up comfortably beneath the address flap.

Draw Box Text shapes in the bottom frame (frame #3)

Now that you have placed the three frames, you will add the Box Text and rectangle shapes that show the position of the return address, mailing label, and stamp in the bottom frame. Start by setting a snap-to grid.

- Enable Graphic mode. Select the bottom frame (frame #3).
- Select Grid Settings. Choose Grid Snap: On. Make both the Horizontal and the Vertical Spacing 01,00 picas & points.

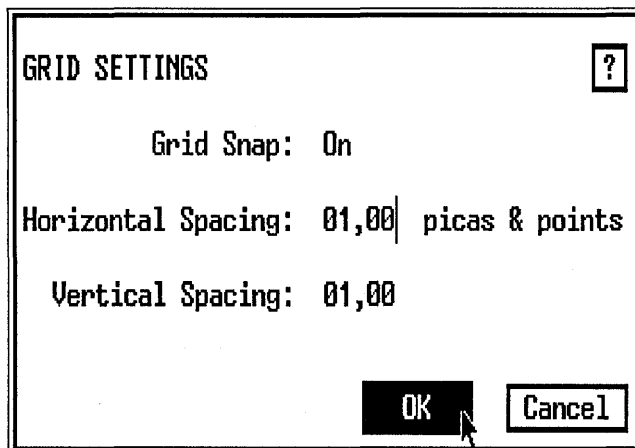

Draw the return address Box Text

Draw the return address using Box Text.

- Reset the zero point of the ruler to line up with the upper left corner of the bottom frame (Figure 5-15).
- Select the Box Text tool from the Side-Bar. Starting at position 01,00 picas on the vertical ruler and position 01,00 picas on the horizontal ruler, draw a box 05,00 picas high and 12,00 picas wide.

➔ *TIP: Remember, you can check the size of a Box Text or rectangle by placing the ruler's zero point on one corner of the shape.*

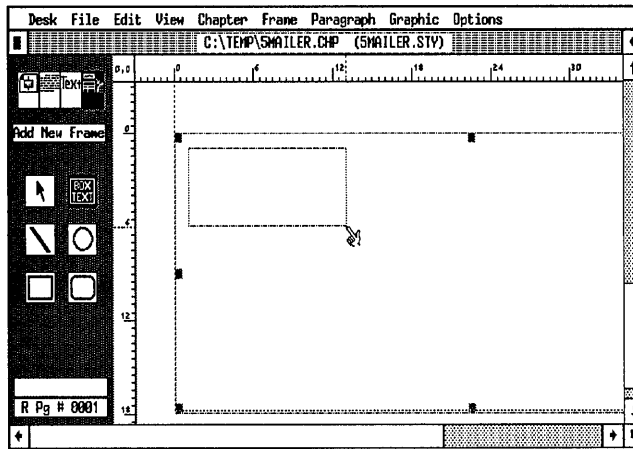

Figure 5-15.

Next you will change the line attributes for the Box Text.

- Line Attributes Thickness: Thin
 End Styles (Beginning and End): Square
 Defaults: Save To

- Fill Attributes Color: White
 Pattern: Hollow
 Results: Transparent
 Defaults: Save To

Draw the mailing label

Now you will use the Box Text shape to draw a mailing label 06,00 picas high and 24,00 picas wide (1 inch by 4 inches, a standard label size) in the bottom frame (frame #3).

- Select the Box Text tool. Starting from position 08,00 picas on the vertical ruler and 13,00 picas on the horizontal ruler, draw the box 06,00 picas high and 24,00 picas wide (Figure 5-16).

Ventura remembers the line and fill attributes from the last Box Text.

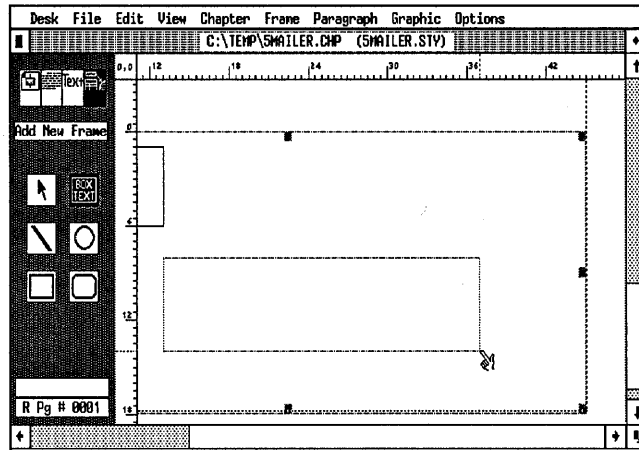

Figure 5-16.

Draw the stamp

Now you will draw the “stamp” with a rectangle shape.

- Grid Settings Grid Snap: On
 Horizontal Spacing: 00,06 picas & points
 Vertical Spacing: 00,06 picas & points

- Select the rectangle tool from the Side-Bar. Draw a rectangle 03,00 picas high and 04,06 picas wide in the upper right corner of the frame (Figure 5-17).

If necessary, move the rectangle into position.

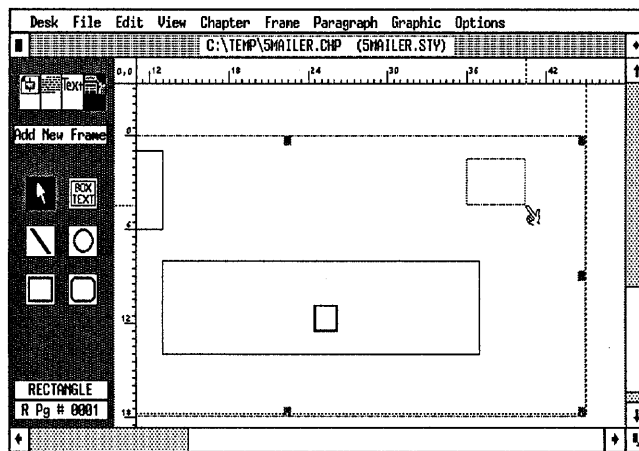

Figure 5-17.

➡ *NOTE: Judge the position as best you can from previous illustrations. Accuracy is not essential.*

Change the rectangle's attributes

- Line Attributes Thickness: Thin
 End Styles (Beginning and End): Square
 Defaults: Save To
- Fill Attributes Color: White
 Pattern: Hollow
 Results: Transparent
 Defaults: Save To

Layout page two

You have completed the layout for page one. Before you continue, reset the zero point back to its original position at the upper left corner of the column margin. As you saw earlier, when you place text in frames (instead of on the Page), Ventura doesn't automatically create new pages. Therefore, you must add one manually.

- Select Insert/Remove Page from the Chapter menu to insert a new page after the current one.
- Choose Operation: Insert New Page After Current Page and click OK.

On the second page, you will create a two-column format with different margins and columns from the first page. The new format will make it easier to size and place the frames for the finished layout.

- Enable Frame mode and select the Underlying Page.
- Select Margins & Columns from the Frame menu. Choose # of Columns: 2. Set the top and bottom margins at 03,00 picas & points. Make the left and right margins 08,00 picas & points. Make the Column 1 width 16,03 picas & points and the first gutter width 02,06 picas & points. Choose Make Equal Widths and click OK.

| MARGINS & COLUMNS | | | | ? | | | | |
|-------------------|---|---------------------------------------|--|----------------------------|---------------------------------------|----------------------------|----------------------------|----------------------------|
| # of Columns: | <input type="checkbox"/> 1 | <input checked="" type="checkbox"/> 2 | <input type="checkbox"/> 3 | <input type="checkbox"/> 4 | <input type="checkbox"/> 5 | <input type="checkbox"/> 6 | <input type="checkbox"/> 7 | <input type="checkbox"/> 8 |
| Settings For: | <input checked="" type="checkbox"/> Left Page | | <input type="checkbox"/> Right Page | | | | | |
| | Widths | Gutters | Margins | | | | | |
| Column 1: | 16,03 | 02,06 | Top: | 03,00 | picas & points | | | |
| 2: | 16,03 | 00,00 | Bottom: | 03,00 | | | | |
| 3: | 00,00 | 00,00 | Left: | 08,00 | | | | |
| 4: | 00,00 | 00,00 | Right: | 08,00 | | | | |
| 5: | 00,00 | 00,00 | | | | | | |
| 6: | 00,00 | 00,00 | | | | | | |
| 7: | 00,00 | 00,00 | | | | | | |
| 8: | 00,00 | 00,00 | | | | | | |
| | | | Calculated Width = | | 51,00 | | | |
| | | | Actual Frame Width = | | 51,00 | | | |
| Inserts: | <input checked="" type="checkbox"/> Make Equal Widths | | <input type="checkbox"/> Copy To Facing Page | | | | | |
| | | | <input type="button" value="OK"/> | | <input type="button" value="Cancel"/> | | | |

➔ *TIP: As a general rule, always enter the top, bottom, left, and right margins before you enter the column widths. If you want all the columns equal, use this sequence: enter the first column width, then the first gutter width, and then choose Make Equal Widths. If you want unequal columns, enter the first column width, then the first gutter width, and then manually enter the second column width.*

Add frames to page two

Once you set the margins and columns for page two, you are ready to add the frames. Use the ruler plus Line and Column Snap to accurately position the frames as shown in Figure 5-18. Use the Sizing & Scaling dialog box to verify the position and size of the frames.

■ Draw the frames on page two using Figure 5-18 as a guide.

➔ *NOTE: We intentionally placed the bottom-most frame (frame #6) so it extends below the bottom column guide.*

Add a ruling box around the center frames

To make the two center frames (frame #6 and #7) stand out on the page, and to enclose the pictures that will be placed inside, add a Ruling Box Around.

■ Select the left frame (frame #6).

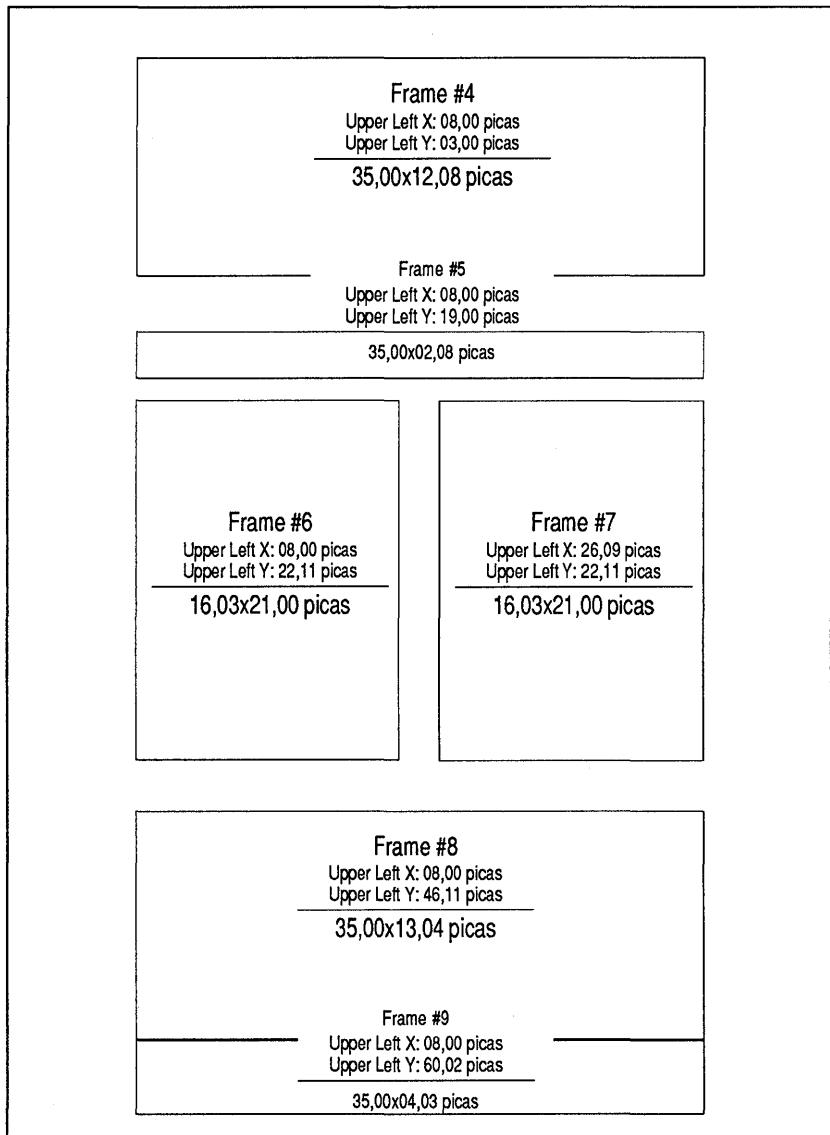
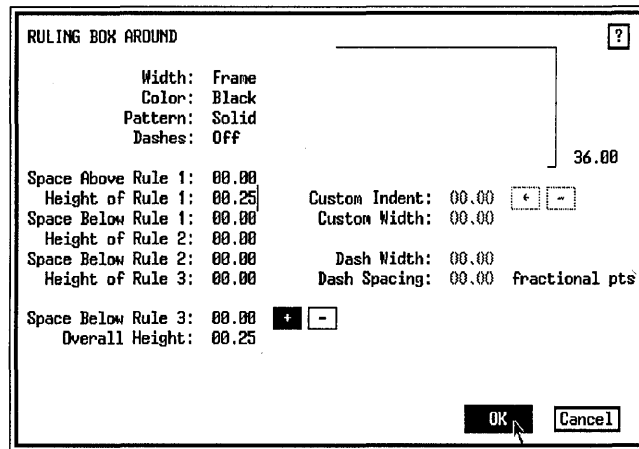

Figure 5-18. Draw frames matching these dimensions on page two.

- Select Ruling Box Around from the Frame menu. Choose Width: Frame. Give Rule 1 a height of 00.25 fractional pts and click OK.



Repeat the step above for the right picture frame (frame #7). When you are finished the frames should look like Figure 5-19:

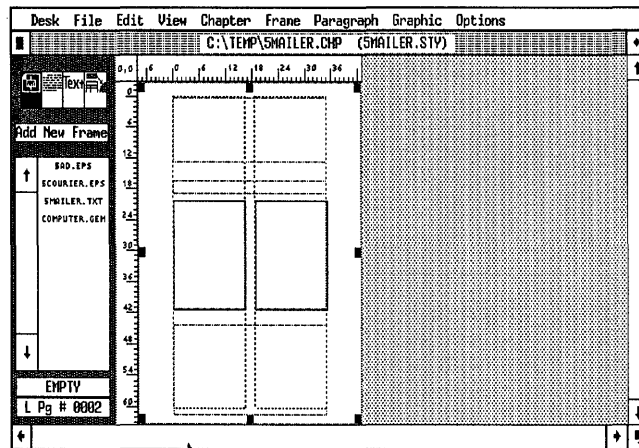

Figure 5-19.

Change the number of columns in one frame

When you place a frame on the Page, Ventura gives it a single column and sets all the margins to 00,00 picas & points. With Margins & Columns you can change the margins of a frame.

Select the frame reserved for the body copy (frame #8).

- Select Margins & Columns. Choose # of Columns: 2. (Notice that Ventura remembers the two-column and gutter set-

tings from the Page.) Leave the column and gutter settings as they are and keep all the margins at 00,00 picas & points. Then click OK to close the dialog box.

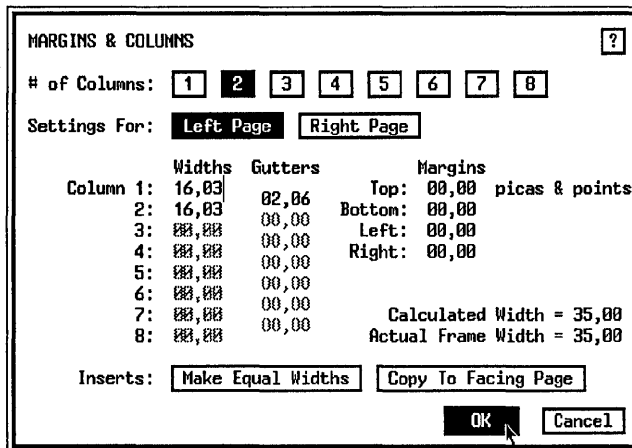

Now the frame has the same column and gutter settings as the Page (even though the column guides are not visible inside the frame).

Add text to page one

With the frames in their proper place you can enter the text. Start on page one and work frame-by-frame until you have placed all the text.

- Press PgUp to go to page one.
- Enable Text mode and click the text cursor anywhere inside the top frame (frame #1).

➔ **NOTE:** You may want to change to Normal or Enlarged View as you type in the text.

Type the first teaser

Use a non-keyboard character to create the ellipsis at the end of the first teaser headline. At this point, do not worry about the appearance of the text. You will format it later.

■ Type:

Introducing a cure for the common document

Now make the ellipsis:

■ Hold down the Alt key and use the numeric keyboard to type: 193

Then release the Alt key.

Type the second teaser

Now enter the second headline, which includes another non-keyboard character — the em dash in frame #2.

■ Place the text cursor anywhere in the middle frame (frame #2), and type the text shown in the Figure 5–20. Place a line break (press Ctrl-Enter) at the end of each line.

(To make the em dash, hold down the Alt key and type: 197 on the numeric keypad, or type Ctrl-]).

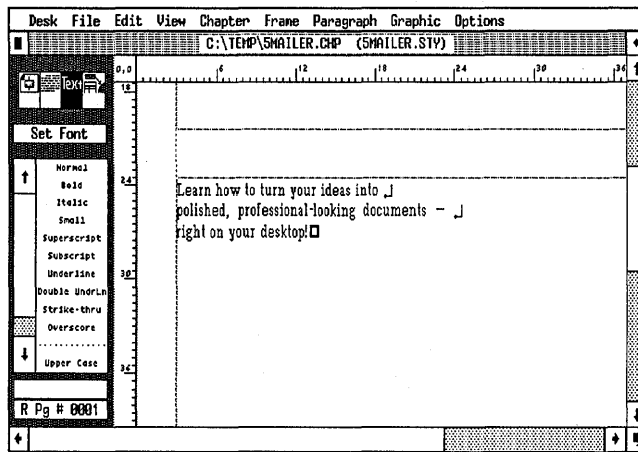

Figure 5–20.

Type the return address

Now move to the bottom frame (frame#3).

■ Type the text into the Box Text shape as shown in Figure 5–21. Place line breaks (press Ctrl-Enter) at the end of each line. If the text doesn't fit, make the Box Text shape bigger.

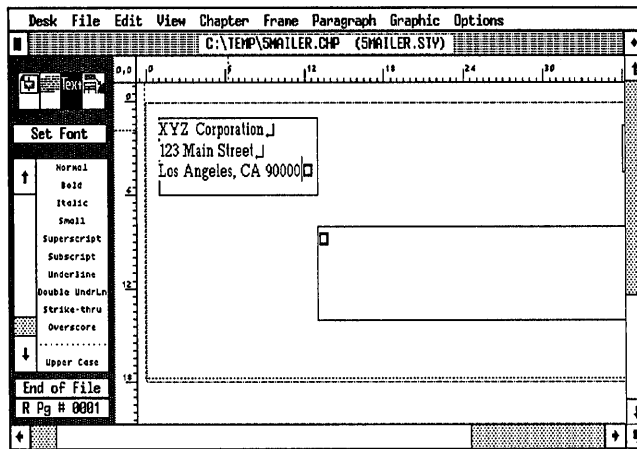

Figure 5-21.

Type the mailing address

- Type in the mailing address in Figure 5-22.

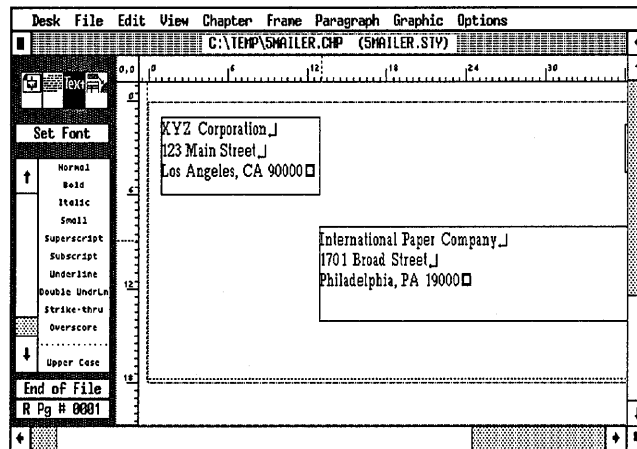

Figure 5-22.

- Enable Graphic mode and select both address boxes. Change their line attributes to none.
- Line Thickness: None
Attributes

Add text to page two

Continue on to page two and finish adding text.

- Press PgDn to go to page two.
- Enable Text mode.
- Place the cursor inside the top frame (frame #4) (Figure 5-23) and type:

**The Ventura [Ctrl-Enter]
Makeover**

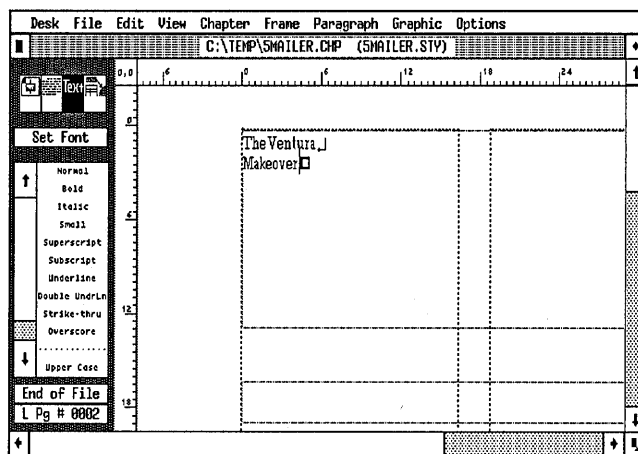

Figure 5-23.

- Now place the text cursor in the second frame (frame #5) (Figure 5-24) and type:

**Take a great idea [tab] [Alt-193] [tab] and make it
greater**

Place a text file on page two

The two frames in the middle of the page are reserved for pictures. Skip them for now and move to the frame that is second from the bottom (frame #8). It will contain the body copy you loaded at the beginning of the project.

- Enable Frame mode and select the frame.
- Select the file 5MAILER.TXT from the Assignment List.

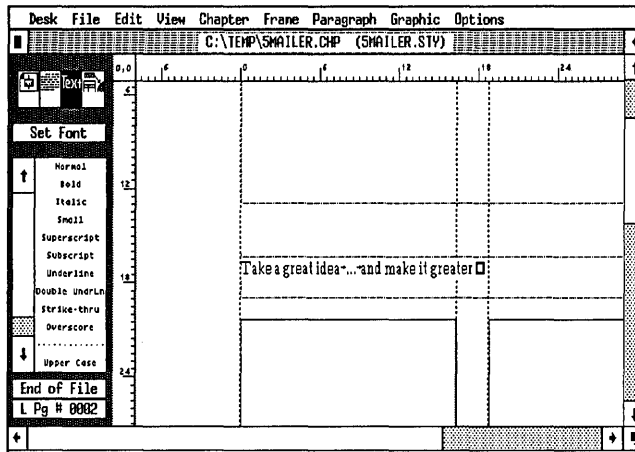

Figure 5-24.

Ventura flows the text into the frame and stops (Figure 5-25). Do not be concerned that the text doesn't fill the frame. When you get to the picture section, you will insert a small frame between the text columns, which will reflow the text to the end of the frame.

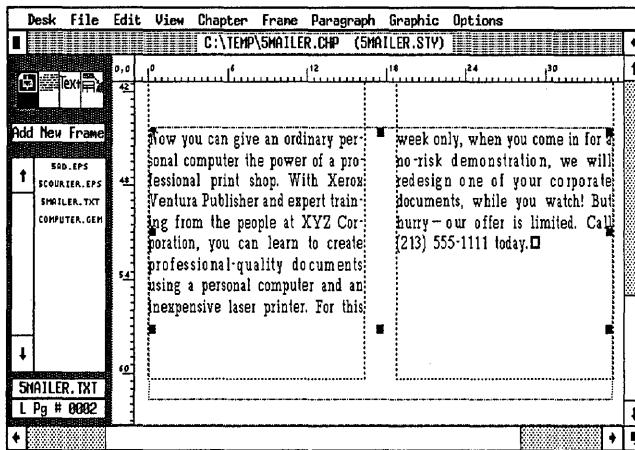

Figure 5-25.

Type the remaining text on page two

Now you will place text in the bottom-most frame (frame #9) (Figure 5-26). Use a non-keyboard character to create the registered sign after the word Xerox.

- Enable Text mode.
- Place the text cursor in the bottom-most frame (frame #9) and type:

Contact your nearest XYZ representative for further information. [Ctrl-Enter]
 XYZ Corporation, 123 Main Street, Los Angeles, CA 90000 [Ctrl-Enter]
 Xerox [Alt-190] is a trademark of Xerox Corporation.

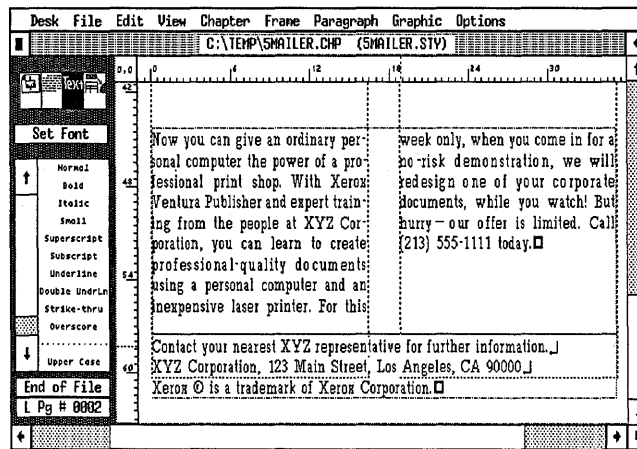

Figure 5-26.

Apply tags to page one

Now it's time to format the text. Because the tags have been predefined in the style sheet from the Power disk, all you need to do is to choose the right paragraph and apply the proper tag. Start on page one and apply the first two headline tags. If you have questions about any tags or effects, take a few moments to examine the appropriate dialog boxes from the Paragraph menu.

➡ **NOTE:** If you are not using the pre-defined style sheet from the Power disk, you must create the tags as you go along, using the tag table provided in Appendix B.

- Press PgUp to go to page one.

- Enable Paragraph mode.
- Select the teaser headline in frame #1 and tag it as Head3.
- Select the teaser headline in frame #2 and tag it as Head-Rotate (Figure 5-27).

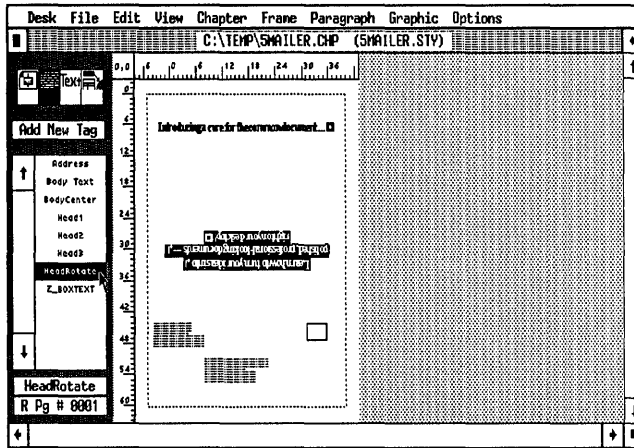

Figure 5-27.

- In frame #3, select XYZ's return address and tag it as Address.
 - Select the mailing address and tag it as BodyCenter.
- Your screen should look like Figure 5-28:

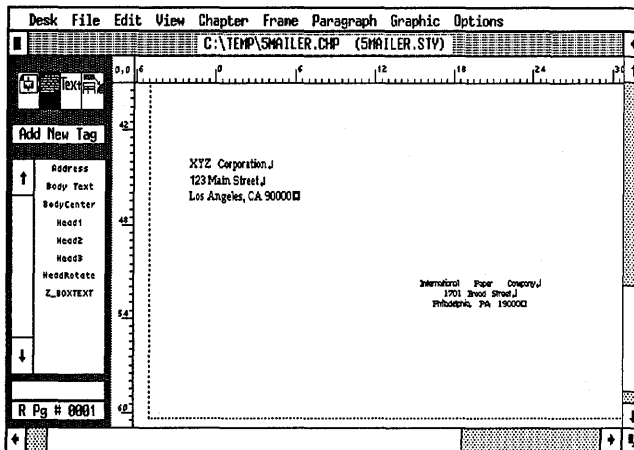

Figure 5-28.

➔ **NOTE:** If your screen shows tab and line break symbols, you know that *Show Tabs & Returns* is on from the *Options* menu.

Before you go to page two, let's take a moment to show you how we got the effect of rotated text.

- Select the teaser headline (the `HeadRotate` tag) in the second frame.

- Now select *Alignment* from the *Paragraph* menu.

Notice that *Text Rotation* is set to 180. Because we want the teaser to appear right-side up when the mailer is folded, we made it upside-down — that is, rotated 180 degrees on-screen. You can edit rotated text by placing the text cursor through the “invisible” rotated text. In practice, however, it is easier if you edit your text before rotating it.

Apply tags to page two

- Press `PgDn` to go to page two.

- Select the first headline “The Ventura Makeover” and tag it as `Head1`.

- Select the second headline “Take a great idea ... and make it greater” and tag it as `Head2` (Figure 5–29).

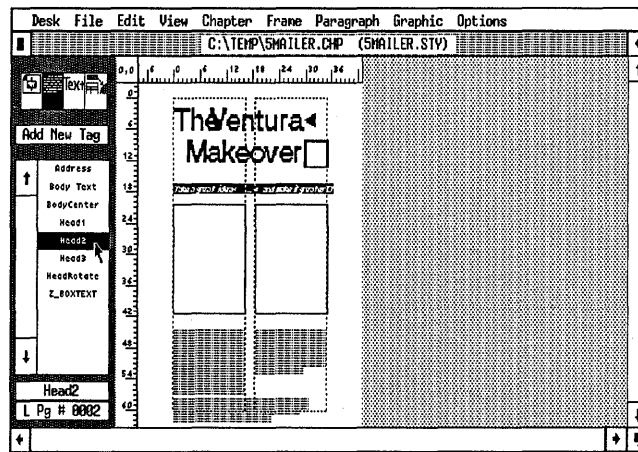

Figure 5–29.

Leave the main body copy tagged as Body Text.

- Go to frame #9 and select the paragraph that begins “Contact your nearest...” and tag it as BodyCenter (Figure 5-30).

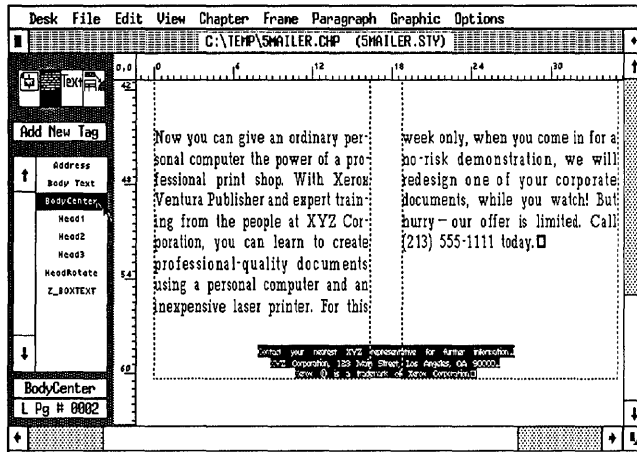

Figure 5-30.

That was fast, wasn't it? The more you tag, the easier it becomes. Before you continue, let's examine the Head2 tag more closely. You may recall that you entered two tab characters as part of the Head2 text. The first tab setting is a center tab and the second tab setting is right-aligned (Figures 5-31 and 5-32). To position the tabs correctly you should measure their locations from the edge of the frame (not the edge of the page). The location of the second tab forces the text past the visible column guides. We chose this tab location so the text would line up with the right-most picture frame.

➡ **NOTE:** The second tab setting pushes the text outside the normal frame and column boundaries.

"Head2" TAB SETTINGS

Tab Number:

Tab Type: Center

Tab Shown As: Open Space

Tab Location: 17,06 picas & points

Leader Char: Spaces 032 (ASCII)

Leader Spacing: 0

Auto-Leader: Off

OK Cancel

Figure 5-31.

"Head2" TAB SETTINGS

Tab Number:

Tab Type: Right

Tab Shown As: Open Space

Tab Location: 35,06 picas & points

Leader Char: Spaces 032 (ASCII)

Leader Spacing: 0

Auto-Leader: Off

OK Cancel

Figure 5-32. Tab settings for Head2



Stopping point

This is a good place to stop and save what you've done so far. Check your progress against the sample page in Figure 5-33.

If you wish, you can quit now and return to this project later. If you have the time, continue on to the next section. In the pictures section you will learn some helpful tips and techniques.

The Ventura Makeover

Take a great idea ... and make it greater

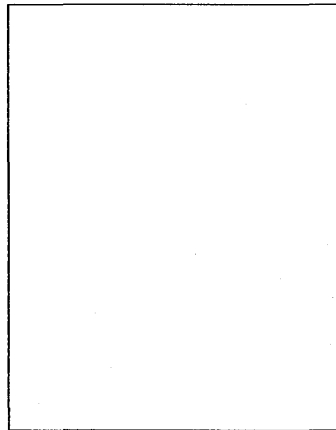
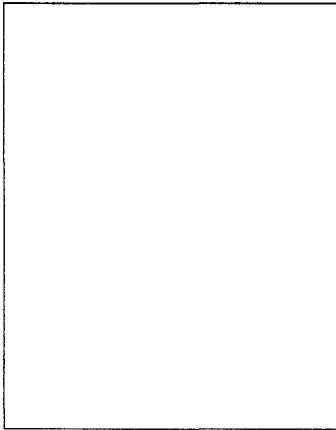

Now you can give an ordinary personal computer the power of a professional print shop. With Xerox Ventura Publisher and expert training from the people at XYZ Corporation, you can learn to create professional-quality documents using a personal computer and an inexpensive laser printer. For this

week only, when you come in for a no-risk demonstration, we will redesign one of your corporate documents, while you watch! But hurry—our offer is limited. Call (213) 555-1111 today.

Contact your nearest XYZ representative for further information.
XYZ Corporation, 123 Main Street, Los Angeles, CA 90000
Xerox is a trademark of Xerox Corporation

Figure 5-33.

Pictures

In this section you will add the final graphic touches to the advertisement by placing three line-art pictures into frames on page two.

Place pictures on page two

An advertisement relies heavily on visual imagery to create an impact and convey a message. For this example, you will place three pictures. Two of them are Encapsulated Postscript Files (which Ventura treats as line-art) and the third is a standard line-art picture (in GEM format). If you do not have a PostScript printer, leave the two EPS frames blank, or fill them with any picture of your choice.

➔ **NOTE:** *EPS files will not print on non-PostScript printers.*

- Make sure you are on page two.
- Enable Frame mode.
- Select the left frame (frame #6) and place the file 5COURIER.EPS.
- Select the right frame (frame #7) and place the file 5AD.EPS (Figure 5-34).

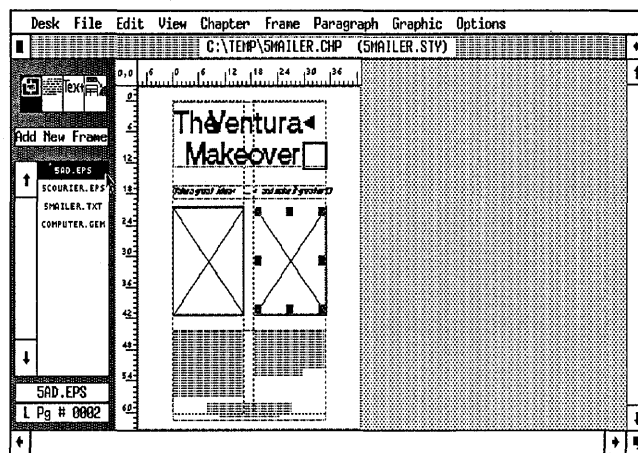

Figure 5-34.

➔ *TIP: If you see the message, “You’re about to overwrite an existing caption. You won’t be able to recover the caption text. Is that OK?,” choose Yes. Ventura displays this message if you previously typed in text or added a caption to the frame.*

When Ventura loads the Ventura-generated PostScript file into a frame, it displays an “X” on the screen. You will not see the picture until you print the chapter.

➔ *TIP: Since it is impossible to preview a Ventura-generated EPS file on-screen, it is important to make the frame size the same aspect ratio as the original EPS file.*

Add drop shadows to the frames

A drop shadow gives the illusion of depth to a two-dimensional object. One way to create a drop shadow is to lay one frame on top of another. The bottom frame, which is gray or black, is offset slightly so that only the two edges show. However, this method may not work on all printers, and slows down some others. We recommend a second method: drawing two rectangle shapes with a gray screen pattern at right angles to each other.

Before you start drawing, choose a grid value that will make it easy to place your shapes on the page.

■ Enable Graphic mode and select the left picture frame (frame #6).

■ Grid Settings Grid Snap: On
Horizontal Spacing: 00,03 picas & points
Vertical Spacing: 00,03 picas & points

➔ *TIP: Every frame on the Page can have its own grid settings.*

Draw a horizontal shadow

■ Draw a rectangle along the bottom edge of the left frame. Stretch it to the right to create the bottom shadow (Figure 5–35).

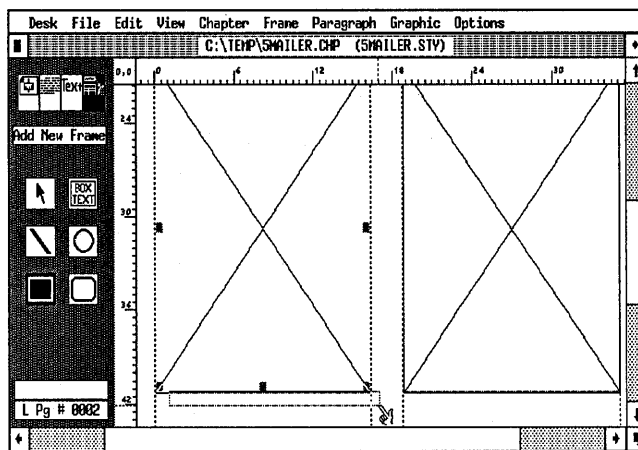

Figure 5-35.

Change the rectangle's attributes

Now change the line and fill attributes of the rectangle.

- Line Attributes Thickness: None
 Defaults: Save To
- Fill Attributes Color: Black
 Pattern: 4
 Result: Transparent
 Defaults: Save To

Draw a vertical shadow

- Draw a second rectangle at a right angle to the first as shown in Figure 5-36.

➡ **NOTE:** Do not be discouraged if it takes some time to draw the two drop shadows. If you want, go on to the next section (placing and sizing an image) and complete the shadows later.

When you are satisfied with the size and position of the drop shadow, you must use the Send to Back option, so the rectangles don't cover up the frame's ruling lines.

WARNING: If you omit this next step, the ruling lines at the bottom and side of the frame will not be visible when you print the page.

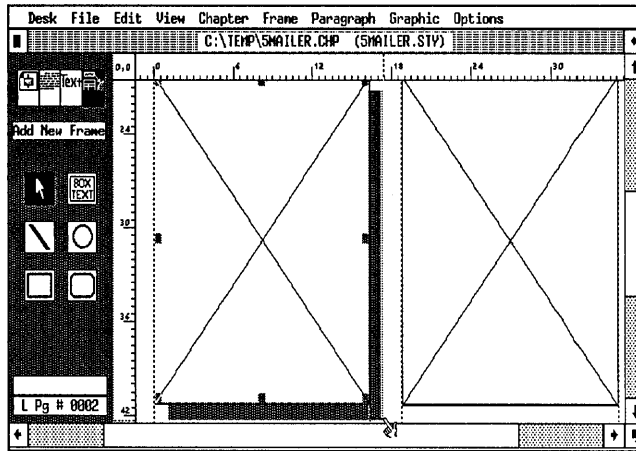

Figure 5-36.

- Use the Shift-Click method to select both rectangles. Then select Send to Back from the Graphic menu (or press Ctrl-Z), as shown in Figure 5-37.

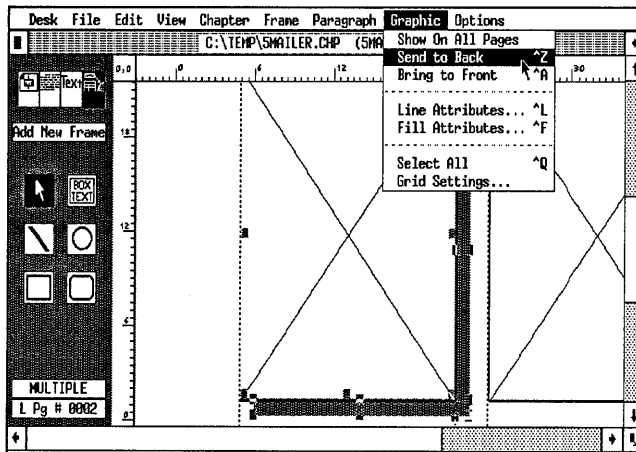

Figure 5-37.

Shadow the second frame

To eliminate a drawing step, you will copy the drop shadows from the left frame (frame #6) to the right frame using the following steps.

- Use Shift-Click to select both rectangles. To copy them into the Graphic clipboard, press Shift-Del (or select Copy

Graphic from the Edit menu). To paste them back onto the Page, press Ins (or select Paste Graphic from the Edit menu). While the rectangles are still selected, press and hold down the mouse button and drag the shapes over to the right frame. Carefully line them up with the edges of the frame. You may want to switch to Normal or Enlarged View to fine-tune the placement of the rectangles (Figure 5-38).

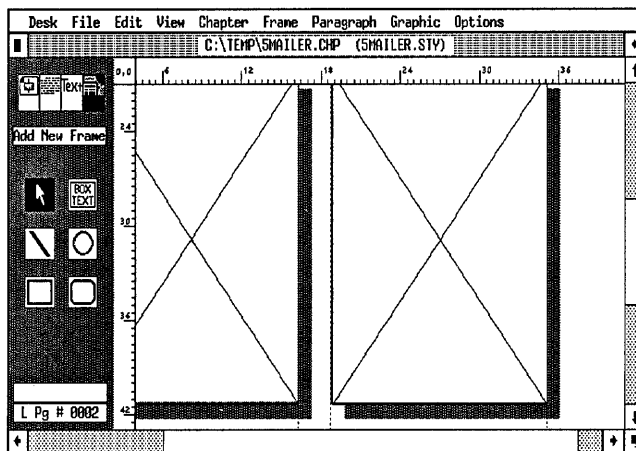

Figure 5-38.

- While the two rectangle shapes are still selected, choose Send to Back from the Graphic menu.

Place and size an image

Now that you've completed the drop shadows, you will place a picture of a computer in the next frame (frame #8) the one which contains the body copy. First, however, you will need to add a smaller frame within the frame to contain the picture.

- Enable Frame mode. Add a frame with the dimensions shown in Figure 5-39. Position the center of the frame in the center of the gutter margin. Use Sizing & Scaling to verify its position and dimensions.

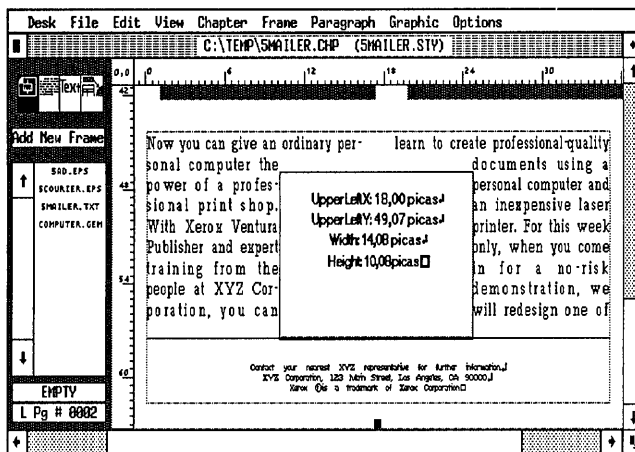
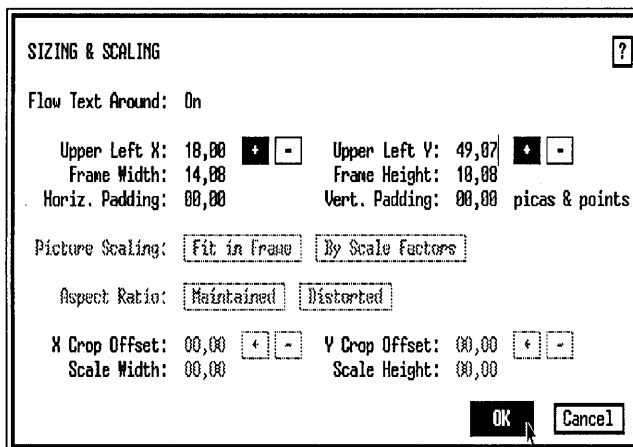

Figure 5-39. Draw a frame with the dimensions shown here to contain the picture of the computer.



Ventura automatically flows the Body Text around the new frame. Do not be concerned how the text fits into the frame or if it matches the illustration we show below. You will have a chance to make adjustments later.

Now you will place the picture of the computer inside.

- With the small frame still highlighted, place the file COMPUTER.GEM from the Assignment List.

Scale the image

After placing the picture, you can use the Sizing & Scaling dialog box to scale the picture in the frame and to make the text runaround.

- Select Sizing & Scaling from the Frame menu. Choose Flow Text Around: Off, Picture Scaling: By Scale Factor, and Aspect Ratio: Distorted.

Now crop the image.

- Enter X Crop Offset: (+) 7,00 picas & points, Y Crop Offset: (+) 11,06 picas & points. Scale Width: 30,00 picas & points and Scale Height: 30,00 picas & points.

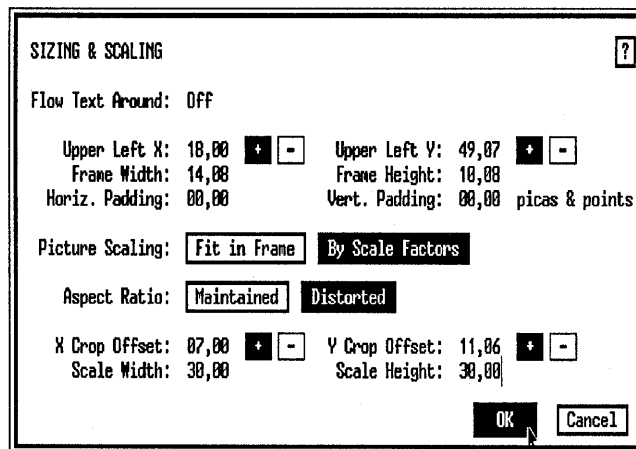

➡ **NOTE:** You can also interactively crop the image. Place the mouse cursor inside the picture frame. Then press the Alt key as you hold the mouse button. Slide the image back and forth until you achieve the placement you want.

When you turn Flow Text Around: Off, Ventura allows the text to flow into the frame and the over the picture inside it (Figure 5-40).

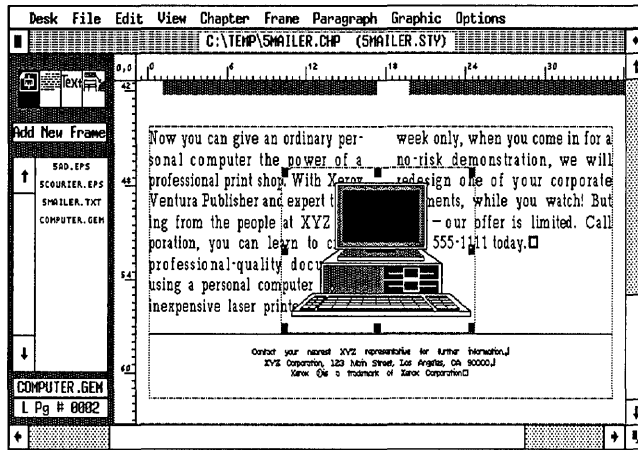

Figure 5-40.

Create a text runaround

Now that you've turned Flow Text Around off, you will now place small frames over portions of the computer to create an irregular text runaround. Place the frames in a pyramid arrangement to make the text run around in a stair-step fashion.

Before you add your frames, make sure that Line Snap is on and Column Snap is off (the Options menu).

➤ *TIP: Turning Line Snap on guarantees that the new frames will be sized in increments of the Body Text inter-line spacing. You will be able to create frames exactly one or two lines deep.*

■ Add four small frames over the computer image as shown in Figure 5-41. If you want absolute accuracy, check each frame's dimensions with the Sizing & Scaling dialog box. If you don't have the time, use your best judgment to gauge the sizes of the frame.

Copy fit the body copy

Now that you've created the text wraparound, it's time to copy-fit the text so it fills the frame exactly. With Ventura you can copy-fit in several different ways:

1. Add or delete from the text.

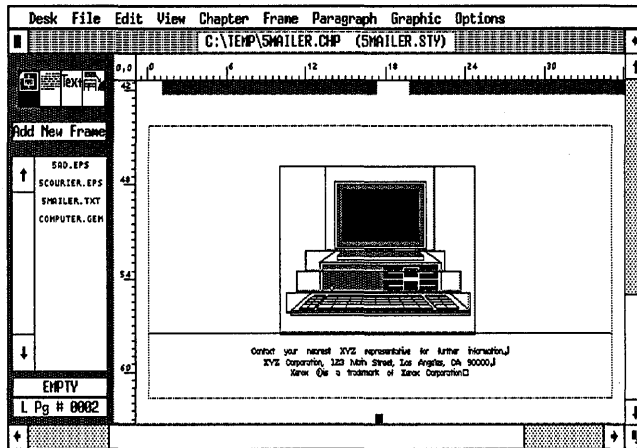

Figure 5-41.

The traditional way to copy-fit is to add or delete words to make the text fit the space. If you trim all the excess from your copy and the text still won't fit the space, try one of the other options.

2. Change the size of the frame containing the text.

When text is placed in a frame on top of the Page, you can increase or reduce the size of the frame to make the text fit. With Line Snap On you can add to or subtract from the frame size by one-line increments.

3. Fine-tune the frame typography settings.

Initially, Ventura makes all the Frame Typography settings equal to the Chapter Typography settings (e.g. Widows and Orphans, Column Balance, and Move Down to 1st Baseline). You can, however, change a setting in the Frame Typography menu so it overrides the chapter settings you defined in the Chapter Typography menu.

In this project, you will adjust the Frame Typography to make the body copy fit into the frame.

- Enable Frame mode and select the frame reserved for the body copy (frame #8).
- Select Frame Typography from the Frame menu.
- Choose Widows (Min Lines at Top): 1, Orphans (Min Lines at Bottom): 1.

- Select Column Balance: On and Move Down to 1st Baseline By: Inter-Line. Then click OK to close the dialog box.

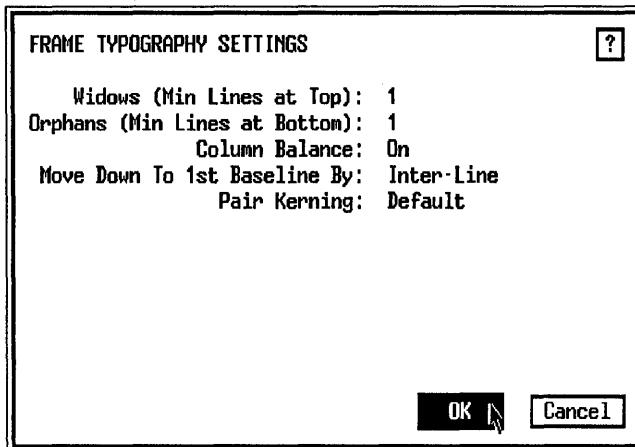

With the baseline position of text changed to inter-line, the text will align across columns (Figure 5-42).

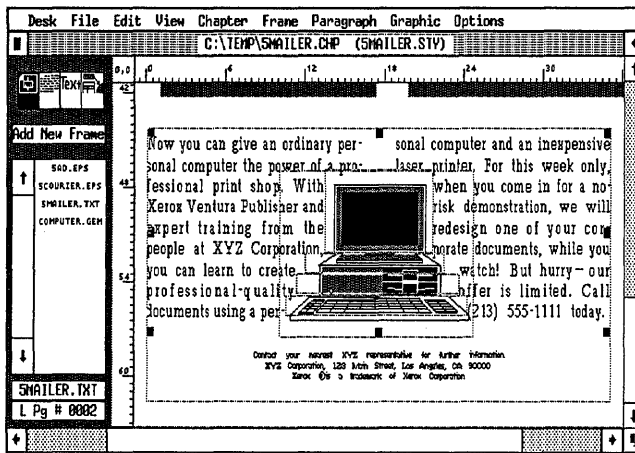

Figure 5-42.

These adjustments should make the text reach to the bottom edge of the frame. If not, try adding or deleting a few words until it looks right.

Kern the headline

Before you complete this project, we'll show you how to make

some adjustments to your headlines and body copy. Because of space limitations, we will not go through all the fine-tuning that would ordinarily occur for an advertisement. We will, however, introduce you to the methods. Once you grasp these techniques, you can use them to adjust this and other documents until all the details are perfect.

Kerning is a typographic technique that allows you to selectively reduce the amount of space between individual letter pairs and leave the rest of the word the same. Kerning (or the lack of it) is most noticeable in display type of 18 points or larger. Ventura has two ways to kern: automatically and manually.

Automatic pair kerning occurs only if the fonts for your printer come with special files called kerning tables (Ventura 2 includes kerning tables for most printers). Kerning tables contain information about special letter pairs that look better spaced more closely. Certain letter combinations are improved by kerning, such as AV, YO, Ve, LY, and Te. Figure 5-43 shows how kerning alters the appearance of the word "wave."

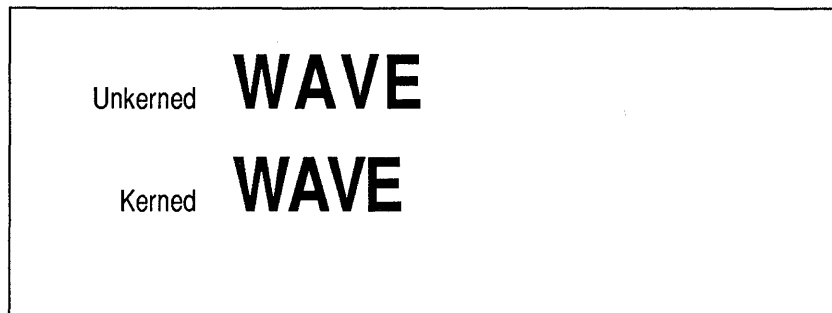

Figure 5-43.

➡ **NOTE:** *You will not do any damage if you specify automatic kerning for fonts that do not have kerning information. Ventura will simply ignore the command.*

In our example, the kerning table contains information that told Ventura what to do if it found a capital letter A followed by a capital V. More specifically, it told Ventura just how far to move the V to the left to improve the appearance of this letter pair. Although we used "AV" as an example, most kerning tables also include information on 200 or more combinations.

To implement automatic kerning, you must take two steps: (1) turn it on globally for the entire document and (2) turn it on for each tag that you want kerned. You must take both steps. Turning kerning on globally has no effect if you haven't turned it on for the individual tags. Likewise, turning it on for an individual tag does nothing unless you also remember to turn it on globally.

Enable automatic kerning for the headline

Let's begin by enabling automatic kerning for the headline. Later you will do some manual kerning as well. First you should verify that kerning is globally on.

- Select Chapter Typography from the Chapter menu. Choose Pair Kerning: On then click OK.
- Enable Paragraph mode. Select the headline "The Ventura Makeover" in frame #4.
- Select Paragraph Typography from the Paragraph menu. Verify that Automatic Pair Kerning is on, Letter Spacing is off, and Tracking is set to 0.040 Ems Tighter. Click OK.

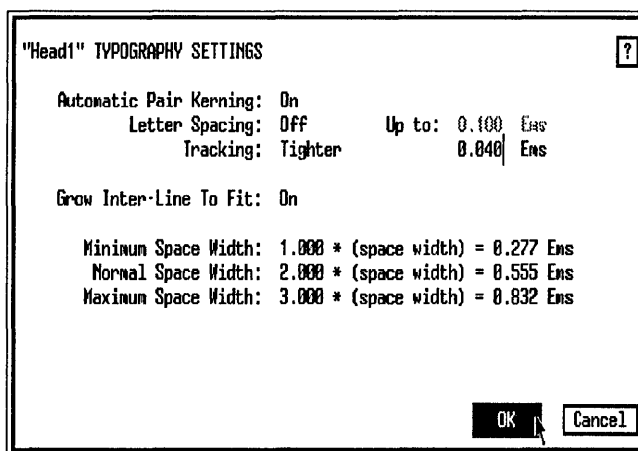

With the Paragraph Typography dialog box, you can also tighten type with the tracking command. Refer to Chapter Three for an explanation of tracking.

Perform manual kerning on the headline

You can also kern manually in addition to, or instead of automatic pair kerning. For example, here's how to move the “e” in the word “Ventura” close to the “V”.

- Enable Text mode. Select the letter “V” in the word “Ventura” (Figure 5-44).

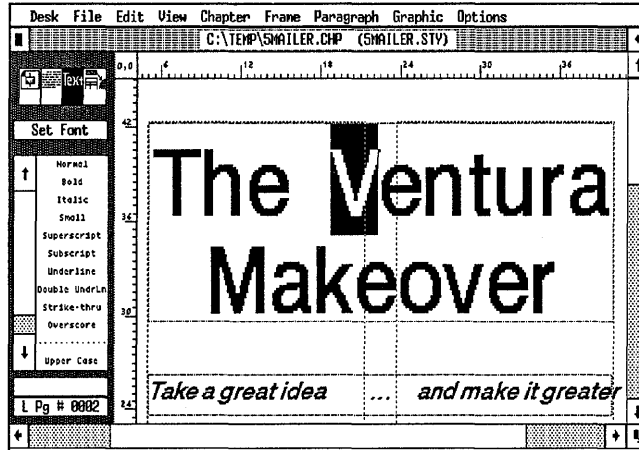

Figure 5-44.

- Hold down the Shift key and press the left arrow key 8 times to move the letter “e” closer to the V.

➔ *NOTE: When you kern manually, the letter following the selected letter moves in the direction of the arrow.*

This moves the “e” closer to the V. The amount of kerning is a matter of personal taste. We suggest you experiment with different values until you come up with the best look.

➔ *NOTE: Do not be concerned if the letters overlap on-screen. When you print out the page, the two letters will look right.*

You can also kern manually using the Set Font Addition button in Text mode. Highlight the letter “V” and choose Set Font from the Side-Bar. Choose Kern: Tighter and enter the amount in Ems to kern. When you close the dialog box you can see the result of the kerning.

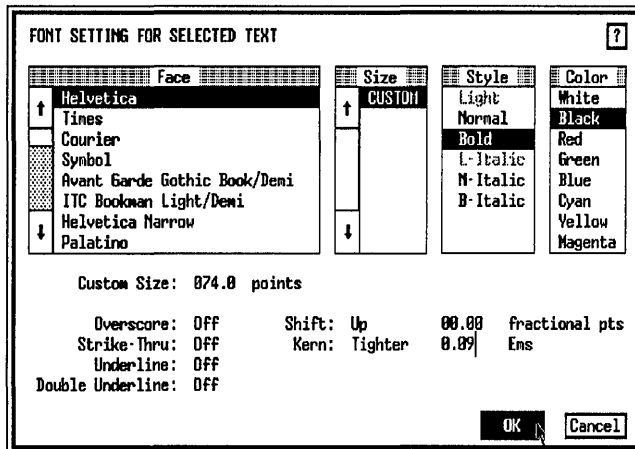

About screen kerning

You may not notice much difference on the screen when you apply kerning. Check Set Preferences from the Options menu to see if On-Screen Kerning is on for all display type 18 points and larger.

- Select Set Preferences from the Options menu. Choose On-Screen Kerning: 18. Click OK.

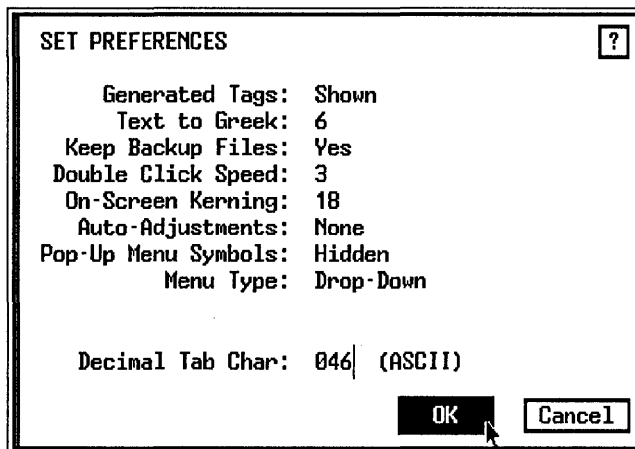

Ventura permits you to select the size at which to show kerning on the screen. In general, it is best to show on-screen kerning only for large type sizes or not at all. Otherwise, on-screen kerning slows down the display. And because of the

low resolution of computer screens, it is not effective or accurate at lower point sizes. In fact, don't be surprised if your monitor doesn't show any visible on-screen kerning. Because Ventura uses generic screen fonts, on-screen kerning is an approximation at best.

➔ *TIP: The only way to accurately gauge the effects of typographic adjustments is to print out the page.*

WARNING: Remember to reset On-Screen Kerning to None before you continue on to the next section.

About letter spacing

Ventura has another typographic control called Letter Spacing. To understand letter spacing, it is first necessary to understand how Ventura justifies text. Although the explanation below is not technically thorough, it will help you understand the letter spacing option. As it flows text onto the page, Ventura fits as many words as possible onto each line before moving to the next. If the words do not fit, Ventura adds or subtracts space between words, *but not between letters*. Ventura will not reduce the word space beyond the minimum or maximum word spacing values. Ventura has default maximum and minimum space widths, but you can change them in the Paragraph Typography dialog box (Figure 5-45).

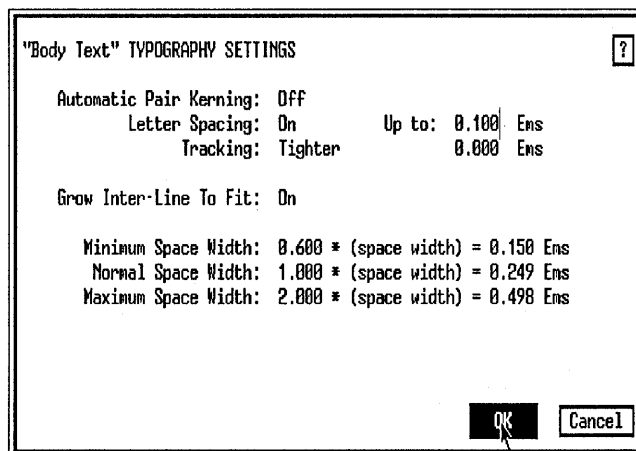

Figure 5-45.

Quite often Ventura cannot fit the words onto the line without exceeding the maximum or minimum values. In that case, it searches for the discretionary hyphens that were placed in the text file when it was loaded. If it can find a hyphenation point, Ventura will split a word, so part goes on one line and part goes on another.

Even with the help of hyphenation, Ventura still encounters some lines that cannot be justified without exceeding the maximum space width. These lines, which have too much white space between the words, are known as *loose lines*. You can instruct Ventura to highlight these lines by selecting Show Loose Lines from the Options menu.

There are several ways to reduce the number of loose lines:

- Manually hyphenate words (sometimes Ventura's hyphenation algorithm misses opportunities)
- Edit your text
- Allow Ventura to use its Letter Spacing feature to adjust the space between individual letters as well as the space between words

➔ *NOTE: Even if you fix the loose lines with letter spacing, Ventura will still highlight them on screen.*

Enter letter spacing

Let's use the letter spacing technique to fine tune the body copy. You will tell Ventura that it is allowed to add a small amount of space between letters if necessary to justify a line.

■ Enable Paragraph mode and select the Body Text paragraph in frame #8.

| | |
|--------------|--------------------|
| ■ Paragraph | Letter Spacing: On |
| ■ Typography | Up to: 0.100 Ems |

Experiment with fixing loose lines

As we mentioned above, letter spacing is just one of the ways you can avoid loose lines in body copy. If you are interested, you may want to take some time to experiment on your own to

further reduce the number of loose lines in the ad copy. Try adding a discretionary hyphen or two (place the text cursor where you want and press Ctrl-Hyphen), edit the text, or stretch one of the small frames. To continue practicing these adjustments, refer to Figure 5-46 for places to hyphenate text. Since this is for practice only, do not be concerned if your text is off a word or letter. The important thing is to understand that you have several powerful typographic tools at your command.

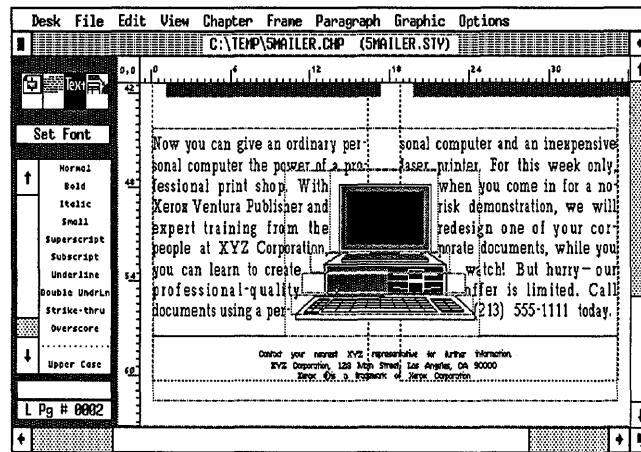

Figure 5-46.

Now that you've completed the ad, let's see the results of your efforts and print the chapter.

Chapter

Take a moment to save your work (press Ctrl-S). Then use the Print option to print out the entire document.

➡ **NOTE:** *Because of the size of the Encapsulated Postscript files, you should allow extra time for printing.*

■ **Select To Print** from the File menu. Choose **Which Pages:** All.

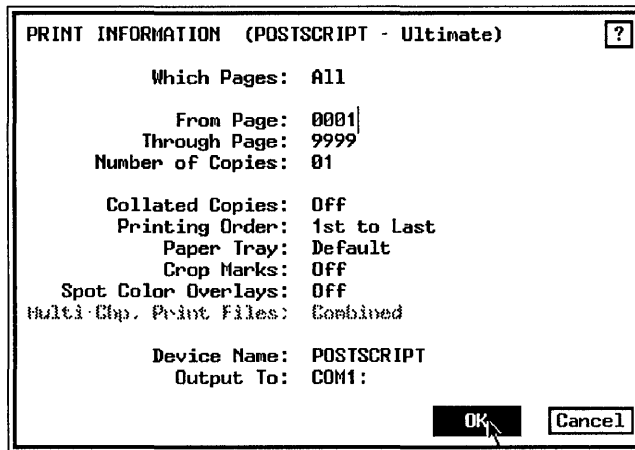

Print hidden pictures

If you customarily work with documents that use many pictures, you can save time printing a rough draft if you hide all the pictures in the document. When you hide pictures, Ventura prints out a gray box in place of the picture.

To hide pictures, choose Hide All Pictures from the Set Preferences dialog box (Options menu). When you print the document, Ventura first tells you that the document contains at least one hidden picture and then asks if you want to print all hidden pictures or keep them hidden. Choose Hide Them to hide the pictures.

➡ *TIP: You can also use Hide Pictures to decrease screen redraw time.*

Print to file

As you see from the final printed version of the advertisement, an Encapsulated Postscript file allows you to take a "snapshot" of a page and make it part of a document. If you have a PostScript printer, you can make your own EPS file by using the print option Print To File. Before we conclude this chapter, we'd like to show you how you to make an EPS file from the second page of this document.

■ Go to the second page (the advertisement itself).

➔ **NOTE:** You can only make an EPS file of one page at a time.

- Select Set Printer Info from the Options menu.

In this dialog box you can select which printer port (LPT1, COM1), to print a file to or you can choose to print to a filename.

- Choose Output To: Filename.

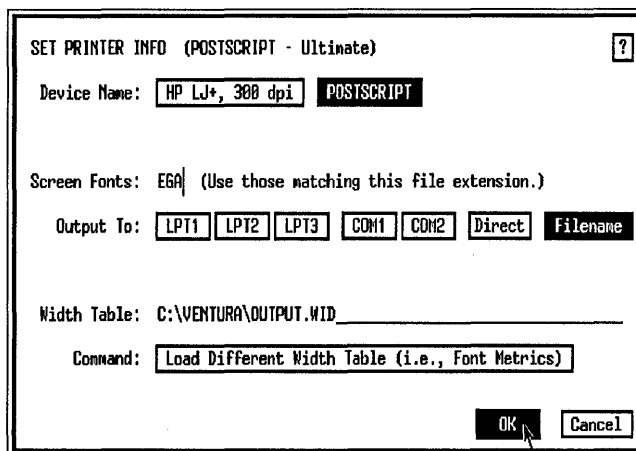

➔ **NOTE:** You may want to review Chapter Three for an explanation of the other printer options in this dialog box.

WARNING: Remember to use Set Printer Info to return the settings to the original output device (e.g. COM1, COM2) after you are finished making the EPS file.

- Select To Print from the File menu. Select Which Pages: Current and click OK.

Ventura displays the Item Selector, which asks you for the name of the print file.

- Move the cursor to the Directory line and replace the filename extension C00 with EPS.
- Locate the C:\TEMP subdirectory and type in the file name, 5MAILER.EPS on the Selection line. Click OK.

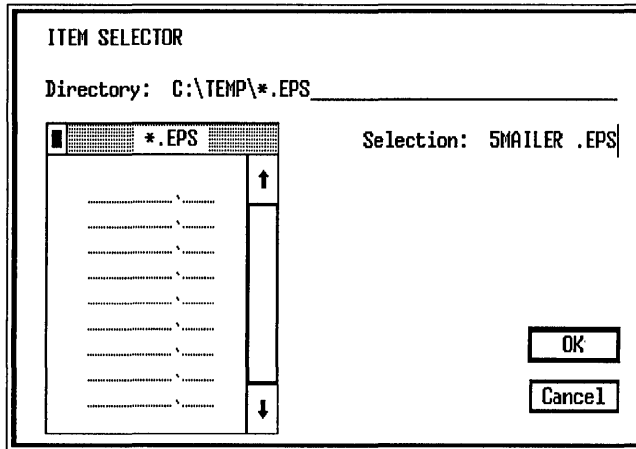

➔ *TIP: Always use the .EPS extension when printing to a filename.*

Ventura prints as normal, except the output goes to the file instead of to the printer. Once you create an EPS file, you can load it into a frame like any other picture.



Tips and techniques

Picture tips

- Use a stand-alone graphics program for complex illustrations. Ventura's built-in graphics tools are most useful for annotating existing drawings or producing very simple illustrations such as organization charts.
- Ventura does not store or modify outside graphics files. It stores a pointer to the file.
- If you revise a picture with an outside program and give it the same name as the old version, Ventura will load the new picture the next time you open the chapter.
- When sizing pictures with By Scale Factors, remember that the numbers shown in the dialog box represent the original size of the picture. To change the picture, enter the new values you want.
- When using By Scale Factors together with Aspect Ratio:

Maintain, Ventura lets you choose the width. Then it automatically calculates the necessary height to avoid distorting the aspect ratio.

- Scanned images look better if you leave them at their original size. If you must enlarge or reduce, do so in integer amounts.
- A positive X offset moves the picture to the left. A positive Y offset moves the picture up.
- Reset the zero point of the ruler for more accurate positioning of graphics elements.
- To create a text runaround, turn Flow Text Around to Off in the original frame. Then use smaller overlapping frames to keep the text away from the object inside the frame.

More Box Text tips

- Use the snap-to grid for easy, precise sizing and placement of Box Text.
- Once the first Box Text looks correct, use the Save To buttons in the Line and Fill Attributes dialog boxes. These buttons store the attribute settings. From then on, every Box Text you draw will have the same attributes.
- If you must position a Box Text with extreme accuracy, attach the upper left corner of the Box Text to the upper left corner of a small, invisible frame. Use Sizing & Scaling to position the frame. Since the Box Text is attached, it will move to the correct position too.
- If you must size a Box Text with extreme precision, first draw a frame of that size. Use Sizing & Scaling to verify the size. Then place the Box Text over the sizing frame. You can then delete the frame. Be careful to attach the Box Text where you really want it, and not to the sizing frame, which will be deleted.
- Use Send to Back and Bring to Front from the Graphic menu to force graphics shapes to overlap in the order you want them to.
- See Chapter Four for more tips on Box Text.

Other tips

- Always format the Chapter first, even when creating a free-form document. Use the Page as a guide to positioning page elements.
- Type non-keyboard characters by holding down the Alt key while typing the decimal code on the numeric keypad.
- To select a frame underneath another, hold down the Ctrl key and click the mouse button on the frame you want. Each time you press Ctrl-Click, Ventura selects the next layer down. Continue clicking until you see sizing buttons around the frame you want.
- To achieve automatic kerning, you must (1) turn it on globally using Chapter Typography from the Chapter menu and (2) turn it on for the individual tag using Paragraph Typography from the Paragraph menu.
- Use the Set Preferences dialog box from the Options menu to set On-Screen Kerning to None. Screen kerning slows down the display and is generally not very accurate.
- Enter additional discretionary hyphens on-screen with Ctrl-Hyphen.
- To keep Ventura from hyphenating a word, enter a discretionary hyphen immediately before the word.
- Enter additional discretionary hyphens permanently by adding the word to the user hyphenation dictionary. This dictionary is called HYPHUSER.DIC and is found in the Ventura subdirectory. Use the ASCII mode of your word processor to load the file. Then type in the words as you want them hyphenated.
- To permanently prevent Ventura from hyphenating a word (such as a product name), enter it into the user hyphenation dictionary without a hyphen.
- To create an EPS file, choose the PostScript printer and print the page to a file, using the Set Printer Info dialog box.

Chapter Six Skills Checklist

Theory

- The grid system
- Using frames to design a complex page layout

Text

- Converting file formats from different word processors
- Adding jump text
- Typing a pull quote

Style

- Adding editorial color to frames
- Improving display type with tracking and kerning
- Using pull quotes for spacing and graphic effect
- Adding style with big first characters (drop caps)
- Understanding chapter and frame typography
- Creating boldface lead-in heads
- Advanced effects with double and dashed rules

Pictures

- Building a calendar with Box Text
- Placing and sizing an image
- Adding captions to illustrations

Chapter

- Saving production time with chapter templates

A Three-Column Newsletter

Producing newsletters is one of the most popular desktop publishing applications. With Ventura and a laser printer, there is virtually no limit to what you can do. In Chapter Three you learned how to build a simple, two-column newsletter. In this chapter, you will tackle a second newsletter, a three-column format that shows off some of Ventura's advanced design capabilities. You will create this sophisticated layout using the skills and effects listed to the left. At the end of the chapter we will also explain two time-saving production tips that make newsletter production faster and easier.

Theory

The grid system

It is easiest and most efficient to build newsletters by pouring text into frames. The format of the Page determines the size and placement of those frames. For example, a two-column page presents two columnar alternatives: (1) frames that are one column wide or (2) frames that are two columns wide (Figure 6-1).

A three-column Page offers more alternatives. Frames can be one, two, or three columns wide (Figure 6-2).

As you can imagine, four- and five-column pages offer even more possibilities. However, more alternatives also mean more decisions. In general, four- and five-column grids are best left to those with graphic arts experience.

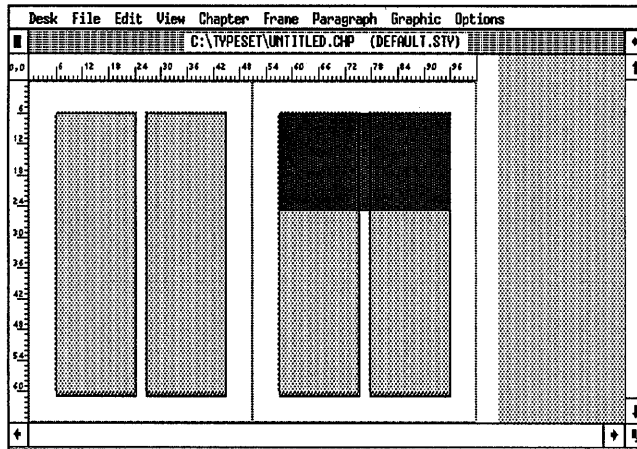

Figure 6-1. On a two-column page you can place frames that are one column or two columns wide.

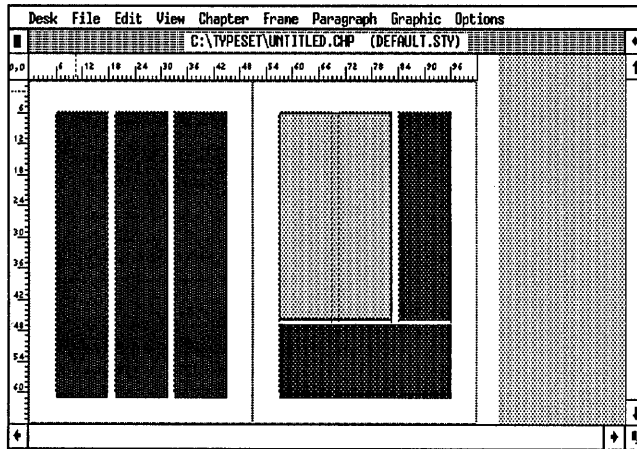

Figure 6-2. When you use a three-column grid, frames can be one, two, or three columns wide.

The three-column format is a good compromise (Figure 6-3). It is simple enough that production doesn't become too time-consuming. Yet it is also flexible enough to provide the variety and visual excitement lacking in one- and two-column formats. You can fit more text on the page with three columns than with one or two. And you have many more ways to present illustrations. In short, you can solve almost any layout problem within the framework of a three-column grid. For these reasons, it is the most popular newsletter style. You will learn it in this chapter.

VENTURA SCOOP

SEPTEMBER 1988, VOLUME 1, NO 9

Xerox introduces a new product
Will Ventura run on the Macintosh?
Xerox takes on Aldus in IBM market
Scanner produces 256 levels of gray

Xerox shows Ventura 1.1 at Spring conference

Xerox Corporation has introduced version 1.1 of its first electronic publishing software product that runs on industry standard personal computers. Conference attendees were impressed by the eighty-one new features, all of which were added without compromising the speed of the product and its depth of functionality. In addition, Xerox sponsored a second booth for third party developers who have created add-on products that work with Ventura. Over thirty companies displayed books, educational videos, hardware and software enhancements for Ventura.

The updated patch to the Xerox Desktop Publishing Software Series: Ventura Publisher Edition is available through Xerox authorized dealers and distributors (including ComputerLand, Microage, and Proxel), and the Xerox Business Software Center via (800) 823-8221, and the Xerox general line sales force. Commented one observer, "Xerox has always had a reputation of good quality service and after-support. We feel we can expect the same excellent technical back-up with the Ventura product line."

"As one of the pioneers in the field of electronic publishing, Xerox fully understands users' requirements for a desktop publishing software product," said James Brown, vice president, office systems. "There are some very exciting developments we can look forward to in the next two to three years. It is our intention to stay at the forefront of

Board approves Ventura purchase

President Davis M. Fulbright announced today his approval of a 12-month plan to install desktop publishing workstations in key departments throughout Aptex Post Typography. The announcement follows a three-month pilot study conducted by the Marketing Communications Department.

"We initially thought that desktop publishing would only have advantages for one or two departments," said President Fulbright, "but our study revealed that it could save time and money throughout the company while improving the appearance and effectiveness of our documents."

Several technological advances make the company-wide strategy feasible. First, Aptex was able to standardize on a single software program for all applications. Second, the selected software, Xerox Ventura Publisher, will

Ventura 1.1 takes on PageMaker in battle for IBM PC marketplace

MORGAN HILL (VT) — Xerox Ventura Publisher Edition version 1.1 has added new meaning to the term "Desktop Publishing." Before the introduction of Ventura Publisher Edition, desktop publishing referred primarily to advanced drawing packages that were extended to handle different text fonts.

These types of packages were characterized by a hand-intensive approach that attempted to mimic what graphic artists and typesetters were used to doing using the personal computer screen as an electronic paste-up board. While this approach was easy for artists to pick up, it did not result in much time-saving because the user was still faced with the

tediousness of hand-adjusting each piece of text on the page.

Fortunately, the software developers at Ventura Software Inc. recognized this and adopted a style sheet approach. In the same way that a spreadsheet defines the rules for a complex set of repetitive calculations, a Style Sheet defines the rules for complex layout. Once these rules are defined, non-typesetters can quickly achieve typesetter-quality results simply by applying or tagging each paragraph as a Headline, Sub-Head, etc. Style sheets give typeset results, and let professionals get the quality they expect from high-priced professional typesetting systems.

Continued on page 3

Figure 6-3 Three-column newsletters are one of the most versatile and popular design formats.

The danger of overdesign

As you venture into more complex layouts, beware of an affliction that strikes many first-time desktop publishers: Overdesignitis. This disease results in an overwhelming urge to cram as many fonts, rules, patterns, and other effects onto one page as possible.

Good page design doesn't call attention to itself. For instance, when readers pick up a business-oriented newsletter, you do not want their first reaction to be surprise, amazement or shock. Rather, you want the design to pull them into the page and entice them to start reading. Overdesign shouts. It says "Stop! Look at me first! See what I can do!" Proper page design, by contrast, talks in a quiet voice: "Come on in, make yourself comfortable, here's something you'll enjoy...."

So don't let Ventura's power lure you into the trap of over-design. Don't let your layouts become a barrier to communication. Yes, you want enough pizzazz so pages look pleasing and professional. But your main goal is to make it easier for busy readers to find information.

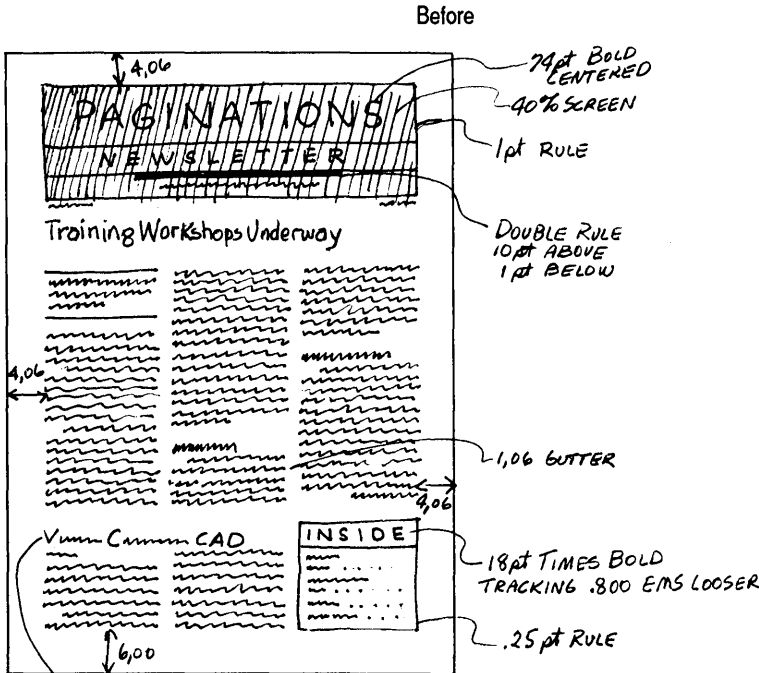

BANNER HEADLINE FRAME-WIDE
 24pt TIMES BOLD

After

PAGINATIONS NEWSLETTER

Volume 1, Number 1 Winter 1989

Training workshops underway

Ventura Publisher users may now enroll in training workshops.

Ventura Publisher workshops in basic and advanced skills begin this month. Licensed XT2 personnel may enroll by contacting Jim Belden of Marketing Communications at ext. 323.

Mr. Belden will conduct basic skills workshops four times this month. She has also scheduled two advanced sessions, one on computer graphics and the second on the production of long documents such as brochures and manuals.

"To allow for individual attention and practice, users Belden is fast sets out an intensive program," said Mr. Belden, who will likely conduct all the sessions himself. "The basic workshop begins with an overview of Ventura Publisher and its capabilities, plus an overview demonstration of the design of different documents that can be created with this software package." In the second half of the day-long workshop, attendees will practice on individual workstations. They will learn the basic Ventura skills necessary to load and format their own documents using a style sheet from XT2's growing library of professional designs. Mr. Belden said that other members of the Marketing Communications Department would be invited to give the workshops and provide support to users as demand increases.

Basic Workshop

Attendees at the basic workshops will receive a training guide and a reference book. The training guide and its accompanying software disk are used in the book for the hands-on exercises that make up the second half of the workshop. It can also be used for self-paced advanced self-study after the workshop.

The reference book provides a more complete explanation of Ventura's features and offers insights into the best methods of operation.

Advanced Seminars

The advanced seminars will focus on specific skills necessary for the completion of specific documents types. In addition to teaching advanced Ventura techniques, attendees will also be taught graphic arts skills. They will receive a manual on design, plus tips on production techniques, including the preparation of so-called camera-ready art—pages that are ready to be taken to an offset printer or to a photocopier. These photographs are made into printing plates, and the documents can then be reproduced via offset lithography.

Mr. Belden believes that desktop publishing with Ventura Publisher will

SEE WORKSHOP next page

Ventura complements CAD

by Joe Raposo

Now Ventura Publisher is proving to be a perfect complement to the computer-aided design and drafting program already in use by the Engineering Department.

Since Ventura Publisher can accept graphics files in AutoCAD's standard

AutoCAD drawings is technical documents and manuals. The Engineering Department has been an enthusiastic user of AutoCAD, the leading CAD program, for more than two years. In 2D and 3D capabilities make it the product for CAD page 7

| INSIDE | |
|-------------------------|---|
| Training workshops | 1 |
| Ventura complements CAD | 1 |
| News items | 2 |
| Tip of the month | 3 |

Planning the newsletter

The first thing you see on the front page of a newsletter is the logo or nameplate. The logo draws attention to the page and identifies the publication. Most newsletters need a carefully thought-out logo design because it sets the tone for the rest of the publication. For instance, as you proceed through this chapter, you will see how several effects from the logo are repeated elsewhere. Newsletters benefit from a design theme that is repeated throughout. This consistency improves the look while helping readers identify different parts of the publication.

The headlines are sized in proportion to the logo and to each other. This hierarchy — the bigger the story the bigger the headline — helps the reader judge which information is most important.

Since this newsletter will be mailed, the back page includes space for a label and a stamp. Depending on the amount of editorial space you need, you can allocate a full, half, or fraction of a page to mailing information.

As you create layouts of your own, you will discover that Ventura contains lots of built-in power you can put to work in your newsletters. Here are some of the effects you will learn to use to add character and punch to your newsletter designs.

- Three-column format
- Frame backgrounds
- Custom and double rules
- Big first character
- Boldface lead-ins
- Box Text for a calendar of events

Even though this newsletter is more a complex layout than the one from Chapter Three, *the same basic principles apply*. First you will format the Page. Next you will place frames using the Page as your guide. Then you will put text into the frames.

Ventura prep

Verify that the settings from the Options menu are the way you want them. In particular, be sure that Column and Line Snap are turned on so frames automatically snap to the Page. Choosing Show Column Guides also makes it easier to position frames.



If you have the Power disk

Instead of building the newsletter chapter from scratch, you will use the sample newsletter chapter from the Power disk. The chapter file contains the newsletter style sheet and most of the frames for the newsletter text.

- Open the chapter C:\POWER\6NEWSLET.CHP.
- Load the ASCII text files 6NEWSLT1.TXT, 6NEWSLT2.TXT, 6NEWSLT3.TXT, 6NEWSLT4.TXT, 6NEWSLT5.TXT, and 6NEWSTOC.TXT from the C:\POWER subdirectory.
- Use Save As New Style to save the style sheet as C:\TEMP\6NEWS.STY
- Load the image file, WPVP.IMG (GEM/HALO DPE format) from the C:\POWER subdirectory.

➡ *NOTE: If Ventura automatically places the image on the Page, use Remove Text/File to remove the image from the frame (do not remove it from the list of files).*

Before you place the text files, we want to show you how to convert text files from one word processing format to another.

Converting file formats

If you publish a newsletter composed of articles from several writers, you are likely to receive files in different formats. Ventura can convert from one file format to another. After loading a text file you can use File Type/Rename from the Edit menu to convert it to a different word processing format. Thanks to File Type/Rename you can standardize the text

format of the newsletter without restricting writers to any one word processor.

For practice, convert the six ASCII text files you just loaded into your favorite word processing format (at the same time you rename them).

Change formats

Follow these instructions for each of the six files in turn. First, place the text file on the Page. Then call up the File Type/Rename dialog box. Type in the new name (and new location) and choose the new file format. As always, you will be placing the new file in the \TEMP subdirectory along with the projects from other chapters. Figure 6-4 shows how it would look if you were changing 6NEWSLT1.TXT to Microsoft Word format:

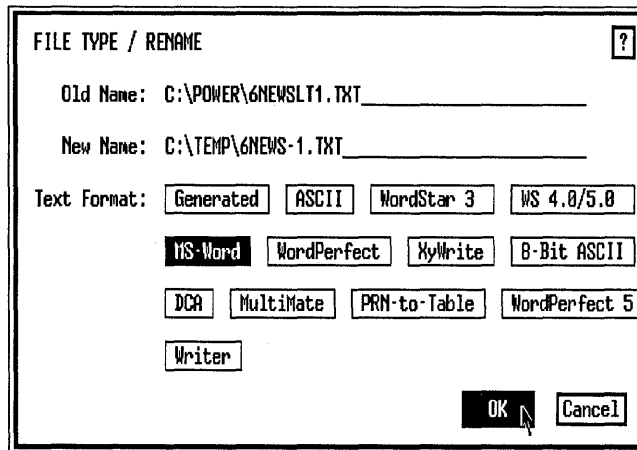

Figure 6-4.

If you were changing to MultiMate format, the dialog box would look identical except that the MultiMate button would be highlighted instead.

When you have finished, put the next file on the Page and repeat the process.

➡ **NOTE:** When you place a new file on the Page, Ventura automatically replaces the old file with the new one.

Here's a listing of the new file names (you can change the extension to your own word processing format if you prefer):

| Load from C:\POWER | Save to C:\TEMP |
|---------------------------|------------------------|
| 6NEWSLT1.TXT | 6NEWS-1.TXT |
| 6NEWSLT2.TXT | 6NEWS-2.TXT |
| 6NEWSLT3.TXT | 6NEWS-3.TXT |
| 6NEWSLT4.TXT | 6NEWS-4.TXT |
| 6NEWSLT5.TXT | 6NEWS-5.TXT |
| 6NEWSTOC.TXT | 6TOC.TXT |

WARNING: Neither the format change or the name change/relocation takes effect until you save the chapter.

Using File Type/Rename merely tells Ventura, "Please make these changes the next time you save to the disk." If you abandon the chapter without saving you will lose the changes.

- After you rename all the text files, use Remove Text/File to remove the last file from the frame.
- Select Save As to save the chapter as C:\TEMP\6NEWS.CHP.



If you do not have the Power disk

- Using your favorite word processor, type the text files for Chapter Six from Appendix A. Save them under the C:\TEMP subdirectory using the names listed in the right column in the table above.
- Load the original Ventura style sheet &NEWS-P3.STY from the C:\POWER subdirectory. Change the margins and columns to match Figure 6-5. Change or add tags according to the tag table for Chapter Six in Appendix B. Save and rename the style sheet as C:\TEMP\6NEWS.STY.

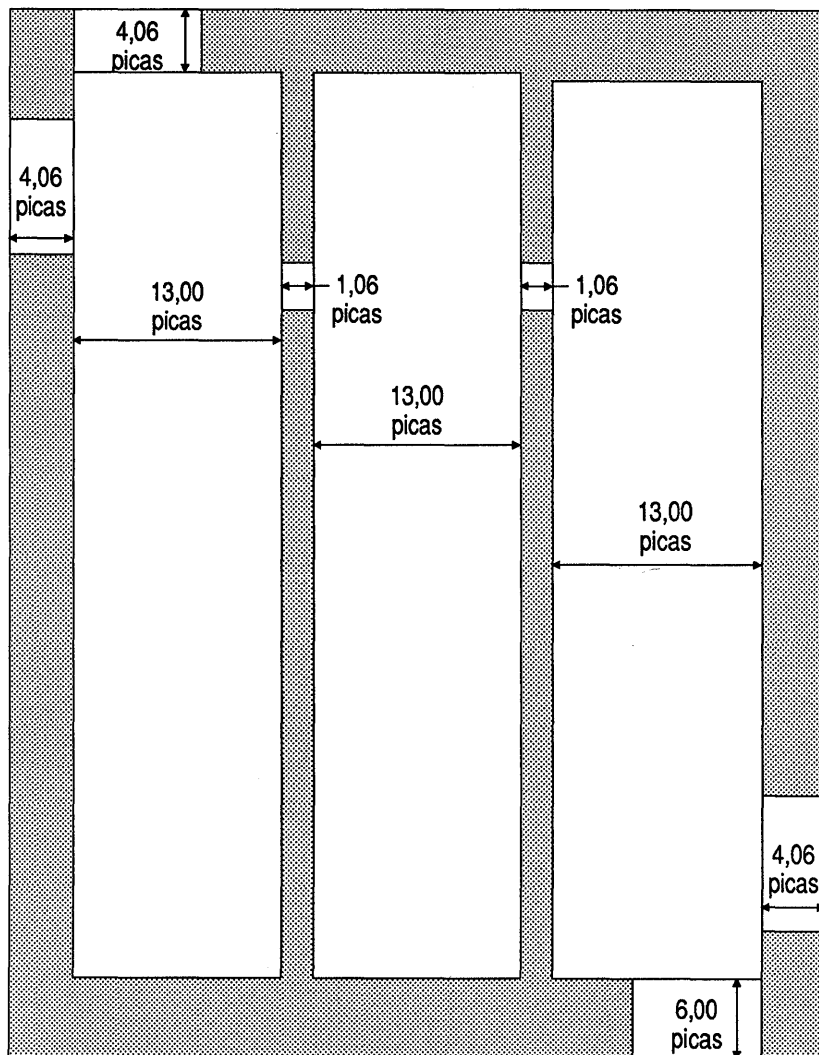

Figure 6-5.

- Load the sample image file, CHANEL.IMG from the C:\POWER subdirectory or substitute your own bit-mapped image in place of the one provided on the Power disk.

Style

Since the newsletter is composed of text files in frames, it is easier to add frames before placing text. Start by formatting the Page, then use it as a guide for drawing the frames.

Verify the page layout

Although the 6NEWS.STY style sheet should have the correct values for page layout, margins, columns, and global kerning, verify that the values match Figure 6-5.

Add a footer

- Select Headers & Footers from the Chapter menu. Choose Define: Right Page Footer, Usage: On. Type: **Fall/Winter 1989** on the Left line and **Page [P#]** on the Right line.

- Choose Define: Left Page Footer, Usage: On. Type: **Page [P#]** on the Left line and **Paginations** on the Right line.
- Choose Turn Footer Off from the Chapter menu for the first page of the newsletter.

Change the chapter typography

Now you will change the settings in the Chapter Typography dialog box to complete the chapter format. (See Chapter Three for a detailed explanation of these settings.)

- Select Chapter Typography from the Chapter menu.
- Choose Widows (Min. Lines at Top): 1 and Orphans (Min. Lines at Bottom): 1.
- Choose Move Down to 1st Baseline By: Inter-Line.
- Verify that Column Balance is off.

Chapter Typography settings ensure that the text will align across multiple columns and reach the bottoms of the frames.

Add frames to page one

- Place nine frames on page one using Figure 6–7 as a guide for their size and position.
- Use Sizing & Scaling to fine-tune the size and placement.

Don't forget that you can use temporary memory to create identical frames. See Chapters Two and Three.

➔ *NOTE: With Line Snap turned on, the frames (frames #6 and #7) at the bottom of the page will extend below the column guide. Nevertheless, the text you pour into the frames will line up properly with the bottom of the column guide.*

Place the two “jump text” frames (frames #8 and #9) *inside* the column frames as shown in Figure 6–6. (Shading in the figure is for illustration purposes only. Do not add shading.)

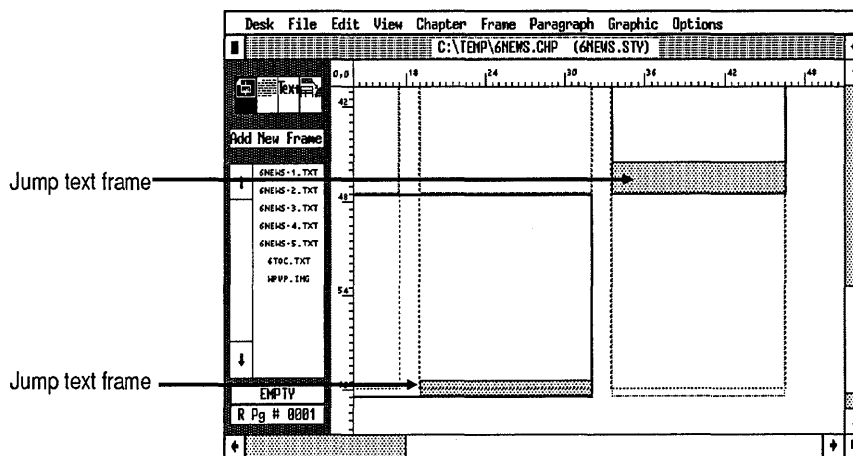

Figure 6–6.

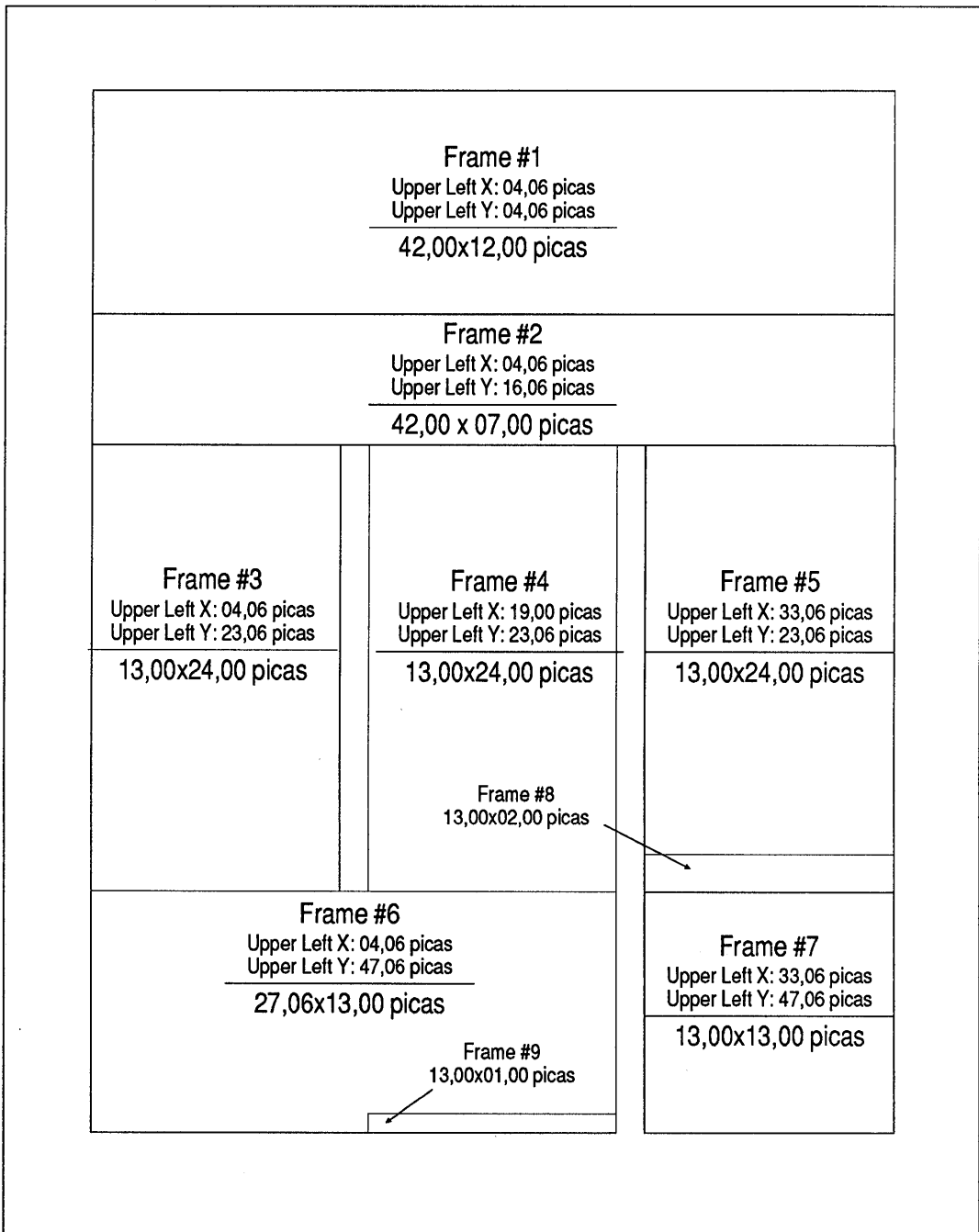

Figure 6-7. Use this illustration to draw the frames on page one.

Add a ruling box around

When you are finished adding the frames, you will make a ruling box around the frame reserved for the logo.

- Select the top frame (frame #1).
- Ruling Box Width: Frame
 Around Height of Rule 1: 00.25 fractional pts

Add a pattern

To add interest to the page design, put a gray fill pattern inside the Logo frame (frame #1).

- Select Frame Background from the Frame menu. Choose Color: Black and Pattern: 1. Click OK.

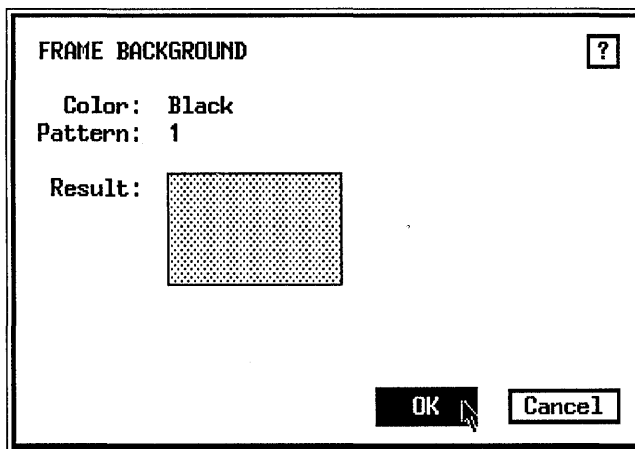

Change columns

Use Margins & Columns from the Frame menu to change the bottom left frame (frame #6) to a two-column format. The size of the columns inside this frame will match the columns on the Page.

- Select frame #6.

- Margins & Columns # of Columns: 2
Column 1: 13,00 picas & points
Column 2: 13,00 picas & points
Gutter 1: 01,06 picas & points

Add a ruling box around the TOC

- Select the frame that will contain the TOC (frame #7).
- Ruling Box Around Width: Frame
Height of Rule 1: 00.25 fractional pts



Add frames on page two

If you are using the Power disk, proceed directly to the section entitled, "Add a dashed ruling line."

If you do not have the Power disk and the sample newsletter chapter file, use Figures 6-8, 6-9, and 6-10 as guides to lay out the remaining frames on pages two, three, and four.

- Insert/Remove Page Operation: Insert New Page After Current Page

Use Figure 6–8 to guide the placement of frames on page two. Then check for accuracy with Sizing & Scaling.

Add margins and a ruling box around

If you do not have the Power disk, you will add margins and a ruling box around the frame reserved for the staff box (frame #12). Start by adding margins to the frame. This keeps the text in the frame from touching the ruling box around it.

- Select the frame for the staff box (frame #12).
- Margins & Columns Top: 02,00 picas & points
Bottom: 02,00 picas & points
Left: 01,00 picas & points
Right: 01,00 picas & points
- Select Ruling Box Around. Choose Width: Frame. Give Rule 1 a height of 00.25 fractional pts.

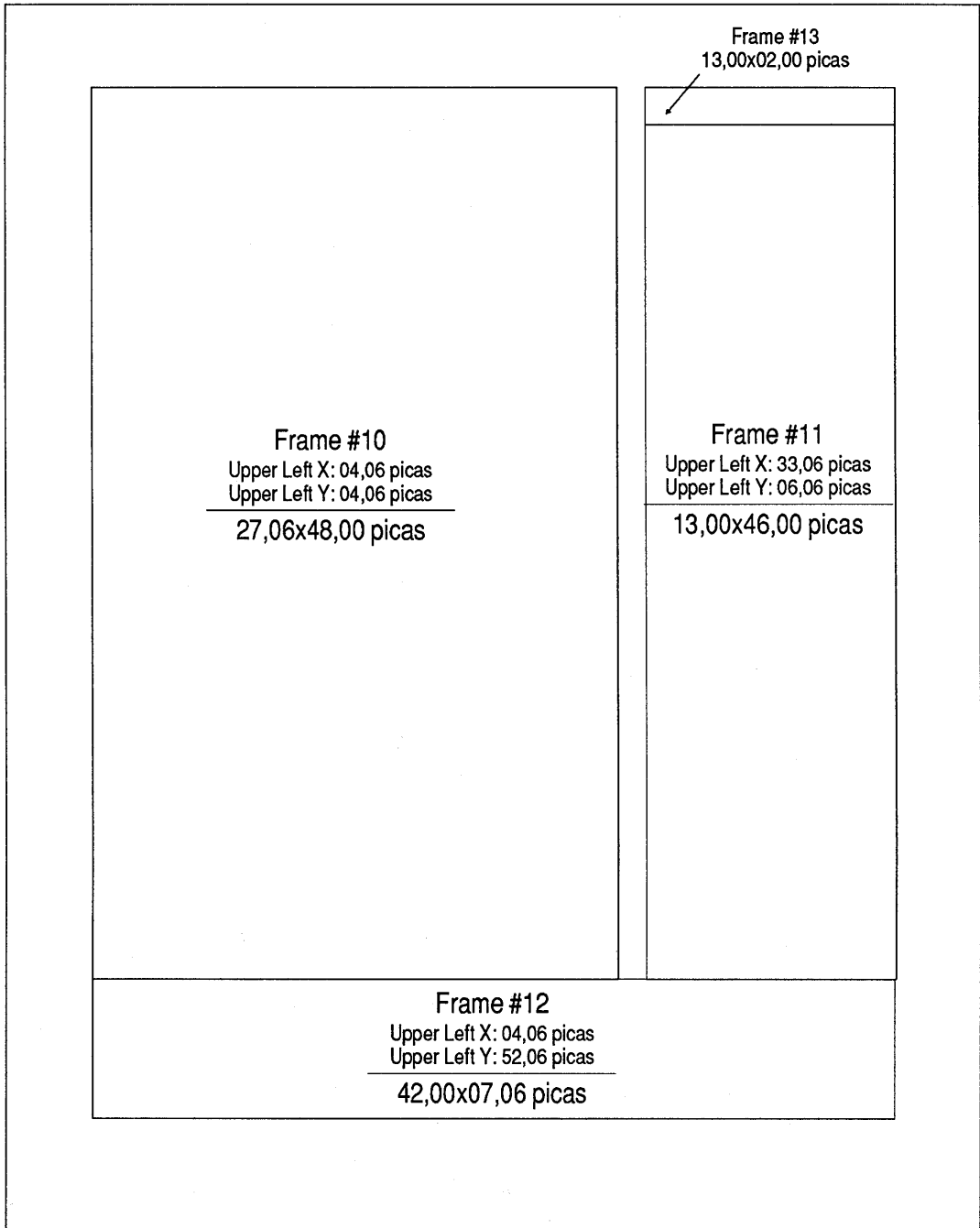
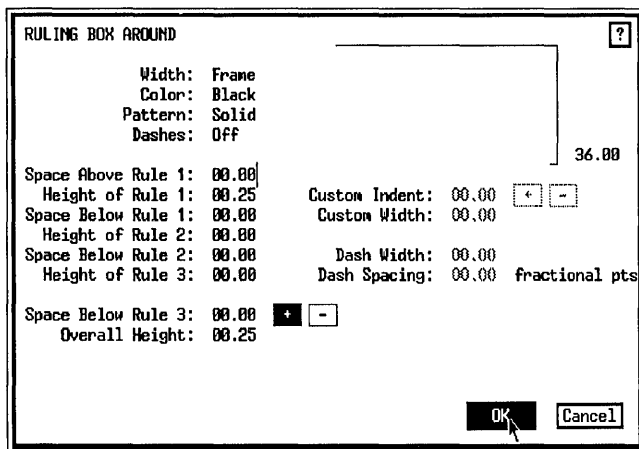

Figure 6-8. If you do NOT have the Power disk, you must draw these frames on page two.



On to page three

Good work — you're halfway through placing the frames (If you have the Power disk, these frames were drawn for you). Two more pages to go. Insert another page before drawing the frames on page three.

- Insert/Remove Page Operation: Insert a New Page After Current Page

Add frames to page three

Using the Figure 6–9 as a guide, draw the five frames on page three, then check your results with Sizing & Scaling. The upper right frame (frame #18) is reserved for a picture and a caption. You will add a caption to the picture frame in the picture section of the chapter. For now, simply leave enough space for the caption.

Add a ruling box around the picture frame

To visually separate the picture from the rest of the text, add a ruling box around the frame that will contain it.

- Select the frame that will contain the picture (frame #18).
- Ruling Box Around Height of Rule 1: 00.25 fractional pts

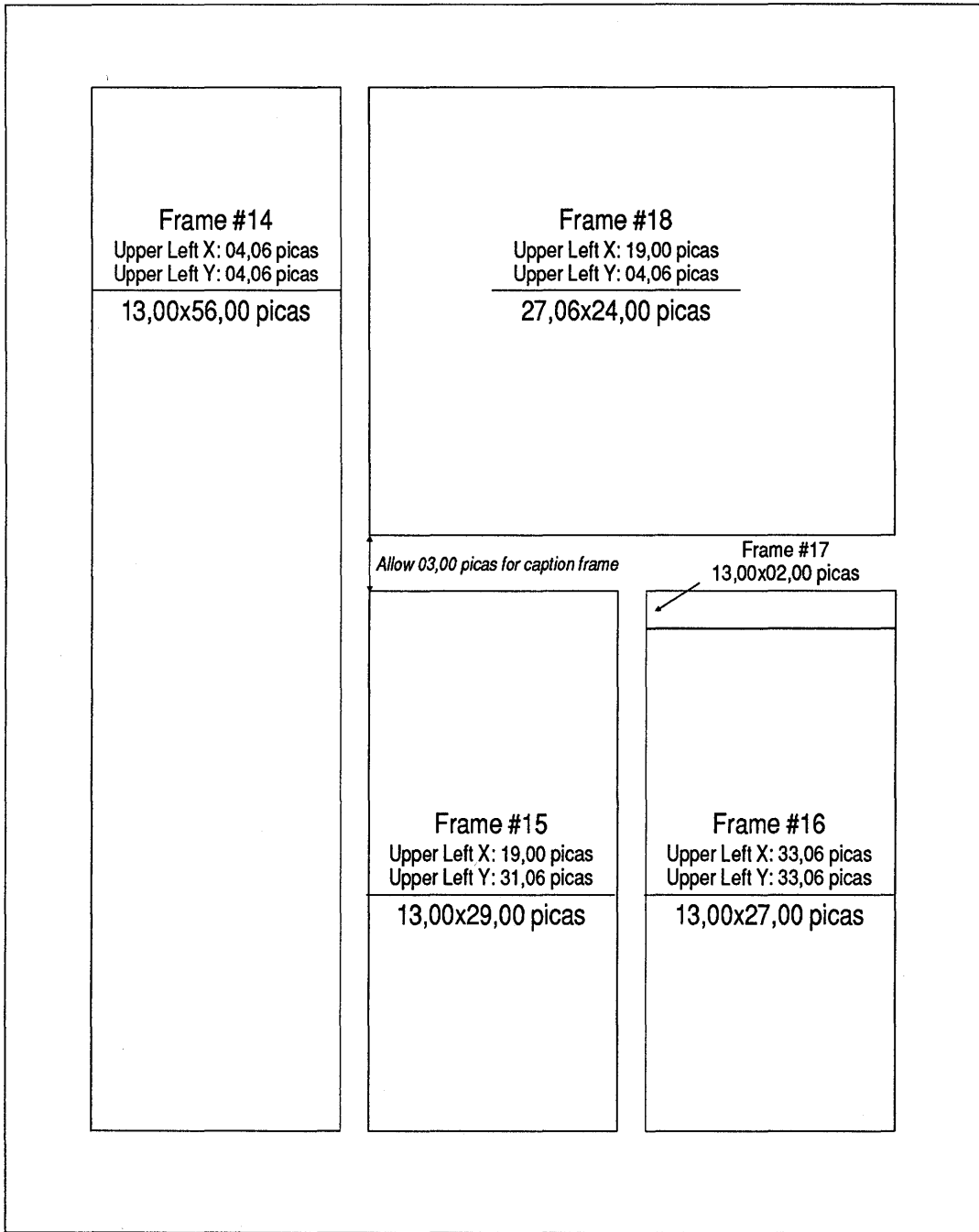

Figure 6-9. If you do NOT have the Power disk, draw these frames on page three.

Insert page four

■ Insert/Remove
Page

Operation: Insert a New Page
After Current Page

Add frames to page four

Add the two frames shown in Figure 6-10.

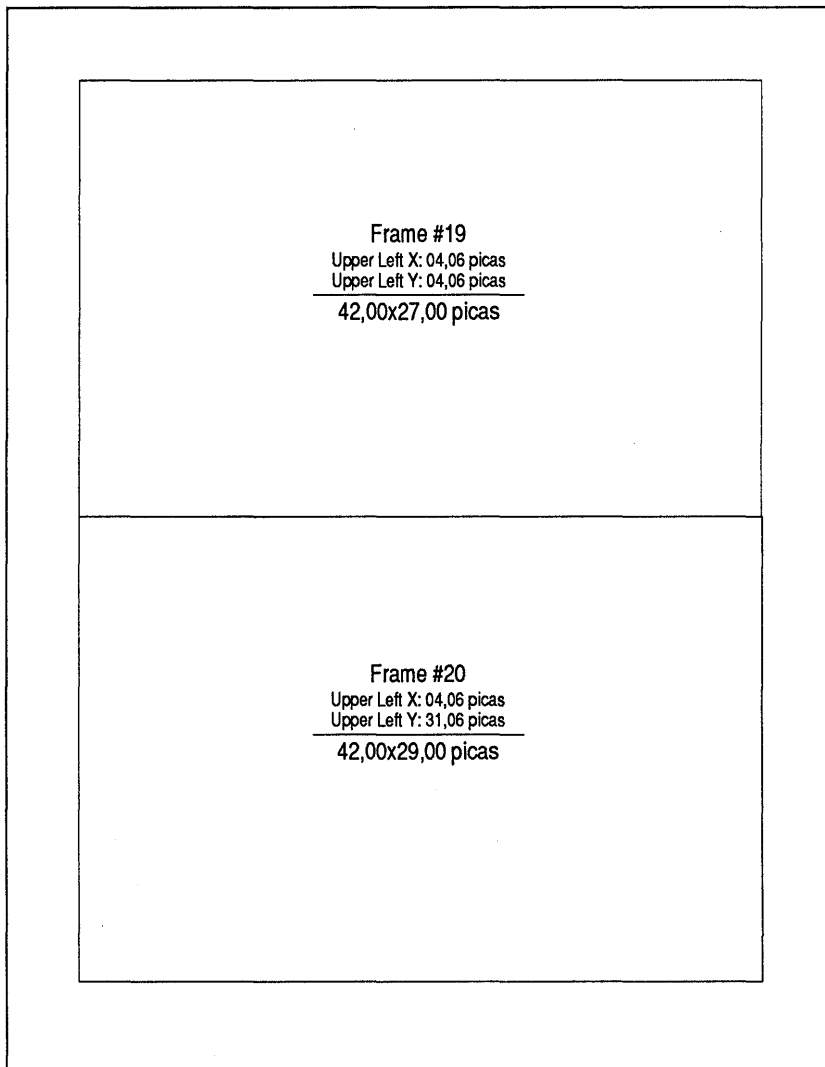
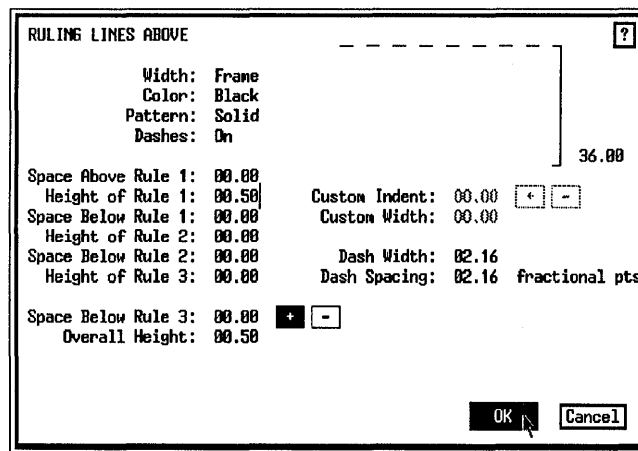

Figure 6-10. If you do NOT have the Power disk, draw these frames on page four.

Add a dashed ruling line above

To create a fold line, you will add a dashed rule above the bottom frame on page four.

- Go to page four.
- Select Go To Page from the Chapter menu (or press Ctrl-G). Move to the Selected Page line and enter 0004
- Select the bottom frame (frame #20).
- Select Ruling Line Above. Choose Width: Frame, Dashes: On. Make the Dash Width: 02.16 fractional pts and the Dash Spacing: 02.16 fractional pts. Give Rule 1 a height of 00.50 fractional pts.



Place text files

Now that the frames are completed, you are ready to place the text. Start with the two articles on page one.

- Press Home to go to page one.
- Select frame #3.
- Select 6NEWS-1.TXT from the Assignment List.

Ventura pours as much of the text file it can fit in the frame and then stops.

➔ **NOTE:** Most of the sample text files have been pretagged. Ventura will automatically format these paragraphs as you place the text.

Finish placing the first article.

- Select frame #4 then select 6NEWS-1.TXT from the Assignment List.
- Select frame #5 then select 6NEWS-1.TXT from the Assignment List.

You will place the rest of 6NEWS-1.TXT when you get to page two. For now, continue working on page one. Place the article "Ventura Complements CAD" (6NEWS2.TXT).

- Select frame #6 and place the text file 6NEWS-2.TXT.

Ventura flows the text in the two columns and stops when it reaches the end of the second frame (Figure 6-11). You will place the remaining text when you get to page three.

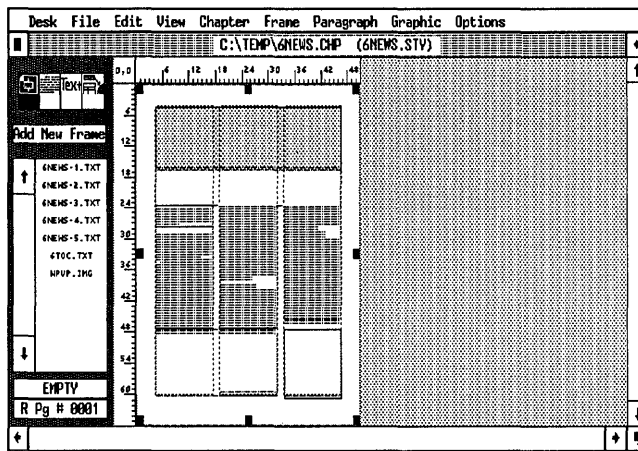

Figure 6-11.

- Select frame #7 and place the text file 6TOC.TXT.

➔ **TIP:** You do not have to place all of a file at once. Ventura will "remember" where you left off when you get to the next page. Generally, the most efficient way to work is to do everything you can on one page before moving on to the next.

After placing the last text file, take a moment to compare your first page to Figure 6-12. Your newsletter is now starting to shape up.

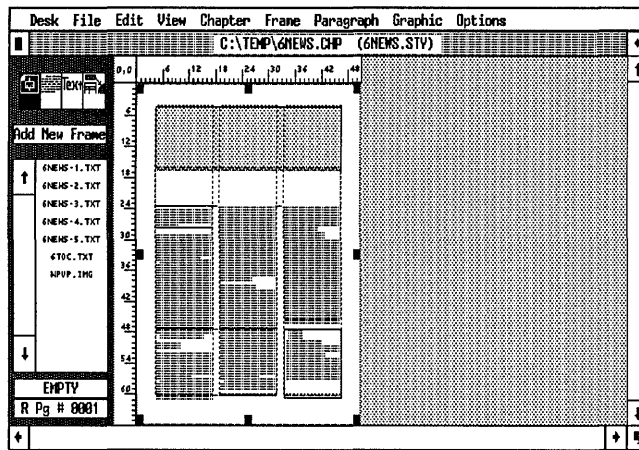

Figure 6-12. The first page so far.

Add logo text on page one

To complete the text on page one, add the logo, headline, dateline, and jump text to the proper frames. Change to Normal or Enlarged View (your choice) so you can see the text as you type.

- Enable Text mode.
- Click anywhere in the logo frame (frame #1) and type the following three paragraphs:

PAGINATIONS [Enter]

NEWSLETTER [Enter]

Design and Production News for Ventura Publishers

Add dateline and headline

- Click anywhere in frame #2 and type the next two paragraphs:

Volume 1, Number 1 [Tab] Winter 1989 [Enter]

Training workshops underway

The text in the first two frames should look like the sample screen in Figure 6–13.

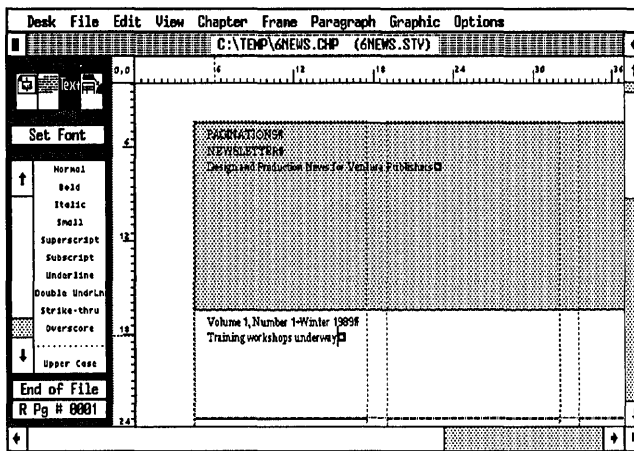

Figure 6–13.

Add jump text

- Click once inside the small frame (frame #8) above the Table of Contents and type: (Figure 6–14)

See WORKSHOP next page

- Click anywhere in the small frame at the bottom of the page (frame #9) and type: (Figure 6–14)

See CAD page 3

➡ **NOTE:** *If you do not see the end of file marker after clicking on the frame, make the jump text frame larger. Later, you can resize the frame so it measures 01,00 pica high. The logo, headline, and jump text will be stored as part of the chapter's caption file.*

If you wish to place this text into separate files, switch to Frame mode. Select the frame containing the text you want to put in a separate file. Select File Type/Rename from the Edit menu. Ignore the name you see listed as Old Name. Clear the New Name line and type in the new name and location. Then click OK.

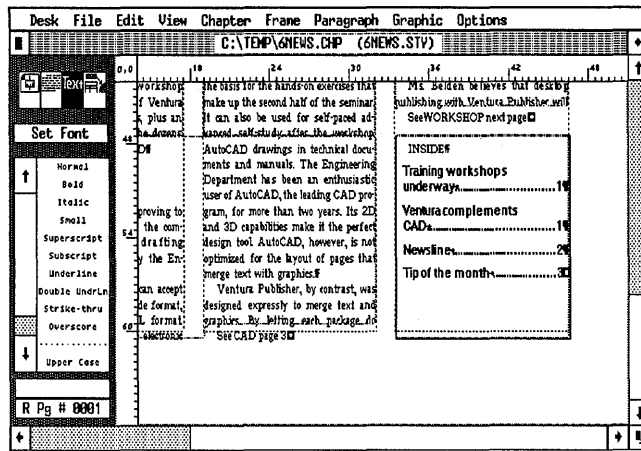

Figure 6-14.

Place text on page two

■ Press PgDn to go to page two and enable Frame mode.

■ Select frame #10 and place the text file 6NEWS-3.TXT.

Now continue the article from page one in frame #11 and put a new article into frame #12.

■ Select frame #11 and place the text file 6NEWS-1.TXT.

■ Select frame #12 and place the text file 6NEWS-4.TXT.

Upon finishing, your page will look similar to Figure 6-15:

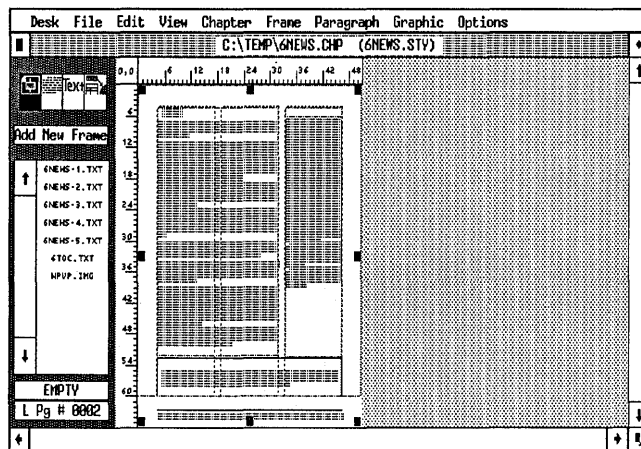

Figure 6-15. Page two as it should appear at this stage.

Notice that the text does not completely fill frame #11. What do you do with the empty space? You could type in additional text. Or you could add something to take up space, like an illustration or a *pull quote* (sometimes called a *lift out*).

Add a pull quote

A pull quote is a short quotation or extract that can be used as a graphic element to fill space and to attract attention to an article.

To create the pull quote, you will add a small frame inside the existing frame (frame #11). To set it apart from the rest of the text add vertical padding and rules to the frame. The style of the rules is derived from the graphic look of the logo. After you add the frame, you will type in the pull quote text.

- While still in Frame mode, select Add New Frame from the Side-Bar.
- Make sure that the zero point is set to its original position at the upper left corner of the Page (click the 0,0 square in the upper left corner of the Page).
- Starting at position 19,06 picas on the vertical ruler, draw a frame 13,00 picas wide by 09,00 picas high inside frame #11 as shown in Figure 6-16. You can check for accuracy with the Sizing & Scaling dialog box.

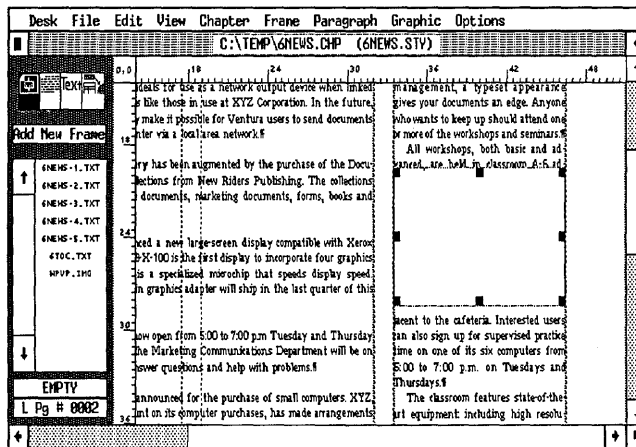
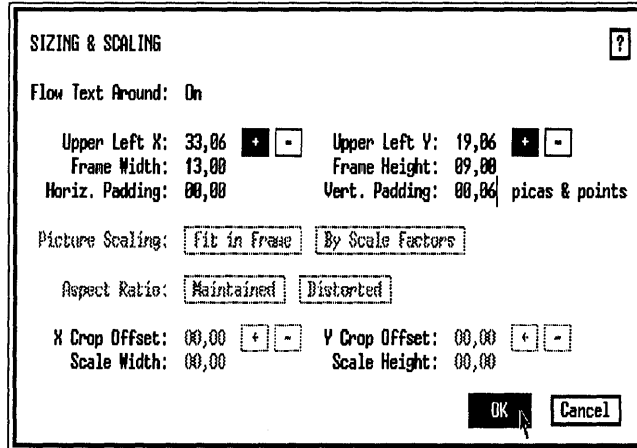

Figure 6-16.

Add padding

Add vertical padding to keep the text from butting up against the pull quote frame.

- With the frame still highlighted, select Sizing & Scaling from the Frame Menu. Make the vertical padding 00,06 picas & points.



You have just added padding of 06.00 fractional pts above (00,06 picas & points) and 06.00 fractional pts below the frame — a total of 12.00 fractional pts which is equal to the inter-line spacing of the Body Text. By making the frame padding an integer of the Body Text inter-line spacing, you maintain even spacing throughout the document.

Add ruling lines to the pull quote frame

With the frame still highlighted:

- Ruling Line Above Width: Frame Height of Rule 1: 00.25 fractional pts
- Ruling Line Below Width: Frame Height of Rule 1: 00.25 fractional pts

Add the pull quote text

- Enable Text mode. Click anywhere inside the pull quote frame. Type the following pull quote text using non-keyboard characters to create the quote marks. (For example, [Alt-169] means “type 169 on the numeric keypad while holding down the Alt key.” This procedure creates an open quote mark when you release the Alt key.) (Figure 6–17.)

[Alt-169]Anyone who wants to make an impression on paper should attend a Ventura training workshop. [Alt-170]

- ➔ *TIP: You can also enter open and close quotes with Ventura's built-in keyboard shortcuts, Ctrl-Shift-[(open bracket) and Ctrl-Shift-] (closed bracket).*

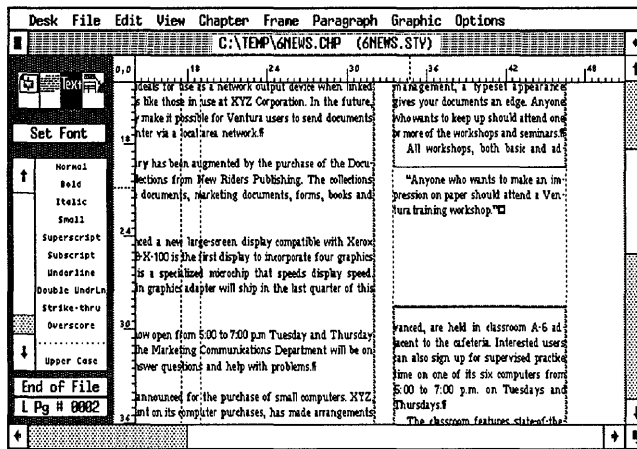

Figure 6–17.

Add jump text

Next type in the jump text at the top of the right-hand column and change its attributes.

- While still in Text mode, click anywhere inside the small frame at the top of the right-hand column (frame #13) and type: **WORKSHOP from page 1**

- Select the word “WORKSHOP” and change its attributes. Highlight the word and choose Bold. Then choose Italic from the Assignment List (Figure 6–18).

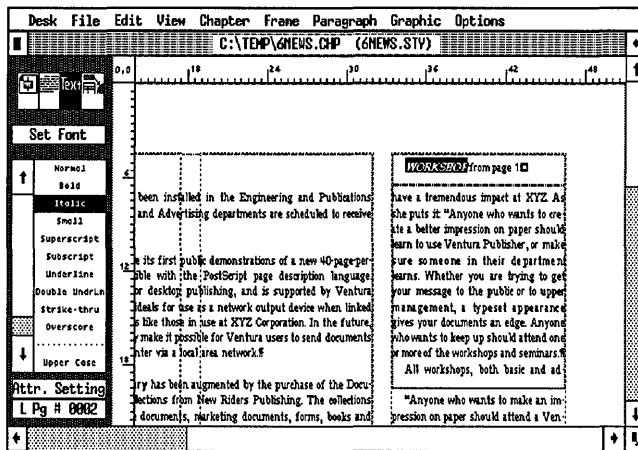

Figure 6–18.

Create boldface lead-in heads

In addition to using headings on a separate line, you can also draw the reader’s attention to an article with lead-in heads. Lead-in heads use boldface, italic, or small capitals for the first few words of a paragraph. To create the boldface lead-in heads in frame #10, highlight the text (by dragging or the Shift-Click method), then choose Bold from the Assignment List.

- Make sure you are still in Text mode.
- Select the two following phrases in the first two paragraphs in frame #10 and make them bold:
 - “Ventura Workstations...”
 - “Digital Laser Corporation...”

➔ **NOTE:** If you accidentally click your text cursor on the Underlying Page instead of in the desired frame, Ventura asks you if you intend to type text on an empty page. Choose Cancel to remove the message.

The rest of the lead-in heads have been completed for you. When you are finished the page should look like Figure 6–19:

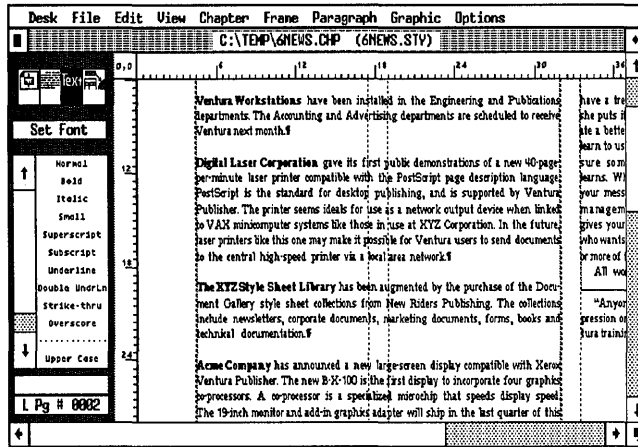

Figure 6–19. Check your progress against this illustration.

Place text on page three

■ Press PgDn to go to page three.

Now you will place the article “Preformatting Ventura Documents” in frame #14 and frame #15 and the rest of the article “Ventura Complements CAD” in frame #16 as explained below.

■ Enable Frame mode.

■ Select frame #14 and place 6NEWS-5.TXT.

■ Select frame #15 and place the rest of 6NEWS-5.TXT.

■ Select frame #16 and place the rest of 6NEWS-2.TXT.

Your page should look like Figure 6–20:

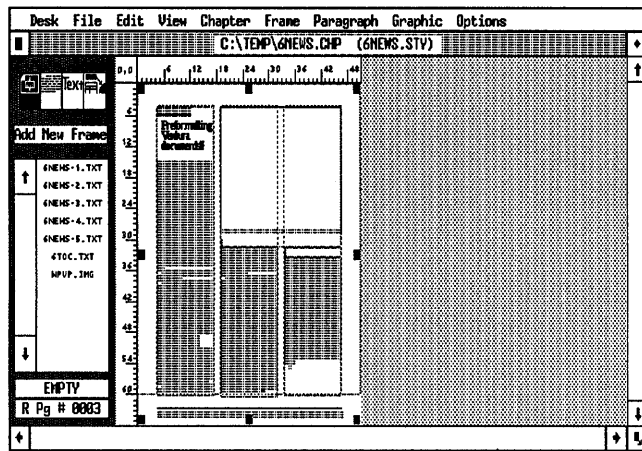

Figure 6-20. At this stage, your page should look like this.

Add jump text

- Enable Text mode. Click anywhere inside the small frame above the right-hand column (frame #17). Then type:

CAD from page 1

- Select the word “CAD.” Choose Bold, then Italic from the Assignment List (Figure 6-21).

➔ *NOTE: If you select the wrong attribute from the Assignment List, choose Normal to return the text to its original format. Then reselect another attribute.*

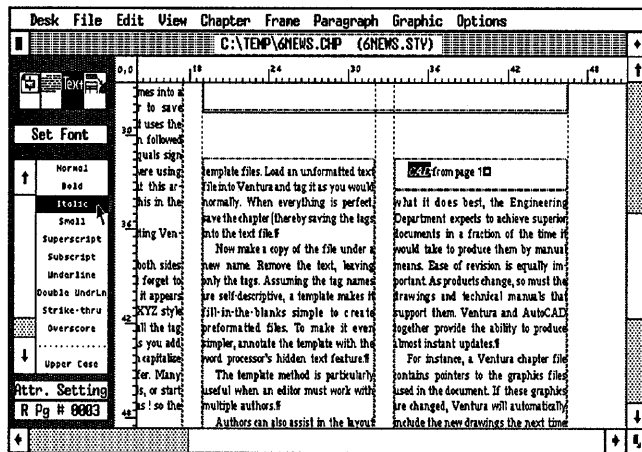

Figure 6-21.

Add text to page four

You're almost done with the text on page four.

Use Text mode to create the address panel on page four.

- Press PgDn or End to go to page four.
- Click anywhere in the bottom frame on page four (frame #20) and type the following address (use Ctrl-Enter to create a line break):

**New Riders Publishing [Ctrl-Enter]
31125 Via Colinas, Unit 902 [Ctrl-Enter]
West Lake Village, CA 91362 [Enter]**

- Start a new paragraph for the postage text and type:

**Bulk Rate [Ctrl-Enter]
US Postage [Ctrl-Enter]
PAID [Ctrl-Enter]
LOS ANGELES, CA [Ctrl-Enter]
PERMIT # XXXX**

- Select the text "PAID, LOS ANGELES, CA, PERMIT # XXXX" and make it Bold.
- Now select the text "LOS ANGELES, CA PERMIT # XXXX" and make it Small.

When you are finished, check that your page looks similar to Figure 6-22.

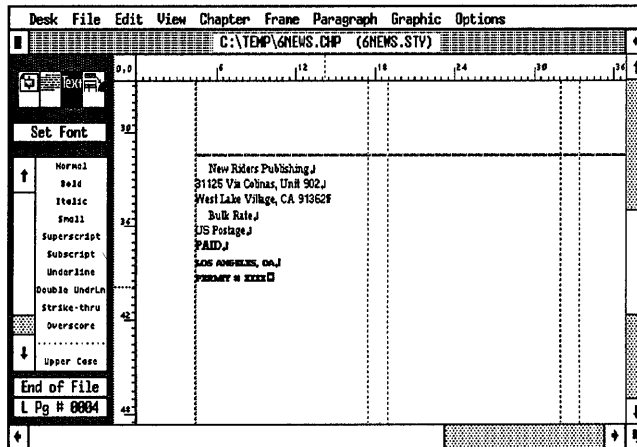

Figure 6-22. At this point, your page four should look similar to this illustration.



Stopping point

This is a good point to stop, take a break and save your work (press Ctrl-S). You've already done a lot of work, so we should probably remind you the first time through a newsletter is always the hardest. Make no mistake — it takes a substantial effort to produce a newsletter the first time around. But don't become discouraged. Once you've set up your pages and finished the first issue, the production gets easier each time, particularly if you use the techniques we show you at the end of this chapter.

If you want to take a break now, and start again later, save the changes to the document and quit Ventura. When you have more time, load Ventura, open the chapter C:\TEMP\6NEWS.CHP and start from where you left off.

If you're ready to forge ahead, proceed directly to the next section.

Tagging the newsletter

With the text in place, you can format the rest of the newsletter with tags. As always, start with the Body Text tag. Then proceed from the first frame to the last until all the text is tagged.

- Go to page one.
- Enable Paragraph mode.
- Select the second paragraph in frame #3, which starts "Ms. Belden will conduct basic skills workshops...."

Confirm that the Body Text matches the following attributes:

- Font
 - Face: Times
 - Style: Normal
 - Size: 010.0 points
- Alignment
 - Horz. Alignment: Justified
 - Overall Width: Column-Wide
 - First Line: Indent
 - In/Outdent Width: 01,00 picas & points

- Spacing Inter-Line: 12.00 fractional pts
Add in Above: When Not At Column Top

When you're finished with Body Text, you will then go to frame #1 and add a new tag called Logo.

Add the Logo tag

The logo is the most important element on the front page. It distinguishes a newsletter from others, projects the overall tone, and lends consistency from issue to issue. A logo can be letters and pictures or just letters and rules combined in a visually exciting way. The logo's size should relate to the other elements on the page. It should be easy to read without conflicting with the headlines.

- Select the paragraph "PAGINATIONS."
- Add New Tag Tag Name to Add: Logo
- Font Style: Bold
Size: 072.0 points

WARNING: If you are using a non-Postscript printer, you may not be able to print fonts as large as 072.0 points. Use the largest size available to you instead.

- Alignment Horz. Alignment: Center
Width: Column-Wide
In/Outdent Width: 00,00 picas & points

➡ *NOTE: In this style sheet, tags are copied from Body Text, which has a first-line indent of 01,00 picas & points. Therefore, you must remove this indent for all the tags that follow.*

- Spacing Inter-Line: 80.00 fractional pts
Add in Above: Always

Now use kerning and tracking to reduce the space between the individual letters and improve the appearance of the type.

- Select Paragraph Typography from the Paragraph menu.
Choose Automatic Pair Kerning: On, Letter Spacing: Off.
Make Tracking 0.050 Ems Tighter.

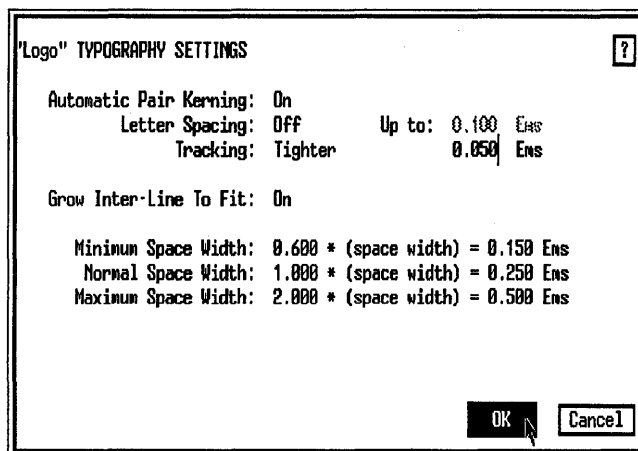

You can also track the letters interactively. Enable Text mode and select the letters you want to track. With the letters highlighted press the Shift key and the left arrow about five times. Each time you press the left arrow key you move the letters together about .01 Em. (Conversely, you can press the right arrow to move the letters further apart.) To find out the how much tracking you've done on-screen, choose Set Font from the Side-Bar while the letters are still highlighted.

Add Logo2 tag

Now you will add a tag named "Logo2."

■ Try to select the paragraph "NEWSLETTER."

You may find it impossible to select the NEWSLETTER paragraph. The inter-line spacing of the Logo tag is so large (80.00 fractional pts) that it causes the Logo paragraph to overlap the paragraph below. Fortunately, there are a few techniques to get around this problem:

- Select the second paragraph before you tag the Logo paragraph. This is a good method only if you know ahead of time that one tag will overlap the next.
- Tag the Logo paragraph as Body Text. This reduces the Logo tag to the size of Body Text and lets you select the paragraph below. After you add the Logo2 tag (to the Newsletter paragraph), retag the paragraph above it as Logo.

- Change the Frame typography. Select the frame reserved for the logo and change the setting for Move Down to 1st Baseline By from Default to Cap Height (Frame Typography, Frame menu). This action raises the baseline of the logo text and lets you select the paragraph below.

➡ *NOTE: If you are interested in understanding the subtle differences between Move Down to 1st Baseline By: Cap Height and Move Down to 1st Baseline By: Inter-Line, we encourage you to read the next section. On the other hand, if you have little interest in advanced typographic techniques, just follow the step-by-step instructions and watch what happens.*

Review move down to 1st baseline

In Chapter Three we introduced you to the concept of Move Down to 1st Baseline By in the Chapter Typography menu. Because most beginners have a hard time with this concept, we're going to take the time to review it.

Move Down to 1st Baseline By affects the starting position of text *at the top of a column or page*. For instance, when you select Move Down to 1st Baseline By: Inter-Line, Ventura positions the baseline (the imaginary line on which the text rests) of the word PAGINATIONS 80.00 fractional pts from the top of the margin (the value of its inter-line spacing). When you select Move Down to 1st Baseline By: Cap Height, Ventura “hangs” the word PAGINATIONS from the column margin by the tallest capital letter in the word. (Imagine the word PAGINATIONS hanging down from the top of the column like laundry hanging from a clothesline.)

Using Move Down to 1st Baseline By: Cap Height causes the word to be raised upward in the frame (Figure 6–23 and Figure 6–24).

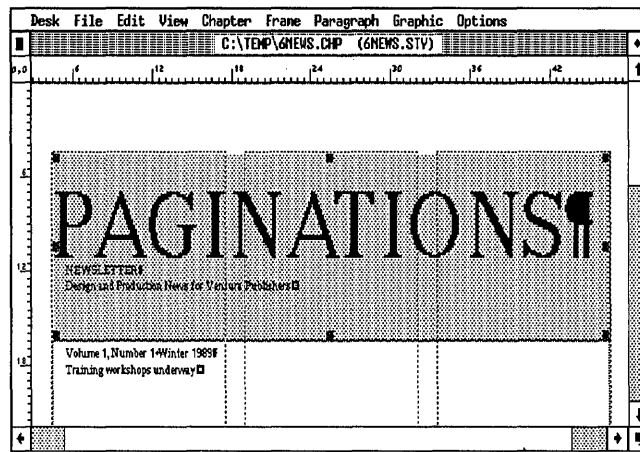

Figure 6-23. Move Down to 1st Baseline By: Inter-Line.

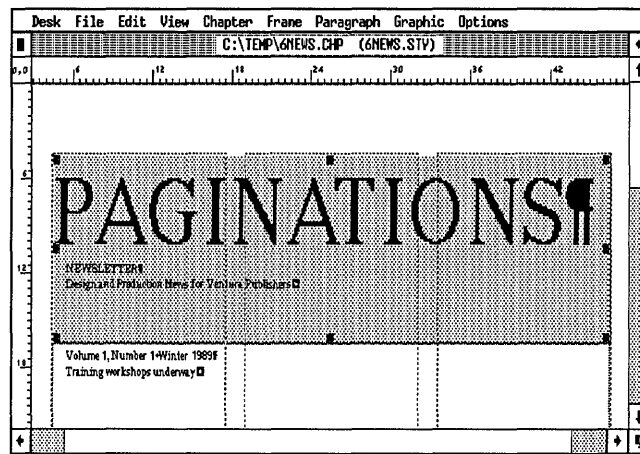

Figure 6-24. Move Down to 1st Baseline By: Cap Height.

If you're still struggling with this concept, you may understand it better if you step through the process. Go ahead and change the frame typography and watch what happens.

Change the frame typography

- Enable Frame mode.
- Select the logo frame.
- Select Frame Typography from the Frame menu.

- Choose Move Down to 1st Baseline By: Cap Height and click OK.

The word PAGINATIONS is raised up and you can now select the paragraph below.

- Enable Paragraph mode and select the paragraph “NEWSLETTER” in frame #1.
- Add New Tag Tag Name to Add: Logo2
- Font Style: Bold
 Size: 030.0 points
- Alignment Horz. Alignment: Center
 In/Outdent Width: 00,00 picas & points
- Spacing Above: 02.00 fractional pts
 Inter-Line 34.00 fractional pts
 Add in Above: Always

As you saw earlier, you can use tracking to reduce the individual space between characters and make a headline more legible. You can also use tracking to *add space* between characters for special effects. You will now add extra space between letters in the Logo2 tag.

- Select Paragraph Typography. Choose Automatic Pair Kerning: On, Letter Spacing: Off. Choose Tracking: Looser and enter 0.750 Ems.

When you are finished, the tag should look like Figure 6–25:

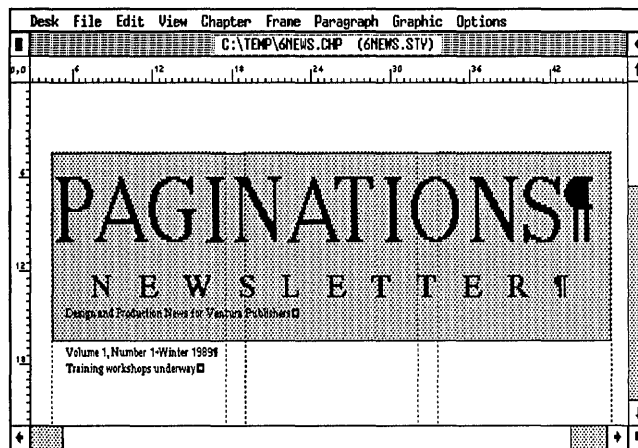

Figure 6-25.

Add a ruling line above and below the Logo2 tag

With the paragraph still highlighted, add ruling lines above and below.

- Ruling Line Above Width: Frame
Height of Rule 1: 01.00 fractional pts
- Ruling Line Below Width: Frame
Height of Rule 1: 01.00 fractional pts

Add the Motto tag

- Select the paragraph “Design and Production News for Ventura Publishers.”
- Add New Tag Tag Name to Add: Motto
- Font Size: 012.0 points
- Alignment Horz. Alignment: Center
Overall Width: Frame-Wide
In/Outdent Width: 00,00 picas & points

Now use tracking to tighten the spacing between letters.

- Paragraph Typography Letter Spacing: Off
Tracking: Tighter
Ems: 0.030

Add a custom rule to the Motto tag

To create the effect of a double line — one thick and one thin — you will add a custom rule above the Motto tag. Even though these two lines look like one unit, they are not. The top, thinner rule is part of the Logo2 tag above. The bottom, thicker rule will be attached to the Motto tag.

- With the Motto paragraph still highlighted, select Ruling Line Above. Make the unit measurement picas & points. Choose Width: Custom. Make the Space Above Rule 1: 00,01 picas & points. Give Rule 1 a height of 00,10 picas & points. Enter a Custom Indent of (+) 06,00 picas & points and a Custom Width of 30,00 picas & points.

"Motto" RULING LINES ABOVE

Width: Custom
Color: Black
Pattern: Solid
Dashes: Off

Space Above Rule 1: 00,01
Height of Rule 1: 00,10
Space Below Rule 1: 00,00
Height of Rule 2: 00,00
Space Below Rule 2: 00,00
Height of Rule 3: 00,00
Space Below Rule 3: 00,00
Overall Height: 00,11

Custom Indent: 06,00
Custom Width: 30,00
Dash Width: 00,00
Dash Spacing: 00,00 picas & points

OK Cancel

➔ **NOTE:** If the text below the motto paragraph disappears below the frame try 1) enlarging the frame, 2) reducing the Height of Rule 1, or 3) reducing the Space Above Rule 1.

Add a Dateline tag

Now move to the next frame to create the Dateline and Headline tags. In Chapter Three, you learned how to create a dateline by placing two different tags on the same line. Now we will show you another way to achieve the same effect, but this time with Tab Settings.

- Select the paragraph "Volume 1, Number 1...."
- Add New Tag Tag Name to Add: Dateline
- Font Style: N-Italic
- Alignment Horz. Alignment: Left
 In/Outdent Width: 00,00 picas & points
- With the paragraph still highlighted, select Tab Settings from the Paragraph menu. Choose Tab Number 1, Tab Type: Right, Tab Shown As: Open Space. Make the Tab Location: 42,00 picas & points and the Leader Char: Spaces. Click OK.

"Dateline" TAB SETTINGS ?

Tab Number: ← 1 →

Tab Type: Right

Tab Shown As: Open Space

Tab Location: 42,00 picas & points

Leader Char: Spaces 032 (ASCII)

Leader Spacing: 0

Auto-Leader: Off

OK
Cancel

Tab settings are always measured from the left margin. By setting a right tab at 42,00 picas & points (the width of the frame) you position the words "Winter 1989" flush against the right margin.

Tag the headline

Since most of the text on this page has already been preformatted for you, there are only a few more paragraphs to tag.

- Tag the paragraph "Training workshops underway" as Head1 (Figure 6-26).

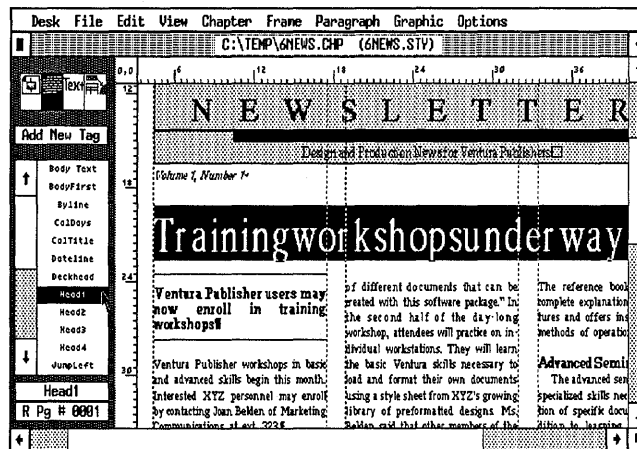

Figure 6-26.

- Select both jump text paragraphs (in frames #8 and #9) and tag them as JumpRight (Figure 6–27).

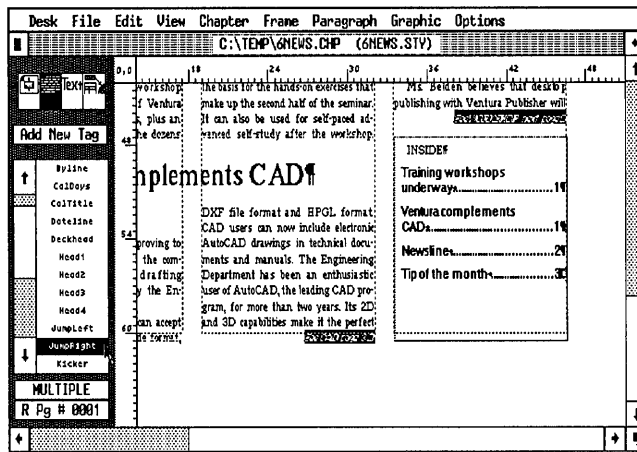

Figure 6–27.

- Select the paragraph “Ventura Complements CAD” and tag it as Head2.

To create the banner headline (“Ventura complements CAD”) we gave the tag a frame-wide alignment. Ventura stretches the text across the full width of the frame. If you are unclear about the difference between frame- and column-wide alignment, open the Alignment dialog box for Head2 and switch back and forth a few times.

➔ *TIP: You can also create a banner headline by placing text in a separate frame that spans more than one column. You used this second technique to create the Head1 headline above the first article.*

Tag the TOC

The last format changes on this page are in the Table of Contents (TOC) in the bottom right frame (frame #7). Add a new tag called DeptTitle.

- Enable Paragraph mode.
- Select the word “INSIDE” in the bottom right frame.
- Add New Tag Tag Name to Add: DeptTitle

| | |
|-------------|---|
| ■ Font | Style: Bold Size: 018.0 points |
| ■ Alignment | Horz. Alignment: Center In/Outdent Width: 00,00 picas & points |
| ■ Spacing | Below: 06.00 fractional pts Inter-Line: 24.00 fractional pts |

Add tracking to the DeptTitle tag

You can use tracking to add more space between the letters and mimic the graphic effect used in the logo.

| | |
|---------------------------|---|
| ■ Paragraph Typography | Letter Spacing: Off Tracking: Looser Ems: 0.800 |
|---------------------------|---|

Add ruling lines

A ruling line above and below the DeptTitle tag separates it from the TOC entries below.

| | |
|------------------------|--|
| ■ Ruling Line Above | Width: Frame Height of Rule 1: 01.00 fractional pts Space Below Rule 1: 06.00 fractional pts |
| ■ Ruling Line Below | Width: Frame Space Above Rule 1: 06.00 fractional pts Height of Rule 1: 01.00 fractional pts |

Check the page

Page one is now complete. Take a moment to look carefully for changes that might improve the design. For instance, examine the TOC title (“INSIDE”). If it does not appear properly centered you might want to use Text mode to add a thin space (Ctrl-Shift-T) or a figure space (Ctrl-Shift-F) in front of the word. (Figure 6–28.) Also, check that the jump text lines up with the text in the adjacent column. If it does not, adjust the size or position of the jump text frame (turn Line Snap off temporarily).

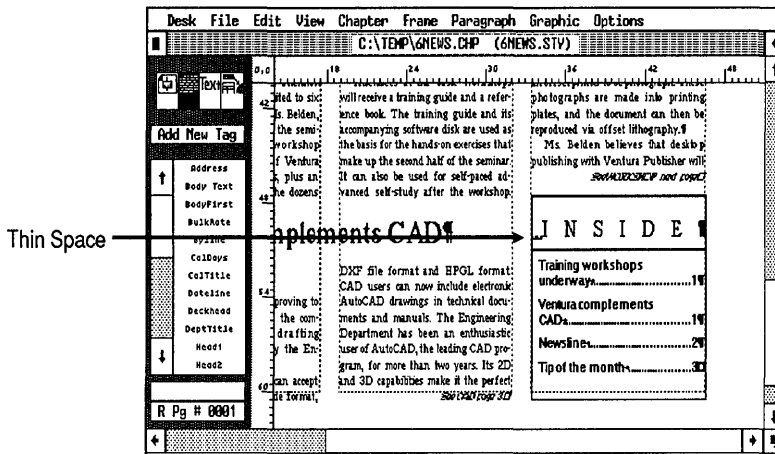

Figure 6-28.

➔ **TIP:** If you come across text alignment problems in a frame-intensive document, try adjusting your frames so they do not touch. Sometimes, when frames butt up against each other, Ventura pushes the text in the upper frame up a line.

Apply the DeptTitle tag

- Press PgDn to move to the next page.
- If necessary, enable Paragraph mode before you continue.
- Select the paragraph “NEWSLINE” at the top of frame #10 and tag it as DeptTitle.
- Select the jump text “WORKSHOP from page 1” (frame #13) and tag it as JumpLeft.

Add a PullQuote tag

Earlier, you created a special frame that separated the pull quote from the main text. Now you will enhance its appearance by enlarging the size of the text and adding a second ruling line above. This second line echoes the double line effect from the logo.

- In the pullquote frame (in the middle of frame #13), select the paragraph that begins “Anyone who wants....”
- Add New Tag Tag Name to Add: PullQuote

- Font Style: B-Italic
Size: 014.0 points
- Alignment Horz. Alignment: Left
In/Outdent Width: 00,00 picas & points
- Spacing: Inter-Line: 14.00 fractional pts
In From Left: 01,00 picas & points
In From Right: 01,00 picas & points
- Select Ruling Lines Above. Make the Width: Custom. Give Rule 1 a height of 00,08 picas & points and the Space Below Rule 1: 01,01 picas & points. Make the Custom Indent: (+) 00,07 picas & points and the Custom Width: 10,00 picas & points.

The pull quote should look like Figure 6-29:

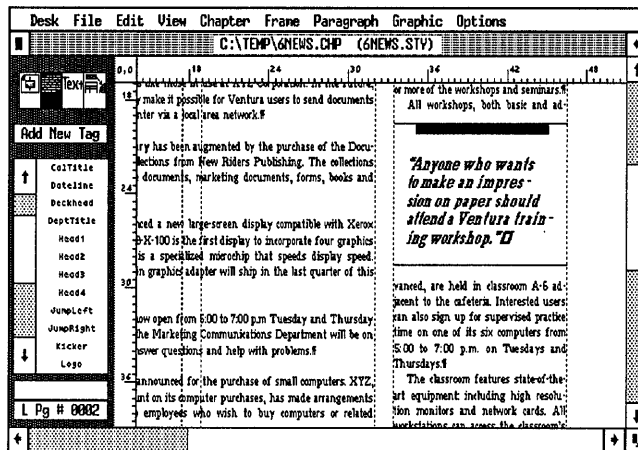

Figure 6-29.

Add a big first character to the StaffBox tag

Now let's change the text in the staff box frame at the bottom of page two. To set it apart from the surrounding text, change the text to italics and add a big first character.

- Select the paragraph from the staff box "Paginations is published...."
- Font Style: N-Italic

- Select Special Effects from the Paragraph menu. Choose Special Effect: Big First Character. Choose Set Font Properties to bring up the Font dialog box. Choose Style: B-Italics, and Size: 024.0 points. Click OK to return to the first dialog box. Now choose Space for Big First: Custom and make the custom lines 001. Click OK to close the dialog box.

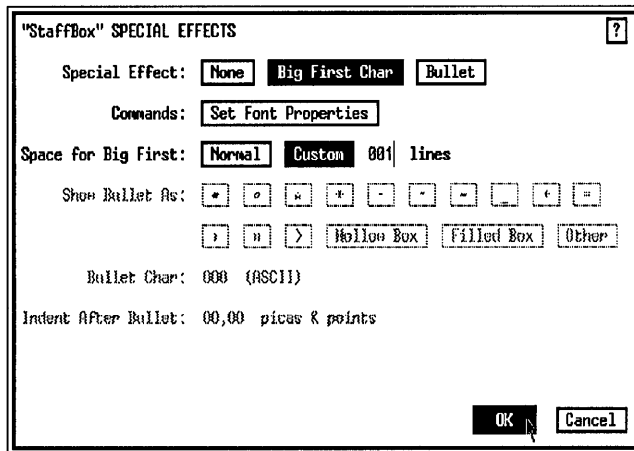

If you had chosen Space for Big First: Normal, Ventura would have made its own best decision where to place the big first character. In this particular case — a 24-point big first character on 12-point lines — it would have chosen two lines. It would have set the first character on the baseline of the *second* line, creating a two-line indent.

When you choose Custom instead, you get to decide which baseline to use. By entering 1, for example, you tell Ventura to place the big first character on the baseline of the *first* line. To make a big first character start below the first line, enter a number greater than one.

Apply JumpLeft tag

- Press PgDn to move to page three.
- Select the jump text “CAD from page 1” (frame #17) and tag it as JumpLeft.

Add an end of article symbol on page three

To distinguish the beginnings and ends of articles in a newsletter, it is common to place a special editorial symbol, like a square (either hollow or solid) or a small version of the logo at the end of the article. In a text-intensive, multi-column format, this symbol is easy to spot and guides the reader from the end of one story to the beginning of another. We will show you how to create a special end of article symbol using the Ins Special Item option. You will insert a small hollow box at the end of an article on page three.

➡ **NOTE:** You can also create an end of article symbol with a character from the international character set or (if you have a PostScript printer) Zapf Dingbats. In Text mode, insert the code you want by pressing Alt and the number from the numeric keyboard. Then highlight the character and choose Set Font from the Side-Bar to change the font to either Zapf Dingbats or Symbol.

■ Enable Text mode. Place the cursor in front of the end of file marker at the end of the middle frame on page three (frame #15). (Figure 6—30.)

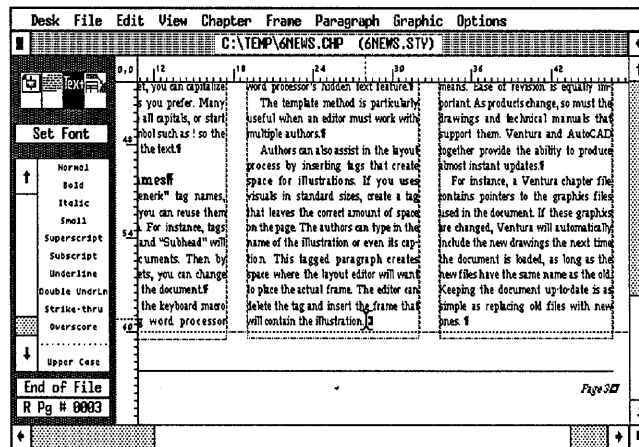
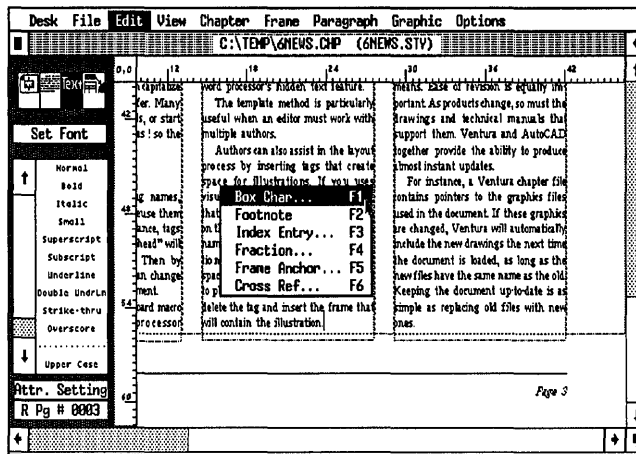

Figure 6-30.

■ Select Ins Special Item from the Edit menu (Ctrl-C).

■ Choose Box Char or press the F1 function key.



■ When you are asked to insert a hollow or filled box character, choose hollow.

Ventura places the hollow box at the end of the text. Now you can interactively change the size of the hollow box.

■ While you are still in Text mode, highlight the box by dragging or by using the Shift-Click method.

■ Once it is selected, hold down the Shift key and tap the down arrow key until you see the box get smaller. (To increase the box, hold down the Shift key and press the up arrow key.)

➡ **NOTE:** If the box does not appear smaller, press the ESC key once to redraw the screen.

When finished, your page should resemble Figure 6-31:

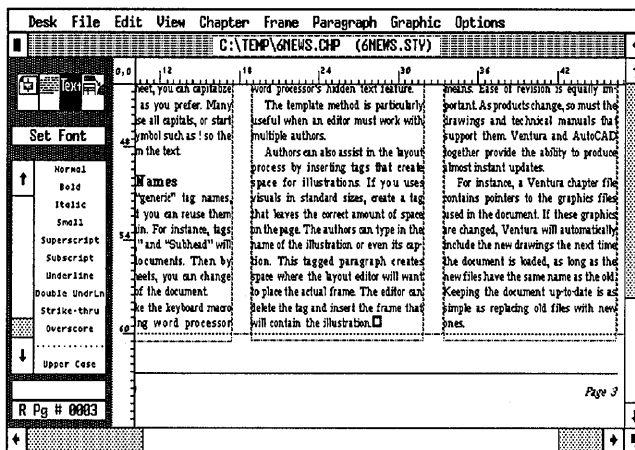

Figure 6-31.

➤ **NOTE:** When you move the text cursor over a box character on-screen the words “Box Character” appear in the Current Selection Box. You can cut, copy, and paste a box character just as you would any other text character — use the Edit Text option in the Edit menu or use the equivalent keyboard shortcuts.

▣ If you want more practice inserting box characters, repeat the steps above to add a hollow box to the end of the each article in the newsletter.

➤ **TIP:** You can copy the hollow box to the clipboard and then paste it in where you want.

The final page

Since the rest of page three is already preformatted, go to the last page of the newsletter.

▣ Press End to go to the last page.

Adding the Address tag

To complete the style section, you will add two tags that reside on the same line: the Address tag and the BulkRate tag.

The Address tag

- Enable Paragraph mode.
- Select the paragraph “New Riders Publishing...”
- Add New Tag Tag Name to Add: Address
- Font Face: Helvetica
- Alignment Horz. Alignment: Left
In/Outdent Width: 00,00 picas & points
- Spacing Above: 24.00 fractional pts
Inter-Line: 24.00 fractional pts
Add in Above: Always
In From Left: 02,00 picas & points

As you learned earlier, you can use Breaks to place two tags on the same line. The first tag — in this case the Address tag — uses a line break before.

- Breaks Line Break: Before
Allow Within: Yes
Keep With Next: No

The BulkRate Tag

Now create the BulkRate tag and change the Line Break to After so it appears on the same line with the Address tag (Figure 6–32).

- Select the paragraph that begins “Bulk Rate...”
- Add New Tag Tag Name to Add: BulkRate
- Font Face: Helvetica
- Alignment Horz. Alignment: Center
In/Outdent Width: 00,00 picas & points
- Spacing Above: 24.00 fractional pts
Add in Above: Always
In From Left: 30,00 picas & points
In From Right: 02,00 picas & points

Using In From Left and In From Right pushes the BulkRate tag to the right margin. The In From Left and Right spacing prevents the two tags from overlapping.

Now place the BulkRate tag on the same line as the Address tag.

■ Breaks

Line Break: After

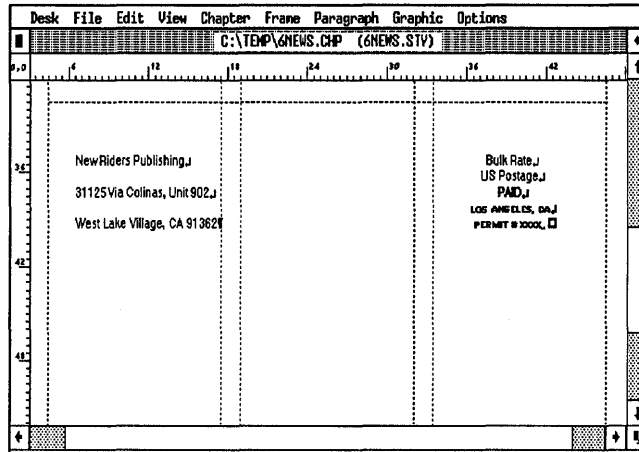

Figure 6-32.

Add ruling lines to the BulkRate tag

Add the finishing touches by adding ruling lines above and below the margins of the BulkRate tag.

■ Ruling Line
Above

Width: Margin

Height of Rule 1: 04.00 fractional pts

Space Below Rule 1: 06.00 fractional pts

■ Ruling Line
Below

Width: Margin

Space Above Rule 1: 06.00 fractional pts

Height of Rule 1: 04.00 fractional pts

➡ *TIP: We made the ruling line width equal to Margin so it lined up with the margin created by In From Left and In From Right spacing.*

Pictures

Illustrations are an important part of many newsletters. In this section, you will import and scale an image file and use Box Text shapes to draw a monthly calendar. Let's start by adding an illustration and caption to the article on page three.

Place the picture

- Press PgUp to move back to page three.
- Enable Frame mode.
- Select the picture frame (frame #18) and place the image file WPVP.IMG from the Assignment List.

Scale the picture

- Sizing & Scaling Picture Scaling: Fit in Frame
Aspect Ratio: Distorted

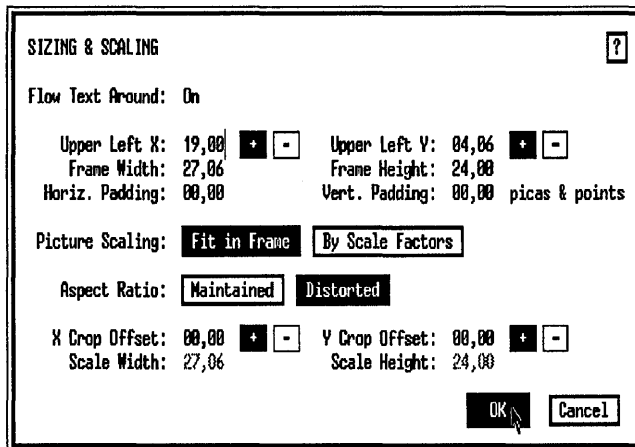

By choosing Distorted, you allow Ventura to stretch the dimensions of the picture as much as needed to fit it exactly inside the frame.

➔ **NOTE:** Because the picture is close to the actual size of the picture frame, there is very little visible distortion.

Add a caption to the frame

With the picture frame still selected, add a caption.

- Anchors & Captions Caption: Below

Ventura attaches an empty caption frame to the original frame. Now add the caption text inside this frame.

- Enable Text mode. Place the cursor in front of the end of file marker inside the caption frame. Type:

Insert tag names into word processing files to preformat Ventura documents.

The caption is already formatted for you (Figure 6-33).

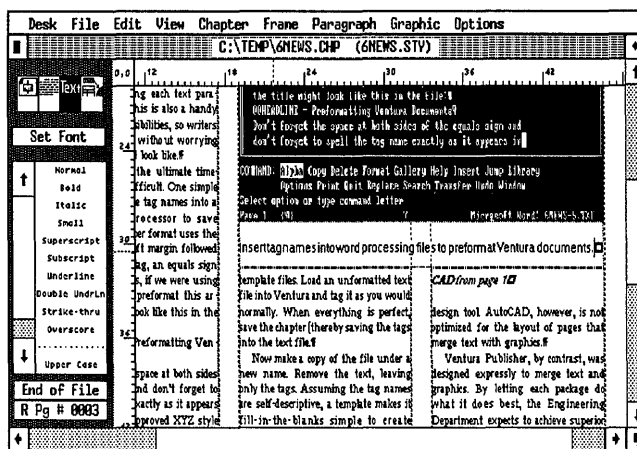

Figure 6-33.

Draw a calendar

Many readers consider the calendar the most useful part of a newsletter. It lists current and future events in an eye-catching, visual format. By placing the calendar on the back page, you make it easy for someone to find and refer to throughout the month.

- Go to page four.

Before you begin to draw the Box Text, set up a snap-to grid for the frame that will contain the calendar.

- Enable Graphic mode.
- Select the top frame.
- Grid Settings Grid Snap: On
Horizontal Spacing: 06,00 picas & points
Vertical Spacing: 02,00 picas & points

Draw the title box

Start the calendar by drawing the Box Text shapes to contain the calendar title and the days of the week.

- Before you draw the first Box Text, reset the zero point of the ruler to the upper left corner of the frame (frame #19).
- Select the Box Text tool from the Side-Bar. Starting at the upper left column margin, draw a Box Text 42,00 picas & points wide (the width of the frame) by 02,00 picas & points high (one grid snap unit). (Figure 6–34.)

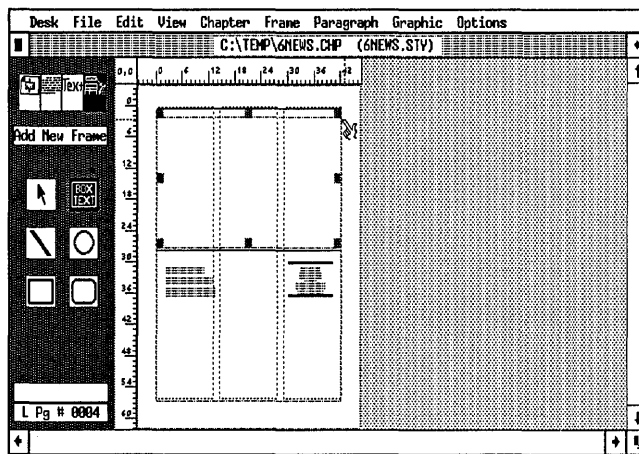

Figure 6–34.

➔ **NOTE:** Remember, you can align the ruler with any edge of a Box Text to check its measurements.

Now change the line and fill attributes.

- Line Attributes Thickness: None
- Fill Attributes Color: White
 Pattern: Hollow
 Result: Transparent
 Default: Save To

Draw the days of the week

Draw one Box Text for the first day. Then use copy and paste to duplicate the shape across the frame.

- Switch to Normal or Enlarged View to draw the next shape.
 Starting at position 2 picas on the vertical ruler, draw a Box
 Text 06,00 picas wide by 02,00 picas high (Figure 6–35).

- Line Attributes Thickness: Thin
 End Styles: Square
 Default: Save To
- Fill Attributes Color: Black
 Pattern: 2
 Result: Transparent

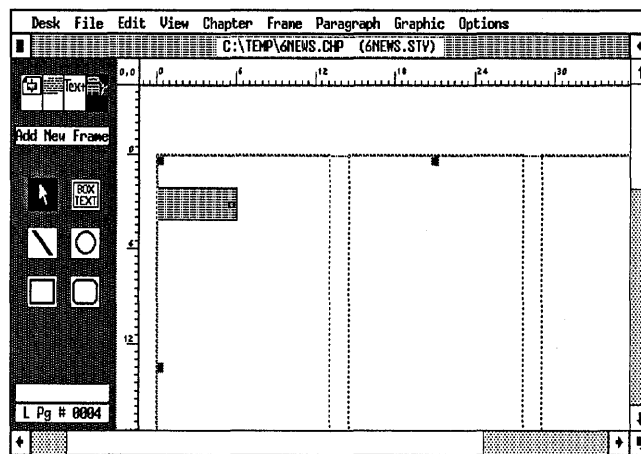

Figure 6–35.

Copy the shape

- Press Shift-Del to copy the last shape into the clipboard. Press Ins to paste a copy on the page.

Remember, Ventura pastes the copy on top of the original.

- Use the mouse to move the shape to the right. Thanks to the grid, it will snap into position.

Complete the remaining boxes

- To add the rest of the boxes for the days of the week, copy the last Box Text shape, then copy it five times across the width of the frame.

When you are finished, your screen should look similar to Figure 6-36:

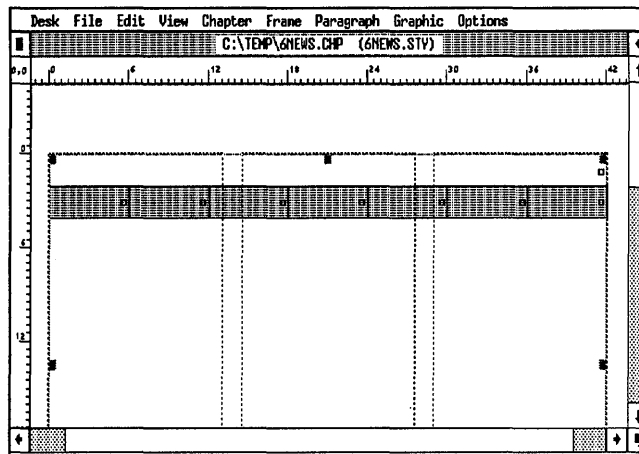

Figure 6-36.

Finish the calendar

Now you will copy the entire row of boxes four times, using Shift-Click to select the entire row at once.

- ➡ *TIP: Be careful when trying to move an entire row of boxes. You must avoid accidentally resizing the boxes, or selecting just one and leaving all the others behind.*

To move an entire row, use Shift-click to select all the shapes. Now hold down the Shift key and press down the mouse button in one of the shapes. *Do not move the mouse until the four-way arrow appears.* If the pointing finger appears instead, release the button immediately without moving the mouse. Then reposition the cursor and try again.

With these precautions in mind, complete the following steps.

Draw the first box

By changing the vertical grid settings, you make it easier to create the right size box.

- Grid Settings Grid Snap: On
Horizontal Spacing: 06,00 picas & points
Vertical Spacing: 04,00 picas & points
- Starting from position 4 picas on the vertical ruler draw a Box Text 06,00 picas wide by 04,00 picas high.

Copy the box

- Press Shift-Del to copy the first box to temporary memory.
- Paste a copy of the box back onto the page.
- Use the mouse to move the copy to the right until it snaps into place.

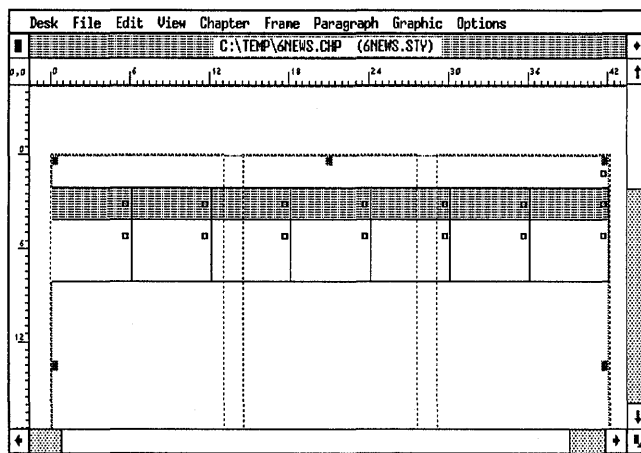

Figure 6-37.

- Paste five more copies and move them into position to complete one row of the calendar (Figure 6–37).

Copy the row

Now you will copy the entire row of boxes into the clipboard.

- Select the first box. Shift-Click to select the remaining boxes. Then press Shift-Del to copy the entire row into temporary memory.
- Press Ins to paste a copy of the row onto the page.
- Hold down the Shift key and place the cursor in the middle of one box shape. Drag the entire row of shapes down one grid unit.
- Paste three more copies and move them into position to complete the calendar (Figure 6–38).

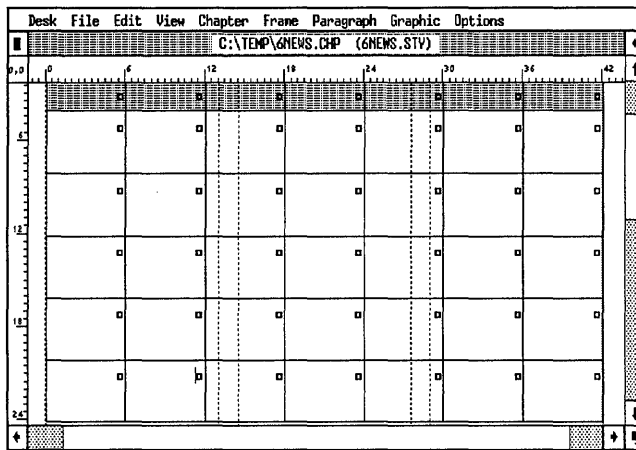

Figure 6–38.

➡ **NOTE:** If you have trouble moving the shapes as a group, move them one at a time.

Add text to the calendar

Now that all the Box Text shapes are in place, use Text mode to enter the calendar text. Use Figure 6–39 as a guide.

➔ **NOTE:** Use a line break (Ctrl-Enter) to separate lines within a Box Text.

| February 1988 | | | | | | |
|---------------------|----------------------|---------|--------------------|---------------------|--------|----------|
| Sunday | Monday | Tuesday | Wednesday | Thursday | Friday | Saturday |
| | | | 1 | 2 Basic Workshop | 3 | 4 |
| 5 Basic Workshop | 6 | 7 | 8 | 9 | 10 | 11 |
| 12 | 13 | 14 | 15 Adv. Seminar | 16 | 17 | 18 |
| 19 | 20 Basic Workshop | 21 | 22 | 23 | 24 | 25 |
| 26 | 27 Adv. Seminar | 28 | | | | |

New Riders Publishing
31125 Via Colinas, Unit 902
West Lake Village, CA 91362

Bulk Rate
US Postage
PAID
LOS ANGELES, CA
PERMIT # XXXX

Figure 6-39 Your calendar will look like this after typing in the text and tagging it.

Apply tags to the calendar

Use the predefined tags in the Assignment List to format the calendar.

- Enable Paragraph mode.
- Select the paragraph “February 1989” and tag it as Cal-Title.
- Tag all the days of the week as CalDays.

Chapter

Nice work. You should be proud of yourself. After completing this project, you’re ready to take on any type of newsletter, whether simple or complex. Let’s take a look at the finished product.

- To Print Which Pages: All
 Printing Order: Last to 1st

Once you have the final copy in your hands, inspect each page, looking for small changes that will improve its appearance. Remember, no matter how good it might appear on the screen, the true test of your talents shows up after printing.

Creating a chapter template

As promised, we’re going to finish this chapter with tips that speed newsletter production. Once you establish a successful format, the hard part has been done. You can reuse your newsletter chapter over and over again for future issues.

Here’s how it works. Open the newsletter and save it under a new name — `TEMPLATE.CHP`, for example, or `BLANK.CHP`. Now remove all the text files and graphics files with Remove Text/File from the Edit menu (Figure 6–40).

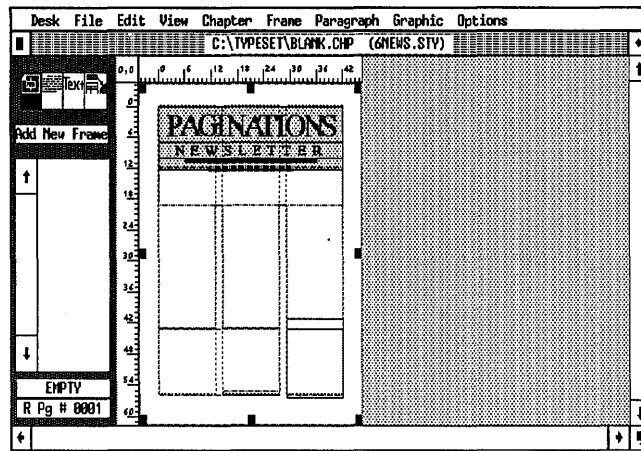

Figure 6-40.

➔ **NOTE:** You do not have to remove the logo text, unless you are using the same template for different newsletters with different names.

Now save `TEMPLATE.CHP` again. From now on, you will use this chapter full of blank frames as your starting point. Start by renaming the template so you preserve it intact. Then load and place text files into the empty frames. Change the headers and footers if necessary to reflect the new dates. Adjust frame sizes, add frames, edit copy and make any other minor changes as necessary to make the new text and pictures fit. Newsletters that vary quite a bit from month to month may require more extensive adjustments. Even so, you will still be finished with the newsletter in a fraction of the time it takes to build one from scratch.

Another time-saving trick

If you want to save a step, simply use the same file names for each issue's text and pictures. This technique is most useful if the newsletter format is nearly the same each month. Make a copy of the first issue under a new name, but *do not remove the text and graphics files*. Keep this new version in a subdirectory of its own, together with all the files that make up the chapter. For example, you might call the copy `FINAL.CHP` and store it in a directory called `\FINAL` because this is the

chapter you will use to print the final version of the newsletter each month.

Collect the text and graphics for each new issue in a separate subdirectory (for instance, \JANUARY, \FEBRUARY, \MARCH, etc.). When everything's ready to go, copy the text files to the \FINAL directory, but *rename the files so they match the names used in the first issue*. Once you've updated the files in \FINAL directory, you can load FINAL.CHP. Since the file names are the same, Ventura will immediately flow the new text and graphics into the old layout. You won't even need to place the files. You will, however, need to make some minor adjustments before printing.



Tips and techniques

Text tips

- After you convert a text file format, or rename it to a new location, the changes do not take effect until you save the chapter. If you abandon the chapter without saving, you will lose the changes.
- To create a dashed line effect, choose Ruling Line Above, Below or Ruling Box Around from either the frame or paragraph and select Dashes On. You can adjust the width of the dashes and the space between them.
- The text you type directly into a frame or caption is stored in Ventura's caption file. If you wish to save the text as a separate file use File Type/Rename from the Edit menu. Ignore the name you see listed in Old Name. Type in the new name and location and click OK.

Style tips

- A pull quote is a short quotation that can be used as a graphic element to fill space or add emphasis to an article. To make a pull quote, place and size a separate frame within a column. Then type the pull quote text directly into the frame. Add a new tag called PullQuote and change the text attributes to create the desired effect.

- Use tracking to reduce or increase the space between individual letters in a word.
- To create a banner headline, tag the text as frame-wide, or place text in a separate frame that spans more than one column.
- If you choose Space for Big First: Normal, Ventura makes its best guess where to place the big first character. When you choose Custom instead, you decide which baseline to use. By entering 1, for example, you tell Ventura to place the big first character on the baseline of the first line. To make a big first character start below the first line, enter a number greater than one.
- Use an end of article symbol to show where one article ends and another begins. Use the Ins Special Item to insert a hollow or filled box at the end of a story.

Picture and frame tips

- It is easiest and most efficient to build newsletters by pouring text into frames.
- Frames can have fill patterns and up to three ruling lines around.
- Frames that reside on top of the Underlying Page can have the same or different margins and columns as the Underlying Page.
- Make the vertical padding of frames equal to the current inter-line spacing of the Body Text tag.
- If you come across text alignment problems in frame-intensive layouts, try adjusting the frames so they do not touch each other. Sometimes when frames butt up against each other, Ventura pushes the text in the upper frame up one line.
- Be careful when you move a group (a row or a column) of graphic shapes together. To avoid accidentally re-sizing them, or selecting one by itself, be sure to select them by holding down the Shift key before you go to move the boxes. After you press the mouse button, do not move the shapes until the four-way arrow appears.

Chapter tip

- You can re-use a standard chapter format over and over again by converting it into a chapter template. Take the original chapter and save it as a new chapter. Then remove all the text and picture files. Once they are removed, save the new chapter with a name like BLANK.CHP. From now on, you will use this chapter, including its frames, headers and footers, and so forth, to begin your new projects.

Chapter Seven Skills Checklist

Theory

- The power of pretagging
- Creating a directory from a database file

Text

- Line breaks versus paragraphs
- More timesaving tips on preformatting

Style

- Live headers and footers that change from page to page
- How to make your own crop marks
- Advanced typographic effects using reverse type
- Inserting the page number anywhere on the frame

Picture

- Creating thumb tabs with repeating frames
- Adding fill patterns to frames

Chapter

- Creating a publication
- Linking page numbers from chapter to chapter
- Using Multi-Chapter to print a publication
- Using chapter templates to speed production

Chapter Seven

A Directory

Combining the power of a database program with Ventura's batch formatting allows you to publish professional-quality directories quickly and easily. In this chapter, you will create a sample directory using the skills and techniques listed on the facing page.

In Chapter Two, you learned the basics of preparing text in advance, including how to use bracket codes to enter attributes directly into word processing files. In this chapter, you will also learn how to enter tag names directly. In addition, we will pass along a few ideas on how to use a database program to generate pretagged files for Ventura.

Theory

Because of time and space limitations, you will not actually use a database to build the sample document in this chapter. However, the text file you will load into the sample document resembles a file you would get from a database. If you expect to use a database in your real-life applications, you will benefit from understanding the theory of using a database to generate pretagged files.

The power of pretagging

The fastest way to format text from a database is to include tag names in the text file. As soon as the file is loaded into Ventura, the style sheet definitions are automatically applied. Pretagging virtually eliminates the need to tag inside Ventura and reduces layout time and formatting errors. You can, of course, produce sophisticated documents without pretagging.

course, produce sophisticated documents without pretagging. In the long run, however, this pretagging shortcut saves time and increases productivity.

Rules for pretagging

When you load a text file, Ventura treats all untagged paragraphs as Body Text. For this reason, you do not need to pretag Body Text. All other paragraphs, however, can be pretagged using the format `@TAGNAME = .` The “at” sign (@) comes first followed by the tag name (e.g. HEAD1, HEAD2, etc.), a space, an equals sign, and a second space. Leaving out any character or space cancels the tagging instruction. Likewise, the tag will not take effect unless it is the first line in the paragraph and flush against the left margin. Moreover, the tag name in the text file must match the name in the style sheet *exactly*. Ventura doesn’t care whether you capitalize or not, but it does care that you spell both tag names the same.

In the files you will load for this chapter, `@HeadSection =` is the tag code for the title of each directory section. `@Head1 =` is the tag code for the first-level heading (the single letters that precede each alphabetical section); `@Head2 =` is the tag code for the second level heading, and so on. Backward arrows (↵) at the end of lines indicate line breaks. Paragraph symbols (¶) indicate paragraph returns.

At first glance, it seems like extra trouble to type in tag names at the beginning of each paragraph. Once you settle on a standard set of names, however, you can store them as keyboard macros (with your word processor or a separate program like Smartkey). Then you can enter tags in quickly by pressing a single macro key. Or, as suggested below, you can have a database program do the work for you.

You’ll find more tips on pretagging text at the end of the chapter.

Using a database file with Ventura

Database programs are more practical than word processors for generating lists and directories. Businesses use database programs to maintain client lists, mailing lists, inventory lists, and so forth. You can transform such a list into a Ventura

document by having the database program generate an ASCII file, which then can be loaded into Ventura. Creating an ASCII file can be as simple as printing a report to disk.

➡ *NOTE: If you are not familiar with the structure and use of a database, you may not understand some of the terminology (e.g. fields, records, and so forth) we introduce in the strategy section below. Don't worry. Just skip ahead to the planning section and read about the Ventura skills you will learn in this chapter. You will be able to apply most of these skills to practical projects that don't require the use of a database.*

A “raw” ASCII file, however, needs lots of formatting once inside Ventura. You can make things even easier by using the database to pretag the file. Here's the strategy:

- Prepare a thumbnail sketch of the directory. Choose names for the tags (for instance, Head1, Head2, Company, Phone#, etc.).
- Use Ventura to create a style sheet with matching tag names. Format it to match the thumbnail sketch.
- Sort the database to pull out the specific information you need.
- Specify a database report with the fields in correct order.

So far you've done nothing out of the ordinary with Ventura or with the database. To pretag, however, you must take two additional steps:

- Use the database report generator to insert the tag names in front of the fields.
- Print the report (which now includes the tag names) to disk.

Once you've generated the pretagged ASCII file, you can load it into Ventura. The text will be formatted as soon as you place the file on the Page.

Line breaks versus paragraphs

The sample text file you will use in this chapter contains line breaks as well as paragraph returns. For long documents such

as directories, you should get in the habit of using line breaks to create new lines whenever both lines have the same tag name. Line breaks consume less memory than returns. Memory considerations do not come into play for short documents, but they can become a concern with long documents, especially those with many lines of small type and memory-intensive effects such as leader dots.

A database can enter line breaks by inserting the bracket code <R> in place of a carriage return (Figure 7-1).

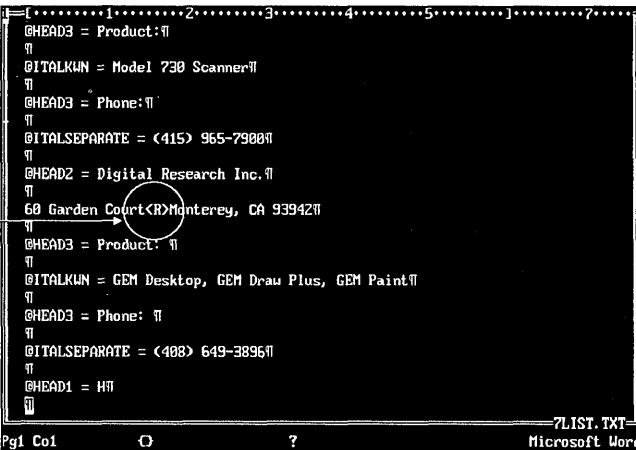

```
.....1.....2.....3.....4.....5.....6.....7.....
@HEAD3 = Product:¶
¶
@ITALKUN = Model 730 Scanner¶
¶
@HEAD3 = Phone:¶
¶
@ITALSEPARATE = (415) 965-7900¶
¶
@HEAD2 = Digital Research Inc.¶
¶
60 Garden Court<R>Monterey, CA 93942¶
¶
@HEAD3 = Product: ¶
¶
@ITALKUN = GEM Desktop, GEM Draw Plus, GEM Paint¶
¶
@HEAD3 = Phone: ¶
¶
@ITALSEPARATE = (408) 649-3896¶
¶
@HEAD1 = HT¶
¶
-7LIST.TXT
Pg1 Col 0 ? Microsoft Word
```

Figure 7-1. Use line breaks instead of returns in a long directory file. Ventura's line break code is <R>.

Before

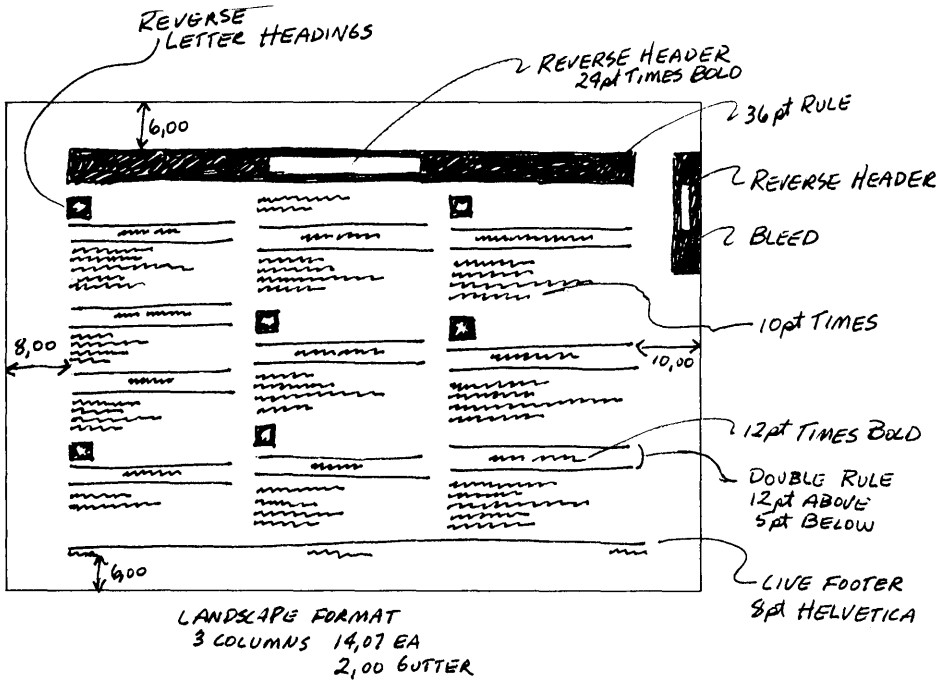

After

Manufacturers

| | | |
|---|--|---|
| <p>A</p> <hr/> <p style="text-align: center;">Adobe, Inc</p> <hr/> <p>1870 Embarcadero Rd. Palo Alto, CA 94303 Product: <i>PostScript, Illustrator, Adobe Type Library</i> Phone: (415) 852-0271</p> <hr/> <p style="text-align: center;">Allied Linotype Co.</p> <hr/> <p>425 Oster Ave. Hauppauge, NY 11788 Product: <i>Linotronic 100 and 300</i> Phone: (516) 434-2016</p> <hr/> <p style="text-align: center;">Autodesk, Inc.</p> <hr/> <p>2320 Marinship Way San Rafael, CA 94965 Product: <i>AutoCAD, AutoSketch</i> Phone: (415) 332-2344</p> <hr/> <p>D</p> <hr/> <p style="text-align: center;">Datascopy Corp.</p> <hr/> <p>1215 Terra Bella Ave Mountain View, CA 94043</p> | <p>Product: <i>Model 730 Scanner</i> Phone: (415) 965-7900</p> <hr/> <p style="text-align: center;">Digital Research Inc.</p> <hr/> <p>60 Garden Court Menlo Park, CA 94025 Product: <i>GEM Desktop, GEM Draw Plus, GEM Paint</i> Phone: (408) 649-3896</p> <hr/> <p>H</p> <hr/> <p style="text-align: center;">Hewlett-Packard</p> <hr/> <p>P.O. Box 15 Boise, ID 83707 Product: <i>Laserjet Plus, Laserjet II, Scanjet</i> Phone: (208) 323-3869</p> <hr/> <p>I</p> <hr/> <p style="text-align: center;">Imagen</p> <hr/> <p>2650 San Tomas Expressway Santa Clara, CA 95051 Product: <i>DDL Language</i> Phone: (408) 986-9400</p> | <p>L</p> <hr/> <p style="text-align: center;">Lotus Development Corp.</p> <hr/> <p>55 Cambridge Parkway Cambridge, MA 02142 Product: <i>Lotus 1-2-3, Symphony, Freelance, Graphwriter</i> Phone: (617) 577-8500</p> <hr/> <p>M</p> <hr/> <p style="text-align: center;">Media Cybernetics</p> <hr/> <p>8484 Georgia Ave., Ste. 200 Silver Spring, MD 20910 Product: <i>Halo Desktop Publishing Editor</i> Phone: (301) 495-3305</p> <hr/> <p style="text-align: center;">MicroPublishing</p> <hr/> <p>21150 Hawthorne Blvd., Ste. 104 Torrance, CA 90503 Product: <i>microPublishing Report Newsletter, Ventura Style Sheets</i> Phone: (213) 376-5724</p> |
|---|--|---|

M i S o 1

1888 Edition

Manufacturers A-A

Chapter 1

Planning the directory

Directories are text-intensive documents with detailed listings of people, products, organizations, etc. Most directories are quick reference guides. They are scanned and skimmed to pinpoint information. As such, they should be designed to help the reader find facts quickly and efficiently. Since most directories maintain the same format from page to page they are fast to format, especially if you pretag the files.

The landscape page format of this chapter's sample directory provides three spacious columns for text. Graphic techniques such as reverse type, ruling lines, and thumb tabs help the reader spot different sections, headings, and entries. For instance, the thumb tabs bleed to the edge of the page. Even with the book closed, you can tell where one section begins and another ends by the dark edges of the pages. The reverse type effect on the heading creates a visual contrast between major headings and minor entries and helps establish an hierarchical order of information.

Here are some of the effects and techniques you will learn in the directory:

- Live footers
- Thumb tabs
- Landscape layout
- Reverse type (or shaded type)
- Crop marks
- Page numbers anywhere on the page

This chapter's sample contains two partial sections of a three-section directory. The first section is arranged alphabetically by manufacturer, the second by category. You will create each section as a separate chapter. At print time, you will use Ventura's multi-chapter operation to combine them into a single publication. In actual practice, you may find it practical to create directories of up to 30-40 pages as a single chapter. For longer directories, we recommend breaking the individual sections into separate chapters.

Ventura prep



If you have the Power disk

Load and rename/relocate the files for this chapter.

- Load the text file 7LIST.TXT from the C:\POWER sub-directory. Use File Type/Rename to save it as C:\TEMP\7DIRECT.TXT.
- Load the style sheet 7LIST.STY from the C:\POWER sub-directory. Save it as C:\TEMP\7DIRECT.STY.
- Save the chapter as C:\TEMP\7DIRECT.CHP.



If you do not have the Power disk

- If you don't own the Power disk, type in 7DIRECT.TXT from Appendix A. Save it as C:\TEMP\7DIRECT.TXT.
- Load &TBL2-L1.STY from C:\TYPESET. Modify it to match Figure 7-2. Add or change tags using the tag tables in Appendix B. Save it as C:\TEMP\7DIRECT.STY.
- Save the chapter as C:\TEMP\7DIRECT.CHP.

WARNING: When you type in the directory file listings in ASCII format, remember to place two carriage returns between each paragraph. Otherwise, Ventura runs all the lines of text together. This warning applies to database files you create on your own.

Text

For this project, you will act as if you have already used a database program to generate and preformat the ASCII file 7LIST.TXT. Although the text file contains tag names, those tags have not yet been defined in the style sheet, so all the text is displayed as Body Text. When you get to the style section, you will build the tags while learning some new graphic effects.

- Place the text file 7DIRECT.TXT on the Page.

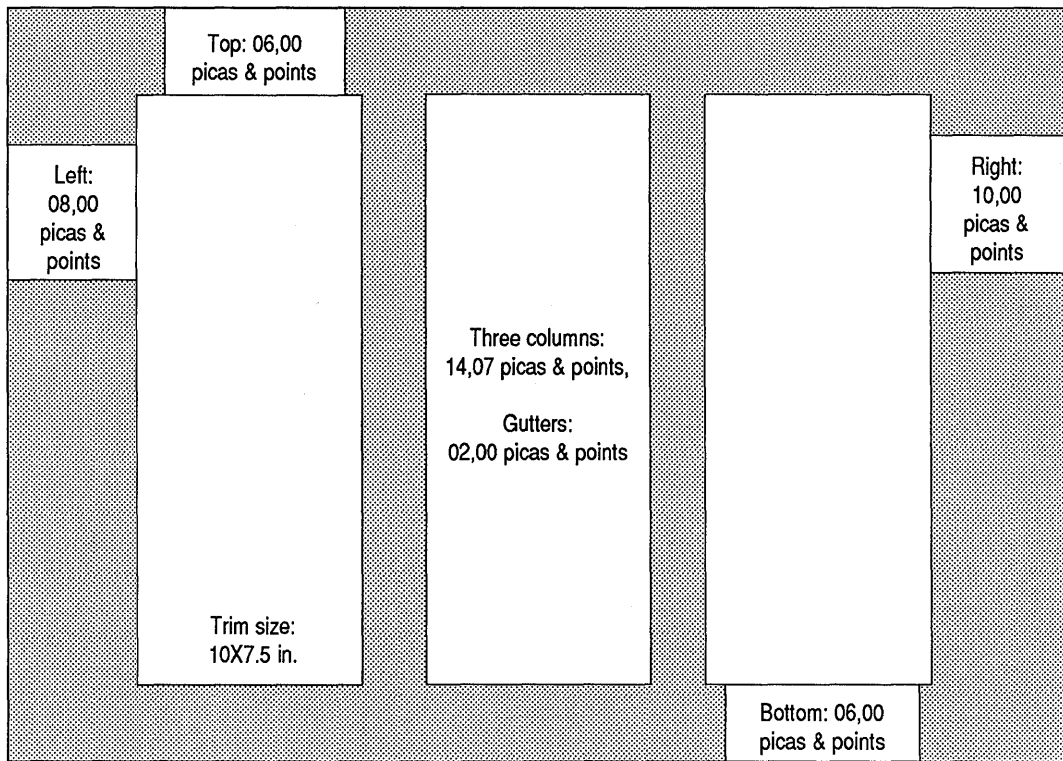

Figure 7-2. If you do NOT have the Power disk, modify the right page of &TBL2-L1.STY to match this illustration with Margins & Columns, then copy these settings to the facing page.

Style

In the style section you will learn a variety of useful techniques, including crop marks, live headers and footers, leader dots, and more.

Chapter layout

If you loaded the preformatted style sheet from the Power Disk, all the chapter settings should be intact. To be on the safe side, confirm both the page layout and the margins and columns.

■ Page Size &
Layout

Orientation: Landscape
Sides: Double
Start On: Right Side

▣ Margins & Columns

of Columns: 3
 Settings For: Right Page
 Top: 06,00 picas & points
 Bottom: 06,00 picas & points
 Left: 08,00 picas & points
 Right: 10,00 picas & points
 Column 1,2,and 3 width: 14,08 picas & points
 Gutter width: 02,00 picas & points

Draw crop marks

Although the size of the paper is 11x8.5 in., the paper will be trimmed by ½ inch on all four sides to create a page size of 10x7.5 in. Crop marks (also called *trim marks*) show the “live area” — the area which remains after the paper is trimmed by the printer (Figure 7-3).

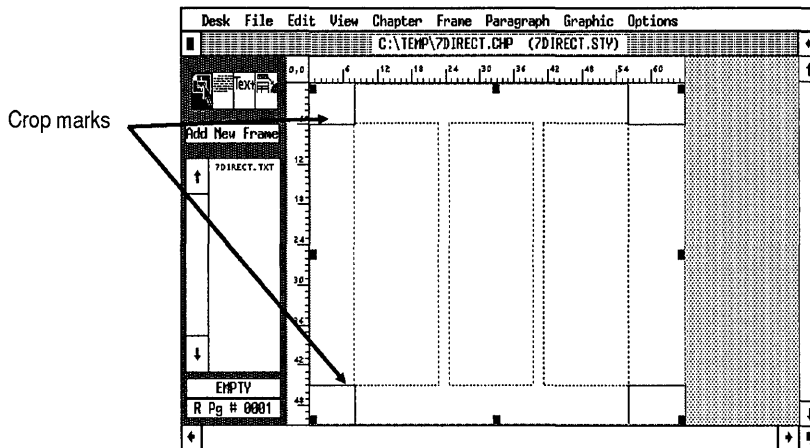

Figure 7-3.

You will create the crop marks in this project using the rectangle tool in Graphic mode. Then you will tell Ventura to repeat the graphic shapes on every page of the document. Before you draw the rectangle, plan the grid settings. Because you are trimming the paper ½ inch (03,00 picas) on each side, you will make the grid settings 03,00 picas & points. This grid setting guarantees that the crop marks will be exactly 03,00 picas from the edge of the Page.

- Reset the zero point to the upper left corner of the Page (click on the 0,0 square in the upper left corner of the screen).
- Enable Graphic mode. Then select the rectangle tool from the Side-Bar. Now set the grid for the Page.
- Grid Settings Grid Snap: On
Horizontal Spacing: 03,00 picas & points
Vertical Spacing: 03,00 picas & points
- Change to Normal or Enlarged View to draw the crop marks.
- Starting at position 0,0 picas on the ruler, use the rectangle tool to draw a 03,00 by 03,00 pica shape.

The grid settings force the rectangle into position (Figure 7-4).

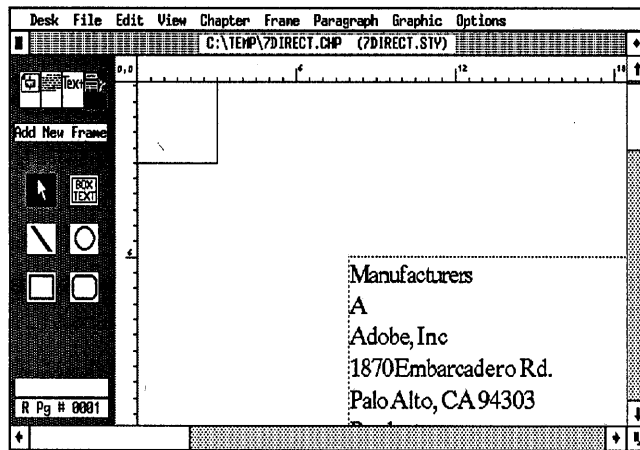

Figure 7-4.

➔ **NOTE:** If you draw the rectangle and the grid doesn't take effect, just set the grid again while the rectangle tool is highlighted.

Now change the line attributes.

- Line Thickness: Thin
Attributes End Styles: (Beginning and End) Square
Defaults: Save To

| | |
|--------------|---------------------|
| ■ Fill | Color: White |
| ■ Attributes | Pattern: Hollow |
| | Result: Transparent |
| | Defaults; Save To |

➔ *NOTE: You may have to experiment a few times before you get the hang of drawing shapes with a mouse. Keep trying until you master this new skill.*

Repeat the above steps to place crop marks at the other three corners. Your finished page should look like Figure 7-5:

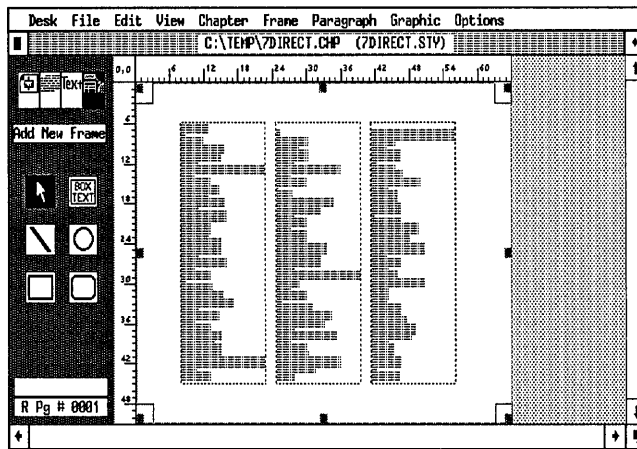

Figure 7-5.

Now that you've completed the crop marks for this page, you will make them repeat on every page of the directory.

- Choose Select All from the Graphic menu (or press Ctrl-Q) to select all the line shapes.
- Select Show On All Pages from the Graphic menu.

➔ *NOTE: You can also use Ventura's built-in crop mark feature from the To Print dialog box instead of drawing marks on the page.*

Although Ventura has a crop mark feature in the To Print dialog box, we taught you to draw your own crop marks as an alternate technique. Ventura's automatic crop marks are visible only on the printed page. They cannot be seen on the

screen, since they are not selected until print time. By contrast, if you draw the crop marks you can see them on the screen, which helps when you visualize the page design. To get Ventura's generated crop marks for this size directory you would have to *reduce the size of the Page* to 10x7.5 in. But reducing the size of the Page makes it harder to accomplish bleed effects like the thumb tabs in this chapter.

In general, Ventura's built-in crop marks are most useful when working with the Paper Type & Dimension: Half option from the Page Size & Layout dialog box, or for those who have a printer that creates pages larger than 8.5x11 in. In most other cases, we recommend drawing the crop marks yourself.

Build the footer

Headers and footers are vital to a good reference document. They help readers zero in on the facts. For instance, a phone book's header shows the first and last names on the page. A dictionary's header tells the first and last word on the page. Headers and footers that change from page to page are called *live headers* and *live footers*.

For this exercise, you will build a live footer that shows the first and last entries on each page. The commands to accomplish this effect are shown in Figure 7-6:

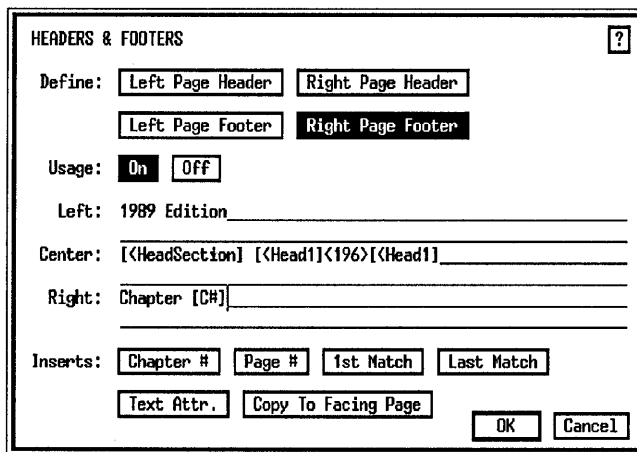

Figure 7-6.

Here are the steps for creating a live footer.

- Select Headers & Footers. Select Define: Right Page Footer, Usage: On.
- Move to the Left line and type: **1989 Edition**
- Move to the Center line and select Inserts: 1st Match. Delete the words “tag name” between the brackets (do not delete any of the brackets) and replace them with: **HeadSection**
- Next, use the right arrow key to move past the right bracket. Press the space bar to enter a space following the right bracket.

You have just given the 1st Match instruction. Ventura will look on every page and find the first paragraph tagged as HeadSection. It will display this paragraph in the footer. If it gets to a page and doesn't find a new HeadSection tag, it will use the one from a previous page.

- Select Insert: 1st Match again. Delete the words “tag name” and replace them with: **Head1**

This command tells Ventura to display the first occurrence of the Head1 tag in the center of the footer.

- Move past the right bracket and select Inserts: Text Attr. Delete the letter “D” between the brackets and replace it with: **196**

You just told Ventura to print an en dash (a dash the size of the letter n in the current font). The decimal code for an en dash is 196.

- Move past the right bracket and select Inserts: Last Match. Delete the words “tag name” and replace them with: **Head1**

This copies the last occurrence of Head1 to the center footer.

- Move to the Right line and type: **Chapter** followed by a space.
- Choose Inserts: Chapter #.

Now you will copy these settings to the left page and modify them slightly.

- Choose Inserts: Copy to Facing Page to copy the footer settings to the left page.
- Select Define: Left Page Footer, Usage: On. Move to the Right line, press Esc to clear the line, and type: **Desktop Publishing Directory** and click OK.

When you are finished, your page should look similar to Figure 7-7.

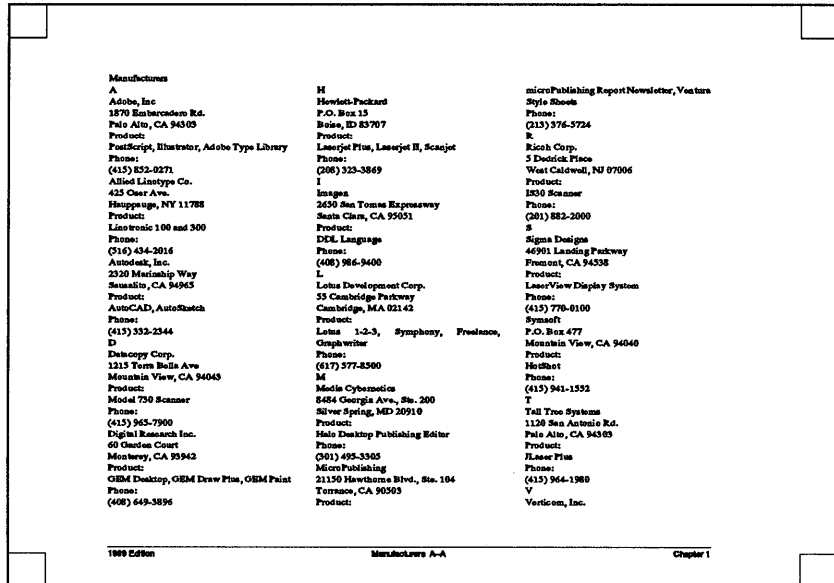

Figure 7-7.

Change the footer frame margins

When the paper is trimmed, it will later lose $\frac{1}{2}$ in. from each side. If you trimmed the page as it is, the footer text might get clipped off (Figure 7-8).

To raise the footer into the live area of the Page, you will change the top margin of the footer frame.

- Enable Frame mode and select the footer frame.
- Margins & Columns Top: 01,00 picas & points

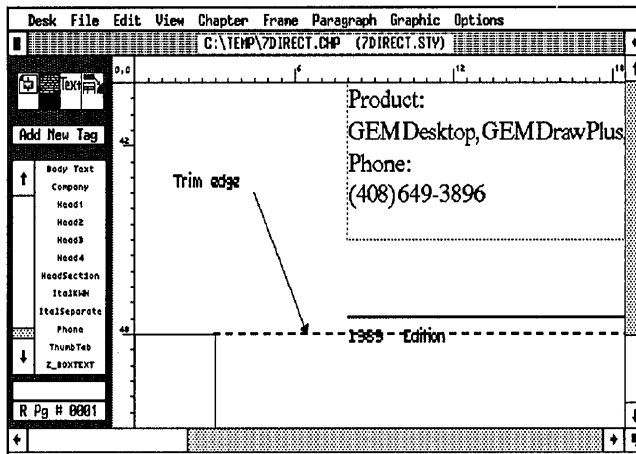

Figure 7-8.

Notice that the right and left margins of the footer are equal to the Page margins (Figure 7-9). You raised the footer text on the page by decreasing the top margin from 02,04 picas & points to 01,00 picas & points.

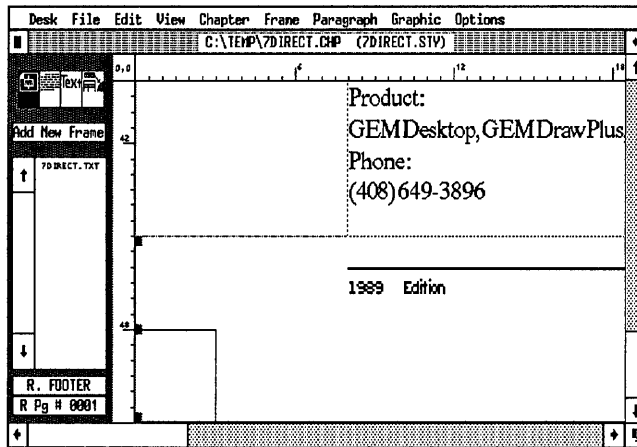

Figure 7-9.

➡ **TIP:** You can also change the position of headers and footers by changing the Above Spacing value in the Z_HEADER or Z_FOOTER tag (Spacing, Paragraph menu).

Spacing attributes are stored with the style sheet and can be reused if it is easier. Document attributes, such as footer margins, are stored with the chapter. They cannot be reused

unless you construct a chapter template (as described in Chapter Six). Sometimes, however, you cannot achieve the effect you want without changing the header or footer margins, especially if you have large trim margins — as is the case with this document.

Building new tags

Now that you’ve completed the changes to the Page, you are ready to format the tags. Start with the Body Text tag, then proceed through the document paragraph by paragraph.

Verify the Body Text tag

- Enable Paragraph mode.
- Select the paragraph “1870 Embarcadero Rd.” at the top of the page and check that the Body Text tag matches these settings:

| | |
|-------------|--|
| ■ Font | Face: Times Style: Normal Color: Black Size: 010.0 points |
| ■ Alignment | Horz. Alignment: Justified Overall Width: Column-Wide |
| ■ Spacing | Inter-Line: 12.00 fractional pts Add in Above: When Not At Column Top |

Build the HeadSection tag

The HeadSection tag uses a Ruling Line Above to create the reverse type effect. Later, in the picture section, we will show you how to achieve the same effect by placing white text in a solid black frame.

- ➔ *NOTE: Certain printers may not be able to print out white text on a black background. You can, however, achieve a similar effect using black text over a gray patterned rule (or frame). We will show you how to create both effects.*
- Select the first paragraph “Manufacturers.”

The tag name, HeadSection, appears in the Current Selection Box (Figure 7-10). Now change its font.

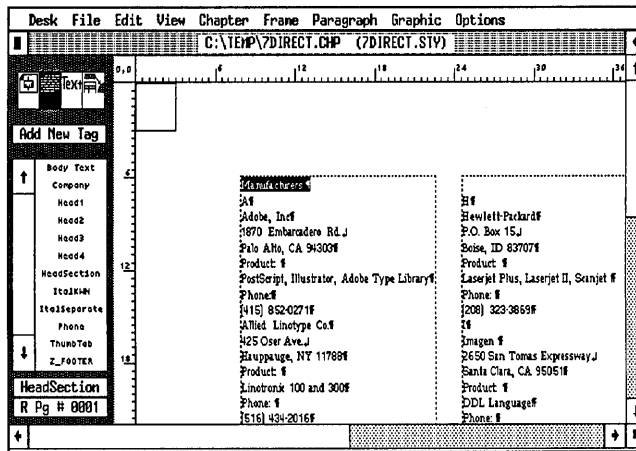

Figure 7-10.

■ Font Style: Bold
 Color: White
 Size: 024.0 points

Because you just made the text white, it is invisible against the white screen. But as soon as you drop a black background behind it, the text will become visible again.

■ Alignment Horz. Alignment: Center
 Overall Width: Frame-Wide

Frame-wide alignment forces the text to extend across all three columns.

■ Spacing Below: 24.00 fractional pts
 Inter-Line: 24.00 fractional pts
 Add in Above: Always

■ Breaks Page Break: Before/Until Right

This Page Break selection places a page break before every HeadSection tag. As a result, every section of the directory starts on a separate right-hand page.

➔ *NOTE: If you want the HeadSection tag to start on either a new right or a new left page, choose Page Break: Before instead of Before/Until Right.*

Create reverse type

Now you will create the reverse type effect with Ruling Line Above. The strategy behind this effect is simple: You make the type white and drop a black ruling line on top of it.

➡ *NOTE: If your printer is incapable of reverse type, follow the substitute procedures explained in the next section.*

You will start by giving Rule 1 a height larger than the type. In this example, HeadSection is 24.00 fractional pts and Rule 1 is 36.00 fractional pts. If you did nothing else, the rule would appear above the white type. You can, however, shift the rule downwards, by entering a negative value for the Space Below Rule 3. If you enter a positive value, Ventura *adds* space below the rule. If you enter a negative value, Ventura *subtracts* space so the rule shifts downwards.

➡ *TIP: Although it is called Space Below Rule 3, this measurement refers to the space below the last rule, whether that last rule is the first, second, or third.*

To calculate how many points to shift the rule down, use the following formula:

- Add the ruling line height and the font size
- Divide the sum by two

This formula vertically centers the text within the rule.

Here's the simple math for finding the Space Below Rule 3 in our example above:

- $36 + 24 = 60$ (fractional pts)
- $60 \div 2 = 30$ (fractional pts)

You would, therefore, make the Space Below Rule 3 equal to negative 30.00 fractional pts to center the type exactly in the middle of the rule. The formula, however, is only a starting point. In many cases, you will find it necessary to adjust the Space Below Rule 3 to create a more pleasing visual effect. For instance, in this example, you will use 34.00 fractional pts instead of 30.00 for the Space Below Rule 3. This places the text slightly above the center of the rule.

- Select Ruling Line Above. Choose Width: Frame. Give Rule 1 a height of 36.00 fractional pts. Make the Space Below Rule 3: 34.00 fractional pts. Choose the minus sign to shift the rule downwards (Figure 7-11).

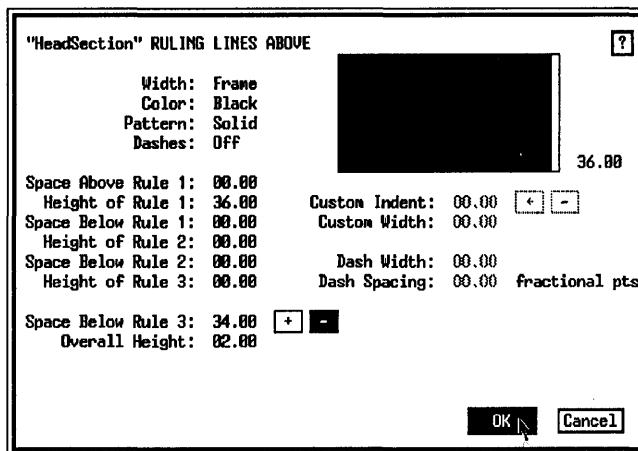

Figure 7-11.

If you cannot print reverse type

If your printer is incapable of reverse type, create black text on a gray rule instead. Use the same steps as above, but change the font color to Black and make the Ruling Line Above a gray pattern. For instance you would select:

- Font Style: Bold
Color: Black
Size: 024.0 points
- Select Ruling Line Above. Choose Width: Frame, Color: Black, Pattern: 3. Make the height of Rule 1: 36.00 fractional pts and the Space Below Rule 3: (minus) 34.00 fractional pts (Figure 7-12).

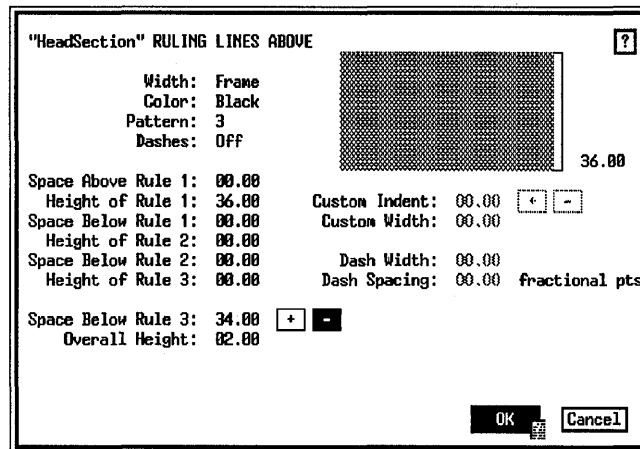

Figure 7-12. Without special add-on cards, printers such as the Hewlett-Packard LaserJet Series II cannot printer reverse type, but they can produce black text on a gray background.

Change the Head1 tag

The next paragraph to tag is Head1. You will use the method described above to create reverse type. Because the file was pretagged, every Head1 paragraph will be effected by the changes you make in the following step.

■ Select the paragraph "A" that was pretagged as Head1.

■ Font Style: Bold
 Color: White
 Size: 018.0 points

■ Alignment Horz. Alignment: Left
 In/Outdent Width: 00,06 picas & points

■ Spacing Above: 18.00 fractional pts
 Inter-Line: 18.00 fractional pts

To prevent Ventura from isolating the Head1 tag at the top or bottom of a page or column, you will choose Keep With Next: Yes from the Breaks dialog box.

■ Breaks Keep With Next: Yes

"Head1" BREAKS ?

Page Break: No Before After Before & After
 Before/Until Left Before/Until Right

Column Break: No Before After Before & After

Line Break: No Before After Before & After

Next Y Position: Normal Beside Last Line of Prev. Para

Allow Within: Yes No

Keep With Next: Yes No

OK Cancel

Create the ruling line above

Now you will create a black ruling line above the Head1 tag and move it down over the white type. This time you will make the rule a custom width so it is confined to a smaller space within the column.

- Select Ruling Line Above. Choose Width: Custom. Give Rule 1 a height of 24.00 fractional pts. Make the Space Below Rule 3 (minus) 24.00 fractional pts. Then make the Custom Width 24.00 fractional pts.

"Head1" RULING LINES ABOVE ?

Width: Custom 36.00
 Color: Black
 Pattern: Solid
 Dashes: Off

Space Above Rule 1: 00.00
 Height of Rule 1: 24.00
 Space Below Rule 1: 00.00
 Height of Rule 2: 00.00
 Space Below Rule 2: 00.00
 Height of Rule 3: 00.00
 Space Below Rule 3: 24.00 + -
 Overall Height: 00.00

Custom Indent: 00.00 + -
 Custom Width: 24.00
 Dash Width: 00.00
 Dash Spacing: 00.00 fractional pts

OK Cancel

➔ *NOTE: The centering formula would indicate a negative space of 21 fractional pts ($18 + 24 = 42$. $42 \div 2 = 21$). We have increased the Space Below Rule 3 setting by 03.00 fractional pts to raise the text slightly above the center line of the rule.*

If you cannot print reverse type

To make black text on a gray rule, change the font color to Black and the rule Pattern to 3.

Change the Head2 tag

Now you will change the Head2 tag.

■ Select the paragraph "Adobe, Inc."

■ Font Style: Bold

■ Alignment Horz. Alignment: Center

■ Spacing Above: 12.00 fractional pts
Below 12.00 fractional pts
Inter- Line: 14.00 fractional pts

The space below separates the title from the entries below.

■ Breaks Keep With Next: Yes

Keep With Next prevents the title from being isolated at the top or bottom of a column or page.

■ Select Ruling Line Above. Choose Width: Column. Give Rule 1 a height of 02.00 fractional pts. Make the Space Below Rule 1 02.00 fractional pts (Figure 7-13).

■ Select Ruling Line Below. Choose Width: Column. Make the Space Above Rule 1 02.00 fractional pts, then give Rule 1 a height of 00.50 fractional pts (Figure 7-14).

Change the Head3 tag

■ Select the paragraph "Product."

■ Font Style: Bold

■ Alignment Horz. Alignment: Left

■ Breaks Keep With Next: Yes

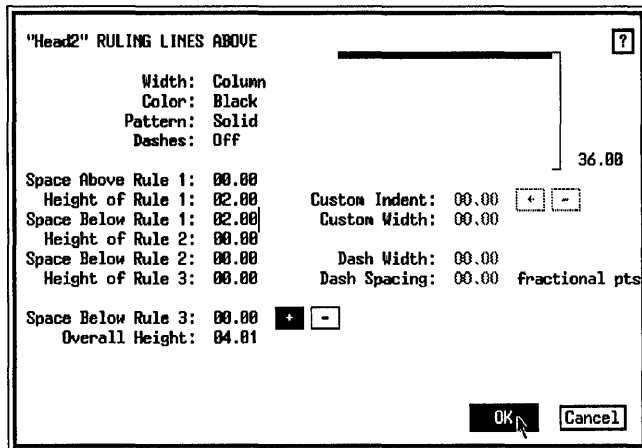

Figure 7-13.

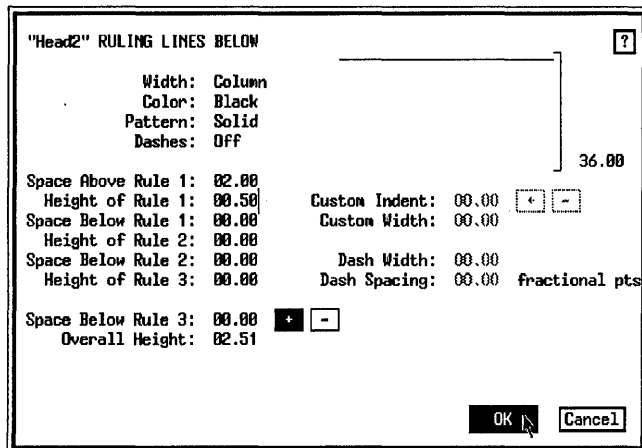

Figure 7-14.

The Breaks dialog box accomplishes two things. Line Break Before allows another tag to reside on the same line. Keep With Next: Yes keeps the listing from being separated from the following tag.

Change the ItalKWN tag

- Select the paragraph "PostScript, Illustrator, Adobe Type Library."

The tag name ItalKWN (short for Italics Keep With Next) appears in the Current Selection Box.

- Font Style: N-Italic
- Alignment Horz. Alignment: Left
In/Outdent Width: 00,06 picas & points
Relative Indent: On

Relative Indent: On positions the tag next to the previous paragraph.

- Breaks Line Break: After
Keep With Next: Yes

Line Break: After allows the ItalkWN tag to reside on the same line as the previous tag.

Change the Italseparate tag

The next tag encountered is Italseparate. It is identical to the ItalkWN tag, except that Keep with Next is set to No in the Breaks menu. Choosing No permits Ventura to split the text to a new column after the tag.

- Select the paragraph “(415) 852-0271.”

- Font Style: N-Italic
- Alignment Horz. Alignment: Left
In/Outdent Width: 00,06 picas & points
Relative Indent: On
- Breaks Line Break: After
Keep With Next: No



Stopping point

Here’s the stopping point for the chapter. Take a moment to save your work and relax. You should also congratulate yourself for all the progress you are making. Before you continue, check to make sure your document matches Figure 7–15.

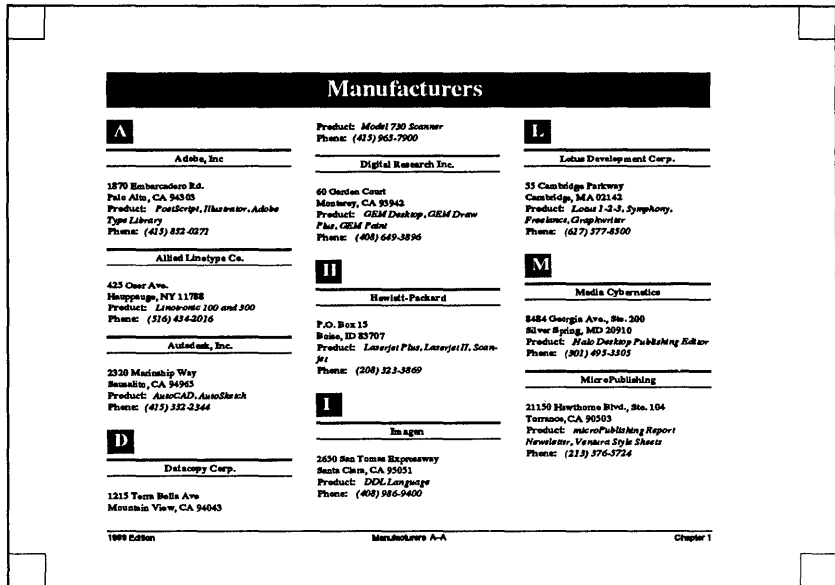

Figure 7-15. Your document should look similar to this illustration at this stage of the project.

If you don't have time to continue, quit Ventura and come back later. Simply open the chapter C:\TEMP\7DIRECT.CHP and jump right into the pictures section.

You are now ready to proceed with the pictures section. If you plan to continue without a break, proceed directly to the next section.

Pictures

Now that you have finished the style section, you are ready to make the thumb tabs. As explained earlier, thumb tabs make it easier to find different sections of a directory. You will create the thumb tabs with repeating frames. As the name implies, a repeating frame shows up on every page of the document. Before you draw the thumb tabs you must do two things:

1. Determine how high the thumb tab should be.

For the three-section directory, the height of each thumb tab will be $\frac{1}{3}$ of the total column height, or 13,00 picas & points (Figure 7-16).

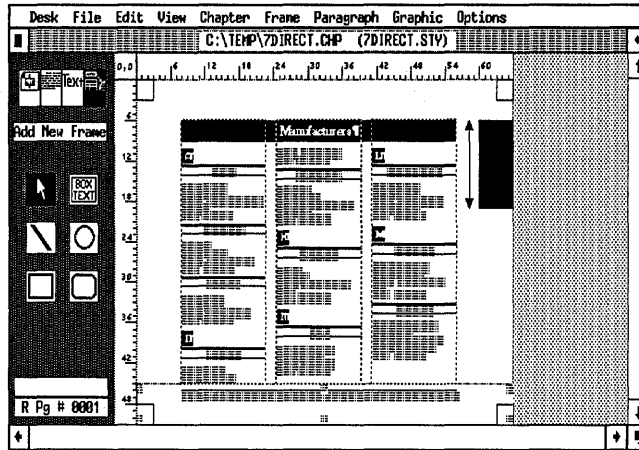

Figure 7-16.

2. Calculate how wide the thumb tab should be.

You will make the thumb tab wider than necessary, so it will bleed off the edge of the paper. Since the margin from the live area to the trim edge is 03,00 picas & points, you could make the thumb tab 04,00 or 05,00 picas & points — anything larger than 03,00 picas & points will extend past the trim area. It is easier to position if you use a six-pica frame. Then you can line it up with the top column guide and the edge of the paper for perfect alignment.

Create the thumb tab frame

- Enable Frame mode. Select Add New Frame from the Side-Bar.
- Make sure the zero point is reset to the upper left corner of the Page. (Click the 0,0 square at the upper left corner of the Page.)
- Starting at position 60 picas on the horizontal ruler and 6 picas on the vertical ruler, draw a thumb tab frame 06,00 picas wide by 13,00 picas high. You may want to change to Normal View to draw the frame (Figure 7-17).

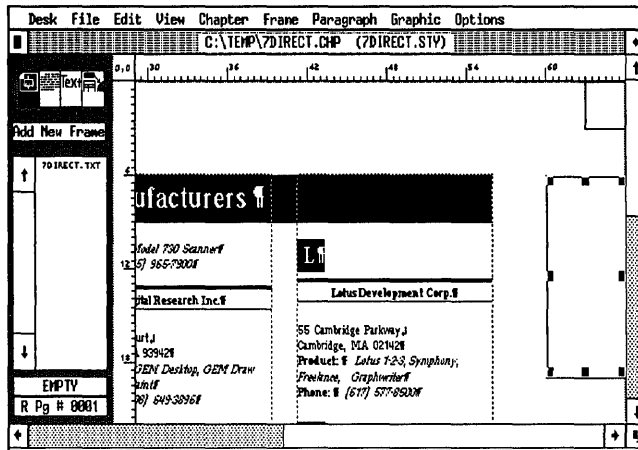
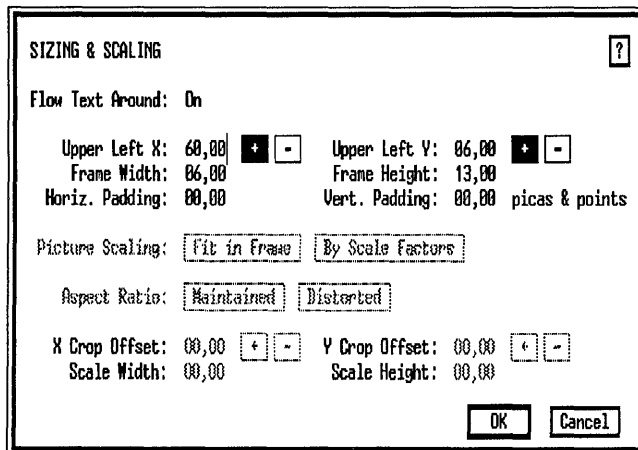

Figure 7-17.

Verify the position and size of the frame with the Sizing & Scaling dialog box.



Add a frame margin

By adding a right margin inside the thumb tab frame, you will center the text inside the three-pica area that remains *after trimming*. Without the right margin, the text would be centered inside the full six-pica width — and part of it would get trimmed off by the printer.

- With the thumb tab frame still highlighted, select Margins & Columns. Make the right margin 03,00 picas & points.

| MARGINS & COLUMNS | | | |
|-------------------|---|--|----------------------------|
| # of Columns: | <input checked="" type="checkbox"/> 1 | <input type="checkbox"/> 2 | <input type="checkbox"/> 3 |
| | <input type="checkbox"/> 4 | <input type="checkbox"/> 5 | <input type="checkbox"/> 6 |
| | <input type="checkbox"/> 7 | <input type="checkbox"/> 8 | <input type="checkbox"/> ? |
| Settings For: | <input checked="" type="checkbox"/> Left Page | <input type="checkbox"/> Right Page | |
| | Widths | Gutters | Margins |
| Column 1: | 03,00 | 00,00 | Top: 00,00 picas & points |
| 2: | 00,00 | 00,00 | Bottom: 00,00 |
| 3: | 00,00 | 00,00 | Left: 00,00 |
| 4: | 00,00 | 00,00 | Right: 03,00 |
| 5: | 00,00 | 00,00 | |
| 6: | 00,00 | 00,00 | |
| 7: | 00,00 | 00,00 | Calculated Width = 06,00 |
| 8: | 00,00 | 00,00 | Actual Frame Width = 06,00 |
| Inserts: | <input checked="" type="checkbox"/> Make Equal Widths | <input type="checkbox"/> Copy To Facing Page | |
| | <input type="button" value="OK"/> | <input type="button" value="Cancel"/> | |

Add a page number to the thumb tab frame

To make the vertical text within the frame, you will use line breaks as spacers after each letter in the word.

■ Enable Text mode and type within the thumb tab frame:

```
[Ctrl-Enter]
[Ctrl-Enter]
[Ctrl-Enter]
M [Ctrl-Enter]
f [Ctrl-Enter]
g [Ctrl-Enter]
s [Ctrl-Enter]
[Ctrl-Enter]
```

Now you will insert a page number inside the thumb tab frame with the Ins Special Item option (Edit menu). With the text cursor still at the bottom of the thumb tab:

- Select Ins Special Item from the Edit menu (or press the keyboard shortcut Ctrl-C).
- Choose Reference or press the F6 key.
- When asked if you wish to insert a reference to the current page or chapter number, choose Page #. The number 1, preceded by a degree symbol appears in the thumb tab frame.

By inserting a page number reference in the frame, Ventura displays the current page number in the thumb tab. If you turn on Show Tabs & Returns (Options menu) you can see the Reference marker (a degree symbol) at the bottom of the frame. The word "Reference" is displayed in the Current Selection Box (Figure 7-18).

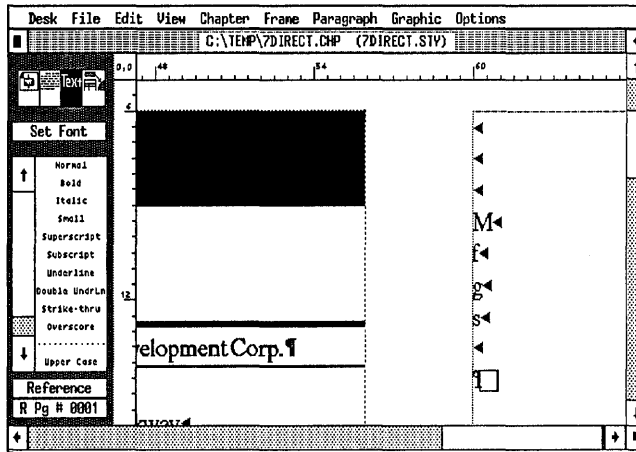

Figure 7-18.

➔ **NOTE:** Like other text attributes, you can cut, copy and paste a page reference using Ventura's editing tools.

Now you will tag the thumb tab text to make it white.

- Enable Paragraph mode. Select the letters "Mfgs" and tag them as ThumbTab.

The white text is invisible against the screen until you change the frame background.

Change the frame's fill pattern

Now you will change the frame's fill pattern to solid black.

- Enable Frame mode and select the thumb tab frame.
- Select Frame Background from the Frame menu. Choose Color: Black and Pattern: Solid.

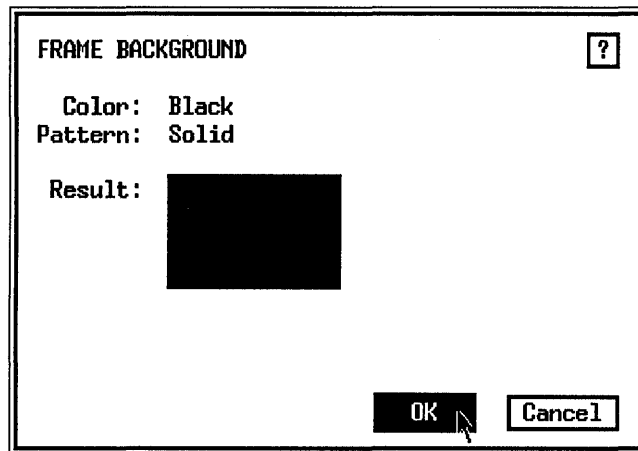

➔ **NOTE:** If you cannot print white text on solid black, make the text color black and the frame background pattern gray.

The thumb tab should look like Figure 7-19:

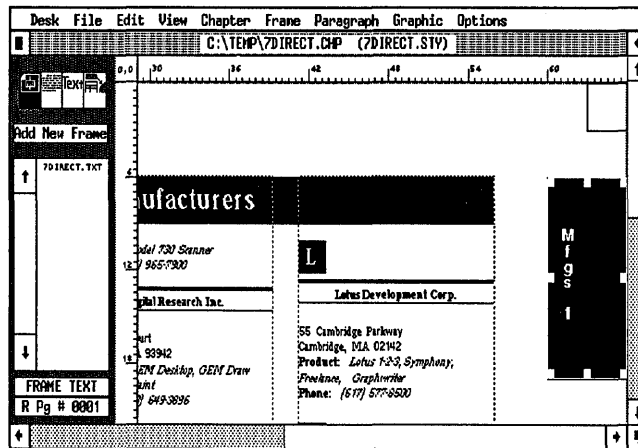

Figure 7-19. The completed thumb tab.

Copy the thumb tab frame

Now you will make a copy of the frame to place on the second page of the directory.

- With the thumb tab frame still selected, copy it into the clipboard (press Shift-Del).

Be sure to make this copy before taking the next step. You will need to paste in this frame on page two.

Change the thumb tab frame to a repeating frame

To make the thumb tab repeat on every right page, turn it into a repeating frame.

- While the thumb tab frame is still selected, select Repeating Frame from the Frame menu. Choose For All Pages: Right, On Current Page: Show This Repeating Frame.

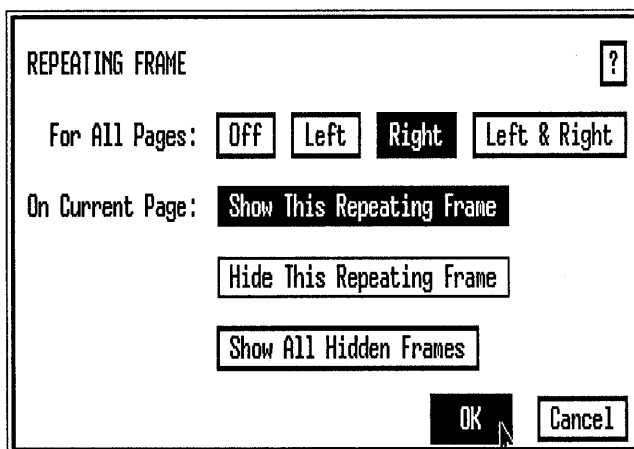

- ➔ **NOTE:** You cannot copy, delete, or change a repeating frame. To change a repeating frame, first return it to normal, then make the changes, then make it a repeating frame again.

Create a thumb tab for the left page

Thumb tabs gain part of their effectiveness because they sit back-to-back on both sides of a page. This creates a black area that can easily be seen along the edge of the document. To mirror the thumb tab from the first page, you will paste the copy onto page two, then move it into its new position.

- Press PgDn to go to page two.
- Press the Ins key or select Paste from the Edit menu.

The thumb tab frame will appear in the same position it had

on the first page. Now move it to the left page margin, as shown in Figure 7-20.

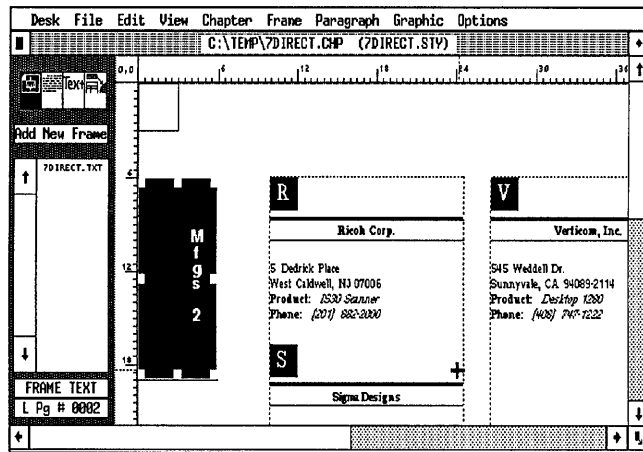
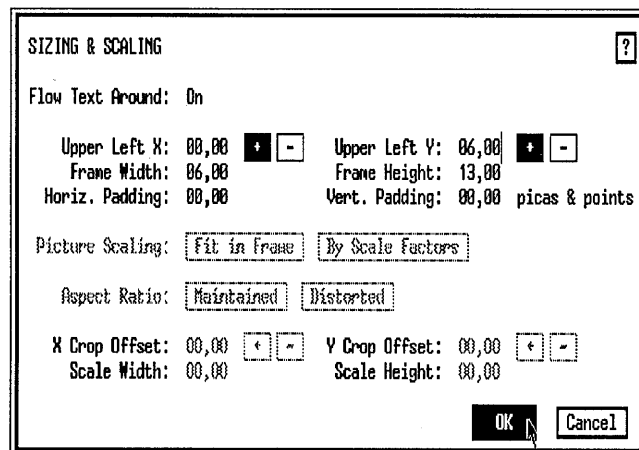

Figure 7-20.

Use Sizing & Scaling to position the frame accurately. Otherwise, the two frames may not line up back-to-back.

- Select Sizing & Scaling. Make the Upper Left X: (+) 00,00 picas & points and the Upper Left Y: (+) 06,00 picas & points.



Verify frame margins

Check the frame margins so the text is properly centered within the tab. (The margins should be the mirror opposites of the margins for the right page.)

- | | |
|------------------------|---|
| ■ Margins & Columns | Left: 03,00 picas & points Right: 00,00 picas & points |
|------------------------|---|

Make the left page thumb tab a repeating frame

As you did on page one, make the left page thumb tab a repeating frame.

- | | |
|-----------------------|--|
| ■ Repeating Frames | For All Pages: Left On Current Page: Show This Repeating Frame |
|-----------------------|--|

Create a chapter template

Now that you've formatted the first section of the directory, you can use it to create a blank template. Normally we would teach this technique in the chapter section. However, we want you to practice starting with a template. As you will see, a template speeds production by eliminating the need to rebuild headers and footers.

Save your chapter with its existing name before turning it into a template.

- Press Ctrl-S.

Now you will remove the text file from the Page and save the chapter under a new name to make a copy, which you will turn into a template.

Remove the text file

- Enable Frame mode. Select the Page.
- Select Remove Text/File from the Edit menu. Choose Remove from: List of Files.

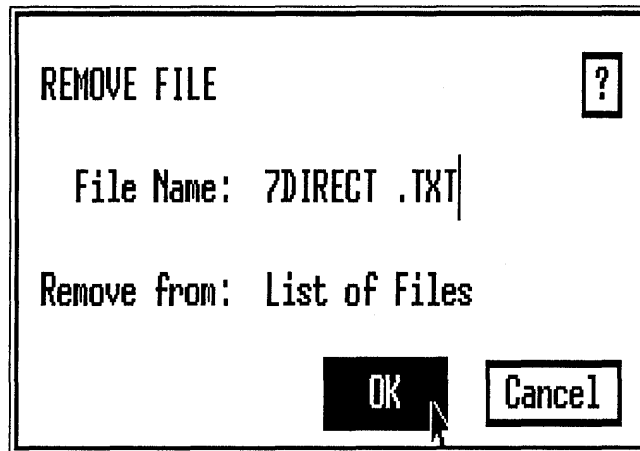

Ventura removes the text file 7DIRECT.TXT from the Assignment List.

- Select Save As from the File menu. Save the chapter as C:\TEMP\DIRPLATE.CHP.

You just made a template — an “empty” chapter. Now you are ready to use it to create the next section of the directory.

- *NOTE: If you had selected Save As while the text file 7DIRECT.TXT was still on the Page, Ventura would have automatically renamed and relocated the text file to DIRPLATE.TXT.*

Load text into the template

Load the text for the second section. Since the text is pretagged and all the tag definitions are present in the style sheet, the document is formatted as soon as you load it.

- Make sure the Page is selected.
- Load and place the text file 7CATEGORY.TXT from the C:\POWER subdirectory.

- *NOTE: If you don't have the Power disk, remember that you will have to create this file in advance.*

The text flows onto the Page.

Rename the text

- While the Page is still highlighted, select File Type/Rename from the Edit menu. Rename the text file as C:\TEMP\7DIRECT2.TXT.
- Use Save As to save the new chapter as C:\TEMP\7DIRECT2.CHP.

By saving under a new name, you preserve the template in its original form. The empty template can be used over and over again to create additional directory sections.

Change the thumb tab

The thumb tab for the second section of the directory will be shifted down so it aligns with the bottom edge of the first tab.

To make a copy of the original thumb tab, select the frame and change it from a repeating frame to a normal frame (remember, you cannot copy a repeating frame).

- Select the thumb tab frame. Select Repeating Frame from the Frame menu. Choose For All Pages: Off.

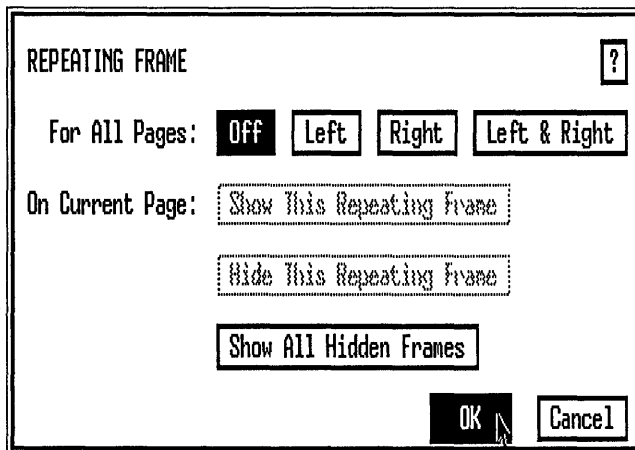

Now you are ready to copy the frame.

WARNING: Do not delete the original frame until you place the copy. You will use the original as a guide to line up the second thumb tab.

- Select Copy from the Edit menu (or press Shift-Del).

Now you will paste a copy on top of the original.

- Press the Ins key or select Paste Frame from the Edit menu.

Move the frame into place below the first thumb tab, so the top edge aligns with the bottom edge of the original (Figure 7-21).

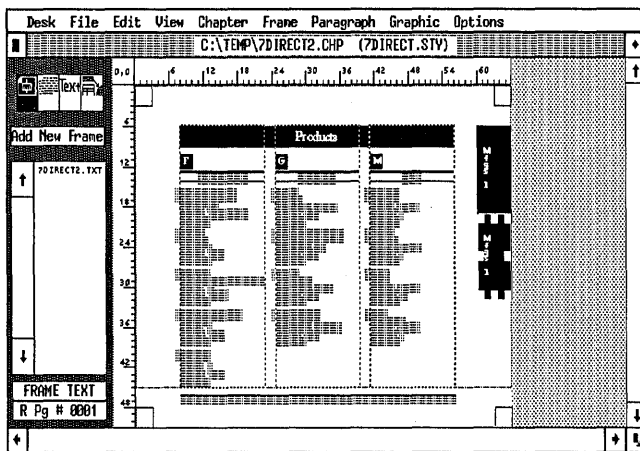

Figure 7-21.

Once the frame is properly placed, delete the original.

- Select the top frame and press Del.
- Select Repeating Frame from the Frame menu. Choose For All Page: Right and On Current Page: Show This Repeating Frame. Then click OK.

Now you will change the text in the frame to read "Products."

- Enable Text mode. Delete the text *but do not delete the page reference symbol* (°) from the frame.
- Now type:

[Ctrl-Enter]
P [Ctrl-Enter]
r [Ctrl-Enter]
o [Ctrl-Enter]
d [Ctrl-Enter]
u [Ctrl-Enter]
c [Ctrl-Enter]
t [Ctrl-Enter]
s [Ctrl-Enter]
[Ctrl-enter]

➡ *NOTE: If you delete the page number by mistake, reinsert another page reference. Select *Ins Special Item* (Edit menu). Choose *Reference then Page #* (See the section “Add a page number to the left thumb tab frame” in this chapter).*

Make a second thumb tab on page two

Go to the next page and repeat the previous instructions to create a second thumb tab.

2. Select the left thumb tab frame.
3. Make it a non-repeating frame.
4. Copy it to temporary memory.
5. Paste a copy on top of the original.
6. Move the new frame into place below the first thumb tab, so the top edge aligns with the bottom edge of the original.
7. Delete the original once the frame is properly placed.
8. Make it a repeating frame again.
9. Change the text in the frame to read “Products” and leave the page reference as is.

When you are finished your screen should look like Figure 7-22 for page two.

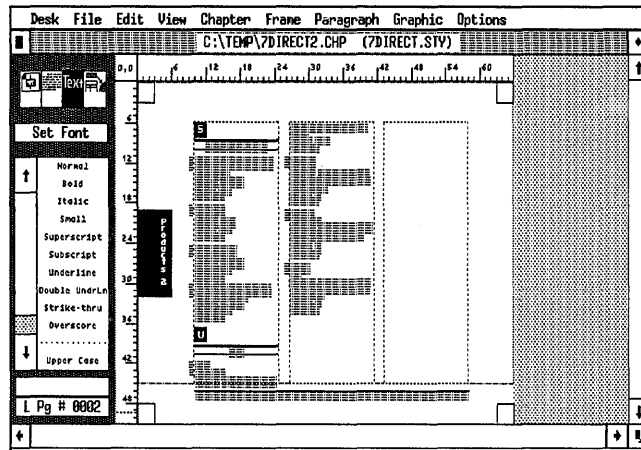

Figure 7-22. Page two of the completed directory.

Because of space limitations, we will not show you how to complete the third section of the directory. You would, however, use the identical steps and methods.

Chapter

In this section, you will renumber the chapters, place both sections into a publication and print the publication.

Update the page counter

You will now use the Update Counters option to renumber the second chapter to start on page three. (In this teaching example, the first chapter was only two pages long. Normally, it would be much longer. Nevertheless, the principles are the same.) Ventura can link the page numbers across chapters in a publication. Once you make a publication in the Multi-Chapter dialog box (Options menu) you will renumber the chapters so that the second chapter starts on the next page number after the previous chapter.

- Press Home to go to page one of the chapter 7DIRECT2.CHP.
- Select Update Counters from the Chapter menu. Choose Which Counter: This Page, Update Method: Previous Number + 1, Number Format: 1,2. Then click OK.

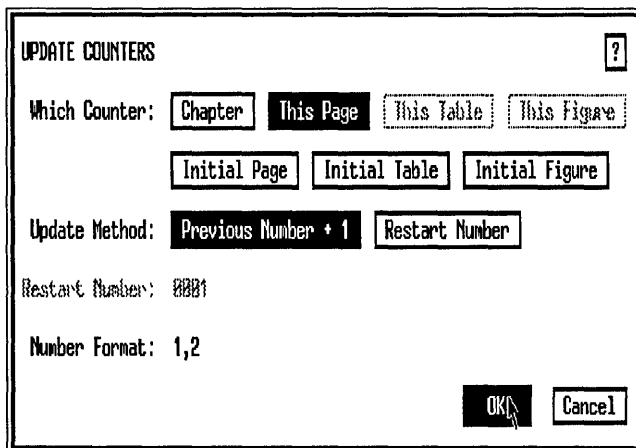

You will not actually see the new page numbers until you perform the renumber operation in the Multi-Chapter dialog box.

Since the directory is composed of two chapters, you can use Ventura's Multi-Chapter function to print both at once. First you will put both chapters into a publication. Then you will renumber the chapters. Finally, you will use the Print option from the Multi-Chapter dialog box to print both chapters with a single command. Although you are using only two chapters in our example, you can use this same technique to print many chapters at once.

■ Select Multi-Chapter from the Options menu.

➔ *NOTE: If you have made any changes, Ventura asks if you want to Save or Abandon. Choose Save.*

Create a new publication

■ Select New from the Multi-Chapter dialog box.

Add the two chapter names from this project to the publication.

■ Select Add Chapter. Select C:\TEMP\7DIRECT.CHP from the Item Selector.

The chapter appears at the top of the Multi-Chapter dialog box.

Now add the next chapter.

- Select Add Chapter again. Select C:\TEMP\7DIRECT2.CHP from the Item Selector.

Ventura returns you to the dialog box and displays the two chapter names (Figure 7-23).

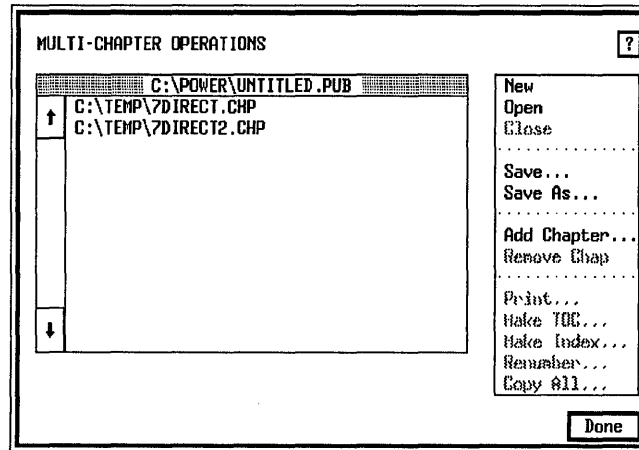
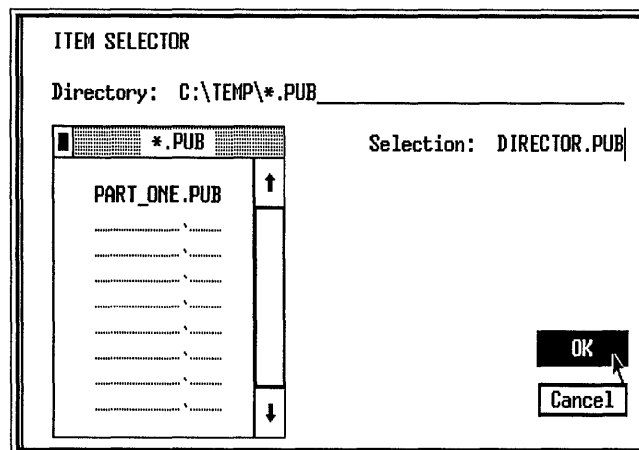

Figure 7-23.

Now you are ready to save the chapters as a publication.

- Select Save As from the Multi-Chapter dialog box. If necessary, use the Backup button to locate the C:\TEMP sub-directory. Then save the publication as C:\TEMP\DIRECTOR.PUB.



The publication name appears in the Multi-Chapter menu bar. Once the publication is created, you can renumber it.

➤ *NOTE: If a single chapter is highlighted in the list, Ventura will not be able to perform the renumber operation.*

■ Choose Renumber from the Multi-Chapter dialog box.

■ When asked if you want to renumber chapters, pages, tables, and figures across the entire publication, choose Renumber.

Ventura displays a message telling you it is renumbering all the chapters in the publication.

After the publication is renumbered, you are ready to print.

■ While still in the Multi-Chapter dialog box, select Print. Choose All, Last to 1st.

➤ *NOTE: If your printer puts out pages printed-side down, choose 1st to Last instead.*

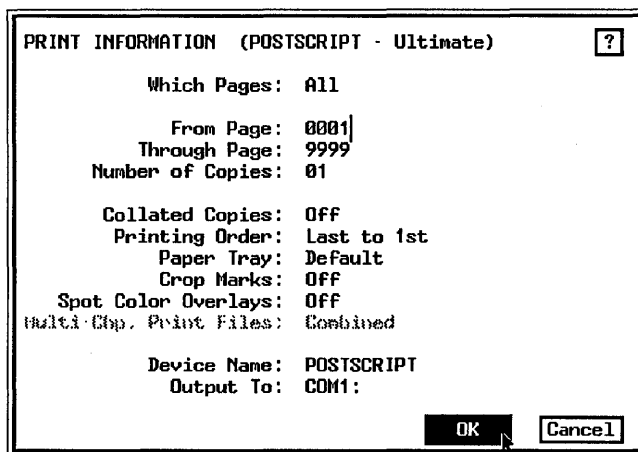

Ventura prints out both chapters, one after another. When you are finished, select Done to return to the work space.



Tips and techniques

Pretagging tips

- Always use the format @TAGNAME = . Make sure the tag name is the first thing in the paragraph.
- Ventura assumes that any paragraph without a tag name is Body Text.
- The tag name must precede the rest of the paragraph. Ventura applies the tag name until it encounters a hard carriage return (¶). Then it switches back to Body Text, or to the next tag name.
- Put the @ sign in the left margin. If the @ sign is any other place in the text file, it will not be recognized as part of the tag code.
- Tag names are not case-sensitive. Ventura doesn't recognize any difference between upper and lower case.
- Always match the tag name in the text file with the tag name in the current style sheet. Ventura recognizes *any* minor mismatch between tag names, including spaces. For instance, CHAP # and CHAP# would be listed as two separate tags in the Assignment List.
- When Ventura finds tag names in the text file that are not part of the current style sheet, it lists them in the Assignment List in uppercase and displays them on the screen with Body Text attributes.
- Use the @PARAFILTR = tag to strip out double carriage returns in a document. This allows you to retain normal spacing (two carriage returns between paragraphs) for readability in the text file, but strips out the extra returns when you bring the file into Ventura.
- Tags added in Ventura with Paragraph mode will be saved back to the original text file when the chapter is saved.
- When producing files in ASCII format, make sure to enter two carriage returns between each paragraph.
- The fastest way to format a text generated from a database is to include the tag names in the text file.

Other tips

- You can create crop marks manually by drawing line shapes on the Page. To repeat them on every page of the document, choose Show On All Pages from the Graphic menu. You can also use Ventura's built-in crop marks in the print option. Use the automatic crop marks when you are creating half-size pages, or if you have a printer that can print larger than 8.5x11 in. format.
- You can create live headers and footers that change from page to page throughout the document in the Headers & Footers dialog box. If you select 1st Match, Ventura places the first occurrence of the tag in the header (or footer). If you select Last Match, Ventura places the last occurrence of the tag into the header (or footer). If Ventura doesn't find the tag on a page, it uses one from a previous page.
- Initially, the frame margins of headers and footers are set to vertically center the header. You can raise or lower the header or footer by changing the frame margins (in Margins & Columns) or by changing the space above or below (in Spacing). The spacing attributes are stored with the style sheet and therefore can be reused. The header and footer frame margins are stored with the chapter and can only be reused by creating a chapter template.
- A reverse type effect can be created by placing white text in a black frame, or by dropping a solid black rule down over white text. If you want to use reverse text as a predominant effect in your style sheet, it's best to make it as a tag using the rule above technique.
- Some non-PostScript printers cannot print white type on a black background. Substitute black type on a gray background.
- Space Below Rule 3 refers to the space below the last rule in the tag (or frame), whether that last rule is the first, second or third. If you enter a positive value the Ventura adds space below the rule and the rule shifts upwards. If you enter a negative space, Ventura subtracts space below the rule, so it shifts downwards.
- The Breaks option Keep With Next can be used to keep tags from being isolated at the top or bottom of a column or page.

- When you turn select the Relative Indent:On in the Alignment dialog box, Ventura makes the first line indent equal to the length of the last line in the previous paragraph. When this is used in combination with the Breaks option, you can make two tags reside on the same line side-by-side.
- To make a thumb tab that repeats on every page of the document, use a repeating frame.
- You can insert a page number anywhere on the page including captions, frames, and Box Text with the Ins Special Item option.
- Once you make a frame into a repeating frame you cannot cut or delete it. Change it back to a normal frame with the Repeating Frame dialog box if you need to make changes.
- Multi-Chapter allows you to combine a list of chapters together into a publication. Once the publication is created, you can print all the chapters at once.
- Once you create a publication you can renumber the chapters so the page numbers follow sequentially from chapter to chapter. Open a chapter and use Update Counters to update the initial page to Previous + 1. The new page numbers will not be displayed until you choose Renumber from the Multi-Chapter dialog box.

Chapter Eight Skills Checklist

Theory

- The parts of a book

Text

- Inserting footnote references
- Adding footnote text
- Working with true typographic fractions
- Inserting index entries
- Changing the attribute overrides
- Preparing text for vertical tabs (side-by-side paragraphs)

Style

- Using a half-size page layout
- How to update the page and chapter counters
- Understanding widows and orphans
- Creating a table with side-by-side paragraphs
- How to use spacing and breaks to create multiple columns
- Adding a big first character to the lead-in paragraph

Chapter

- Creating and printing a publication
- Rearranging the chapter list
- Renumbering a publication
- Generating a table of contents
- Creating an index
- Printing crop marks

Chapter Eight

A Book

For book publishers large and small, Ventura can mean faster production and lower costs. In this chapter you will learn the special Ventura skills that apply to long documents. You may need to make a few changes to your current production practices to accommodate the realities of working with Ventura.

Theory

There are three parts to a traditional book: the front matter, the main text, and the back matter. Each section has its own format and style, but all three work together to complement the overall design. It is tempting to put the entire book into one large chapter file. For easier production, however, we recommend a separate Ventura chapter for each book chapter, plus separate Ventura chapters for the front and back matter.

Preformatting text files in advance can help reduce the bottlenecks that typically occur in the book production cycle. By establishing standard tag names and using bracket codes, authors and editors can format as they write.

Before

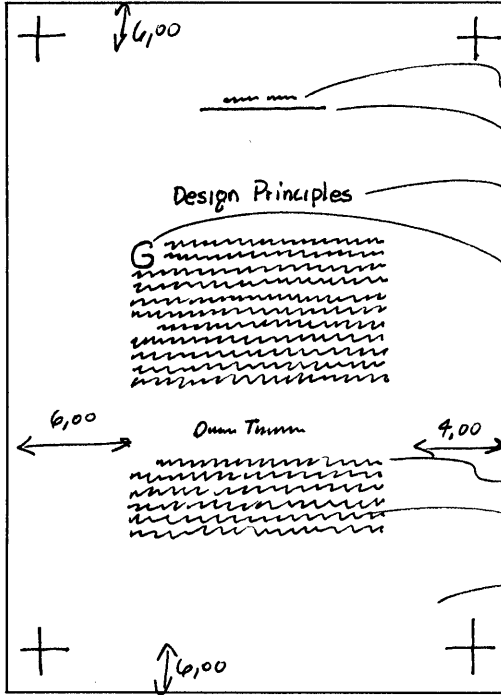

- ITALIC
- 14pt TIMES BOLD CENTERED
- 1pt RULE X 12,00 PICA CENTERED
- 30pt TIMES BOLD CENTERED
- 30pt TIMES BOLD DROP CAP
- 1ST LINE INDENT 1,00 PICA
- TEXT 12pt TIMES
14pt INTERLINE SPACING
- 1/2 PAGE FORMAT
5 1/2 X 8 1/2

After

Chapter Six

Design Principles

Getting top-quality books from a desktop publishing system requires special know-how in two areas: design and printing. This chapter discusses the theory of design. The following chapter, Chapter Seven, outlines the steps to take before going to a commercial printer.

This chapter offers comments on the principles of book design as they apply to desktop publishing. In some cases, the realities of desktop publishing force changes from traditional methods.

Design Terminology

If you're new to page design and typography, you'll need to learn a few words. You'll encounter this vocabulary over and over again in software manuals and in conversations with graphic designers and commercial printers. This specialized terminology applies to three

Planning the book

For the example in this chapter, you will use the 5.5x8.5 in. *half-size* format. This size lends itself to text-intensive books with only a few illustrations. It is easy and economical to produce; it is easy to bind (either perfect, sewn or saddle-stitched); and it fits nicely in your hand. In the corporate environment, this format is especially useful for in-house booklets and software documentation.

The page design taught in this chapter is quiet and understated. It has large right and left margins with a generous amount of space separating the chapter title and subheads from the Body Text. The use of white space conveys an open feeling and makes the page more readable. Single horizontal rules separate the header and index title from the rest of the Body Text.

In this project, you will use several special Ventura long-document features:

- Generating a table of contents
- Generating an index
- Inserting footnotes and fractions
- Big first character
- Vertical tabs (side-by-side paragraphs)
- Changing chapter and page counters
- Printing crop marks

To learn these long document techniques, you will work with four chapters in all: one for a table of contents, two main text chapters, and one for an index.

Ventura prep



If you have the Power disk

- Load the ASCII text files 8TBL.TXT and 8DESIGN.TXT from the C:\POWER subdirectory. Using File Type/Rename from the Edit menu save and rename them respectively as C:\TEMP\8TABLE.TXT and C:\TEMP\8BOOK.TXT. When you are finished, the file 8BOOK.TXT should be on the Page.

➔ *NOTE: Do not load the file 8PRINT.TXT. It will be used later in the project.*

Since there are no pictures to place in this document, load the proper style sheet.

- Load the style sheet 8DESIGN.STY from the C:\POWER subdirectory and save it under the name C:\TEMP\8BOOK.STY.
- Save the chapter as C:\TEMP\8BOOK.CHP.



If you do not have the Power disk

- In your word processor, rename any two existing text files as 8BOOK.TXT and 8PRINT.TXT. Save them in the C:\TEMP subdirectory. Choose files of more than five pages if possible. (If you have the time and the energy you can type in the two text files for Chapter Eight from Appendix A.) Then type in the file 8TABLE.TXT from Appendix A and save it in the C:\TEMP subdirectory.
- Load the &BOOK-P1.STY style sheet from the C:\TYPESET subdirectory and save it as C:\TEMP\8BOOK.STY.
- Format the style sheet to match Figure 8-1. Then use the tag table in Appendix B to format the necessary tags.
- Select Save As from the File menu to save the chapter under the name and location C:\TEMP\8BOOK.CHP.

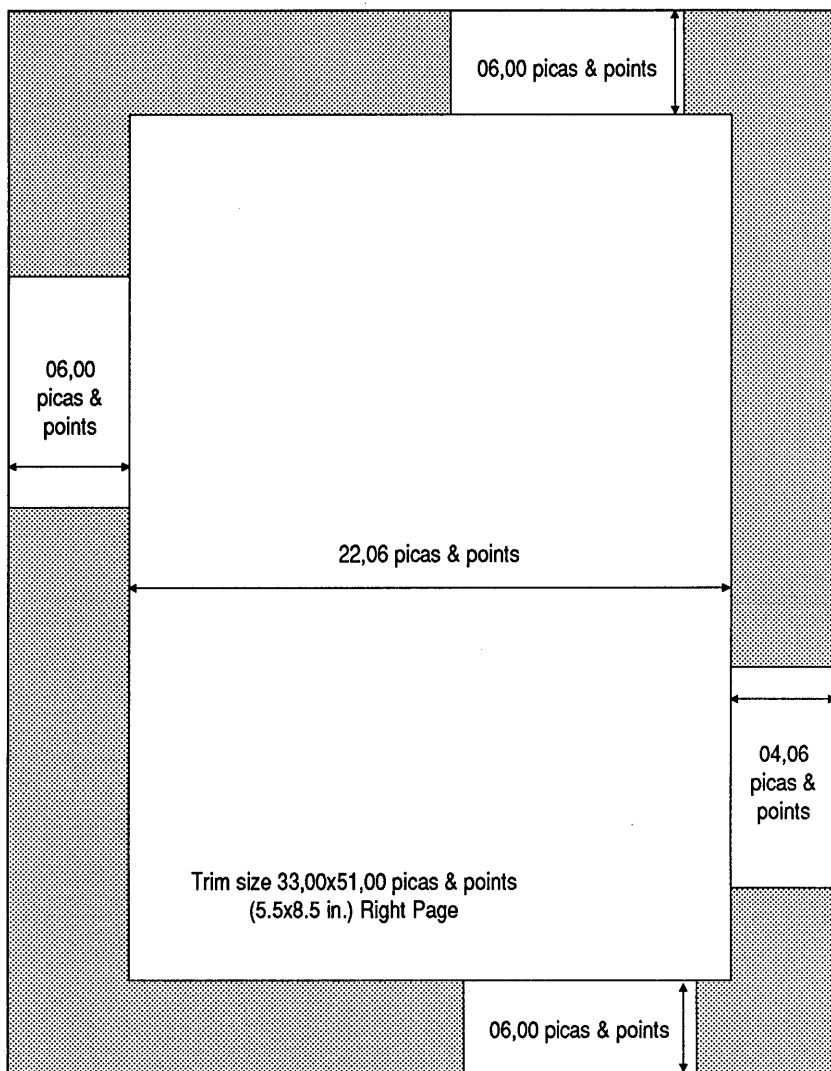

Figure 8-1. If you do NOT have the Power diisk, modify &BOOK-P1.STY as shown here.

Text

In this section, you will learn a variety of powerful text functions. You will enter footnotes, true typographic fractions, and index references. If you do not expect to use any of these three features, you may skip ahead to the style section. The sample text file for this chapter (8BOOK.TXT) has, for the most part, been pretagged and precoded for you.

Inserting a footnote

Before you insert a footnote in Ventura, you must set the format using Footnote Settings from the Chapter menu. Once you choose the format, you create a footnote in two steps: (1) you insert the reference into the text file and (2) you type the footnote text at the bottom of the page.

Set the footnote format

Your first task is to design how the footnotes will appear on the page. You only have to do this once for the entire document.

- Select Footnote Settings from the Chapter menu. Choose Usage & Format: # From Start of Page (User-Defined), Position of Number: Superscript.

Now create a “separator line” to visually separate the footnote from the main Body Text above.

- Make the Separator Line Width 12,00 picas & points, the Space Above Line: 01,01 picas & points. Switch from picas & points to fractional pts and make the Space Above Line 14.00 fractional pts and make the Height of Line 00.25 fractional pts. Then click OK.

FOOTNOTE SETTINGS ?

Usage & Format:

Start With #: 0001
 Number Template: #_

Position of Number: Superscript

User-Defined Strings: 1: *__ 2: **_ 3: ***_ 4: ****
 5: +__ 6: ++_ 7: +++_ 8: ++++

Separator Line Width: ~.~ fractional pts
 Space Above Line: 14.00
 Height of Line: 00.25

➔ **NOTE:** Be careful to make the height of the line 00.25 fractional pts, not picas & points. If you switch back to picas & points, the height will show as 00,00 picas & points. Do not be concerned. Your measurements have not disappeared. They are simply too small to show up in picas & points mode.

The separator line is measured from the left edge of the page, not from the margin. The left margin is 06,00 picas & points, and the separator line is 12,00 picas & points. The portion of the separator line in the margin (the first 06,00 picas) will not print. The portion on the live area (the second 06,00 picas) will print (Figure 8-2).

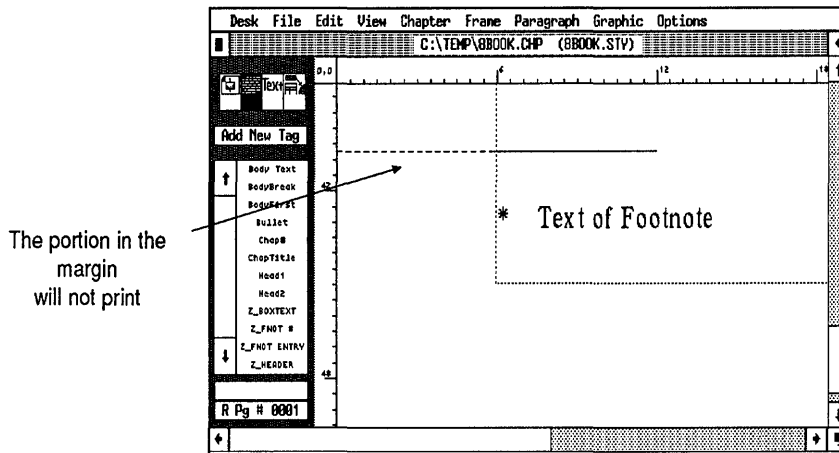

Figure 8-2.

The separator line is not yet visible on your screen. It will appear after you insert the footnote reference in the following step.

Insert the footnote reference

After setting the format, you're ready to insert the footnote reference in the text file.

- Go to page seven and change to Normal View.
- Enable Text mode.
- Place your cursor after the period at the end of the sentence as shown in Figure 8-3.

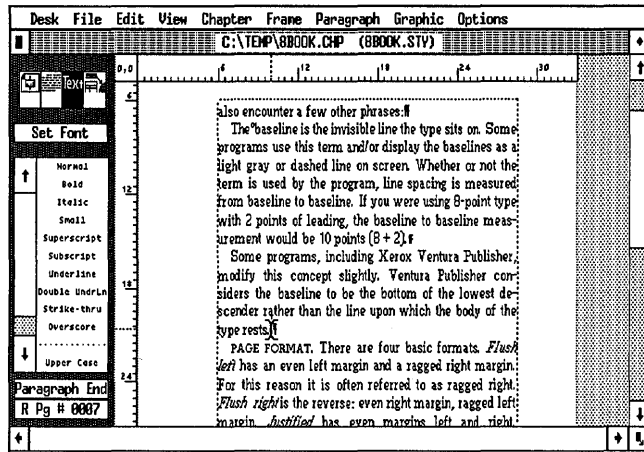

Figure 8-3.

➔ **NOTE:** Do not be concerned if there are minor discrepancies between the position of text on your screen and the text shown here. Different monitors and graphic cards may show more or less than our illustrations.

- Select **Ins Special Item** from the **Edit** menu (or hit **Ctrl-C**).
- Choose **Footnote** (or press **F2**).

A small cross shows the location of the footnote reference in the text. Ventura also displays the separator line, the footnote symbol (an asterisk), and the words "Text of Footnote" at the bottom of the page (Figure 8-4).

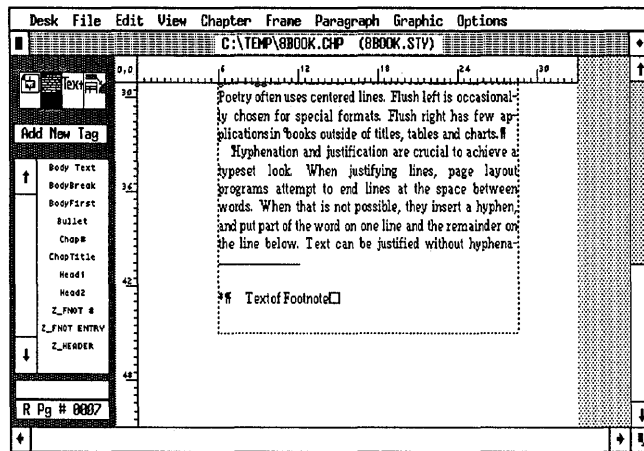

Figure 8-4.

Add footnote text

After you insert the footnote reference into the text, you will delete the words "Text of Footnote" at the bottom of the page and type in the footnote text.

■ Delete the words "Text of Footnote." Then type:

For more information on this program, see Inside Xerox Ventura Publisher by James Cavuoto and Jesse Berst (MicroPublishing and New Riders, Westlake Village, CA, 1987)

➔ *NOTE: If you backspace to erase the footnote text and get the message "The paragraph you are trying to tag/edit is made up of text that was automatically generated...", simply press OK to delete the message.*

When you are finished the footnote should look similar to Figure 8-5.

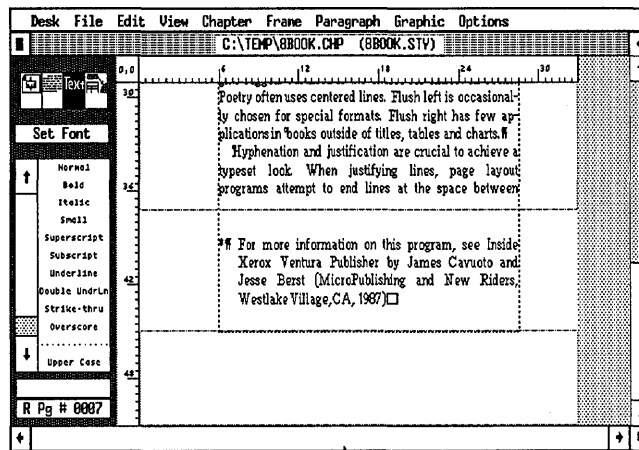

Figure 8-5.

The footnote symbol is a generated tag named Z_FNOT# and the footnote text is a generated tag named Z_FNOT ENTRY. For now, do not be concerned with their appearance. Later when you get to the style section of the chapter, you will change their appearance.

➔ **NOTE:** Like headers and footers, footnotes occupy their own frames. You can raise or lower the footnote on the page by changing the top margins of this frame or by changing the space above the tag. You cannot, however, resize the frame.

To delete a footnote and its text reference, delete the footnote symbol (the asterisk) in the text file. When the footnote symbol and its corresponding footnote text are deleted, Ventura automatically renumbers the remaining footnotes.

Insert a fraction

In earlier chapters, we taught you how to use bracket codes to insert true typographic characters in your word processor. In this section we will show you how to enter true typographic fractions directly in a text file. The Fraction option in the Ins Special Item dialog box (Edit menu) gives you true fractions that display as smaller-than-normal letters separated by a fraction bar.

☒ Go to page four.

For this project, you will replace the fraction “1/6” in the second paragraph with a true typographic fraction.

☒ In Text mode, place the cursor in front of the fraction and press the Del key three times to delete the 1, the separator bar, and the 6 (Figure 8–6).

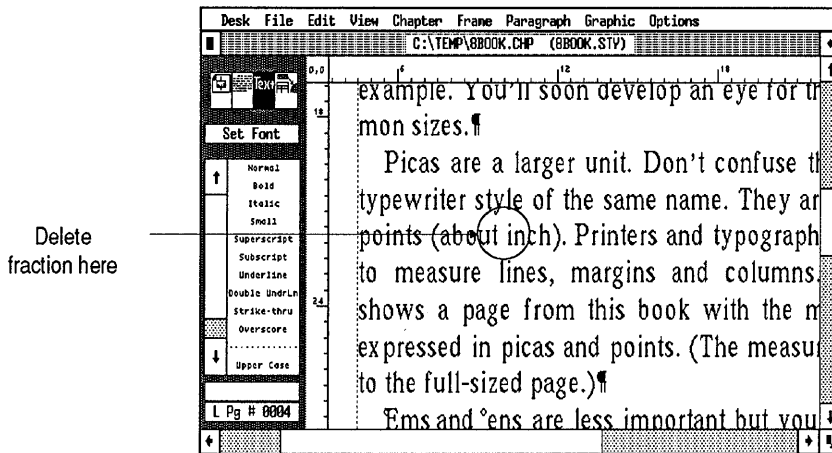
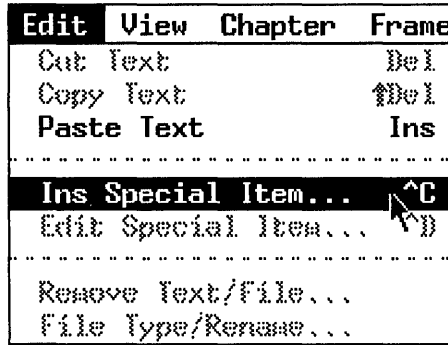

Figure 8–6.

Now you are ready to insert a real fraction.

- Without moving the text cursor, select **Ins Special Item** from the **Edit** menu.



- Choose **Fraction** (or press F4).

The fraction editing screen appears (Figure 8-7).

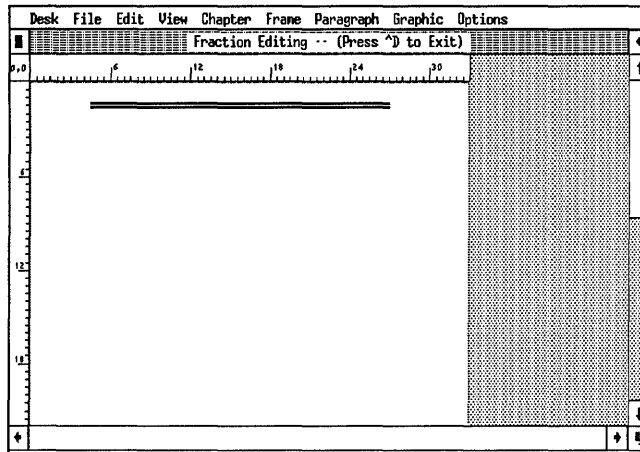

Figure 8-7.

- Type: **1/6**

Ventura displays the typographic fraction on-screen.

- Now press **Ctrl-D** to return to the document, where you will see the new fraction format (Figure 8-8).

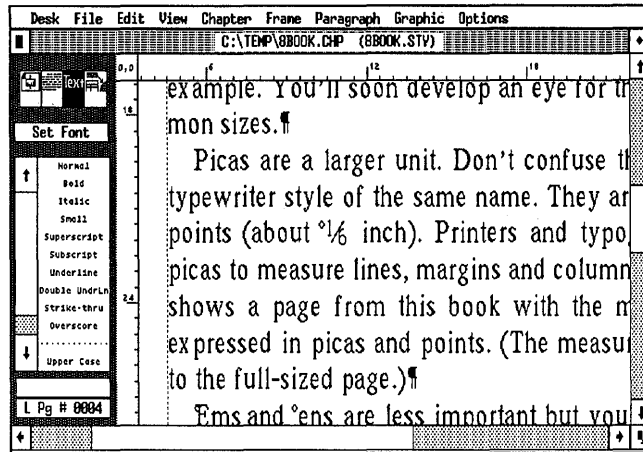

Figure 8-8. After you close the fraction editing screen, the true typographic character appears in the main text file.

You can also make a fraction that looks like this: $\frac{1}{6}$. Select **Ins Special Item** and choose **fraction**. When the equation editing screen appears type: **1 over 6**. Make sure you leave a space on both sides of the word **over**.

After creating a simple fraction, you are ready to learn how to index.

➔ **NOTE:** To create complex mathematical equations, we recommend the equation editing capabilities of Ventura's *Professional Extension*.

Insert an index

Indexing is a difficult concept to teach and to learn. The best way to master the process is simply to go through it a time or two. It is a three-step process: (1) insert index references into the text file, (2) generate the index file, (3) format the generated index file. For the moment, you will insert sample index entries into the text file. Later, in the chapter section, you will generate and format the index.

Before you insert your first index reference, take a moment to review the different levels of an index as shown in Figure 8-9.

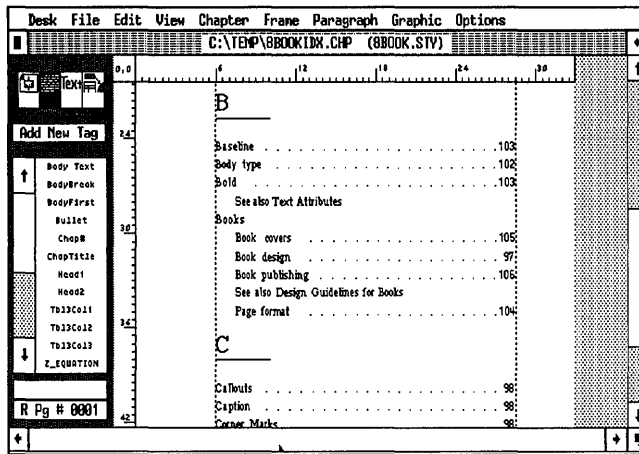

Figure 8–9.

In Figure 8–9, each major index section is preceded by a letter heading — A, B, C, and so forth. The first entry below the letter is the Primary Entry (for example, Books in the illustration above). The indented words are Secondary Entries (for example, Book covers, Book design, and Book publishing). See and See also references can also be secondary entries. For instance, “See also Design Guidelines for Books” is a secondary entry. Instead of listing a page number, the See and See Also references direct the reader to a related entry elsewhere in the index.

Insert an index entry

To learn how to insert references, you will place a Primary Entry and a See Also Entry.

- Go to page five.
- Enable Text mode.
- Place the cursor immediately in front of the “a” in the word “attributes” in the third paragraph. (The word attribute is underlined in Figure 8–10 to help you place the text cursor on the page. *Do not* underline the word.)
- Select Ins Special Item from the Edit menu (or press the shortcut Ctrl-C).

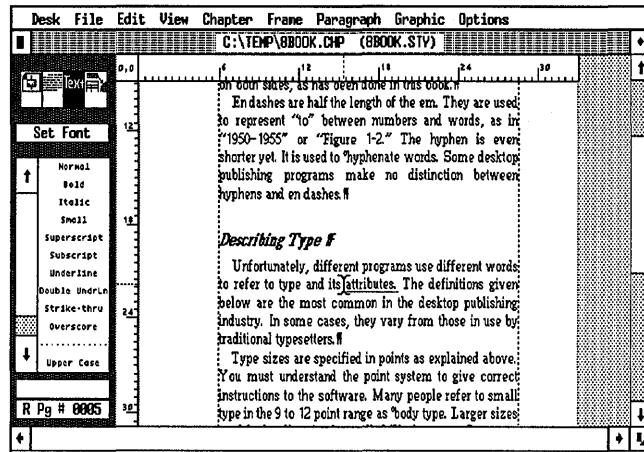
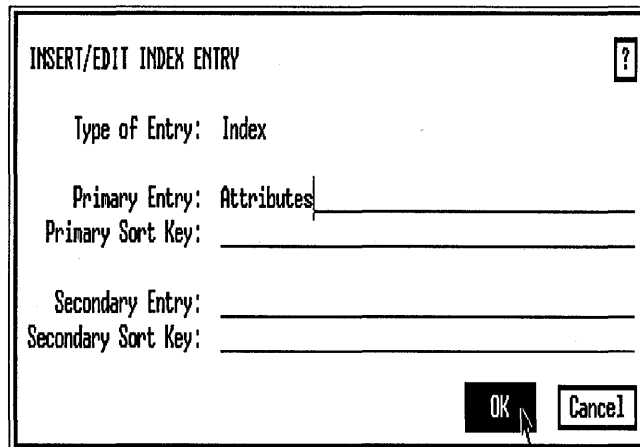

Figure 8-10.

- Select Index Entry (or press the F3 key).
- Choose Type of Entry: Index. Place the text cursor on the Primary Entry line, type: **Attributes** and click OK.



Ventura inserts a degree symbol (°) in front of the word Attributes. If you do not see the symbol on-screen, make sure Show Tabs & Returns is on from the Options menu (or press Ctrl-T).

Now you will add the identical entry on another page.

- Go to page six.

- Place the text cursor in front of the letter “A” in the word “ATTRIBUTES” (Figure 8–11).

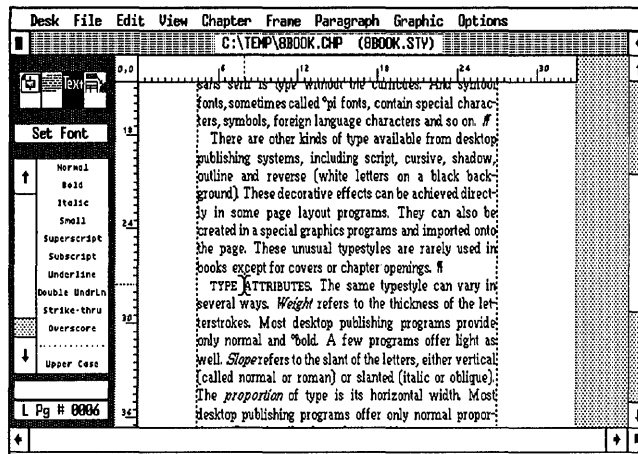

Figure 8–11.

- Select Ins Special Item and press F3.
- Select Type of Entry: Index. Place the text cursor on the Primary Entry line and type: **Attributes** and click OK.

➔ *TIP: When you insert multiple entries be careful to use identical spelling and case.*

For instance, if you were to enter the word *Attributes* as one Primary Entry and the word *Attribute* as the other Primary entry, Ventura would create two separate entries in the index.

Add a see also entry

Ventura permits you to go back to a reference to make changes or additions. Let's return to the previous index reference and add a secondary entry.

- Go to page five.
- Place the cursor immediately in front of the degree symbol (°) that precedes the word “attributes” (Figure 8–12).
- Move the cursor back and forth with the arrow keys until the words “Index Entry” appear in the Current Selection box.

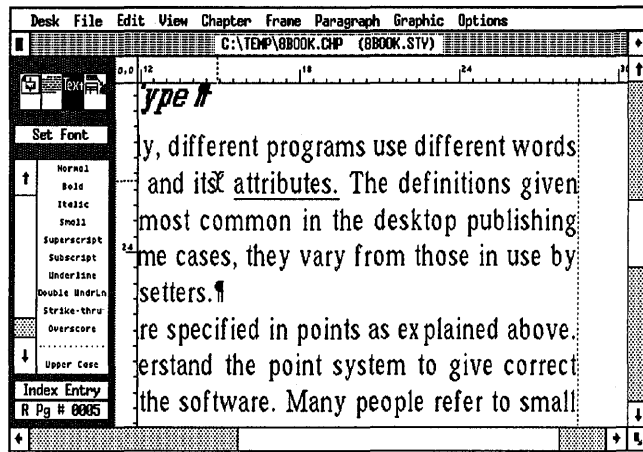
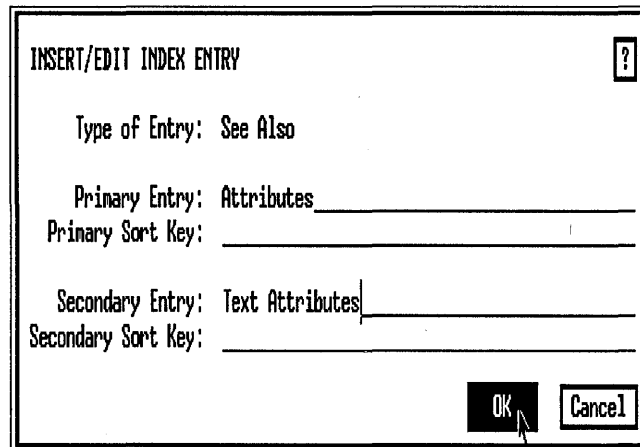

Figure 8-12.

- Select Edit Special Item from the Edit menu. Select Type of Entry: See Also. Move the cursor next to the Secondary Entry line and type: **Text Attributes** and click OK.



You will see the words “Index-See Also” in the Current Selection Box.

Because of space limitations, we will not ask you to insert additional index entries. Instead, we have done this for you in the files you loaded from the Power disk. We have inserted additional entries into the text file so you will have enough entries to generate a sample index later. If you look closely, you will see the degree symbols marking these entries on the screen.



Stopping point

You have learned two of Ventura's most complex features, footnoting and indexing. This is a good place to save your work and take a break. When you're ready to continue, begin with the style section.

Style

If you are returning to this project after turning off your computer, open the chapter C:\TEMP\8BOOK.CHP to resume where you left off. In this next section, you will learn more about page and chapter counters, and widows and orphans.

Verify the page size and layout

Now you will verify the settings for Page Size & Layout and Margins & Columns. You can do this while on any page in the document.

- Page Orientation: Portrait
 Paper Type & Dimension: Half
 Sides: Double
 Start On: Right Side
- Enable Frame mode and select the Page. Then check the margins and columns.
- Margins & # of Columns: 1
 Columns Settings For: Right Page
 Column 1: 22,06 picas & points
 Top: 06,00 picas & points
 Bottom: 06,00 picas & points
 Left: 06,00 picas & points
 Right: 04,06 picas & points

➔ **NOTE:** The above settings are for the right page only. The left and right margins are reversed for the left page.

Build the header

- Go to page one.
- Select Headers & Footers from the Chapter menu.
- Choose Define: Right Page Header, Usage: On. Type: **Design Principles** on the Left line and **[P#]** on the Right line.

HEADERS & FOOTERS

Define: Left Page Header Right Page Header
 Left Page Footer Right Page Footer

Usage: On Off

Left: Design Principles _____

Center: _____

Right: [P#] _____

Inserts: Chapter # Page # 1st Match Last Match
 Text Attr. Copy To Facing Page

- Without closing the dialog box, choose Define: Left Page Header, Usage: On. Type: **[P#]** on the Left line and **Chapter [C#]** on the Right line. Then click OK.

HEADERS & FOOTERS

Define: Left Page Header Right Page Header
 Left Page Footer Right Page Footer

Usage: On Off

Left: [P#] _____

Center: _____

Right: Chapter [C#] _____

Inserts: Chapter # Page # 1st Match Last Match
 Text Attr. Copy To Facing Page

- Turn off the header on the first page only.

Update the chapter counter

In the header you just made, the chapter number is displayed as part of the header text. For each consecutive book chapter, you must update the chapter counter (Update Counters, Chapter menu) so this number is correct. If you do not update the counter, the header will read “Chapter 1” for every chapter. The chapter counter controls both the number and the numbering format.

- Make sure you are on page one of the chapter.
- Select Update Counters from the Chapter menu.
- Choose Which Counter: Chapter, Update Method: Restart Number, Restart Number: 0006. Do not click OK yet. In the next section, you will change the page counter in the same dialog box.

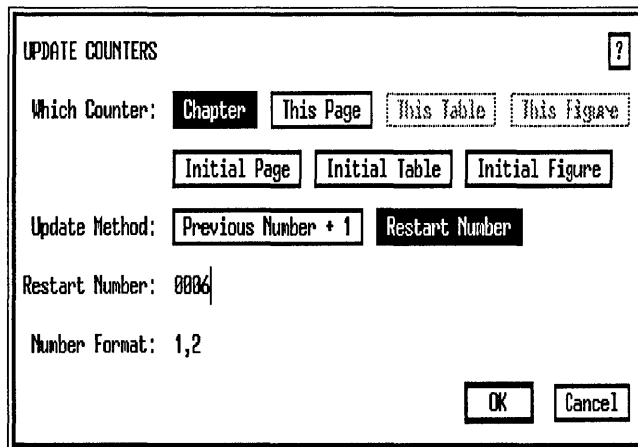

You have restarted the chapter counter at six. When you close the Update Counters dialog box the header will now read “Chapter 6.” If you had chosen, for example, the One, Two button, it would read “Chapter Six.” If you had chosen I, II, it would read “Chapter VI.”

Update the page counter

The page counter function is similar to the chapter counter. It allows you to reset the current page number to any number and override the automatic page number counter. In the following example, let's assume that the previous five chapters of this book have taken 96 pages. You will, therefore, reset the starting page number of Chapter Six to 97.

- Choose Which Counter: Initial Page, Update Method: Restart Number, Restart Number: 0097, and Number Format: 1,2. Click OK to close the dialog box.

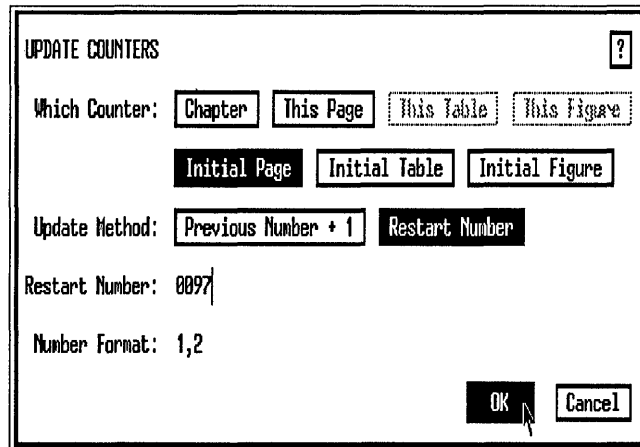

Because you turned off the header on this page, you must go to page two to see the new page numbers.

- Press PgDn to go to page 2.

Check that the number in the header is 98 (Figure 8–13).

➔ **NOTE:** The page numbers you see at the bottom of the Side-Bar are not affected by the Update Counters dialog box. The new page numbers appear only when you print the chapter.

Widows and orphans

As we explained in an earlier chapter, a widow is a single line of text at the top of the page. An orphan is a single line of text at the bottom. The Widows & Orphan dialog box determines the minimum number of lines Ventura can leave at the top or

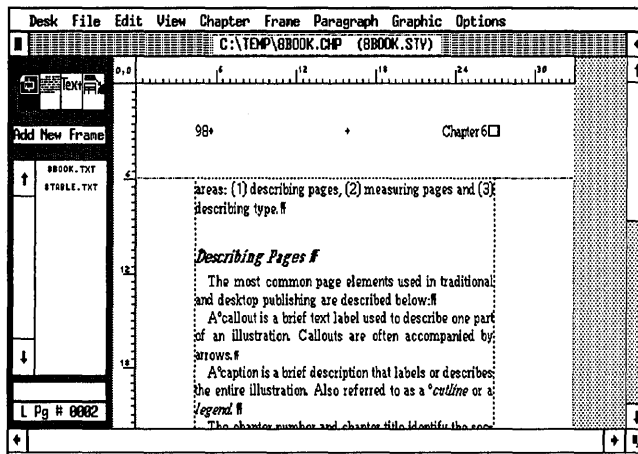

Figure 8-13.

bottom of a page or column. For this book chapter, turn off the widow and orphan control so Ventura has the flexibility to place single lines at the top and bottom of the page.

- Select Chapter Typography from the Chapter menu. Choose Widows (Min. Lines at Top): 1 and Orphans (Min. Lines at Bottom): 1.

Before you close the dialog box, change the position of the 1st baseline:

- Chapter Move Down to 1st Baseline By: Typography Inter-Line

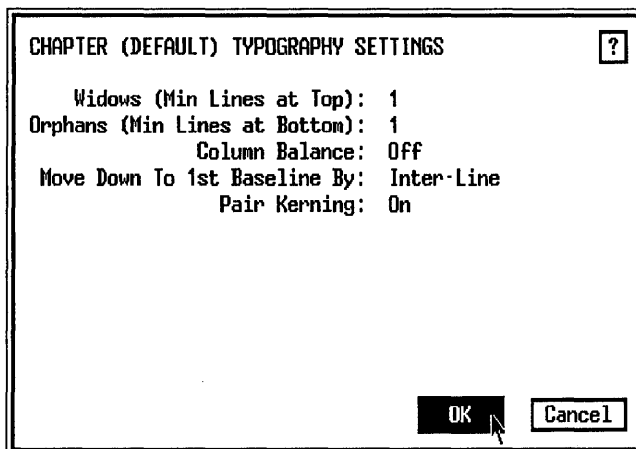

Changing the position of the text baseline from cap-height to inter-line ensures that the text reaches all the way to the bottom of the column.

Tag the first paragraph

Now that you've completed the overall page format, you will fine tune the appearance of the document by changing two tags. First you will change the book's first paragraph to include a big first character. Earlier, in Chapter Six, you learned to make a big first character rise above the first line. This time, you will create a big first character that drops below the baseline. This effect is often called a Drop Cap.

- Go to page one.
- Enable Paragraph mode.
- Select the first paragraph of the chapter, which was pretagged as BodyFirst (Figure 8-14).

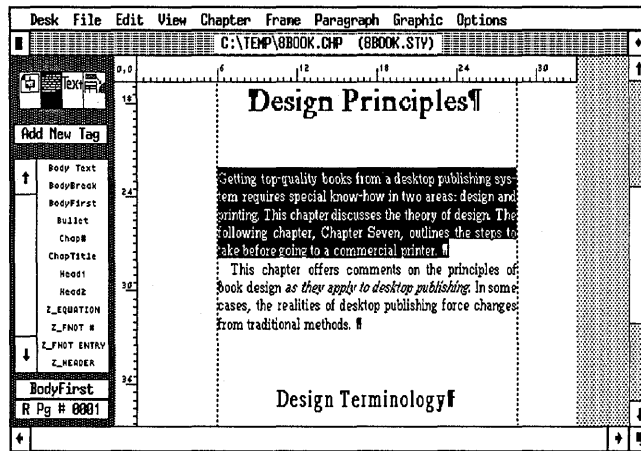

Figure 8-14.

- Special Effects Special Effect: Big First Char
Space for Big First: Normal

Selecting normal lets Ventura choose the number of lines the character should take up, based on the point size of the big first character. You will set that point size next.

- Without leaving the Special Effects dialog box, choose Set Font Properties. When the Font dialog box appears, choose Style: Bold and Size: 030.0 points.

Before you exit the Font dialog box, use the Shift option to shift the first big character down a point. This fine-tune adjustment will ensure that the first big character lines up properly with the first line of the paragraph.

- Select Shift: Down. Enter 01.00 fractional pts.

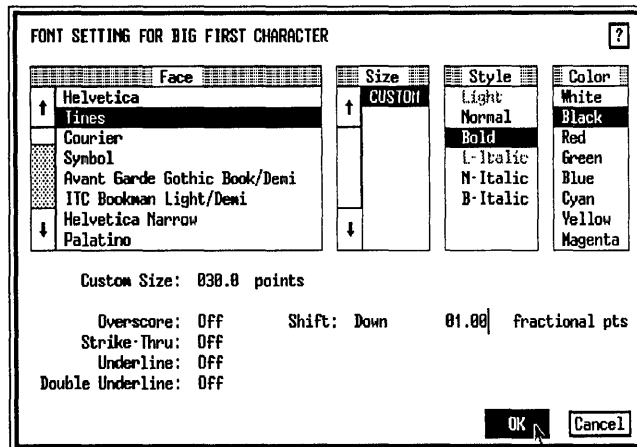

Click OK to return to the Special Effects dialog box. Click OK again to return to the workspace.

Change the footnote tag

Now you will change the attributes of the footnote tag so the two tags (Z_FNOT# and Z_FNOT ENTRY) reside on the same line.

- Go to page seven and select the footnote text (the Z_FNOT ENTRY tag) at the bottom of the page.

- Font Style: N-Italics
 Size: 010.0 points

- Spacing Inter-Line: 10.00 fractional pts
 In From Left: 01,06 picas & points

For now, this is the only tag you need to change.

Change attribute overrides

There's one more small detail to complete in the style section. You will change the size of the small text (small caps) attribute with the Attribute Overrides option.

■ Go to page five.

The lead-in heads you see on the page (for example, TYPE STYLES) were created in Text mode by applying the small (capitals) attribute. You can customize the size of the small caps attribute and apply it to selected words throughout the document. Let's say you wanted to change all the lead-in heads from 12 points to 14 points. Normally, you would have to scan the document for every occurrence of the lead-in head, and change its font to 14 points using Set Font from the Side-Bar (Text mode). However, there's an easier method. Select the Attribute Overrides option from the Paragraph menu and change the default size of the small text attribute. Now every occurrence of small text throughout the document automatically changes size.

Try out this feature for yourself.

■ In Paragraph mode, select the Body Text paragraph that includes the small text lead-in head, "TYPE STYLES." (Figure 8-15)

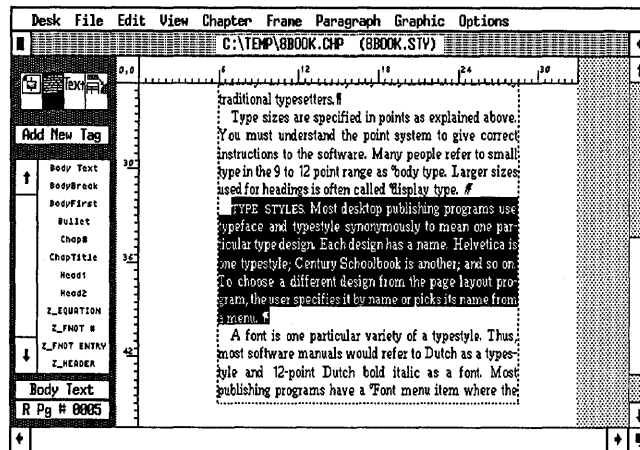
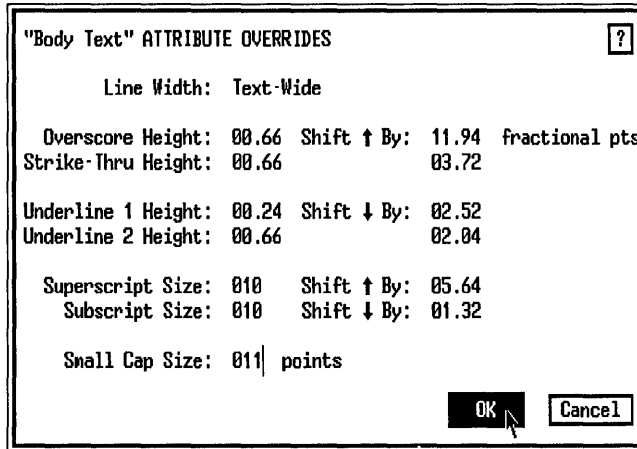

Figure 8-15.

■ Select Attribute Overrides from the Paragraph menu.

- Move to the Small Caps Size line and enter 011 points. Then click OK.



Now every occurrence of the small text attribute throughout the document changes to 11 points.



Stopping point

You've reached the stopping point for this chapter. We know that we're packing a lot of information into one chapter. Stick with us. The next section includes some powerful, valuable Ventura features. If you're tired, get up from your desk, stretch, and come back when you're refreshed.

Place the 8TABLE.TXT file

If you are continuing after a break, load Ventura and open the chapter 8BOOK.CHP and go to page four.

You have finished formatting the 8BOOK.TXT file. Now you are ready to place and tag the second text file, 8TABLE.TXT. To format this file you will use a technique called *side-by-side paragraphs* (what the Ventura manual calls *vertical tabs*). It's a complicated procedure but extremely powerful. Even if it seems a bit confusing, try to stick it out to the end of the exercise.

➔ **NOTE:** *If you do not use tables in your documents, skip this section and go directly to the chapter section. However, if you use tables of any kind, we recommend that you learn side-by-side paragraphs.*

Before you place the text, insert a new frame to contain it.

■ Go to page four.

■ Reset the zero point to its original position at the upper left corner of the Page by clicking on the 0,0 square in the upper left corner of the page.

■ Enable Frame mode and select Add New Frame. Add a new frame that measures 22,06 picas & points wide by 17,06 picas & points high. Place the upper left corner of the frame at position 28,00 picas on the vertical ruler. Stretch the frame downwards to position 45,06 picas and over next to the right column. The frame will extend slightly below the bottom column guide (Figure 8-16).

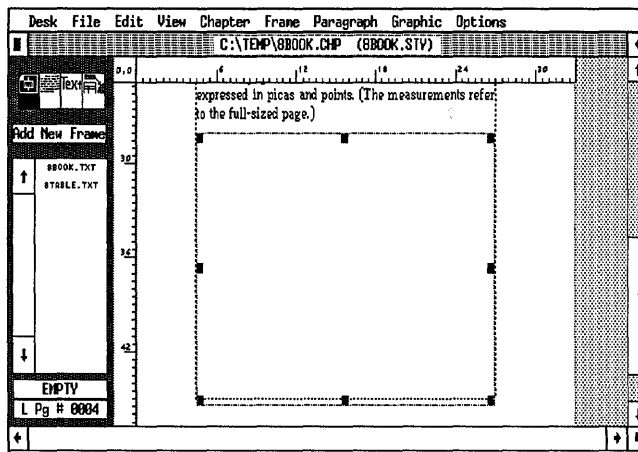

Figure 8-16.

➔ **NOTE:** *You may want to Turn Column Snap and Line Snap Off to help you place the frame.*

■ Use Sizing & Scaling to confirm that the frame measures 22,06 picas & points by 17,06 picas & points.

Before closing the Sizing & Scaling dialog box, add vertical padding to the frame.

- Sizing & Scaling Vertical Padding: 07.00 fractional pts

Now add a box around the frame.

- Ruling Box Width: Frame
- Around Height of Rule 1: 00.05 fractional pts

Give the frame its own margins.

- Margins & Columns Number of Columns: 1
- Top: 01,00 picas & points
- Bottom: 01,00 picas & points
- Left: 01,00 picas & points
- Right : 01,00 picas & points

- With the frame still selected, place the text file, 8TABLE.TXT, by selecting it from the Assignment List.

➡ **NOTE:** You will not see the entire text file when you first place it in the frame. Do not be concerned. Later, when you tag the text, it will become visible.

Create a table

There are several ways to create tables in Ventura. You can use tab settings; you can use Box Text; or you can use the technique referred to as *vertical tabs* in the Reference Guide. In this chapter you will learn the vertical tabs method, which we prefer to call *side-by-side paragraphs*.

We will start by reviewing the process and showing examples. Then we will give you a chance to try it yourself.

To use side-by-side paragraphs, you must do two things. First you must properly format the text file. Second, you create a separate tag for each column.

➡ **NOTE:** As a general rule, use tab settings when each table entry is only a single line. For tables with multi-line entries, it is easier to use side-by-side paragraphs, which allows each column to have more than one line.

Preparing text for side-by-side paragraphs

To prepare text for side-by-side paragraphs, *type each column entry as a separate paragraph*. The text file you just loaded (8TABLE.TXT) is already in the proper format. Do not enter a tab stop at the end of an entry. Figure 8–17 shows what the text file looks like before loading it into Ventura.

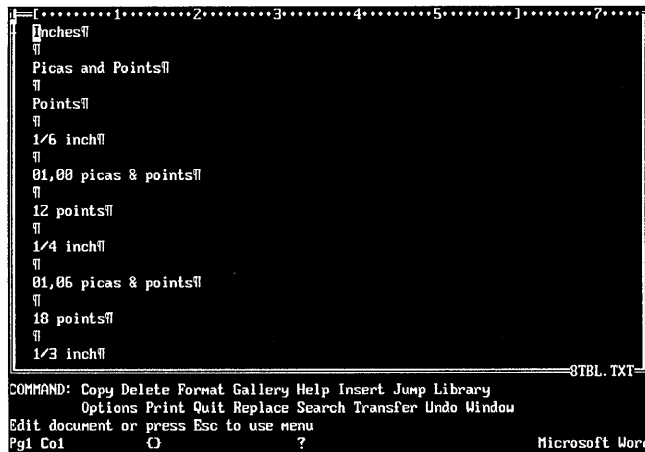

Figure 8–17.

Once you create, load, and place the text, you are ready to create the tags for each column.

Spacing with side-by-side paragraphs

Spacing and Breaks are the two keys to building columns with vertical tabs. With In From Left and In from Right Spacing you restrict the text to individual columns (Figure 8–18).

The hard part is calculating the column settings. Start by deciding the width of the columns and gutters. In the example you will build for this project, we divided the space into three equal columns of 07,06 picas & points. Once you know these widths, you must translate them into settings for In From Left and In From Right. To figure these settings, subtract the cumulative column widths from the margins (Figure 8–19).

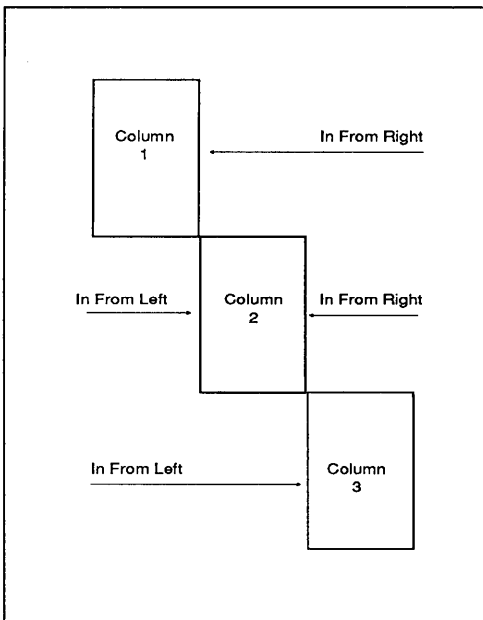

Figure 8-18.

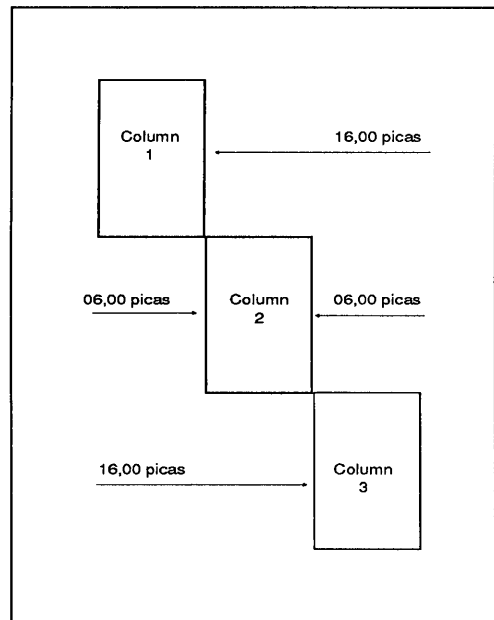

Figure 8-19.

Breaks with side-by-side paragraphs

After using Spacing to confine the text to columns, move to Breaks. Change the line breaks to allow all three column tags to co-exist on the same line. In the example below, the left column has a line break before; the center column has no line breaks; and the right column has a line break after. Now that we've reviewed the key concepts, you are ready to go ahead and create the table.

Add the tag for the first column

At this point, you will create the tags for all three columns.

- Enable Paragraph mode.
- Select the paragraph "Inches."
- Add New Tag Tag Name to Add: Tbl3Col1
- Font Face: Helvetica
Style: Normal
Size: 010.0 points

- Alignment Horz. Alignment: Center
Overall Width: Column-Wide
In/Outdent Width: 00,00 picas & points
- Spacing Above: 06.00 fractional pts
Inter-Line: 12.00 fractional pts
Add in Above: When Not at Column Top

Do not close the dialog box yet. You will now create a temporary right margin with In From Right Spacing.

- Make the In From Left Spacing 00,00 picas & points and the In From Right Spacing 16,00 picas & points.

"Tb13Col1" SPACING

Above: 06.00 fractional pts
Below: 00.00
Inter-Line: 12.00 fractional pts
Inter-Paragraph: 00.00

Add in Above: Always When Not at Column Top

Settings For: Left Page Right Page

In From Left: 00,00 picas & points
In From Right: 16,00

Inserts: Copy To Facing Page

OK Cancel

You just completed the first column. Now create the other two tags. You can use the Tbl3Col1 tag as a starting point for building the second and third column tags.

- Select the paragraphs "Picas and Points" and "Points" and tag them as Tbl3Col1.

Now change the attributes of both tags.

Add the Tbl3Col2 tag

- Select the paragraph "Picas and Points."
- Add New Tag Tag Name to Add: Tbl3Col2
- Spacing In From Left: 06,00 picas & points
In From Right: 06,00 picas & points

The In From Left Spacing and the In From Right Spacing create a temporary left and right margin to restrict the text to the center of the page.

☒ Breaks Line Break: No

Add the Tbl3Col3 tag

Finally, create the tag for the third column.

☒ Select the paragraph “Points.”

☒ Add New Tag Tag Name to Add: Tbl3Col3

☒ Spacing In From Left: 16,00 picas & points
In From Right: 00,00 picas & points

☒ Breaks Line Break: After

Now that you’ve created the tags for all three columns, you’re ready to apply them to the rest of the paragraphs in the text file. Use Figure 8–20 as your guide to tag the rest of the table.

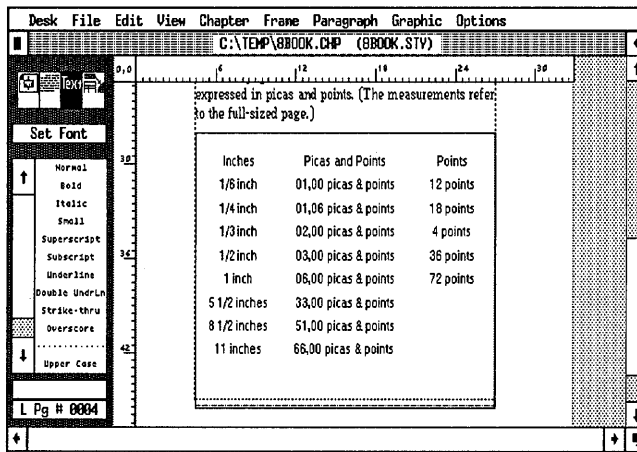

Figure 8–20.

To put the final touches on the table, make the column headings bold.

☒ Enable Text mode.

☒ Select each column heading (“Inches,” “Picas and Points,” and “Points”) in turn and make it bold.

Congratulations. You made it through one of Ventura's most difficult and most useful techniques. Your reward awaits you in the next section.

Pictures

Since you will not be placing any pictures in this sample project, proceed directly to the Chapter section.

Chapter

So far you have formatted the text and inserted index entries. You are now ready to advance to the Chapter section, where you will generate a table of contents (TOC) and an index. To do either function, you must first make a publication. The publication would normally include all the chapters in the book. For this example, you will include only two chapters: Chapter Six, which you completed above, and Chapter Seven, a fully-formatted sample chapter from the Power disk (or typed in from Appendix A).

Prepare for the publication

Before you generate a TOC or index, you must update the page and chapter counters for every chapter in the publication. If you were to omit this step, the page numbers in the TOC and index would be incorrect.

Add a page to Chapter Six

Now you will go to the end of Chapter Six (8BOOK.CHP) to find the last page number in the chapter.

➡ *TIP: When Ventura updates the page number, it displays the new number in the header or footer, not in the Side-Bar.*

■ Press the End key to go to the last page in the chapter.

Note that the page number is 107 and that it is a right-handed page. Traditionally, book chapters start on a right-hand page. Therefore, to start the next chapter (Chapter Seven) on a right

page, you will insert a blank left page as a “spacer” page at the end of the Chapter Six.

- Insert/ Remove Page Operation: Insert Page After Current Page

Now, the last page reads as 108. Chapter Seven will start on the right-hand page number 109.

Save the chapter.

- Press Ctrl-S.



Open Chapter Seven (if you have the Power disk)

Now you will change the starting page number of Chapter Seven.

- Select Open Chapter from the File menu and open the chapter C:\POWER\8PRINT.CHP.
- Save the text file as C:\TEMP\8PRINT.TXT.
- Load the style sheet C:\TEMP\8BOOK.STY.
- Save the chapter as C:\TEMP\8PRINT.CHP.



Open Chapter Seven (if you do not have the disk)

- Load the text file 8PRINT.TXT from the C:\TEMP sub-directory.
- Load the style sheet 8BOOK.STY from the C:\TEMP sub-directory.
- Save the chapter as C:\TEMP\8PRINT.CHP.

Update the chapter counter

Now update the chapter counter to make the header read “Chapter 7”.

- Select Update Counters from the Chapter menu.

- Select Which Counter: Chapter, Update Method: Previous Number + 1, Number Format: 1,2. Do not close the dialog box until you also update the page counter.

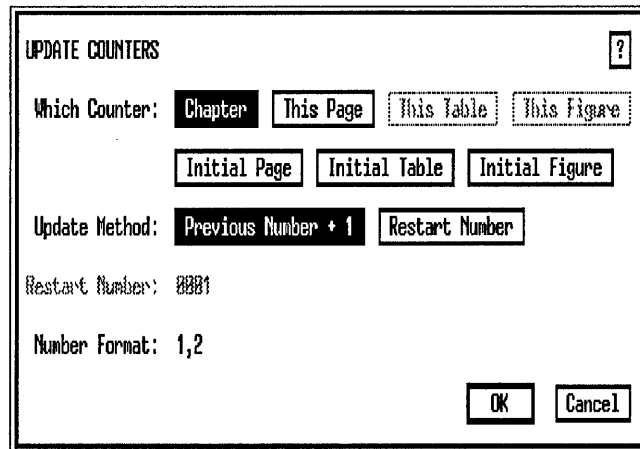

Update the page counter

After setting the chapter number, reset the first page of the chapter.

- Select Which Counter: Initial Page, Update Method: Previous Number + 1, Number Format: 1,2. Click OK to close the dialog box.

When you select the initial page counter, Ventura resets the first page of the chapter as you specified in the update method. By selecting Update Method: Previous Number + 1, Ventura makes the first page of Chapter Seven start one page after the last page of Chapter Six. The header will not reflect the new page and chapter counters until later, when you renumber the publication in the Multi-Chapter dialog box.

Save Chapter Seven before continuing on.

- Press Ctrl-S.

Create a publication

To create the publication, you will use the Multi-Chapter dialog box in the Options menu.

- Select Multi-Chapter from the Options menu.
- Select New to start a new publication.
- Select Add Chapter.
- Select the chapter C:\TEMP\8PRINT.CHP.

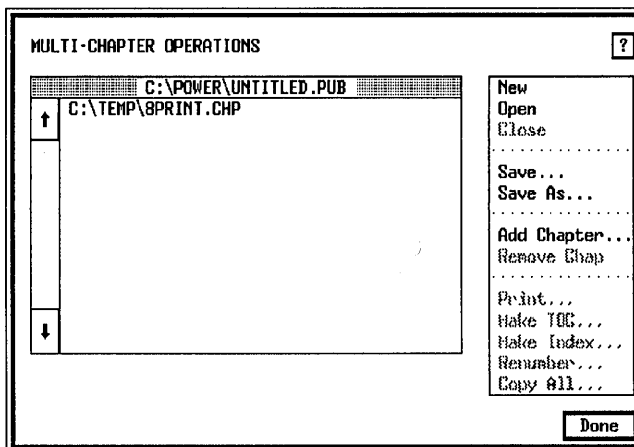

Now add the second chapter to the list.

- Select Add Chapter.
- Select the chapter, 8BOOK.CHP, from the C:\TEMP sub-directory.

The chapter name 8BOOK.CHP is the second item in the list.

Rearrange the chapter list

Before saving the publication, you will practice rearranging the chapters in the list so that 8BOOK.CHP (Chapter Six) is first and 8PRINT.CHP (Chapter Seven) is second.

- Press and hold down the mouse button over 8BOOK.CHP until you see the hand cursor appear. Now drag the filename to the top of the list and release the button (see Figure 8–21).

Before you save the publication, make sure that none of the names are highlighted. Otherwise, Ventura will save only that chapter.

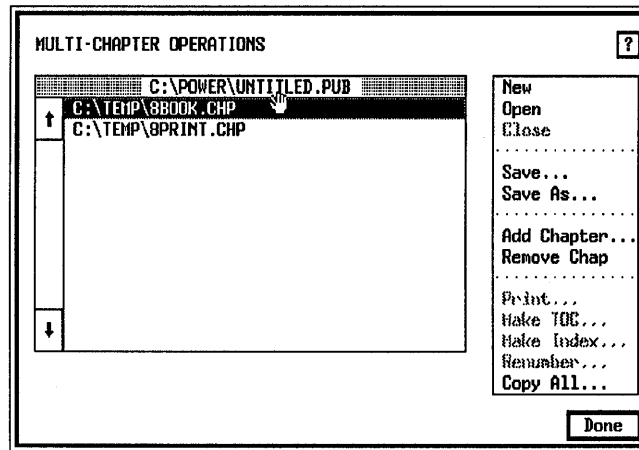

Figure 8-21.

- Select Save As from the dialog box.
- The Item Selector appears. Use the Backup button to locate the C:\TEMP subdirectory if necessary. On the Selection line type the name of the publication: **8BOOK.PUB** and click OK. Ventura returns you to the Multi-Chapter dialog box.

Renumber the publication

After making the publication, you can renumber the chapter and page counters for every chapter in the publication. This will generate the correct page numbers in both the Index and the TOC.

- ➔ *NOTE: Make sure that none of the chapter names are highlighted. Otherwise, Ventura will not let you renumber the publication.*
- While you are in the Multi-Chapter dialog box, choose Renumber. When asked if you want to renumber chapters, pages, tables, and figures across the entire publication, choose Renumber. Ventura displays a message that it is renumbering the publication.

Generate a table of contents

Now you are ready to generate the TOC. A table of contents provides an outline of a book's major topics and sub-topics,

along with their page numbers. Ventura generates a TOC in two steps. First, it searches the publication for the tag names you specify. Second, it generates a text file that shows each instance of those tags and the page on which they appear.

The generated TOC text file can be loaded and formatted like any other text file. Ventura assigns the different levels of the TOC a generated tag. For example, Level One is tagged as Z_TOC LVL 1, level two is Z_TOC LVL 2, etc. As with other generated tags, you can change the attributes of the tags to achieve the desired effect.

☒ While still in Multi-Chapter, select Make TOC.

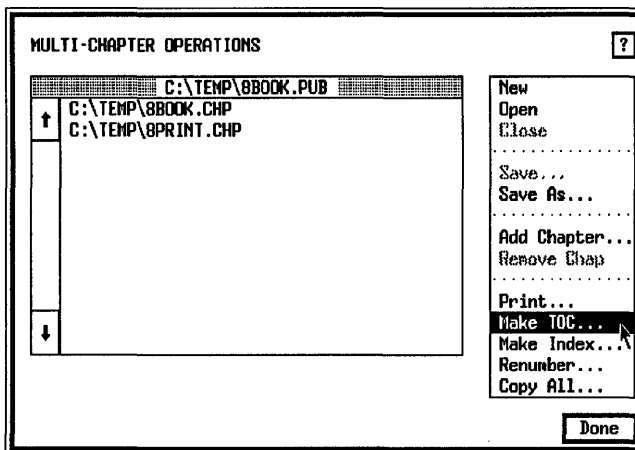

➡ *TIP: You cannot select the Make TOC option if a single chapter is highlighted.*

The Generate Table of Contents dialog box appears. Notice that the name of the current publication is displayed next to TOC File except that the last three letters have been changed to TOC and the file extension to GEN. This is the default name that Ventura assigns to a generated TOC file. Although you can change the name of this file, we suggest that you not change the three-letter extension GEN.

WARNING: Make sure that the TOC File line reads C:\TEMP\8BOOKTOC.GEN. If a different subdirectory name is displayed, press Esc to clear the line and type in C:\TEMP\8BOOKTOC.GEN.

For this project, you will not change the Title String that tells Ventura to display the words “Table of Contents” at the top of the page. You will, however, make additions to the other levels of the TOC.

- Place the text cursor next to the Level 1 line and select the Inserts: Text Attr. button at the bottom of the dialog box.

The bracket code <D> appears on the line.

- Delete the D and replace it with the letter B.

The bracket code turns on the Bold text attribute.

- Move the cursor past the right bracket and choose the Inserts: Chapter # button.

The bracket code [C#] appears on the line.

The [C#] code tells Ventura to display the number of the chapter.

- Now choose Inserts: Tab from the bottom of the dialog box.

The tab symbol appears on the line. The tab separates the chapter number from the next tag name.

- Choose Inserts: Tag Text. The code [*tag name] appears on the line. Delete the words “tag name.” Type in: **ChapTitle** within the brackets.

[*ChapTitle] tells Ventura to scan for all occurrences of the tag ChapTitle and to list them as level 1 entries in the TOC.

- Move the cursor past the right bracket and choose Inserts: Tab.

The tab separates the entry from the page number that follows. Later in this chapter you will use this tab setting to create leader dots between the entries and the page numbers.

- Choose Inserts: Page #

The [P#] code tells Ventura to display the page number on which it found this occurrence of the tag you indicated.

- Choose Inserts: Text Attr.

The bracket code <D> appears on the line. <D> turns off the Bold text attribute and returns the font to normal.

When the TOC is generated and formatted the first level will look similar to Figure 8-22:

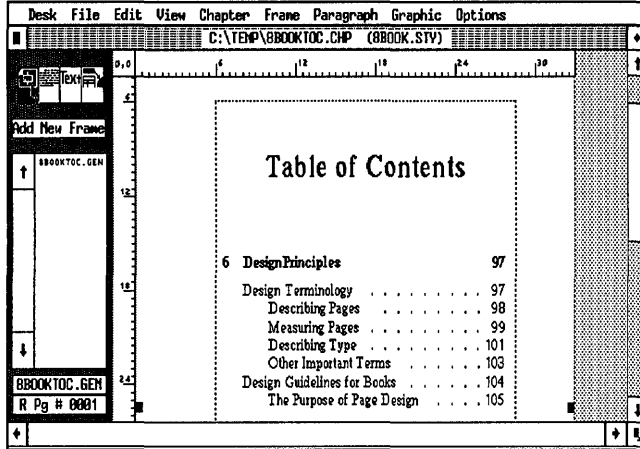

Figure 8-22.

Insert the codes for second and third levels

Place the text cursor on the Level 2 and Level 3 lines and type in the codes shown in Figure 8-23. Use the buttons at the bottom of the dialog box as shortcuts.

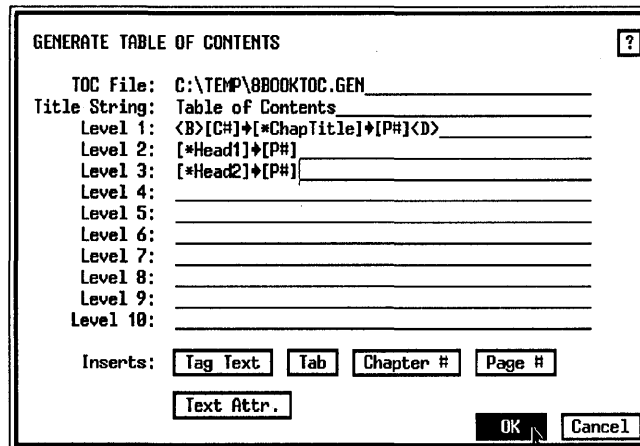

Figure 8-23.

Generate the TOC by clicking the OK button.

Ventura displays a message that it is generating the TOC text file and shows which chapter files it is scanning. When the TOC is finished, you return to the Multi-Chapter dialog box. Later you will format this file. For the moment, complete the last Multi-Chapter operation.

Generate an index

Do you remember the index entries you inserted into the text file? Ventura will generate its index based on those references (plus some extras we inserted for you in advance). Once the index is complete, you will load and format both the index and the TOC generated files.

- With the Multi-Chapter dialog box still open, select Make Index from the Multi-Chapter Side-Bar.

The Generate Index dialog box appears on the screen. On the Index File line Ventura displays the current publication name with the last three letters changed to IDX and the extension changed to GEN. Do not change this file name extension.

WARNING: If a different subdirectory name is displayed, change the TOC File line to read C:\TEMP\8BOOKIDX.GEN.

Leave the Title String line as “Index.” This tells Ventura to display the word “Index” as the heading for the index.

- Choose Letter Headings: On.

When you turn Letter Headings on, you instruct Ventura to place an A before the entries starting with A, a B before the B index entries, and so forth.

- Move the cursor to the For Each # line and delete both occurrences of the [C#] code and the hyphen (*do not delete the hyphen between the page number [P#] codes*). This tells Ventura to display only the page numbers in the completed index, not the chapter numbers (Figure 8–24).

- Choose OK to generate the index.

During index generation, Ventura locates the index references, and builds them into a sorted list with the corresponding page numbers. After each entry, Ventura inserts a line

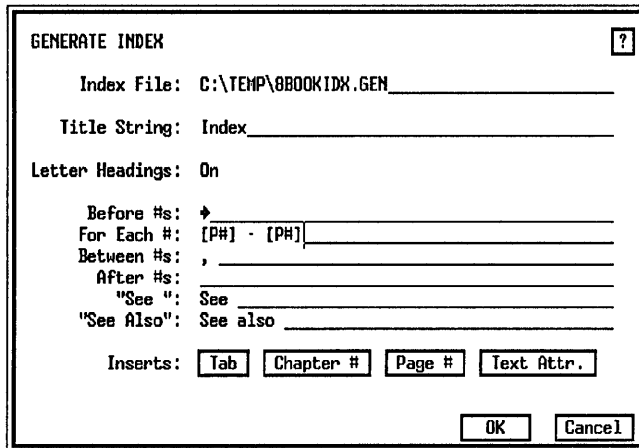

Figure 8-24.

break and a horizontal tab character. After the last entry of a letter heading, Ventura inserts a paragraph return.

The index contains three generated tags: Z_INDEX TITLE, Z_INDEX LTR, and Z_INDEX MAIN. Later in this chapter you will change the attributes of these generated tags.

After generating the index, Ventura returns you to the Multi-Chapter dialog box.

- Choose Done to exit the Multi-Chapter dialog box.
- If Ventura asks, choose Save to save the changes you made to the publication.

Format the TOC and the index

This is a good place to pause and remind ourselves where we've been and where we are headed. At this point, you have used Ventura to generate "raw" text files. By searching the chapter, Ventura was able to find and insert the page numbers where each entry can be found.

With that work out of the way, you can load and format the TOC and the Index text files. You will create them as two separate chapters using the same style sheet (8BOOK.STY). Begin with the table of contents.

➔ **NOTE:** *If you are in a hurry, you can skip over this formatting section, since it does not introduce any new skills. However, we suggest you read over it, if you plan to do TOCs and indexes of your own. For instance, because of the way Ventura outputs the index file, you must use Tab Settings to create the proper indents.*

Start a new chapter

Since you are using the same style sheet, you can simply “empty out” the current workspace by choosing New from the File menu.

■ Select New from the File menu.

The screen is emptied of text, but Ventura retains the current 8BOOK.STY style sheet.

■ Enable Frame mode and select the Page.

■ Select Load Text/Picture from the File menu. Select Type of File: Text, Text Format: Generated, # of Files: One, and Destination: List of Files.

WARNING: Be sure to select Text Format: Generated rather than ASCII.

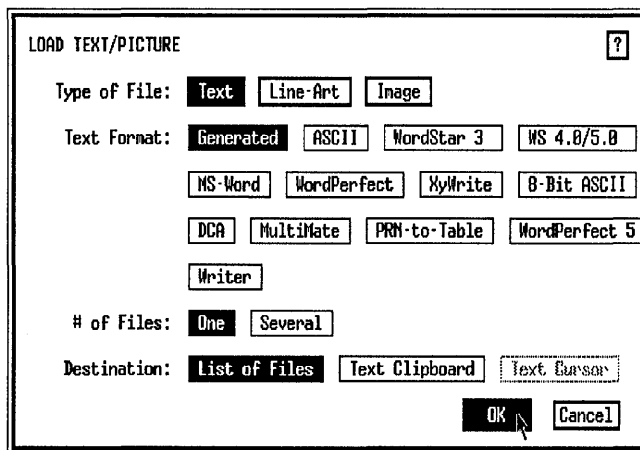

■ Use the Backup button to locate the C:\TEMP subdirectory. Then load the text file 8BOOKTOC.GEN and place it on the Page.

- Select Save As to save the chapter as C:\TEMP\BOOK-TOC.CHP.

Change the Z_TOC TITLE tag

You will change the text attributes of the generated tags in the TOC. Start with the title.

- Enable Paragraph mode.
- Select the paragraph “Table of Contents.” (Notice the tag name Z_TOC TITLE in the Current Selection Box.)
- Font Style: Bold
 Size: 024.0 points
- Alignment Horz. Alignment: Center
 In/Outdent Width: 00,00 picas & points
- Spacing Above: 28.00 fractional pts
 Below: 56.00 fractional pts
 Inter-Line: 28.00 fractional pts
- Breaks Page Break: Before/Until Right

Selecting Before/Until Right forces the TOC to start on a right-hand page, the traditional placement in books. When you are finished, the title should look like Figure 8-25:

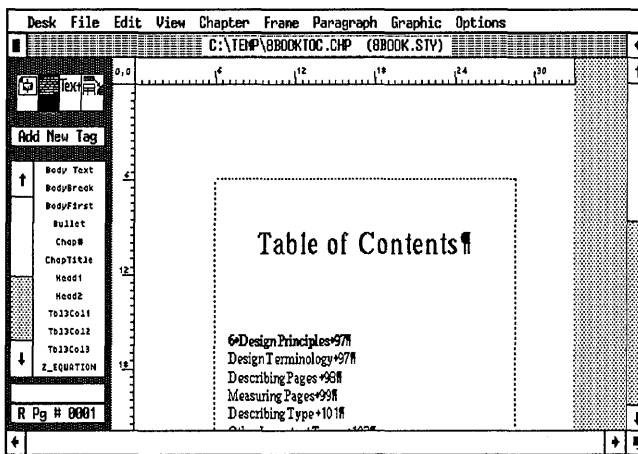

Figure 8-25.

Change the Z_TOC LVL 1 tag

- Select the paragraph “6 Design Principles97.”
- Alignment Horz. Alignment: Left
 In/Outdent Width: 00,06 picas & points
- Spacing Above: 28.00 fractional pts
 Below: 07.00 fractional pts
 Inter-Line: 14.00 fractional pts
 Add in Above: When Not at Column Top

You will now use tab settings to position the text across the page, as shown in Figure 8–26.

- Tab Settings Tab Number: 1
 Tab Type: Left
 Tab Shown As: Open Space
 Tab Location: 02,00 picas & points
- Tab Number: 2
 Tab Type: Right
 Tab Shown As: Open Space
 Tab Location: 21,09 picas & points

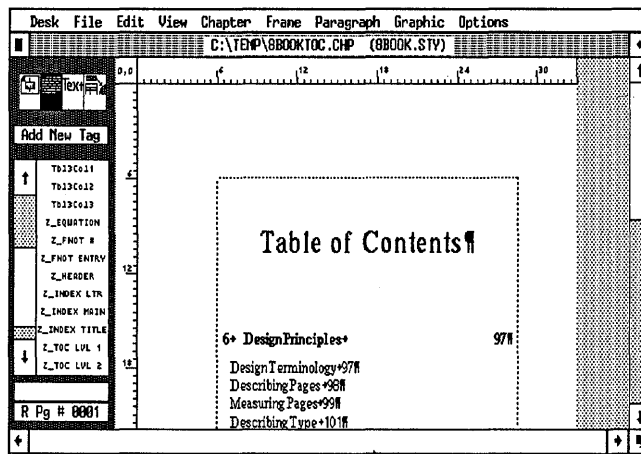

Figure 8–26.

Change the Z_TOC LVL 2 tag

- Select the paragraph “Design Terminology97.”

- Alignment Horz. Alignment: Left
 In/Outdent Width: 02,00 picas & points
- Spacing Add in Above: When Not at Column Top
- Tab Settings Tab Number: 1
 Tab Type: Right
 Tab Shown As: Leader Char
 Tab Location: 21,09 picas & points
 Leader Char: ...
 Leader Spacing: 3

Change the Z_TOC LVL 3 tag

- Select the paragraph “Describing Pages98.”
- Alignment Horz. Alignment: Left
 In/Outdent Width: 04,00 picas & points
- Spacing Add in Above: When Not At Column Top
- Tab Settings Tab Number: 1
 Tab Type: Right
 Tab Shown As: Leader Char
 Tab Location: 21,09 picas & points
 Leader Char: ...
 Leader Spacing: 3

Apply the tags

When you are finished, the table of contents should look like Figure 8–27:

Congratulations on completing your first table of contents. Now save your work.

- Press Ctrl-S
- Select New from the File menu to create a new chapter for the index. Load the generated file 8BOOKIDX.GEN from the C:\TEMP subdirectory and place it on the Page. Save the chapter as C:\TEMP\8BOOKIDX.CHP. With the text file loaded, you’re ready to change the tags.

| Table of Contents | |
|---|------------|
| 6 Design Principles | 97 |
| Design Terminology | 97 |
| Describing Pages | 98 |
| Measuring Pages | 99 |
| Describing Type | 101 |
| Other Important Terms | 103 |
| Design Guidelines for Books | 104 |
| The Purpose of Page Design | 105 |
| 7 Offset Printing From Laser Mechanicals | 109 |
| Traditional Book Printing | 109 |
| The Desktop Workflow | 111 |
| Preparing Photographs | 111 |
| Positioning Photographs | 114 |
| Scanning and Digitizing | 115 |
| Crop Marks | 116 |
| Screen Tints | 117 |
| Color printing | 118 |
| Covers | 120 |
| Adjusting Page Counts | 121 |
| Improving the Look of Laser-printed Pages | 122 |
| Improving Mechanicals | 122 |
| The Lithographer Can Help | 126 |

Figure 8-27.

Change the Z_INDEX TITLE tag

- Enable Paragraph mode. Select the title "Index" at the top of the page.
- Font
 - Style: Bold
 - Size: 024.0 points
- Alignment
 - Horz. Alignment: Left
 - In/Outdent Width: 00,00 picas & points
- Spacing
 - Above: 28.00 fractional pts
 - Below: 28.00 fractional pts
 - Inter-Line: 21.00 fractional pts
- Ruling Line
 - Below
 - Width: Column
 - Color: Black
 - Pattern: Solid
 - Space Above Rule 1: 02.00 fractional pts
 - Height of Rule 1: 00.25 fractional pts

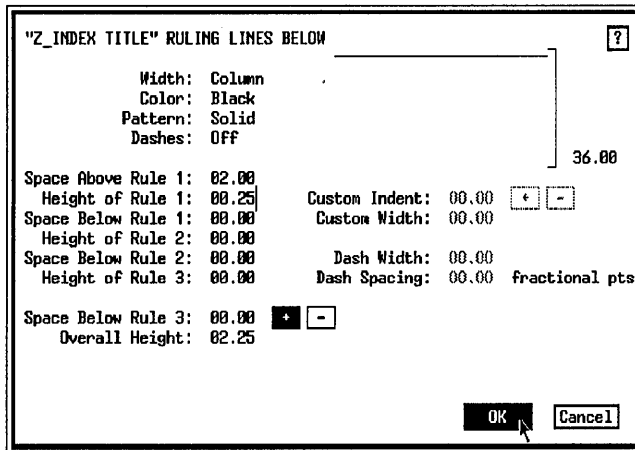

Change the Z_INDEX LTR tag

- Select the letter "A" at the top of the page.
 - Font Style: Bold
 Size: 018.0 points
 - Alignment Horz. Alignment: Left
 In/Outdent Width: 00,00 picas & points
 - Spacing: Above: 14.00 fractional pts
 Below: 14.00 fractional pts
 Add in Above: When Not at Column Top
 - Breaks Keep With Next: Yes
- The Keep With Next option makes sure the letter heading is not isolated from the index entries that follow it.
- Ruling Line Width: Custom
 Below Pattern: Solid
 Space Above Rule 1: 02.00 fractional pts
 Height of Rule 1: 00.25 fractional pts
 Custom Width: (+) 48.00 fractional pts

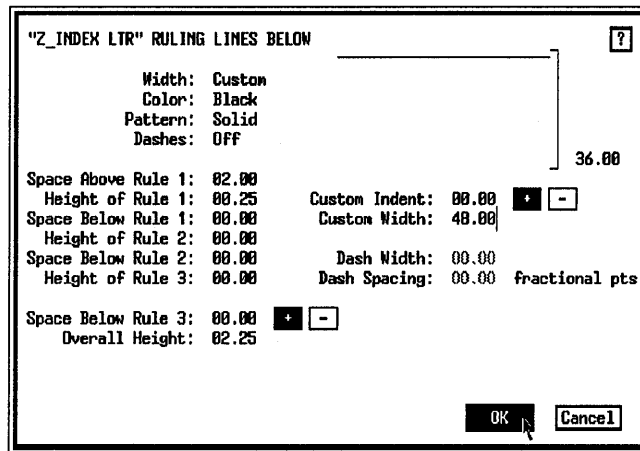

Change the Z_INDEX MAIN tag

The rest of text is tagged Z_INDEX MAIN. Primary and Secondary entries are positioned with horizontal tabs.

■ Select the first index entry that begins “Advertising.”

■ Font Size: 010.0 points

■ Alignment Horz. Alignment: Left
In/Outdent Width: 00,00 picas & points

■ Spacing Add in Above: When Not at Column Top

■ Tab Settings Tab Number: 1
Tab Type: Left
Tab Shown As: Open Space
Tab Location: 00,00 picas & points

Tab Number: 2
Tab Type: Left
Tab Shown As: Open Space
Tab Location: 01,06 picas & points

Tab Number: 3
Tab Type: Right
Tab Shown As: Leader Char
Tab Location: 22,06 picas & points
Leader Char: ...
Leader Spacing: 3

The screen should look like Figure 8–28.

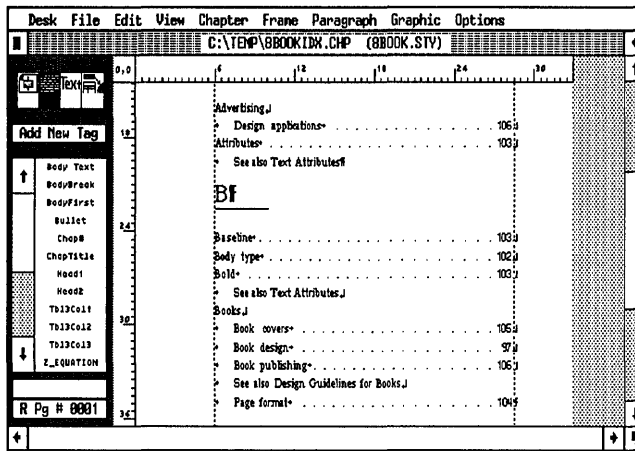

Figure 8-28.

When you have completed the changes to the index tags, save the chapter.

- Press Ctrl-S.

Print the publication

Now that you've created the TOC, the index and two sample chapters, you are ready to print them. First, add the TOC and the index to the C:\TEMP\8BOOK.PUB publication.

- While still in BOOKIDX.CHP, select Multi-Chapter from the Options menu.
- Open the C:\TEMP\8BOOK.PUB publication if it is not already open. Select Add Chapter and then choose C:\TEMP\8BOOKTOC.CHP.
- Select Add Chapter, and then choose the chapter C:\TEMP\8BOOKIDX.CHP.

Organize the book chapters by moving the TOC chapter to the top of the list.

- Drag C:\TEMP\8BOOKTOC.CHP to the top of the publication list.
- Make sure none of the files are highlighted.
- Select Save As to save this publication under the name C:\TEMP\8BOOK.PUB.

When Ventura asks you if you want to overwrite the existing publication, choose **Overwrite**.

Leave the Multi-Chapter dialog box open for printing.

Print crop marks

Now you will print out all the chapters listed in the publication using the **Print** function found in the Multi-Chapter dialog box. This time you will tell Ventura to print crop marks. Ventura is able to print crop marks as long as they reside within the live area of the printer (the area of the page on which the printer can actually produce marks). Almost all laser printers can show crop marks that fall inside a 7x10 in. area.

➔ *TIP: To find out the exact live area of your printer, print out the sample chapter CAPABILI.CHP in the \TYPESET subdirectory.*

| | |
|------------|------------------|
| ■ To Print | Which Pages: All |
| | Crop Marks: On |

Ventura prints out each chapter of the publication in order.

➔ *NOTE: This project contains more than 30 pages. It will take longer to print than other, shorter sample chapters in this book.*



Tips and techniques

Book tips

- The last thing you must do before generating an index and TOC, is to update the chapter and page numbers in every chapter included in the publication. Use **Update Counters** from the **Chapter** menu to reset the numbering in the correct sequence.
- If you want each chapter to start on a right-hand page (as is traditional), check that the preceding chapter ends on a left-hand page. If not, insert a blank left-hand page at the end of the preceding chapter.

- Changing page numbers with Update Counters (Chapter menu) does not affect the page numbers shown at the bottom of the Side-Bar.
- Some publishers use a single style sheet for the whole book. Others create a separate style sheet for each section. Although Version 2 of Ventura automatically numbers pages sequentially across chapters, it may be tempting to put the entire book in one large chapter file. In practice, very large chapters can lead to crashes or other problems, especially, if there are many pictures involved.
- Putting the entire book into one chapter file also makes it difficult to work in groups. When one person is busy with the one and only file, no one else can work on it. For easier access and manageability, most books should have separate Ventura chapters for every book chapter.

Table tips

- Generally, it's best to use tab settings when creating a table with single-line entries. For tables with multiple-line entries it is easier to use side-by-side paragraphs which allow each column to have more than one line.
- To prepare text for side-by-side paragraphs, make sure you enter each table entry as a single line. Enter a carriage return instead of a tab at the end of each line.
- Spacing and Breaks are the key to creating a table. Use In From Left and In From Right spacing to restrict text to individual columns. Use Breaks to allow multiple tags to reside on the same line.

Footnote and index tips

- The footnote separator line is measured from the left edge of the page, not from the margin. Only the portion *inside* the margin actually prints. Suppose, for example, that you have a five-pica margin. If you wanted a three-pica separator line, you would enter a Separator Line Width of eight picas ($5 + 3 = 8$). Only the three-pica portion that is inside the margin would print.

- If you cannot see the symbols which marks footnotes, anchors and index entries, choose Show Tabs & Returns from the Options menu.
- Footnotes occupy a special frame created by Ventura. You can change the margins inside this frame, but you cannot change the size of the frame.
- You can insert footnotes, anchors and index entries directly into word processing files using the following bracket codes:
 - Footnote: <\$Ftext>
 - Anchor (same page): <\$&Anchor name>
 - Anchor (below): <\$&Anchor name[v]>
 - Anchor (above): <\$&Anchor name[^]>
 - Fraction: <\$Enumerator/denominator>
 - Fraction: <\$Enumerator over denominator>
 - Index: <\$IPrimary; Secondary>
- Indexes and tables of contents are created with Multi-Chapter from the Options menu.

Chapter Nine Skills Checklist

Theory

- Technical illustrations for desktop publishing
- Importing AutoCAD drawings into Ventura

Text

- Assigning tags in Text mode
- Creating empty paragraphs

Style

- How to format numbered lists
- Adding a page break tag
- A double rule effect with ruling line above
- A special note tag with ruling box around
- Adding space with a tag
- Adding spot color to page elements

Picture

- Attaching callouts to illustrations
- Anchoring frames to text references
- Automatic figure numbering in captions

Chapter

- Printing spot color overlays

Chapter Nine

A Technical Manual

Modern industry has produced a new generation of publishers, writers, and designers, dedicated to creating “user-friendly” technical manuals. These manuals are instrumental in selling and maintaining high-tech equipment, from microwaves to machinery to personal computers. In this chapter, you will learn some special techniques for producing technical documentation with Ventura. The checklist on the left gives you an overview of the skills you will learn.

Theory

Technical documentation is a demanding application. Consequently, this chapter may require more than one attempt to create some of the effects. If you can stick with it, however, you will be rewarded with hands-on knowledge of some of Ventura’s most powerful capabilities. Before starting with the project, let’s take a moment to examine how Ventura deals with technical illustrations.

Technical illustrations

Skip this section if you do not use illustrations from line-art programs, such as AutoCAD.

As a general rule, line-art is used for technical drawings and illustrations because of its higher quality (see Chapter Five for more details on the difference between line-art and images). AutoCAD is one of the most popular line-art programs. AutoCAD drawings can be imported into Ventura in four different formats (SLD, GEM, HPGL, and PostScript), three of which produce line-art.

AutoCAD Slide Files (SLD) are image files (bit-mapped graphics) produced by taking a “snap shot” of an AutoCAD screen. Their quality is only as good as the resolution of the screen. Consider using slide files if you have access to a monitor with at least a 1,024 x 960 resolution, or if you do not require high-quality images. Otherwise, you will get better results from line-art.

You can import AutoCAD line drawings in three ways: in GEM format (via Ventura’s DXFTOGEM utility), in HPGL format (Hewlett Packard Graphics Language), or in Encapsulated PostScript format.

DXFTOGEM conversion

Ventura’s conversion utility takes AutoCAD DXF files (which it cannot read directly) and transforms them into GEM files (which it can use in documents). Before using the DXFTOGEM conversion, you must produce a DXF drawing file in AutoCAD (or any other CAD program that supports the DXF drawing interchange format). After the DXF file is created, use the DOS copy command to copy the file to the C:\VENTURA subdirectory.

Move to the C:\Ventura subdirectory. At the DOS prompt, type:

DXFTOGEM Filename Filename

First type the command name, followed by the AutoCAD DXF file name, a space, and the GEM file name, leaving off the three-letter extension. The DXF and the GEM file names can be the same or different. For example, here’s the command for converting a DXF file named SAMPLE.DXF to a GEM file named CADTEST.GEM:

DXFTOGEM SAMPLE CADTEST

After creating the GEM file, copy it to the subdirectory of your choice.

➡ *TIP: The DXFTOGEM utility is normally located in the C:\Ventura subdirectory. If you cannot find it there, load it from the Ventura Utilities disk.*

You may find that certain AutoCAD shapes are lost during the DXFTOGEM conversion. For a complete listing of shapes that are converted, see the Xerox Ventura Publisher Reference Guide.

HPGL format

HPGL is an alternative to the DXFTOGEM conversion. To create a HPGL file in AutoCAD, first configure your plotter as any Hewlett Packard plotter (for example, the HP 7475). Then plot the drawing to a file instead of to the plotter. The resulting file has a .PLT extension. You can load this file directly into Ventura, by selecting Line-Art Format: HPGL in the Load Text/Picture dialog box. Simply change the .HPG extension to .PLT on the Directory line of the Item Selector before selecting a file.

Encapsulated PostScript

AutoCAD can also produce a PostScript file, that, when modified, can be loaded into Ventura. To create a PostScript file in AutoCAD, configure your plotter for the desired resolution (300 dpi for a laser printer, 1270 or 2540 for a phototypesetter, etc.) and plot the drawing to a file instead of to the printer. The resulting file has a .PLT extension. Before you load it in Ventura, you must do two things: change the extension from .PLT to .EPS, and change three lines in the PostScript file itself.

To encapsulate an AutoCAD PostScript plot file, you will need to edit the file with an ASCII text editor. Begin by recording the four sets of numbers on the the bounding box line that is second from the end of the file listing. Now delete that line. To the top of the file add the following three lines:

```
%!PS-Adobe-2.0 EPSF-1.2  
%%BoundingBox: XX XX XXX XXX  
%%EndComments
```

Substitute the numbers you recorded from the original bounding box line for the Xs in the second line above. Now you are ready to load the encapsulated file. Select Load Text/Picture from the File menu, and choose Line-Art and PostScript format in the dialog box.

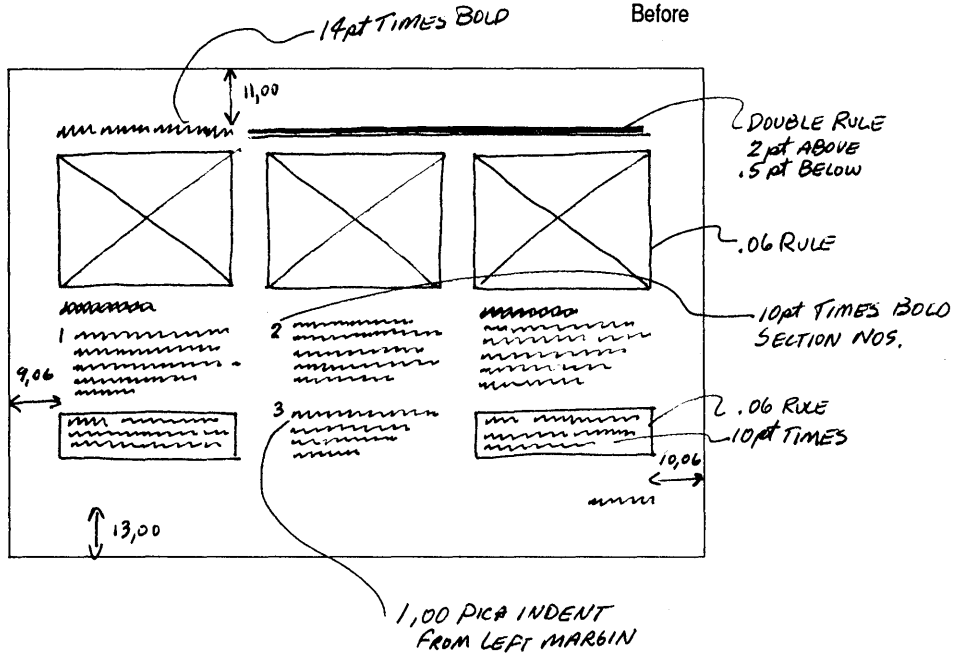

After

Paper Trays, Paper Cassettes

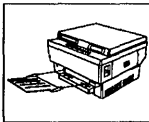

Paper Tray

1. Print tray position. Hold the print tray on the wide end front towards the front of the printer. Insert the plastic pins into the front slots above the handle.

NOTE: Do not overload the paper tray. Pushing it too full will cause paper jams and print errors.

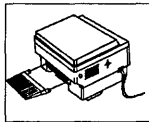

2. Attach the manual feed guide. Hold the manual feed guide with the plastic handles towards the rear of the printer. Place the ribbon side up.

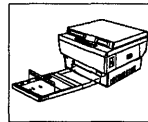

Paper Cassette

Place the paper in the cassette and push it under the paper clips. Insert the paper cassette into the slot under the front of the printer until it snaps. The cassette holds approximately 110 sheets.

NOTE: If you want to print on letterhead, place the paper FACE DOWN towards the clips.

3

Laser Jet II Manual

Planning the manual

Whether it deals with a microwave or a microcomputer, the primary responsibility of a technical manual is to teach the user how to operate and benefit from the system. It must include all the technical specifications. It must also help the user get started, discover features, and learn both elementary and advanced operations. Finally, it must help people know what to do when things go wrong.

The manual you will create in this chapter includes instructions for assembling and using a laser printer. Its landscape format provides space for three columns without crowding the text. The three-column format also provides flexibility for varying picture sizes and column combinations. On some pages, the left column is used for the major heading and nothing else. The resulting white space gives the page a more open, non-threatening appearance.

Throughout the manual, lists are identified with bullets, and step-by-step instructions are shown with boldface section numbers. The instructions are slightly indented from the numbers to make them easy to locate on the page. The box around the warnings is a visual device to draw attention to important material not included in the main body of text.

The manual has two standard sizes for illustrations. Smaller pictures fit three across. Because they are positioned directly above descriptive text, they do not demand captions or callouts. On the other hand, a full page illustration needs a caption and/or callouts for clarity.

The “before” and “after” illustrations show the manual in the planning and final stages. In addition to many of the skills you already have learned, you will use the following effects to create the technical manual:

- Column breaks
- Section numbers
- Rules around table entries
- Callouts for illustrations
- Spot color for emphasis

Ventura prep



If you have the Power disk

- If you are continuing from a previous chapter, select New from the File menu to clear the work area.
- Load the ASCII file 9TECH.TXT from the C:\POWER subdirectory. Use File Type/Rename to save it as C:\TEMP\9TECHDOC.TXT. Leave the file 9TECHDOC.TXT on the Page.
- Load the style sheet, 9TECH.STY from the C:\POWER subdirectory and save it as C:\TEMP\9TECHDOC.STY.
- Load the GEM Line-Art format files 9-LASER1.GEM, 9LASER-2.GEM, 9LASER-3.GEM, and 9LASER-4.GEM from the C:\POWER subdirectory.
- Save the chapter as C:\TEMP\9TECHDOC.CHP.



If you do not have the Power disk

- Use your word processor to type in the text file 9TECH.TXT from Appendix A. Then save it as C:\TEMP\9TECHDOC.TXT.
- Use Load Text/Picture to load and place the file 9TECHDOC.TXT on the Page.
- Load the &TBL2-L1.STY style sheet from the C:\TYPESET subdirectory. Change the margins and columns to match Figure 9-1. Use the tag table in Appendix B to change the tags you will need for the project. Then save the revised style sheet as C:\TEMP\9TECHDOC.STY.
- Since you do not have access to the AutoCAD drawings included on the Power Disk, load any four pictures to use as substitutes in the picture section of this chapter.
- Save the chapter as C:\TEMP\9TECHDOC.CHP.

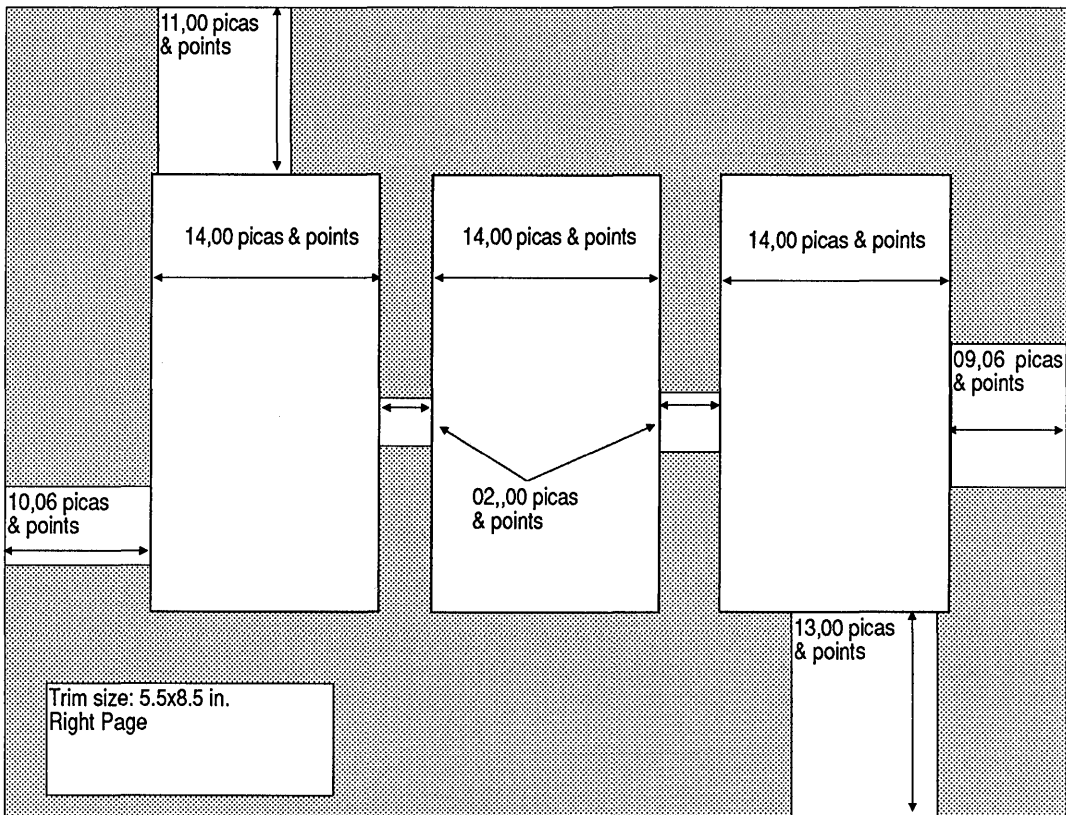

Figure 9-1.

Style

You will learn several powerful new functions in the style section of this chapter. You will start by learning a fast way to draw crop marks. Then you will learn about new tagging effects using column breaks, page breaks, and ruling lines. You will continue with an example of auto-numbering, a useful technique for technical documentation.

Draw crop marks

Crop marks designate the live area of the paper. For this document, you will draw the crop marks at each corner of the Page and instruct Ventura to show them on every page of the document.

- *TIP: It is easier to draw crop marks if you temporarily change the margin settings to equal the trim size. Then you can use the (temporary) column guides to help you position the lines.*
- Enable Frame mode and select the Underlying Page. Select Margins & Columns from the Frame menu.
- Choose # of Columns: 1. Make the top and bottom margins 09,00 picas & points, and the left and right margins 07,06 picas & points (Figure 9-2).

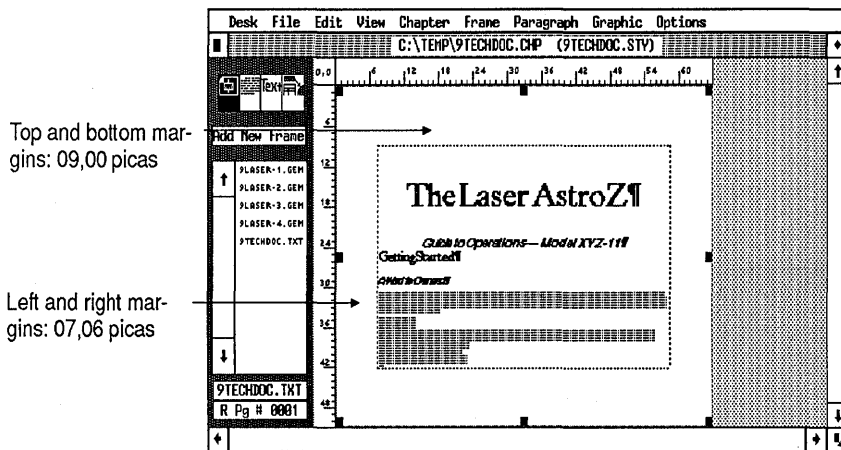

Figure 9-2. After you change the margins, your page should look like this illustration.

Choose grid settings

- Make sure the zero point is reset to the upper left corner of the Page. (Click on the 0,0 square at the upper left corner of the Page.)
- With the Page selected, enable Graphics mode.
- Select the line tool from the Side-Bar.

Make the grid settings an integer multiple of the margins so the lines automatically snap to the margin.

- Grid Settings Grid Snap: On
Horizontal Spacing: 01,06 picas & points
Vertical Spacing: 01,06 picas & points

- Select the line tool again. Starting from the upper left corner of the column margin, draw a 03,00 pica vertical line (two snap-grid units) perpendicular to the horizontal column guide and toward the edge of the Page (Figure 9-3). Press the Alt key as you draw to keep the line absolutely straight.

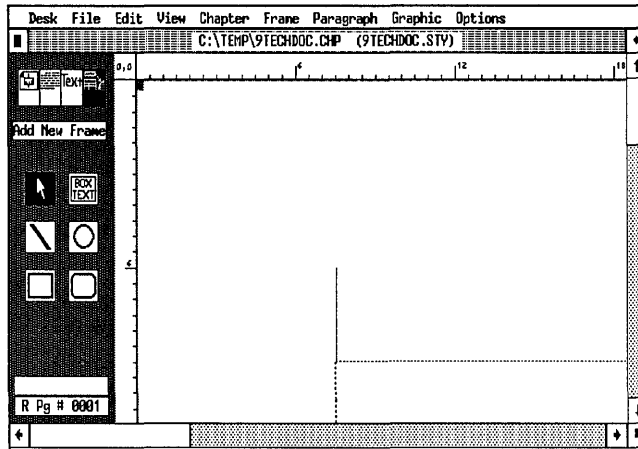

Figure 9-3.

- *NOTE: Don't worry if it takes you a couple of attempts to draw the correct line. Drawing with a mouse can be tricky. If you make a mistake, simply delete the line (press the Del key) and try again.*

Now make sure the line attributes match the following values:

- Line Attributes Thickness: Thin
 End Styles: (Beginning and End) Square
 Defaults: Save To

- *TIP: If you hold down the Shift key while drawing, you can continue to draw lines without reselecting the line tool.*

- Select the line tool. Starting at the upper left corner of the column guide draw a 03,00 pica horizontal line (two snap-grid units) perpendicular to the vertical column guide and toward the edge of the Page (Figure 9-4).

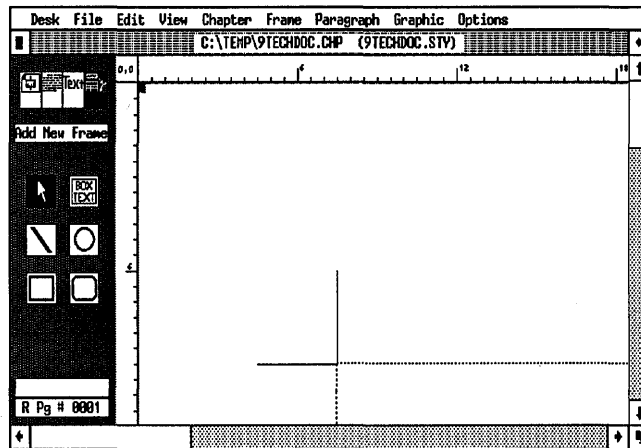

Figure 9-4.

Repeat the steps above to create crop marks on the other three corners on the page. When you are finished, reset the margins and columns to their original values. Refer to Figure 9-5 for the original margin and column sizes.

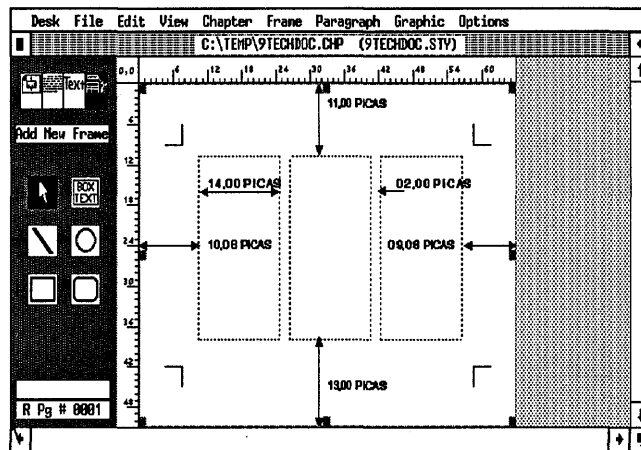

Figure 9-5.

After drawing the crop marks, make them appear on every page of the document.

- While still in Graphic mode, choose Select All from the Graphic menu (or press Ctrl-Q) to select every line shape on the Page.
- Select Show On All Pages from the Graphic menu.

Build the footer

You will complete the chapter format by building the footer.

- Select Headers & Footers from the Chapter menu.
- Choose Define: Right Page Footer, Usage: On. Move to the Left line and choose 1st Match. Delete the words “tag name” and type: **Head1**
- Move to the Right line and choose Inserts: Page #.

The screenshot shows the 'HEADERS & FOOTERS' dialog box. Under the 'Define:' section, 'Right Page Footer' is selected. The 'Usage:' section has 'On' selected. The 'Left:' field contains '<Head1'. The 'Right:' field contains '[PH]'. Under the 'Inserts:' section, 'Page #' is selected. The 'Text Attr.' and 'Copy To Facing Page' options are also visible.

- Choose Define: Left Page Footer, Usage: On. Move to the Left line and choose Inserts: Page #. Move to the Right line and type: **Laser AstroZ Manual**

The screenshot shows the 'HEADERS & FOOTERS' dialog box. Under the 'Define:' section, 'Left Page Footer' is selected. The 'Usage:' section has 'On' selected. The 'Left:' field contains '[PH]'. The 'Right:' field contains 'Laser AstroZ Manual'. Under the 'Inserts:' section, 'Page #' is selected. The 'Text Attr.' and 'Copy To Facing Page' options are also visible.

The footer text is automatically formatted as soon as you close the dialog box. (The Z_FOOTER tag was predefined in the style sheet you loaded at the beginning of the chapter.)

Raise the footer

To prevent the footer from being cropped off at print time, you must raise it upward on the page.

- ☒ Enable Frame mode. Select the footer frame so you can change its margins.
- ☒ Margins & Columns Top: 02,00 picas & points
 Inserts: Copy To Facing Page

Now you will turn off the footer on page one.

- ☒ Select Turn Footer Off from the Chapter menu.

Because a cover page is not normally numbered, you must update the page counter so that “page one” starts on the second page of the chapter.

- ☒ Press PgDn to go to page two.
- ☒ Select Update Counters from the Chapter menu.
- ☒ Choose Which Counter: This Page, Update Method: Restart Number, With Number: 0001, Number Format: 1,2.

The page number in the footer changes to 1 (Figure 9–6).

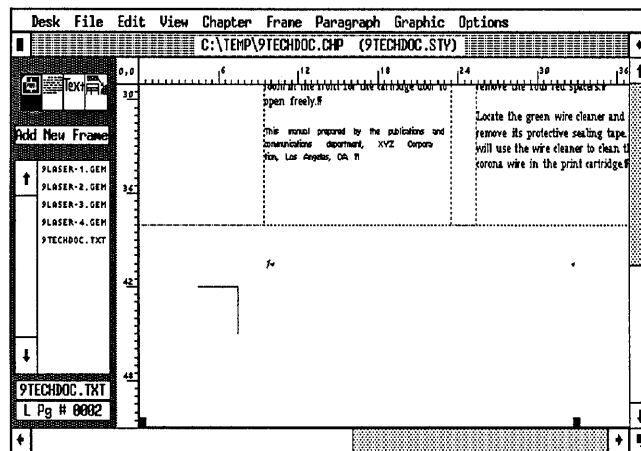

Figure 9-6.

➡ **NOTE:** If the following pages do not automatically increase, you will have to renumber them manually. Move to each page in turn and select *Update Counters* from the *Chapter* menu. Choose *Which Counter: This Page*, *Update Method: Previous Number + 1*, and click *OK*, until all pages are in the correct sequence.

With the chapter format complete, you can begin to assign tags to the text.

Verify the Body Text settings

- Press Home to go to the beginning of the chapter.
- Enable Paragraph mode.
- Select the paragraph “Thank you for choosing the Laser AstroZ...”
- Font
 - Face: Times
 - Style: Normal
 - Color: Black
 - Size: 010.0 points
- Alignment
 - Horz. Alignment: Left
 - Overall Width: Column-Wide
- Spacing
 - Above: 12.00 fractional pts
 - Inter-Line: 12.00 fractional pts
 - Add in Above: When Not At Column Top

Create a title page with the BodyBreak tag

To isolate the title page text from the rest of the document, you will create an empty paragraph (a paragraph that includes a carriage return only) and tag it with the *BodyBreak* tag. Since the *BodyBreak* tag (which has already been defined in the style sheet) includes a page break after, the text following the tag will be forced to the next page.

- Enable Text mode to create the empty paragraph. Place the text cursor at the end of the paragraph “Guide to Operations — Model XYZ-11” and press Enter once.
- Enable Paragraph mode.

- Select the empty paragraph (click on the paragraph symbol ¶) and tag it as BodyBreak (Figure 9-7).

This text will be forced to the next page by the Body-Break tag

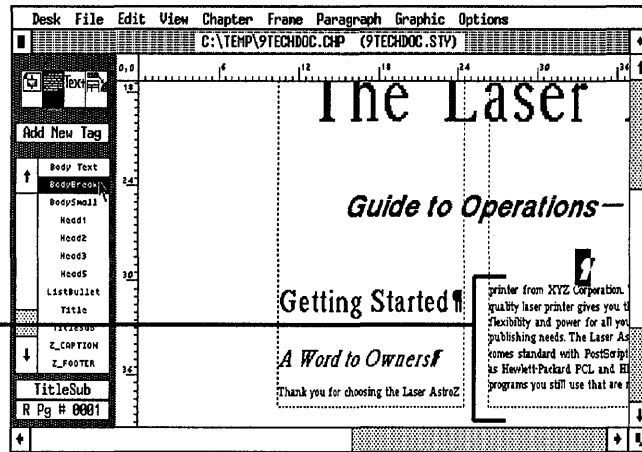

Figure 9-7.

The text following the tag moves to the next page (Figure 9-8).

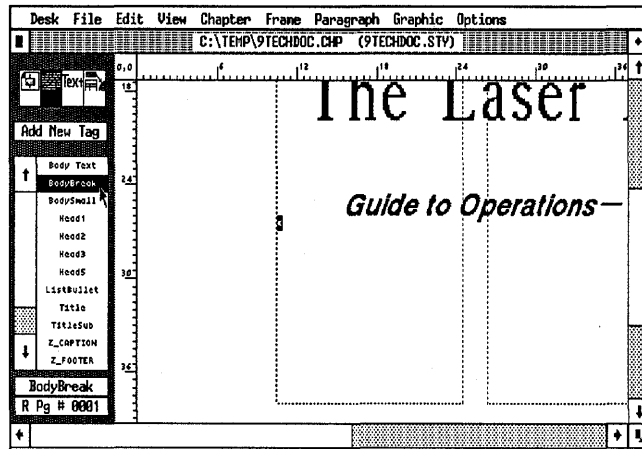

Figure 9-8.

With the title page complete, go to the second page to continue tagging.

- Press PgDn to go to the second page.

Change the Head1 tag

To isolate the Head1 tag in the far left column, you will include a column break before and after. The Column Break Before keeps the heading from slipping back to the previous page. The Column Break After forces the text following the tag to start at the top of the next column.

- Select the paragraph “Getting Started.”
- Select Breaks. Choose Column Break: Before & After.

"Head1" BREAKS

Page Break: No Before After Before & After

Before/Until Left Before/Until Right

Column Break: No Before After Before & After

Line Break: No Before After Before & After

Next V Position: Normal Beside Last Line of Prev. Para

Allow Within: Yes No

Keep With Next: Yes No

OK Cancel

Use the BodyBreak tag

To start a new page, you will put a page break after the BodySmall paragraph at the end of page one. You will first create an “empty” paragraph. Then you will assign the Body-Break tag to a function key so you can tag the empty paragraph while you are in Text mode.

- Enable Text mode. Place the text cursor after the words “LOS ANGELES, CA” at the bottom of the page and press Enter once (Figure 9–9).

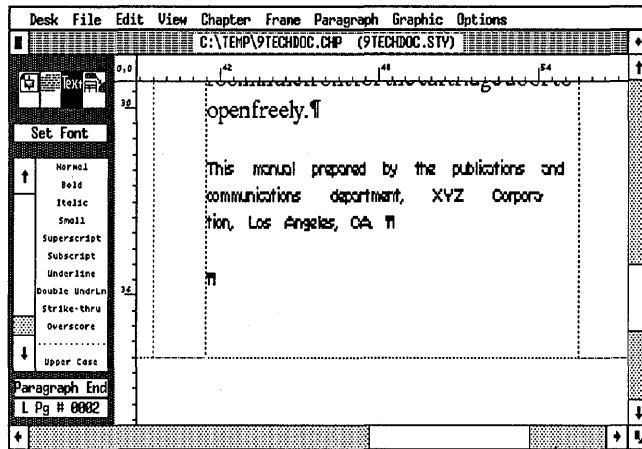
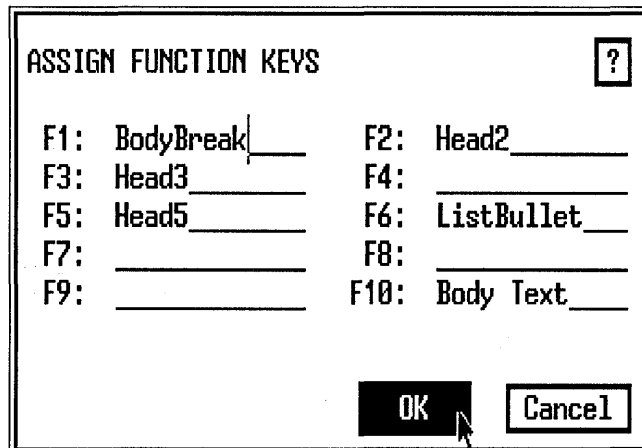

Figure 9-9.

- Without moving the cursor from its current position, press Ctrl-K to bring up the Assign Function Keys dialog box.

➔ *NOTE: If you press Ctrl-K while you are in Paragraph mode, Ventura will ask you if you want to save your changes.*

- Assign the BodyBreak tag to the F1 key. Click OK to close the dialog box.



➔ *NOTE: Do not be concerned if your function key assignments do not match ours exactly.*

- Press F1 to tag the empty paragraph you just typed as BodyBreak.

The text following the tag is pushed to the next page.

➔ *TIP: If you accidentally hit the wrong function key while tagging, you can usually recover by pressing the correct key immediately, before you do anything else.*

About auto-numbering

For the first two pages, you formatted the manual using predefined tags from the style sheet. In the next section, you will create some advanced effects by adding several tags.

Many technical documents include section numbers, outlines, or numbered lists. Ventura's automatic numbering can handle these chores for you. It can create anything from simple lists to multi-level outlines. Rearrange part of the list, and Ventura will renumber it for you — automatically. Automatic numbering includes two basic steps: First, you choose which tags to number and what style of numbering to use; second, you format the section numbers Ventura has generated. For the first step, use the Auto-Numbering dialog box from the Chapter menu to choose which tags to number and what style to use. For example, Figure 9-10 shows the dialog box settings for Head1 displayed in roman numerals (I, II, III, IV, etc.)

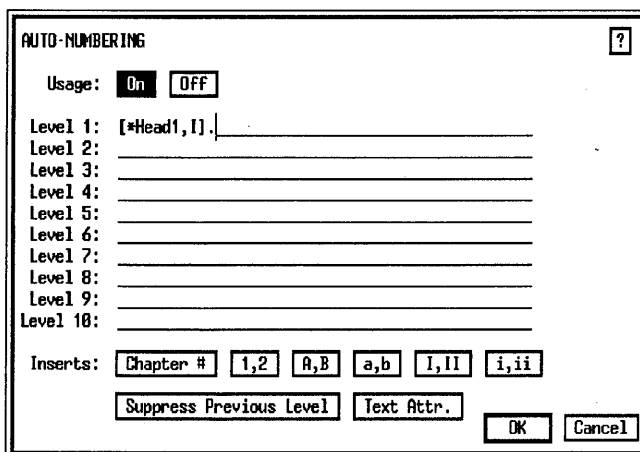

Figure 9-10.

When Ventura creates the numbers, it assigns generated tags at the same time. The name of the tag depends on the level of the numbers. Numbers created at Level 1 are tagged as Z_SEC1. Level 2 numbers are tagged as Z_SEC2, and so on. Once Ventura has generated and tagged the numbers, you can format them as you like. The theory of auto-numbering will become clearer after you perform the sample project in this chapter.

To create the numbered list of instructions, you will add a new tag named List#. The tag is indented from the margin to make room for the section numbers (which you will add below using Auto-Numbering).

- Press PgDn to go to the third page of the chapter.
- Enable Paragraph mode.
- Select the paragraph in the second column that begins “Lift the release lever....”
- Add New Tag Tag Name to Add: List#
- Spacing In From Left: 01,00 picas & points

Use Shift-Click to select the next two paragraphs shown in Figure 9–11 and tag them as List#.

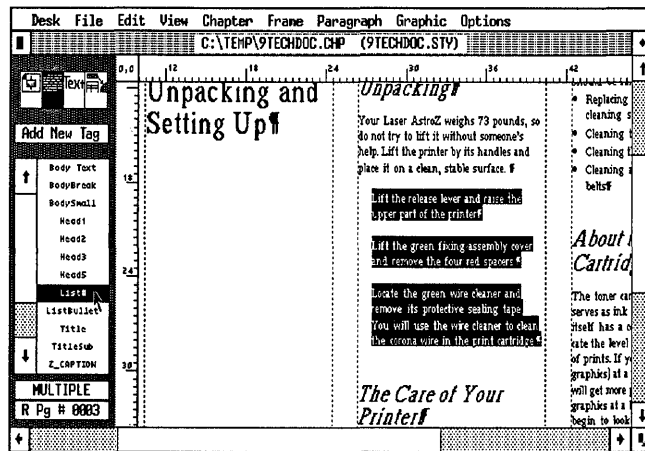

Figure 9–11.

Next, we will show you how to use Auto-Numbering to generate the numbered list.

Using auto-numbering

To create the numbered list, use Auto-Numbering from the Chapter menu. By placing the List# tag on Level 1, you instruct Ventura to place numbers before each paragraph tagged as List#. After Ventura generates the section numbers, you format them to reside on the same line as the List# paragraph.

➔ *NOTE: Although we are teaching a single level list, you can use these same basic principles to create multi-level numbered lists such as outlines.*

- ☒ Select Auto-Numbering from the Chapter menu.
- ☒ Choose Usage: On. Move to the Level 1 line and choose Inserts: 1,2. This button defines the number format for the list.
- ☒ Delete the words “tag name” and type **List#**, then move the cursor past the right bracket and type a period. The period separates the automatically generated numbers from the text that follows. Click OK.

The screenshot shows the 'AUTO-NUMBERING' dialog box. At the top right is a question mark icon. Below it, the 'Usage:' section has two buttons: 'On' (selected) and 'Off'. The 'Level 1:' field contains the text ' [*List#,1].'. Below this are ten empty lines for 'Level 2:' through 'Level 10:'. The 'Inserts:' section contains a row of seven buttons: 'Chapter #', '1,2', 'A,B', 'a,b', 'I,II', and 'i,ii'. Below this row are two more buttons: 'Suppress Previous Level' and 'Text Attr.'. At the bottom right are 'OK' and 'Cancel' buttons.

Notice that the numbers (which are tagged as Z_SEC1) and the text paragraphs (tagged as List#) appear on separate lines. To place both number and paragraph text on the same line, you will change the attributes of the Z_SEC1 and List# tags (Figure 9-12).

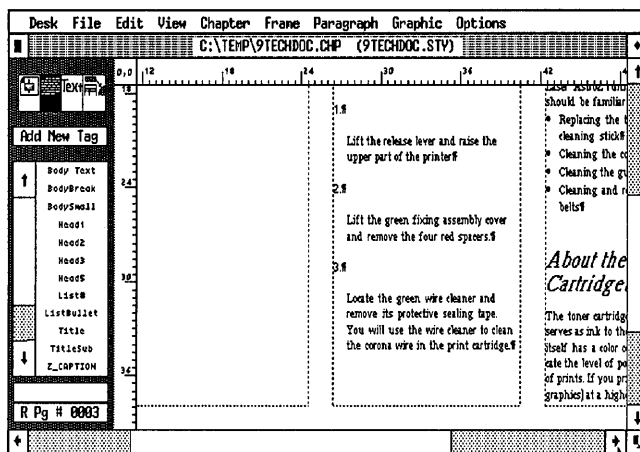

Figure 9-12.

Change the Z_SEC1 tag

- Select the number 1 (the Z_SEC1 tag).
- Font Style: Bold
- Breaks Line Break: Before
Keep With Next: Yes

Change the List# tag

- Select the first List# paragraph “Lift the release lever and raise the upper part of the printer.”

Now you will change the tag to include a line break *after*. The line break after allows the List# and Z_SEC1 tag to reside on the same line.

- Breaks Line Break: After

Earlier, you used In From Left Spacing to add a first line indent to the List# tag. You can see now how this indent keeps the List# paragraphs from touching the numbers. When you are finished the list should look like Figure 9–13:

- ➡ **NOTE:** *If you had created the indent with the In/Outdent option in the Alignment dialog box, only the first line of the paragraph would have been indented.*

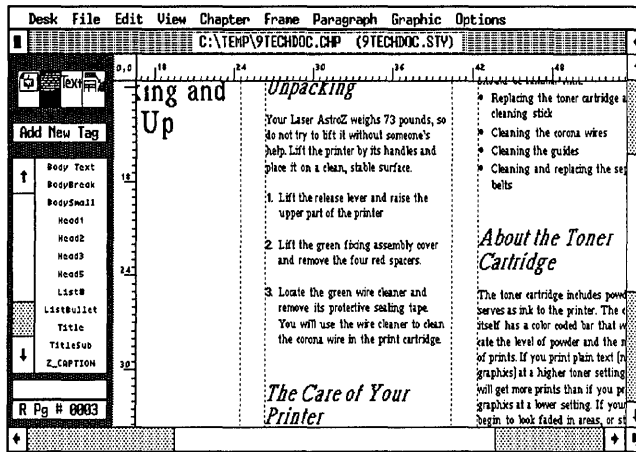

Figure 9-13.

Add a page break

To complete the page, you will create an empty paragraph and tag it as BodyBreak. The text following the tag will move to the next page.

■ Enable Text mode.

■ Place the text cursor at the end of the last paragraph in the third column "...replace your toner cartridge." Then press Enter once (Figure 9-14).

■ While the text cursor is next to the end of paragraph symbol, press F1 to tag the new paragraph as BodyBreak.

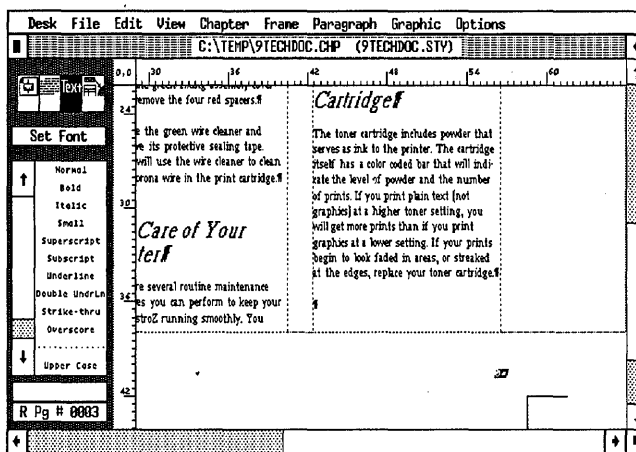

Figure 9-14.



Stopping point

Let's pause here to summarize where we've been and what lies ahead. You certainly have reason to be pleased with yourself. In the last few pages, you have been working with two of Ventura's most powerful and sophisticated functions, Breaks and Auto-Numbering. The ability to associate breaks and numbers with tags sets Ventura apart from ordinary programs. When you can manipulate these two dialog boxes with ease, you will stand out from the crowd.

Before you stop, check your progress against Figure 9-15.

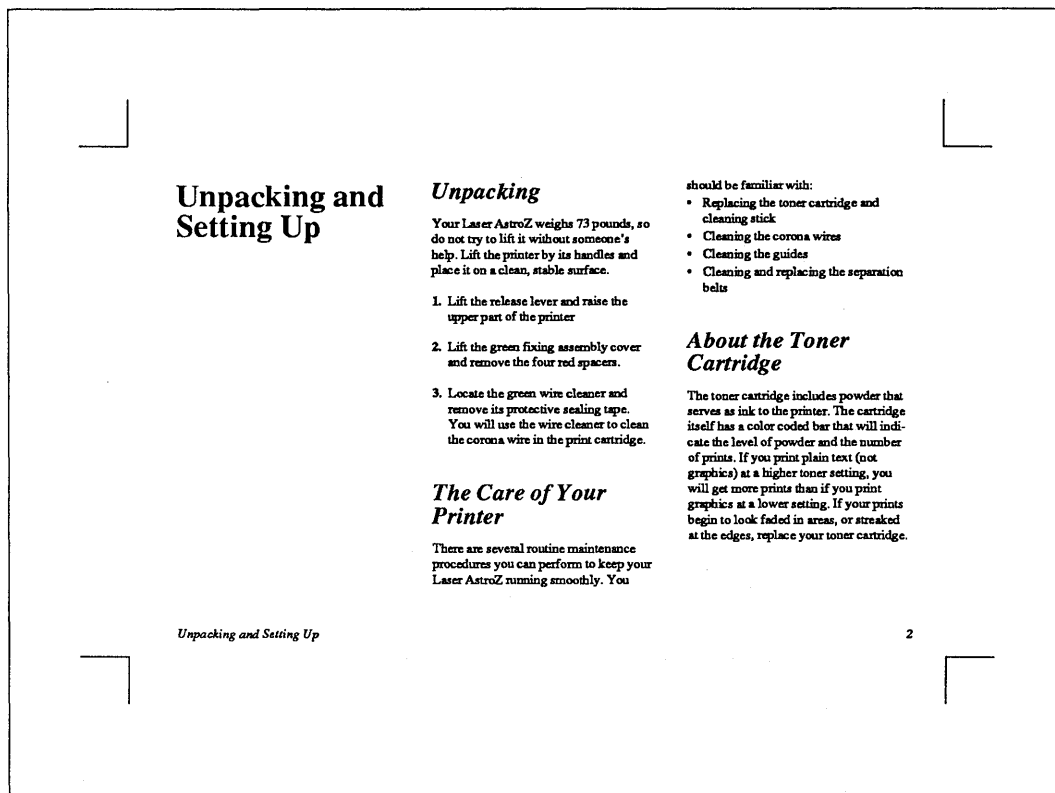

Figure 9-15 At this stage in the project, page three of your document should look like this.

If you're planning to stop and relax for awhile, save the document and exit from Ventura. When you're ready to start again, reload Ventura and open the chapter C:\TEMP\9TECH-DOC.CHP.

| | |
|-------------|---|
| ■ Alignment | Overall Width: Frame-Wide |
| ■ Spacing: | Above: 00.00 fractional pts Inter-Line: 18.00 fractional pts |
| ■ Breaks | Page Break: Before Keep With Next: No |

Your paragraph should now look like Figure 9–17.

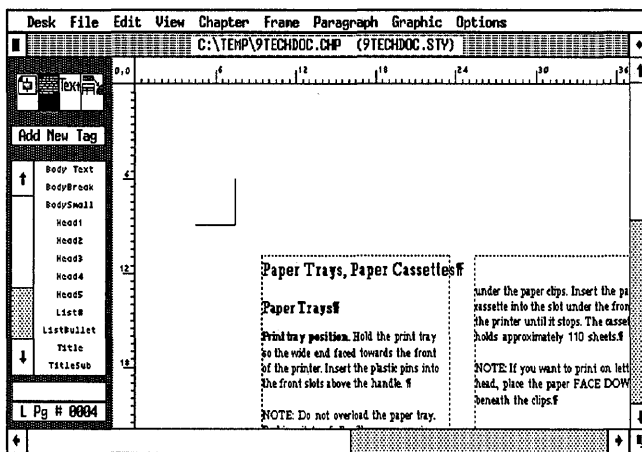

Figure 9–17.

The Page Break Before guarantees that Head4 will always start on a new page.

Next you will add the Rule tag. The paragraph tagged as Rule will include two characters: a horizontal tab and a paragraph return (¶). With Tab Settings (Paragraph menu), you will set the tab location at the right margin of the page. Then you will choose Ruling Line Above: Text. In this case, the only text is the tab character itself. Ventura extends the rule the length of the text — that is, to the tab location at the right margin.

WARNING: The effect you are learning is a complex one. Do not be concerned if text temporarily overlaps as you proceed. Once you complete all the steps, the text will realign properly.

- Enable Text mode.
- Verify that Show Tabs & Returns is on from the Options menu.

- Place the text cursor before the “P” in the word “Paper trays” on the second line. Press Enter once to create an empty paragraph (Figure 9–18).

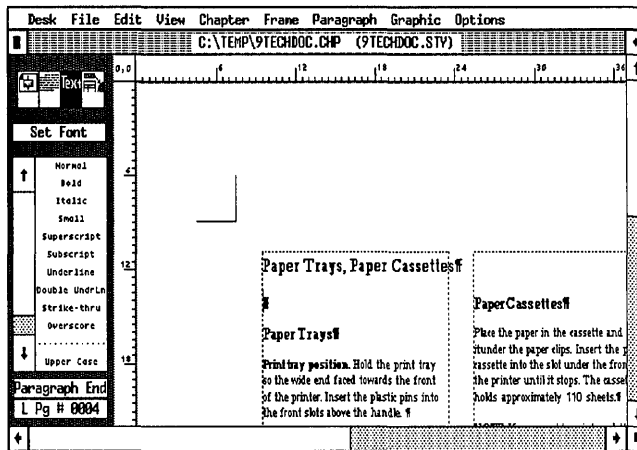

Figure 9–18.

Now you will enter the tab character.

- Place the text cursor in front of the new end of paragraph symbol (§) and press the tab key once.

You will see the tab character on-screen (Figure 9–19).

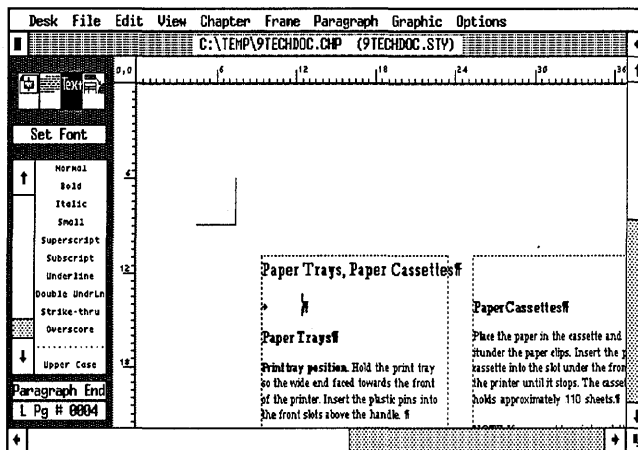

Figure 9–19.

Now you will change the tab location with Tab Settings in the Paragraph menu.

- Enable Paragraph mode.
- Select the paragraph that includes the tab character and the end of paragraph symbol (Figure 9-20).

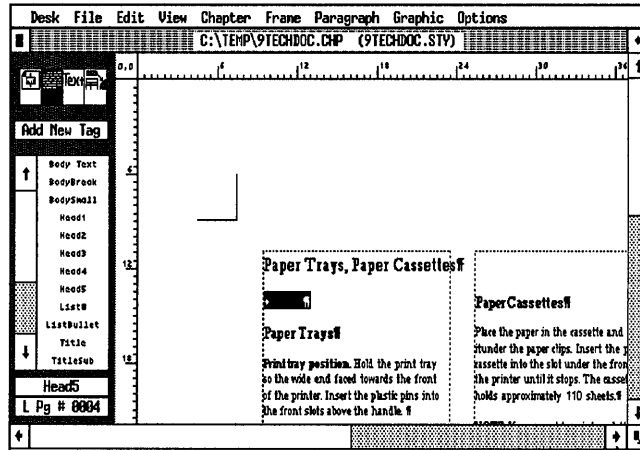

Figure 9-20.

- Add New Tag Tag Name to Add: Rule
- Alignment Overall Width: Frame-Wide
First Line: Indent
Relative Indent: On
In/Outdent Width: 00,04 picas & points

The relative indent aligns the beginning of this paragraph with the end of the previous paragraph — no matter how long or how short the previous paragraph may be. Since you don't want the rule to touch the text, you must also specify an extra 00,04 picas & points indent to separate the rule from the text.

- Tab Settings Tab Number: 1
Tab Type: Right
Tab Shown As: Open Space
Tab Location: 46,00 picas & points

The new tab location moves the paragraph symbol to the right margin (Figure 9-21).

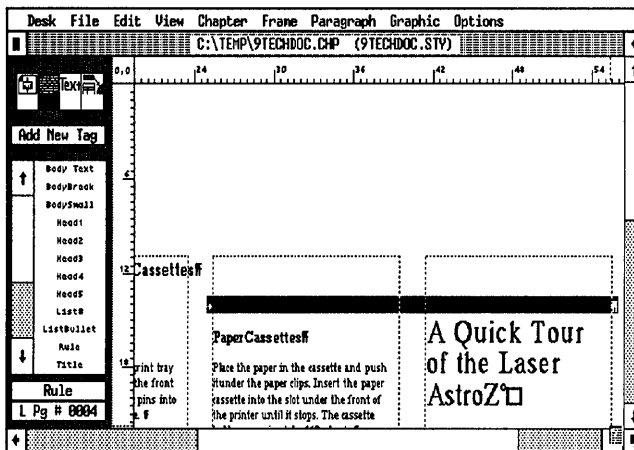

Figure 9-21.

At this point the Head4 and Rule tags still reside on separate lines. With the Rule paragraph still selected, use the Breaks dialog box to put them on the same line.

☒ Breaks Line Break: After

Add a ruling line above

You've placed the Rule tag on the same line, but it doesn't make much difference yet because nothing is showing in the Rule paragraph. Now you will make it visible by creating two ruling lines above.

In the next step you are going to create a double rule that is the width of the text. Recall that you created the paragraph with a tab stop (which is invisible) instead of actual text. Nevertheless, Ventura sees the tab as text. When you make the ruling line text-wide, the double rule stretches from the end of the Head4 paragraph to the tab location at the right margin.

☒ With the empty paragraph still highlighted, select Ruling Line Above. Choose Width: Text. Give Rule 1 a height of 02.00 fractional pts and make the Space Below Rule 1 02.00 fractional pts. Give Rule 2 a height of 00.50 fractional pts. Make the Space Below Rule 3 negative (-) 09.00 fractional pts. Click OK.

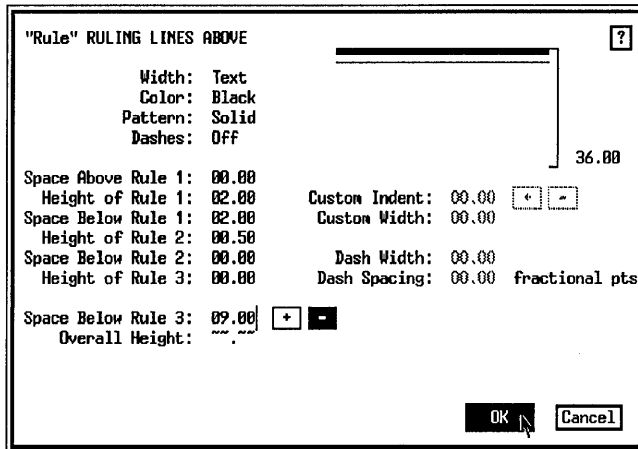

The negative value for Space Below Rule 3 shifts the rule down from its original location and aligns it with the Head4 paragraph (Figure 9–22).

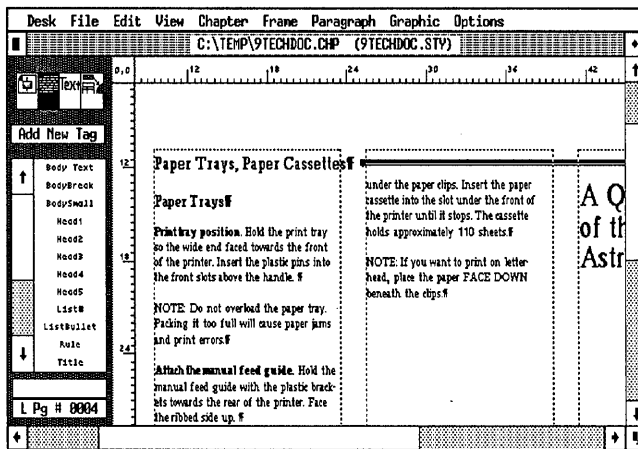

Figure 9–22.

Since you gave the Rule tag a line break after, the double rule appears right next to the Head4 tag.

Add the Note tag

The Note tag isolates special warnings and procedures inside a box. To create the box around the Note tag, you will use the Ruling Line Around dialog box. As is often the case with Ventura, there is more than one way to create the effect we

will show you. You could also achieve a similar effect with frames or with Box Text. Each method has its advantages and disadvantages. The method we are showing you relies on tag attributes. It has the advantage of allowing you to change the look of multiple paragraphs throughout the entire document by changing a single tag.

- Select the paragraph that begins “NOTE: Do not overload the paper tray ... ” in the first column of the page.
- Add New Tag Tag Name to Add: Note
- Spacing In From Left: 01,00 picas & points
 In From Right: 01,00 picas & points
- Select Ruling Box Around. Choose Width: Column. Give Rule 1 a height of 00.06 fractional pts and make the Space Below Rule 1: 03.00 fractional pts.

The Space Below Rule 1 adds extra space between the text and the ruling box (Figure 9–23).

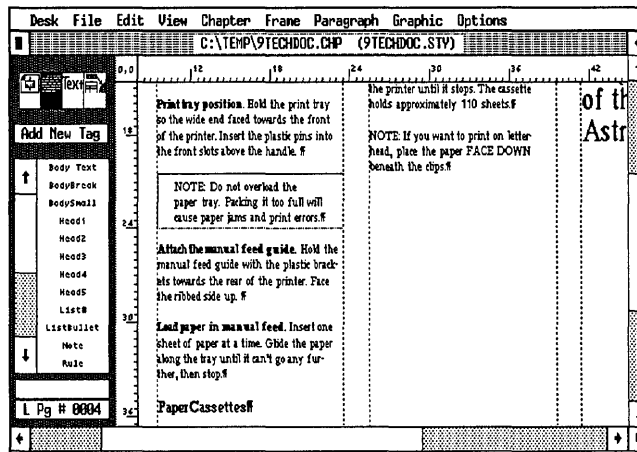

Figure 9–23.

Once the Note tag is defined, you can apply it to the next Note paragraph.

- Select the paragraph that begins “NOTE: If you want to print on letterhead ...” in the second column and tag it as Note.

➔ *NOTE: You can force Ventura to keep all of the paragraph together by choosing Allow Within: No from the Breaks dialog box. Ventura will not allow line breaks within the paragraph. Instead, it will move the entire paragraph to the next column or page if necessary to keep the paragraph together. However, this method has the danger of leaving large gaps of white space at the bottom of the previous column.*

Create a second list

You will now create a second numbered list by tagging three paragraphs as List#.

➔ *NOTE: Because the List# tag has a Line Break After, the three paragraphs you tag will shift on top of preceding paragraphs. This temporary confusion will be eliminated as soon as you renumber the chapter.*

■ Select the following paragraphs and tag them with the List# tag.

“Print tray position...”

“Attach the Manual Feed Guide...”

“Load Paper in Manual Feed...”

To generate numbers for the newly tagged List# paragraphs, use Ventura’s Renumber Chapter function.

■ Select Renumber Chapter from the Chapter menu or press Ctrl-B (Figure 9-24).

➔ *TIP: Despite its name, Renumber Chapter does not affect chapter numbering. It applies only to Auto-Numbering.*

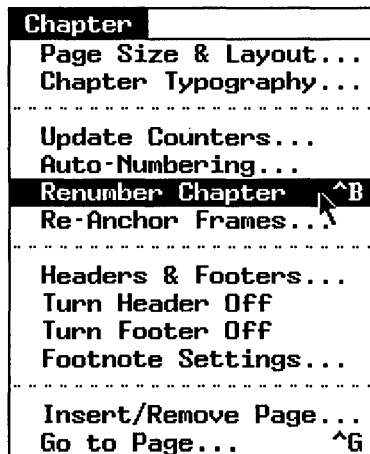

Figure 9-24.

Create multiple lists

After renumbering the chapter, the instructions are numbered sequentially, but they start with the number four (Figure 9-25).

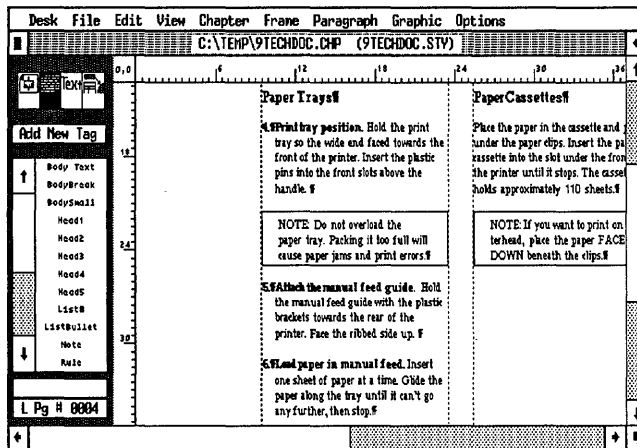

Figure 9-25.

Ventura starts with the list with the number four because it assumes that the sequence continues from the list on the previous page. In some cases, you may want a list that is numbered sequentially throughout the chapter. In other cases, however, you may want multiple lists that start num-

bering over again at one. We will show you a quick way to restart the numbering.

Whenever Ventura encounters a Level 1 tag, it resets the numbering for all the lower levels. By putting ordinary Body Text at Level 1, you trick Ventura into restarting the numbering for Levels 2 and below. In this case, then, you will use Body Text for Level 1 and List# for Level 2.

- Select Auto-Numbering from the Chapter menu.
- Place the text cursor next to the Level 1 line and press Esc to clear the line. Choose Inserts: 1,2. Delete the 1, the comma, and the words “tag name.” Then type: **Body Text**

By deleting the 1, you tell Ventura to number Body Text *but not to show the numbers*. In effect, then, you have “invisible” numbers.

- Move the text cursor next to the Level 2 line. Select Inserts: 1,2. Remove the words “tag name”, but keep the 1 and the comma. Then type: **List#**
- Add a period after the right bracket. Click OK.

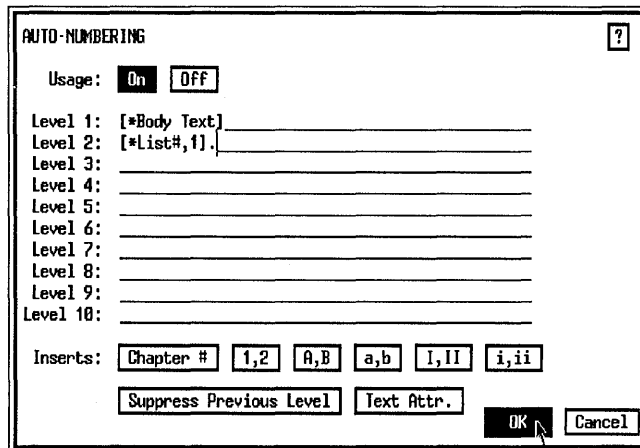

The list now starts over at one (Figure 9–26).

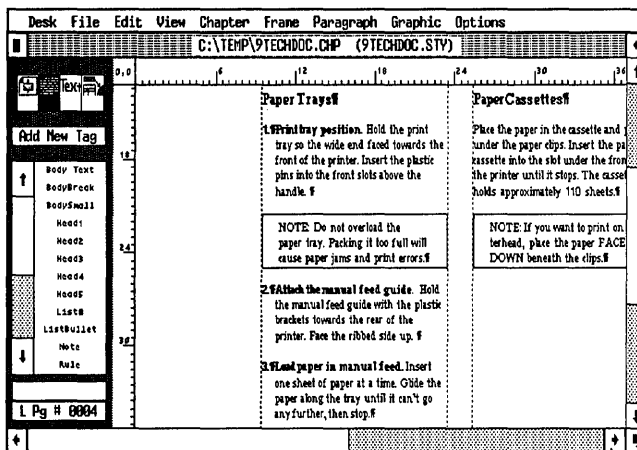

Figure 9-26.

➔ **NOTE:** The numbers are now tagged as `Z_SEC2`, since they are now on Level 2 in the Auto-Numbering dialog box. If you are using the style sheet from the Power disk, this tag has already been defined for you. If not, copy the attributes set forth for `Z_SEC1` earlier in this chapter.

Add a page break

When you're finished with Auto-Numbering, you will enter a page break after the last Note paragraph to push the rest of the text to the next page. Then leave the page as is. In the next section you will add frames and pictures to this page.

- Enable Text mode.
- Place the text cursor at the end of the paragraph "NOTE: If you want to print on letterhead..." Press Enter (Figure 9-27).
- Press F1 to tag the new paragraph as BodyBreak.

You have formatted the final paragraph in the 9TECHDOC.TXT file. Before we continue, let's take stock once again. You've already learned about breaks and Auto-Numbering. Now you are ready to tackle a new feature that will add spark and dazzle to your Ventura documents. Get ready for some fun.

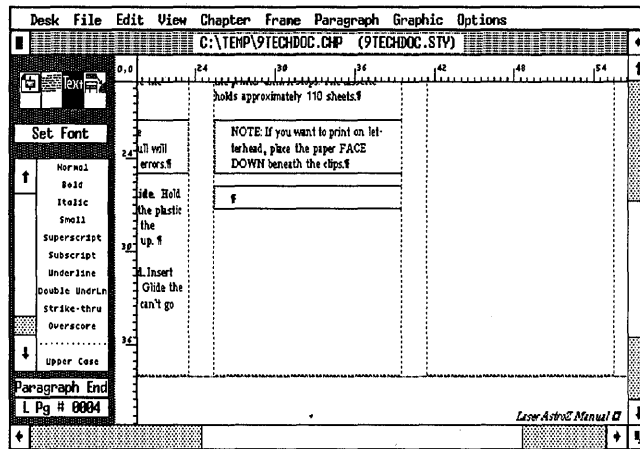

Figure 9-27.

Adding spot color

If you have the budget, color can add an extra dimension to your visual communication. With color, you have a powerful visual aid that can add impact and import to information in a document. Color can jazz up a dull report or transform a lackluster manual. As you plan for color in your publication, don't get lured into the snare many beginners find themselves in: placing too many colors in too many shades on a single page. You'll find that too many conflicting colors can be garish, amateurish and at worse, distracting to your main communication. If you are just starting out in design, we suggest you stick to one or two colors for your document.

Without going into all the complexities of color theory, in this section we will show you how to define and apply one color. We will start with a few basics about color printing.

➡ **NOTE:** *If you never use or intend to use color in any of your documents, feel free to skip ahead to the pictures section.*

In traditional printing, there are two ways to print color: Process color and spot color. Let's look at both in turn.

In process color printing you run a page through the press four times. One time for each primary color (cyan, magenta, and yellow) and another time for black. By mixing these four colors in different combinations, you get a limitless palette of

colors. You would use process color printing to print color photographs or illustrations with a range of colors. If you have the budget for photography and/or color illustrations, you can define over 125 million colors in Ventura and print directly to a color printer, such as the QMS ColorScript.

On the other hand, if you don't have the luxury of a color printer, you can still use Ventura to define one or two colors. When your document uses only a few colors, you do not use process printing. Instead, you use what is known as "spot color." Spot color runs a page through the press for each color (plus black) that you define on the page.

Before you give a document to a printer for spot color printing, you must create a set of color separations, that is, a separate page for each color you define. For instance, let's say you wanted to use two colors, black and red. First, you would define the colors. In our example, you would apply red to the desired text, ruling lines, or graphic shapes and backgrounds in the document. (You can apply the color in any dialog box that includes color selections.) Second, you would instruct Ventura to *print out a page for every page element that is black and a separate page for every element that is red*. The end result is a set of color overlays that you can send to an offset printer for printing.

➡ **NOTE:** *With Ventura's color capabilities, you eliminate the extra expense of paying an offset printer to make the color separations for you.*

So let's get started. In this section you will define and apply a color to one page element. Later in the Chapter section, you will print out your color overlays. For this example, we will assume that you are printing to a black and white printer, not a color printer.

Disable colors

First you will disable the colors that you will not use — in this case, everything except red, black, and white.

- Enable Paragraph mode.
- Select Define Colors from the Paragraph menu.

- Click once on the right arrow next to the Color Number line to move to color 3. Then choose Color Setting: Disabled.

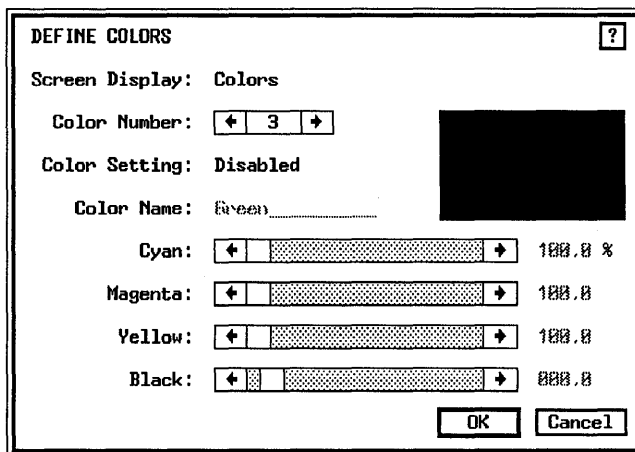

- Repeat the step above to disable color numbers 4 through 7. Then click OK to close the dialog box.

➔ **NOTE:** If you do not disable unused colors, Ventura will print out a separate page for each one.

Assign a color to selected page elements

Next you will tell Ventura which page elements will be red.

- Make sure you are on page four.
- Select the Note in the first column (Figure 9–28).
- Select Ruling Box Around from the Paragraph menu.
- Choose Color: Red and click OK.

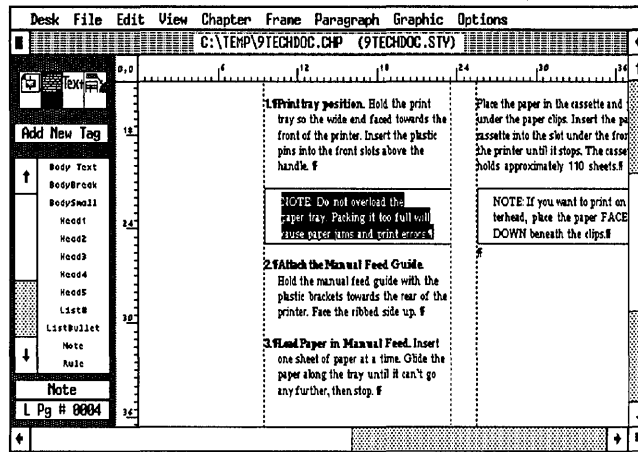
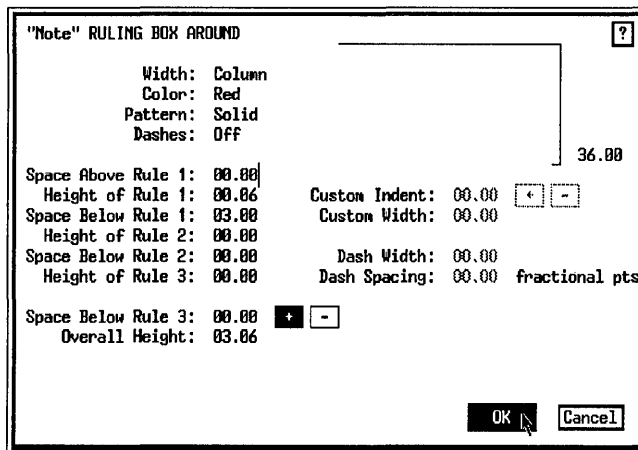

Figure 9-28.



You just changed the color of the ruling box around the note. Now you will change the color of the Head4 tag to red.

- Select the paragraph "Paper Trays, Paper Cassettes" at the top of the page.
- Select Font from the Paragraph menu. Choose Color: Red and click OK.

Notice that the only colors in the dialog box are white, black and red, the ones you defined and enabled in the Define Colors dialog box. Because of time and space limitations, you will only add color to one page.

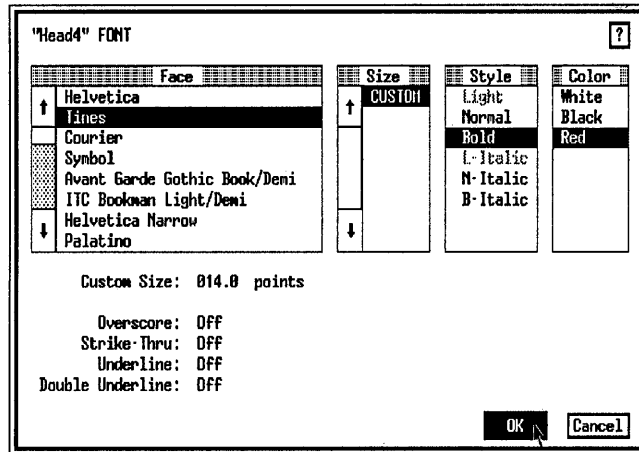

Pictures

Before you print out the color overlays, you will place pictures into frames. In this section, you will incorporate illustrations by adding new frames and importing AutoCAD pictures. You will also learn to anchor frames to text. As with the rest of this chapter, you will be learning advanced techniques that may take extra time and effort to master completely.

Add three frames

Before you place the pictures, you must add the frames to contain them.

- Check that you are on page four.
- Reset the zero point to its original position at the upper left corner of the Page by clicking on the 0,0 square in the upper left corner of the page. Check to make sure that Line snap and Column Snap are on.
- Enable Frame mode. Select Add New Frame from the Side-Bar.
- Add a frame in the first column, starting from position 13 picas on the vertical ruler. Stretch it 14,00 picas wide and 11,00 picas high (Figure 9–29).

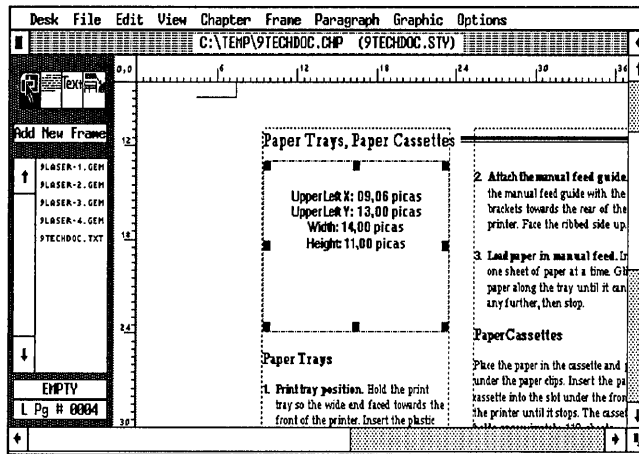

Figure 9-29.

➔ **NOTE:** You can check the frame's width and height with the *Sizing & Scaling* dialog box.

To visually separate the frame from the Page, you will add a ruling box around.

- Ruling Box Width: Frame
- Around Height of Rule 1: 00.05 fractional pts

Now you will copy the frame and paste it twice.

- With the frame still selected, press Shift-Del.
- Press the Ins key to paste a copy on top of the original.
- Press Ins again to insert another copy of the frame.
- Move the two copies into position. Make sure the top and bottom edges of the new frames line up with the top and bottom edge of the original frame (Figure 9-30).

Place pictures inside the frames

- Select the left frame and place the file 9LASER-1.GEM inside.
- Select the middle frame and place the file 9LASER-2.GEM inside.
- Select the right frame and place the file 9LASER-3.GEM inside (Figure 9-31).

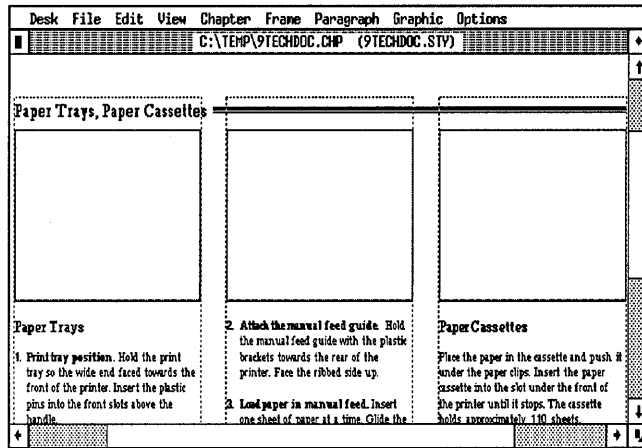

Figure 9-30.

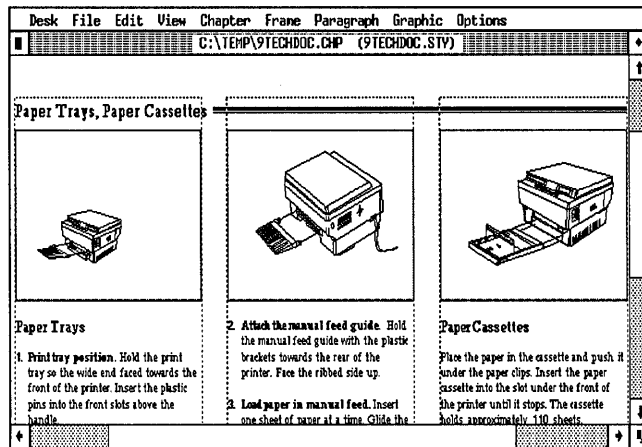

Figure 9-31.

➔ **NOTE:** If you do not have these three pictures from the Power Disk, substitute others of your own choosing.

Size and scale the pictures

You will use Picture Scaling: By Scale Factors (Sizing & Scaling dialog box) to scale the pictures in the frames. Select the left-most frame.

| | |
|--------------------|--|
| ■ Sizing & Scaling | Picture Scaling: By Scale Factors Aspect Ratio: Maintained X Offset: + 03,00 picas & points Y Offset: + 12,00 picas & points Scale Width: 29,00 picas & points |
|--------------------|--|

Use Figure 9–32 to gauge the scale and aspect ratio for the rest of the three frames.

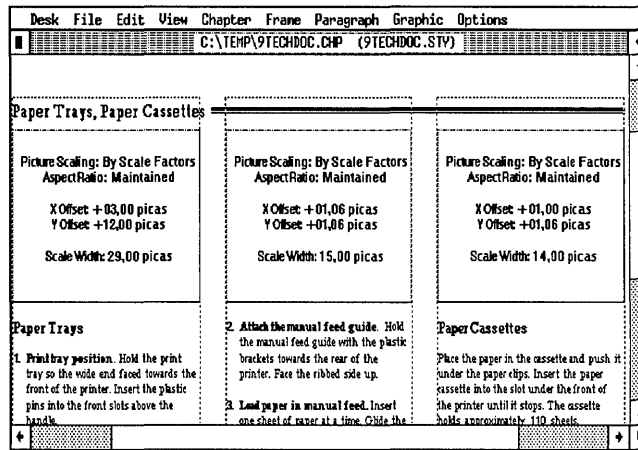

Figure 9–32.

Add a Spacer paragraph

When you placed the frames, the text automatically re-flowed on the page. Now you will finish the formatting with one adjustment — you will add a spacer tag to an empty paragraph in the second column to keep the spacing of the numbered items even.

- Enable Text mode.
- Place the text cursor after the last period in the first Note paragraph in column 1 (Figure 9–33). Press Enter. Then press F10 to tag the empty paragraph as Body Text.
- Enable Paragraph mode.
- Select the empty paragraph you just created (which was tagged as Body Text).
- Add New Tag Tag Name to Add: Spacer

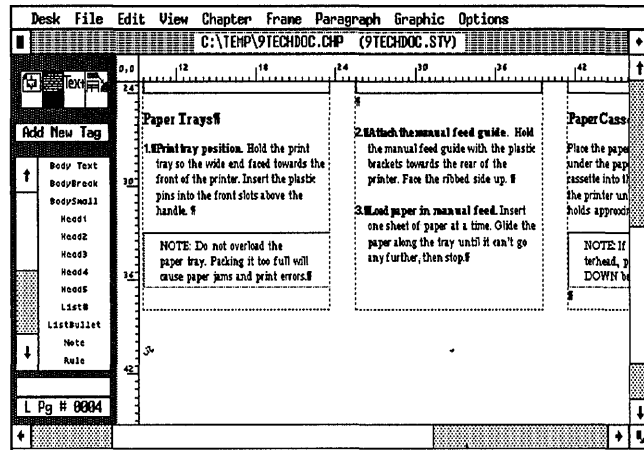

Figure 9-33.

Spacing Add in Above: Always

Unlike Body Text, you want the Spacer tag to keep 12.00 fractional pts of extra white space at the top of the column. The extra space above in the Spacer tag makes the top of all three columns line up with each other (Figure 9-34).

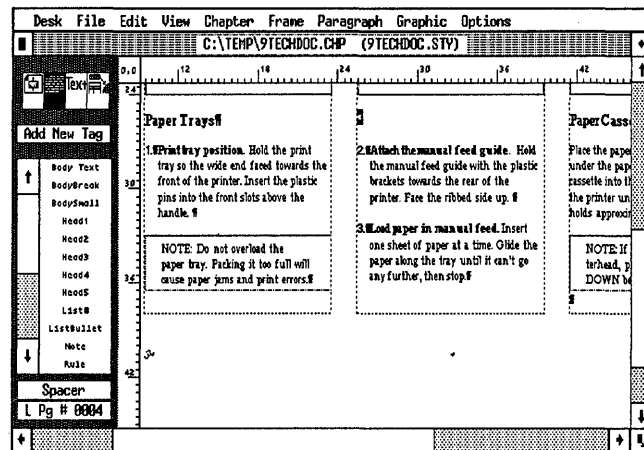

Figure 9-34.

➔ **NOTE:** You also did not use Body Text as the spacer because Body Text would cause the Auto-Numbering to reset to one.

Add the final illustration

Now you will go to page five and add the frame for the final illustration.

- Go to page five.
- Enable Frame mode.
- Select Add New Frame. Start the frame at the upper left corner of the second column and stretch it 30,00 picas wide and 24,00 picas high. You may want to change to reduced view to place the frame (Figure 9–35).

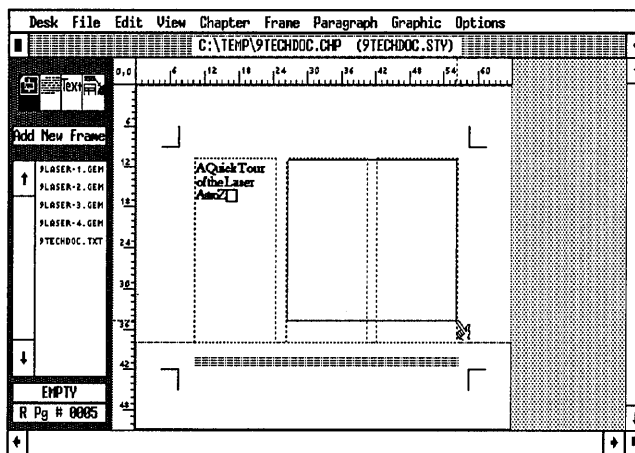

Figure 9–35.

- With the frame still selected, choose the file 9LASER-4.GEM from the Assignment List.
- Sizing & Scaling

| | |
|------------------|-----------------------|
| Picture Scaling: | By Scale Factors |
| Aspect Ratio: | Maintained |
| X Crop Offset: | +08,00 picas & points |
| Y Crop Offset: | +20,00 picas & points |
| Scale Width: | 63,00 picas & points |

Add a caption label

You are almost finished with the manual. Let's make a few more enhancements to the page by including automatic figure numbering.

- With the frame still selected, choose Anchors & Captions from the Frame menu.
- Choose Caption: Below. Move to the Label line and type: **Figure** followed by a space.
- Choose Inserts: Chapter #, type a hyphen and choose Inserts: Figure # and type a period. The code will read **[C#] - [F#]** . Click OK.

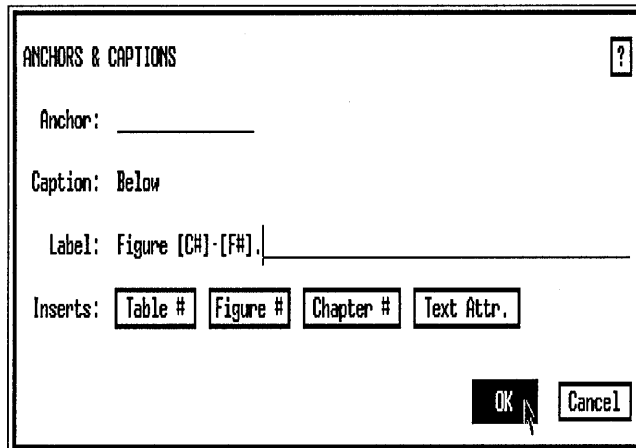

Add caption text

- Enable Text mode.
- Place the text cursor in front of the end of file mark inside the caption and type:

The front view of the Laser AstroZ, showing the display panel, the toner cartridge door, the release lever, the paper cassette, and the print tray.

Add a frame anchor

We promised to show you some advanced picture techniques, and frame anchoring is one of the most useful. Frame anchoring keeps frames on the same page as the text they refer to. Once a frame has been anchored, you can make large additions and deletions to a text file without worry that the frame will be displaced from its text reference. It is a two-step process: (1) insert an anchor reference into the text file and (2)

attach an identical reference to the frame. Once a frame has been anchored, you can make large additions or deletions to the text without the fear that you will move the frames. The Re-Anchor Frames function searches the text file for anchor references and then moves frames to the correct pages again.

As is so often the case, the best way to understand this advanced function is to try it out. Start by placing an anchor reference into the text on page five.

- Place the text cursor after the “Z” in the phrase “A Quick Tour of the LaserAstroZ” on page five.
- Select **Ins Special Item** (or press Ctrl-C) from the Edit menu (Figure 9–36).

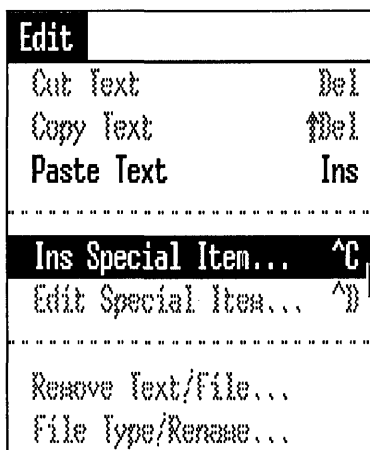
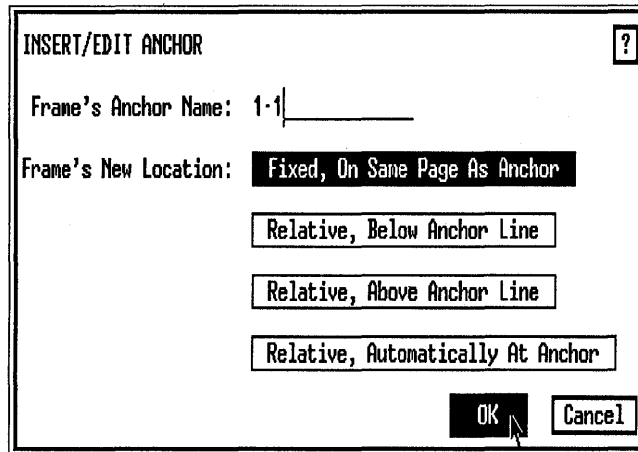

Figure 9-36.

- Choose **Frame Anchor** (or press the F5 key).
 - Move the text cursor to the Frame’s Anchor Name line and type: 1-1
 - Choose **Frame’s New Location: Fixed, On Same Page As Anchor** and click OK.
- ➔ **NOTE:** When Ventura tells you it cannot find the Anchor Frame 1–1, and asks what you want to do about it, choose *Ignore*. You have not yet added the anchor.



If Show Tabs & Returns is selected, you will see a degree symbol (°) in the text to indicate the anchor reference.

➔ *TIP: Like footnotes and index entries, anchor references can be typed directly into text files using a bracket code. See the tips at the end of Chapter Eight for details.*

After placing the anchor reference in the text, you will attach an identical anchor name to the frame with Anchors & Captions.

- Enable Frame mode. Select the frame.
- Select Anchors & Captions from the Frame menu.
- Move the text cursor to the Anchor line and type: 1-1 (Figure 9-37).

WARNING: Type the anchor reference exactly the same in both dialog boxes. Otherwise, Ventura cannot match the two references.

Re-anchoring frames

There is no need to use anchoring until a frame is separated from the text reference. Just to see the feature in operation, try deleting the frame you just anchored. Move to any other page of the document and paste the frame there.

Now you will try re-anchoring.

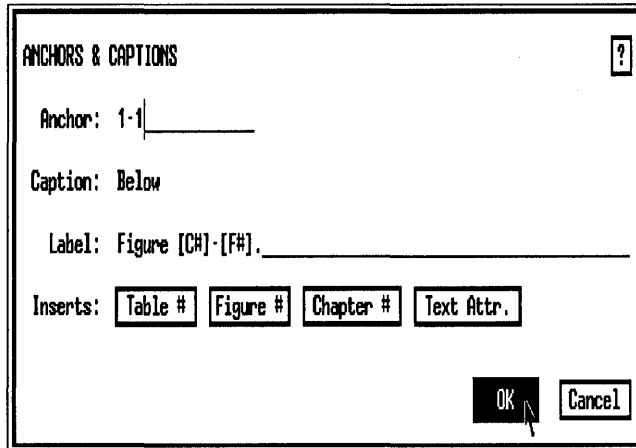

Figure 9-37.

- Select Re-Anchor Frames from the Chapter menu (or press Ctrl-B) and choose All Pages. If you press the keyboard shortcut, Ctrl-B, you will automatically Re-Anchor Frames for all pages.

The frame returns to the page containing the anchor reference in the text. You may need to re-position it slightly.

Adding callouts

Ventura's graphics tools are perfect for adding callouts to pictures. Using Box Text and lines, you can create annotations and arrows. Since graphic shapes stay tied to the parent frame, when you move the frame, the callouts move with it.

Draw Box Text

To create callouts, you will start by creating the Box Text. Then you will type in the actual words, and draw arrows pointing to specific features in the picture. First you will set the horizontal and vertical grid settings.

- Enable Graphic mode. Choose the picture frame to make it the parent to the shapes you will draw.
- Grid Settings
 - Grid Snap: On
 - Horizontal Spacing: 00,06 picas & points
 - Vertical Spacing: 00,06 picas & points

- Select the Box Text tool. Draw a Box Text shape 06,00 picas wide and 03,00 picas high. Position it close to where we show in Figure 9–38.

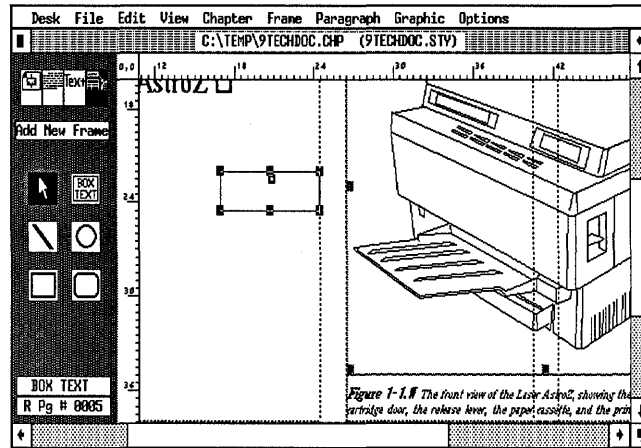

Figure 9–38.

- Line Attributes Thickness: None
Defaults: Save To
- Fill Attributes Color: White
Pattern: Hollow
Results: Transparent
Defaults: Save To

Now add the text part of the callout.

- Enable Text mode.
- Place the cursor inside the Box Text and type: **Display Panel**

Now you will draw an arrow.

- Enable Graphic mode and make sure the picture frame is selected as the parent. Then select the line tool. Starting from the end of the word “Panel,” draw a line from the text to the picture as shown in Figure 9–38.

➡ **NOTE:** Although you could have drawn the arrow before typing the words, you would have been forced to guess at the precise location. Placing the arrow after typing the callout makes placement easier.

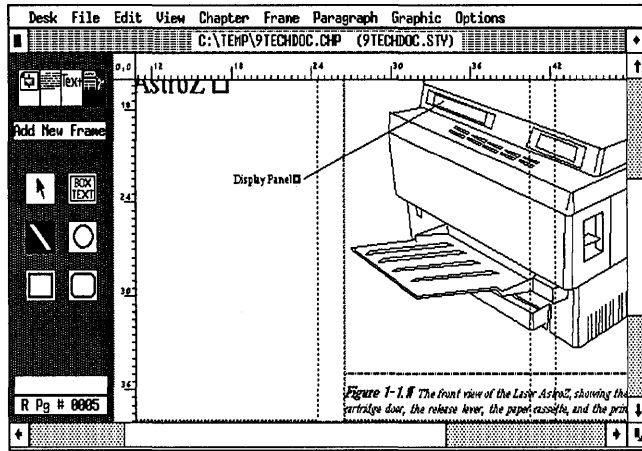

Figure 9-39.

- Line Attributes Thickness: Thin
- End Styles: (Beginning) Arrow
- Defaults: Save To

Repeat the steps above to add two more callouts as shown in Figure 9-40.

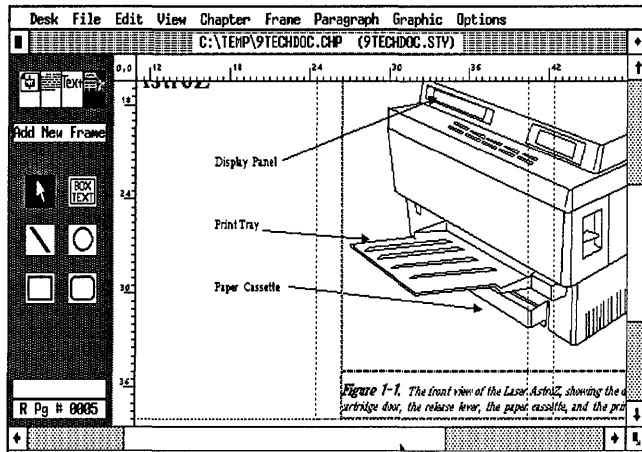

Figure 9-40.

When you are finished, save the chapter and move on to the Chapter section.

Chapter

Now you are ready to print out the chapter and create a set of color overlays. You will get two sheets of paper for the color overlays on page four.

- Go to page 4.
- Choose To Print from the Chapter menu.
- Choose Which Pages: All and Spot Color Overlays: On. Then click OK.
- When Ventura asks if you want to print 2 spot overlays per page of the chapter, choose Overlays (Figure 9-41).

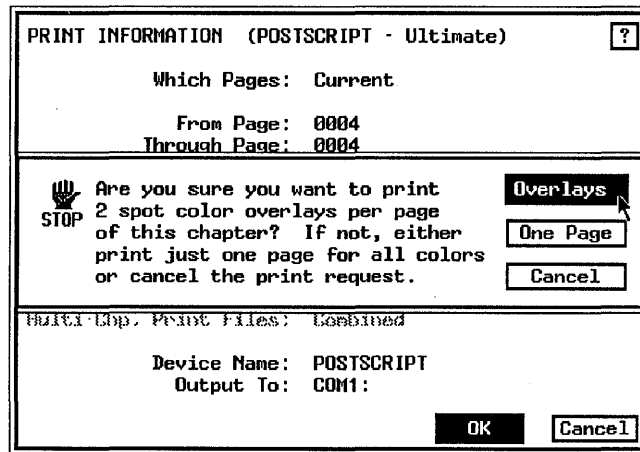

Figure 9-41.

Ventura prints out the manual. When it gets to page four, it prints out one sheet for black and one sheet for red.

➡ **NOTE:** *If you place the two overlays pages on top of each other, you can see the resulting effect.*

Now give yourself a *big pat* on the back. You made it through all nine chapters of Ventura expert training. You should be proud of yourself. Now you are ready to show off your talents to the world. Get started on those high-powered, award-winning designs.

For all of you who have the ambition and the determination to go beyond your own limits, don't stop here. You are just one

chapter away from becoming a true Ventura master. In Chapter Ten, we tackle the advanced features of the Professional Extension. If you have the Professional Extension and are ready for the challenge, go to the next chapter.



Tips and techniques

Text tips

- You can create a special page break (BodyBreak) tag that includes a Page Break: After. To force a page break within the text file, tag an empty paragraph with the page break tag. All the text following the tag will be forced to the next page.
- Auto-Numbering includes two basic steps: first you choose which tags to number and what style of numbering to use. Second, you format the numbers that Ventura generates.
- Initially the generated section number tags have the same attributes as body text. You can format them like any paragraph.
- You can create a traditional outline format (uppercase Roman numerals, uppercase letters, lower case Roman, and so forth) with the Auto-Numbering dialog box. Insert the Suppress Previous Level symbol ([-]) as the first item on the Level line. This selection instructs Ventura to suppress printing of the higher level numbers.
- Whenever Ventura encounters a Level 1 tag, it resets the numbering for all the lower levels.
- Using Body Text to reset numbering will not work properly if you want to intersperse Body Text between consecutive numbers in the same list. In these cases, you can create a special Reset tag. Here's how you do it: First, go to the Auto-Numbering dialog box and place the tag name Reset on the Level 1 line. Now select an empty paragraph and add a tag called Reset. Align the new tag flush right. Set the line spacing to a very small amount. Use the Breaks dialog to set the Line Breaks to No. In essence, you will create an invisible tag that resides on the same line with other para-

graphs. Its only function is to signal Ventura when to start renumbering from one.

- When a tag with a ruling box around crosses a page or column boundary, the paragraph text continues but the ruling line does not. To avoid this problem, try creating the same effect with Box Textor text inside a frame.

Picture tips

- Frame anchoring allows you to tie frames to the text reference they refer to. Once a frame has been anchored you can make large additions and deletions to a text file without worry that the frame will be displaced from its text reference.
- Like text references and footnotes, frame anchors can be typed directly into the text file in advance using a bracket code. The anchor codes are as follows (where anchor name is the frame reference name specified in Anchors & Captions):
 - Picture frame on same page: <\$&anchor name>
 - Picture frame below: <\$&anchor name[v]>
 - Picture frame above: <\$&anchor name[^]>
 - Picture frame floats with text <\$&anchor name [-]>
- Make sure you type the anchor name exactly the same in the Insert/Edit Anchor dialog box and the Anchors & Caption dialog box. Otherwise Ventura cannot match the two references.

Miscellaneous tips

- You can create a special spacer to insert extra spaces between paragraphs. Simply tag an empty paragraph with the above, below, or inter-line spacing desired.
- It is easier to draw crop marks manually if you temporarily reset the page margins to equal the trim size of the paper. Then you can use the column guides to help you position the marks.

Chapter Ten Skills Checklist

Theory

- Using cross references to link text with frames
- Ventura's Table mode
- The parts of a table
- Editing tables
- Understanding vertical justification

Text

- Inserting cross references
- Table text
- Editing table text

Style

- Building a table
- Adding tint screens to tables
- Applying vertical justification
- Vertical justifications in paragraphs

Chapter

- Printing a publication to a single disk file

Chapter Ten

The Professional Extension

By completing the first nine chapters of *Publishing Power* you have gained a solid, working knowledge of Ventura. Now you are ready to advance beyond the basics to reach a higher level of expertise. In Chapter Ten, you will broaden your inventory of Ventura skills and techniques as you learn the specialized features of Ventura's Professional Extension. The checklist on the left gives a preview of the skills you will learn in this chapter.

Theory

In the first half of the theory section, we will show you how to operate Ventura's Cross Reference feature. In the second half, we will cover the principles behind vertical justification and Ventura's automatic table generator, two features that bolster Ventura's professional publishing capabilities.

➤ *NOTE: Because of time and space limitations, we did not include complex equation editing in this chapter. We did, however, include a simple example of equation editing in the "Insert Fractions" section in Chapter Eight.*

Cross references

As you begin to work on long documents of your own, you will find that keeping track of all the figures, tables, captions, and pictures is crucial to the success of the project. With the Professional Extension, Ventura provides a high-powered device for creating and updating all the page, chapter, figure, table, caption, or section number references in a document.

Among other things, the Cross Referencing feature lets you keep track of pictures and text as you change a document.

To help you understand cross referencing, let's apply its basic principles to the following hypothetical situation:

Imagine that you have created a technical manual with fifty illustrations. You numbered each frame (with automatic figure numbers) and gave it a Frame Anchor name. Figure 10-1 shows how the Anchors & Caption dialog box would appear for a typical frame in our sample document.

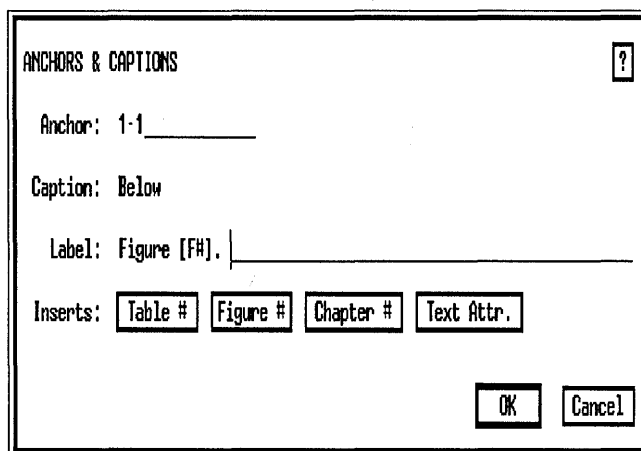

Figure 10-1.

In the text, you have also inserted a reference to each illustration that reads “See Figure 1,” “See Figure 2,” and so forth (Figure 10-2).

Now it's time to update the manual. You insert a new illustration on the first page of the document. With Ventura's automatic figure numbering, when you add a frame, you “bump up” all the subsequent figure numbers in the document. But the “See Figure...” references in the text keep their old numbers — which are now inaccurate. Normally you would have to renumber each one individually in Text mode. But if you use the Cross Reference feature to link each text reference with its corresponding frame, Ventura can update the numbers automatically. The following steps show how you can make a cross reference and link the text reference with a frame. We are assuming that you have already inserted frames and given them anchor names, as explained in Chapter Nine.

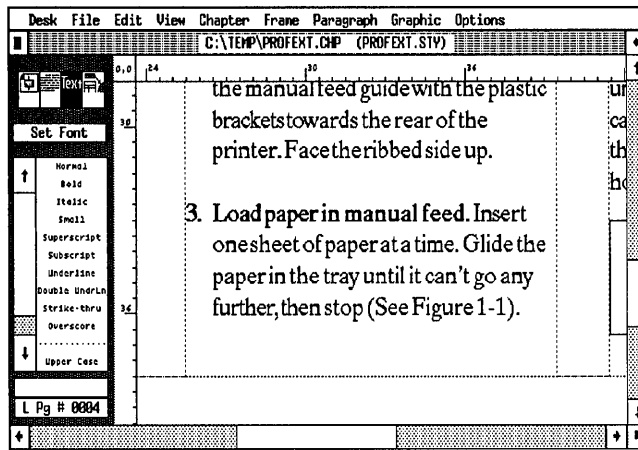

Figure 10-2.

➔ **NOTE:** The steps below illustrate the theory of cross-referencing. Later in the chapter you will have a chance to try some hands-on practice.

- Enable Text mode.
- Place the text cursor where you want the figure number to appear. Typically, you would place the number after the word "Figure" as in Figure 10-3.

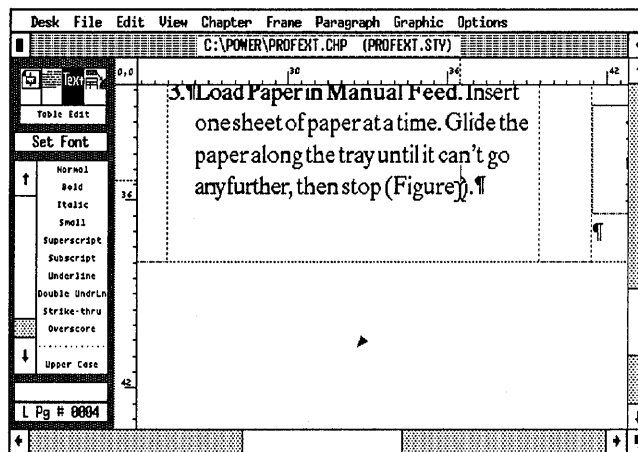

Figure 10-3.

To insert a cross reference you would:

- Select Ins Special Item from the Edit menu and choose Cross Reference (Figure 10-4).

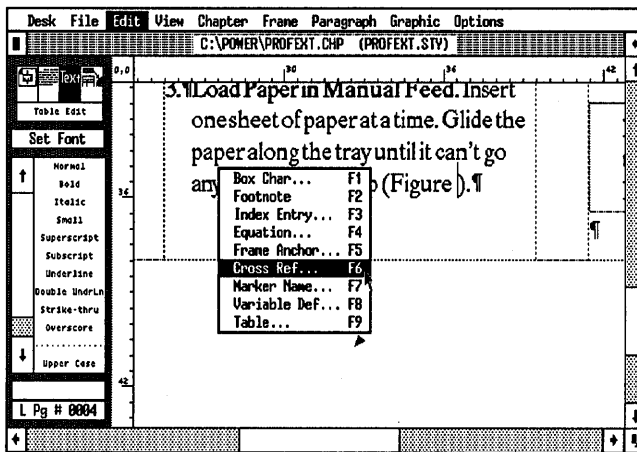

Figure 10-4.

- Move to the At The Name line and type in the name of the frame you want to reference.

➔ **NOTE:** Make sure you enter the same name as you entered for the Anchor Name line (Anchors & Captions dialog box). Otherwise, Ventura won't link up the frame with the cross reference.

- Move to the Refer To line and enter the type of reference you want to create (Figure 10-5). For our example above, you would choose F# to references the figure numbers. Click OK to close the dialog box.

No new numbers appear yet. First you must generate a cross reference for the chapter. To do so, you save the chapter(s) as a publication. Then you select Renumber from the Multi-Chapter dialog box. When Ventura rennumbers the publication, you will see the correct figure numbers inserted into the text (Figure 10-6).

If cross referencing seems difficult, don't be concerned.

Remember you are learning an advanced application that goes beyond everyday skills. It will become clear with practice.

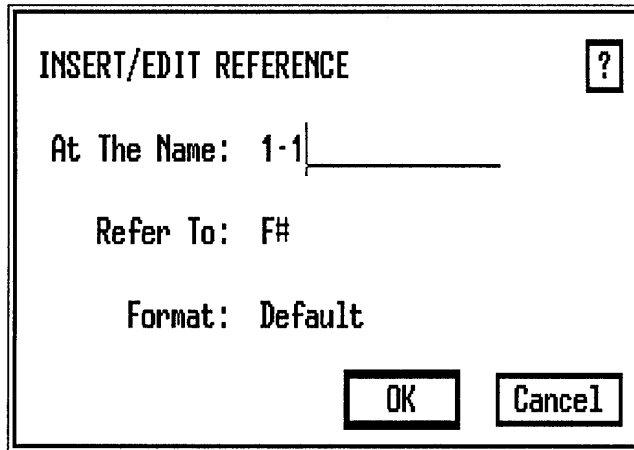

Figure 10-5.

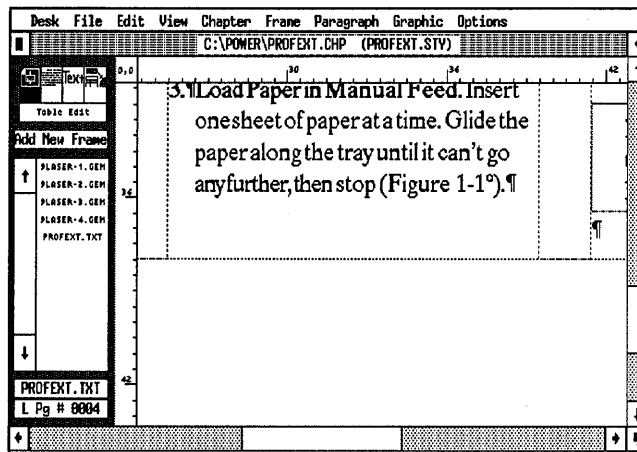

Figure 10-6.

Table mode

In earlier chapters, you learned several methods for creating tables. Chapter Two showed how to format simple, single-line tables using Tab Settings. Chapter Eight explained side-by-side paragraphs for complex tables. In this chapter, you will learn how to use the Professional Extension's table editor, an advanced capability for generating simple or complex tables.

The parts of a table

A table is any text (words or numbers) that is formatted in a grid of rows and columns (up to 9999 rows or columns with the Professional Extension). Each table is a collection of individual grid units called “cells” (Figure 10–7).

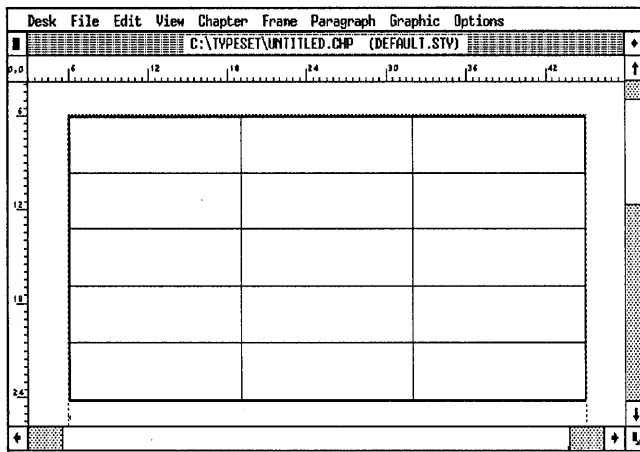

Figure 10–7. In Table mode, tables are constructed of individual cells.

Ventura can place a ruling box around the table and ruling lines between each row and column. Or, at your option, you can hide or change any or all of the lines (Figure 10–8).

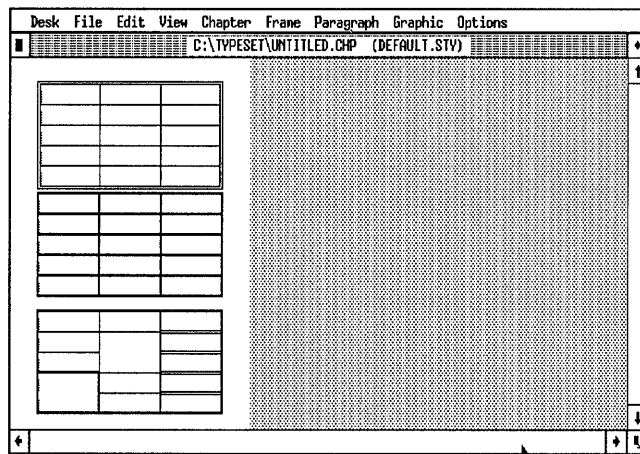

Figure 10–8.

The table editor assigns row and column numbers. This built-in numbering system makes it easy to specify a cell or range of cells. For instance, Figure 10-9 shows the row and column numbers for a three-row by four-column table.

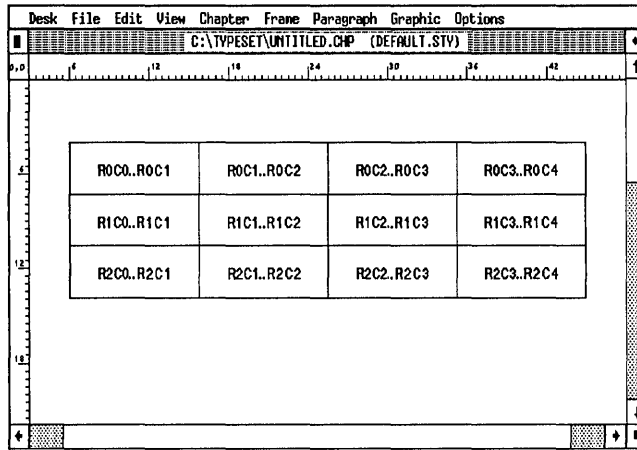

Figure 10-9.

In Figure 10-9, the grid cell in the upper left corner is R0C0...R0C1, or row zero, column zero through row zero, column one. To see the position of a cell, point and click on one of its ruling lines. Ventura highlights the selected ruling line in gray and displays the range of rows and columns in the Current Selection Box (Figure 10-10).

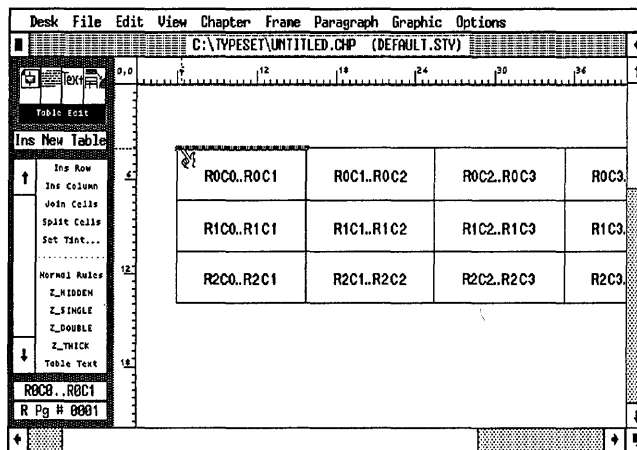

Figure 10-10.

➔ *TIP: Ventura sees each grid cell as a box defined by four borders.*

Each cell can contain one or more lines of text. In fact, you can make every cell a different size. You can also dress up the table by adding a tint screen to an individual or group of cells. A tint screen adds visual contrast and helps separate diverse information.

➔ *NOTE: You may not be able to get all of the effects if you do not have a PostScript printer.*

You can place a table on the Underlying Page or in a separate frame that resides on top of the Page. If your table is excessively long, you can instruct Ventura to continue the table across a column, a page, or a frame (Figure 10-11).

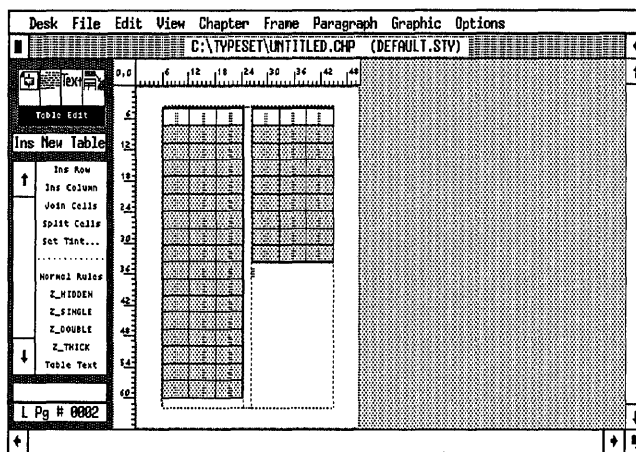

Figure 10-11.

Editing tables

After you generate a table, you can use Ventura's standard editing tools to add or delete rows and columns. You start by highlighting the cell or range of cells you want to cut or copy. Then you select Cut or Copy Row/Column from the Edit menu (or press the Shift-Del or Del keys) to copy or cut cells to the clipboard. To paste a row or column, *select the line between the row or column* where you want to insert the cell(s) and select Paste from the Edit menu (or press the Ins key).

➔ **NOTE:** You can select a ruling line even if it is hidden.

In addition to cut, copy, and paste, Table mode lets you change the table specifications and change column widths.

To change the table settings, click anywhere in the table and select Edit Table Settings from the Edit menu (or press Ctrl-D). The Insert/Edit Table dialog box appears. Now you can change the # of header rows, the ruling line attributes, and the spacing values for the entire table.

Once you create a table, you cannot change the number of rows and columns through the Insert/Edit dialog box. Instead, you must add or subtract rows and columns using Ins Row and Ins Column from the Assignment List. To do this, you place the Table Edit cursor on the ruling line where you want to insert the row(s) or column(s). Then you drag the cursor across the number of cells you want to insert. If you drag the cursor over three rows, you are instructing Ventura to insert three rows. If you drag the cursor across two columns, you are instructing Ventura to add two columns. After selecting the number of rows or columns to add, select Ins Row or Ins Column from the Assignment List.

To change the width of a column, click on the column you wish to change then select Set Column Widths from the Edit menu. The current column number is displayed on the Column Number line (Figure 10-12).

TABLE COLUMN WIDTHS

Column Number: ◀ 1 ▶

Width Setting: Variable

Fixed Width: 00,00 picas & points

Variable Width: 0001 proportions

OK Cancel

Figure 10-12.

➡ **NOTE:** To change the column number, click on the left or right arrows next to the Column Number.

In the Set Column Width dialog box, you can change the column width by a fixed or variable amount. If you choose Width Settings: Fixed, Ventura applies the width you specify to the selected column. To make the column exactly 06,00 picas & points wide, you would enter 06,00 for the Fixed Width (Figure 10-13).

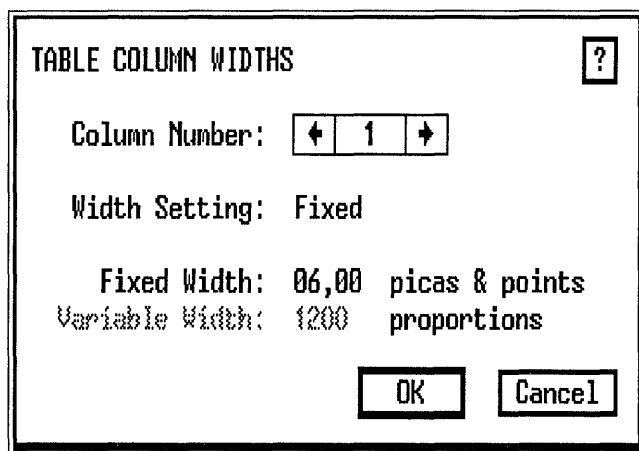

TABLE COLUMN WIDTHS ?

Column Number: ← 1 →

Width Setting: Fixed

Fixed Width: 06,00 picas & points
Variable Width: 1200 proportions

OK Cancel

Figure 10-13.

On the other hand, if you choose Variable Width, Ventura sizes the current column in proportion to all the other columns in the table. For instance, if you entered a variable width of 2, Ventura would give the current column two proportional units of the space left over after creating the fixed columns. Perhaps the easiest way to understand variable widths is to use percentages. Let's say you assign columns 1, 2, and 3 variable widths of 20, 30, and 50. Ventura will give column 1 20 percent of the space, column 2 30 percent, and column 3 50 percent. From there, it should be apparent that you could also enter widths of 2, 3, and 5 to achieve the same effect. To make things easy on yourself, when first learning variable widths, make sure that the numbers you enter always add up to a total of 10 or 100 (Figure 10-14).

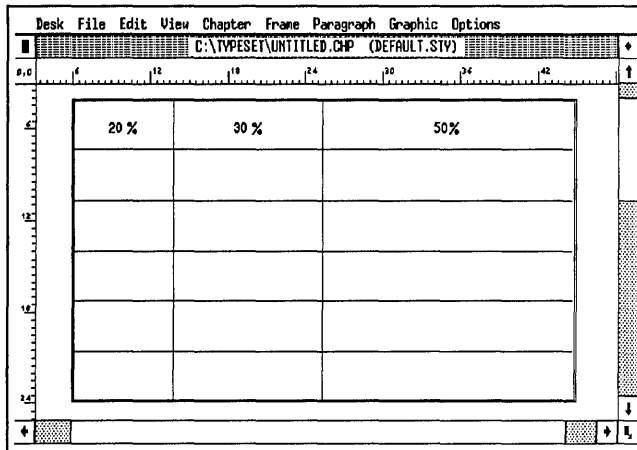

Figure 10-14.

To determine the size of each column, Ventura uses the variable proportion you enter in the Insert/Edit Table dialog box and calculates the relative proportions of the current column width, the fixed column widths, and the overall width of the table.

You can also change column widths interactively. In Table mode, put the cursor anywhere in the column you want to change. Press and hold down the Alt key. A line appears from the top to the bottom of the screen (Figure 10-15). Move the line to change the position of the right-hand column.

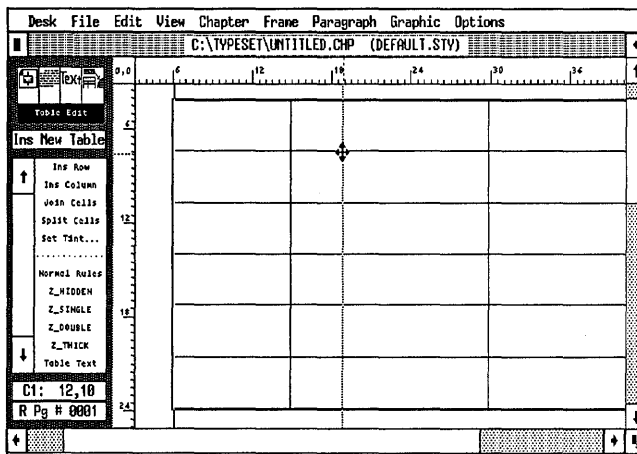

Figure 10-15. Press and hold the alt key while sliding the mouse to interactively change the column width.

Table text

Now that you've learned how to set up the physical dimensions of a table, let's take a look at the "text" part of tables. For every cell in the table Ventura automatically generates a tag named Table Text. You can format it with the attributes from Paragraph menu or rename it as a different tag. In this chapter's table, you will change the text attributes of Table Text and add a new tag for the table title.

Vertical justification

Vertical justification is a sophisticated typographic technique that makes text fill to the bottom of a column, frame, or page. Just as horizontal justification aligns text on both right and left edges of a column or page, vertical justification aligns text with the top and bottom edges of a column or page (Figure 10-16 and Figure 10-17).

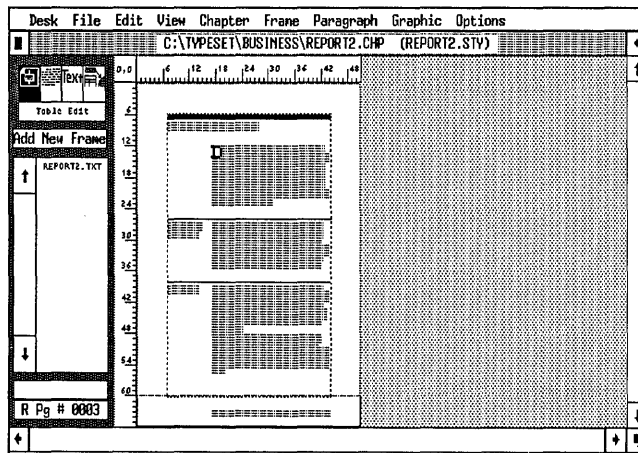

Figure 10-16. Before applying vertical justification.

To understand vertical justification, you must first understand why Ventura cannot always fill text to the bottom of the page. As you know from earlier projects, Ventura flows as much text onto a page or frame as possible, then stops. If the text file you place does not contain enough text to reach the bottom, a large gap is left over. Likewise, gaps are made when you force headings to stay with the following text using Keep With Next (Breaks menu), and when you prevent single lines

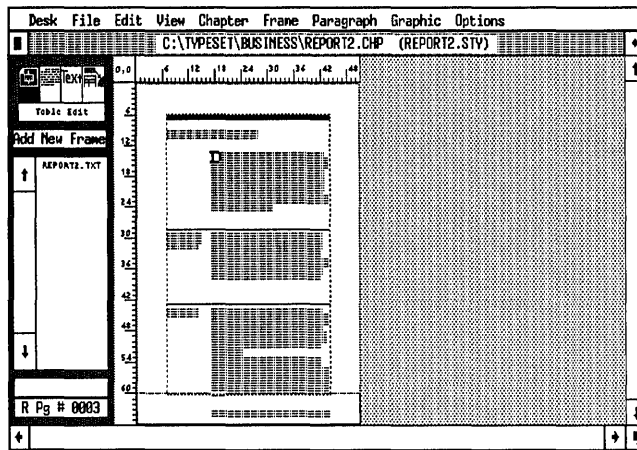

Figure 10-17. After applying vertical justification.

of text at the top or the bottom of the page with the Widows and Orphans control (Chapter Typography menu). Furthermore, you make extra spaces whenever you arbitrarily insert a page or column break (Figure 10-18).

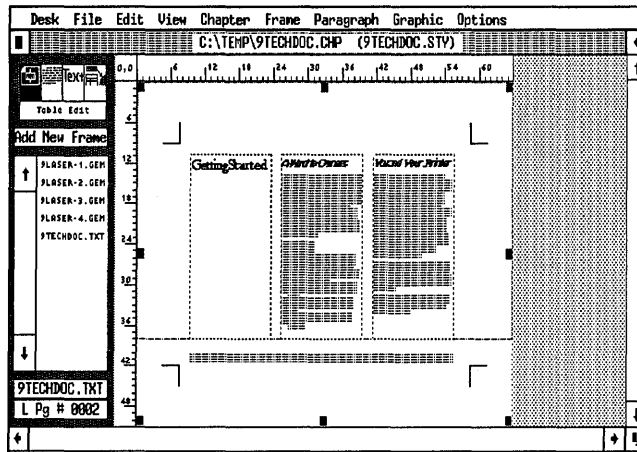

Figure 10-18.

To eliminate unattractive “holes” at the bottom of a page, you can use the vertical justification control in the Professional Extension. Ventura will add space until the text reaches the bottom of the column or page according to the rules you define. You tell Ventura how much space to add between frames, paragraphs, tables, and lines of text. Ventura then adds space, to the maximum you specified, in the following order:

1. Between frames and the surrounding text
2. Between paragraphs or between paragraphs and tables
3. Between individual lines of text

↳ *NOTE: During vertical justification, space is always added, never subtracted. Vertical justification never moves text across the boundary of a page.*

For a preview of each vertical justification control, take a moment to read through Table 9–1. The table shows you where to find each vertical justification control, which settings are available, and what each option does .

Because vertical justification is an advanced typographic effect, you may not understand the effects of every vertical justification control. Don't let that bother you. For now, concentrate on observing how text flows and reflows on the page before and after you turn on vertical justification. Then try changing one or another vertical justification setting to see the results. As you already know, the best way to understand a complex feature is to explore its options on your own. For the project in this chapter, you will have the chance to experiment with vertical justification as you fine-tune the page format in the technical manual.

Now that you've read through the theory section of the chapter, you are prepared for some hands-on practice. In the next few sections, you will have a chance to apply the Professional Extension's powerful tools to a real-life project.

Table 9–1. Vertical Justification Settings

| Menu | Setting | Option | What It Does |
|-------------------------|--------------------------------|-------------|--|
| Chapter Typography | Vert. Just. Within Frame | Carding | Space added in multiples of Body Text inter-line spacing only |
| | | Feathering | Space added in exact amount of space needed for text to reach the bottom of the page or column |
| | Vert. Just. Around Frame | Moveable | Frame can be moved down and space added below |
| | | Fixed | Frame cannot be moved from its original position. Space can be added below frame only |
| | Vert. Just. Allowed | 100.0% | Increase or decrease amount of vertical justification allowed on each page |
| | At Top of Frame | Enter value | Set equal to Body Text inter-line spacing |
| | At Bottom of Frame | Enter value | Set equal to Body Text inter-line spacing |
| Frame Typography | Same as Chapter Typography | same | Can override global settings from Chapter Typography menu for an individual frame or inserted page |
| Paragraph Typography | Vert. Just. At Top of Para | Enter value | Set equal to Body Text Above Spacing |
| | Vert. Just. At Bottom of Para. | Enter value | Set equal to Body Text Below Spacing |
| | Between Lines of Para | Enter value | Set to zero |
| Insert/Edit Tables | Same as Paragraph Typography | same | Tables are treated like paragraphs for vertical justification |

Ventura prep

For this project you will work with the technical manual you created in Chapter Nine of *Publishing Power*. If you have already completed the project in Chapter Nine, follow the instructions outlined in the section, “If you completed chapter nine.” If you did NOT complete Chapter Nine, you can use the preformatted chapter supplied on the Power Disk, following the instructions in the section “If you have the Power disk.” If you do not own the Power disk and you did not complete Chapter Nine, follow the instructions in the section “If you do not have the Power disk.”

➔ *NOTE: We recommend that you finish Chapter Nine before you venture any further with the Professional Extension. Otherwise, you may find it difficult to follow along. Many skills presented in this chapter build on techniques in Chapter Nine.*



If you have the Power disk

- Open the chapter C:\POWER\PROFEXT.CHP.
- Use Save As New Style to save the style sheet as C:\TEMP\PROFEXT.STY.
- Use File Type/Rename to rename the text file as C:\TEMP\PROFEXT.TXT.
- Save the chapter as C:\TEMP\PROFEXT.CHP.



If you do not have the Power disk

- Use your word processor to type in the text file for Chapter Ten from Appendix A. Load it in Ventura and save it as C:\TEMP\PROFEXT.TXT.
- Load the original style sheet &TBL2-L1.STY from the C:\TYPESET subdirectory. Use the tag table for Chapter Ten from Appendix A to change the columns and margins and the tag definitions you will need for the project. Then save the revised style sheet as C:\TEMP\PROFEXT.STY.

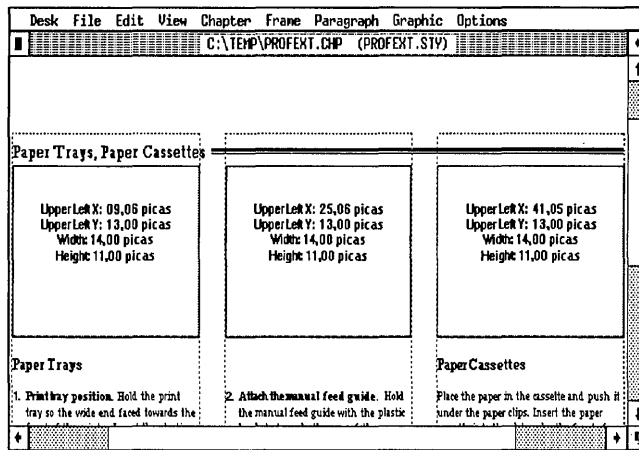

Figure 10-19. Those WITHOUT the Power disk must insert the above frames into the document.

- Add frames to pages in the document (Figure 10-19).
- Save the chapter as C:\TEMP\PROFEXT.CHP.

If you completed chapter nine

- Open the chapter 9TECHDOC.CHP from the C:\TEMP subdirectory.
- Use Save As New Style to save the style sheet as C:\TEMP\PROFEXT.STY.
- Use File/Type Rename to rename the text file as C:\TEMP\PROFEXT.TXT.
- Save the chapter as C:\TEMP\PROFEXT.CHP.

Text

How many times have you used your word processor's search and replace feature to quickly update information in a text file? More than likely, search and replace has become an indispensable part of your text editing tool kit. In this section, we will show you how to use the Professional Extension's cross referencing feature to replace text *while you are in Ventura*.

Before you can trigger the replace operation, you must define the variable text and the substitute text. Variable text is a

word or phrase that changes in the document. For instance, in the sample technical manual, the *product name*, “Laser AstroZ,” is the variable. (The product name will change when the XYZ corporation manufacturers a new line of printers next month.) The substitute text in our example is the new product name, “TurboSpeed-X.” When you activate the replace function, the new product name will appear throughout the document.

After you define the variable and substitute text, you must insert a cross reference marker in the text wherever you want the substitute text (the product name) to appear. For instance, on page one of the document you would delete the words Laser AstroZ, then insert a cross reference in the space between the words “the” and “printer ” in the first paragraph “Thank you for choosing the _____ printer from XYZ Corporation.”

➡ *TIP: The cross reference you insert is a hidden text attribute, similar to the hidden footnote and index attributes you inserted in Chapter Eight. If you want to see the attribute marker (the degree symbol) displayed on-screen, make sure you select Show Tabs & Returns from the Options menu.*

After all cross reference markers are inserted, you will select Renumber from the Multi-Chapter dialog box to activate the replace operation. From now on, whenever you want to change the product name in the manual, just enter new substitute text and Renumber the chapter.

➡ *NOTE: You can replace different variables within one chapter.*

Now it's time to apply the theory to a practical test. Start by defining the text variable.

- Go to page one (the cover page) of the technical manual.
- Enable Text mode.
- Place the text cursor before the “T” in the word “The” (Figure 10-20).
- Select Ins Special Item from the Edit menu. Choose Variable Def (or press the F8 key).

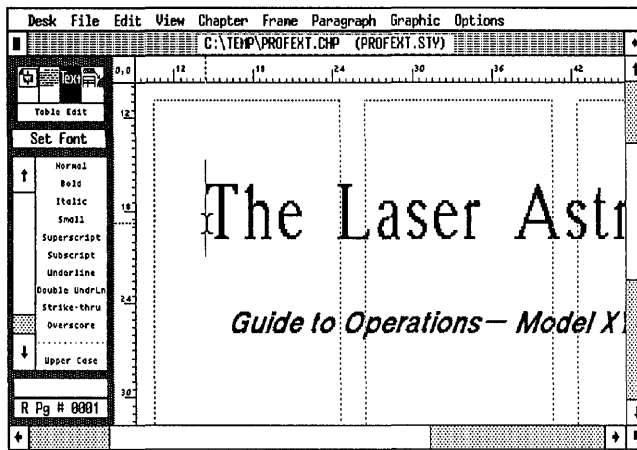
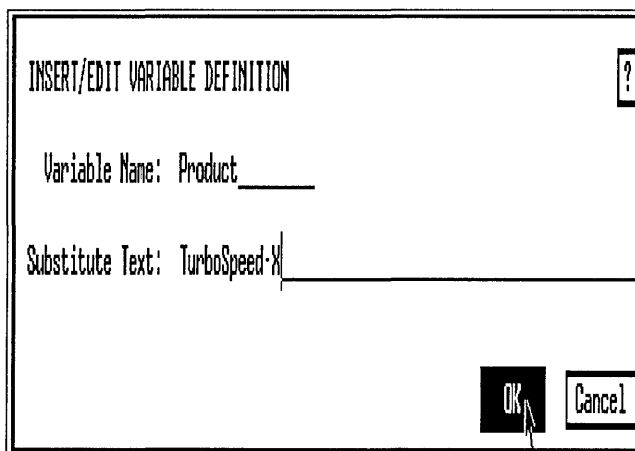

Figure 10-20.

- Move to the Variable Name line and type: **Product**, which is the variable name to which you will refer when you insert the cross reference attributes in the text file.



- ➔ **NOTE:** When you insert a variable text definition in a text file, Ventura generates a hidden attribute and attribute marker (you can see the marker, a degree symbol, when Show Tabs & Returns is on). By inserting the attribute marker at the beginning of the document, you make it easier to locate .

Now move to the Substitute Text line and type:
TurboSpeed-X

The words Variable Def. appear in the Current Selection Box and a degree symbol is displayed on-screen to show the hidden text attribute. Later, when you renumber the publication, Ventura will insert the name “TurboSpeed-X,” at each cross reference location.

Now that you’ve entered the variable and substitute text, you are ready to insert the cross reference markers.

- While you are in Text mode, delete the name “Laser Astro-Z,” on the cover page. (Be careful not to delete the variable definition you just inserted.)

Now you will place a cross reference after the title word “The” on the cover page.

- Without moving the cursor, select Ins Special Item from the Edit menu (Figure 10-21).

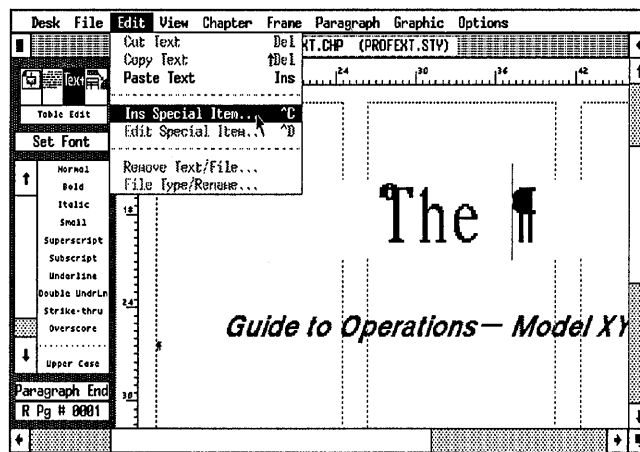

Figure 10-21.

- Choose Cross Reference (or press F6). Move to the At The Name line and type: **Product**
- Choose Refer To: V* and click OK (Figure 10-22).

The word Reference appears in the Current Selection Box and a degree symbol is displayed on-screen to show the hidden text attribute.

You will now continue to insert cross references in the document.

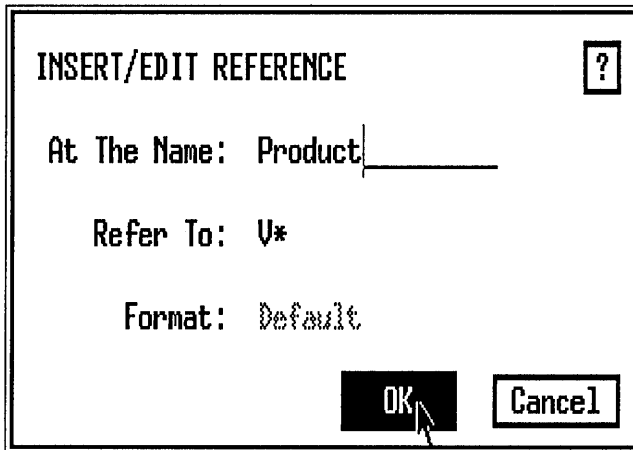

Figure 10-22.

- Press PgDn to go to page 2.
- Delete the first occurrence of the words “Laser AstroZ,” in the first paragraph of the second column. Be careful to retain the space before and after. (Figure 10-23).

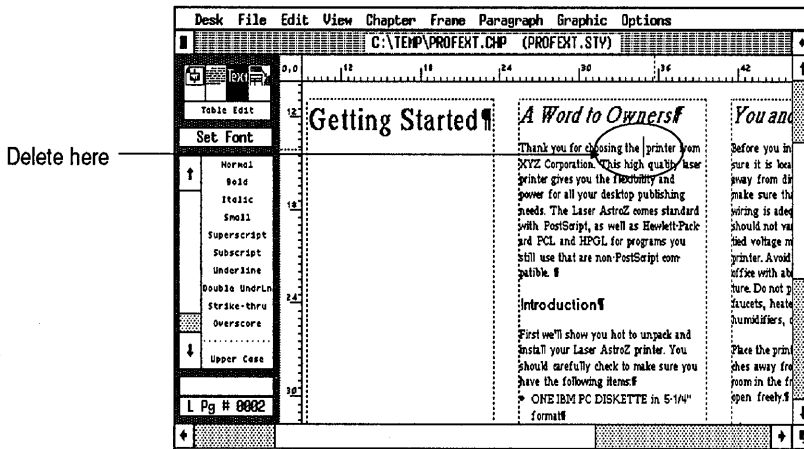

Figure 10-23.

Now you will place another cross reference between the words “the” and “printer” in the first paragraph.

- Without moving the text cursor, select Ins Special Item from the Edit menu (Figure 10-24).

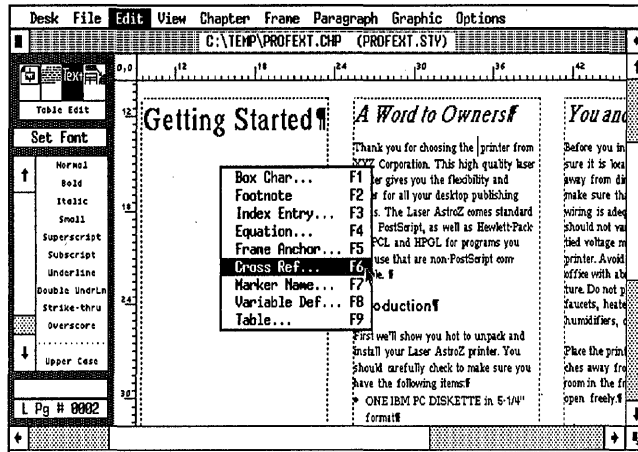

Figure 10-24.

- Choose Cross Reference (or press F6). Move to the At The Name line and type: **Product**
- Choose Refer To: V* and click OK to close the dialog box..

Repeat the steps above to insert five more cross references in place of the name Laser AstroZ everywhere in the document (pages 2, 3, and 5).

Now that you've inserted all the cross references, you are ready to Renumber the chapter.

- Save the chapter by pressing Ctrl-S.
- Select Multi-Chapter from the Options menu. The chapter C:\PROFEXT.CHP appears at the top of the list.

➤ *NOTE: If the PROFEXT.CHP chapter is not listed, select New to start a new publication. Then choose Add Chapter. Move to the C:\TEMP subdirectory and select the chapter PROF-TEXT.CHP. Ventura will return you to the Multi-Chapter dialog box and place the PROFEXT.CHP at the top of the list.*

- Select Save As to save the publication as C:\TEMP\PROFEXT.PUB.

Once you've made the publication, you can renumber it.

➤ *NOTE: Be sure the chapter is not highlighted. Otherwise, the Renumber operation will not be available for selection.*

@BODYFIRST = Acme Company<D> has announced a new large-screen display compatible with Xerox Ventura Publisher. The new B-X-100 is the first display to incorporate four graphics co-processors. A co-processor is a specialized microchip that speeds display speed. The 19-inch monitor and add-in graphics adapter will ship in the last quarter of this year.¶

¶

@BODYFIRST = The Ventura Classroom<D> is now open from 5:00 to 7:00 p.m Tuesday and Thursday of every week. A member of the Marketing Communications Department will be on hand during those hours to answer questions and help with problems.¶

¶

@BODYFIRST = An employee discount<D> was announced for the purchase of small computers. XYZ, which receives a volume discount on its computer purchases, has made arrangements

to pass this discount on to employees who wish to buy computers or related equipment for home use.

@BODYFIRST = A new desktop publishing-related job position<D> has been created in the Engineering Department, which recently announced its intention to convert its entire library of technical documentation to electronic form. Now the production of technical manuals and other technical documentation will be automated as well. In accordance with company policy, the new position will be filled from within XYZ if possible. If no suitable internal candidates present themselves within two weeks, the job will be advertised in local papers.¶

¶

@BODYFIRST = ABC Company<D> has released a low-cost document scanner capable of sensing and transmitting 16 levels of gray. Priced under \$3,000, the scanner permits desktop publishers to convert halftones to electronic form.

ASCII file to create: C:\TEMP\6NEWS-4.TXT

@STAFFBOX = Paginations is published quarterly for the employees of XYZ Corporation, Los Angeles, CA. Copyright 1989 by XYZ Corporation, all rights reserved. Reproduction in whole or in part

without written permission is strictly forbidden. The editors welcome submissions, but cannot be responsible for manuscripts or their return.

ASCII file to create: C:\TEMP\6NEWS-5.TXT

@KICKER = Tip of the month¶

¶

@HEAD3 = Preformatting Ventura documents¶

¶

@BODYFIRST = Ventura Publisher allows you to preformat text files by inserting tags names into the original word processing file. By inserting these tags in advance, you save the time of paging through the document and tagging each text paragraph in Ventura. This is also a handy way to divide responsibilities, so writers can tag documents without worrying what the format will look like.¶

¶

Preformatting is the ultimate time-saver and it's not difficult. One simple trick is to program the tag names into a keyboard macro processor to save typing time. The proper format uses the at sign (@) at the left margin followed by the name of the tag, an equals sign (=) and the text. Thus, if we were using a word processor to preformat this article, the title might look like this in the file:¶

¶

@HEADLINE = Preformatting Ventura documents¶

¶

Don't forget the space at both sides of the equals sign and don't forget to spell the tag name exactly as it appears in the style sheet. Approved XYZ style sheets come with a listing of all the tag names for handy reference. As you add tags to the style sheet, you can capitalize the name or not as you prefer. Many people choose to use all capitals, or start the name with a symbol such as ! so the tags stand out from the text.¶

¶

@HEAD4 = Choosing tag names¶

¶

By choosing <169>generic<170> tag names, you will find that you can reuse them over and over again. For instance, tags like <169>Title,<170> <169>List,<170> and <169>Subhead<170> will apply to most documents. Then by changing style sheets, you can change the entire format of the document.¶

¶

If you don't like the keyboard macro idea, try building word processor template files. Load an unformatted text file into Ventura and tag it as you would normally. When everything is perfect, save the chapter (thereby saving the tags into the text file.)

Now make a copy of the file under a new name. Remove the text, leaving only the tags. Assuming the tag names are self-descriptive, a template makes it fill-in-the-blanks simple to create preformatted files. To make it even simpler, annotate the template with the word processor's hidden text feature.

ASCII file to create: C:\TEMP\6TOC.TXT

```
INSIDE
|
| @TOCENTRY = Training workshops
| underway→1
|
```

Chapter Seven

ASCII file to create: C:\TEMP\7DIRECT.TXT

```
@HEADSECTION = Manufacturers
|
| @HEAD1 = A
|
| @HEAD2 = Adobe, Inc
|
| 1870 Embarcadero Rd.<R>Palo Alto, CA 94303
|
| @HEAD3 = Product:
|
| @ITALKWN = PostScript, Illustrator, Adobe Type
| Library
|
| @HEAD3 = Phone:
|
| @ITALSEPARATE = (415) 852-0271
|
| @HEAD2 = Allied Linotype Co.
|
| 425 Oser Ave.<R> Hauppauge, NY 11788
|
| @HEAD3 = Product:
|
| @ITALSEPARATE = Linotronic 100 and 300
|
| @HEAD3 = Phone:
|
```

```
|
| The template method is particularly useful when
| an editor must work with multiple authors.
|
```

```
|
| Authors can also assist in the layout process by
| inserting tags that create space for illustrations.
| If you uses visuals in standard sizes, create a tag
| that leaves the correct amount of space on the
| page. The authors can type in the name of the
| illustration or even its caption. This tagged para-
| graph creates space where the layout editor will
| want to place the actual frame. The editor can
| delete the tag and insert the frame that will con-
| tain the illustration.
```

```
@TOCENTRY = Ventura complements CAD→1
|
| @TOCENTRY = Newsline→2
|
| @TOCENTRY = Tip of the month→3
```

```
@ITALSEPARATE = (516) 434-2016
|
| @HEAD2 = Autodesk, Inc.
|
| 2320 Marinship Way<R>Sausalito, CA 94965
|
| @HEAD3 = Product:
|
| @ITALKWN = AutoCAD, AutoSketch
|
| @HEAD3 = Phone:
|
| @ITALSEPARATE = (415) 332-2344
|
| @HEAD1 = D
|
| @HEAD2 = Datacopy Corp.
|
| 1215 Terra Bella Ave<R>Mountain View, CA
| 94043
|
| @HEAD3 = Product:
|
| @ITAL KPWTHNXT = Model 730 Scanner
|
| @HEAD3 = Phone:
|
```

@ITALSEPARATE = (415) 965-7900¶
 ¶
 @HEAD2 = Digital Research Inc.¶
 ¶
 60 Garden Court<R>Monterey, CA 93942¶
 ¶
 @HEAD3 = Product: ¶
 ¶
 @ITALKWN = GEM Desktop, GEM Draw Plus,
 GEM Paint¶
 ¶
 @HEAD3 = Phone: ¶
 ¶
 @ITALSEPARATE = (408) 649-3896¶
 ¶
 @HEAD1 = H¶
 ¶
 @HEAD2 = Hewlett-Packard¶
 ¶
 P.O. Box 15<R>Boise, ID 83707¶
 ¶
 @HEAD3 = Product: ¶
 ¶
 @ITALKWN = Laserjet Plus, Laserjet II, Scanjet
 ¶
 ¶
 @HEAD3 = Phone: ¶
 ¶
 @ITALSEPARATE = (208) 323-3869¶
 ¶
 @HEAD1 = I¶
 ¶
 @HEAD2 = Imagen ¶
 ¶
 2650 San Tomas Expressway<R>Santa Clara, CA
 95051¶
 ¶
 @HEAD3 = Product: ¶
 ¶
 @ITALKWN = DDL Language¶
 ¶
 @HEAD3 = Phone:¶
 ¶
 @ITALSEPARATE = (408) 986-9400¶
 ¶
 @HEAD1 = L¶
 ¶
 @HEAD2 = Lotus Development Corp.¶
 ¶
 55 Cambridge Parkway<R>Cambridge, MA
 02142¶
 ¶
 @HEAD3 = Product: ¶
 ¶

@ITALKWN = Lotus 1-2-3, Symphony, Freelance,
 Graphwriter¶
 ¶
 @HEAD3 = Phone: ¶
 ¶
 @ITALSEPARATE = (617) 577-8500¶
 ¶
 @HEAD1 = M¶
 ¶
 @HEAD2 = Media Cybernetics¶
 ¶
 8484 Georgia Ave., Ste. 200<R>Silver Spring, MD
 20910¶
 ¶
 @HEAD3 = Product: ¶
 ¶
 @ITALKWN = Halo Desktop Publishing Editor¶
 ¶
 @HEAD3 = Phone: ¶
 ¶
 @ITALSEPARATE = (301) 495-3305¶
 ¶
 @HEAD2 = MicroPublishing¶
 ¶
 21150 Hawthorne Blvd., Ste. 104<R>Torrance,
 CA 90503¶
 ¶
 @HEAD3 = Product: ¶
 ¶
 @ITALKWN = microPublishing Report Newslet-
 ter, Ventura Style Sheets¶
 ¶
 @HEAD3 = Phone: ¶
 ¶
 @ITALSEPARATE = (213) 376-5724¶
 ¶
 @HEAD1 = R¶
 ¶
 @HEAD2 = Ricoh Corp.¶
 ¶
 5 Dedrick Place<R>West Caldwell, NJ 07006¶
 ¶
 @HEAD3 = Product: ¶
 ¶
 @ITALKWN = IS30 Scanner¶
 ¶
 @HEAD3 = Phone: ¶
 ¶
 @ITALSEPARATE = (201) 882-2000¶
 ¶
 @HEAD1 = S¶
 ¶
 @HEAD2 = Sigma Designs¶
 ¶
 46901 Landing Parkway<R>Fremont, CA 94538¶

```

¶
@HEAD3 = Product: ¶
¶
@ITALKWN = LaserView Display System¶¶
¶
@HEAD3 = Phone: ¶
¶
@ITALSEPARATE = (415) 770-0100¶
¶
@HEAD2 = Symsoft¶
¶
P.O. Box 477<R>Mountain View, CA 94040¶
¶
@HEAD3 = Product: ¶
¶
@ITALKWN = HotShot¶
¶
@HEAD3 = Phone: ¶
¶
@ITALSEPARATE = (415) 941-1552¶
¶
@HEAD1 = T¶
¶
@HEAD2 = Tall Tree Systems¶
¶

```

```

1120 San Antonio Rd.<R>Palo Alto, CA 94303¶
¶
@HEAD3 = Product: ¶
¶
@ITALKWN = J Laser Plus¶
¶
@HEAD3 = Phone: ¶
¶
@ITALSEPARATE = (415) 964-1980¶
¶
@HEAD1 = V¶
¶
@HEAD2 = Verticom, Inc.¶
¶
545 Weddell Dr.<R>Sunnyvale, CA 94089-2114¶
¶
@HEAD3 = Product: ¶
¶
@ITALKWN = Desktop 1280¶
¶
@HEAD3 = Phone: ¶
¶
@ITALSEPARATE = (408) 747-1222¶
¶

```

ASCII file to create: C:\TEMP\7DIRECT2.TXT

```

@HEADSECTION = Products ¶
¶
@HEAD1 = F¶
¶
@HEAD2 = Fonts and Font Software¶
¶
@HEAD4 = Adobe Typeface Library¶
¶
@COMPANY = Adobe Systems Inc.¶
¶
@HEAD3 = PostScript:¶
¶
@ITALKWN = Yes¶
¶
@HEAD3 = Computers:¶
¶
@ITALKWN = Macintosh, IBM PC¶
¶
@PHONE = (415) 852-0271¶
¶
@HEAD4 = Conofonts¶
¶
@COMPANY = Conographics¶
¶
@HEAD3 = PostScript:¶
¶

```

```

@ITALKWN = No¶
¶
@HEAD3 = Computers:¶
¶
@ITALKWN = IBM PC¶
¶
@PHONE = (714) 474 -1188¶
¶
@HEAD4 = Fluent Fonts¶
¶
@COMPANY = Genny Software Research and
Development¶
¶
@HEAD3 = PostScript:¶
¶
@ITALKWN = Yes¶
¶
@HEAD3 = Computers:¶
¶
@ITALKWN = Macintosh¶
¶
@PHONE = (409) 860-5817¶
¶
@HEAD4 = Hewlett Packard Soft Fonts¶
¶
@COMPANY = Hewlett Packard¶

```

¶
 @HEAD3 = PostScript:¶
 ¶
 @ITALKWN = No¶
 ¶
 @HEAD3 = Computers:¶
 ¶
 @ITALKWN = IBM PC¶
 ¶
 @PHONE = (800) 538-8787¶
 ¶
 @HEAD4 = PC Fontware¶
 ¶
 @COMPANY = Bitstream¶
 ¶
 @HEAD3 = PostScript:¶
 ¶
 @ITALKWN = No¶
 ¶
 @HEAD3 = Computers:¶
 ¶
 @ITALKWN = IBM PC¶
 ¶
 @PHONE = (617) 497-6222¶
 ¶
 @HEAD1 = G¶
 ¶
 @HEAD2 = Graphics Software¶
 ¶
 @HEAD4 = AutoCAD¶
 ¶
 @COMPANY = Autodesk,Inc.¶
 ¶
 @HEAD3 = Ventura Format:¶
 ¶
 @ITALKWN = SLD or GEM¶
 ¶
 @HEAD3 = Computers:¶
 ¶
 @ITALKWN = IBM PC¶
 ¶
 @PHONE = (415) 332-2344¶
 ¶
 @HEAD4 = Desktop Publisher's Graphics¶
 ¶
 @COMPANY = IMSI¶
 ¶
 @HEAD3 = Ventura Format:¶
 ¶
 @ITALKWN = Image¶
 ¶
 @HEAD3 = Computers:¶
 ¶
 @ITALKWN = IBM PC¶
 ¶

@PHONE = (415) 454-7101¶
 ¶
 @HEAD4 = Halo DPE¶
 ¶
 @COMPANY = Media Cybernetics¶
 ¶
 @HEAD3 = Ventura Format:¶
 ¶
 @ITALKWN = Halo DPE¶¶
 ¶
 @HEAD3 = Computers:¶
 ¶
 @ITALKWN = IBM PC¶
 ¶
 @PHONE = (301) 495-3305¶
 ¶
 @HEAD4 = PC Paintbrush Plus¶
 ¶
 @COMPANY = ZSoft¶
 ¶
 @HEAD3 = Ventura Format:¶
 ¶
 @ITALKWN = PC Paintbrush¶
 ¶
 @HEAD3 = Computers:¶
 ¶
 @ITALKWN = IBM PC¶
 ¶
 @PHONE = (404) 980-1950¶
 ¶
 @HEAD1 = M¶
 ¶
 @HEAD2 = Monitors¶
 ¶
 @HEAD4 = Crystal View¶
 ¶
 @COMPANY = Taxan¶
 ¶
 @HEAD3 = Resolution:¶
 ¶
 @ITALKWN = 1,280 x 960¶
 ¶
 @HEAD3 = Display Size:¶
 ¶
 @ITALKWN = 19¶¶
 ¶
 @PHONE = (818) 810-1291¶
 ¶
 @HEAD4 = Laserview¶
 ¶
 @COMPANY = Sigma Design¶
 ¶
 @HEAD3 = Resolution:¶
 ¶
 @ITALKWN = 1,664 x 1200¶

¶
 @HEAD3 = Display Size:¶
 ¶
 @ITALKWN = 19¶
 ¶
 @PHONE = (415) 770-0100¶
 ¶
 @HEAD4 = Viking I¶
 ¶
 @COMPANY = Moniterm¶
 ¶
 @HEAD3 = Resolution:¶
 ¶
 @ITALKWN = 1,280 x 960¶
 ¶
 @HEAD3 = Display Size:¶
 ¶
 @ITALKWN = 19.6¶
 ¶
 @PHONE = (612) 935-4151¶
 ¶
 @HEAD4 = Wy-700¶
 ¶
 @COMPANY = Wyse Technology¶
 ¶
 @HEAD3 = Resolution:¶
 ¶
 @ITALKWN = 1,280 x 800¶
 ¶
 @HEAD3 = Display Size:¶
 ¶
 @ITALKWN = 15¶
 ¶
 @PHONE = (408) 433-1000¶
 ¶
 @HEAD1 = S¶
 ¶
 @HEAD2 = Scanners - Graphics and OCR¶
 ¶
 @HEAD4 = Crystal Scan Image Scanner Model
 3001¶
 ¶
 @COMPANY = Taxan Corporation¶
 ¶
 @HEAD3 = Scan Area:¶
 ¶
 @ITALKWN = Platen Feed¶
 ¶
 @HEAD3 = List Price:¶
 ¶
 @ITALKWN = \$1,695¶
 ¶
 @PHONE = (818) 810-1291¶
 ¶
 @HEAD4 = Datacopy 730¶

¶
 @COMPANY = Datacopy¶
 ¶
 @HEAD3 = Scan Area:¶
 ¶
 @ITALKWN = Flatbed¶
 ¶
 @HEAD3 = List Price:¶
 ¶
 @ITALKWN = \$1,800¶
 ¶
 @PHONE = (800) 821-2898¶
 ¶
 @HEAD4 = Microtek MS-300C¶
 ¶
 @COMPANY = Microtek Lab, Inc.¶
 ¶
 @HEAD3 = Scan Area:¶
 ¶
 @ITALKWN = Platen Feed¶
 ¶
 @HEAD3 = List Price:¶
 ¶
 @ITALKWN = \$1,795¶
 ¶
 @PHONE = (213) 321-2121¶
 ¶
 @HEAD4 = The Laser Scanner, Model KS-300¶
 ¶
 @COMPANY = Princeton Graphics Systems¶
 ¶
 @HEAD3 = Scan Area:¶
 ¶
 @ITALKWN = Platen Feed¶
 ¶
 @HEAD3 = List Price:¶
 ¶
 @ITALKWN = \$1,095¶
 ¶
 @PHONE = (609) 683-1660¶
 ¶
 @HEAD1 = U¶
 ¶
 @HEAD2 = Utilities¶
 ¶
 @HEAD4 = PubSet¶
 ¶
 @COMPANY = EDCO Services¶
 ¶
 @HEAD3 = Description:¶
 ¶
 @ITALKWN = Software typesetter driver to send
 Ventura documents directly to your typesetter¶
 ¶
 @HEAD3 = List Price:¶

```

¶
@ITALKWN = $4,233¶
¶
@PHONE = (813) 962-7800¶
¶
@HEAD4 = VPToolbox¶
¶
@COMPANY = SNA, Inc.¶
¶
@HEAD3 = Description:¶
¶
@ITALKWN = File management program that
lets you review the contents of related files and
style sheets¶
¶
@HEAD3 = List Price:¶
¶
@ITALKWN = $99¶
¶
@PHONE = (609) 683-1237¶
¶
@HEAD4 = VP/Saddle¶
¶
@COMPANY = The Laser Edge¶
¶
@HEAD3 = Description:¶

```

```

¶
@ITALKWN = Enhanced features for printing
books and booklets with PostScript Printers¶
¶
@HEAD3 = List Price:¶
¶
@ITALKWN = $79¶
¶
@PHONE = (415) 835-1581¶
¶
@HEAD4 = Headline¶
¶
@COMPANY = Corel¶
¶
@HEAD3 = Description:¶
¶
@ITALKWN = Application program which gives
access to the powerful graphics features of Post-
Script¶
¶
@HEAD3 = List Price:¶
¶
@ITALKWN = $89¶
¶
@PHONE = (613) 728-8200¶
¶

```

Chapter Eight

ASCII files to create: C:\TEMP\8BOOK.TXT and C:\TEMP\8PRINT.TXT

If you do not want to type in the two text files below, substitute two text files of your own and rename them as shown above. Text files of five

pages or longer are best. Save them in ASCII format.

ASCII file to create: C:\TEMP\BOOK.TXT

```

@CHAP# = Chapter Six¶
¶
@CHAPTITLE = <$IDesign;Design Prin-
ciples>Design Principles¶
¶
@BODYFIRST = Getting top-quality books from a
desktop publishing system requires special know-
how in two areas: design and printing. This chap-
ter discusses the theory of design. The following
chapter, Chapter Seven, outlines the steps to take
before going to a commercial printer. ¶
¶
This chapter offers comments on the principles of
<$IBooks;Book design>book design <MI>as they
apply to desktop publishing<D>. In some cases,
the realities of desktop publishing force changes
from traditional methods. ¶

```

```

¶
@HEAD1 = Design Terminology¶
¶
If you're new to page design and typography,
you'll need to learn a few words. You'll encounter
this vocabulary over and over again in software
manuals and in conversations with graphic desig-
ners and commercial printers. This specialized
terminology applies to three areas: (1) describing
pages, (2) measuring pages and (3) describing
type.¶
¶
@HEAD2 = <$IDescribing pages>Describing
Pages ¶
¶
The most common page elements used in tradi-

```

tional and desktop publishing are described below:¶

¶
A <\$ICallouts>callout is a brief text label used to describe one part of an illustration. Callouts are often accompanied by arrows.<MS>¶

¶
A <\$ICaption>caption is a brief description that labels or describes the entire illustration. Also referred to as a <\$ACutline;Caption><MI>cutline<D> or a <MI>legend<D>. ¶

¶
The chapter number and chapter title identify the section of the book. Often one or both are repeated in the header.¶

¶
<\$ICrop marks><\$SCrop marks;Describing Pages>Crop marks are small lines, usually at the corner of the live area, that show the offset printer where to cut the pages after printing. They are also used by the printer to align each page correctly. Also called <\$ICorner Marks><\$A-Corner marks;Crop marks>corner marks, or<MI><D>trim marks.¶

¶
The <\$IFolio>folio is the page number.¶

¶
A <\$IFooter>footer is a line or two of text that appears at the bottom of every page (or almost every page). A footer may include the folio (page number) or other information.¶

¶
A <\$IGutter>gutter is the white space between two areas of text. Gutters appear between columns on a page. The word also refers to the margin between facing pages.<MS>¶

¶
A <\$IHeader> header is a line or two of text that appears at the top of every page (or almost every page). A header often includes the title of the book, the title of the chapter and/or the folio.<MS> <D>Alternating <\$IHeader;Alternating headers and footers>headers and footers put different information on left and right pages. Quite often the header is omitted from the<MI><D>first page of a chapter.<MI>¶¶

¶
A <\$IHeading>heading is a few words set off from the rest of the text to describe a major section of the chapter. Also called a main heading.¶

¶
A keyline is a thin rule that shows the printer where to position a halftone or other illustration.¶

¶

The live area is the area of the page that receives ink when printed.¶

¶
The margins are the white borders that surround the live area. Margins must be carefully considered to take into account the look of the book, the binding method and the limitations of laser printers. ¶

¶
A subhead is a few words set off from the rest of the text to describe a minor section of the chapter. Also called a <MI>minor heading<D>. ¶

¶
@HEAD2 = Measuring Pages¶

¶
Most Americans are comfortable with inches. But for desktop publishing, the method called <MI>printer's measure<D> or <MI>the point system<D> is superior. Since type sizes are always specified in points, it makes sense to use printer's measure for everything on the page so you don't waste time converting back and forth. In addition, the point system has units that are much smaller than inches, so it is rarely necessary to complicate things with fractional units. By contrast, using inches requires you to make many fractional computations.¶

¶
For these reasons, printer's measure is the easiest way to talk to a page layout program. (Most programs let the user choose between inches, centimeters or printer's measure.) The two most important units in printer's measure are <MI>points<D> and <MI>picas<D>.¶

¶
Points are a very small unit, about 1/72 inch. They are used to measure type sizes and rules. The point size of a typeface is roughly the measurement from the highest ascender (the top of a <169>b<170> for instance) to the lowest descender (the bottom of a <169>g<170>). This is only an approximation, since point sizes originate from the metal body used to carry type in the days before phototypesetting. The best way to get familiar with point sizes is by example. You'll soon develop an eye for the most common sizes.¶

¶
Picas are a larger unit. Don't confuse them with the typewriter style of the same name. They are equal to 12 points (about 1/6 inch). Printers and typographers use picas to measure lines, margins and columns. Figure 6-2 shows a page from this book with the measurements expressed in picas and points. (The measurements refer to the full-sized page.)¶

¶
 <\$IEm Dash>Ems and <\$IEEn Dash>ens are less important but you'll hear them mentioned. Ems and ens vary according to the size of the type. In 12-point type, an em is 12 points. In 18-point type it is 18 points, and so on. An en is 1/2 the em. In 12-point type, then, the en is 6 points; in 18-point type it is 9 points, and so on.<MS>¶

¶
 The em is the basis for spacing. An <MI>em indent<D>, also called an em square, is an indent from the left margin equal to the em size <197> 12 points in 12-point type, 18 points in 18-point type, and so on. It is the standard indent for books. ¶

¶
 The most common use for the em is to describe the <MI>em dash<D>. The em dash is, obviously, the length of one em. Em dashes are used to separate sentences <197> like this. The most common convention is to use the em dash without any space between the dash and the word<197>like this. It is also acceptable to use the em dash with a space on both sides, as has been done in this book.¶

¶
 En dashes are half the length of the em. They are used to represent <169>to<170> between numbers and words, as in <169>1950<196>1955<170> or <169>Figure 1-2.<170> The hyphen is even shorter yet. It is used to <\$IHyphenation>Use of en dash>hyphenate words. Some desktop publishing programs make no distinction between hyphens and en dashes.¶

¶
 @HEAD2 = Describing Type ¶

¶
 Unfortunately, different programs use different words to refer to type and its attributes. The definitions given below are the most common in the desktop publishing industry. In some cases, they vary from those in use by traditional typesetters.¶

¶
 Type sizes are specified in points as explained above. You must understand the point system to give correct instructions to the software. Many people refer to small type in the 9 to 12 point range as <\$IBody type>body type. Larger sizes used for headings is often called <\$IDisplay Type><\$ADisplay Type>Headings>display type.¶

¶
 <MS>TYPE STYLES.<D> Most desktop publishing programs use typeface and typestyle synonymously to mean one particular type design. Each design has a name. Helvetica is one typestyle; Century Schoolbook is another; and so on. To

choose a different design from the page layout program, the user specifies it by name or picks its name from a menu. ¶

¶
 A font is one particular variety of a typestyle. Thus, most software manuals would refer to Dutch as a typestyle and 12-point Dutch bold italic as a font. Most publishing programs have a <\$IFonts>Font menu item where the user can specify all the attributes of the typestyle.¶

¶
 <MS>KINDS OF TYPE.<D> Different people divide type in different groups. Book publishers are most likely to use three different kinds: serif, sans serif and symbol. Serifs are curlicues that decorate the ends of letters, so serif type is distinguished by these tiny lines. This book uses a serif typestyle. Sans is the French word for without, so sans serif is type without the curlicues. And symbol fonts, sometimes called <\$IFonts>Pi fonts>pi fonts, contain special characters, symbols, foreign language characters and so on.<MI> ¶

¶
 There are other kinds of type available from desktop publishing systems, including script, cursive, shadow, outline and reverse (white letters on a black background). These decorative effects can be achieved directly in some page layout programs. They can also be created in a special graphics programs and imported onto the page. These unusual typestyles are rarely used in books except for covers or chapter openings. ¶

¶
 <MS>TYPE ATTRIBUTES<D>. The same typestyle can vary in several ways. <MI>Weight<D> refers to the thickness of the letterstrokes. Most desktop publishing programs provide only normal and <\$IBold><\$ABold>Text Attributes>bold. A few programs offer light as well. <MI>Slope<D> refers to the slant of the letters, either vertical (called normal or roman) or slanted (italic or oblique). The <MI>proportion<D> of type is its horizontal width. Most desktop publishing programs offer only normal proportions. Occasionally they also provide access to condensed and expanded versions.¶

¶
 @HEAD2 = Other Important Terms¶

¶
 Understanding printer's measure is the most important part of becoming a good desktop designer. But you'll also encounter a few other phrases:¶

¶
 The <\$IBaseline>baseline is the invisible line the type sits on. Some programs use this term and/or

display the baselines as a light gray or dashed line on screen. Whether or not the term is used by the program, line spacing is measured from baseline to baseline. If you were using 8-point type with 2 points of leading, the baseline to baseline measurement would be 10 points (8 + 2).<MS>¶

¶
Some programs, including Xerox Ventura Publisher, modify this concept slightly. Ventura Publisher considers the baseline to be the bottom of the lowest descender rather than the line upon which the body of the type rests.¶

¶
<MS>PAGE FORMAT<D>. There are four basic formats. <MI>Flush left<D> has an even left margin and a ragged right margin. For this reason it is often referred to as ragged right. <MI>Flush right<D> is the reverse: even right margin, ragged left margin. <MI>Justified<D> has even margins left and right. <MI>Centered<D> puts each line in the center, leaving both margins ragged. Justified is the choice for almost all books. Poetry often uses centered lines. Flush left is occasionally chosen for special formats. Flush right has few applications in <\$IBooks;Page format>books outside of titles, tables and charts.¶

¶
<\$IHyphenation;Hyphenation and justification>Hyphenation and justification are crucial to achieve a typeset look. When justifying lines, page layout programs attempt to end lines at the space between words. When that is not possible, they insert a hyphen, and put part of the word on one line and the remainder on the line below. Text can be justified without hyphenation, but this forces the program to stretch the words too far apart.¶

The computer program needs to know where it is allowed to insert hyphens when needed. Good page layout programs insert invisible <\$IHyphenation;Discretionary hyphens>discretionary hyphens into text files when they are loaded. These discretionary hyphens tell the program where to divide a word if necessary. By hyphenating a word, the program can fit a few extra characters on the line, improving the spacing and appearance.¶

¶
<HEAD1 = <\$ABooks;Design Guidelines for Books><\$IDesign;Design Guidelines for Books>Design Guidelines for Books¶

¶
Good page design is inconspicuous <197> it calls

attention to the message, not to itself. But just because good design isn't loud and flashy doesn't mean there isn't a lot going on behind the scenes. Definite rules, skills and aesthetic choices go into the creation of book pages. Until now, this knowledge was the province of specialists. Desktop publishing, however, forces untrained users to grapple with the same decisions.¶

¶
Fortunately, there is a way to harness the power of desktop publishing <197> <MI>design<D>. Design is a business tool, a way to make words more effective. It is often regarded as an innate ability <197> you're born with it or you're not. In reality, you <MI>can<D> learn the fundamentals of good design. Creating straightforward, professional pages just takes a little know-how. You can get such pages by consistently applying a few safe and sane rules.¶

¶
<HEAD2 = <\$IDesign;Purpose of>The Purpose of Page Design¶

¶
Page design has five goals: ¶

¶
<BULLET = Attract attention¶

¶
<BULLET = Please the eye¶

¶
<BULLET = Provide guideposts¶

¶
<BULLET = Improve legibility¶

¶
<BULLET = Make production easier and more efficient¶

¶
<MS>ATTRACTING THE EYE<D>. The attention-grabbing power of design does not play a large role in <\$IBooks;Book covers>books, except on covers. Covers are such a crucial part of marketing that they are best left to design professionals. It is valuable to understand, however, that cover design can set a book apart on the shelves and entice browsers.¶

¶
<MS>PLEASING THE EYE<D>. Once again, this aspect of design does not have the same crucial role in <\$IBooks;Book publishing>book publishing as in magazine publishing and <\$IAdvertising;Design applications>advertising. Nevertheless, a book's physical format can add (or detract) from its sales appeal. To compete in the marketplace, books must meet certain minimum standards of design and attractiveness. What's more, the book must project the right image for

the target market, whether business, educational, scientific or mass market.¶

¶ This chapter does not go into the more esoteric aspects of pleasing the eye. But it is valuable to realize that top-quality books utilize balance, symmetry and proportion for aesthetic effect. Novice desktop publishers are well-advised not to stray too far from time-tested formats.¶

¶ <MS>GUIDING THE EYE<D>. A page can be a structuring device, a way to organize information. The eye needs guideposts or it becomes lost in a sea of type. Readers need signals so they don't miss key information. Good page design makes documents easier to use by providing these visual cues. There are three keys to guiding the eye: contrast, separation and consistency. ¶

¶ Light against dark, small against large, slanted against upright, one typestyle against another <197> these are all examples of contrast. The eye picks up these differences, which provide signals and separation. ¶

¶ Visual separation tells the eye that something new is coming along. You can achieve it with contrast, with barriers or with formatting. Barriers are page elements that stop the eye. The most common barrier <197> and generally the best one <197> is white space. This book, for example, contains extra white space above <IHeadings>headings and subheadings. Rules (lines across the page) are another effective barrier. Format can

ASCII file to create: C:\TEMP\8PRINT.TXT

@CHAP# = Chapter Seven¶

¶ @CHAPTITLE = Offset Printing From Laser Mechanicals ¶

¶ @BODYFIRST = This is not a report on printing or production. Nevertheless, it will be valuable to briefly review the traditional production process. We can then examine how that process changes for desktop publishing. Our discussion centers around laser printers, but much of the advice also applies when electronic pages are sent to phototypesetting machines. The workflow is the same. The difference is that phototypeset pages don't need the extra precautions necessary with low-resolution laser type. ¶

¶

also provide visual separation. The way text is spaced and indented give clues to the reader. The more complex the document, the more important it is to use formatting to guide the reader <197> one reason technical documentation often has several levels of indents. Headings, subheadings, lists and quotes are often good candidates for special formatting. ¶

¶ But contrast and separation won't accomplish their purpose without consistency. Once a rule has been established, it should be used throughout the book. Every heading, for example, should use the same format.¶

¶ <IDesign;Design Guidelines for Books>Improving legibility is the fourth goal of page design. The way text is laid out on the page affects how easy it is to read. You must be careful to avoid designs that look good on the screen but are difficult to read for long stretches.¶

¶ Making production easier and more efficient is the final goal of page design and certainly one of the most important. Page designs must take into account the realities of today's desktop publishing programs to minimize their weaknesses and play up their strengths. Often a few small changes can make a format much faster and easier to work and/or improve the final printed result. At the same time, a page design should be cost-efficient <197> for example, by using trim sizes that correspond to standard offset press dimensions.

@HEAD1 = Traditional Book Printing¶

¶ Traditionally, book publishers delivered camera-ready copy to the lithographer (the commercial printer). This material was in the form of <169>mechanicals.<170> Mechanicals were made by pasting type and line art onto stiff mounting boards. These mechanicals were then photographed to produce printing plates. ¶

¶ Photographs were not pasted on the boards. Original photographs have continuous tone <197> a full range of shades ranging from dark to light. Printing is an all or nothing, black or white process <197> either there's ink on the page or there's not. To simulate continuous tone, a photograph must be <MI>screened<D>. This

process converts the photo into a <MI>halftone<D>. A halftone breaks the photograph into tiny dots. Since the human eye perceives closely spaced black dots as gray, a halftone permits a printing press to simulate the shades of a continuous tone photograph. ¶

¶ Black and white line art can be treated like text <197> it does not require a halftone. But continuous tone drawings <197> those with shadings and gray tones <197> must be converted into halftones before printing. Black and white pictures need one halftone. Color photographs need four, one for each of the three primary colors and one for black. These four halftones are called <MI>color separations<D>.¶

¶ The more dots per inch, the better the quality of a halftone. Newspapers typically use a screen of 65 to 85 dpi. Inexpensive books sometimes use 100-line screens (100 dpi), which give quality that's good but not great. Modern photocopiers can reproduce screens up to 100 dpi. Most books, however, are printed using the superior resolution of 133- to 150-line screens. After the halftoning process, the converted photograph can be recombined with the text to form the complete page. ¶

¶ How the photographs are combined with the text depends on the type of printing. <MI>Getting It Printed<D>, an outstanding book for anyone who buys printing services, divides the industry into two categories: commercial printers and quick printers. Commercial printers typically produce longer jobs. They produce metal printing plates by combining line negatives (negatives of the text and the line art) with halftone or separation negatives (negatives of photographs). Quick printers are sometimes used for short-run books. They produce plates directly without an intervening negative stage. For this reason, photographs must be pasted onto the page in the correct position before they are given to a quick printer. Those photographs must first be converted to a printable form through halftoning.¶

¶
@HEAD1 = The Desktop Workflow¶

¶ Desktop publishers do most of their paste-up electronically. Then they substitute laser-printed pages for mounting boards. Typically, the text is laid out first. Then line art is placed on the page, since line art can be imported directly into page layout programs. ¶

¶

@HEAD2 = Preparing Photographs¶

¶ Photographs, on the other hand, must still be handled the old-fashioned way. Although page layout programs can accept scanned photos, the end result is generally not up to the standards of book publishers. So a space, or <MI>>window<D> is created for each photo. What you do with the window depends on whether you are using a commercial printer or a quick printer. ¶

¶ If you are going to a commercial printer, the windows are left blank. The photographs are given to him separately. He makes separate negatives of the text (including the windows) and the photos. At this time the photographs are screened (converted to a halftone) and scaled (re-sized) if necessary. Then the two negatives are combined in a process called <MI>stripping.<D> This method produces the best results. It is mandatory for color photographs.¶

¶ There is a second, less expensive alternative for black and white photos. If you are using a quick printer, you must paste the photos onto the page directly. However, normal photos won't reproduce, so they must first be screened. Rather than creating a halftone negative, as you would for a commercial printer, you obtain a halftone <MI>positive<D>. While it is being screened, the photo is also re-sized if necessary. This converted version of the photograph is pasted directly onto the laser-printed page, in the window. The combined page is given to the lithographer. This method is less expensive, because the lithographer no longer has to strip the two negatives together. He can take a single shot of the combined page and use it to create a printing plate. There is, however, some loss of image quality (reproducing a photo of a photo). There is also the risk that cut lines will show. ¶

¶ Positive halftones go by several different names, including <MI>PMTs<D>, <MI>veloxes<D> and <MI>stats.<D> Although there are slight differences, they all work in the same basic fashion. Many books and references state that 100 dpi is the best you can expect using the PMT method. In fact, knowledgeable printers can obtain results up to 120 dpi. The loss in quality, therefore, does not have to be great. On the other hand, this second alternative does require the desktop publisher to do some paste-up.¶

¶

There are two easy ways to obtain a positive

halftone. The best is to take the photo to a commercial printer or a trade camera shop. (To locate trade camera services, look in the yellow pages under <169>lithographic negative and plate makers.<170>) These services turn photos into positive halftones for \$5 to \$15 each. At the same time they can resize the photo if necessary. Ask them to use fixer during development. Otherwise the prints will yellow and fade in a few months. When you get the screened PMTs back, check to make sure they are printed on pure white paper with no chemical stains. ¶

¶
If quality is not a concern and the photo is the right size already, you can also buy special plastic screens. The plastic is pasted on top of the photograph on the page. Cost is \$3 to \$4 per sheet from most graphic arts supply houses. You can achieve up to 85 dpi or so with this method <197> somewhat less than the 100 dpi most experts consider the minimum for a professional-quality book. You can also use a 85 dpi or 100 dpi photocopier screen for <169>homemade<170> veloxes. Run the photo through the copier with the screen on top. Use the copier's facilities to enlarge or reduce. Paste the resulting image directly onto the page. <MI>Warning<D>: quality suffers with this method.¶

¶
Use rubber cement to paste photos down. Pay extra attention to the edges <197> if they lift up they will cause a shadow line on the printed page. Use extra glue, then rub off any excess that shows after it's dry with a special rubber cement lifter available at art supply stores. You can also paste line art directly onto the page if you prefer to use existing hand drawings rather than creating the art with the computer.¶

¶
@HEAD2 = Positioning Photographs¶

¶
Whether you strip photos or paste them on the page you must create a window. Decide which photographs you plan to use, what size they will be and where they belong in the text. Using the tools of the page layout program, create a box for each picture. Make it the exact size you want the final photo. Place a thin rule around the box. This rule is called the keyline, and it's vital. The lithographer uses it to properly size and position the halftone. So will you if you decide to paste positive halftones directly onto the page. Normally the lithographer will drop out the keyline so it does not show on the printed page. If you want the rule

to show, specify "Keyline prints" in your instructions.¶

¶
Both the photos and the windows must be carefully labeled. Desktop publishers have an advantage here. They can use the text editing capabilities of the page layout software to insert labels in the center of the blank window as they go along.¶

¶
Here's another possibility for creating windows: draw a box as before. Now use the page layout program to fill the box with black. This solid black box is the equivalent of the Rubylith window some layout artists use to key photographs to mechanicals. When the page is photographed by the lithographer, the black box leaves a transparent window on the film negative. The separately prepared halftone negative is positioned behind this window.¶

¶
With the keyline method, the lithographer actually cuts the negative along the line before stripping in the halftone. This provides the ultimate in quality, since there's no intervening layer of film. Ask the printing company which method it prefers. If you are using the PMT or velox method, keylines are the way to go. Why waste toner and print time creating black boxes? All you need is something to indicate where to paste down the velox. ¶

¶
@HEAD2 = Scanning and Digitizing¶

¶
If the job requires special care, consider using a scanner to provide position stats. In traditional publishing, a position stat is a photocopy that's pasted on the page in the window. It's only function is to show the printer what goes where. If you have a scanner, you can accomplish the same thing electronically. Digitize the photograph and place it in the window using the desktop publishing software. Scanned images from today's technology are not good enough for reproduction. At best they produce the equivalent of a 50 to 70 line screen. But scanned images are ideal for proofing purposes. They allow you and the lithographer to accurately visualize how the final page will look. Scanned position stats are the ultimate in convenience and safety. It's virtually impossible to put the wrong picture on the page when you can look at a sample. But they may be too much trouble for all but the most demanding projects. Most scanners still cost over \$1000. Creating scanned images requires extra time and effort.

And storing the results demands lots of space on the hard disk. ¶

¶
If there's one thing a commercial printer wants it's consistency <197> consistent density and consistent placement. Density refers to the type. Placement refers to the position of folios, rules, column tops and bottoms, captions, key lines and other repeating page elements. They must be in the same place from page to page. Consider a rule at the top of the page. If the desktop publisher places it inconsistently, the lithographer will be unable to use it to align pages. The rule will <169>jump<170> up and down as the reader pages through the book. And it may not match up across the top of facing pages. ¶

¶
@HEAD1 = Crop Marks ¶

¶
While using the page layout program, you can take several steps to make life easier for the lithographer. One is to add keylines for photos, as discussed above. Another is to place crop marks on each page. Crop marks are also known as <169>register<170> or <169>corner<170> marks. These tiny lines help the lithographer position the page. Lithographers can work without crop marks. In such cases, they try to line up each page by using the folio or a rule as the <169>anchor.<170> Some lithographers also suggest avoiding ragged right margins. Ragged right is a good effect for certain brochures and newsletters, but it's generally inappropriate for books. If margins are even and consistent, the lithographer can use them to help position the pages. But commercial printers are happier when they can work from crop marks. Most prefer hairline rules placed just outside the live area. However, some lithographers like register marks placed inside the trim area. Ask in advance, then use your page layout program to produce the marks. ¶

¶
The specifics of creating crop marks depends on the software. In Ventura Publisher, for example, lines placed on the Underlying Page appear on every page of the document. Most software packages have a similar <169>Master Page,<170> <169>Repeating Page<170> or <169>Underlying Page<170> feature to place crop marks throughout the manuscript. ¶

¶
@HEAD1 = Screen Tints ¶

¶
Most page layout programs provide screen tints. A screen is a pattern of tiny dots. With black ink,

the dots make an area look gray. With colored ink they give a light tint. Lithographers use percentages to describe the amount of ink laid down. A 10% screen is very light; a 90% screen is very dark. Screen tints are used to highlight an area, to set text apart and to accent charts and graphs. Often type is <MI>overprinted<D> <197> laid down on top of the tint. ¶

¶
Short-run publishers who use quick printers must supply complete mechanicals. They must, therefore, put the screen tint on the page themselves. One alternative is to use the page layout program. Trouble is, the dots produced by laser printers are too large for top-quality screens. There's no problem if the screen is simply used as a pattern to fill in a pie chart or a graph. But if type is difficult to read when placed on top of a coarse screen. The smaller the type, the harder it is to read. To minimize problems, use screens of 20% or less (if the program doesn't specify percentages, use one of the two lightest shades). Keep the type as large as possible <197> 14 points or bigger if possible. An alternative is to buy tint material from an art supply store and paste it over the area to be screened. Use this option if you must put small type inside a large screened area. Buy tint material with the highest resolution you can find. ¶

¶
Publishers who use commercial printers should the printer do the screen. Indicate the area to be screened. Use a non-reproducing blue pencil, a stick-on Post-It note or write the instructions on top of a see-through tissue overlay. ¶

¶
@HEAD1 = Color printing ¶

¶
Multicolored documents are created in several passes through the printing press. Each time another color is added to a page, it must be sent through the press again. The lithographer must have a separate plate for each color. Normally, the commercial printer makes these color separations. It costs extra, of course. But desktop publishers can easily create their own separations, thereby saving money and time. The process described here works for spot color. Continuous tone color photographs must still be handled using traditional methods. ¶

¶
The method relies on the ability of some software to specify the color of different text elements. It is most effective with programs such as Xerox Ventura Publisher that use style sheets <197> docu-

ment formatting guidelines that can be prepared once and used over and over again. This report describes a method for Ventura Publisher, but it can be adapted to other programs as well.¶

¶ Let's use a two-color example. The same principles would apply for more than two colors. Consider, for instance, black text with blue headings. Start by creating the document as normal. The style sheet for this step will have all text elements specified as black. Now create another style sheet for each color. These style sheets will be identical to the first except for the color of the text elements. ¶

¶ To create a color separation for the black text, specify that all the headings (all the blue text) should print in white. By changing the color to white, the text disappears<197>white text on white paper is invisible. The beauty of this method is that the invisible headings are still on the page. Consequently, the position of the page elements does not change. The overlay for each color will match up with the others. ¶

¶ The third and final style sheet reverses the process. All the headings print in black. Everything else is set to print in white. When you print this version out on the laser printer, it shows only the text that is to be printed in blue ink. The lithographer will match the two separations to create a composite page with the black and the blue text in perfect registration. ¶

¶ The beauty of the system described here is its speed and ease-of-use. The only real investment in time is to create the two extra style sheets. Once these have been prepared, the user can create color separations in moments just by calling up the different style sheets and printing out the separate versions. If your page layout program does not have these capabilities, you can simulate the effect by manually deleting text, as long as you do so without changing the position of anything on the page. Naturally, you can also use the traditional method. Specify which elements are to be what color and let the printer prepare the separations.¶

¶
@HEAD1 = Covers ¶

¶ Some publishers may be tempted to produce covers using laser mechanicals. It is not recommended. Most covers use display type on slick

stock. That's simply too demanding for the 300 dpi resolution of laser printers. The imperfections stand out. The design of the cover is also an issue. Most publishers are unlikely to do as good a job as a professional designer. Buyers judge books by their covers, especially wholesalers, distributors and retailers. If those individuals aren't impressed, your books will never get on the shelves for readers to find. The most common failing of small independent publishers is to put a good book inside a shoddy, amateurish cover. ¶

¶ If you insist on producing camera ready art for the cover, send the file to a phototypesetter for high resolution output. And be sure to calculate carefully for the spine. You must know the number of pages and the bulk of the paper (the pages per inch) to figure the correct width. Printers say it is very difficult to correct for an improperly-sized spine. ¶

¶
@HEAD1 = Adjusting Page Count¶

¶ Desktop publishing differs from traditional publishing in another key aspect <197> the ability to make last minute changes. That capability can be put to good use to make the books you publish mesh properly with the work customs of commercial printers.¶

¶ The final page count is vitally important to a book printing job, and desktop publishers are ideally suited to adapt to the constraints of the printing industry. Lithographers print in signatures of 16 and 32 pages. You can save money by working within these limitations. Poor planning can force the lithographer to add a <169>bastard eight<170> (an undersized, eight-page signature). This extra work can add a surprising amount to the total print bill.¶

¶ And it's unnecessary, since desktop publishing gives you the control to tailor books to the right size. If the final page count is not a multiple of 16, make changes until it fits. Often a small change creates a substantial difference by the time it ripples through the entire manuscript. To shorten a book, try removing words and lines. Add hyphens to shorten paragraphs. Expand margins slightly. Reduce the size of illustrations. Go down a point size or two. Or try a different typesetyle<197>some take more space than others, even when set at the same size and line spacing.¶

¶ In other cases, you might want to up the page

count. For instance, you might be able to increase 156 pages to 160 by removing a single line from each page. An added bonus would be more white space and a more readable manuscript. Or you could add illustrations, or make existing illustrations slightly larger. As long as you need extra pages to fill up the signature anyway, consider adding some order cards at the back, or a page or two of sales copy and testimonials at the front. ¶

¶
 @HEAD1 = Improving the Look of Laser-printed Pages ¶

¶
 Several advanced techniques can boost the quality of pages printed from laser mechanicals. Although desktop laser printers can create impressive documents, the density and resolution of the type simply isn't up to the standards of traditional phototypesetters. Nowhere is this more apparent than when laser output is used as mechanicals for offset printing. Three problems occur most often: ¶

¶
 @BULLET = Washed out areas <197> sections or even entire pages that have a pale gray, washed-out appearance ¶

¶
 @BULLET = Broken letters <197> characters where small sections have dropped out ¶

¶
 @BULLET = The jaggies <197> rough, uneven edges and diagonals caused by the low resolution of laser printers ¶

¶
 Fortunately, there are tricks and techniques that improve the quality of pages printed from laser mechanicals. ¶

¶
 @HEAD2 = Improving Mechanicals ¶

¶
 <MS>SELECTING THE RIGHT TYPEFACE <D> is the first step. Some typefaces are more suitable than others for offset reproduction. If you produce more than one or two books each year, experiment with different typefaces. It may be cost effective to purchase additional fonts, either from the original supplier or from an outside company. As a bonus, your documents will not have the all-to-familiar <169>Times-Roman body, Helvetica headlines <170> look that is common to 90% of all desktop publishing documents. ¶

¶
 Getting dark, dense type is the next challenge. Laser printers, unfortunately, are plagued by drop outs and washed out, gray areas. Sometimes,

the problem lies with the toner or the toner cartridge. It also has to do with the way printers work. Some laser printer engines are better than others at creating solid black areas. The Canon CX engine at the heart of most first-generation laser printers was notorious for weak, gray letters. If your printer has a front panel control of any kind, put it on the darkest setting. Many pros also suggest removing the toner cartridge and rotating it. This may overcome clumping and clotting and help achieve a uniform print quality across the page. And cartridges work better than others. When you find one that creates dense, dark type, set it aside and save it for special print jobs. ¶

¶
 It's best to have type as dark and dense as possible. Nevertheless, if all the pages are slightly pale, most lithographers can compensate. What they hate is type that fluctuates from page to page or, worst of all, within each page. Check each page before the job goes to the lithographer. Reprint any pages that aren't consistent. ¶

¶
 <MS>SPRAYING WITH A MATTE FIXATIVE <D> usually causes laser-printed pages to <169>darken up. <170> Not only does the fixative make black areas appear darker, it also protects the pages. Fixative helps prevent smears, fingerprints and flaking. The aerosol cans are sold at art supply stores. To the best of our knowledge, any fixative suitable for charcoal drawings will also work with laser-printed pages. ¶

¶
 <MS>SPECIAL LASER PRINTER PAPER <D> is sometimes recommended for laser mechanicals. The theory is that this paper has whiter whites and blacker blacks. It also has a smoother even coating that makes it easier for the camera operator to produce a good negative. Warning: Some desktop publishers complain that certain coated laser papers jam repeatedly in laser printers. Buy a small sample and test first. ¶

¶
 Special paper may be an especially good idea for publishers who create galleys with the laser printer and paste them up using traditional methods. Some special papers contain wax hold-out that minimizes problems from waxing and paste-up. Be aware, however, that coated papers must be treated with care. The laser-printer type tends to crack and fall off if coated pages are bent, folded or stacked. ¶

¶

<MS>PHOTOREDUCTION<D> is a difficult technique, but it also has great potential for improving pages from laser mechanicals. Reducing an image makes flaws less apparent. (Conversely, enlarging magnifies flaws. That's why you should never enlarge laser type). By reducing laser type, you increase its apparent resolution. Most laser printers create type at 300 dpi. Researchers think the human eye loses its ability to distinguish individual dots at about 450 dpi. (By way of comparison, graphic arts-quality phototypesetters produce 900 dpi or higher.)¶

¶ It would seem an obvious step, then, to create pages at a larger size and reduce them down. In practice, this method creates problems. You can, for example, start with 18 point type and photoreduce it to 10 points. Unfortunately, the letterspacing and line spacing will be incorrect. Although subtle, these spacing problems begin to be noticeable when type is reduced more than 10 percent or so. In addition, fine lines or dot patterns may end up too thin to print, or disappear altogether. You may not want to make a small face even smaller or decrease the margins too much. ¶

¶ Careful planning is essential to make sure everything fits properly on the page after the photoreduction. As anyone who has sized photos already knows, it's easy to make mistakes. Basically, it's just another step and one that many publishers don't want to bother with. ¶

¶ <MS>THERE IS A SIMPLER METHOD<D> for pages where the live area is 5 x 7 or smaller. Start by laying out the page exactly as you would otherwise. Use normal linespacing, letterspacing and type sizes. At print time, however, use the Print dialog box to enlarge. The laser printer will increase by the percentage you specify. (Note: Some programs cannot perform this enlargement function. Others require a separate, add-on program.)¶

¶ Now take the enlarged page to the lithographer and instruct him to reduce back down to the original size. Since these are the dimensions you originally worked with, everything will be exactly as you saw it on the screen. The letterspacing, margins, and so on will be correct, but the type will be at a higher apparent resolution. ¶

¶ Why doesn't this technique work for pages larger than 5 x 7? Today's laser printers accept 8 1/2 x 11 paper, but they can only print to within an inch or

so of the margin, for an effective live area of only 7 1/2 x 10. You can enlarge a 5 x 7 page up to about 150% before you run out of room. When you bring this 150% enlargement back down to the original 5 X 7, you will have achieved an effective resolution of 450 dpi.¶

¶ This photoreduction technique can distinctly improve the look of a page. One Southern California publishing company, for example, wanted to produce a final live area of 3 3/4 x 6. Through trial and error, they discovered they could enlarge by 165% before coming up against the laser printer's <169>dead zone.<170> By bringing this enlargement back down to the original size, they achieved an apparent resolution approaching 500 dpi.¶

¶ What if you must produce pages larger than 5 x 7? Access to an 11 x 17 printer is one answer. The Dataproducts LZR-2665 is a PostScript compatible laser printer that produces 11 x 17 pages at 26 ppm. At \$17,900, it's too high-priced for most desktop publishers, but you may be able to find a service bureau or print center to output final copy for a page charge.¶

¶ @HEAD2 = The Lithographer Can Help

So far we've covered how the publisher should prepare laser mechanicals. In addition, the lithographer can take steps to improve the final output.¶

¶ <MS>ALTERING THE EXPOSURE<D> is one relatively simple technique. The kind of alteration depends on whether the lithographer creates a positive or a negative. In either case, the idea is the same: to alter the exposure so the type looks darker. For the traditional, high-quality method involving a film negative, a 10 percent underexposure is generally enough to help <169>fill in<170> the type. ¶

¶ Discuss this concept with the lithographer. Most of them are more familiar with the same procedure done in reverse. For example, when creating negatives, camera operators will often <MI>over<D>expose. This causes tiny specks and dots to disappear and become white. Sometimes operators refer to a <169>dropout<170> halftone, since the overexposure causes imperfections and small details to drop out. If the operator knows how to alter exposure for dropouts, ask if he can do the same thing in reverse to make the type

denser. One warning: When you darken the type, you also darken dirt, dust and other imperfections that would normally disappear. Both the publisher and the lithographer must take exceptional care to make sure the mechanicals are spotless. ¶
 ¶
 <MS>THE PAPER STOCK<D> can also make a difference. Work with the lithographer to select the paper that gives the best look for the money.

There may not be much point in going to expensive coated stock. Slick paper only brings out the shortcomings of laser type by making jagged edges and drop outs more visible. On the other hand, cheap newsprint will cause the ink to spread, making characters even fuzzier. A good grade of uncoated book stock is probably the best bet. Ask the lithographer to run some tests and give his suggestions.

Chapter Eight

ASCII file to create: C:\TEMP\8TABLE.TXT

Inches¶
 ¶
 Picas and Points¶
 ¶
 Points¶
 ¶
 1/6 inch¶
 ¶
 01,00 picas & points¶
 ¶
 12 points¶
 ¶
 1/4 inch¶
 ¶
 01,06 picas & points¶
 ¶
 18 points¶
 ¶
 1/3 inch¶
 ¶
 02,00 picas & points¶
 ¶
 4 points¶
 ¶

1/2 inch¶
 ¶
 03,00 picas & points¶
 ¶
 36 points¶
 ¶
 1 inch¶
 ¶
 06,00 picas & points¶
 ¶
 72 points¶
 ¶
 5 1/2 inches¶
 ¶
 33,00 picas & points¶
 ¶
 8 1/2 inches¶
 ¶
 51,00 picas & points¶
 ¶
 11 inches¶
 ¶
 66,00 picas & points ¶
 ¶

Chapter Nine

ASCII file to create: C:\TEMP\9TECHDOC.TXT

@TITLE = The Laser AstroZ¶
 ¶
 @TITLESUB = Guide to Operations <197> Model XYZ-11¶
 ¶
 @HEAD1 = Getting Started¶
 ¶

@HEAD2 = A Word to Owners¶
 ¶
 Thank you for choosing the Laser AstroZ printer from XYZ Corporation. This high quality laser printer gives you the flexibility and power for all your desktop publishing needs. The Laser AstroZ comes standard with PostScript, as well as

Hewlett-Packard PCL and HPGL for programs you still use that are non-PostScript compatible. ¶

¶
 @HEAD3 = Introduction ¶

¶
 First we'll show you how to unpack and install your Laser AstroZ printer. You should carefully check to make sure you have the following items: ¶

¶
 @LISTBULLET = ONE IBM PC DISKETTE in 5-1/4" format ¶

¶
 @LISTBULLET = A PRINT TRAY and manual feed guide ¶

¶
 @LISTBULLET = A PAPER CASSETTE and toner cartridge ¶

¶
 @HEAD2 = You and Your Printer ¶

¶
 Before you install your printer, make sure it is located in a well-ventilated area away from direct sunlight. Check to make sure that your office's electrical wiring is adequate. The line voltage should not vary from the factory warranted voltage marked on the back of the printer. Avoid placing the printer in an office with abrupt changes in temperature. Do not place the printer near open faucets, heaters, air conditioners, humidifiers, or radiators. ¶

¶
 Place the printer on a flat surface 8-9 inches away from the wall. Leave enough room in the front for the cartridge door to open freely. ¶

¶
 @BODYSMALL = This manual prepared by the publications and communications department, XYZ Corporation, Los Angeles, CA. ¶

¶
 @HEAD1 = Unpacking and Setting Up ¶

¶
 @HEAD2 = Unpacking ¶

¶
 Your Laser AstroZ weighs 73 pounds, so do not try to lift it without someone's help. Lift the printer by its handles and place it on a clean, stable surface. ¶

¶
 Lift the release lever and raise the upper part of the printer ¶

¶
 Lift the green fixing assembly cover and remove the four red spacers. ¶

¶
 Locate the green wire cleaner and remove its

protective sealing tape. You will use the wire cleaner to clean the corona wire in the print cartridge. ¶

¶
 @HEAD2 = The Care of Your Printer ¶

¶
 There are several routine maintenance procedures you can perform to keep your Laser AstroZ running smoothly. You should be familiar with: ¶

¶
 @LISTBULLET = Replacing the toner cartridge and cleaning stick ¶

¶
 @LISTBULLET = Cleaning the corona wires ¶

¶
 @LISTBULLET = Cleaning the guides ¶

¶
 @LISTBULLET = Cleaning and replacing the separation belts ¶

¶
 @HEAD2 = About the Toner Cartridge ¶

¶
 The toner cartridge includes powder that serves as ink to the printer. The cartridge itself has a color coded bar that will indicate the level of powder and the number of prints. If you print plain text (not graphics) at a higher toner setting, you will get more prints than if you print graphics at a lower setting. If your prints begin to look faded in areas, or streaked at the edges, replace your toner cartridge. ¶

¶
 Paper Trays, Paper Cassettes ¶

¶
 @HEAD5 = Paper Trays ¶

¶
 Print tray position<D>. Hold the print tray so the wide end faced towards the front of the printer. Insert the plastic pins into the front slots above the handle. ¶

¶
 NOTE: Do not overload the paper tray. Packing it too full will cause paper jams and print errors. ¶

¶
 Attach the manual feed guide<D>. Hold the manual feed guide with the plastic brackets towards the rear of the printer. Face the ribbed side up. ¶

¶
 Load paper in manual feed.<D> Insert one sheet of paper at a time. Glide the paper along the tray until it can't go any further, then stop. ¶

¶
 @HEAD5 = Paper Cassettes ¶

¶

Place the paper in the cassette and push it under the paper clips. Insert the paper cassette into the slot under the front of the printer until it stops. The cassette holds approximately 110 sheets.¶

Chapter Ten

ASCII file to create: C:\TEMP\PROFEXT.TXT

@TITLE = The Laser AstroZ¶

¶

@TITLESUB = Guide to Operations<197> Model XYZ-11¶

¶

@BODYBREAK = ¶

¶

@HEAD1 = Getting Started¶

¶

@HEAD2 = A Word to Owners¶

¶

Thank you for choosing the Laser AstroZ printer from XYZ Corporation. This high quality laser printer gives you the flexibility and power for all your desktop publishing needs. The Laser AstroZ comes standard with PostScript, as well as Hewlett-Packard PCL and HPGL for programs you still use that are non-PostScript compatible. ¶

¶

@HEAD3 = Introduction¶

¶

First we'll show you how to unpack and install your Laser AstroZ printer. You should carefully check to make sure you have the following items:¶

¶

@LISTBULLET = ONE IBM PC DISKETTE in 5-1/4" format¶

¶

@LISTBULLET = A PRINT TRAY and manual feed guide¶

¶

@LISTBULLET = A PAPER CASSETTE and toner cartridge¶

¶

@HEAD2 = You and Your Printer¶

¶

Before you install your printer, make sure it is located in a well-ventilated area away from direct sunlight. Check to make sure that your office's electrical wiring is adequate. The line voltage should not vary from the factory warranted voltage marked on the back of the printer. Avoid placing the printer in an office with abrupt changes in temperature. Do not place the printer near open

NOTE: If you want to print on letterhead, place the paper FACE DOWN beneath the clips.¶

¶

@HEAD1 = A Quick Tour of the Laser AstroZ

¶

faucets, heaters, air conditioners, humidifiers, or radiators. ¶

¶

Place the printer on a flat surface 8-9 inches away from the wall. Leave enough room in the front for the cartridge door to open freely.¶

¶

@BODYSMALL = This manual prepared by the publications and communications department, XYZ Corporation, Los Angeles, CA¶

¶

@BODYBREAK = ¶

¶

@HEAD1 = Unpacking and Setting Up¶

¶

@HEAD2 = Unpacking¶

¶

Your Laser AstroZ weighs 73 pounds, so do not try to lift it without someone's help. Lift the printer by its handles and place it on a clean, stable surface. ¶

¶

@LIST# = Lift the release lever and raise the upper part of the printer¶

¶

@LIST# = Lift the green fixing assembly cover and remove the four red spacers.¶

¶

@LIST# = Locate the green wire cleaner and remove its protective sealing tape. You will use the wire cleaner to clean the corona wire in the print cartridge.¶

¶

@HEAD2 = The Care of Your Printer¶

¶

There are several routine maintenance procedures you can perform to keep your Laser AstroZ running smoothly. You should be familiar with:¶

¶

@LISTBULLET = Replacing the toner cartridge and cleaning stick¶

¶

@LISTBULLET = Cleaning the corona wires¶

¶

@LISTBULLET = Cleaning the guides¶

¶

@LISTBULLET = Cleaning and replacing the separation belts¶

¶

@HEAD2 = About the Toner Cartridge¶

¶

The toner cartridge includes powder that serves as ink to the printer. The cartridge itself has a color coded bar that will indicate the level of powder and the number of prints. If you print plain text (not graphics) at a higher toner setting, you will get more prints than if you print graphics at a lower setting. If your prints begin to look faded in areas, or streaked at the edges, replace your toner cartridge.¶

¶

@BODYBREAK = ¶

¶

@HEAD4 = Paper Trays, Paper Cassettes¶

¶

@RULE = →¶

¶

@HEAD5 = Paper Trays¶

¶

@LIST# = Print tray position<D>. Hold the print tray so the wide end faced towards the front of the printer. Insert the plastic pins into the front slots above the handle. ¶

¶

@NOTE = NOTE: Do not overload the paper tray.

Packing it too full will cause paper jams and print errors.¶

¶

@SPACER = ¶

¶

@LIST# = Attach the manual feed guide<D>. Hold the manual feed guide with the plastic brackets towards the rear of the printer. Face the ribbed side up. ¶

¶

@LIST# = Load paper in manual feed.<D> Insert one sheet of paper at a time. Glide the paper along the tray until it can't go any further, then stop. ¶

¶

@HEAD5 = Paper Cassettes¶

¶

Place the paper in the cassette and push it under the paper clips. Insert the paper cassette into the slot under the front of the printer until it stops. The cassette holds approximately 110 sheets.¶

¶

@NOTE = NOTE: If you want to print on letter-head, place the paper FACE DOWN beneath the clips.¶

¶

@BODYBREAK = ¶

¶

@HEAD1 = A Quick Tour of the Laser Astro-Z<1-1>

Tag Tables

If you do not have the Power disk, you can construct the sample style sheets using the tag tables below. Each tag table includes the settings for the Page (e.g., page size and layout, margins and columns, etc.) and the settings for each tag in the style sheet. The tag tables *omit all settings that are identical to the Body Text* tag. So if a tag has the same Font as Body Text, the Font for that tag is not included in the list. Just make it the same as Body Text.

To create the style sheets, open a blank chapter, load the DEFAULT.STY style sheet from the \TYPESET subdirectory and load a sample text file onto the Page. (Make sure the text file you load does not contain any predefined tag names — or they will become part of the style sheet.) Change the Page settings first using the Chapter and Frame menus. Then go on to creating the tags.

Start with the Body Text tag. Select a paragraph and modify its font, alignment, spacing, and so forth until it matches the settings Body Text in the tag table. Once the Body Text tag is completed, begin to add new tags, one at a time, for each tag name in the table. In Paragraph mode, select any Body Text paragraph, then choose Add New Tag. Enter the new tag name. Then modify the tag's font, alignment, spacing, etc., until it matches the settings in the tag table.

After you have completed all the tags in a style sheet, select Save As New Style (File menu). Save the new style sheet in the C:\TEMP subdirectory with the name we give below. Then abandon the chapter.

C:\POWER\4FORM.STY**Save as C:\TEMP\4INVOICE.STY****Underlying Page Settings****Page Size & Layout**

| | | | |
|--------------|----------------------|--------|--------|
| Orientation: | Portrait | Sides: | Single |
| Paper Type: | Letter, 8.5 x 11 in. | | |

Margins & Columns

| | | | |
|------------------------|--------------------|-------------------------|--------------------|
| # of Columns: | 1 | Settings For Right Page | |
| Settings For Left Page | | Top: | 06,00 picas & pts. |
| Top: | 06,00 picas & pts. | Bottom: | 06,00 picas & pts. |
| Bottom: | 06,00 picas & pts. | Left: | 07,06 picas & pts. |
| Left: | 07,06 picas & pts. | Right: | 07,06 picas & pts. |
| Right: | 07,06 picas & pts. | Widths/Gutters—1: | 36,00 picas & pts. |
| Widths/Gutters—1: | 36,00 picas & pts. | | |

Tag Settings**Body Text****Font**

| | | | |
|-------|-----------|--------|--------|
| Face: | Helvetica | Style: | Normal |
| Size: | 12 points | Color: | Black |

Alignment

| | | | |
|---------------------|-------------|---------------------|--------------------|
| Horz. Alignment: | Left | First Line: | Indent |
| Vert. Alignment: | Top | Relative Indent: | Off |
| Text Rotation: | None | In/Outdent Width: | 00,00 picas & pts. |
| Hyphenation: | Off | In/Outdent Ht.: | 1 |
| Successive Hyphens: | 2 | In Fm. Rt. to Dec.: | 00,00 picas & pts. |
| Overall Width: | Column-Wide | | |

Spacing

| | | | |
|------------------|----------------------|-------------------|--------------------|
| Above: | 07.00 fractional pts | In Fm. Left (L): | 00,00 picas & pts. |
| Below: | 00.00 fractional pts | In Fm. Right (L): | 00,00 picas & pts. |
| Inter-Line: | 14.00 fractional pts | In Fm. Left (R): | 00,00 picas & pts. |
| Inter-Paragraph: | 00.00 fractional pts | In Fm. Right (R): | 00,00 picas & pts. |
| Add in Above: | Always | | |

Breaks

| | | | |
|---------------|--------|------------------|--------|
| Page Break: | No | Next Y Position: | Normal |
| Column Break: | No | Allow Within: | Yes |
| Line Break: | Before | Keep With Next: | No |

Logo

| | | | |
|-------|-----------|--------|------|
| Font | | Style: | Bold |
| Size: | 18 points | | |

Alignment

Horz. Alignment: Center

Spacing

Above: 00.00 fractional pts Add in Above: When Not at C.T.
 Inter-Line: 24.00 fractional pts

Label**Font**

Size: 10 points

Alignment

Horz. Alignment: Center Vert. Alignment: Middle

Spacing

Above: 00.00 fractional pts Inter-Line: 12.00 fractional pts

Breaks

Keep With Next: Yes

Z_BOXTEXT**Spacing**

Above: 03.00 fractional pts In Fm. Left (L): 00,06 picas & pts.
 Inter-Line: 12.00 fractional pts In Fm. Left (R): 00,06 picas & pts.

Balance**Font**

Style: Bold

Alignment

Horz. Alignment: Decimal In Fm. Rt. to Dec.: 05,06 picas & pts.

Spacing

Above: 03.00 fractional pts Inter-Line: 12.00 fractional pts

Address**Font**

Style: B-Italic

Spacing

Above: 10.00 fractional pts

LabelBlack**Font**

Size: 10 points Style: Bold

Alignment

Horz. Alignment: Center

Spacing

| | | | |
|--------|----------------------|-------------|----------------------|
| Above: | 04.00 fractional pts | Inter-Line: | 12.00 fractional pts |
|--------|----------------------|-------------|----------------------|

Breaks
Keep With Next: Yes

LabelLeft

Font
Size: 10 points

Alignment
Vert. Alignment: Middle In/Outdent Width: 00,06 picas & pts.

Spacing
Above: 00.00 fractional pts Inter-Line: 12.00 fractional pts

Breaks
Keep With Next: Yes

LabelLine

Font
Size: 10 points

Alignment
Vert. Alignment: Middle

Spacing
Above: 00.00 fractional pts Inter-Line: 12.00 fractional pts

Breaks
Keep With Next: Yes

Tab Settings
Leader Char: 95 Auto-Leader: On
Leader Spacing: 0

LogoAddress

Alignment
Horz. Alignment: Center

Spacing
Above: 00.00 fractional pts Add in Above: When Not at C.T.

ListDecimal

Alignment
Horz. Alignment: Decimal In Fm. Rt. to Dec.: 03,00 picas & pts.

Spacing
Above: 03.00 fractional pts Inter-Line: 12.00 fractional pts

Tab Settings

LabelLine

Tab Number 2: Left, 06,00, 32
Tab Number 3: Left, 09,00, 32
Tab Number 4: Left, 12,00, 32
Tab Number 5: Left, 15,00, 32
Tab Number 6: Left, 18,00, 32
Tab Number 7: Left, 21,00, 32
Tab Number 8: Left, 24,00, 32
Tab Number 9: Left, 27,00, 32

Tab Number 10: Left, 30,00, 32
Tab Number 11: Left, 33,00, 32
Tab Number 12: Left, 36,00, 32
Tab Number 13: Left, 39,00, 32
Tab Number 14: Left, 42,00, 32
Tab Number 15: Left, 45,00, 32
Tab Number 16: Left, 48,00, 32

C:\POWER\5AD.STY

Save as C:\TEMP\5MAILER.STY

Base Page Settings

Page Size & Layout

| | | | |
|--------------|----------------------|-----------|------------|
| Orientation: | Portrait | Sides: | Double |
| Paper Type: | Letter, 8.5 x 11 in. | Start On: | Right Side |

Margins & Columns

| | | | |
|------------------------|--------------------|-------------------------|--------------------|
| # of Columns: | 1 | Settings For Right Page | |
| Settings For Left Page | | Top: | 03,00 picas & pts. |
| Top: | 03,00 picas & pts. | Bottom: | 03,00 picas & pts. |
| Bottom: | 03,00 picas & pts. | Left: | 03,00 picas & pts. |
| Left: | 03,00 picas & pts. | Right: | 03,00 picas & pts. |
| Right: | 03,00 picas & pts. | Widths/Gutters—1: | 45,00 picas & pts. |
| Widths/Gutters—1: | 45,00 picas & pts. | | |

Tag Settings

Body Text

Font

| | | | |
|-------|-----------|--------|--------|
| Face: | Times | Style: | Normal |
| Size: | 14 points | Color: | Black |

Alignment

| | | | |
|---------------------|-------------|---------------------|--------------------|
| Horz. Alignment: | Justified | First Line: | Indent |
| Vert. Alignment: | Top | Relative Indent: | Off |
| Text Rotation: | None | In/Outdent Width: | 00,00 picas & pts. |
| Hyphenation: | USEENGLISH | In/Outdent Ht.: | 1 |
| Successive Hyphens: | 2 | In Fm. Rt. to Dec.: | 00,00 picas & pts. |
| Overall Width: | Column-Wide | | |

Spacing

| | | | |
|------------------|----------------------|-------------------|--------------------|
| Above: | 00.00 fractional pts | In Fm. Left (L): | 00,00 picas & pts. |
| Below: | 00.00 fractional pts | In Fm. Right (L): | 00,00 picas & pts. |
| Inter-Line: | 16.00 fractional pts | In Fm. Left (R): | 00,00 picas & pts. |
| Inter-Paragraph: | 00.00 fractional pts | In Fm. Right (R): | 00,00 picas & pts. |
| Add in Above: | When Not at C.T. | | |

Breaks

| | | | |
|---------------|--------|------------------|--------|
| Page Break: | No | Next Y Position: | Normal |
| Column Break: | No | Allow Within: | Yes |
| Line Break: | Before | Keep With Next: | No |

Address

Font

| | |
|-------|-----------|
| Size: | 10 points |
|-------|-----------|

Spacing

| | | | |
|------------------|----------------------|------------------|--------------------|
| Inter-Line: | 12.00 fractional pts | In Fm. Left (R): | 02,00 picas & pts. |
| In Fm. Left (L): | 02,00 picas & pts. | | |

Head3**Font**

| | | | |
|-------|-----------|--------|------|
| Size: | 24 points | Style: | Bold |
|-------|-----------|--------|------|

Alignment

| | |
|------------------|--------|
| Horz. Alignment: | Center |
|------------------|--------|

Spacing

| | | | |
|-------------|----------------------|---------------|--------|
| Above: | 60.00 fractional pts | Add in Above: | Always |
| Inter-Line: | 30.00 fractional pts | | |

Paragraph Typography

| | | | |
|-----------|-------------------|-----------------------------|--------------|
| Tracking: | 0.025 Ems Tighter | Vert. Just. At Top of Para: | 0.833 inches |
|-----------|-------------------|-----------------------------|--------------|

Head1**Font**

| | | | |
|-------|-----------|--------|------|
| Face: | Helvetica | Style: | Bold |
| Size: | 74 points | | |

Alignment

| | | | |
|------------------|--------|----------------|------------|
| Horz. Alignment: | Center | Overall Width: | Frame-Wide |
| Hyphenation: | Off | | |

Spacing

| | |
|-------------|----------------------|
| Inter-Line: | 74.00 fractional pts |
|-------------|----------------------|

Paragraph Typography

| | | | |
|-------------------------|-----|-----------|-------------------|
| Automatic Pair Kerning: | On | Tracking: | 0.040 Ems Tighter |
| Letter Spacing: | Off | | |

Head2**Font**

| | | | |
|-------|-----------|--------|----------|
| Face: | Helvetica | Style: | B-Italic |
| Size: | 20 points | | |

Alignment

| | | | |
|------------------|------|----------------|------------|
| Horz. Alignment: | Left | Overall Width: | Frame-Wide |
| Hyphenation: | Off | | |

Spacing

| | |
|-------------|----------------------|
| Inter-Line: | 28.00 fractional pts |
|-------------|----------------------|

Tab Settings

| | | | |
|--------------|----|-----------------|---|
| Leader Char: | 32 | Leader Spacing: | 0 |
|--------------|----|-----------------|---|

HeadRotate

| | | | |
|-----------------------------|----------------------|----------------|--------|
| Font | | | |
| Size: | 24 points | Style: | Bold |
| Alignment | | | |
| Horz. Alignment: | Center | Text Rotation: | 180 |
| Spacing | | | |
| Above: | 60.00 fractional pts | Add in Above: | Always |
| Inter-Line: | 30.00 fractional pts | | |
| Paragraph Typography | | | |
| Tracking: | 0.025 Ems Tighter | | |

BodyCenter

| | | | |
|------------------|----------------------|----------------|------------|
| Font | | | |
| Size: | 8 points | | |
| Alignment | | | |
| Horz. Alignment: | Center | Overall Width: | Frame-Wide |
| Spacing | | | |
| Above: | 08.00 fractional pts | Add in Above: | Always |
| Inter-Line: | 08.00 fractional pts | | |

Tab Settings

| | | | |
|---------------|-------------------|---------------|------------------|
| Head2 | | | |
| Tab Number 1: | Center, 17,06, 32 | Tab Number 2: | Right, 35,06, 32 |

C:\POWER\6NEWSLET.STY

Save as C:\TEMP\6NEWS.STY

Base Page Settings

Page Size & Layout

| | | | |
|--------------|----------------------|-----------|------------|
| Orientation: | Portrait | Sides: | Double |
| Paper Type: | Letter, 8.5 x 11 in. | Start On: | Right Side |

Margins & Columns

| | | | |
|------------------------|-----------------------|-------------------------|-----------------------|
| # of Columns: | 3 | Settings For Right Page | |
| Settings For Left Page | | Top: | 04,06 picas & pts. |
| Top: | 04,06 picas & pts. | Bottom: | 06,00 picas & pts. |
| Bottom: | 06,00 picas & pts. | Left: | 04,06 picas & pts. |
| Left: | 04,06 picas & pts. | Right: | 04,06 picas & pts. |
| Right: | 04,06 picas & pts. | Widths/Gutters—1: | 13,00/01,06 pcs & pts |
| Widths/Gutters—1: | 13,00/01,06 pcs & pts | Widths/Gutters—2: | 13,00/01,06 pcs & pts |
| Widths/Gutters—2: | 13,00/01,06 pcs & pts | Widths/Gutters—3: | 13,00 picas & pts. |
| Widths/Gutters—3: | 13,00 picas & pts. | | |

Tag Settings

Body Text

Font

| | | | |
|-------|-----------|--------|--------|
| Face: | Times | Style: | Normal |
| Size: | 10 points | Color: | Black |

Alignment

| | | | |
|---------------------|-------------|---------------------|--------------------|
| Horz. Alignment: | Justified | First Line: | Indent |
| Vert. Alignment: | Top | Relative Indent: | Off |
| Text Rotation: | None | In/Outdent Width: | 01,00 picas & pts. |
| Hyphenation: | USEENGLISH | In/Outdent Ht.: | 1 |
| Successive Hyphens: | 3 | In Fm. Rt. to Dec.: | 00,00 picas & pts. |
| Overall Width: | Column-Wide | | |

Spacing

| | | | |
|------------------|----------------------|-------------------|--------------------|
| Above: | 00.00 fractional pts | In Fm. Left (L): | 00,00 picas & pts. |
| Below: | 00.00 fractional pts | In Fm. Right (L): | 00,00 picas & pts. |
| Inter-Line: | 12.00 fractional pts | In Fm. Left (R): | 00,00 picas & pts. |
| Inter-Paragraph: | 00.00 fractional pts | In Fm. Right (R): | 00,00 picas & pts. |
| Add in Above: | When Not at C.T. | | |

Breaks

| | | | |
|---------------|--------|------------------|--------|
| Page Break: | No | Next Y Position: | Normal |
| Column Break: | No | Allow Within: | Yes |
| Line Break: | Before | Keep With Next: | No |

Byline**Font**

Style: N-Italic

AlignmentHorz. Alignment: Left In/Outdent Width: 00,00 picas & pts.
Hyphenation: Off**Spacing**

Above: 12.00 fractional pts

Paragraph Typography

Letter Spacing: Off

Z_FOOTER**Font**

Style: N-Italic

AlignmentHorz. Alignment: Left In/Outdent Width: 00,00 picas & pts.
Hyphenation: Off**Spacing**Above: 06.00 fractional pts Add in Above: Always
Inter-Line: 12.00 fractional pts**Ruling Line Above**Width: Frame Space Below Rule 1: 06.00 fractional pts
Color: Black Height of Rule 2: 00.00 fractional pts
Pattern: Solid Space Below Rule 2: 00.00 fractional pts
Dashes: Off Height of Rule 3: 00.00 fractional pts
Space Above Rule 1: 00.00 fractional pts Space Below Rule 3: 00.00 fractional pts
Height of Rule 1: 00.12 fractional pts**Kicker****Font**Face: Helvetica Style: N-Italic
Size: 12 points**Alignment**

Horz. Alignment: Left In/Outdent Width: 00,00 picas & pts.

Spacing

Add in Above: Always

Attribute OverridesSuperscript Size: 10 points/05.64 fractional Subscript Size: 10 points/01.32 fractional pts
Small Cap Size: 10 points

Ruling Line Below

| | | | |
|---------------------|----------------------|---------------------|----------------------|
| Width: | Text | Space Below Rule 1: | 00.00 fractional pts |
| Color: | Black | Height of Rule 2: | 00.00 fractional pts |
| Pattern: | Solid | Space Below Rule 2: | 00.00 fractional pts |
| Dashes: | Off | Height of Rule 3: | 00.00 fractional pts |
| Space Above Rule 1: | 02.00 fractional pts | Space Below Rule 3: | 00.00 fractional pts |
| Height of Rule 1: | 00.06 fractional pts | | |

Head1

| | | | |
|-----------------------------|----------------------|-------------------|--------------------|
| Font | | | |
| Size: | 36 points | Style: | Bold |
| Alignment | | | |
| Horz. Alignment: | Left | Overall Width: | Frame-Wide |
| Hyphenation: | Off | In/Outdent Width: | 00,00 picas & pts. |
| Successive Hyphens: | Off | | |
| Spacing | | | |
| Above: | 18.00 fractional pts | Add in Above: | Always |
| Inter-Line: | 36.00 fractional pts | | |
| Paragraph Typography | | | |
| Letter Spacing: | Off | Tracking: | 0.030 Ems Tighter |

Head2

| | | | |
|-----------------------------|----------------------|-------------------|----------------------|
| Font | | | |
| Size: | 24 points | Style: | Bold |
| Alignment | | | |
| Horz. Alignment: | Left | Overall Width: | Frame-Wide |
| Hyphenation: | Off | In/Outdent Width: | 00,00 picas & pts. |
| Successive Hyphens: | Off | | |
| Spacing | | | |
| Above: | 12.00 fractional pts | Inter-Line: | 24.00 fractional pts |
| Below: | 12.00 fractional pts | Add in Above: | Always |
| Breaks | | | |
| Allow Within: | No | Keep With Next: | Yes |
| Paragraph Typography | | | |
| Letter Spacing: | Off | Tracking: | 0.030 Ems Tighter |

Z_CAPTION

| | | | |
|-------------------|----------------------|---------------|--------|
| Font | | | |
| Face: | Helvetica | | |
| Alignment | | | |
| In/Outdent Width: | 00,00 picas & pts. | | |
| Spacing | | | |
| Above: | 12.00 fractional pts | Add in Above: | Always |

Z_BOXTEXT**Font**

| | | | |
|-------|-----------|--------|------|
| Face: | Helvetica | Style: | Bold |
| Size: | 8 points | | |

Alignment

| | | | |
|------------------|-------|-------------------|--------------------|
| Horz. Alignment: | Right | In/Outdent Width: | 00,00 picas & pts. |
|------------------|-------|-------------------|--------------------|

Spacing

| | | | |
|---------------|----------------------|-------------------|--------------------|
| Above: | 03.00 fractional pts | In Fm. Right (L): | 00,04 picas & pts. |
| Add in Above: | Always | In Fm. Right (R): | 00,04 picas & pts. |

StaffBox**Alignment**

| | |
|-------------------|--------------------|
| In/Outdent Width: | 00,00 picas & pts. |
|-------------------|--------------------|

Spacing

| | |
|--------|----------------------|
| Above: | 12.00 fractional pts |
|--------|----------------------|

TOCEntry**Font**

| | | | |
|-------|-----------|--------|------|
| Face: | Helvetica | Style: | Bold |
|-------|-----------|--------|------|

Alignment

| | | | |
|------------------|------|-------------------|--------------------|
| Horz. Alignment: | Left | In/Outdent Width: | 00,00 picas & pts. |
| Hyphenation: | Off | | |

Spacing

| | | | |
|-------------------|----------------------|-------------------|--------------------|
| Above: | 06.00 fractional pts | In Fm. Left (R): | 00,06 picas & pts. |
| In Fm. Left (L): | 00,06 picas & pts. | In Fm. Right (R): | 02,00 picas & pts. |
| In Fm. Right (L): | 02,00 picas & pts. | | |

Tab Settings

| | |
|--------------|----|
| Leader Char: | 46 |
|--------------|----|

BodyFirst**Alignment**

| | |
|-------------------|--------------------|
| In/Outdent Width: | 00,00 picas & pts. |
|-------------------|--------------------|

Spacing

| | | | |
|--------|----------------------|---------------|--------|
| Above: | 12.00 fractional pts | Add in Above: | Always |
|--------|----------------------|---------------|--------|

JumpLeft**Font**

| | |
|--------|----------|
| Style: | N-Italic |
|--------|----------|

Alignment

| | | | |
|---------------------|------|-------------------|--------------------|
| Horz. Alignment: | Left | In/Outdent Width: | 00,00 picas & pts. |
| Successive Hyphens: | Off | | |

JumpRight

Font

Style: N-Italic

Alignment

Horz. Alignment: Right In/Outdent Width: 00,00 picas & pts.

Successive Hyphens: Off

Spacing

Add in Above: Always In Fm. Right (R): 01,00 picas & pts.

In Fm. Right (L): 01,00 picas & pts.

CalTitle

Font

Size: 14 points

Style: Bold

Alignment

Horz. Alignment: Center In/Outdent Width: 00,00 picas & pts.

Hyphenation: Off

Spacing

Add in Above: Always

CalDays

Font

Face: Helvetica

Style: Bold

Alignment

Horz. Alignment: Center In/Outdent Width: 00,00 picas & pts.

Hyphenation: Off

Spacing

Above: 06.00 fractional pts Add in Above: Always

Deckhead

Font

Size: 12 points

Style: Bold

Alignment

Hyphenation: Off In/Outdent Width: 00,00 picas & pts.

Overall Width: Frame-Wide

Spacing

Add in Above: Always

Breaks

Allow Within: No

Ruling Line Above

| | | | |
|---------------------|----------------------|---------------------|----------------------|
| Width: | Frame | Space Below Rule 1: | 05.75 fractional pts |
| Color: | Black | Height of Rule 2: | 00.00 fractional pts |
| Pattern: | Solid | Space Below Rule 2: | 00.00 fractional pts |
| Dashes: | Off | Height of Rule 3: | 00.00 fractional pts |
| Space Above Rule 1: | 00.00 fractional pts | Space Below Rule 3: | 00.00 fractional pts |
| Height of Rule 1: | 00.25 fractional pts | | |

Ruling Line Below

| | | | |
|---------------------|----------------------|---------------------|----------------------|
| Width: | Frame | Space Below Rule 1: | 00.00 fractional pts |
| Color: | Black | Height of Rule 2: | 00.00 fractional pts |
| Pattern: | Solid | Space Below Rule 2: | 00.00 fractional pts |
| Dashes: | Off | Height of Rule 3: | 00.00 fractional pts |
| Space Above Rule 1: | 05.75 fractional pts | Space Below Rule 3: | 00.00 fractional pts |
| Height of Rule 1: | 00.25 fractional pts | | |

Head4**Font**

| | | | |
|-------|-----------|--------|------|
| Size: | 12 points | Style: | Bold |
|-------|-----------|--------|------|

Alignment

| | | | |
|------------------|------|-------------------|--------------------|
| Horz. Alignment: | Left | In/Outdent Width: | 00,00 picas & pts. |
| Hyphenation: | Off | | |

Spacing

| | |
|--------|----------------------|
| Above: | 12.00 fractional pts |
|--------|----------------------|

Breaks

| | |
|-----------------|-----|
| Keep With Next: | Yes |
|-----------------|-----|

Head3**Font**

| | | | |
|-------|-----------|--------|------|
| Size: | 24 points | Style: | Bold |
|-------|-----------|--------|------|

Alignment

| | | | |
|---------------------|------|-------------------|--------------------|
| Horz. Alignment: | Left | Overall Width: | Frame-Wide |
| Hyphenation: | Off | In/Outdent Width: | 00,00 picas & pts. |
| Successive Hyphens: | Off | | |

Spacing

| | | | |
|-------------|----------------------|------------------|--------------------|
| Above: | 12.00 fractional pts | Add in Above: | Always |
| Below: | 12.00 fractional pts | In Fm. Left (L): | 01,00 picas & pts. |
| Inter-Line: | 24.00 fractional pts | In Fm. Left (R): | 01,00 picas & pts. |

Breaks

| | | | |
|---------------|----|-----------------|-----|
| Allow Within: | No | Keep With Next: | Yes |
|---------------|----|-----------------|-----|

Paragraph Typography

| | | | |
|-----------------|-----|-----------|-------------------|
| Letter Spacing: | Off | Tracking: | 0.030 Ems Tighter |
|-----------------|-----|-----------|-------------------|

Tab Settings

TOCEntry

Tab Number 1: Left, 12,00, 46

C:\POWER\7LIST.STY**Save as C:\TEMP\7DIREC.T..STY****Base Page Settings****Page Size & Layout**

| | | | |
|--------------|----------------------|-----------|------------|
| Orientation: | Landscape | Sides: | Double |
| Paper Type: | Letter, 8.5 x 11 in. | Start On: | Right Side |

Margins & Columns

| | | | |
|------------------------|-----------------------|--------------------------------|-----------------------|
| # of Columns: | 3 | Settings For Right Page | |
| Settings For Left Page | | Top: | 06,00 picas & pts. |
| Top: | 06,00 picas & pts. | Bottom: | 06,00 picas & pts. |
| Bottom: | 06,00 picas & pts. | Left: | 08,00 picas & pts. |
| Left: | 10,00 picas & pts. | Right: | 10,00 picas & pts. |
| Right: | 08,00 picas & pts. | Widths/Gutters—1: | 14,08/02,00 pcs & pts |
| Widths/Gutters—1: | 14,08/02,00 pcs & pts | Widths/Gutters—2: | 14,08/02,00 pcs & pts |
| Widths/Gutters—2: | 14,08/02,00 pcs & pts | Widths/Gutters—3: | 14,08 picas & pts. |
| Widths/Gutters—3: | 14,08 picas & pts. | | |

Tag Settings**Body Text****Font**

| | | | |
|-------|-----------|--------|--------|
| Face: | Times | Style: | Normal |
| Size: | 10 points | Color: | Black |

Alignment

| | | | |
|---------------------|-------------|---------------------|--------------------|
| Horz. Alignment: | Justified | First Line: | Indent |
| Vert. Alignment: | Top | Relative Indent: | Off |
| Text Rotation: | None | In/Outdent Width: | 00,00 picas & pts. |
| Hyphenation: | USEENGLSH | In/Outdent Ht.: | 1 |
| Successive Hyphens: | 2 | In Fm. Rt. to Dec.: | 00,00 picas & pts. |
| Overall Width: | Column-Wide | | |

Spacing

| | | | |
|-------------|----------------------|------------------|----------------------|
| Above: | 00.00 fractional pts | Inter-Paragraph: | 00.00 fractional pts |
| Below: | 00.00 fractional pts | Add in Above: | When Not at C.T. |
| Inter-Line: | 12.00 fractional pts | | |

Breaks

| | | | |
|---------------|--------|------------------|--------|
| Page Break: | No | Next Y Position: | Normal |
| Column Break: | No | Allow Within: | Yes |
| Line Break: | Before | Keep With Next: | No |

Z_FOOTER**Font**

| | | | |
|-------|-----------|-------|----------|
| Face: | Helvetica | Size: | 8 points |
|-------|-----------|-------|----------|

Alignment

| | | | |
|------------------|------|--------------|-----|
| Horz. Alignment: | Left | Hyphenation: | Off |
|------------------|------|--------------|-----|

Spacing

| | | | |
|-------------|----------------------|---------------|--------|
| Inter-Line: | 09.60 fractional pts | Add in Above: | Always |
|-------------|----------------------|---------------|--------|

Ruling Line Above

| | | | |
|---------------------|----------------------|---------------------|----------------------|
| Width: | Margin | Space Below Rule 1: | 02.00 fractional pts |
| Color: | Black | Height of Rule 2: | 00.00 fractional pts |
| Pattern: | Solid | Space Below Rule 2: | 00.00 fractional pts |
| Dashes: | Off | Height of Rule 3: | 00.00 fractional pts |
| Space Above Rule 1: | 00.00 fractional pts | Space Below Rule 3: | 00.00 fractional pts |
| Height of Rule 1: | 00.50 fractional pts | | |

Phone**Spacing**

| | |
|---------------|--------|
| Add in Above: | Always |
|---------------|--------|

Head1**Alignment**

| | |
|--------------|-----|
| Hyphenation: | Off |
|--------------|-----|

Head2**Alignment**

| | |
|--------------|-----|
| Hyphenation: | Off |
|--------------|-----|

Breaks

| | |
|---------------|----|
| Allow Within: | No |
|---------------|----|

Company**Spacing**

| | |
|---------------|--------|
| Add in Above: | Always |
|---------------|--------|

Breaks

| | |
|-----------------|-----|
| Keep With Next: | Yes |
|-----------------|-----|

Head3**Spacing**

| | |
|---------------|--------|
| Add in Above: | Always |
|---------------|--------|

Head4**Font**

| | | | |
|-------|-----------|--------|------|
| Size: | 11 points | Style: | Bold |
|-------|-----------|--------|------|

Alignment

| | | | |
|------------------|---------|-------------------|--------------------|
| Horz. Alignment: | Left | In/Outdent Width: | 01,00 picas & pts. |
| First Line: | Outdent | | |

Spacing

Above: 12.00 fractional pts

Breaks

Keep With Next: Yes

Special Effects

| | | | |
|----------------------|--------------------|--------|-----------|
| Special Effect: | Bullet | Face: | Times |
| Bullet Char: | 175 | Size: | 11 points |
| Indent After Bullet: | 01,00 picas & pts. | Color: | Black |

HeadSection**Alignment**

| | | | |
|--------------|-----|----------------|------------|
| Hyphenation: | Off | Overall Width: | Frame-Wide |
|--------------|-----|----------------|------------|

Paragraph Typography

Tracking: 0.020 Ems Tighter

ItalSeparate**Spacing**

Add in Above: Always

ThumbTab**Font**

| | | | |
|-------|-----------|--------|-------|
| Face: | Helvetica | Style: | Bold |
| Size: | 14 points | Color: | White |

Alignment

| | | | |
|------------------|--------|--------------|-----|
| Horz. Alignment: | Center | Hyphenation: | Off |
|------------------|--------|--------------|-----|

Spacing

Add in Above: Always

Breaks

Keep With Next: Yes

C:\POWER\8DESIGN.STY

Save as C:\TEMP\8BOOK.STY

Base Page Settings

Page Size & Layout

| | | | |
|--------------|---------------------|-----------|------------|
| Orientation: | Portrait | Sides: | Double |
| Paper Type: | Half, 5.5 x 8.5 in. | Start On: | Right Side |

Margins & Columns

| | | | |
|------------------------|--------------------|-------------------------|--------------------|
| # of Columns: | 1 | Settings For Right Page | |
| Settings For Left Page | | Top: | 06,00 picas & pts. |
| Top: | 06,00 picas & pts. | Bottom: | 06,00 picas & pts. |
| Bottom: | 06,00 picas & pts. | Left: | 06,00 picas & pts. |
| Left: | 04,06 picas & pts. | Right: | 04,06 picas & pts. |
| Right: | 06,00 picas & pts. | Widths/Gutters—1: | 22,06 picas & pts. |
| Widths/Gutters—1: | 22,06 picas & pts. | | |

Tag Settings

Body Text

| | | | |
|---------------------|----------------------|---------------------|----------------------|
| Font | | | |
| Face: | Times | Style: | Normal |
| Size: | 12 points | Color: | Black |
| Alignment | | | |
| Horz. Alignment: | Justified | First Line: | Indent |
| Vert. Alignment: | Top | Relative Indent: | Off |
| Text Rotation: | None | In/Outdent Width: | 1,00 picas & pts. |
| Hyphenation: | USEENGLISH | In/Outdent Ht.: | 1 |
| Successive Hyphens: | 3 | In Fm. Rt. to Dec.: | 00,00 picas & pts. |
| Overall Width: | Column-Wide | | |
| Spacing | | | |
| Above: | 00.00 fractional pts | Inter-Paragraph: | 00.00 fractional pts |
| Below: | 00.00 fractional pts | Add in Above: | Always |
| Inter-Line: | 14.00 fractional pts | | |
| Breaks | | | |
| Page Break: | No | Next Y Position: | Normal |
| Column Break: | No | Allow Within: | Yes |
| Line Break: | Before | Keep With Next: | No |

Head1

| | | | |
|-------------|-----------|--------|------|
| Font | | | |
| Size: | 18 points | Style: | Bold |

Alignment

| | | | |
|------------------|--------|-------------------|--------------------|
| Horz. Alignment: | Center | In/Outdent Width: | 00,00 picas & pts. |
| Hyphenation: | Off | | |

Spacing

| | | | |
|--------|----------------------|---------------|----------------------|
| Above: | 42.00 fractional pts | Inter-Line: | 18.00 fractional pts |
| Below: | 18.00 fractional pts | Add in Above: | When Not at C.T. |

Breaks

| | | | |
|---------------|----|-----------------|-----|
| Allow Within: | No | Keep With Next: | Yes |
|---------------|----|-----------------|-----|

Head2**Font**

| | | | |
|-------|-----------|--------|----------|
| Size: | 14 points | Style: | B-Italic |
|-------|-----------|--------|----------|

Alignment

| | | | |
|------------------|------|-------------------|--------------------|
| Horz. Alignment: | Left | In/Outdent Width: | 00,00 picas & pts. |
| Hyphenation: | Off | | |

Spacing

| | | | |
|--------|----------------------|---------------|------------------|
| Above: | 21.00 fractional pts | Add in Above: | When Not at C.T. |
| Below: | 07.00 fractional pts | | |

Breaks

| | | | |
|---------------|----|-----------------|-----|
| Allow Within: | No | Keep With Next: | Yes |
|---------------|----|-----------------|-----|

Bullet**Spacing**

| | | | |
|--------|----------------------|--------|----------------------|
| Above: | 07.00 fractional pts | Below: | 07.00 fractional pts |
|--------|----------------------|--------|----------------------|

Breaks

| | |
|-------------|----------------|
| Line Break: | Before & After |
|-------------|----------------|

Special Effects

| | | | |
|----------------------|--------------------|--------|-----------|
| Special Effect: | Bullet | Face: | Times |
| Bullet Char: | 195 | Size: | 12 points |
| Indent After Bullet: | 01,06 picas & pts. | Color: | Black |

Z_HEADER**Alignment**

| | | | |
|------------------|------|-------------------|--------------------|
| Horz. Alignment: | Left | In/Outdent Width: | 00,00 picas & pts. |
| Hyphenation: | Off | | |

BodyBreak**Alignment**

| | |
|-------------------|--------------------|
| In/Outdent Width: | 00,00 picas & pts. |
|-------------------|--------------------|

Breaks

| | |
|-------------|-------|
| Page Break: | After |
|-------------|-------|

BodyFirst**Alignment**

In/Outdent Width: 00,00 picas & pts.

Spacing

Above: 42.00 fractional pts

Chap#**Font**

Size: 14 points Style: B-Italic

AlignmentHorz. Alignment: Center Overall Width: Frame-Wide
Hyphenation: Off In/Outdent Width: 00,00 picas & pts.**Breaks**Page Break: Before/Until Right Keep With Next: Yes
Allow Within: No**Ruling Line Below**Width: Custom Height of Rule 2: 00.00 fractional pts
Color: Black Space Below Rule 2: 00.00 fractional pts
Pattern: Solid Height of Rule 3: 00.00 fractional pts
Dashes: Off Space Below Rule 3: 00.00 fractional pts
Space Above Rule 1: 00.00 fractional pts Custom Indent: 05,00 picas & pts.
Height of Rule 1: 01.02 fractional pts Custom Width: 12,00 picas & pts.
Space Below Rule 1: 00.00 fractional pts**ChapTitle****Font**

Size: 30 points Style: Bold

AlignmentHorz. Alignment: Center In/Outdent Width: 00,00 picas & pts.
Hyphenation: Off**Spacing**

Above: 98.00 fractional pts Inter-Line: 36.00 fractional pts

Breaks

Allow Within: No Keep With Next: Yes

Paragraph Typography

Tracking: 0.050 Ems Tighter

C:\POWER\8PRINT.STY

Save as C:\TEMP\8PRINT.STY

Base Page Settings

Page Size & Layout

| | | | |
|--------------|---------------------|-----------|------------|
| Orientation: | Portrait | Sides: | Double |
| Paper Type: | Half, 5.5 x 8.5 in. | Start On: | Right Side |

Auto-Numbering

Margins & Columns

| | | | |
|------------------------|--------------------|-------------------------|--------------------|
| # of Columns: | 1 | Settings For Right Page | |
| Settings For Left Page | | Top: | 06,00 picas & pts. |
| Top: | 06,00 picas & pts. | Bottom: | 06,00 picas & pts. |
| Bottom: | 06,00 picas & pts. | Left: | 06,00 picas & pts. |
| Left: | 04,06 picas & pts. | Right: | 04,06 picas & pts. |
| Right: | 06,00 picas & pts. | Widths/Gutters—1: | 22,06 picas & pts. |
| Widths/Gutters—1: | 22,06 picas & pts. | | |

Tag Settings

Body Text

Font

| | | | |
|-------|-----------|--------|--------|
| Face: | Times | Style: | Normal |
| Size: | 12 points | Color: | Black |

Alignment

| | | | |
|---------------------|-------------|---------------------|--------------------|
| Horz. Alignment: | Justified | First Line: | Indent |
| Vert. Alignment: | Top | Relative Indent: | Off |
| Text Rotation: | None | In/Outdent Width: | 01,00 picas & pts. |
| Hyphenation: | USEENGLSH | In/Outdent Ht.: | 1 |
| Successive Hyphens: | 3 | In Fm. Rt. to Dec.: | 00,00 picas & pts. |
| Overall Width: | Column-Wide | | |

Spacing

| | | | |
|-------------|----------------------|------------------|----------------------|
| Above: | 00.00 fractional pts | Inter-Paragraph: | 00.00 fractional pts |
| Below: | 00.00 fractional pts | Add in Above: | Always |
| Inter-Line: | 14.00 fractional pts | | |

Breaks

| | | | |
|---------------|--------|------------------|--------|
| Page Break: | No | Next Y Position: | Normal |
| Column Break: | No | Allow Within: | Yes |
| Line Break: | Before | Keep With Next: | No |

Head1

Font

| | | | |
|-------|-----------|--------|------|
| Size: | 18 points | Style: | Bold |
|-------|-----------|--------|------|

Alignment

| | | | |
|------------------|--------|-------------------|--------------------|
| Horz. Alignment: | Center | In/Outdent Width: | 00,00 picas & pts. |
| Hyphenation: | Off | | |

Spacing

| | | | |
|--------|----------------------|---------------|----------------------|
| Above: | 42.00 fractional pts | Inter-Line: | 18.00 fractional pts |
| Below: | 18.00 fractional pts | Add in Above: | When Not at C.T. |

Breaks

| | | | |
|---------------|----|-----------------|-----|
| Allow Within: | No | Keep With Next: | Yes |
|---------------|----|-----------------|-----|

Head2**Font**

| | | | |
|-------|-----------|--------|----------|
| Size: | 14 points | Style: | B-Italic |
|-------|-----------|--------|----------|

Alignment

| | | | |
|------------------|------|-------------------|--------------------|
| Horz. Alignment: | Left | In/Outdent Width: | 00,00 picas & pts. |
| Hyphenation: | Off | | |

Spacing

| | | | |
|--------|----------------------|---------------|------------------|
| Above: | 21.00 fractional pts | Add in Above: | When Not at C.T. |
| Below: | 07.00 fractional pts | | |

Breaks

| | | | |
|---------------|----|-----------------|-----|
| Allow Within: | No | Keep With Next: | Yes |
|---------------|----|-----------------|-----|

Bullet**Spacing**

| | | | |
|--------|----------------------|-------------|----------------------|
| Above: | 07.00 fractional pts | Inter-Line: | 14.00 fractional pts |
| Below: | 07.00 fractional pts | | |

Breaks

| | |
|-------------|----------------|
| Line Break: | Before & After |
|-------------|----------------|

Special Effects

| | | | |
|----------------------|--------------------|--------|-----------|
| Special Effect: | Bullet | Face: | Times |
| Bullet Char: | 195 | Size: | 12 points |
| Indent After Bullet: | 01,06 picas & pts. | Color: | Black |

Z_HEADER**Alignment**

| | | | |
|------------------|------|-------------------|--------------------|
| Horz. Alignment: | Left | In/Outdent Width: | 00,00 picas & pts. |
| Hyphenation: | Off | | |

BodyBreak**Font**

| | |
|-------|-----------|
| Size: | 10 points |
|-------|-----------|

Alignment

| | |
|-------------------|--------------------|
| In/Outdent Width: | 00,00 picas & pts. |
|-------------------|--------------------|

Spacing

Inter-Line: 12.00 fractional pts

Breaks

Page Break: After

BodyFirst**Alignment**

In/Outdent Width: 00,00 picas & pts.

Spacing

Above: 42.00 fractional pts

Special Effects

| | | | |
|----------------------|----------------|--------|---------------------------|
| Special Effect: | Big First Char | Size: | 30 points |
| Space for Big First: | 2 lines | Color: | Black |
| Face: | Times | Shift: | Down 01.00 fractional pts |

Chap#**Font**

| | | | |
|-------|-----------|--------|----------|
| Size: | 14 points | Style: | B-Italic |
|-------|-----------|--------|----------|

Alignment

| | | | |
|------------------|--------|-------------------|--------------------|
| Horz. Alignment: | Center | Overall Width: | Frame-Wide |
| Hyphenation: | Off | In/Outdent Width: | 00,00 picas & pts. |

Breaks

| | | | |
|---------------|--------------------|-----------------|-----|
| Page Break: | Before/Until Right | Keep With Next: | Yes |
| Allow Within: | No | | |

Ruling Line Below

| | | | |
|---------------------|----------------------|---------------------|----------------------|
| Width: | Custom | Height of Rule 2: | 00.00 fractional pts |
| Color: | Black | Space Below Rule 2: | 00.00 fractional pts |
| Pattern: | Solid | Height of Rule 3: | 00.00 fractional pts |
| Dashes: | Off | Space Below Rule 3: | 00.00 fractional pts |
| Space Above Rule 1: | 00.00 fractional pts | Custom Indent: | 05,00 picas & pts. |
| Height of Rule 1: | 01.02 fractional pts | Custom Width: | 12,00 picas & pts. |
| Space Below Rule 1: | 00.00 fractional pts | | |

ChapTitle**Font**

| | | | |
|-------|-----------|--------|------|
| Size: | 30 points | Style: | Bold |
|-------|-----------|--------|------|

Alignment

| | | | |
|------------------|--------|-------------------|--------------------|
| Horz. Alignment: | Center | In/Outdent Width: | 00,00 picas & pts. |
| Hyphenation: | Off | | |

Spacing

| | | | |
|--------|----------------------|-------------|----------------------|
| Above: | 98.00 fractional pts | Inter-Line: | 36.00 fractional pts |
|--------|----------------------|-------------|----------------------|

Breaks

| | | | |
|---------------|----|-----------------|-----|
| Allow Within: | No | Keep With Next: | Yes |
|---------------|----|-----------------|-----|

C:\POWER\9TECH.STY**Save as C:\TEMP\9TECHDOC.STY****Base Page Settings****Page Size & Layout**

| | | | |
|--------------|----------------------|-----------|------------|
| Orientation: | Landscape | Sides: | Double |
| Paper Type: | Letter, 8.5 x 11 in. | Start On: | Right Side |

Margins & Columns

| | | | |
|------------------------|-----------------------|-------------------------|-----------------------|
| # of Columns: | 3 | Settings For Right Page | |
| Settings For Left Page | | Top: | 11,00 picas & pts. |
| Top: | 11,00 picas & pts. | Bottom: | 13,00 picas & pts. |
| Bottom: | 13,00 picas & pts. | Left: | 10,06 picas & pts. |
| Left: | 09,06 picas & pts. | Right: | 09,06 picas & pts. |
| Right: | 10,06 picas & pts. | Widths/Gutters—1: | 14,00/02,00 pcs & pts |
| Widths/Gutters—1: | 14,00/02,00 pcs & pts | Widths/Gutters—2: | 14,00/02,00 pcs & pts |
| Widths/Gutters—2: | 14,00/02,00 pcs & pts | Widths/Gutters—3: | 14,00 picas & pts. |
| Widths/Gutters—3: | 14,00 picas & pts. | | |

Tag Settings**Body Text****Font**

| | | | |
|-------|-----------|--------|--------|
| Face: | Times | Style: | Normal |
| Size: | 10 points | Color: | Black |

Alignment

| | | | |
|---------------------|-------------|---------------------|--------------------|
| Horz. Alignment: | Left | First Line: | Indent |
| Vert. Alignment: | Top | Relative Indent: | Off |
| Text Rotation: | None | In/Outdent Width: | 00,00 picas & pts. |
| Hyphenation: | USEENGLSH | In/Outdent Ht.: | 1 |
| Successive Hyphens: | 2 | In Fm. Rt. to Dec.: | 00,00 picas & pts. |
| Overall Width: | Column-Wide | | |

Spacing

| | | | |
|-------------|----------------------|------------------|----------------------|
| Above: | 12.00 fractional pts | Inter-Paragraph: | 00.00 fractional pts |
| Below: | 00.00 fractional pts | Add in Above: | When Not at C.T. |
| Inter-Line: | 12.00 fractional pts | | |

Breaks

| | | | |
|---------------|--------|------------------|--------|
| Page Break: | No | Next Y Position: | Normal |
| Column Break: | No | Allow Within: | Yes |
| Line Break: | Before | Keep With Next: | No |

Z_LABEL FIG**Font**

| | | | |
|-------|-----------|--------|----------|
| Size: | 12 points | Style: | B-Italic |
|-------|-----------|--------|----------|

Alignment

| | |
|------------------|-----------|
| Horz. Alignment: | Justified |
|------------------|-----------|

Spacing

| | | | |
|--------|----------------------|---------------|--------|
| Above: | 06.00 fractional pts | Add in Above: | Always |
|--------|----------------------|---------------|--------|

Z_LABEL CAP**Alignment**

| | | | |
|------------------|--------|--------------|-----|
| Horz. Alignment: | Center | Hyphenation: | Off |
|------------------|--------|--------------|-----|

Spacing

| | |
|--------|----------------------|
| Above: | 00.00 fractional pts |
|--------|----------------------|

Z_FOOTER**Font**

| | |
|--------|----------|
| Style: | N-Italic |
|--------|----------|

Alignment

| | |
|--------------|-----|
| Hyphenation: | Off |
|--------------|-----|

Spacing

| | | | |
|--------|----------------------|---------------|--------|
| Above: | 00.00 fractional pts | Add in Above: | Always |
|--------|----------------------|---------------|--------|

Title**Font**

| | | | |
|-------|-----------|--------|------|
| Size: | 60 points | Style: | Bold |
|-------|-----------|--------|------|

Alignment

| | | | |
|------------------|--------|----------------|------------|
| Horz. Alignment: | Center | Overall Width: | Frame-Wide |
| Hyphenation: | Off | | |

Spacing

| | | | |
|--------|----------------------|---------------|----------------------|
| Above: | 48.00 fractional pts | Inter-Line: | 60.00 fractional pts |
| Below: | 48.00 fractional pts | Add in Above: | Always |

Head1**Font**

| | | | |
|-------|-----------|--------|------|
| Size: | 24 points | Style: | Bold |
|-------|-----------|--------|------|

Alignment

| | |
|--------------|-----|
| Hyphenation: | Off |
|--------------|-----|

Spacing

| | | | |
|--------|----------------------|-------------|----------------------|
| Above: | 24.00 fractional pts | Inter-Line: | 24.00 fractional pts |
| Below: | 12.00 fractional pts | | |

Head2**Font**

| | | | |
|-------|-----------|--------|----------|
| Size: | 18 points | Style: | B-Italic |
|-------|-----------|--------|----------|

Alignment

Hyphenation: Off

Spacing

Above: 24.00 fractional pts Inter-Line: 18.00 fractional pts

Breaks

Keep With Next: Yes

Head3**Font**Face: Helvetica Style: Bold
Size: 12 points**Head5****Font**

Size: 12 points Style: Bold

Spacing

Add in Above: Always

Breaks

Keep With Next: Yes

Z_CAPTION**Font**

Style: N-Italic

Alignment

Relative Indent: On In/Outdent Width: 00,04 picas & pts.

Spacing

Above: 00.00 fractional pts

Breaks

Line Break: After

Z_SEC2**Font**

Style: Bold

Spacing

Add in Above: Always

Breaks

Keep With Next: Yes

BodyBreak**Alignment**

Horz. Alignment: Justified

Spacing

| | | | |
|--------|----------------------|-------------|----------------------|
| Above: | 00.00 fractional pts | Inter-Line: | 02.00 fractional pts |
|--------|----------------------|-------------|----------------------|

Breaks

| | |
|-------------|-------|
| Page Break: | After |
|-------------|-------|

BodySmall**Font**

| | | | |
|-------|-----------|-------|----------|
| Face: | Helvetica | Size: | 8 points |
|-------|-----------|-------|----------|

Spacing

| | | | |
|--------|----------------------|-------------|----------------------|
| Below: | 12.00 fractional pts | Inter-Line: | 10.00 fractional pts |
|--------|----------------------|-------------|----------------------|

ListBullet**Spacing**

| | |
|--------|----------------------|
| Above: | 00.00 fractional pts |
|--------|----------------------|

Special Effects

| | | | |
|----------------------|--------------------|--------|-----------|
| Special Effect: | Bullet | Face: | Times |
| Bullet Char: | 195 | Size: | 12 points |
| Indent After Bullet: | 01,00 picas & pts. | Color: | Black |

TitleSub**Font**

| | | | |
|-------|-----------|--------|----------|
| Face: | Helvetica | Style: | B-Italic |
| Size: | 24 points | | |

Alignment

| | | | |
|------------------|--------|----------------|------------|
| Horz. Alignment: | Center | Overall Width: | Frame-Wide |
| Hyphenation: | Off | | |

Spacing

| | | | |
|--------|----------------------|-------------|----------------------|
| Above: | 24.00 fractional pts | Inter-Line: | 24.00 fractional pts |
|--------|----------------------|-------------|----------------------|

C:\POWER\PROFEXT.STY**Save as C:\TEMP\PROFEXT.STY****Base Page Settings****Page Size & Layout**

| | | | |
|--------------|----------------------|-----------|------------|
| Orientation: | Landscape | Sides: | Double |
| Paper Type: | Letter, 8.5 x 11 in. | Start On: | Right Side |

Auto-Numbering

| | | | |
|----------|--------------|----------|-------------|
| Level 1: | [*Body Text] | Level 2: | [*List#,1]. |
|----------|--------------|----------|-------------|

Margins & Columns

| | | | |
|-------------------------------|--------------------------|--------------------------------|--------------------------|
| # of Columns: | 3 | Settings For Right Page | |
| Settings For Left Page | | Top: | 11,00 picas & pts. |
| Top: | 11,00 picas & pts. | Bottom: | 13,00 picas & pts. |
| Bottom: | 13,00 picas & pts. | Left: | 10,06 picas & pts. |
| Left: | 09,06 picas & pts. | Right: | 09,06 picas & pts. |
| Right: | 10,06 picas & pts. | Widths/Gutters—1: | 14,00/02,00 picas & pts. |
| Widths/Gutters—1: | 14,00/02,00 picas & pts. | Widths/Gutters—2: | 14,00/02,00 picas & pts. |
| Widths/Gutters—2: | 14,00/02,00 picas & pts. | Widths/Gutters—3: | 14,00 picas & pts. |
| Widths/Gutters—3: | 14,00 picas & pts. | | |

Color Settings

| | | | |
|-------------------------|------------------------------|-------------------------|------------------------------|
| Screen Display: | Shades of Gray | Color Number 1 (Black): | (100.0, 100.0, 100.0, 000.0) |
| Color Number 0 (White): | (000.0, 000.0, 000.0, 000.0) | Color Number 2 (Red): | (000.0, 100.0, 100.0, 000.0) |

Tag Settings**Body Text****Font**

| | | | |
|-------|-----------|--------|--------|
| Face: | Times | Style: | Normal |
| Size: | 10 points | Color: | Black |

Alignment

| | | | |
|---------------------|-------------|---------------------|--------------------|
| Horz. Alignment: | Left | First Line: | Indent |
| Vert. Alignment: | Top | Relative Indent: | Off |
| Text Rotation: | None | In/Outdent Width: | 00,00 picas & pts. |
| Hyphenation: | USEENGLSH | In/Outdent Ht.: | 1 |
| Successive Hyphens: | 2 | In Fm. Rt. to Dec.: | 00,00 picas & pts. |
| Overall Width: | Column-Wide | | |

Spacing

| | | | |
|-------------|----------------------|------------------|----------------------|
| Above: | 12.00 fractional pts | Inter-Paragraph: | 00.00 fractional pts |
| Below: | 00.00 fractional pts | Add in Above: | When Not at C.T. |
| Inter-Line: | 12.00 fractional pts | | |

Breaks

| | | | |
|---------------|--------|------------------|--------|
| Page Break: | No | Next Y Position: | Normal |
| Column Break: | No | Allow Within: | Yes |
| Line Break: | Before | Keep With Next: | No |

Z_LABEL FIG**Font**

| | | | |
|-------|-----------|--------|----------|
| Size: | 12 points | Style: | B-Italic |
|-------|-----------|--------|----------|

Alignment

| | |
|------------------|-----------|
| Horz. Alignment: | Justified |
|------------------|-----------|

Spacing

| | | | |
|--------|----------------------|---------------|--------|
| Above: | 06.00 fractional pts | Add in Above: | Always |
|--------|----------------------|---------------|--------|

Z_LABEL CAP**Alignment**

| | | | |
|------------------|--------|--------------|-----|
| Horz. Alignment: | Center | Hyphenation: | Off |
|------------------|--------|--------------|-----|

Spacing

| | |
|--------|----------------------|
| Above: | 00.00 fractional pts |
|--------|----------------------|

Z_FOOTER**Font**

| | |
|--------|----------|
| Style: | N-Italic |
|--------|----------|

Alignment

| | |
|--------------|-----|
| Hyphenation: | Off |
|--------------|-----|

Spacing

| | | | |
|--------|----------------------|---------------|--------|
| Above: | 00.00 fractional pts | Add in Above: | Always |
|--------|----------------------|---------------|--------|

Title**Font**

| | | | |
|-------|-----------|--------|------|
| Size: | 60 points | Style: | Bold |
|-------|-----------|--------|------|

Alignment

| | | | |
|------------------|--------|----------------|------------|
| Horz. Alignment: | Center | Overall Width: | Frame-Wide |
| Hyphenation: | Off | | |

Spacing

| | | | |
|--------|----------------------|---------------|----------------------|
| Above: | 48.00 fractional pts | Inter-Line: | 60.00 fractional pts |
| Below: | 48.00 fractional pts | Add in Above: | Always |

Head1**Font**

| | | | |
|-------|-----------|--------|------|
| Size: | 24 points | Style: | Bold |
|-------|-----------|--------|------|

Alignment

| | |
|--------------|-----|
| Hyphenation: | Off |
|--------------|-----|

Spacing

| | | | |
|--------|----------------------|-------------|----------------------|
| Above: | 24.00 fractional pts | Inter-Line: | 24.00 fractional pts |
| Below: | 12.00 fractional pts | | |

Breaks

| | |
|---------------|----------------|
| Column Break: | Before & After |
|---------------|----------------|

Head2**Font**

| | | | |
|-------|-----------|--------|----------|
| Size: | 18 points | Style: | B-Italic |
|-------|-----------|--------|----------|

Alignment

| | |
|--------------|-----|
| Hyphenation: | Off |
|--------------|-----|

Spacing

| | | | |
|--------|----------------------|-------------|----------------------|
| Above: | 24.00 fractional pts | Inter-Line: | 18.00 fractional pts |
|--------|----------------------|-------------|----------------------|

Breaks

| | |
|-----------------|-----|
| Keep With Next: | Yes |
|-----------------|-----|

Head3**Font**

| | | | |
|-------|-----------|--------|------|
| Face: | Helvetica | Style: | Bold |
| Size: | 12 points | | |

Head5**Font**

| | | | |
|-------|-----------|--------|------|
| Size: | 12 points | Style: | Bold |
|-------|-----------|--------|------|

Spacing

| | |
|---------------|--------|
| Add in Above: | Always |
|---------------|--------|

Breaks

| | |
|-----------------|-----|
| Keep With Next: | Yes |
|-----------------|-----|

Z_CAPTION**Font**

| | |
|--------|----------|
| Style: | N-Italic |
|--------|----------|

Alignment

| | | | |
|------------------|----|-------------------|--------------------|
| Relative Indent: | On | In/Outdent Width: | 00,04 picas & pts. |
|------------------|----|-------------------|--------------------|

Spacing

| | |
|--------|----------------------|
| Above: | 00.00 fractional pts |
|--------|----------------------|

Breaks

| | |
|-------------|-------|
| Line Break: | After |
|-------------|-------|

Z_SEC2**Font**

Style: Bold

Spacing
Add in Above: Always

Breaks
Keep With Next: Yes

BodyBreak

Alignment
Horz. Alignment: Justified

Spacing
Above: 00.00 fractional pts Inter-Line: 02.00 fractional pts

Breaks
Page Break: After

BodySmall

Font
Face: Helvetica Size: 8 points

Spacing
Below: 12.00 fractional pts Inter-Line: 10.00 fractional pts

ListBullet

Spacing
Above: 00.00 fractional pts

Special Effects
Special Effect: Bullet Face: Times
Bullet Char: 195 Size: 12 points
Indent After Bullet: 01,00 picas & pts. Color: Black

TitleSub

Font
Face: Helvetica Style: B-Italic
Size: 24 points

Alignment
Horz. Alignment: Center Overall Width: Frame-Wide
Hyphenation: Off

Spacing
Above: 24.00 fractional pts Inter-Line: 24.00 fractional pts

List#

Spacing
In Fm. Left (L): 01,00 picas & pts. In Fm. Left (R): 01,00 picas & pts.

Breaks

Line Break: After

Z_SEC1**Font**

Style: Bold

Breaks

Keep With Next: Yes

Head4**Font**

Size: 14 points

Color: Red

Style: Bold

Alignment

Overall Width: Frame-Wide

Spacing

Above: 00.00 fractional pts

Inter-Line: 18.00 fractional pts

Breaks

Page Break: Before

Rule**Font**

Size: 12 points

Style: Bold

Alignment

Overall Width: Frame-Wide

In/Outdent Width: 00,04 picas & pts.

Relative Indent: On

Spacing

Add in Above: Always

Breaks

Line Break: After

Keep With Next: Yes

Ruling Line Above

Width: Text

Space Below Rule 1: 02.00 fractional pts

Color: Black

Height of Rule 2: 00.50 fractional pts

Pattern: Solid

Space Below Rule 2: 00.00 fractional pts

Dashes: Off

Height of Rule 3: 00.00 fractional pts

Space Above Rule 1: 00.00 fractional pts

Space Below Rule 3: 09.00 fractional pts

Height of Rule 1: 02.00 fractional pts

Note**Spacing**

In Fm. Left (L): 01,00 picas & pts.

In Fm. Left (R): 01,00 picas & pts.

In Fm. Right (L): 01,00 picas & pts.

In Fm. Right (R): 01,00 picas & pts.

Ruling Box Around

| | | | |
|---------------------|----------------------|---------------------|----------------------|
| Width: | Column | Space Below Rule 1: | 03.00 fractional pts |
| Color: | Red | Height of Rule 2: | 00.00 fractional pts |
| Pattern: | Solid | Space Below Rule 2: | 00.00 fractional pts |
| Dashes: | Off | Height of Rule 3: | 00.00 fractional pts |
| Space Above Rule 1: | 00.00 fractional pts | Space Below Rule 3: | 00.00 fractional pts |
| Height of Rule 1: | 00.06 fractional pts | | |

Spacer**Spacing**

Add in Above: Always

Z_BOXTEXT**Alignment**

Hyphenation: Off

Tab Settings**Rule**

Tab Number 1: Right, 46,00, 32

The Power Disk

The Power disk contains text files, style sheets, and chapter files for use with the sample projects in *Publishing Power With Ventura*. You may obtain as many original copies of the Power disk as you need by using the order form at the back of this book, or by phoning the number shown on the form.

The Power disk requires Xerox Ventura Publisher Version 2.0 or 2.0 Professional Extension, and PC-DOS/MS-DOS 2.0 or higher.

Benefits of the disk

The Power disk saves time. It allows you to get right to the heart of the sample projects by using prepared text files, style sheets, and chapter files. It contains many pages of text that you would otherwise need to type on your own. In addition, it includes style sheets with predefined tags, margins, columns, and other basics. Because the style sheets are partially encoded, you can focus on the specific topics at hand, without the need to recreate basic parameters before you can start.

Disclaimer

The Power disk is subject to change at any time without notice. It is provided on an as-is basis, as a convenience. New Riders Publishing is not liable or responsible to any person or entity with respect to any loss or damage in connection with or arising from the use of the disk.

Installing the disk

Before starting, make a copy of the disk using the DOS utility DISKCOPY. (DISKCOPY will duplicate the subdirectories and the files. If you prefer to use the COPY command, you must create the subdirectories on your own and copy the correct files to the correct subdirectories.) Store the original in a safe place and use the copy as the working disk.

The Power disk is copyrighted. It is intended for your personal use. It may not be sold or transferred for profit.

After making a copy, you are ready to install the files onto the hard disk. You should begin by scanning the README.1ST file on the disk for possible changes or corrections:

- Turn on your system.
- When you see the DOS prompt, put the working Power disk in drive A:

- Change to the A: drive by typing:

```
A: [Enter]
```

- To view the README.1ST file, type:

```
HELP [Enter]
```

- Alternatively, you can type:

```
TYPE README.1ST [Enter]
```

- To stop the screen from scrolling, type Ctrl-S. Type Ctrl-S again to resume scrolling.

- To produce a printout of the file, turn on your printer and type:

```
COPY README.1ST PRN [Enter]
```

Installing on hard disk C:

You may install the Power disk with a simple DOS COPY procedure provided (1) that your hard disk is designated as C: and (2) that you are able to set up a separate C:\POWER subdirectory.

If you do not meet *both* conditions, you must perform the

additional procedure below titled "If your hard disk is designated other than C:."

WARNING: If you use DOS COPY to move the files from the Power disk to any place other than C:\POWER without following the additional procedures explained below, the sample chapters may not work properly.

To install the Power disk, you will perform two steps:

1. create a C:\POWER subdirectory and
2. copy the files from the floppy to the C:\POWER subdirectory.

Here are the steps to take:

- Move to the C: disk by typing:

```
C: [Enter]
```

- At the C: prompt, type:

```
MD \POWER  
CD \POWER
```

- Put the working Power disk in drive A: and type:

```
COPY A:*.*
```

The installation is complete. Remove the working Power disk from the A: drive and store it in a safe place. You may proceed to Chapter One and begin work.

If your hard disk is designated other than C:

If your hard disk is named other than C:, you must perform an additional Multi-Chapter function before you can begin work with the Power disk.

For instance, your hard disk may be designated as D:. Or, you may already have a C:\POWER subdirectory to which you do not wish to add any additional files. In either case, you can use the Power disk, but only if you use the Multi-Chapter procedures explained below.

Ventura's chapters contain pointers that tell the program where to find the files it needs. The sample chapters on the

Power disk point to the C:\POWER subdirectory. If you place them anywhere else, you must change their pointers before they will work properly. To do that, you must use Multi-Chapter from the Options menu while in Ventura.

The first step is to decide where you want to place the Power files. For illustration, we will assume that you wish to place them in a subdirectory called D:\SAMPLE. In the instruction below, substitute your actual disk drive and subdirectory wherever you see D:\SAMPLE.

WARNING: You must follow the installation instructions in the order shown below. Otherwise, we cannot guarantee proper operation of the sample chapters.

- Change to the D: disk by typing:

```
D: [Enter]
```

- At the D: prompt, type:

```
MD \SAMPLE
```

```
CD \SAMPLE
```

- Put the working Power disk in drive A: and do not remove it until the end of this procedure. Type:

```
COPY A:*.*
```

- Load Ventura Publisher. Once it is on the screen, select Multi-Chapter from the Options menu. You do not need to open a chapter first.

- If there is a chapter highlighted in the Multi-Chapter dialog box, deselect it by clicking anywhere else inside the dialog box.

- Select Open from the list at the side of the dialog box. The Item Selector will appear.

- Move the cursor to the Directory line. Press Esc to clear the line and type:

```
A:\CHAPTERS\*.PUB [Enter]
```

Ventura looks on the A: drive for publications. An Item Selector appears. It shows only one publication, called POWER.PUB.

- Click on POWER.PUB to select it. Click OK.

The Multi-Chapter dialog box now shows a list of the chapters that make up the publication.

- Select Copy All from the list at the right side of the dialog box.

The Copy All dialog box appears. At the top is a Source section. Confirm that it shows the publication A:\CHAPTERS\POWER.PUB.

- Move the cursor to the line labeled PUB & CHPs. Press Esc to clear the line. Type in the name of your destination subdirectory. For example:

D:\SAMPLE

- Click once on the button titled Make All Directories the Same As the First.

All the lines now read D:\SAMPLE.

- Click OK.

WARNING: As Ventura copies the files, you will see one or more of the following messages. Respond by choosing the uppermost button, as explained below.

Ventura displays several messages like the one below:

D:\SAMPLE\6NEWSLET.CHP already exists on the target drive. Do you wish to overwrite the old version, keep the old file, or cancel the archive process?

- Choose Overwrite (the uppermost button).

You may also see this message:

This file could not be found: C\VENTURA\OUTPUT.WID. Do you wish to skip over it or retry with a new disk, or cancel the archive process?

- Choose Skip (the uppermost button).

When Ventura has finished copying, it returns you to the Multi-Chapter dialog box.

- Click on Done.

Remove the Power disk from the A: drive. You are ready to begin work.

➤ *NOTE: See Chapter One for more information about Ventura files and pointers. See Chapters Three and Seven for hands-on practice with Multi-Chapter.*

Colophon

Not only do we produce books *about* Ventura at New Riders, we also produce books *with* Ventura. Consequently, people often ask us about our favorites: our favorite equipment, our favorite software, our favorite production tricks and techniques. We included this brief appendix to answer some of those questions.

Perhaps the most important advice we have to offer concerns the management of the production process. Some of the biggest problems with Ventura arise not from the software, but from lack of organization and standardization. We use a variety of techniques to make it easier to produce pages with Ventura in a workgroup environment:

- Standard tag names
- Standard file naming conventions for *every* file that goes into the document
- Standard subdirectory naming and organization across different computers
- A standard chapter template so headers, crop marks, frame sizes, and other repeating elements are identical from chapter to chapter
- A style guide for authors and editors that covers tagging, file naming, spelling, grammar, and other basics
- A tag that shows the latest date of the style sheet, so we don't accidentally use an old version

- An ID line at the top of text files to identify the file name and date. This information is placed in a footer that falls outside the trim margin. That way, we can glance at the bottom of the page and immediately know which version of the document we are looking at

These procedures have brought numerous benefits:

- We can recognize files at a glance just by their name and extension
- Authors can pretag manuscripts so we have less pretagging to do
- Authors can mark the manuscripts with the position, file name, and a description of the pictures they want. The layout editor merely has to load the right file into the right frame
- We can use DOS to archive and copy chapters between machines (because the subdirectory organization is identical)
- Any layout operator can work on any project, because the procedures are the same

We developed some of these ideas on our own. Many of them, however, are borrowed from editors and experts around the country who have been kind enough to share their favorite tricks and tips. Our production management techniques are described in detail in our book *New Writing*, a style guide and procedures handbook for desktop publishing. See the ordering section for more information on this book.

Software and hardware

Our job was made easier this time around by several new or improved tools. At the top of the list is Ventura 2.0 Professional Extension. In our experience, this new version is much less prone to bugs and crashes. We employed many of its new features. Our favorites include:

- EMS support for faster formatting and fewer crashes
- Table mode for quick, easy preparation of tables

- Enhancements to Graphic mode so callouts and other illustrations are easier to produce

We are also experimenting with the new cross referencing and frame anchoring features available in the Professional Extension, but we have not yet fully integrated them into our production system.

We captured the screen shots with Hotshot Graphics from Symsoft. This combination screen capture/graphics editor/graphics library program continues to expand and improve with each new edition.

We also made extensive use of LaserTorq, a print spooling utility from LaserTools. You can print your chapters to a disk or (RAM disk) and LaserTorq will then spool them to the printer in the background. Meanwhile, you get your keyboard back so you can go on working without waiting for the printer to stop. Unfortunately, we did not have enough memory to permit us to use LaserTorq with very large chapters.

In addition, we also made use of our own third-party program, Desktop Manager. This utility works “inside” Ventura to add new dialog boxes and new features. We can track the status of projects, check the contents and size of files, get automatic timed backup, and much more, all without leaving the Ventura work session. Best of all, from a production standpoint, is the ability to copy, move, rename, or delete any file, chapter, or publication within Ventura. Until we had Desktop Manager, we had to leave Ventura to rename a graphics file; or to archive a chapter without also sending the width file to the hard disk; or to delete a chapter and its associated files. Now we can do all these tasks (and many more) within Ventura.

The manuscript was created with Microsoft Word. We used Ventura to convert to WordStar format for in-house editing.

We couldn't have gotten by without our big screen monitors from Verticom and Moniterm. Verticom no longer makes monitors for desktop publishing (although they are still selling in the CAD arena), but Moniterm is still active.

Our computers are Premium 286 models from AST equipped with 1- 2MB of RAM and 40MB hard disks. When you routinely produce 700-page books with 500 illustrations, you soon

come to wish for the speed of a 386-based computer and the storage capacity of 100MB+ hard drives. We hope to upgrade soon. We are also still searching for the ideal backup solution. At the moment, we still use 1.2 MB floppies.

Production details

The camera-ready pages for this book were produced on a 300-dpi laser printer.

The main text is 11/13 Century Schoolbook. Display type is Helvetica Bold. Captions and tables are Helvetica Narrow.

Printing: Web offset, R.R. Donnelley & Sons, Indiana.

Index

A

- Abandon 1-29
 - publications 1-65
 - recovering from mistakes 1-53
- Abbreviated Format 1-53, 3-37
- Above Spacing 1-43, 1-51, 1-66
 - See also Spacing
- Add Chapter 3-64
- Add New Frame 1-58, 3-23, 3-32
- Add New Tag 2-29
- Adding a Caption 2-51, 3-59
- Adding a Frame 2-41, 3-23
- Adding a New Printer 3-63
- Adding a New Tag 2-28, 2-49, 2-56
- Adding a Page Break 2-30, 2-56
- Adding a Picture 2-41
- Addition Button 1-9
- Adobe Illustrator 5-1
- An Advertising Flyer 5-10
- Aligning Text Frame-Wide 2-27
- Alignment
 - decimal 4-46
 - frame-wide 2-27, 6-41, 7-17
 - indents 2-26, 2-56
 - middle 4-43
 - relative indent: on 7-44, 9-26
 - rotated 5-32
- Allow Within: No 9-30
- Alt Key 2-5, 4-51, 5-7, 5-26, 5-30, 5-57, 10-11
- Anchors & Captions 2-51, 2-57, 3-59, 3-70, 6-52, 9-43
 - See also Insert/Edit Anchors
- Applying Tags 1-39, 2-25
 - to an empty paragraph 2-31
- Arrow Keys
 - finding hidden attributes 2-17
- ASCII Files
 - converting to other formats 6-8
 - creating 7-2
 - typing in 7-7
- Aspect Ratio: Distorted 5-6, 6-51
- Aspect Ratio: Maintained 3-59, 5-6, 5-55
- Assign a Color 9-36
- Assign Function Keys 3-50, 3-53, 3-68, 9-16
- Assigning a File Extension 1-24
- Assignment List 1-9, 1-39
- Attribute Overrides 8-24
- Attributes, Text 2-5, 2-15, 2-18
 - bold 6-27, 10-34
 - hidden 10-18
 - in headers 4-17
 - italics 2-16, 6-27
 - normal 6-30
 - paste 2-21
 - removing 2-18, 2-21
 - small 6-28, 8-24
- Auto-Adjustments 1-52, 2-8
- Auto-Leader 4-44
- Auto-Numbering 9-17, 9-19, 9-51
 - creating outlines 9-51
 - with multiple lists 9-31
- AutoCAD 5-1, 9-1
 - DXF TO GEM conversion 9-2

encapsulated postscript format 9-2
 HPGL format 9-2
 slide file format 9-2
 Automatic Figure Numbering 9-43
 Automatic Invoice Numbering 4- 13
 Automatic Pair Kerning 5-46, 5-47
 implementing 5-49, 5-59

B

- Backing Up
 a chapter 1-5, 1-63
 a publication 1-5, 3-64
 See also Copying
 See also Multi-Chapter
- Backspace Key 1-22
- Backup Button 1-23, 1-67
 moving to subdirectories 1-17
- Backup Files 1-27
- Balancing Columns 2-25, 2-56, 3-20
- Banner Headline 6-41, 6-62
- Below Spacing 1-43, 1-51, 1-66,
 2-28, 3-48
 See also Spacing
- Big First Character 6-6, 6-44, 6-62,
 8-22
- Bit-Mapped Images
 See Pictures
- Body Text
 formatting first in a document
 1-40, 2-25, 6-32
 inter-line spacing 1-66, 10-36
 removing a tag to 3-58
- Boldface Lead-ins 6-6
- A Book 8-3
 parts of 8-1
- Book Tips 8-50
- Box Character 6-47
 copy 6-48
 cut 6-48
 paste 6-48
- Box Text 1-9, 4-7
 adding text to 4-38
 changing fill attributes 4-26, 4-47
 changing line attributes 4-25, 4-49
 copy 4-26, 4-34, 6-55
 cut 4-24
 deselecting 4-47
 drawing 4-24, 5-13, 9-47
 effects 4-7
 end styles 4-50
 modifying the Z_BOXTEXT tag 4-9,
 4-42
 moving 4-27, 4-54
 paste 4-27, 4-35
 resizing 4-24, 4-28
 tips 5-56
 versus frame text 4-8
 versus rectangles 4-9
- Box Text Tips 4-54, 5-56
- Bracket Codes 2-5, 2-17, 8-52, 9-46
- Breaks 2-25, 2-30, 2-32
 allow within: no 9-30
 keep with next 2-35, 2-39, 2-56,
 7-20, 7-22 to 7-24
 page 2-32
 with side-by-side paragraphs 8-28
- Bring to Front 5-56
- Bullets 2-37, 2-39
 See also Special Effects
- Business Documents
 an advertising flyer 5-10
 an invoice 4-12
 a book 8-3
 a directory 7-6
 a single-column report 1-7
 a technical manual 9-5
 a three-column newsletter 6-6
 a two-column newsletter 3-13
 a two-column proposal 2-8
- By Scale Factors 5-4, 5-6, 5-55
 aspect ratio distorted 5-6
 aspect ratio maintained 5-6, 5-55

C

- A Calendar 6-6, 6-52
- Callouts 4-7, 4-54, 9-5, 9-47
- Canceling a Dialog Box 1-11
- Caption File 3-28, 3-30, 4-8, 6-61
- Caption Labels 3-59, 3-70
- Captions 2-56
 - adding 2-51, 3-5, 3-59, 6-52, 9-43
 - automatic figure numbering 3-59, 9-43
 - definition of 3-5
 - formatting 2-53
 - label 3-59
 - modifying 3-60
 - overwriting 5-37
 - sizing and scaling 2-52, 2-54
 - text in 2-53, 6-52
- Carding 10-36
- Cells 10-6
 - adding text to 10-32
 - contents of 10-8
 - editing 10-43
 - joining 10-28
 - specifying 10-6
- Changing Column Formats 2-23
- Changing Page Numbers 4-21, 4-52, 8-20, 8-32
- Chapter Counter 8-19, 8-32
- Chapter Files
 - backing up 1-5, 1-63
 - definition of 1-1
 - opening 1-5, 1-49
 - parts of 1-1
 - pointers in 1-1, 1-5, 1-63
 - printing 1-62
 - renaming 1-27, 3-16
 - restoring 1-27
 - saving 1-28, 1-62, 3-22
 - where Ventura stores 1-2
- Chapter Menu 1-31
- Chapter Templates 6-59, 7-33 to 7-35
- Chapter Tips 1-67, 3-70, 6-60, 6-63
- Chapter Typography 3-19, 6-11
 - column balance 2-25
 - move down to 1st baseline by 3-20, 6-35, 8-22
 - overriding 5-44
 - pair kerning 5-47
 - vertical justification allowed 10-37
 - vertical justification around frame 10-35
 - widows and orphans 3-20, 8-20
- Clipboard 2-19, 2-21, 2-56, 3-3, 3-34, 3-67, 4-26 to 4-28, 5-39, 6-48
- Codes, Typographic 2-5, 2-17, 4-19, 5-11, 5-25, 5-59, 6-27
- Color
 - See Spot Color
- Color Printing
 - process color 9-34
 - spot color 9-34
- Column Balance 2-25, 2-56, 3-20, 5-46
- Column Break: Before & After 9-15
- Column Breaks 9-5
- Column Guides 1-10, 3-23
- Column Snap 2-41, 3-23, 4-4, 5-15, 5-45
- Columns
 - balancing 2-25, 3-20
 - calculating side-by-side paragraphs 8-28
 - changing number of 2-23, 5-22, 6-14
 - making equal widths 2-24, 2-56
 - unequal 5-22
- Conversion
 - DXFTOGEM 9-2
 - of file formats 6-7, 6-61
 - to typographic characters 2-8
- Copy All 1-64, 3-66
- Copy Box Character 6-48

Copy Box Text 6-55
 Copy Column 10-8
 Copy Fitting 5-46
 Copy Frames 3-34
 Copy Graphic 4-26, 4-31, 4-34, 5-40
 Copy Row 10-8
 Copy Text 2-15, 2-19, 2-21, 2-55
 Copy To Facing Page 3-17, 3-19
 Copying
 a chapter 1-5
 a publication 1-5
 See also Backing Up
 See also Multi-Chapter
 Copyright Symbol 2-5
 Correcting Typing Mistakes 1-22,
 3-29
 Creating a Publication 1-63, 3-64,
 3-70, 10-40
 Creating a Title Page 9-13
 Creating ASCII Files 7-2
 Creating Multiple Lists 9-31
 Creating Subdirectories in Ventura
 1-14
 Creating Technical Illustrations 9-1
 Crop Marks 7-6, 7-9, 7-43, 8-3, 9-7
 built-in vs. hand-drawn 7-11
 changing margins to draw 9-8
 printing 8-50
 Cropping Pictures 5-4
 images, bit-mapped 5-7
 line-art 5-7
 x, y offset 5-7
 Cross Referencing 10-1 to 10-3,
 10-42
 substitute text 10-17
 variable text 10-17
 Ctrl-[5-26
 Ctrl-] 5-26
 Ctrl-B 9-30
 Ctrl-C 6-46
 Ctrl-E 1-30
 Ctrl-Enter 4-40, 5-26

Ctrl-Hyphen 5-51, 5-57
 Ctrl-K 3-51, 3-53, 3-69, 9-16
 Ctrl-N 1-30
 Ctrl-Q 4-52, 4-55, 7-11
 Ctrl-R 1-30
 Ctrl-S 1-28, 1-62, 3-23
 Ctrl-Shift-[6-27
 Ctrl-Shift-] 6-27
 Ctrl-Shift-F 6-42
 Ctrl-Shift-T 6-42
 Ctrl-T 2-19
 Ctrl-X 1-11, 2-54, 3-24, 3-34, 3-57,
 5-12
 Ctrl-Z 5-39
 Current Selection Box 1-10, 1-55,
 2-18
 displaying file name 1-20
 Custom Rules 7-21
 Cut Box Character 6-48
 Cut Column 10-8
 Cut Frames 1-60, 3-24, 3-34
 Cut Graphic 4-24, 4-27
 Cut Row 10-8
 Cut Text 2-15, 2-19, 2-21, 2-55

D

Dashed Rules 6-20, 6-61
 Database Program
 generating a directory from 7-1, 7-3
 pretagging in 7-1 to 7-3
 Decimal Alignment 4-46
 Deckhead 3-55
 Define Colors 9-35
 Del Key 1-22, 3-34, 4-24
 Delete Frames 1-60, 3-24, 3-34
 Delete Graphic 4-24, 4-27
 Delete Tables 10-43
 Delete Text 2-15, 2-19, 2-21
 Deselecting Graphic 4-29
 Dialog Box

- canceling choices 1-11
- enter key 1-11
- help menus 1-11
- measurement units 1-11
- OK button 1-11
- recalling last 2-54
- saving choices 1-11
- text attr. button 4-18
- Diamond 1-23
- A Directory 7-6
- Directory Line 1-23, 1-67
- Disable Colors 9-35
- Discretionary Hyphens 5-51, 5-57
- Display Generated Tags 2-40
- Display Type 3-40
- Documents
 - See Business Documents
- DOS 1-16, 1-67
 - copy command 1-5, 1-15, 1-63, 1-67
 - rename command 1-26, 2-13
 - starting Ventura from 1-8
 - using Multi-Chapter instead of 1-5
- Double Rule 9-23, 9-27
- Double-Clicking 2-10
- Double-Sides 3-17, 5-15
- Dragging the Mouse 3-1
- Drawing Box Text 4-24, 5-18 to 5-21, 9-47
- Drawing Multiple Frames 3-32
- Drop Cap
 - See Big First Character
- Drop Shadows 5-37

- E**

- Edit Fractions 8-11
- Editing Text 1-66, 2-15, 2-19, 2-21, 2-55, 5-32
- Effects
 - arrow 4-50
 - underscore 4-44
 - automatic numbering in header 4-13
 - balanced columns 2-25
 - banner headline 2-28, 6-41, 6-62
 - big first character 6-6, 6-44, 8-22
 - boldface lead-in heads 6-6, 6-28
 - box text 4-7, 5-11
 - bullet 2-37, 2-39
 - callouts 4-7, 4-54, 9-5, 9-47
 - column breaks 9-5
 - creating a calendar 6-6, 6-52 to 6-57, 6-59
 - creating a dateline 3-41
 - creating a title page 2-26
 - creating chapter templates 6-59 to 6-61, 6-63, 7-33 to 7-35
 - crop marks 7-6, 7-9, 7-43, 9-7
 - custom rule 3-54, 6-6, 7-21
 - deckhead 3-55
 - dotted tear line 4-13, 4-36, 4-44
 - double rule 6-6, 6-43, 9-23, 9-27
 - drop cap 8-22
 - drop shadows 5-11, 5-37
 - end of article symbol 6-46
 - fold line 6-20
 - hollow box 6-46
 - jump text 6-23, 6-27
 - kerning headlines 5-11, 5-46, 6-33
 - kicker 3-43
 - lead-in paragraph 3-46
 - letter spacing 5-50
 - logo 3-37, 6-33
 - nameplate 3-37
 - note 9-28
 - number lists 4-46
 - outlines 9-51
 - overlapping graphics 4-8
 - page break 2-30, 2-32
 - pull quote 6-25, 6-43, 6-61
 - reverse type 4-13, 7-6, 7-16, 7-18, 7-43
 - rotated text 5-32

ruling box around frame 2-45, 5-22
 ruling lines in tables 10-44
 secondary margins 1-48
 section numbers 9-5
 small cap lead-in heads 8-24
 snap-to grid 4-13
 solid box 6-46
 spacer tag 9-41
 spot color 9-5
 table of contents 3-28, 8-36
 tables with horizontal tabs 2-45
 tags residing on same line 3-42,
 3-69, 6-39, 6-48, 7-23, 7-44
 teaser 5-25
 text aligned across columns 1-47,
 3-22, 5-47, 6-12
 text runarounds 5-11, 5-42, 5-43,
 5-56
 thumb tabs 7-6, 7-25
 tint screens 4-13, 4-47, 6-6, 6-14
 tracking headlines 3-38, 3-40, 6-33,
 6-37
 two-column format 2-23
 typographic fractions 8-10
 Ellipsis 5-11, 5-25
 Em Dash 2-5, 2-8, 5-11, 5-26
 converting from hyphens 2-8
 Em Space 3-40
 Empty Paragraph 2-31, 9-13, 9-15
 En Dash 7-13
 Encapsulated PostScript 5-57
 creating 5-53
 displaying 5-3, 5-37
 placing 5-3, 5-36
 End Key 1-29
 End of Article Symbol 6-46
 End of File Marker 2-52, 3-28, 4-7,
 4-24, 6-23
 tagging the 4-45
 End Styles 4-26
 Enlarged View 1-30, 5-16
 Enter Key

closing a dialog box 1-11
 EPS
 See Encapsulated PostScript
 Esc Key 1-22
 Extensions
 assigning 1-2, 1-24, 5-55, 8-37

F

Feathering 10-35
 Figure Numbering, Automatic 9-43
 Figure Space 6-42
 File Management
 pictures 5-2
 problems encountered in 1-15
 renaming and relocating files 1-2,
 1-14, 2-11
 storing files in subdirectories 1-14
 File Type/Rename 1-21, 2-11, 3-15,
 6-7, 6-9, 6-23
 tips for using 1-66
 File Types
 CAP 1-2
 CHP 1-2
 CIF 1-2
 IMG 1-2
 VGR 1-2
 Files
 backing up 1-3
 extensions 1-2, 1-24
 loading 1-16, 1-25, 1-49, 2-10, 3-14
 managing 1-1, 1-14, 1-67
 removing from frame 2-13
 renaming and relocating 1-2, 1-15,
 1-21, 1-26, 2-11, 2-55, 6-8, 6-61
 restoring 1-27
 selecting in Item Selector 1-18, 2-10
 spreadsheet 2-41
 See also Chapter Files
 See also Graphics Files
 See also Picture Files

- See also Program Files
- See also Text Files
- Fill Attributes
 - changing 4-26, 4-47
 - saving 4-26, 4-56
- Fill Patterns 6-14, 7-29
- Fit in Frame 3-59, 5-4
 - aspect ratio distorted 5-5, 6-51
 - aspect ratio maintained 5-5
- Flow Text Around: Off 5-42
- Fold Line 6-20
- Font Dialog Box
 - for non-PostScript printer 1-41
 - for PostScript Printer 1-41
- Fonts
 - shifting up/down 8-23
 - with non-PostScript printer 1-41
 - with PostScript printer 1-41
- Fontware 3-37
- Footers 2-56
 - building 2-23, 2-40, 7-12, 9-11
 - changing the frame margin of 7-14, 9-12
 - changing the position with spacing 7-15
 - inserting page numbers in 2-23
 - live 7-6, 7-12, 7-43
 - turning off for first page 2-23
- Footnote
 - changing the frame margin of 8-10
 - changing the position with spacing 8-10
 - deleting 8-10
 - inserting 8-6
 - separator line 8-6
 - setting the format of 8-6
 - text of 8-8
 - tips 8-51
 - See also Ins Special Item
- Footnote Settings 8-6
- Formatting a Generated Tag 2-53
- Formatting Tables
 - horizontal tabs 2-45, 2-49, 2-57
 - side-by-side paragraphs 8-27
 - See also Tables
- Formula, The Ventura -xi
 - See also The Ventura Formula
- Fractions
 - editing 8-11
 - inserting 8-10
 - See also Ins Special Item
- Frame Background 6-14
 - See also Fill Patterns
- Frame Menu 1-31
- Frame Mode 1-9
 - enabling 1-20, 1-36, 3-1
- Frame Text 3-30
 - versus box text 4-8
- Frame Tips 3-67, 4-54, 6-62
- Frame Typography 6-35
 - for copy fitting 5-44
- Frame-Wide Alignment 2-27, 6-41, 7-17
- Frames
 - adding 1-58, 2-41, 3-32, 5-16
 - adding an anchor to 9-44
 - adding captions to 3-5
 - adding columns to 3-4
 - adding margins to 2-44, 3-4, 7-27, 7-43
 - aligning on page 1-60, 3-9
 - blank frame 1-10
 - chaining text files between 3-4, 3-9, 6-21
 - changing the order of 3-10
 - copy 3-34, 3-67
 - creating text runarounds with 5-44, 5-56
 - cut 1-60, 3-24, 3-34
 - fill patterns 6-6, 6-14, 6-62, 7-29
 - grid settings in 4-7, 5-37
 - jump text 3-26, 3-30
 - moving 1-60, 3-2, 3-34, 3-67
 - overlapping 3-3

- padding 1-60
- parent 4-2
- paste 3-3, 3-34
- placing pictures in 2-41
- placing text in 1-19, 2-41, 3-1, 3-7, 3-9, 3-68, 6-20
- re-anchoring 9-46
- removing text from 2-13
- repeating 7-25, 7-31
- ruling lines around 6-62
- selecting 3-1, 3-67, 5-57
- sizing and scaling 1-59, 2-42, 3-1, 3-24, 3-34, 3-59, 3-67, 5-4, 5-16
- typing text in 3-28, 3-30, 3-35, 3-68, 5-13, 6-61
- versus the Page 3-1, 3-7
- Function Keys 3-50, 3-53, 3-68
- tagging with 3-52
- tips for naming 3-52

G

- GEM Draw 5-2
- GEM/HALO DPE 3-15
- Generated Tags 1-39, 2-40, 2-53, 2-56, 3-53, 3-60, 4-9, 4-42, 8-9, 8-37, 8-41, 8-43, 9-12, 9-18, 10-12
- Generating a Table of Contents 8-3, 8-36, 8-38, 8-40
- Generating an Index 8-3, 8-12
- Generating Pretagged Files 7-1
- Go to Page 6-20
- Graphic
 - box text 4-1, 4-7
 - bring to front 5-56
 - circles 4-1
 - clipboard 4-28, 5-39
 - copy 4-26, 4-31, 4-34, 5-39
 - cut 4-24, 4-27
 - deselecting 4-29, 4-47
 - drawing several shapes 4-30

- end styles 4-26
- fill attributes 4-26
- line attributes 4-25, 4-49
- lines 4-1, 4-50
- moving shapes 4-27, 6-62
- overlapping 4-8
- parent frame 4-2
- paste 4-26, 4-31, 4-35, 5-39
- rectangles 4-1, 5-37, 7-9
- resizing 4-24, 4-28
- select all 4-52
- send to back 5-38, 5-56
- show on all pages 4-3, 4-52, 4-55, 7-11, 9-10
- Graphic Mode 1-9, 4-1
 - enabling 4-23
 - if selected while loading text 1-19
 - key points of 4-2 to 4-4
- Graphic Tips 4-55
- The Grid System 6-1
- Grid Settings 4-4, 5-18, 5-37, 7-9
 - horizontal 4-23
 - vertical 4-23
- Grid Snap: On 4-24
- Grid, Snap-To 3-9, 4-4 to 4-6, 4-13, 4-55, 5-56
- Ground Rules
 - making your system match vii
- Gutters
 - entering 2-24, 3-17

H

- Half-Size Format 8-3
- Handles
 - See Sizing Buttons
- Header Rows 10-9
- Headers 2-56
 - automatic numbering in 4-13
 - building 4-17

- changing the position with spacing 7-15
 - copy to facing page 3-19
 - entering text in 4-17
 - inserting page numbers in 1-35, 3-19, 4-19
 - live 7-43
 - modifying the Z_HEADER tag 3-53
 - resetting after margins change 1-37
 - text attributes in 4-17
 - turning off for first page 1-35, 3-19
 - Headers & Footers 2-23, 2-40
 - 1st Match 7-13
 - Help Menus 1-11
 - Hide All Pictures 5-53
 - Hide Tabs & Returns 2-30
 - Hollow Box 6-46
 - changing size of 6-47
 - Home Key 1-29
 - Horizontal Spacing
 - See Spacing
 - Horizontal Tabs 2-45
 - Hyphenation
 - dictionary 5-57
 - manual 5-51
 - preventing 5-57
 - turning off for display type 1-51
 - Hyphens
 - converting to em dash 2-8
 - discretionary 5-51, 5-57
 - placing in text files 1-16
- I**
- I-Beam 2-15
 - Images, Bit-Mapped
 - See Pictures
 - In From Left Spacing 1-48, 2-39, 3-43, 3-47, 3-69, 6-49, 8-28, 9-20
 - See also Spacing
 - In From Right Spacing 1-48, 3-43, 3-69, 6-49, 8-28
 - See also Spacing
 - Indents 2-26, 2-56
 - Index
 - generating 8-3, 8-12
 - levels of 8-12
 - primary entry 8-13
 - secondary entry 8-13
 - see also references 8-13
 - Ins Column 10-9
 - Ins Key 2-19, 3-34, 4-27, 4-35
 - Ins New Table 10-25, 10-43
 - Ins Row 10-9, 10-33
 - Ins Special Item 6-46
 - box character 6-47
 - cross reference 10-4, 10-21
 - footnote 8-8
 - fraction 8-11
 - frame anchor 9-45
 - index entry 8-13
 - reference 7-28, 7-37
 - variable def 10-18
 - Inserts
 - 1st Match 7-13
 - Last Match 7-43
 - Insert Frames 3-3, 3-34
 - Insert Graphic 4-27, 5-39
 - Insert Text 2-15, 2-19
 - Insert/Edit Anchor 9-44, 9-52
 - Insert/Edit Table 10-8, 10-11, 10-24, 10-43
 - Insert/Remove Page 3-32
 - Inserting a Footnote 8-6
 - Inserting a Fraction 8-10
 - Inserting a Page 3-32, 4-52, 5-21
 - Inserting a Reference Marker 7-29
 - Inserting an Index Entry 8-13
 - See also Ins Special Item
 - Inserting Cross References 10-3, 10-18, 10-42

Inserting Discretionary Hyphens 5-51
 Inserting Typographic Codes 2-4, 4-19, 5-11
 Installing a Second Printer 3-70
 Inter-Col. Rules 3-18
 Inter-Line Spacing 1-43, 1-47, 1-51, 1-60, 1-66
 See also Spacing
 Inter-Paragraph Spacing 1-66, 2-28
 See also Spacing
 Interactive Tracking 6-34
 An Invoice 4-12
 Italics
 when to use 2-16
 Item Selector 1-17
 backup button 1-17, 1-67
 diamond 1-17
 directory line 1-23, 1-67
 selection line 1-19

J

Join Cells 10-28
 Jump Text 3-26, 3-30, 6-12, 6-23, 6-27

K

Keep With Next 2-35, 2-39, 2-56, 7-20, 7-22 to 7-24
 Kerning 6-33
 automatic pair 5-46, 5-57
 definition of 5-46
 in text mode 5-48
 manual 5-46, 5-48
 on-screen 5-49, 5-57
 tables 5-46
 Keyboard Mode
 accidentally enabling 1-30

Keyboard Shortcuts 2-19
 alt Key 2-5, 5-7, 5-26, 5-30
 backspace 1-22
 ctrl-[5-26
 ctrl-] 5-26
 ctrl-b 9-30
 ctrl-c 6-46
 ctrl-e 1-30
 ctrl-enter 4-40, 5-26
 ctrl-hyphen 5-51, 5-57
 ctrl-k 3-51, 3-53
 ctrl-n 1-30
 ctrl-q 4-52, 4-55
 ctrl-r 1-30
 ctrl-s 1-28, 3-23
 ctrl-shift-[6-27
 ctrl-shift-] 6-27
 ctrl-shift-f 6-42
 ctrl-shift-t 6-42
 ctrl-t 2-19
 ctrl-x 1-11, 2-54, 3-24, 3-34, 3-57, 5-12
 ctrl-z 5-39
 del 1-22, 2-19, 2-55, 3-34
 end 1-29
 esc 1-22
 function keys 3-50
 home 1-29
 ins 2-19, 2-55
 pgdn 1-21, 1-29
 pgup 1-29
 shift key 4-30
 shift-click 1-55, 1-57, 2-18, 2-34, 2-56
 shift-del 2-19, 2-55
 Kicker 3-43

L

Landscape Format 7-6, 9-5
 Lead-in Heads 6-28, 8-24
 Lead-in Paragraph 3-46

Leader Dots 3-48, 3-69
 Letter Spacing 5-50
 Line Attributes
 adding an arrow 4-50
 changing 4-25, 4-49
 end styles 4-26
 saving 4-25, 4-56
 Line Break: After 3-42, 7-24
 Line Break: Before 3-43, 7-23
 Line Break: No 8-31
 Line Breaks 1-38, 4-40, 5-26
 versus paragraphs 7-3
 Line Snap 2-41, 3-23, 4-4, 5-15,
 5-43, 6-12
 Line-Art
 See Pictures
 Lines 4-50
 Lists 9-5, 9-17 to 9-19, 9-31
 creating 9-5
 Live Headers and Footers 7-6, 7-12,
 7-43
 steps for creating 7-13
 Load Diff. Style 1-22
 Load Different Width Table 3-63
 Load Text/Picture 1-25, 2-55
 Loading a Picture File 1-25, 3-15
 Loading a Style Sheet 1-22
 Loading a Text File 1-16, 2-41
 Loading Several Files 2-10
 Logo 3-37, 6-33
 Loose Lines 5-51
 reducing 5-51

M

MacDraw 5-2
 Make Equal Widths Button 2-24
 Make TOC 8-37
 Making Columns Equal Widths
 2-24, 2-56
 Managing Files 1-1, 1-14, 1-67

Margins
 changing 1-36, 3-17
 creating temporary 1-48, 8-31
 resetting the header after changing
 1-37
 rule of thumb for creating 1-37
 Margins & Columns 1-36, 2-23, 5-22
 copy to facing page 3-17
 in frames 2-44, 3-4, 6-14
 Markers, On-Screen 2-17, 2-19
 displaying 2-30
 Maximum and Minimum Space
 Values 5-50
 Measurement Units 1-11
 changing in dialog box 1-36
 Measuring Indents 2-26
 Measuring System
 picas and points 2-2
 Menus
 drop down 1-8
 selecting 1-8
 MicroSoft Word Format 6-8
 Middle Alignment 4-43
 Mode Selector 1-8
 frame mode 1-8
 graphic mode 1-8
 paragraph mode 1-8
 text mode 1-8
 Modifying Tags 1-30, 2-25
 Mouse 1-18, 3-2
 using viii
 Move Down to 1st Baseline By 3-22,
 5-44, 6-35, 8-22
 definition of 3-20
 Multi-Chapter 1-63
 for backing up a chapter 1-5, 1-63
 for backing up a publication 1-5,
 1-63, 3-64, 3-70
 make TOC 8-37
 printing with 1-62, 3-64, 3-66, 7-39,
 10-39

renumbering a publication 7-39,
10-4, 10-22
See also Backing Up
See also Copying
MultiMate Format 6-8

N

Nameplate 3-37
New 1-8, 4-13
 when to use 2-10
Newsletter-Style Layout 3-1, 3-7,
 3-9, 3-11, 3-17, 3-20, 3-22, 3-37,
 3-68, 6-1, 6-6, 6-21, 6-52, 6-62
Normal View 1-30, 5-16
Number Lists 4-46

O

Object-Oriented Graphics
 See Pictures
OK Button 1-11
On-Screen Kerning 5-49, 5-57
One-Column Report 1-7
Open and Closed Quotes 6-27
 converting from standard quotes
 2-5, 2-8
Open Chapter 1-49
Options Menu 1-11
 starting configuration 1-11
OUTPUT.WID 3-64

P

Padding
 setting to body text inter-line 1-60,
 6-62
 vertical 1-47, 1-60, 6-26
The Page

as parent to graphic 4-2
definition of 1-10, 3-6, 3-68
double-sides 1-32
if selected while loading text 1-19,
2-11, 5-12
moving around 1-29
placing text on 1-19, 1-21, 3-7
removing files from 2-13
selecting 1-20
single-sides 1-32
sizing and scaling 1-32, 3-6, 3-68
versus frames 3-1, 3-7
viewing 1-29
Page Break 2-32, 2-56
 adding a 2-22, 2-30
Page Break: After 2-30, 9-51
Page Break: Before 7-17, 9-24
Page Break: Before/Until Right 7-17
Page Counter 8-20, 8-32
Page Layout Strategy 1-31, 2-22,
 3-1, 3-7, 3-9, 3-17, 3-22, 4-12, 4-17,
 5-10, 5-15, 5-57, 6-3, 6-32
Page Numbers 1-10
 changing 4-20, 4-52, 8-20, 8-32
 in thumb tabs 7-6, 7-28
 inserting in footers 1-35
 inserting in headers 1-35, 3-19, 4-19
 linking across chapters 7-38
 on double-sided pages 3-17
 See also Page Counter
Page Size & Layout 1-32
 defining the page with 1-10
 double-Sides 3-17, 5-15
 half-size format 7-12, 8-3
 landscape format 7-6, 9-5
Pair Kerning: On 5-47
Paper Type & Dimension 7-12
Parafiltr Code 2-4, 2-55, 7-42
Paragraph
 definition of 1-38
 empty 2-31
 lead-in 3-46

- tagging the wrong 2-27
- using line breaks in 1-38
- versus line breaks 7-3
- Paragraph Menu 1-31
- Paragraph Mode 1-9
 - enabling 1-40
 - if selected while loading text 1-19
 - when to use 2-16, 2-55
- Paragraph Typography 3-39, 6-33
 - at bottom of paragraph 10-38
 - at top of paragraph 10-38
 - automatic pair kerning 5-47
- Paste Box Character 6-48
- Paste Column 10-8
- Paste Frames 3-3, 3-34
- Paste Graphic 4-26, 4-31, 4-35, 5-39
- Paste Row 10-8
- Paste Text 2-15, 2-19, 2-55
- PC Paintbrush 5-1
- PgDn Key 1-21, 1-29
- PgUp Key 1-29
- Picture Files
 - how Ventura manages 5-2
 - loading 1-25, 1-49, 5-2
 - renaming and relocating 1-26, 2-13
- Picture Tips 2-57, 3-70, 5-55, 6-62, 9-52
- Pictures
 - Adobe Illustrator 5-1
 - AutoCAD 5-1
 - cropping 5-4, 5-7
 - encapsulated postscript 5-3, 5-37
 - GEM Draw 5-2
 - hiding 5-56
 - images, bit-mapped 5-2, 5-4
 - line-art 5-2 to 5-4, 5-36, 9-1
 - MacDraw 5-2
 - object-oriented 5-2
 - PC Paintbrush 5-1
 - sizing and scaling 5-4 to 5-6, 5-42, 5-55, 6-51
- Placing Text in Frames 1-19
- Placing Text on the Page 1-19, 1-21
- Planning
 - an advertising flyer 5-10
 - a book 8-3
 - a directory 7-6
 - an invoice 4-12
 - a one-column report 1-7
 - a technical manual 9-5
 - a three-column newsletter 6-6
 - a two-column newsletter 3-13
 - a two-column proposal 2-8
- The Point System 2-2
- Pointers
 - changing 1-5, 1-63, 1-67
 - storing 1-1, 1-16, 5-55
- Pop-Up Menus 1-11
- PostScript Printer
 - creating Encapsulated Postscript files with 5-3
 - fonts used with 1-41, 3-37
 - if you do not have 1-41, 1-62, 3-37, 6-33
 - installing as a second printer viii, 1-41
 - overlapping graphics 4-8
 - using the book with viii
- The Power Disk
 - if you do not own ix, 1-8
 - if you own 1-8
 - installing ix, 1-8
 - ordering ix
- Preformatting Text 2-3 to 2-5, 2-55, 8-1
- Pretagging Text 7-1
 - rules for 7-2
 - tips 7-42
- Print Spooler 10-39
- Printer Ports, Changing 3-63
- Printer's Measure 2-2
 - picas 2-2
 - points 2-2
- Printing 1-62

1st to last 6-59, 7-41
 crop marks 7-11, 8-3, 8-50
 current page 2-54, 2-57, 4-53
 hidden pictures 5-53
 last to 1st 3-61, 3-70, 7-41
 number of copies 4-53
 publications 8-49, 10-41
 selected pages 3-61
 spot color 9-34, 9-50
 to file 5-53, 10-39
 which pages 6-59
 The Professional Extension
 if you have installed vi to vii

Publications

abandoning 1-65
 backing up 3-64
 creating 1-63, 3-64, 3-70, 8-34, 10-40
 definition of 1-63, 3-64
 linking page numbers across
 chapters 7-38
 new 8-34
 printing 8-49, 10-41
 rearrange chapter list in 8-35
 renumbering 7-39, 7-44, 8-36, 10-18,
 10-22
 saving 3-65, 10-22
 Pull Quote 6-25, 6-43, 6-61

Q

Quit
 without saving 1-16
 Quotes
 true typographic 2-5

R

Re-Anchoring Frames 9-46
 Rearrange Chapter List 8-35

Recalling the Last Dialog Box 2-54,
 3-24
 Rectangles 4-9, 5-37, 7-9
 Reduced View 1-30
 Reducing Loose Lines 5-51
 Reference 7-28, 7-37
 Registered Sign 5-11
 Relative Indent: On 7-44, 9-26
 Remove Selected Tag 3-58
 Remove Text/File 2-12, 3-15, 6-7
 Removing Ruling Lines 2-34
 Removing Text from Frames 2-12,
 3-15
 Rename Tag 3-57
 Renaming and Relocating Files 1-2,
 1-21, 1-26, 2-11, 2-13, 3-15, 3-30,
 6-8, 6-61
 Renumber a Publication 7-39, 7-44,
 8-36, 10-4, 10-18, 10-22
 Renumber Chapter 9-30
 Repeating Frame 7-25, 7-31
 editing a 7-31
 Resetting the Zero Point 2-42, 4-21,
 4-37
 Reverse Type 4-13, 7-6, 7-16, 7-18,
 7-43
 if you cannot print 7-16, 7-18, 7-22
 Rotated Text 5-32
 Rows and Columns in Tables 10-6
 copy 10-8
 cut 10-8
 paste 10-8
 Rulers
 changing units 1-58
 displaying 1-58
 Rules
 changing attributes in tables 10-43
 custom 3-54, 6-6, 6-38, 7-21
 dashed 6-20, 6-61
 double 6-6, 9-23, 9-27, 10-43
 hidden 10-43
 inter-column 3-18

- margin-wide 6-50
 - normal 10-43
 - single 10-43
 - space below rule 3 7-18, 7-22, 7-43, 9-27
 - thick 10-43
 - vertical 3-18
 - Rules of Thumb
 - adding a new tag 2-29
 - alignment versus spacing 2-39
 - for building style sheets 1-31, 2-25, 3-17, 5-15
 - for creating side-by-side paragraphs 8-27
 - for entering margins & columns 5-22
 - for vertical justification 10-13
 - keep with next 2-36
 - placing text in pictures 6-21
 - preformatting text 2-4
 - pretagging text in a database 7-2
 - Ruling Box Around 2-45, 3-26, 5-22, 9-28
 - tables 10-6
 - when crossing a page or column 9-30
 - Ruling Line Above 7-21
 - creating reverse type with 7-16
 - custom width 3-54, 6-38
 - dashed 6-20, 6-61
 - margin 6-50
 - text 9-24
 - Ruling Line Below
 - margin 6-50
 - removing 2-34
 - text 3-44
- S**
- Save 1-28, 3-22
 - Save As 1-67
 - Save As New Style 1-24
 - Save To 4-26, 4-56, 5-56
 - Saving Chapter Files 1-28
 - Scanned Images 5-2, 5-56
 - Screen Fonts 3-63
 - Scroll Arrows 1-18
 - moving around the page with 1-29
 - Scroll Bars
 - moving around the page with 1-29
 - Scroll Box 1-18
 - Section Numbers
 - See Lists
 - Select All Graphics 4-52
 - Selecting Files 1-19, 2-10
 - Selecting Multiple Paragraphs 2-38
 - Selecting the Page 1-20
 - Selection Line 1-19
 - Send to Back 5-38, 5-56
 - Separator Line for Footnote 8-6
 - Set Column Width 10-43
 - fixed width 10-10
 - variable width 10-10
 - Set Font 2-15, 6-34
 - kerning with 5-48
 - Set Preferences 1-13, 2-40
 - auto-adjustments 1-52
 - hide all pictures 5-53
 - keep backup files 1-27
 - on-screen kerning 5-49
 - starting configuration 1-13
 - Set Printer Info 3-62, 10-39
 - adding a new printer 3-63
 - changing printer ports 3-63, 5-54
 - changing width tables 3-63
 - output.wid 3-64
 - screen fonts 3-63
 - switching printers viii, 1-41, 1-62, 3-37, 3-63, 3-70
 - Set Ruler 1-58
 - Set Tint 10-30
 - Setting Tabs 2-50
 - Shapes
 - See Graphic

Shift Key 3-32

for drawing 9-9

Shift-Click 1-55, 1-57, 2-18, 2-34,
2-38, 2-56, 3-67

Shift-Del 2-19, 4-34, 5-39

Shortcuts, Keyboard

See Keyboard Shortcuts

Show Column Guides 6-7

Show Loose Lines 5-51

Show On All Pages 4-3, 4-52, 4-55,
7-11, 9-10

Show Tabs & Returns 2-30, 3-43,
5-32

Show This Picture 3-59

Side-By-Side Paragraphs 8-3

calculating column widths 8-28

preparing text for 8-28

Sizing & Scaling 2-42, 2-57, 3-34,
5-16, 5-42

aspect ratio maintained 3-59

cropping pictures 5-7

fit in frame 3-59, 5-4

flow text around 5-42

frames 3-24

pictures 5-4

tips for using 5-7

upper left y 5-16

Sizing Buttons 1-10, 1-20, 3-1, 4-2,
4-28

Snap-To Grid 3-9, 4-4 to 4-6, 4-13,
4-55, 5-56

Solid Box 6-46

Space Below Rule 1 9-29

Space Below Rule 3 7-18, 7-22, 7-43,
9-27

Space Between Columns 10-27

Space Between Rows 10-27

Space For Big First: Custom 6-44

Space For Big First: Normal 6-45,
6-62, 8-22

Spacing

at bottom of frame 10-37

at top of frame 10-37

between lines 1-43

between paragraphs 1-43

body text inter-line spacing 1-47,
1-66, 2-25, 3-22

changing the position of footnotes
with 8-10

changing the position of headers
and footers with 7-15

dialog box 1-43

eliminating space at the top of a
page or column 1-43, 1-46

horizontal spacing 1-43, 1-48

how auto-adjustments affect 1-52

in from left 1-48, 2-39, 3-47

in from right 1-48

maintaining standard spacing 1-47,
10-27, 10-36

padding 1-47

tips for above spacing 1-43, 1-51,
1-66

tips for below spacing 1-43, 1-51,
1-66, 2-28, 3-48

tips for in from left and in from
right 1-48, 3-43, 3-69, 6-49, 8-28,
9-20

tips for inter-line spacing 1-43, 1-47,
1-51, 1-66

tips for inter-paragraph spacing
1-43, 1-66, 2-28

versus alignment 2-39

vertical justification 10-13, 10-17,
10-19, 10-27 to 10-31, 10-33, 10-35

vertical spacing 1-43, 1-47, 1-51,
3-22

with side-by-side paragraphs 8-28

Special Effects

big first character 6-44, 6-62, 8-22

bullet 2-37, 2-39

Spooler, Print 10-39
 Spot Color 9-5
 adding 9-34
 printing 9-34
 printing overlays 9-50
 Spot Color Printing 9-35
 Spreadsheet File 2-41
 preformatting 2-10
 Starting a New Chapter 1-8, 4-13
 Style Sheets
 contents of 1-31
 definition of 1-31
 modifying 1-40
 renaming and relocating 1-24, 1-66
 rules of thumb 1-31
 Style Tips 1-66, 2-56, 3-69, 6-61
 Subdirectories
 creating in Ventura 1-14, 1-22
 displayed in item selector 1-17
 moving to 1-17, 1-23

T

Tab Settings 2-45, 2-47, 2-50, 2-57,
 3-48, 3-69, 5-33, 6-39, 9-26
 auto-leader 4-44
 creating an underscore 4-44
 measuring locations from margin
 2-47, 6-40
 turning off 2-57
 Table Editor
 See Tables
 Table Mode vii, 10-5
 Table of Contents 3-28
 generating a 8-3, 8-36, 8-38, 8-40
 Table Text 10-12, 10-27, 10-30, 10-43
 Table Tips 8-51, 10-43
 Tables
 adding rows 10-33
 adding tint screen 10-29
 cells 10-6, 10-43
 changing column number 10-10
 changing column widths 10-9 to
 10-11
 changing header rows 10-9
 changing lines 10-6
 changing rule attributes 10-9
 changing settings 10-9
 changing spacing values 10-9
 creating with table mode 10-5,
 10-24, 10-26
 creating with horizontal tabs 2-45
 creating with side-by-side
 paragraphs 8-27
 deleting 10-43
 editing 10-8
 hiding lines 10-6
 joining cells 10-28
 rows and columns in 10-6
 ruling box around 10-6
 ruling lines between 10-6
 set column width dialog box 10-10
 setting the tint of 10-8, 10-30
 space above 10-27
 space around 10-27
 space below 10-27
 space between columns 10-27
 space between rows 10-27
 text in 10-12, 10-30, 10-43
 the parts of 10-6
 tips 10-43
 Tag Tables 4-15
 Tagging the Wrong Paragraph 2-27
 Tags
 adding new 2-28, 2-49, 2-56
 applying 1-39, 2-25
 applying to empty paragraph 2-31
 applying with function keys 3-50,
 3-68
 definition of 1-31, 1-39
 generated 1-39, 2-40, 2-53, 2-56,
 3-60, 4-9, 4-42
 in a database program 7-1

- modifying 1-30, 1-38, 1-40, 1-54, 2-25
 - removing 3-56, 3-58
 - renaming 3-56
 - residing on same line 3-42, 3-69, 6-39, 6-48, 7-23, 7-44
- Teaser 5-25
- A Technical Manual 9-5
- Technical Illustrations, Creating 9-1
- Templates
 - See Chapter Templates
- Temporary Margins
 - with in from left and in from right spacing 8-31
- Temporary Memory
 - See Clipboard
- Text
 - adding to box text 4-38
 - aligning across columns 1-47, 3-22, 5-45, 6-12
 - at top of column or page 3-20
 - attributes 2-5, 2-15, 2-18, 2-21
 - clipboard 2-19, 2-21
 - copy 2-15, 2-19, 2-21, 2-55
 - copy fitting 5-43
 - correcting mistakes 1-22, 3-29
 - cut 2-15, 2-19, 2-21, 2-55
 - editing 2-15, 2-19, 2-21, 2-55
 - hidden attributes in 2-18
 - in captions 2-53, 6-52, 6-61
 - in tables 10-12, 10-30, 10-43
 - inserting typographic characters 2-5
 - locating hidden attributes 2-18
 - paste 2-15, 2-19, 2-55
 - preformatting 1-66, 2-3 to 2-5, 7-1, 8-1
 - replacing in Ventura 10-17
 - rotated 5-32
 - runarounds 5-11, 5-42, 5-56
 - stored in caption file 3-28, 3-30, 3-35
 - tips 3-68, 10-42
 - typing into frames 3-28, 3-30, 3-35, 3-68, 5-13
 - vertical 7-28
 - white 7-17, 7-29
 - See also Editing Text
 - See also Word Processing
- Text Attr. Button 4-18
- Text Files
 - generating TOC 8-40
 - loading 1-16, 2-11
 - placing in frames 1-19, 2-41, 3-1, 3-7, 3-27, 3-68, 5-13, 6-20
 - placing on the Page 1-19, 3-7
 - pretagging 7-1
 - renaming and relocating 1-21, 2-11, 3-15, 5-12
 - selecting in item selector 1-19
- Text Mode 1-9
 - enabling 2-15
 - if selected while loading text 1-19
 - kerning in 5-48
 - tagging in 3-50 to 3-53, 3-68
 - when to use 2-16, 2-55
- Text of Footnote 8-8
- Text Tips 1-66, 2-55, 6-43, 6-61, 9-51, 10-42
- Thin Space 6-42
- Third-Party Utilities 1-26, 3-37
- A Three-Column Newsletter 6-6
- Three-Column Format 6-2, 9-5
- Thumb Tabs 7-6, 7-25
 - steps for creating 7-25
- Thumbnail Sketch 4-12
- Tiff Format 5-4
- Tint Screens 4-13, 4-47, 6-14, 10-8, 10-29
- Tips
 - book 8-50
 - box text 4-54, 5-56
 - chapter 1-67, 3-70, 6-60, 6-63
 - footnote 8-51
 - frame 3-67, 4-54, 6-62

graphic 4-55
 other 7-43, 10-44
 picture 2-57, 3-70, 5-55, 6-62, 9-52
 style 1-66, 2-56, 3-69, 6-61
 table 8-51, 10-43
 text 1-66, 2-55, 6-43, 6-61, 9-51,
 10-42
 vertical justification 10-44
 Title Bar 1-8, 1-24
 To Print 2-54, 2-57, 3-61
 Tracking 3-38, 6-33, 6-37, 6-62
 definition of 3-40
 interactive 6-34
 Trim Marks
 See Crop Marks
 Turn Column Snap Off 3-23
 Turn Footer Off 2-23
 Turn Header Off 1-35
 Turn Line Snap Off 3-23
 Two-Column Newsletter 3-13
 Two-Column Proposal 2-8
 Type Sizes
 measuring 2-2
 Typographic Characters 2-5
 bracket codes 2-5, 2-17
 copyright symbol 2-5
 ellipsis 5-11, 5-25
 em dash 2-5, 2-8, 5-11, 5-26
 en dash 7-13
 fractions 8-10
 open and closed quotes 2-5, 2-8, 6-27
 registered sign 5-11, 5-30
 Typographic Effects 3-19
 big first character 6-6, 6-44
 kerning 5-11, 5-46, 6-33
 letter spacing 5-50
 move down to 1st baseline by 6-35
 reverse type 4-13
 tracking 3-38, 3-40, 6-33, 6-37, 6-62
 vertical justification 10-13, 10-17,
 10-19 to 10-23, 10-27 to 10-32, 10-35

U

Underlying Page
 See The Page
 Update Counters 4-20, 4-52, 7-38,
 8-19, 8-32, 9-12
 Update Method
 previous number + 1 8-34
 Update Tag List 3-50, 3-69
 Upper Left X 5-16
 Upper Left Y 5-16
 User Interface 1-8
 addition button 1-9
 assignment list 1-9
 column guides 1-10
 current selection box 1-10
 dialog box 1-10
 menus 1-8
 mode selector 1-8
 mouse button 1-18
 the page 1-10
 page number 1-10
 scroll arrows 1-8, 1-18
 scroll bars 1-8
 scroll box 1-18
 sizing buttons 1-10
 title bar 1-8

V

Variable Definition 10-18
 The Ventura Formula x, 1-1, 1-16,
 1-29, 2-14, 3-16, 4-17
 getting you out of trouble xi
 rules for building a document x
 Ventura Prep 1-15
 file management operations ix
 for book 8-4
 for directory 7-7
 for invoice 4-13
 for one-column report 1-15

for professional extension 10-16
 for two-column newsletter 3-13
 for two-column proposal 2-10
 for three-column newsletter 6-7
 rules ix, 4-14
Vertical Alignment 4-43
Vertical Justification 10-1, 10-13,
 10-17, 10-19 to 10-23, 10-27 to
 10-31, 10-33
 allowed 10-37
 applying 10-35
 carding 10-36
 feathering 10-36
 rules for 10-13
 spacing at bottom of frame 10-37
 spacing at top of frame 10-37
 tips 10-44
Vertical Justification Around Frame
 10-35
Vertical Justification At Top of
Paragraph 10-38
Vertical Justification Within Frame
 10-35
Vertical Padding 6-26, 6-62
Vertical Rules 3-18
Vertical Spacing
 See Spacing
Vertical Tabs
 See Side-By-Side Paragraphs
Vertical Text 7-28
View Menu 1-30
Viewing the Page 1-30

W

When Not At Column Top 1-43, 1-46
Which Counter
 chapter 8-19
 initial page 4-21, 8-34
 this page 4-21

Widows and Orphans 3-20, 5-44,
 8-20
Width Tables 3-63, 3-70, 10-44
Windows Metafile Format 5-4
Word Processing
 converting file formats 6-7
 inserting the parafltr code 2-4, 2-55
 inserting typographic characters
 2-5, 2-17
 macros 2-6, 7-2
 preformatting text in 2-3 to 2-5, 2-55
 search and replace 2-4, 10-17

X

X Offset 5-7

Y

Y Offset 5-7

Z

Z_BOXTEXT 4-9
Z_CAPTION 2-53
Z_DOUBLE 10-44
Z_FNOT ENTRY 8-9
Z_FNOT# 8-9
Z_FOOTER 2-40, 9-12
Z_HEADER 2-40, 3-53
Z_INDEX LTR 8-41
Z_INDEX MAIN 8-41
Z_INDEX TITLE 8-41
Z_LABEL CAP 3-60, 3-70
Z_SEC1 9-18
Z_SEC2 9-18
Z_SINGLE 10-44
Z_TOC LVL 1 8-37

Z_TOC LVL 2 8-37
Z_TOC LVL 3 8-45
Z_TOC TITLE 8-43
Zapf Dingbats 6-46

Zero Point
resetting 1-58, 2-42, 3-23, 4-21,
4-37, 5-16, 5-18, 5-56
Zooming in on the Page 1-30, 3-29

New Riders Library

Bestselling how-to books, reference guides, learning materials, and companion disks for corporate and technical publishing from the desktop. Use the postage-free card at the back of the book to order today.

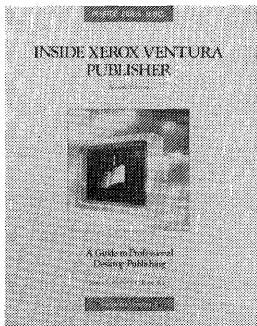

INSIDE XEROX VENTURA PUBLISHER

A Guide to Professional-Quality Desktop Publishing on the IBM PC

James Cavuoto and Jesse Berst

704 pages, 330 illustrations

ISBN 0-934035-59-8 **\$24.95**

2nd Edition

The best reference guide to Ventura Publisher is now even better! *Inside Xerox Ventura Publisher*, 2nd Edition, has been completely rewritten for Ventura Publisher Version 2 and includes more of what readers have asked for: more hands-on examples, more easy-to-use charts, and more time-saving tips and tricks.

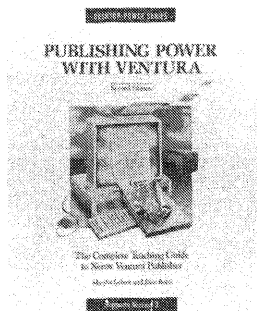

PUBLISHING POWER WITH VENTURA

The Complete Teaching Guide to Xerox Ventura Publisher

Martha Lubow and Jesse Berst

624 pages, 230 illustrations

ISBN 0-934035-61-X **\$27.95**

2nd Edition

Unlock the inner secrets of Ventura Publisher Version 2 with this well-written tutorial. You'll learn how to create your own great-looking business documents by producing the "real world" documents presented in this book. These documents include reports, newsletters, directories, technical manuals, and books. Companion software is available.

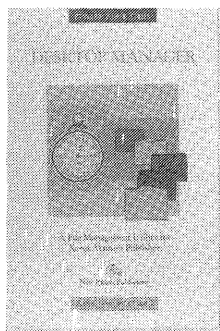

DESKTOP MANAGER

ISBN: 0-934035-34-2 **\$99.95**

Supports Version 1 and 2

Desktop Manager is the desktop accessory software for IBM and compatible personal computers that helps you manage your Ventura Publisher documents, running transparently from within the Ventura Publisher environment. A multifunction software utility, *Desktop Manager* provides file management, timed backup, document control, style sheet settings, and report generation. This essential utility program comes complete with an 180-page guide.

For fast service, call a New Riders Sales Representative
now at (818) 991-5392

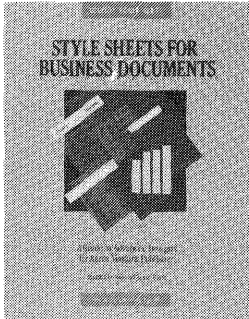

STYLE SHEETS FOR BUSINESS DOCUMENTS

(Book and Disk Set)

Martha Lubow and Jesse Berst

320 pages, 150 illustrations
ISBN 0-934035-22-9 **\$39.95**

Supports Version 1 and 2

Introducing a cure for the common document—*Style Sheets for Business Documents*. This book and disk set contains more than 30 predesigned Ventura Publisher templates for creating top-quality business documents. Style sheets are presented for proposals, reports, marketing materials, ads, brochures, and correspondence. More than 100 pages of design tips and tricks are also included.

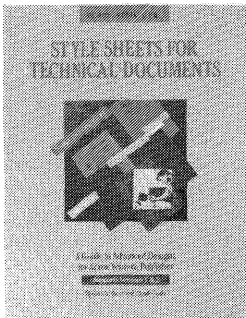

STYLE SHEETS FOR TECHNICAL DOCUMENTS

(Book and Disk Set)

By Byron Canfield and Chad Canty

320 Pages 150 illustrations
ISBN: 0-934035-29-6 **\$39.95**

Supports Version 1 and 2

Get the maximum out of Ventura Publisher with these advanced technical document formats. This book/disk combination presents more than 25 ready-to-use templates for creating technical documents and books. Also includes techniques for creating pictures and tables, plus advanced tips for modifying formats to fit your needs.

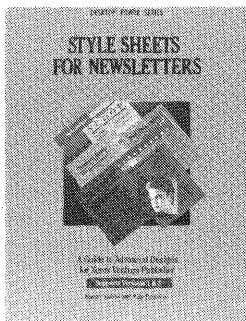

STYLE SHEETS FOR NEWSLETTERS

(Book and Disk Set)

By Martha Lubow and Polly Pattison

320 Pages over 150 illustrations
ISBN: 0-934035-31-8 **\$39.95**

Supports Version 1 and 2

This book and disk set presents more than 25 predesigned Ventura Publisher templates for creating one-, two-, three-, and four-column newsletters. Just open the chapter template, load in your own text, and print. A complete description of every style sheet and key tag for all chapter templates is also included.

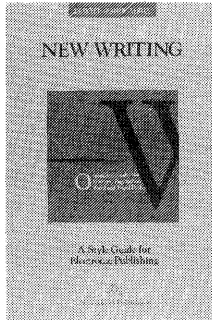

NEW WRITING

By Jesse Berst

320 Pages over 150 illustrations

ISBN: 0-934035-27-X **\$9.95**

The essential handbook for the modern writer and editor. *New Writing* shows you how to save production time by preformatting documents. Learn to manage your files, styles and style sheets. Also presented are the elements of style you need to succeed in today's desktop publishing arena. Companion software is available.

New Riders Library also includes books on AutoCAD

INSIDE AUTOCAD

D. Raker and H. Rice

750 pages, over 400 illustrations

ISBN: 0-934035-49-0 **\$29.95**

INSIDE AutoCAD, the best selling book on AutoCAD, is entirely new and rewritten for AutoCAD's 3D Release 10. This easy-to-understand book serves as both a tutorial and a lasting reference guide.

INSIDE AUTOLISP

J. Smith and R. Gesner

672 pages, over 150 illustrations

ISBN: 0-934035-47-4 **\$29.95**

Introducing the most comprehensive book on AutoLISP for AutoCAD Release 10. Learn AutoLISP commands and functions and write your own custom AutoLISP programs.

INSIDE AUTOSKETCH

By Frank Lenk

240 pages, over 120 illustrations

ISBN: 0-934035-20-2 **\$17.95**

INSIDE AutoSketch gives you real-life mechanical parts, drawing schematics, and architectural drawings.

**For fast service, call a New Riders Sales Representative
now at (818) 991-5392**

CUSTOMIZING AUTOCAD

J. Smith and R. Gesner
480 pages, over 100 illustrations
ISBN: 0-934035-45-8 **\$27.95**

Uncover the hidden secrets of AutoCAD's 3D Release 10 in this all new edition. Discover the anatomy of an AutoCAD menu and build a custom menu from start to finish.

AUTOCAD FOR ARCHITECTS AND ENGINEERS

John Albright and Elizabeth Schaeffer
480 pages, over 160 illustrations
ISBN: 0-934035-53-9 **\$29.95**

Learn by doing a typical AEC project using high-powered design development with AutoCAD Release 10. Learn to construct working drawings using techniques from real life AEC projects.

STEPPING INTO AUTOCAD

By Mark Merickel
380 pages, over 140 illustrations
ISBN: 0-934035-51-2 **\$29.95**

This popular tutorial has been completely rewritten with new exercises for Release 10. The book is organized to lead you step by step from the basics to practical tips on customizing AutoCAD for technical drafting.

AUTOCAD QUICK REFERENCE GUIDE

By Dorothy Kent
180 pages, over 50 illustrations
ISBN: 0-934035-57-1 **\$11.95**

All essential AutoCAD functions and commands are arranged alphabetically and described in just a few paragraphs.

THE AUTODESK FILE

Written and Edited by John Walker
608 pages
ISBN 0-934035-63-6 **\$24.95**

The unvarnished history of Autodesk, Inc. the company behind AutoCAD. Read the original memos, letters and reports that trace the rise of Autodesk, from start-up to their present position as the number one CAD software company in the world.

Order from New Riders Publishing Today

Yes, please send me the productivity-boosting material I have checked below. Make check payable to New Riders Publishing.

- Check enclosed.
 Charge to my credit card:
 Visa Mastercard

Card # _____

Expiration: _____

Signature: _____

Name _____

Company: _____

Address: _____

City: _____

State _____ Zip: _____

Phone: _____

The easiest way to order is to pick-up the phone and call (818) 991-5392 between 9:00 AM and 5:00 PM PST. Please have your credit card readily available and your order can be placed in a snap!

| Quantity | Description of Item | Unit Cost | Total Cost |
|----------|--|-----------|------------|
| | Inside Xerox Ventura Publisher 2nd Edition | \$24.95 | |
| | Publishing Power with Ventura 2nd Edition | \$27.95 | |
| | Publishing Power Disk | \$14.95 | |
| | Style Sheets for Business Documents-Book/Disk Set | \$39.95 | |
| | Style Sheets for Newsletters-Book/Disk Set | \$39.95 | |
| | Style Sheets for Technical Documents-Book/Disk Set | \$39.95 | |
| | Desktop Manager for Xerox Ventura Publisher | \$99.95 | |
| | New Writing | \$ 9.95 | |
| | New Writing - Desktop Utility Disk | \$ 7.95 | |
| | COOKIES (Put the fun back in your computer) | \$ 6.95 | |
| | | | |
| | | | |



Send to:

**New Riders Publishing
P.O. Box 4846
Thousand Oaks, CA 91360
(818)991-5392**

Shipping and Handling: see information below.

Sales Tax: California please add 6.5% sales tax.

TOTAL:

Shipping and Handling: \$3.50 for the first book and \$1.00 for each additional book. Floppy disk add \$1.50 for shipping and handling. Add \$15.00 per book for overseas shipping and handling. If you have to have it NOW, we can ship product to you in 24 to 48 hours. For an additional \$5.00 RUSH CHARGE for processing plus the actual cost of air freight, you'll be able to receive your item over night or in 2 days.

**New Riders Publishing P.O. Box 4846 Thousand Oaks, CA 91360 (818) 991-5392
FAX (818) 991-9263**

Order from New Riders Publishing Today!

Yes, please send me the productivity-boosting material I have checked below. Make check payable to New Riders Publishing.

- Check enclosed.
 Charge to my credit card:
 VISA MasterCard

Card # _____

Expiration: _____

Signature: _____

Name: _____

Company: _____

Address: _____

City: _____

State: _____ ZIP: _____

Phone: _____

The easiest way to order is to pick up the phone and call (818) 991-5392 between 9:00 AM and 5:00 PM PST. Please have your credit card readily available and your order can be placed in a snap!

| Quantity | Description of Item | Unit Cost | Total Cost |
|----------|--|-----------|------------|
| | Inside Xerox Ventura Publisher, 2nd Edition | \$29.95 | |
| | Publishing Power with Ventura, 2nd Edition | \$27.95 | |
| | Publishing Power Disk | \$14.95 | |
| | Style Sheets for Business Documents—Book/Disk Set | \$39.95 | |
| | Style Sheets for Newsletters—Book/Disk Set | \$39.95 | |
| | Style Sheets for Technical Documents—Book/Disk Set | \$39.95 | |
| | Desktop Manager for Xerox Ventura Publisher | \$99.95 | |
| | New Writing | \$ 9.95 | |
| | New Writing—Desktop Utility Disk | \$ 7.95 | |
| | COOKIES (Put the fun back in your computer) | \$ 6.95 | |



Send to:
New Riders Publishing
P.O. Box 4846
Thousand Oaks, CA 91360
(818)991-5392

| | | | |
|---|--|--|--|
| Shipping and Handling: See information below. | | | |
| Sales Tax: California please add 6.5% sales tax. | | | |
| TOTAL | | | |

Shipping and Handling: \$3.50 for the first book and \$1.00 for each additional book. Floppy disk add \$1.50 for shipping and handling. Add \$15.00 per book for overseas shipping and handling. If you have to have it NOW, we can ship product to you in 24 to 48 hours. For an additional \$5.00 RUSH CHARGE for processing plus the actual cost of air freight, you'll be able to receive your item overnight or in 2 days.

PP2E

New Riders Publishing P.O. Box 4846 Thousand Oaks, CA 91360 (818) 991-5392
FAX (818) 991-9263

To order: Fill in the reverse side, fold, and mail



NO POSTAGE
NECESSARY IF
MAILED IN THE
UNITED STATES

BUSINESS REPLY MAIL
FIRST CLASS PERMIT NO. 53 THOUSAND OAKS, CA

POSTAGE WILL BE PAID BY ADDRESSEE

NEW RIDERS PUBLISHING
P.O. Box 4846-P
Thousand Oaks, CA 91360

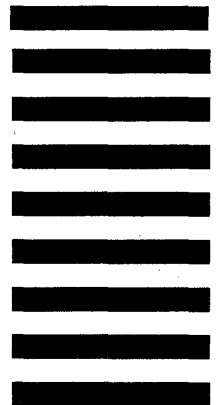



PUBLISHING POWER WITH VENTURA

An In-Depth Guide to Mastering Ventura Version 2

Learn the secrets the professionals use to make good looking documents fast.

- ◆ Create and design Reports, Proposals, Newsletters, Invoices, Flyers, Directories, Books, and more!
- ◆ Make high-powered business documents, just follow the sample screens!
- ◆ Overflowing with time saving Tips and Tricks on Xerox Ventura Version 2.

Other books talk about productivity—this book delivers it. Only Publishing Power provides the right tools for serious Xerox Ventura users.

Optional Disk Available

ISBN 0-934035-61-X



\$27.95 U.S. ISBN 0-934035-61-X